

# MC95XX Series

## Quick Start Guide

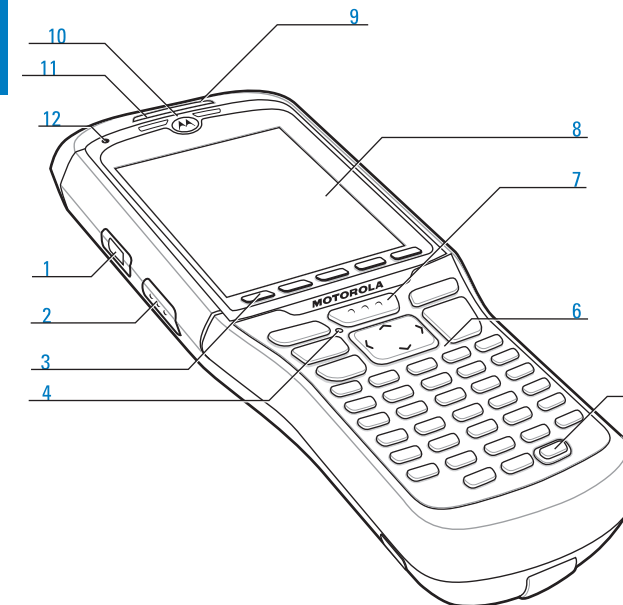

### FEATURES



- 1 Up/Down Volume Button
- 2 Scan/Application Button
- 3 Function Keys
- 4 Microphone
- 5 Power Button
- 6 Keypad
- 7 Scan/Action Button
- 8 Touch Screen (with screen protector)
- 9 Scan/Decode LED
- 10 Receiver
- 11 Charging/Battery Status LED
- 12 Radio Status LED

**Note 1:** To warm boot the MC95XX, press and hold the Power button for five (5) seconds.  
To cold boot the MC95XX, press and hold the 1, 9 and Power button.

- 13 Speaker
- 14 Camera and Flash
- 15 Interface Connector
- 16 Stylus
- 17 Scan Exit Window (see Data Capture Options)
- 18 IrDA Window
- 19 Action Button
- 20 Scan/Application Button
- 21 Headset Connector
- 22 Battery Release Button
- 23 Battery

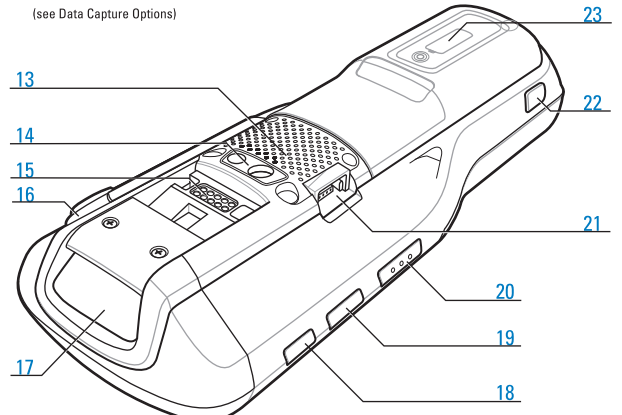

### LED Notifications

- Charging/Battery Status:**
  - Slow blinking amber: Battery charging
  - Solid green: Fully charged
  - Fast blinking amber: Charging error
- Scan/Decode:**
  - Red: Scanning active
  - Green: Good Decode
- Radio Status:**
  - Flashing blue: RF activity

### KEYPADS

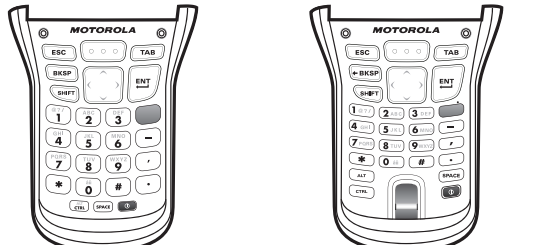

Telephony Numeric



Biometric Telephony Numeric



Calculator Numeric



Alpha Numeric Wide

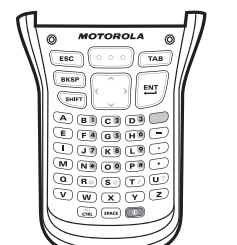

Alpha Primary

### GETTING STARTED

#### 1 Insert the Battery

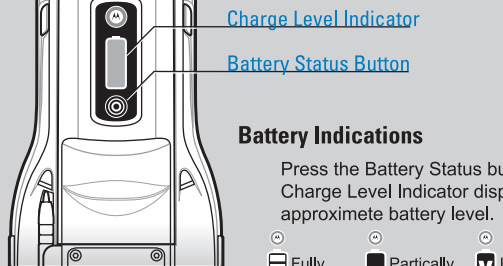
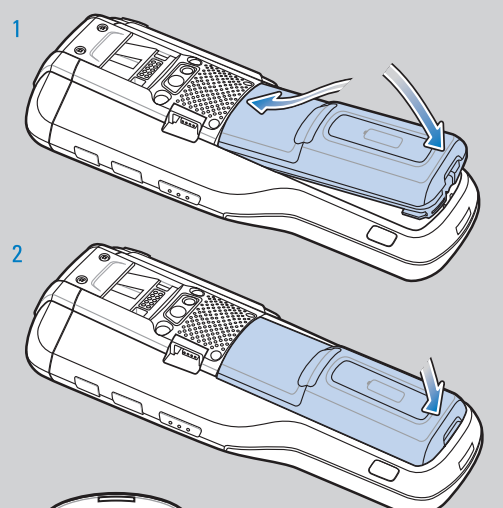

Charge Level Indicator  
Battery Status Button

#### Battery Indications

- Press the Battery Status button. Charge Level Indicator display approximate battery level.
- ☐ Fully Charged
  - ☐ Partly Charged
  - ☐ Un-Healthy

#### 2 Charge the MC95XX

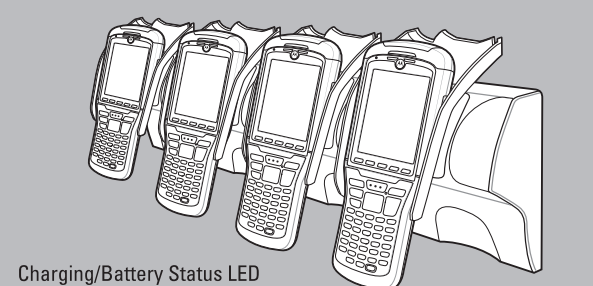
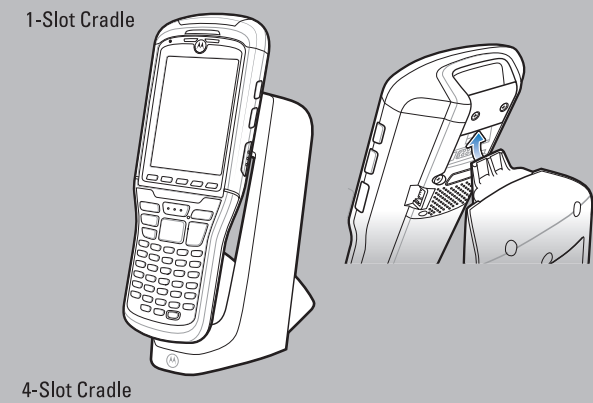

#### Charging/Battery Status LED

- Slow Blinking Amber = Charging
- Solid Green = Fully Charged
- Fast Blinking Amber = Charging error
- Solid Red = Un-healthy battery

\* It is recommended that this product be charged for 24 hours before the first use to ensure that the internal battery is fully charged.

### PHONE SETUP

#### SIM Card Installation (MC9596 Only)

1. Remove battery pack.
2. Remove SIM cover using flathead screwdriver.
3. Slide SIM card holder to the left.
4. Lift card holder.
5. Insert SIM card into SIM holder.
6. Lower the SIM card holder down.
7. Slide SIM card holder to the right to lock into place.
8. Reinstall SIM cover and secure screw.
9. Reinstall battery pack.
10. Warm boot the MC9596.

#### Enter Your PIN

- After installing the SIM card activate your mobile service connection. In most cases, SIM cards are preset with a PIN (Personal Identity Number), provided by your service provider.
1. Press the Power button to turn on the MC9596.
  2. Tap Start > Phone.
  3. Enter the PIN from your service provider.
  4. Tap Enter.

### COMMUNICATION

#### 3 Install ActiveSync®

Download ActiveSync® 4.5 or higher from <http://www.microsoft.com> and follow the instructions to install ActiveSync onto the host computer.

#### 4 Communicate with Host

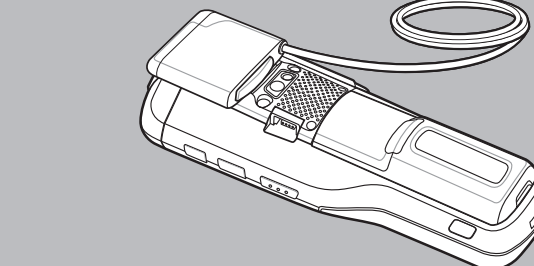

#### 5 Create a Partnership

Follow the on-screen ActiveSync instructions to establish a connection between the MC95XX and the host computer.

# SUPPORT INFORMATION

## More Information on the MC95XX

Visit the Motorola Web site at <http://www.motorola.com/mc9500>

## Setting up, using and troubleshooting the MC95XX

MC95XX User Guide  
MC95XX Integrator Guide  
Available at: <http://www.motorola.com/mc9500>

## Additional Software

Check Motorola web site for approved applications.  
<http://www.motorola.com/mc9500>

## Connecting and synchronizing with the host computer

ActiveSync® Help on the host computer. To view help, start ActiveSync®, Click Help - Microsoft ActiveSync Help.

## Information on using programs on the MC95XX

Tap Start – Help within the specific program.

## Service and Warranty

MC95XX Regulatory Guide



**MOTOROLA**  
Motorola, Inc.  
One Motorola Plaza Holtsville, New York 11742-1300, USA  
MOTOROLA and the Stylized M Logo and Symbol and the Symbol logo are registered in the U.S. Patent and Trademark Office. All other product or service names are the property of their respective owners.  
© Motorola, Inc. 2009



72-118504-01 Rev. 1 — January 2009

# ACCESSORIES

## microSD Card Installation

1. Remove battery pack.
2. Remove SIM cover using flathead screwdriver.
3. Slide microSD card holder to the left.
4. Lift card holder.
5. Insert microSD card into holder.

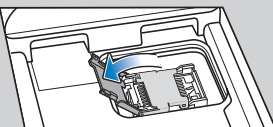

### NOTE:

The proper position of the microSD card—the card connector (i.e., gold area) should be facing outward with the bevelled corner facing away.

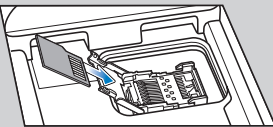

6. Lower the microSD card holder down.
7. Slide card holder to the right to lock into place.

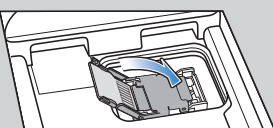

8. Reinstall SIM cover and secure screw.
9. Reinstall battery pack.
10. Warm boot the MC95XX.

## Screen Protector

Motorola recommends the use of a screen protector to minimize wear and tear. Screen protectors enhance the usability and durability of touch screen

- Protection from scratches and gouges
- Durable writing and touch surface with tactile feel
- Abrasion and chemical resistance
- Glare reduction

Not using a screen protector can affect your warranty coverage.

An initial screen protector is already applied to your MC95XX. Contact your local account manager or Motorola, Inc. for more information and purchasing details. Part number: KT-67525-01R Screen Protector 3/pk.

## Vehicle Cradle

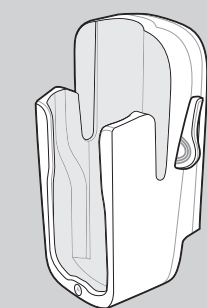

## Auto-Charge Cable

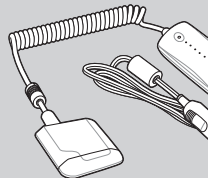

## Vehicle Battery Charger

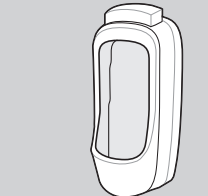

## One Slot USB Cradle

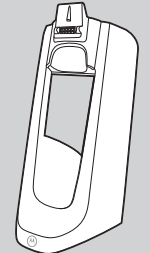

## One Slot Battery Charger

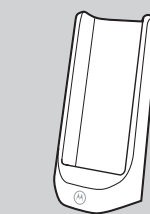

## USB Charging Cable

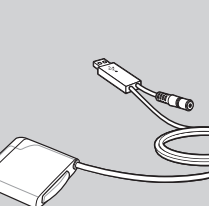

## Four Slot Charge Only Cradle

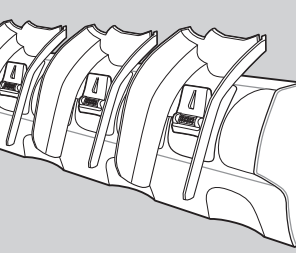

## Four Slot Battery Charger

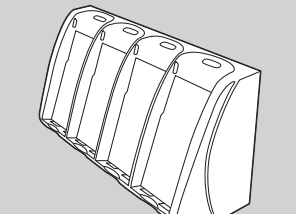

## Magnetic Stripe Reader

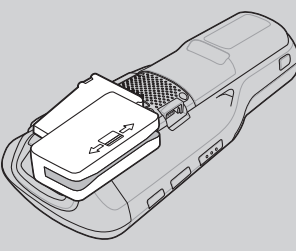

# CABLE CONNECTION

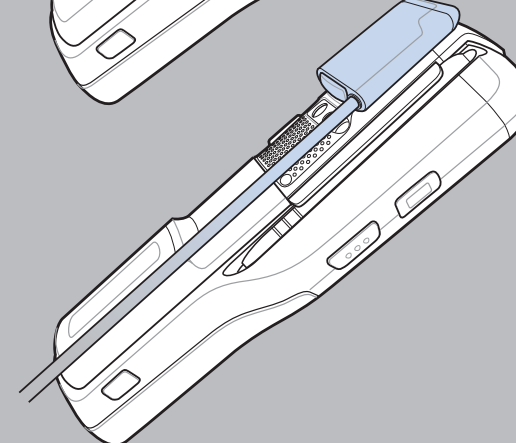
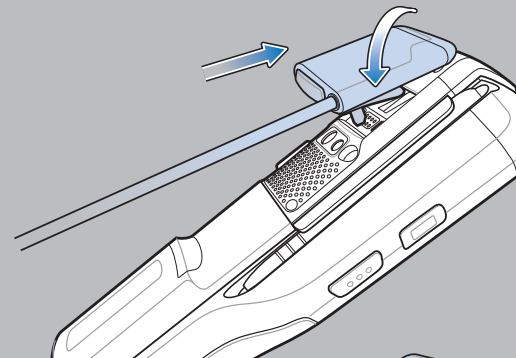

# DATA CAPTURE OPTIONS

## Camera Lens

## Exit Window

Laser scanner or Imager

## GPS Information

When using the GPS feature of the MC95XX:

- Acquiring satellite signals may take a few minutes. It is best to be outside and have a clear, unobstructed view of the sky.
- Without a clear view, acquisition takes much longer and could result in the MC95XX being unable to compute the initial position quickly.
- Obtain a satellite fix before moving.
- Shutdown GPS application when not in use.

# OPTIMUM SCANNING AND IMAGING

## Scanning/Imaging

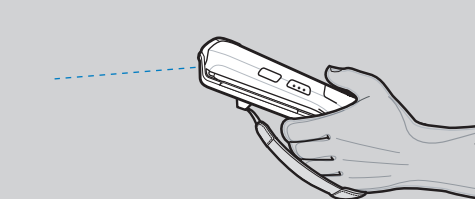

## Laser Scanning



## Imaging



## Camera Decode

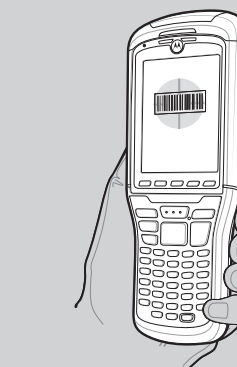

1. Launch a bar code reading application on the MC95XX.
2. Position the MC95XX toward the bar code.
3. Press the **Scan** button.
4. In the image window align the red target over the bar code. When the MC95XX decodes the bar code the target turns green.

## Camera Photo

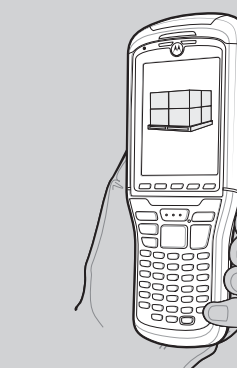

1. Tap **Start > Programs > Pictures & Videos > Camera**.
2. Point the MC95XX at an object.
3. Press the **Enter** button.
4. Hold MC95XX still until "Shutter Sound" is heard.

# ERGONOMIC CONSIDERATIONS

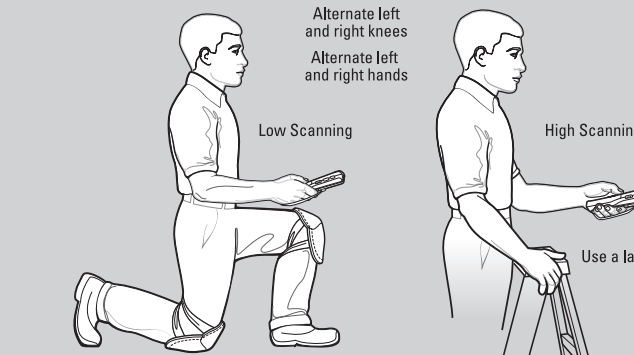
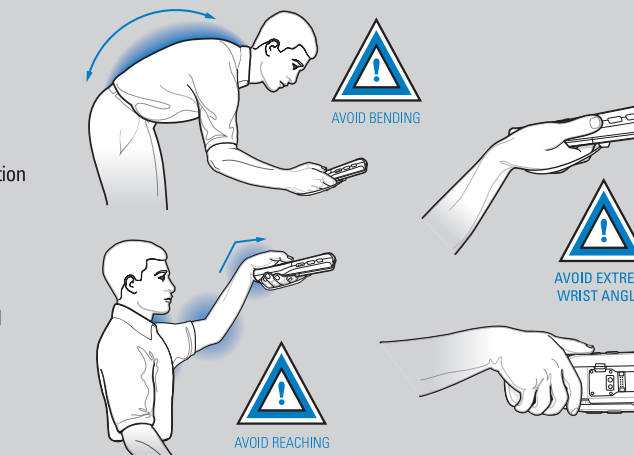

Taking breaks and task rotation recommended

<http://www.motorola.com/mc9500>