

# MC92N0 QUICK START GUIDE



## BATTERY INSERTION

<http://www.motorolasolutions.com/mc92n0-g>

See User Guide for more information

### Front View

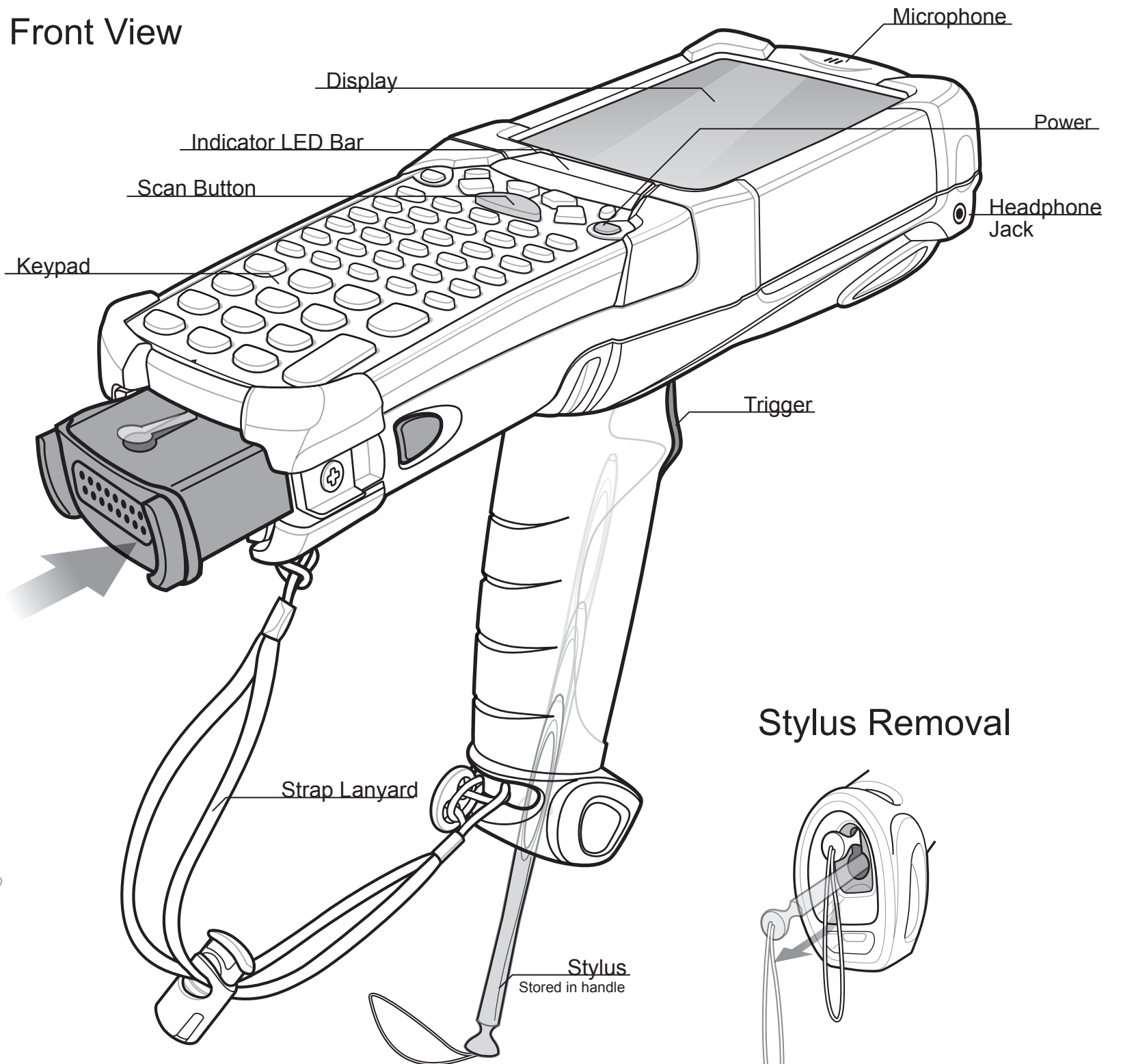

POST IN WORK AREA



### Battery Removal

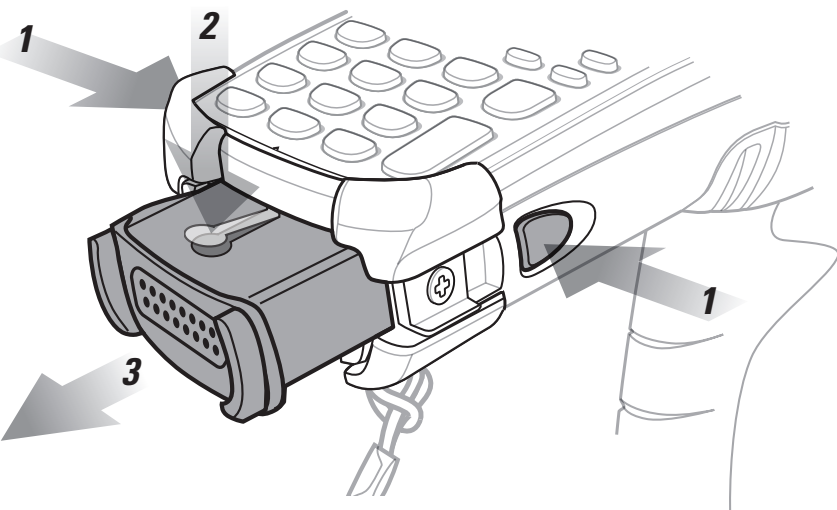

### Stylus Removal

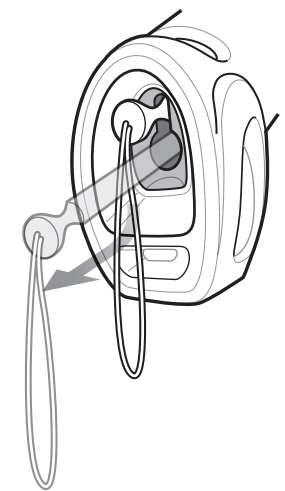

## SNAP-ON ACCESSORY INSTALLATION

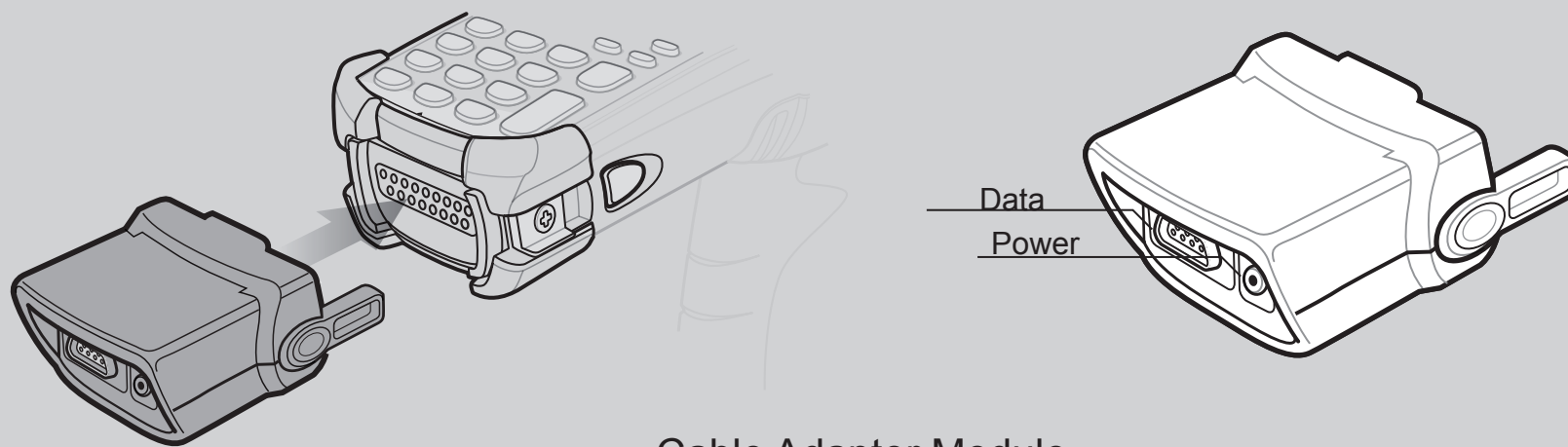

Cable Adapter Module

## CHARGING INSTRUCTIONS

⦿ = LED Indicator Location    Slow Flash = Normal Charge    Solid Amber = Full Charge    Fast Flash = Charging Error

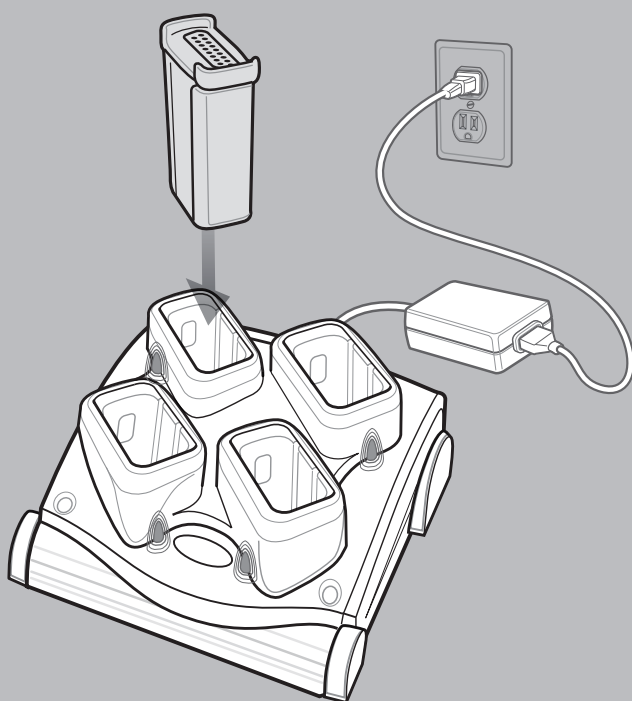

Four Slot Spare Battery Charger

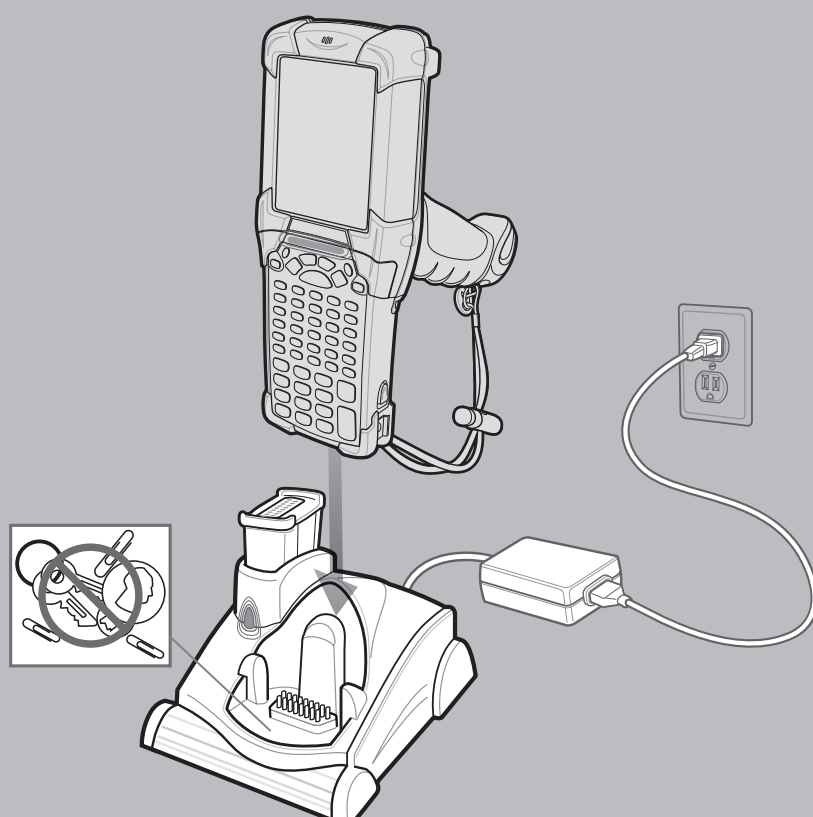

Single Slot Serial/USB Cradle

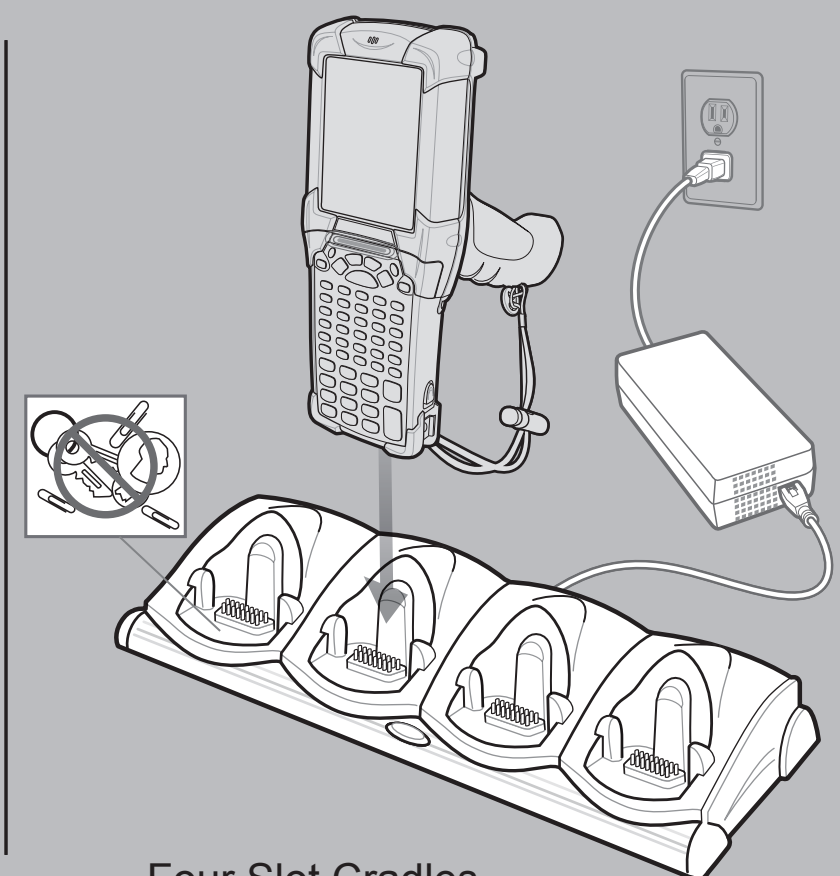

Four Slot Cradles  
Charge-Only Cradle and Ethernet Cradle

# OPTIMUM IMAGING AND SCANNING POSITIONS

## Laser Scanning

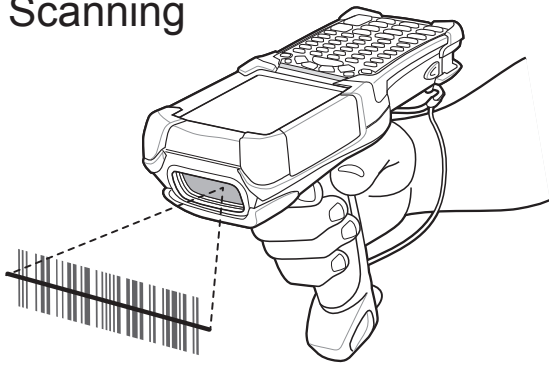

## Standard Range Imaging

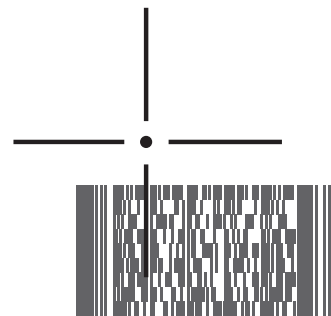
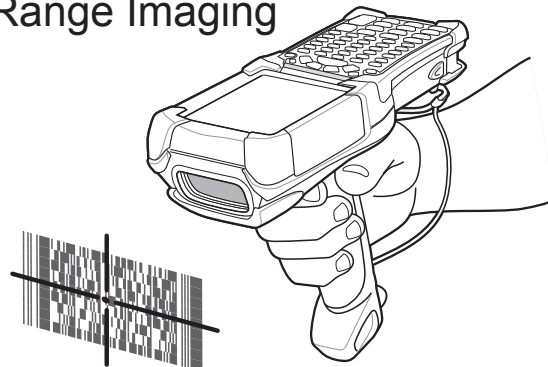

## Long Range Imaging

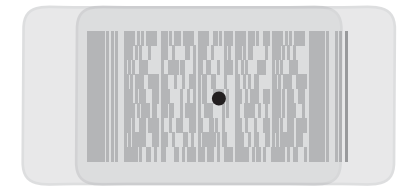
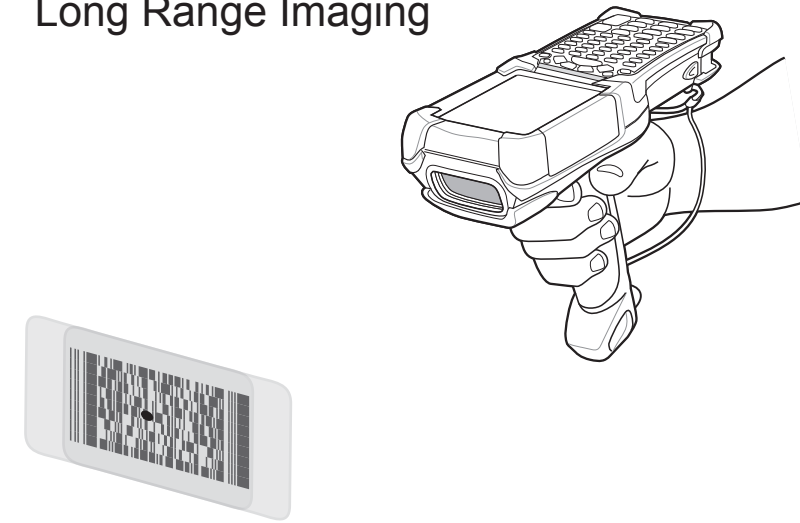

## OPTIMUM UPRIGHT BODY POSTURE



## AVOID EXTREME WRIST ANGLES

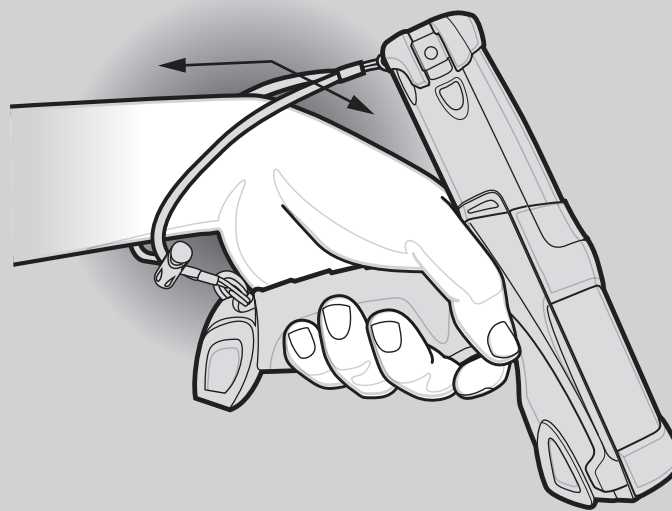

ALTERNATE LEFT AND RIGHT HANDS  
TAKING BREAKS AND TASK ROTATION RECOMMENDED

## OPTIMUM BODY POSTURE

### Low Scanning

Alternate left and right knees

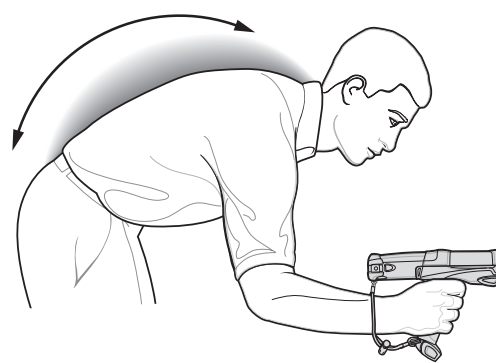

Alternate left and right hands



### High Scanning

Use a ladder



Taking breaks and task rotation recommended

POST IN WORK AREA



**MOTOROLA**

Motorola Solutions, Inc.  
1301 E. Algonquin Rd. Schaumburg, IL 60196-1078, U.S.A.  
MOTOROLA, MOTO, MOTOROLA SOLUTIONS and the Stylized M Logo are trademarks or registered trademarks of Motorola Trademark Holdings, LLC and are used under license. All other trademarks are the property of their respective owners.  
© 2012 Motorola Solutions, Inc. All Rights Reserved.



72-161751-01 Rev A - July 2012



<http://www.motorolasolutions.com/mc92n0-g>