



# FCC TEST REPORT (WLAN - 15.407)

**REPORT NO.:** RF980729H05-1

**MODEL NO.:** MC3190

**RECEIVED:** July 29, 2009

**TESTED:** Aug. 25 to 31, 2009

**ISSUED:** Sep. 16, 2009

**APPLICANT:** Motorola Inc.

**ADDRESS:** One Motorola Plaza  
Holtville NY  
11742-1300 USA

**ISSUED BY:** Bureau Veritas Consumer Products Services (H.K.)  
Ltd., Taoyuan Branch Hsin Chu Laboratory

**ADDRESS:** No. 81-1, Lu Liao Keng, 9th Ling, Wu Lung Tsuen,  
Chiung Lin Hsiang, Hsin Chu Hsien 307, Taiwan

This test report consists of 91 pages in total. It may be duplicated completely for legal use with the approval of the applicant. It should not be reproduced except in full, without the written approval of our laboratory. The client should not use it to claim product endorsement by TAF or any government agencies. The test results in the report only apply to the tested sample.





A D T

## Table of Contents

1.	CERTIFICATION .....	4
2.	SUMMARY OF TEST RESULTS .....	5
2.1	MEASUREMENT UNCERTAINTY.....	6
3.	GENERAL INFORMATION.....	7
3.1	GENERAL DESCRIPTION OF EUT .....	7
3.2	DESCRIPTION OF TEST MODES .....	12
3.2.1	TEST MODE APPLICABILITY AND TESTED CHANNEL DETAIL: .....	13
3.3	GENERAL DESCRIPTION OF APPLIED STANDARDS .....	15
3.4	DESCRIPTION OF SUPPORT UNITS.....	16
3.5	CONFIGURATION OF SYSTEM UNDER TEST .....	17
4.	TEST TYPES AND RESULTS .....	20
4.1	CONDUCTED EMISSION MEASUREMENT.....	20
4.1.1	LIMITS OF CONDUCTED EMISSION MEASUREMENT .....	20
4.1.2	TEST INSTRUMENTS .....	20
4.1.3	TEST PROCEDURES.....	21
4.1.4	DEVIATION FROM TEST STANDARD .....	21
4.1.5	TEST SETUP .....	22
4.1.6	EUT OPERATING CONDITIONS .....	22
4.1.7	TEST RESULTS .....	23
4.2	RADIATED EMISSION MEASUREMENT .....	29
4.2.1	LIMITS OF RADIATED EMISSION MEASUREMENT.....	29
4.2.2	LIMITS OF UNWANTED EMISSION OUT OF THE RESTRICTED BANDS.....	30
4.2.3	TEST INSTRUMENTS .....	31
4.2.4	TEST PROCEDURES.....	33
4.2.5	DEVIATION FROM TEST STANDARD .....	33
4.2.6	TEST SETUP .....	34
4.2.7	EUT OPERATING CONDITION.....	34
	BELOW 1GHZ TEST DATA.....	35
4.2.8	TEST RESULTS .....	35
	ABOVE 1GHZ TEST DATA.....	36
4.2.9	TEST RESULTS .....	36
4.3	PEAK TRANSMIT POWER MEASUREMENT.....	51
4.3.1	LIMITS OF PEAK TRANSMIT POWER MEASUREMENT .....	51
4.3.2	TEST INSTRUMENTS .....	51
4.3.3	TEST PROCEDURE.....	52
4.3.4	DEVIATION FROM TEST STANDARD .....	52
4.3.5	TEST SETUP .....	52
4.3.6	EUT OPERATING CONDITIONS .....	52
4.3.7	TEST RESULTS .....	53



A D T

4.4	PEAK POWER EXCURSION MEASUREMENT .....	64
4.4.1	LIMITS OF PEAK POWER EXCURSION MEASUREMENT .....	64
4.4.2	TEST INSTRUMENTS .....	64
4.4.3	TEST PROCEDURE.....	65
4.4.4	DEVIATION FROM TEST STANDARD .....	65
4.4.5	TEST SETUP .....	65
4.4.6	EUT OPERATING CONDITIONS .....	65
4.4.7	TEST RESULTS .....	66
4.5	PEAK POWER SPECTRAL DENSITY MEASUREMENT.....	71
4.5.1	LIMITS OF PEAK POWER SPECTRAL DENSITY MEASUREMENT .....	71
4.5.2	TEST INSTRUMENTS .....	71
4.5.3	TEST PROCEDURES.....	72
4.5.4	DEVIATION FROM TEST STANDARD .....	72
4.5.5	TEST SETUP .....	72
4.5.6	EUT OPERATING CONDITIONS .....	72
4.5.7	TEST RESULTS .....	73
4.6	FREQUENCY STABILITY .....	79
4.6.1	LIMITS OF FREQUENCY STABILITY MEASUREMENT .....	79
4.6.2	TEST INSTRUMENTS .....	79
4.6.3	TEST PROCEDURE.....	79
4.6.4	DEVIATION FROM TEST STANDARD .....	80
4.6.5	TEST SETUP .....	80
4.6.6	EUT OPERATING CONDITION.....	80
4.6.7	TEST RESULTS .....	81
4.7	CONDUCTED OUT-BAND EMISSION MEASUREMENT .....	82
4.7.1	TEST INSTRUMENTS .....	82
4.7.2	TEST PROCEDURE.....	82
4.7.3	EUT OPERATING CONDITION.....	82
4.7.4	TEST RESULTS .....	83
4.8	ANTENNA REQUIREMENT .....	89
4.8.1	STANDARD APPLICABLE .....	89
4.8.2	ANTENNA CONNECTED CONSTRUCTION .....	89
5.	INFORMATION ON THE TESTING LABORATORIES .....	90
6.	APPENDIX-A- MODIFICATIONS RECORDERS FOR ENGINEERING CHANGES TO THE EUT BY THE LAB .....	91



## 1. CERTIFICATION

**PRODUCT:** Mobile Computer  
**BRAND NAME:** MOTOROLA  
**MODEL NO.:** MC3190  
**TEST SAMPLE:** ENGINEERING SAMPLE  
**TESTED:** Aug. 25 to 31, 2009  
**APPLICANT:** Motorola Inc.  
**STANDARDS:** FCC Part 15, Subpart E (Section 15.407),  
ANSI C63.4-2003

The above equipment has been tested by **Bureau Veritas Consumer Products Services (H.K.) Ltd., Taoyuan Branch**, and found compliance with the requirement of the above standards. The test record, data evaluation & Equipment Under Test (EUT) configurations represented herein are true and accurate accounts of the measurements of the sample's EMC characteristics under the conditions specified in this report.

**PREPARED BY** : Carol Liao , **DATE:** Sep. 16, 2009  
( Carol Liao, Specialist )

**TECHNICAL ACCEPTANCE** : Hank Chung , **DATE:** Sep. 16, 2009  
Responsible for RF ( Hank Chung, Deputy Manager )

**APPROVED BY** : May Chen , **DATE:** Sep. 16, 2009  
( May Chen, Deputy Manager )



A D T

## 2. SUMMARY OF TEST RESULTS

The EUT has been tested according to the following specifications:

[For 802.11a](#)

APPLIED STANDARD: FCC Part 15, Subpart E (Section 15.407)			
Standard Section	Test Type	Result	Remark
15.407(b)(5)	AC Power Conducted Emission	PASS	Meet the requirement of limit. Minimum passing margin is -13.43dB at 0.162MHz
15.407(b/1/2/3) (b)(5)	Electric Field Strength Spurious Emissions, 30MHz ~ 40000MHz	PASS	Meet the requirement of limit. Minimum passing margin is - 6.59dB at 5725.0MHz
15.407(a/1/2/3)	Peak Transmit Power	PASS	Meet the requirement of limit.
15.407(a)(6)	Peak Power Excursion	PASS	Meet the requirement of limit.
15.407(a/1/2/3)	Peak Power Spectral Density	PASS	Meet the requirement of limit.
15.407(g)	Frequency Stability	PASS	Meet the requirement of limit.

### NOTE:

1. There are Bluetooth technology and WLAN technology used for the EUT.
2. For Bluetooth technology, the test data please refer "RF980729H05-2".
3. For WLAN technology, the EUT was operating in 2400 ~ 2483.5MHz, 5.15~5.35GHz, 5.47~5.725GHz and 5.725~5.850GHz frequencies band. This report was recorded the RF parameters including 5.15~5.35GHz and 5.47~5.725GHz. For the 2400 ~ 2483.5MHz and 5.725~5.850GHz RF parameters was recorded in another test report "RF980729H05".

## 2.1 MEASUREMENT UNCERTAINTY

Where relevant, the following measurement uncertainty levels have been estimated for tests performed on the EUT as specified in CISPR 16-4-2:

This uncertainty represents an expanded uncertainty expressed at approximately the 95% confidence level using a coverage factor of  $k=2$ .

Measurement	Value
Conducted emissions	2.44 dB
Radiated emissions (30MHz-1GHz)	3.94 dB
Radiated emissions (1GHz -18GHz)	2.44 dB
Radiated emissions (18GHz -40GHz)	2.67 dB



A D T

### 3. GENERAL INFORMATION

#### 3.1 GENERAL DESCRIPTION OF EUT

<b>PRODUCT</b>	Mobile Computer
<b>MODEL NO.</b>	MC3190
<b>FCC ID</b>	UZ7MC3190
<b>POWER SUPPLY</b>	DC 12V to cradle, DC 5.4V from power adapter or DC 3.7V from battery
<b>MODULATION TYPE</b>	For WLAN : CCK, DQPSK, DBPSK for DSSS 64QAM, 16QAM, QPSK, BPSK for OFDM For Bluetooth : GFSK, $\pi/4$ – DQPSK, 8DPSK
<b>MODULATION TECHNOLOGY</b>	For WLAN : DSSS, OFDM For Bluetooth : FHSS
<b>TRANSFER RATE</b>	For WLAN : 802.11b: 11 / 5.5 / 2 / 1Mbps 802.11g: 54 / 48 / 36 / 24 / 18 / 12 / 9 / 6Mbps 802.11a: 54 / 48 / 36 / 24 / 18 / 12 / 9 / 6Mbps For Bluetooth : DH 1, DH 3, DH 5
<b>FREQUENCY RANGE</b>	For WLAN : <b>For 15.407</b> 802.11a: 5.18 ~ 5.32GHz, 5.50 ~ 5.70GHz <b>For 15.247(2.4GHz)</b> 802.11b & 802.11g: 2412 ~ 2462MHz <b>For 15.247(5GHz)</b> 802.11a: 5.745 ~ 5.825GHz For Bluetooth :2402MHz ~ 2480MHz
<b>NUMBER OF CHANNEL</b>	For WLAN : <b>For 15.407</b> 19 for 802.11a <b>For 15.247(2.4GHz)</b> 11 for 802.11b, 802.11g <b>For 15.247(5GHz)</b> 5 for 802.11a For Bluetooth : 79

<b>MAXIMUM OUTPUT POWER</b>	For WLAN : <b>For 15.407</b> 802.11a: 28.510mW <b>For 15.247(2.4GHz)</b> 802.11b: 52.360mW 802.11g: 165.959mW <b>For 15.247(5GHz)</b> 802.11a: 127.644mW  For Bluetooth : GFSK: 1.445 mW 8DPSK: 2.449 mW $\pi/4$ – DQPSK: 2.265 mW
<b>ANTENNA TYPE</b>	Please see note 4
<b>DATA CABLE</b>	RS232 Cable x 1 (Part No.: 25-67866-03R) USB Cable x 1 (Part No.: 25-67868-03R) (only for test, not for sale together)
<b>I/O PORTS</b>	USB port x 1, SD slot port x 1, Audio port x 1
<b>ASSOCIATED DEVICES</b>	Battery x 1 for MC3190 (S & G) (Model No.: 82-127909-02) Battery x 1 for MC3190(R) (Model No.: 82-127912-01)

**NOTE:**

1. There are Bluetooth technology (BT2.1+EDR) and WLAN technology used for the EUT. <the Bluetooth test data please refer "RF980729H05-2">
2. There are different types in MC3190, which with identical WLAN module and Bluetooth module in inside.
3. The EUT was pre-tested under the following modes:

Test Mode	Description
Mode A	X-Y plane
Mode B	Z-X plane
<b>Mode C</b>	<b>Z-Y plane</b>

From the above modes, the worst emission level was found in **Mode C**. Therefore only the test data of the modes were recorded in this report individually.





A D T

4. There are nine antennas provided to this EUT, please refer to the following table:

For WLAN								
No.	Brand	Model	Antenna Type	Gain (dBi)	Connector Type	Frequency range (MHz)	Cable Loss(dB)	Cable Length
1	Laird (R Type)	Rot main	PIFA	0.37(2.4G) 4.81(5G)	Hirose U.FL	2400~2500 4900~5850	0.1~0.15	25 ± 0.5mm
2	Laird (R Type)	Rot aux	PIFA	1.63(2.4G) 4.93(5G)	Hirose U.FL	2400~2500 4900~5850	0.1~0.15	61 +2/-1mm
3	Laird (S Type)	Str main	PIFA	0.89(2.4G) 4.34(5G)	Hirose U.FL	2400~2500 4900~5850	0.1~0.15	25 ± 0.5mm
4	Laird (S Type)	Str aux	PIFA	1.09(2.4G) 4.52(5G)	Hirose U.FL	2400~2500 4900~5850	0.1~0.15	61 +2/-1mm
5	Laird (G Type)	Gun main	PIFA	2.16(2.4G) 5.83(5G)	Hirose U.FL	2400~2500 4900~5850	0.1~0.15	25 ± 0.5mm
6	Laird (G Type)	Gun aux	PIFA	2.46(2.4G) 5.69(5G)	Hirose U.FL	2400~2500 4900~5850	0.1~0.15	61 +2/-1mm

Note :

1. For 2.4G: The antenna 6 was selected as representative antenna for the test.
2. For 5G: The antenna 5 was selected as representative antenna for the test.

For Bluetooth

No.	Brand	Model	Antenna Type	Gain (dBi)	Connector Type	Frequency range (MHz)	Cable Loss(dB)	Cable Length
1	Motorola	Rot type	PIFA	3.08	Hirose U.FL	2400~2480	0.1~0.15	35 ± 0.5mm
2	Motorola	Str type	PIFA	2.481	Hirose U.FL	2400~2480	0.1~0.15	35 ± 0.5mm
3	Motorola	Gun type	PIFA	2.885	Hirose U.FL	2400~2480	0.1~0.15	35 ± 0.5mm

5. EUT Configuration:

	Straight type	Gun Type	Rotating type
	Type1	Type2_2	Type3
OS	WM6.1	WM6.1	WM6.1
CPU	624MHZ	624MHZ	624MHZ
RAM	128MB	128MB	128MB
Flash	512MB	512MB	512MB
Keypad	48keys	28keys	38keys
Battery	(Motorola)	(Motorola)	(Motorola)
Scan Engine	SE4500 SRBB (imager)	SE950	SE4500 HDBB DPM (imager)
wifi ANT	Str main/Str aux	Gun main/Gun aux	Rot main/Rot aux
WLAN ( a/b/g )	V	V	V
BT	V	V	V



6. The EUT could be supplied with the a charger, power adapter and Li-ion battery as below:

<b>Cradle 1 (1-slot) (only for test, not for sale together)</b>	
Brand:	SYMBOL
Part No.:	CRD3000-1001RR
Input power :	+12V-----3.3A
I/O Ports:	USB Port x 1 RJ-45(console) Port x 1
Associated devices:	USB cable x 1 (Part No.: 25-68596-01R) (1.6m, Unshielded without core) RJ-45(console) cable x 1 (Part No.: 25-63852-01R) (1.8m, Unshielded without core) Adapter x 1 (Part No.: 50-14000-148R)
<b>Cradle 2 (4-slot) (only for test, not for sale together)</b>	
Brand:	SYMBOL
Part No.:	CRD3000-4001ER
Input power :	+12V-----9A
I/O Ports:	RJ-45(LAN) Port x 2
Associated devices:	Power cable x 2 (Part No.: 50-16002-042R) (1.8m, Shielded with two cores) Adapter x 2 (Part No.: 50-14000-241R)
<b>Adapter 1 (only for Cradle 1 use, not for sale together)</b>	
Brand:	HIPRO
Model No.:	HP-O2040D43
Part No.:	50-14000-148R
Input power :	100-240V, 50-60Hz, 1.5A
Output power :	+12V-----3.33A DC output cable (1.8m, Unshielded)
<b>Adapter 2 (only for Cradle 2 use, not for sale together)</b>	
Brand:	SYMBOL
Model No.:	SYM04-1
Part No.:	50-14000-241R
Input power :	100-120/200-240V, 50-60Hz, 3.0/1.5A
Output power :	+12V-----9.0A



A D T

Adapter 3 (only for test, not for sale together)	
Brand:	DELTA
Model No.:	ADP-16GB A
Part No.:	50-14000-147
Input power :	100-240V, 50-60Hz, 0.4A
Output power :	+5.4V----3.0A DC output cable (1.8m, Unshielded, with one core)
Adapter 4 (only for test, not for sale together)	
Brand:	MOTOROLA
Model No.:	EADP-16BB A
Part No.:	50-14000-249R
Input power :	100-240V, 50-60Hz, 0.4A
Output power :	+5.4V----3.0A DC output cable (1.8m, Unshielded)

7. The EUT operates in both the 5GHz and 2.4GHz Bands and compatibility with 802.11a, 802.11b, 802.11g and Bluetooth technology.
8. The above EUT information was declared by the manufacturer and for more detailed features description, please refer to the manufacturer's specifications or User's Manual.

### 3.2 DESCRIPTION OF TEST MODES

#### Operated in 5150MHz ~ 5350MHz bands:

Eight channels are provided for 802.11a:

CHANNEL	FREQUENCY
36	5180 MHz
40	5200 MHz
44	5220 MHz
48	5240 MHz
52	5260 MHz
56	5280 MHz
60	5300 MHz
64	5320 MHz

#### Operated in 5470MHz ~ 5725MHz bands:

Eleven channels are provided for 802.11a:

CHANNEL	FREQUENCY
100	5500 MHz
104	5520 MHz
108	5540 MHz
112	5560 MHz
116	5580 MHz
120	5600 MHz
124	5620 MHz
128	5640 MHz
132	5660 MHz
136	5680 MHz
140	5700 MHz

### 3.2.1 TEST MODE APPLICABILITY AND TESTED CHANNEL DETAIL:

The device has several types and different accessory, therefore the worst case base on investigation by different combination for each test item and its data was recorded in this report.

EUT CONFIGURE MODE	APPLICABLE TO				DESCRIPTION
	PLC	RE < 1G	RE ≥ 1G	APCM	
A	√		√	√	USB Mode: Type3 MC3190+Battery+Adapter(motorola)
B	√				cradle mode: (1-slot)Type3 MC3190+Battery+Adapter
C	√	√			cradle mode: (4-slot) 2*(Type3 MC3190+Battery) +2*(Type2_2 MC3190+Battery)+Adapter

Where **PLC**: Power Line Conducted Emission      **RE < 1G**: Radiated Emission below 1GHz  
**RE ≥ 1G**: Radiated Emission above 1GHz      **APCM**: Antenna Port Conducted Measurement

#### **POWER LINE CONDUCTED EMISSION TEST:**

- Pre-Scan has been conducted to determine the worst-case mode from all possible combinations between available modulations, data rates and antenna ports (if EUT with antenna diversity architecture).
- Following channel(s) was (were) selected for the final test as listed below.

MODE	AVAILABLE CHANNEL	TESTED CHANNEL	MODULATION TECHNOLOGY	MODULATION TYPE	DATA RATE (Mbps)	EUT CONFIGURE MODE
802.11a	36 to 140	52	OFDM	BPSK	6	A, B, C

#### **RADIATED EMISSION TEST (BELOW 1 GHz):**

- Pre-Scan has been conducted to determine the worst-case mode from all possible combinations between available modulations, data rates and antenna ports (if EUT with antenna diversity architecture).
- Following channel(s) was (were) selected for the final test as listed below.

MODE	AVAILABLE CHANNEL	TESTED CHANNEL	MODULATION TECHNOLOGY	MODULATION TYPE	DATA RATE (Mbps)	EUT CONFIGURE MODE
802.11a	36 to 140	36	OFDM	BPSK	6	C



A D T

### **RADIATED EMISSION TEST (ABOVE 1 GHz):**

- Pre-Scan has been conducted to determine the worst-case mode from all possible combinations between available modulations, data rates and antenna ports (if EUT with antenna diversity architecture).
- Following channel(s) was (were) selected for the final test as listed below.

MODE	AVAILABLE CHANNEL	TESTED CHANNEL	MODULATION TECHNOLOGY	MODULATION TYPE	DATA RATE (Mbps)	EUT CONFIGURE MODE
802.11a	36 to 140	36, 40, 48, 52, 60, 64, 100, 120, 140	OFDM	BPSK	6	A

### **BANDEDGE MEASUREMENT:**

- Pre-Scan has been conducted to determine the worst-case mode from all possible combinations between available modulations, data rates and antenna ports (if EUT with antenna diversity architecture).
- Following channel(s) was (were) selected for the final test as listed below.

MODE	AVAILABLE CHANNEL	TESTED CHANNEL	MODULATION TECHNOLOGY	MODULATION TYPE	DATA RATE (Mbps)	EUT CONFIGURE MODE
802.11a	36 to 140	36, 64, 100, 140	OFDM	BPSK	6	A

### **ANTENNA PORT CONDUCTED MEASUREMENT:**

- Pre-Scan has been conducted to determine the worst-case mode from all possible combinations between available modulations, data rates and antenna ports (if EUT with antenna diversity architecture).
- Following channel(s) was (were) selected for the final test as listed below.

MODE	AVAILABLE CHANNEL	TESTED CHANNEL	MODULATION TECHNOLOGY	MODULATION TYPE	DATA RATE (Mbps)	EUT CONFIGURE MODE
802.11a	36 to 140	36, 40, 48, 52, 60, 64, 100, 120, 140	OFDM	BPSK	6	A

### 3.3 GENERAL DESCRIPTION OF APPLIED STANDARDS

The EUT is a Mobile Computer. According to the specifications of the manufacturer, it must comply with the requirements of the following standards:

**FCC Part 15, Subpart E (15.407)**

**ANSI C63.4-2003**

All test items have been performed and recorded as per the above standards.

**NOTE:** The EUT is also considered as a kind of computer peripheral, because the connection to computer is necessary for typical use. It has been verified to comply with the requirements of FCC Part 15, Subpart B, Class B (DoC). The test report has been issued separately.



A D T

### 3.4 DESCRIPTION OF SUPPORT UNITS

The EUT has been tested as an independent unit together with other necessary accessories or support units. The following support units or accessories were used to form a representative test configuration during the tests.

NO.	PRODUCT	BRAND	MODEL NO.	SERIAL NO.	FCC ID
1	NOTEBOOK COMPUTER	DELL	PP19L	CN-OHC416-7016 6-5CA-0448	PIW632500516610
2	NOTEBOOK COMPUTER	DELL	PP17L	CN-ONF743-48643 -7AV-0124	FCC DoC
3	EARPHONE	SYMBOL	NA	NA	NA
4	SD CARD	Transcend	NA	NA	NA
5	BATTERY	SYMBOL	55-060112-05	N/A	NA
6	IPOD	APPLE	A1137	6U6078FMUPR	FCC DOC

No.	Signal cable description
1	NA
2	NA
3	1.3 m wrapped unshielded wire, terminated via drain wire, with 3.5 mm phone plug, w/o core.
4	NA
5	NA
6	1.2 m foil shielded wire, USB connector, w/o core.

Note: 1. All power cords of the above support units are unshielded (1.8m).



### 3.5 CONFIGURATION OF SYSTEM UNDER TEST

**For USB Mode:**

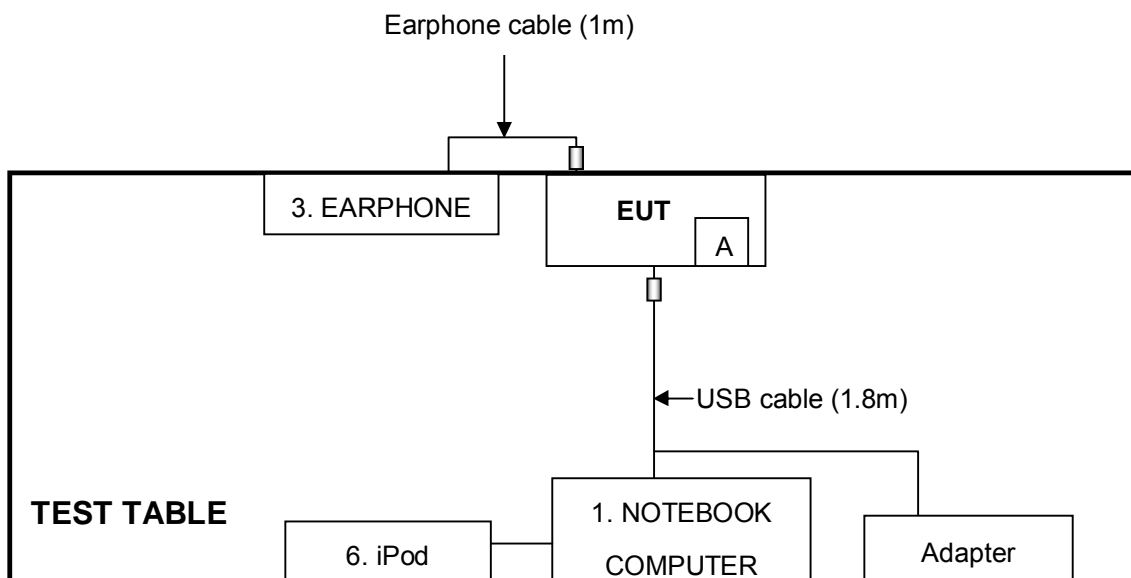

**NOTE:** 1. Item A is the SD Card (Support unit 4).

**For Cradle (1 Slot) Mode:**

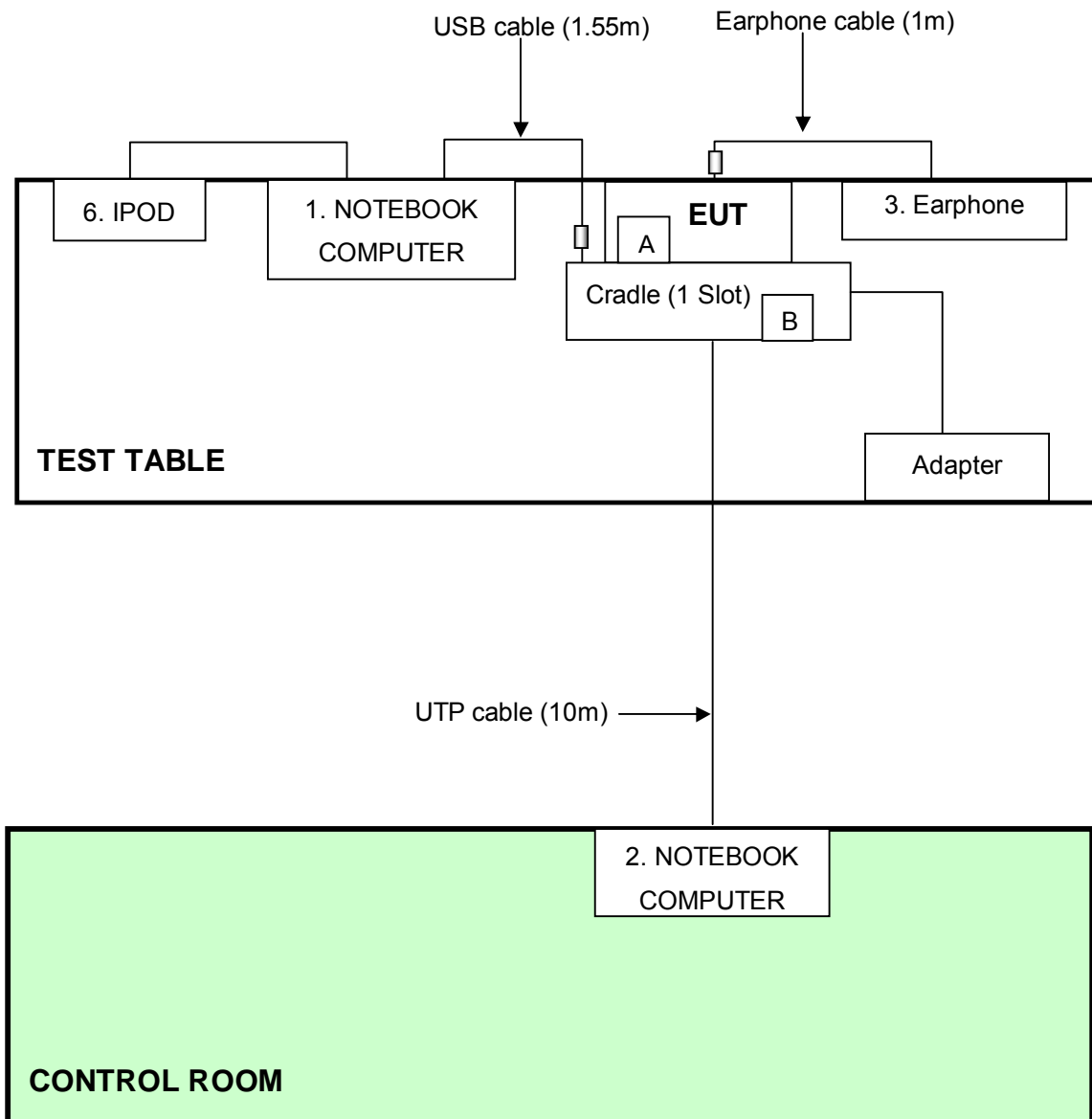

**NOTE:** 1. Item A is the SD Card (Support unit 4).  
 2. Item B is the Battery (Support unit 5).

**For Cradle (4 Slot) Mode:**

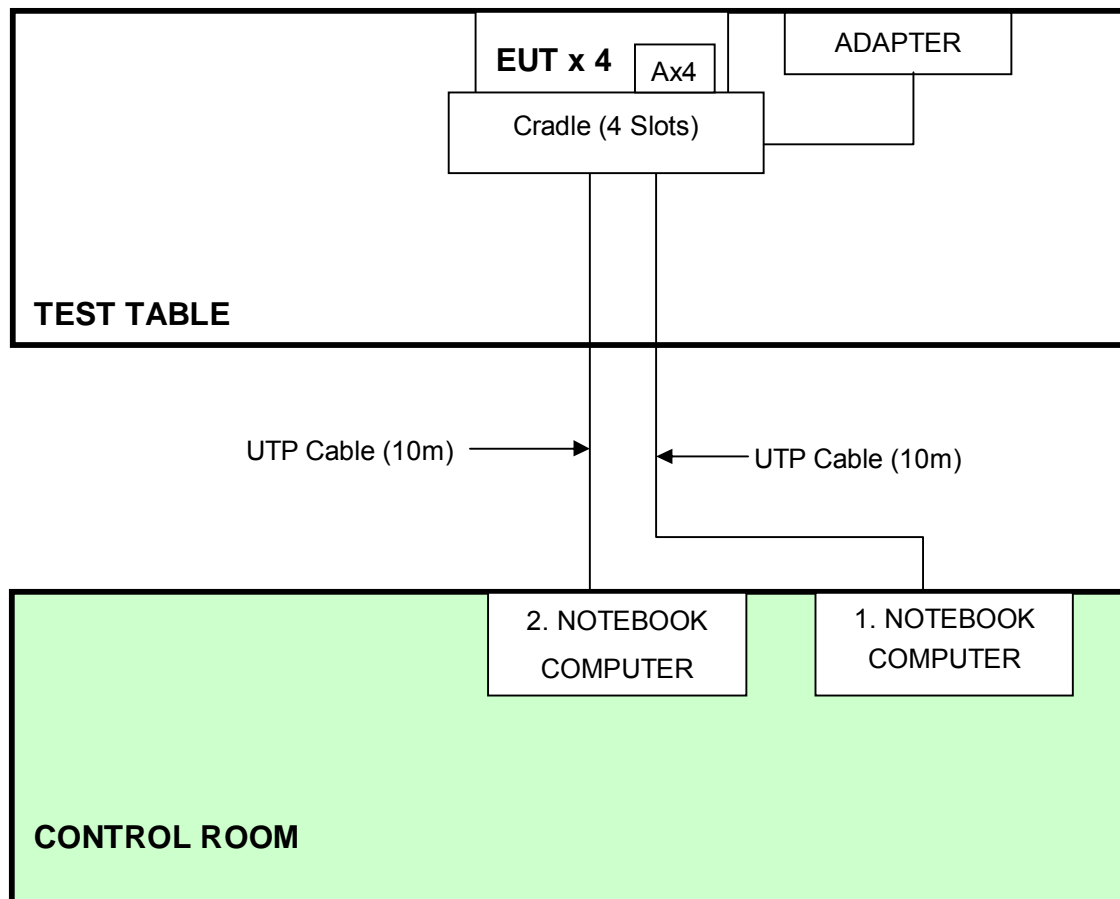

**NOTE:** 1. Item A is the SD Card (Support unit 4).



A D T

## 4. TEST TYPES AND RESULTS

### 4.1 CONDUCTED EMISSION MEASUREMENT

#### 4.1.1 LIMITS OF CONDUCTED EMISSION MEASUREMENT

FREQUENCY OF EMISSION (MHz)	CONDUCTED LIMIT (dB $\mu$ V)	
	Quasi-peak	Average
0.15-0.5	66 to 56	56 to 46
0.5-5	56	46
5-30	60	50

- NOTE:**
1. The lower limit shall apply at the transition frequencies.
  2. The limit decreases in line with the logarithm of the frequency in the range of 0.15 to 0.50 MHz.
  3. All emanations from a class A/B digital device or system, including any network of conductors and apparatus connected thereto, shall not exceed the level of field strengths specified above.

#### 4.1.2 TEST INSTRUMENTS

DESCRIPTION & MANUFACTURER	MODEL NO.	SERIAL NO.	CALIBRATED DATE	CALIBRATED UNTIL
Test Receiver	ESCS 30	100375	Mar. 23, 2009	Mar. 22, 2010
Line-Impedance Stabilization Network(for Peripheral)	ENV-216	100071	Nov. 26, 2008	Nov. 25, 2009
Line-Impedance Stabilization Network (for EUT)	ESH3-Z5	848773/004	Nov. 05, 2008	Nov. 04, 2009
RF Cable (JYEBAO)	5DFB	COBCAB-001	Dec 15, 2008	Dec 14, 2009
50 ohms Terminator	50	3	Nov. 05, 2008	Nov. 04, 2009
Software	BV ADT_ Cond_V7.3.7	NA	NA	NA

**Note:**

1. The calibration interval of the above test instruments is 12 months and the calibrations are traceable to NML/ROC and NIST/USA.
2. The test was performed in Shielded Room No. B.
- 3 The VCCI Con B Registration No. is C-2193.

#### 4.1.3 TEST PROCEDURES

- a. The EUT was placed 0.4 meters from the conducting wall of the shielded room with EUT being connected to the power mains through a line impedance stabilization network (LISN). Other support units were connected to the power mains through another LISN. The two LISNs
- b. provide 50 ohm/ 50uH of coupling impedance for the measuring instrument.
- c. Both lines of the power mains connected to the EUT were checked for maximum conducted interference.
- d. The frequency range from 150kHz to 30MHz was searched. Emission level under (Limit – 20dB) was not recorded.

#### 4.1.4 DEVIATION FROM TEST STANDARD

No deviation

#### 4.1.5 TEST SETUP

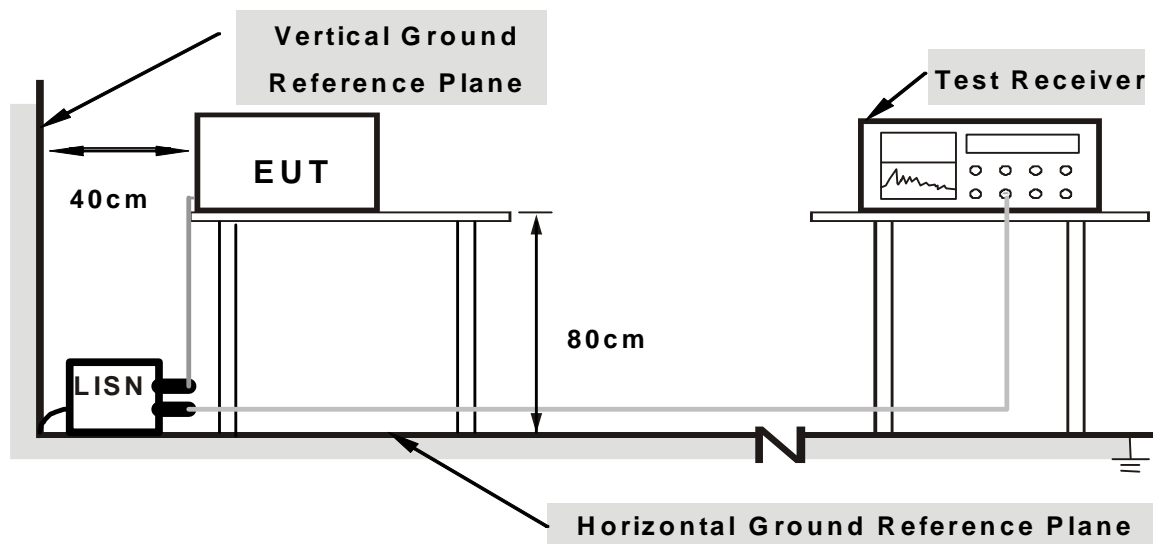

**Note: 1.Support units were connected to second LISN.**

**2.Both of LISNs (AMN) are 80 cm from EUT and at least 80 from other units and other metal planes**

For the actual test configuration, please refer to the related item – Photographs of the Test Configuration.

#### 4.1.6 EUT OPERATING CONDITIONS

##### **For USB Mode:**

1. Set the EUT under charger condition via USB charging cable.
2. EUT runs the test program " CEcTxRx.v1.5.0.0" to transmission/receiving condition continuously.

##### **For Cradle Mode:**

1. Set the EUT under charger condition via cradle.
2. EUT runs the test program " CEcTxRx.v1.5.0.0" to transmission/receiving condition continuously.



A D T

4.1.7 TEST RESULTS  
 802.11a OFDM MODULATION: For USB Mode

EUT TEST CONDITION		MEASUREMENT DETAIL	
CHANNEL	Channel 52	PHASE	Line (L)
MODULATION TYPE	BPSK	6dB BANDWIDTH	9 kHz
TRANSFER RATE	6Mbps	INPUT POWER	120Vac, 60 Hz
ENVIRONMENTAL CONDITIONS	26eg. C, 63RH, 965hPa	TESTED BY	Wen Yu

No	Freq. [MHz]	Corr. Factor (dB)	Reading Value [dB (uV)]		Emission Level [dB (uV)]		Limit [dB (uV)]		Margin (dB)	
			Q.P.	AV.	Q.P.	AV.	Q.P.	AV.	Q.P.	AV.
			1	0.151	0.17	47.41	-	47.58	-	65.92
2	0.181	0.18	42.40	-	42.58	-	64.43	54.43	-21.85	-
3	0.484	0.23	35.46	-	35.49	-	56.27	46.27	-20.78	-
4	4.492	0.65	33.15	-	33.80	-	56.00	46.00	-22.20	-
5	6.486	0.78	40.43	-	41.21	-	60.00	50.00	-18.79	-
6	15.191	1.17	39.97	-	41.14	-	60.00	50.00	-18.86	-

- REMARKS:**
1. Q.P. and AV. are abbreviations of quasi-peak and average individually.
  2. "-": The Quasi-peak reading value also meets average limit and measurement with the average detector is unnecessary.
  3. The emission levels of other frequencies were very low against the limit.
  4. Margin value = Emission level - Limit value
  5. Correction factor = Insertion loss + Cable loss
  6. Emission Level = Correction Factor + Reading Value.

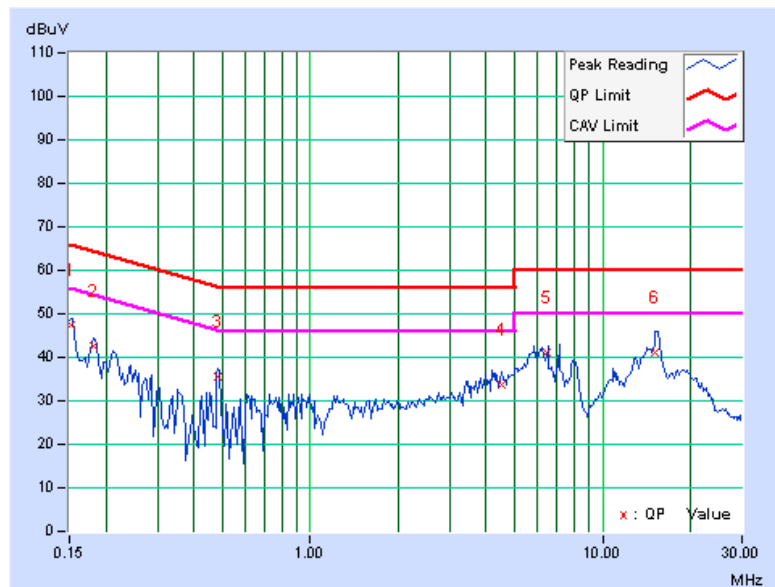

EUT TEST CONDITION		MEASUREMENT DETAIL	
CHANNEL	Channel 52	PHASE	Neutral (N)
MODULATION TYPE	BPSK	6dB BANDWIDTH	9 kHz
TRANSFER RATE	6Mbps	INPUT POWER	120Vac, 60 Hz
ENVIRONMENTAL CONDITIONS	26eg. C, 63RH, 965hPa	TESTED BY	Wen Yu

No	Freq. [MHz]	Corr. Factor (dB)	Reading Value [dB (uV)]		Emission Level [dB (uV)]		Limit [dB (uV)]		Margin (dB)	
			Q.P.	AV.	Q.P.	AV.	Q.P.	AV.	Q.P.	AV.
			1	0.150	0.10	46.44	-	46.54	-	66.00
2	0.181	0.11	41.04	-	41.15	-	64.43	54.43	-23.28	-
3	0.482	0.16	35.20	-	35.36	-	56.30	46.30	-20.94	-
4	4.438	0.57	33.33	-	33.90	-	56.00	46.00	-22.10	-
5	6.105	0.66	37.62	-	38.28	-	60.00	50.00	-21.72	-
6	15.367	0.97	40.21	-	41.18	-	60.00	50.00	-18.82	-

- REMARKS:**
1. Q.P. and AV. are abbreviations of quasi-peak and average individually.
  2. "-": The Quasi-peak reading value also meets average limit and measurement with the average detector is unnecessary.
  3. The emission levels of other frequencies were very low against the limit.
  4. Margin value = Emission level - Limit value
  5. Correction factor = Insertion loss + Cable loss
  6. Emission Level = Correction Factor + Reading Value.

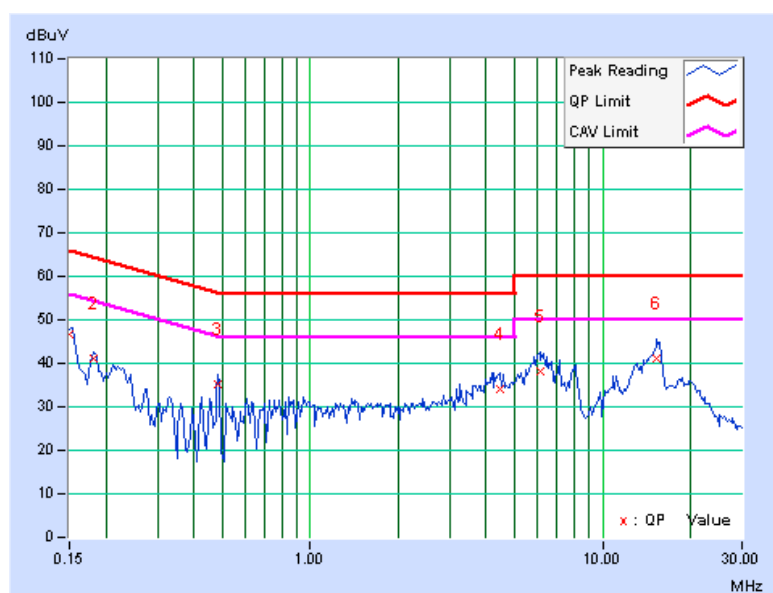





A D T

802.11a OFDM MODULATION: For Cradle (1 Slot) Mode

EUT TEST CONDITION		MEASUREMENT DETAIL	
CHANNEL	Channel 52	PHASE	Line (L)
MODULATION TYPE	BPSK	6dB BANDWIDTH	9 kHz
TRANSFER RATE	6Mbps	INPUT POWER	120Vac, 60 Hz
ENVIRONMENTAL CONDITIONS	26eg. C, 63RH, 965hPa	TESTED BY	Wen Yu

No	Freq. [MHz]	Corr. Factor (dB)	Reading Value [dB (uV)]		Emission Level [dB (uV)]		Limit [dB (uV)]		Margin (dB)	
			Q.P.	AV.	Q.P.	AV.	Q.P.	AV.	Q.P.	AV.
	1	0.205	0.18	45.55	-	45.73	-	63.42	53.42	-17.69
2	0.306	0.19	36.41	-	36.60	-	60.07	50.07	-23.48	-
3	0.412	0.19	37.43	-	37.62	-	57.61	47.61	-19.99	-
4	0.615	0.28	37.96	-	38.24	-	56.00	46.00	-17.76	-
5	0.884	0.39	33.29	-	33.68	-	56.00	46.00	-22.32	-
6	1.300	0.47	33.31	-	33.78	-	56.00	46.00	-22.22	-

- REMARKS:**
1. Q.P. and AV. are abbreviations of quasi-peak and average individually.
  2. "-": The Quasi-peak reading value also meets average limit and measurement with the average detector is unnecessary.
  3. The emission levels of other frequencies were very low against the limit.
  4. Margin value = Emission level - Limit value
  5. Correction factor = Insertion loss + Cable loss
  6. Emission Level = Correction Factor + Reading Value.

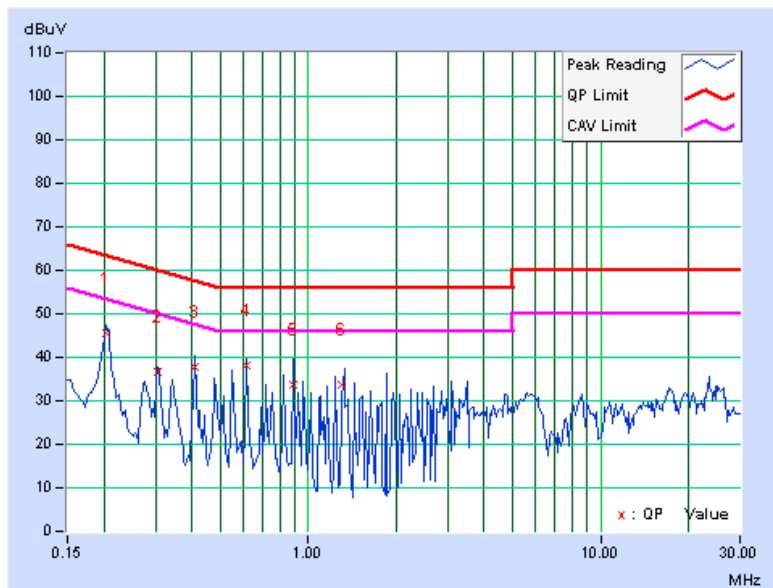

EUT TEST CONDITION		MEASUREMENT DETAIL	
CHANNEL	Channel 52	PHASE	Neutral (N)
MODULATION TYPE	BPSK	6dB BANDWIDTH	9 kHz
TRANSFER RATE	6Mbps	INPUT POWER	120Vac, 60 Hz
ENVIRONMENTAL CONDITIONS	26eg. C, 63RH, 965hPa	TESTED BY	Wen Yu

No	Freq. [MHz]	Corr. Factor (dB)	Reading Value [dB (uV)]		Emission Level [dB (uV)]		Limit [dB (uV)]		Margin (dB)	
			Q.P.	AV.	Q.P.	AV.	Q.P.	AV.	Q.P.	AV.
			1	0.205	0.11	45.86	-	45.97	-	63.42
2	0.306	0.12	36.57	-	36.69	-	60.07	50.07	-23.38	-
3	0.408	0.13	32.27	-	32.40	-	57.69	47.69	-25.29	-
4	0.615	0.21	31.63	-	31.84	-	56.00	46.00	-24.16	-
5	0.822	0.28	34.72	-	35.00	-	56.00	46.00	-21.00	-
6	0.924	0.32	29.76	-	30.08	-	56.00	46.00	-25.92	-

- REMARKS:**
1. Q.P. and AV. are abbreviations of quasi-peak and average individually.
  2. "-": The Quasi-peak reading value also meets average limit and measurement with the average detector is unnecessary.
  3. The emission levels of other frequencies were very low against the limit.
  4. Margin value = Emission level - Limit value
  5. Correction factor = Insertion loss + Cable loss
  6. Emission Level = Correction Factor + Reading Value.

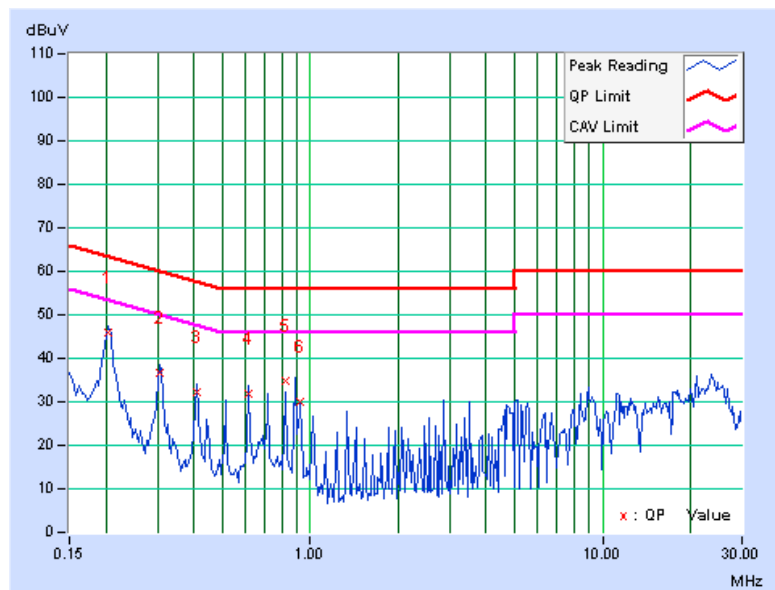



A D T

802.11a OFDM MODULATION: For Cradle (4 Slot) Mode

EUT TEST CONDITION		MEASUREMENT DETAIL	
CHANNEL	Channel 52	PHASE	Line (L)
MODULATION TYPE	BPSK	6dB BANDWIDTH	9 kHz
TRANSFER RATE	6Mbps	INPUT POWER	120Vac, 60 Hz
ENVIRONMENTAL CONDITIONS	26eg. C, 63RH, 965hPa	TESTED BY	Wen Yu

No	Freq. [MHz]	Corr. Factor (dB)	Reading Value [dB (uV)]		Emission Level [dB (uV)]		Limit [dB (uV)]		Margin (dB)	
			Q.P.	AV.	Q.P.	AV.	Q.P.	AV.	Q.P.	AV.
	1	0.150	0.17	50.08	-	50.25	-	66.00	56.00	-15.75
2	0.162	0.17	51.77	-	51.94	-	65.38	55.38	-13.43	-
3	0.173	0.17	43.26	-	43.43	-	64.79	54.79	-21.36	-
4	0.227	0.18	39.18	-	39.36	-	62.56	52.56	-23.20	-
5	0.295	0.18	32.16	-	32.34	-	60.40	50.40	-28.05	-
6	0.748	0.33	27.59	-	27.92	-	56.00	46.00	-28.08	-

- REMARKS:**
1. Q.P. and AV. are abbreviations of quasi-peak and average individually.
  2. "-": The Quasi-peak reading value also meets average limit and measurement with the average detector is unnecessary.
  3. The emission levels of other frequencies were very low against the limit.
  4. Margin value = Emission level - Limit value
  5. Correction factor = Insertion loss + Cable loss
  6. Emission Level = Correction Factor + Reading Value.

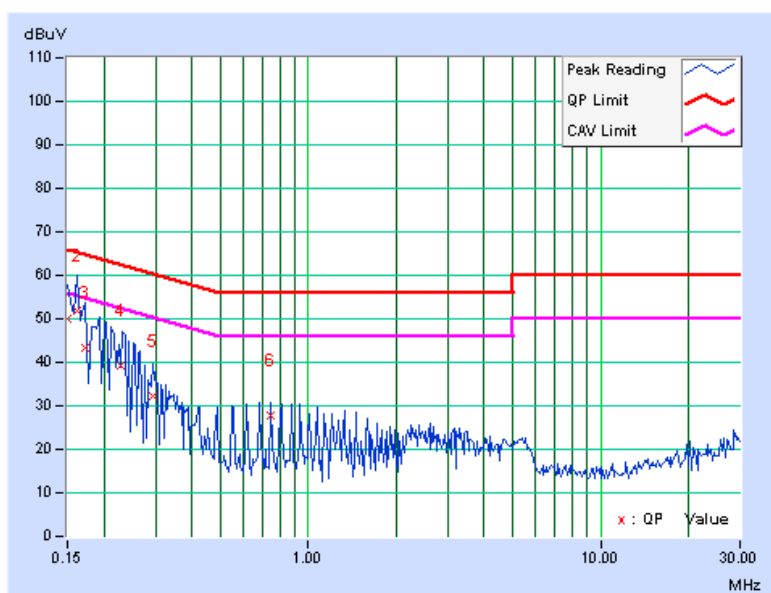

EUT TEST CONDITION		MEASUREMENT DETAIL	
CHANNEL	Channel 52	PHASE	Neutral (N)
MODULATION TYPE	BPSK	6dB BANDWIDTH	9 kHz
TRANSFER RATE	6Mbps	INPUT POWER	120Vac, 60 Hz
ENVIRONMENTAL CONDITIONS	26eg. C, 63RH, 965hPa	TESTED BY	Wen Yu

No	Freq. [MHz]	Corr. Factor (dB)	Reading Value [dB (uV)]		Emission Level [dB (uV)]		Limit [dB (uV)]		Margin (dB)	
			Q.P.	AV.	Q.P.	AV.	Q.P.	AV.	Q.P.	AV.
	1	0.159	0.17	51.60	-	51.77	-	65.51	55.51	-13.74
2	0.227	0.18	40.32	-	40.50	-	62.56	52.56	-22.06	-
3	0.228	0.18	40.14	-	40.32	-	62.52	52.52	-22.20	-
4	0.291	0.18	35.42	-	35.60	-	60.51	50.51	-24.90	-
5	0.619	0.28	27.56	-	27.84	-	56.00	46.00	-28.16	-
6	0.748	0.33	28.09	-	28.42	-	56.00	46.00	-27.58	-

- REMARKS:**
1. Q.P. and AV. are abbreviations of quasi-peak and average individually.
  2. "-": The Quasi-peak reading value also meets average limit and measurement with the average detector is unnecessary.
  3. The emission levels of other frequencies were very low against the limit.
  4. Margin value = Emission level - Limit value
  5. Correction factor = Insertion loss + Cable loss
  6. Emission Level = Correction Factor + Reading Value.

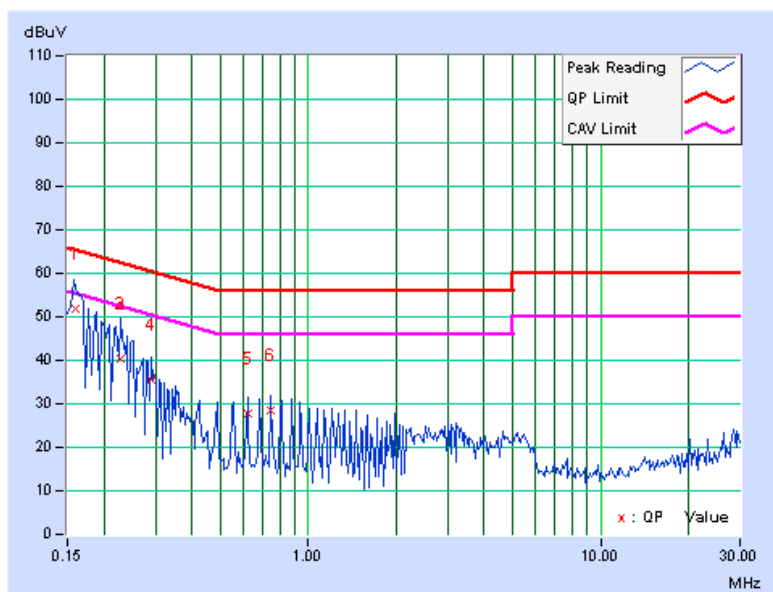

## 4.2 RADIATED EMISSION MEASUREMENT

### 4.2.1 LIMITS OF RADIATED EMISSION MEASUREMENT

Emissions radiated outside of the specified bands, shall be according to the general radiated limits in 15.209 as following:

Frequencies (MHz)	Field strength (microvolts/meter)	Measurement distance (meters)
0.009-0.490	2400/F(kHz)	300
0.490-1.705	24000/F(kHz)	30
1.705-30.0	30	30
30-88	100	3
88-216	150	3
216-960	200	3
Above 960	500	3

**NOTE:**

1. The lower limit shall apply at the transition frequencies.
2. Emission level (dBuV/m) = 20 log Emission level (uV/m).
3. As shown in 15.35(b), for frequencies above 1000MHz, the field strength limits are based on average detector, however, the peak field strength of any emission shall not exceed the maximum permitted average limits, specified above by more than 20dB under any condition of modulation.



A D T

#### 4.2.2 LIMITS OF UNWANTED EMISSION OUT OF THE RESTRICTED BANDS

Frequencies (MHz)	EIRP Limit (dBm)	Equivalent Field Strength at 3m (dB $\mu$ V/m) *note 3
5150~5250	-27	68.3
5250~5350	-27	68.3
5470~5725	-27	68.3
5725~5825	-27 *note 1	68.3
	-17 *note 2	78.3

**NOTE:**

1. For frequencies 10MHz or greater above or below the band edge.
2. All emissions within the frequency range from the band edge to 10MHz above or below the band edge.
3. The following formula is used to convert the equipment isotropic radiated power (eirp) to field strength

$$E = \frac{1000000\sqrt{30P}}{3} \mu\text{V/m, where P is the eirp (Watts)}$$



A D T

#### 4.2.3 TEST INSTRUMENTS

##### For radiated emission test (Below 1 GHz):

DESCRIPTION & MANUFACTURER	MODEL NO.	SERIAL NO.	CALIBRATED DATE	CALIBRATED UNTIL
ROHDE & SCHWARZ Spectrum Analyzer	FSP40	100036	Dec. 9, 2008	Dec. 8, 2009
HP Pre_Amplifier	8449B	3008A01923	Nov. 10, 2008	Nov. 9, 2009
ROHDE & SCHWARZ Test Receiver	ESCS30	847124/029	Sep. 9, 2008	Sep. 8, 2009
SCHWARZBECK TRILOG Broadband Antenna	VULB 9168	138	April 29, 2009	April 28, 2010
Schwarzbeck Horn_Antenna	BBHA9120	D124	Dec. 09, 2008	Dec. 08, 2009
Schwarzbeck Horn_Antenna	BBHA 9170	BBHA9170153	Jan. 22, 2009	Jan. 21, 2010
RF Switches	EMH-011	08009	Oct. 07, 2008	Oct. 06, 2009
RF CABLE (Chaintek)	Sucoflex 106	28077	Aug. 14, 2009	Aug. 13, 2010
RF Cable	8DFB	STCCAB-30M-1GHz	Oct. 07, 2008	Oct. 06, 2009
Software	ADT_Radiated_V7.6.15.9.2	NA	NA	NA
CT Antenna Tower & Turn Table	NA	NA	NA	NA

Note: 1. The calibration interval of the above test instruments is 12 months and the calibrations are traceable to NML/ROC and NIST/USA.

2. The horn antenna, HP preamplifier (model: 8449B) and Spectrum Analyzer (model: FSP40) are used only for the measurement of emission frequency above 1GHz if tested.

3. The test was performed in Open Site No. C.

4. The FCC Site Registration No. is 656396.

5. The VCCI Site Registration No. is R-1626.

6. The CANADA Site Registration No. is IC 7450G-3.



A D T

**For radiated emission test (Above 1 GHz):**

DESCRIPTION & MANUFACTURER	MODEL NO.	SERIAL NO.	CALIBRATED DATE	CALIBRATED UNTIL
ADVANTEST Spectrum Analyzer	U3751	170100022	Nov. 17, 2008	Nov. 16, 2009
ADVANTEST Spectrum Analyzer	U3772	160100280	July 25, 2009	July 24, 2010
HP Pre_Amplifier	8449B	3008A01922	Sep. 25, 2008	Sep. 24, 2009
ROHDE & SCHWARZ Test Receiver	ESVS 30	841977/002	Nov. 03, 2008	Nov. 02, 2009
SCHAFFNER(CHASE) Broadband Antenna	CBL6112B	2798	April 29, 2009	April 28, 2010
Schwarzbeck Horn_Antenna	BBHA9120-D1	D123	Sep. 30, 2008	Sep. 29, 2009
Schwarzbeck Horn_Antenna	BBHA 9170	BBHA9170153	Jan. 23, 2009	Jan. 22, 2010
RF Switches	MP59B	6100175593	Sep. 02, 2008	Sep. 01, 2009
RF Cable	8DFB	STBCAB-30M-1GHz	Sep. 02, 2008	Sep. 01, 2009
Software	ADT_Radiated_V7.6.15.9.2	NA	NA	NA
CT Antenna Tower & Turn Table	NA	NA	NA	NA
CORCOM AC Filter	MRI2030	024/019	NA	NA

Note: 1. The calibration interval of the above test instruments is 12 months and the calibrations are traceable to NML/ROC and NIST/USA.

2. The horn antenna, HP preamplifier (model: 8449B) and Spectrum Analyzer (model: U3772) are used only for the measurement of emission frequency above 1GHz if tested.

3. The test was performed in Open Site No. B.

4. The VCCI Site Registration No. is R-847.

5. The FCC Site Registration No. is 92753.

6. The CANADA Site Registration No. is IC 7450G-2.



#### 4.2.4 TEST PROCEDURES

- a. The EUT was placed on the top of a rotating table 0.8 meters above the ground at a 10 meter open area test site. The table was rotated 360 degrees to determine the position of the highest radiation.
- b. The EUT was set 3 meters away from the interference-receiving antenna, which was mounted on the top of a variable-height antenna tower.
- c. The antenna is a broadband antenna, and its height is varied from one meter to four meters above the ground to determine the maximum value of the field strength. Both horizontal and vertical polarizations of the antenna are set to make the measurement.
- d. For each suspected emission, the EUT was arranged to its worst case and then the antenna was tuned to heights from 1 meter to 4 meters and the rotatable table was turned from 0 degrees to 360 degrees to find the maximum reading.
- e. The test-receiver system was set to Peak Detect Function and Specified Bandwidth with Maximum Hold Mode.
- f. If the emission level of the EUT in peak mode was 10dB lower than the limit specified, then testing could be stopped and the peak values of the EUT would be reported. Otherwise the emissions that did not have 10dB margin would be re-tested one by one using peak, quasi-peak or average method as specified and then reported in a data sheet.

**NOTE:**

1. The resolution bandwidth and video bandwidth of test receiver/spectrum analyzer is 120kHz for Peak detection (PK) and Quasi-peak detection (QP) at frequency below 1GHz.
2. The resolution bandwidth of test receiver/spectrum analyzer is 1 MHz and the video bandwidth is 3 MHz for Peak detection (PK) at frequency above 1GHz.
3. The resolution bandwidth of test receiver/spectrum analyzer is 1 MHz and the video bandwidth is 10 Hz for Average detection (AV) at frequency above 1GHz.

#### 4.2.5 DEVIATION FROM TEST STANDARD

No deviation

#### 4.2.6 TEST SETUP

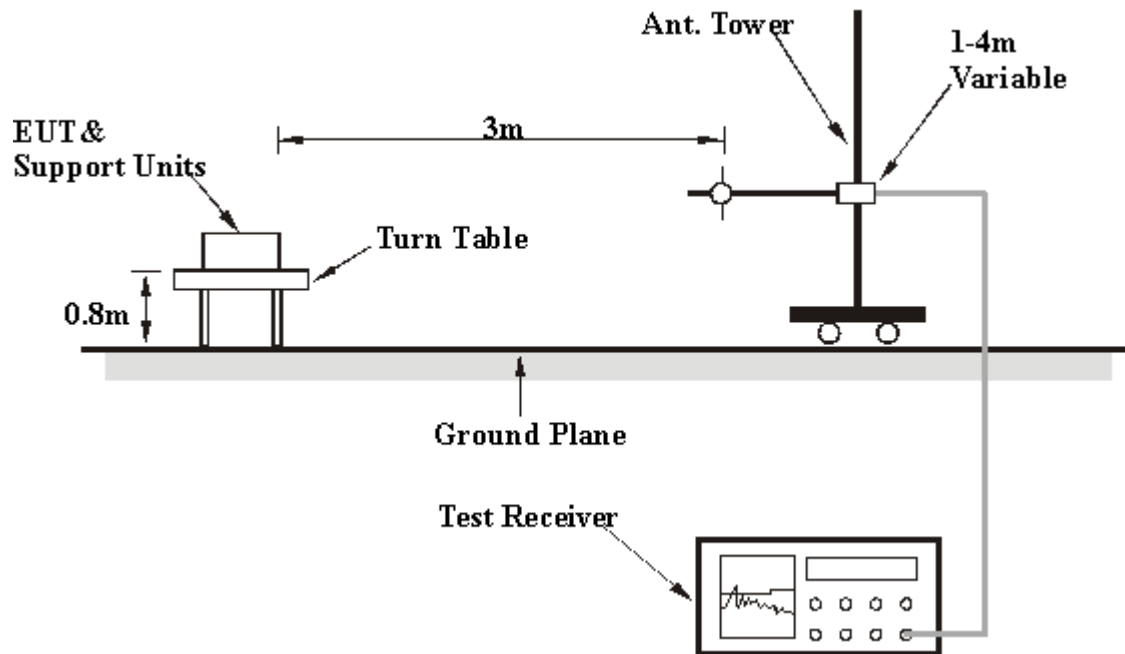

For the actual test configuration, please refer to the related item – Photographs of the Test Configuration.

#### 4.2.7 EUT OPERATING CONDITION

Same as the 4.1.6.

## Below 1GHz Test Data

### 4.2.8 TEST RESULTS

#### BELOW 1GHz WORST-CASE DATA : 802.11a OFDM MODULATION

EUT TEST CONDITION		MEASUREMENT DETAIL	
CHANNEL	Channel 36	FREQUENCY RANGE	Below 1000MHz
INPUT POWER (SYSTEM)	120Vac, 60 Hz	DETECTOR FUNCTION	Quasi-Peak
ENVIRONMENTAL CONDITIONS	25.0deg. C, 66.0%RH 965hPa	TESTED BY	Frank Liu

ANTENNA POLARITY & TEST DISTANCE: HORIZONTAL AT 3 M								
NO.	FREQ. (MHz)	EMISSION LEVEL (dBuV/m)	LIMIT (dBuV/m)	MARGIN (dB)	ANTENNA HEIGHT (m)	TABLE ANGLE (Degree)	RAW VALUE (dBuV)	CORRECTION FACTOR (dB/m)
1	40.67	23.12 QP	40.00	-16.88	1.22 H	174	8.52	14.60
2	65.74	28.66 QP	40.00	-11.34	1.42 H	123	15.17	13.49
3	139.24	30.66 QP	43.50	-12.84	1.21 H	46	16.13	14.53
4	173.32	28.46 QP	43.50	-15.04	1.00 H	156	13.37	15.09
5	250.00	26.45 QP	46.00	-19.55	1.00 H	183	12.20	14.25
6	375.00	36.99 QP	46.00	-9.01	1.00 H	169	18.18	18.81
ANTENNA POLARITY & TEST DISTANCE: VERTICAL AT 3 M								
NO.	FREQ. (MHz)	EMISSION LEVEL (dBuV/m)	LIMIT (dBuV/m)	MARGIN (dB)	ANTENNA HEIGHT (m)	TABLE ANGLE (Degree)	RAW VALUE (dBuV)	CORRECTION FACTOR (dB/m)
1	39.56	30.11 QP	40.00	-9.89	1.00 V	241	15.63	14.48
2	79.95	26.42 QP	40.00	-13.58	1.00 V	244	15.53	10.89
3	135.24	27.59 QP	43.50	-15.91	1.00 V	153	13.47	14.12
4	151.56	28.68 QP	43.50	-14.82	1.00 V	29	12.94	15.74
5	250.00	25.29 QP	46.00	-20.71	1.00 V	73	11.04	14.25
6	375.00	35.63 QP	46.00	-10.37	1.00 V	186	16.82	18.81

- REMARKS:**
1. Emission level (dBuV/m) = Raw Value (dBuV) + Correction Factor (dB/m).
  2. Correction Factor (dB/m) = Antenna Factor (dB/m) + Cable Factor (dB).
  3. The other emission levels were very low against the limit.
  4. Margin value = Emission level – Limit value.



A D T

## Above 1GHz Test Data

### 4.2.9 TEST RESULTS

#### 802.11a OFDM MODULATION

EUT TEST CONDITION		MEASUREMENT DETAIL	
CHANNEL	Channel 36	FREQUENCY RANGE	1 ~ 40GHz
INPUT POWER (SYSTEM)	120Vac, 60 Hz	DETECTOR FUNCTION	Peak (PK) Average (AV)
ENVIRONMENTAL CONDITIONS	28.0deg. C, 62.0%RH 965hPa	TESTED BY	Duke Tseng

ANTENNA POLARITY & TEST DISTANCE: HORIZONTAL AT 3 M								
NO.	FREQ. (MHz)	EMISSION LEVEL (dBuV/m)	LIMIT (dBuV/m)	MARGIN (dB)	ANTENNA HEIGHT (m)	TABLE ANGLE (Degree)	RAW VALUE (dBuV)	CORRECTION FACTOR (dB/m)
1	5150.00	56.24 PK	74.00	-17.76	1.00 H	29	20.05	36.19
2	5150.00	44.93 AV	54.00	-9.07	1.00 H	29	8.74	36.19
3	*5180.00	96.71 PK			1.00 H	30	60.47	36.24
4	*5180.00	87.90 AV			1.00 H	30	51.66	36.24
5	#10360.00	53.27 PK	68.30	-15.03	1.00 H	20	7.36	45.91
ANTENNA POLARITY & TEST DISTANCE: VERTICAL AT 3 M								
NO.	FREQ. (MHz)	EMISSION LEVEL (dBuV/m)	LIMIT (dBuV/m)	MARGIN (dB)	ANTENNA HEIGHT (m)	TABLE ANGLE (Degree)	RAW VALUE (dBuV)	CORRECTION FACTOR (dB/m)
1	5150.00	58.83 PK	74.00	-15.17	1.08 V	65	22.64	36.19
2	5150.00	45.51 AV	54.00	-8.49	1.08 V	65	9.32	36.19
3	*5180.00	103.77 PK			1.08 V	65	67.53	36.24
4	*5180.00	94.72 AV			1.08 V	65	58.48	36.24
5	#10360.00	54.82 PK	68.30	-13.48	1.48 V	85	8.91	45.91

- REMARKS:**
1. Emission level (dBuV/m) = Raw Value (dBuV) + Correction Factor (dB/m).
  2. Correction Factor (dB/m) = Antenna Factor (dB/m) + Cable Factor (dB).
  3. The other emission levels were very low against the limit.
  4. Margin value = Emission level – Limit value.
  5. “ \* “: Fundamental frequency.
  6. “#”: The radiated frequency is out the restricted band.



A D T

EUT TEST CONDITION		MEASUREMENT DETAIL	
CHANNEL	Channel 40	FREQUENCY RANGE	1 ~ 40GHz
INPUT POWER (SYSTEM)	120Vac, 60 Hz	DETECTOR FUNCTION	Peak (PK) Average (AV)
ENVIRONMENTAL CONDITIONS	28.0deg. C, 62.0%RH 965hPa	TESTED BY	Duke Tseng

ANTENNA POLARITY & TEST DISTANCE: HORIZONTAL AT 3 M								
NO.	FREQ. (MHz)	EMISSION LEVEL (dBuV/m)	LIMIT (dBuV/m)	MARGIN (dB)	ANTENNA HEIGHT (m)	TABLE ANGLE (Degree)	RAW VALUE (dBuV)	CORRECTION FACTOR (dB/m)
1	*5200.00	96.55 PK			1.01 H	39	60.27	36.28
2	*5200.00	87.64 AV			1.01 H	39	51.36	36.28
3	#10400.00	53.37 PK	68.30	-14.93	1.00 H	27	7.34	46.03
ANTENNA POLARITY & TEST DISTANCE: VERTICAL AT 3 M								
NO.	FREQ. (MHz)	EMISSION LEVEL (dBuV/m)	LIMIT (dBuV/m)	MARGIN (dB)	ANTENNA HEIGHT (m)	TABLE ANGLE (Degree)	RAW VALUE (dBuV)	CORRECTION FACTOR (dB/m)
1	*5200.00	103.60 PK			1.09 V	69	67.32	36.28
2	*5200.00	94.62 AV			1.09 V	69	58.34	36.28
3	#10400.00	54.56 PK	68.30	-13.74	1.43 V	81	8.53	46.03

- REMARKS:**
1. Emission level (dBuV/m) = Raw Value (dBuV) + Correction Factor (dB/m).
  2. Correction Factor (dB/m) = Antenna Factor (dB/m) + Cable Factor (dB).
  3. The other emission levels were very low against the limit.
  4. Margin value = Emission level – Limit value.
  5. “ \* “: Fundamental frequency.
  6. “#”:The radiated frequency is out the restricted band.



A D T

EUT TEST CONDITION		MEASUREMENT DETAIL	
CHANNEL	Channel 48	FREQUENCY RANGE	1 ~ 40GHz
INPUT POWER (SYSTEM)	120Vac, 60 Hz	DETECTOR FUNCTION	Peak (PK) Average (AV)
ENVIRONMENTAL CONDITIONS	28.0deg. C, 62.0%RH 965hPa	TESTED BY	Duke Tseng

ANTENNA POLARITY & TEST DISTANCE: HORIZONTAL AT 3 M								
NO.	FREQ. (MHz)	EMISSION LEVEL (dBuV/m)	LIMIT (dBuV/m)	MARGIN (dB)	ANTENNA HEIGHT (m)	TABLE ANGLE (Degree)	RAW VALUE (dBuV)	CORRECTION FACTOR (dB/m)
1	*5240.00	96.97 PK			1.00 H	40	60.67	36.30
2	*5240.00	88.06 AV			1.00 H	40	51.76	36.30
3	#10480.00	53.43 PK	68.30	-14.87	1.00 H	28	7.18	46.25
ANTENNA POLARITY & TEST DISTANCE: VERTICAL AT 3 M								
NO.	FREQ. (MHz)	EMISSION LEVEL (dBuV/m)	LIMIT (dBuV/m)	MARGIN (dB)	ANTENNA HEIGHT (m)	TABLE ANGLE (Degree)	RAW VALUE (dBuV)	CORRECTION FACTOR (dB/m)
1	*5240.00	104.09 PK			1.09 V	74	67.79	36.30
2	*5240.00	95.14 AV			1.09 V	74	58.84	36.30
3	#10480.00	55.02 PK	68.30	-13.28	1.44 V	87	8.77	46.25

- REMARKS:**
1. Emission level (dBuV/m) = Raw Value (dBuV) + Correction Factor (dB/m).
  2. Correction Factor (dB/m) = Antenna Factor (dB/m) + Cable Factor (dB).
  3. The other emission levels were very low against the limit.
  4. Margin value = Emission level – Limit value.
  5. “ \* “: Fundamental frequency.
  6. “#”:The radiated frequency is out the restricted band.



A D T

EUT TEST CONDITION		MEASUREMENT DETAIL	
CHANNEL	Channel 52	FREQUENCY RANGE	1 ~ 40GHz
INPUT POWER (SYSTEM)	120Vac, 60 Hz	DETECTOR FUNCTION	Peak (PK) Average (AV)
ENVIRONMENTAL CONDITIONS	28.0deg. C, 62.0%RH 965hPa	TESTED BY	Duke Tseng

ANTENNA POLARITY & TEST DISTANCE: HORIZONTAL AT 3 M								
NO.	FREQ. (MHz)	EMISSION LEVEL (dBuV/m)	LIMIT (dBuV/m)	MARGIN (dB)	ANTENNA HEIGHT (m)	TABLE ANGLE (Degree)	RAW VALUE (dBuV)	CORRECTION FACTOR (dB/m)
1	*5260.00	98.19 PK			1.01 H	40	61.87	36.32
2	*5260.00	89.23 AV			1.01 H	40	52.91	36.32
3	#10520.00	53.57 PK	68.30	-14.73	1.00 H	24	7.25	46.32
ANTENNA POLARITY & TEST DISTANCE: VERTICAL AT 3 M								
NO.	FREQ. (MHz)	EMISSION LEVEL (dBuV/m)	LIMIT (dBuV/m)	MARGIN (dB)	ANTENNA HEIGHT (m)	TABLE ANGLE (Degree)	RAW VALUE (dBuV)	CORRECTION FACTOR (dB/m)
1	*5260.00	106.18 PK			1.08 V	74	69.86	36.32
2	*5260.00	96.93 AV			1.08 V	74	60.61	36.32
3	#10520.00	55.11 PK	68.30	-13.19	1.47 V	88	8.79	46.32

- REMARKS:**
1. Emission level (dBuV/m) = Raw Value (dBuV) + Correction Factor (dB/m).
  2. Correction Factor (dB/m) = Antenna Factor (dB/m) + Cable Factor (dB).
  3. The other emission levels were very low against the limit.
  4. Margin value = Emission level – Limit value.
  5. “ \* “: Fundamental frequency.
  6. “#”:The radiated frequency is out the restricted band.



A D T

EUT TEST CONDITION		MEASUREMENT DETAIL	
CHANNEL	Channel 60	FREQUENCY RANGE	1 ~ 40GHz
INPUT POWER (SYSTEM)	120Vac, 60 Hz	DETECTOR FUNCTION	Peak (PK) Average (AV)
ENVIRONMENTAL CONDITIONS	28.0deg. C, 62.0%RH 965hPa	TESTED BY	Duke Tseng

ANTENNA POLARITY & TEST DISTANCE: HORIZONTAL AT 3 M								
NO.	FREQ. (MHz)	EMISSION LEVEL (dBuV/m)	LIMIT (dBuV/m)	MARGIN (dB)	ANTENNA HEIGHT (m)	TABLE ANGLE (Degree)	RAW VALUE (dBuV)	CORRECTION FACTOR (dB/m)
1	*5300.00	94.31 PK			1.00 H	43	57.97	36.34
2	*5300.00	85.86 AV			1.00 H	43	49.52	36.34
3	10600.00	54.38 PK	74.00	-19.62	1.00 H	54	7.99	46.39
4	10600.00	42.81 AV	54.00	-11.19	1.00 H	54	-3.58	46.39
ANTENNA POLARITY & TEST DISTANCE: VERTICAL AT 3 M								
NO.	FREQ. (MHz)	EMISSION LEVEL (dBuV/m)	LIMIT (dBuV/m)	MARGIN (dB)	ANTENNA HEIGHT (m)	TABLE ANGLE (Degree)	RAW VALUE (dBuV)	CORRECTION FACTOR (dB/m)
1	*5300.00	103.09 PK			1.08 V	74	66.75	36.34
2	*5300.00	94.09 AV			1.08 V	74	57.75	36.34
3	10600.00	54.84 PK	74.00	-19.16	1.49 V	94	8.45	46.39
4	10600.00	43.08 AV	54.00	-10.92	1.49 V	94	-3.31	46.39

- REMARKS:**
1. Emission level (dBuV/m) = Raw Value (dBuV) + Correction Factor (dB/m).
  2. Correction Factor (dB/m) = Antenna Factor (dB/m) + Cable Factor (dB).
  3. The other emission levels were very low against the limit.
  4. Margin value = Emission level – Limit value.
  5. “ \* “: Fundamental frequency.





A D T

EUT TEST CONDITION		MEASUREMENT DETAIL	
CHANNEL	Channel 64	FREQUENCY RANGE	1 ~ 40GHz
INPUT POWER (SYSTEM)	120Vac, 60 Hz	DETECTOR FUNCTION	Peak (PK) Average (AV)
ENVIRONMENTAL CONDITIONS	28.0deg. C, 62.0%RH 965hPa	TESTED BY	Duke Tseng

ANTENNA POLARITY & TEST DISTANCE: HORIZONTAL AT 3 M								
NO.	FREQ. (MHz)	EMISSION LEVEL (dBuV/m)	LIMIT (dBuV/m)	MARGIN (dB)	ANTENNA HEIGHT (m)	TABLE ANGLE (Degree)	RAW VALUE (dBuV)	CORRECTION FACTOR (dB/m)
1	*5320.00	94.80 PK			1.08 H	30	58.44	36.36
2	*5320.00	85.83 AV			1.08 H	30	49.47	36.36
3	5350.00	55.11 PK	74.00	-18.89	1.07 H	30	18.71	36.40
4	5350.00	42.45 AV	54.00	-11.55	1.07 H	30	6.05	36.40
5	10640.00	54.72 PK	74.00	-19.28	1.00 H	20	8.28	46.44
6	10640.00	41.66 AV	54.00	-12.34	1.00 H	20	-4.78	46.44
ANTENNA POLARITY & TEST DISTANCE: VERTICAL AT 3 M								
NO.	FREQ. (MHz)	EMISSION LEVEL (dBuV/m)	LIMIT (dBuV/m)	MARGIN (dB)	ANTENNA HEIGHT (m)	TABLE ANGLE (Degree)	RAW VALUE (dBuV)	CORRECTION FACTOR (dB/m)
1	*5320.00	103.51 PK			1.05 V	71	67.15	36.36
2	*5320.00	94.33 AV			1.05 V	71	57.97	36.36
3	5350.00	57.03 PK	74.00	-16.97	1.05 V	74	20.63	36.40
4	5350.00	44.45 AV	54.00	-9.55	1.05 V	74	8.05	36.40
5	10640.00	56.07 PK	74.00	-17.93	1.47 V	93	9.63	46.44
6	10640.00	43.17 AV	54.00	-10.83	1.47 V	93	-3.27	46.44

- REMARKS:**
1. Emission level (dBuV/m) = Raw Value (dBuV) + Correction Factor (dB/m).
  2. Correction Factor (dB/m) = Antenna Factor (dB/m) + Cable Factor (dB).
  3. The other emission levels were very low against the limit.
  4. Margin value = Emission level – Limit value.
  5. “ \* “: Fundamental frequency.



A D T

EUT TEST CONDITION		MEASUREMENT DETAIL	
CHANNEL	Channel 100	FREQUENCY RANGE	1 ~ 40GHz
INPUT POWER (SYSTEM)	120Vac, 60 Hz	DETECTOR FUNCTION	Peak (PK) Average (AV)
ENVIRONMENTAL CONDITIONS	28.0deg. C, 62.0%RH 965hPa	TESTED BY	Duke Tseng

ANTENNA POLARITY & TEST DISTANCE: HORIZONTAL AT 3 M								
NO.	FREQ. (MHz)	EMISSION LEVEL (dBuV/m)	LIMIT (dBuV/m)	MARGIN (dB)	ANTENNA HEIGHT (m)	TABLE ANGLE (Degree)	RAW VALUE (dBuV)	CORRECTION FACTOR (dB/m)
1	5460.00	53.55 PK	74.00	-20.45	1.00 H	42	17.02	36.53
2	5460.00	41.11 AV	54.00	-12.89	1.00 H	42	4.58	36.53
3	#5470.00	53.21 PK	68.30	-15.09	1.00 H	42	16.67	36.54
4	*5500.00	94.06 PK			1.00 H	42	57.48	36.58
5	*5500.00	84.80 AV			1.00 H	42	48.22	36.58
6	11000.00	54.62 PK	74.00	-19.38	1.00 H	57	7.77	46.85
7	11000.00	43.13 AV	54.00	-10.87	1.00 H	57	-3.72	46.85
ANTENNA POLARITY & TEST DISTANCE: VERTICAL AT 3 M								
NO.	FREQ. (MHz)	EMISSION LEVEL (dBuV/m)	LIMIT (dBuV/m)	MARGIN (dB)	ANTENNA HEIGHT (m)	TABLE ANGLE (Degree)	RAW VALUE (dBuV)	CORRECTION FACTOR (dB/m)
1	5458.35	55.06 PK	74.00	-18.94	1.03 V	81	18.53	36.53
2	5458.35	43.34 AV	54.00	-10.66	1.03 V	81	6.81	36.53
3	#5470.00	58.70 PK	68.30	-9.60	1.01 V	81	22.16	36.54
4	*5500.00	103.76 PK			1.01 V	81	67.18	36.58
5	*5500.00	94.54 AV			1.01 V	81	57.96	36.58
6	11000.00	55.69 PK	74.00	-18.31	1.23 V	78	8.84	46.85
7	11000.00	43.59 AV	54.00	-10.41	1.23 V	78	-3.26	46.85

- REMARKS:**
1. Emission level (dBuV/m) = Raw Value (dBuV) + Correction Factor (dB/m).
  2. Correction Factor (dB/m) = Antenna Factor (dB/m) + Cable Factor (dB).
  3. The other emission levels were very low against the limit.
  4. Margin value = Emission level – Limit value.
  5. “ \* “: Fundamental frequency.
  6. “#“: The radiated frequency is out the restricted band.



A D T

EUT TEST CONDITION		MEASUREMENT DETAIL	
CHANNEL	Channel 120	FREQUENCY RANGE	1 ~ 40GHz
INPUT POWER (SYSTEM)	120Vac, 60 Hz	DETECTOR FUNCTION	Peak (PK) Average (AV)
ENVIRONMENTAL CONDITIONS	28.0deg. C, 62.0%RH 965hPa	TESTED BY	Duke Tseng

ANTENNA POLARITY & TEST DISTANCE: HORIZONTAL AT 3 M								
NO.	FREQ. (MHz)	EMISSION LEVEL (dBuV/m)	LIMIT (dBuV/m)	MARGIN (dB)	ANTENNA HEIGHT (m)	TABLE ANGLE (Degree)	RAW VALUE (dBuV)	CORRECTION FACTOR (dB/m)
1	*5600.00	96.43 PK			1.02 H	44	59.67	36.76
2	*5600.00	87.21 AV			1.02 H	44	50.45	36.76
3	11200.00	54.95 PK	74.00	-19.05	1.00 H	53	8.01	46.94
4	11200.00	43.24 AV	54.00	-10.76	1.00 H	53	-3.70	46.94
ANTENNA POLARITY & TEST DISTANCE: VERTICAL AT 3 M								
NO.	FREQ. (MHz)	EMISSION LEVEL (dBuV/m)	LIMIT (dBuV/m)	MARGIN (dB)	ANTENNA HEIGHT (m)	TABLE ANGLE (Degree)	RAW VALUE (dBuV)	CORRECTION FACTOR (dB/m)
1	*5600.00	106.69 PK			1.11 V	78	69.93	36.76
2	*5600.00	97.76 AV			1.11 V	78	61.00	36.76
3	11200.00	55.73 PK	74.00	-18.27	1.17 V	82	8.79	46.94
4	11200.00	43.71 AV	54.00	-10.29	1.17 V	82	-3.23	46.94

- REMARKS:**
1. Emission level (dBuV/m) = Raw Value (dBuV) + Correction Factor (dB/m).
  2. Correction Factor (dB/m) = Antenna Factor (dB/m) + Cable Factor (dB).
  3. The other emission levels were very low against the limit.
  4. Margin value = Emission level – Limit value.
  5. “ \* “: Fundamental frequency.



A D T

EUT TEST CONDITION		MEASUREMENT DETAIL	
CHANNEL	Channel 140	FREQUENCY RANGE	1 ~ 40GHz
INPUT POWER (SYSTEM)	120Vac, 60 Hz	DETECTOR FUNCTION	Peak (PK) Average (AV)
ENVIRONMENTAL CONDITIONS	28.0deg. C, 62.0%RH 965hPa	TESTED BY	Duke Tseng

ANTENNA POLARITY & TEST DISTANCE: HORIZONTAL AT 3 M								
NO.	FREQ. (MHz)	EMISSION LEVEL (dBuV/m)	LIMIT (dBuV/m)	MARGIN (dB)	ANTENNA HEIGHT (m)	TABLE ANGLE (Degree)	RAW VALUE (dBuV)	CORRECTION FACTOR (dB/m)
1	*5700.00	92.27 PK			1.02 H	53	55.30	36.97
2	*5700.00	83.10 AV			1.02 H	53	46.13	36.97
3	#5725.00	54.61 PK	68.30	-13.69	1.02 H	53	17.59	37.02
4	11400.00	55.06 PK	74.00	-18.94	1.00 H	168	8.00	47.06
5	11400.00	43.57 AV	54.00	-10.43	1.00 H	168	-3.49	47.06
ANTENNA POLARITY & TEST DISTANCE: VERTICAL AT 3 M								
NO.	FREQ. (MHz)	EMISSION LEVEL (dBuV/m)	LIMIT (dBuV/m)	MARGIN (dB)	ANTENNA HEIGHT (m)	TABLE ANGLE (Degree)	RAW VALUE (dBuV)	CORRECTION FACTOR (dB/m)
1	*5700.00	103.47 PK			1.00 V	76	66.50	36.97
2	*5700.00	94.38 AV			1.00 V	76	57.41	36.97
3	#5725.00	61.71 PK	68.30	-6.59	1.00 V	78	24.70	37.02
4	11400.00	57.30 PK	74.00	-16.70	1.18 V	83	10.24	47.06
5	11400.00	45.07 AV	54.00	-8.93	1.18 V	83	-1.99	47.06

- REMARKS:**
1. Emission level (dBuV/m) = Raw Value (dBuV) + Correction Factor (dB/m).
  2. Correction Factor (dB/m) = Antenna Factor (dB/m) + Cable Factor (dB).
  3. The other emission levels were very low against the limit.
  4. Margin value = Emission level – Limit value.
  5. “ \* “: Fundamental frequency.
  6. “#“: The radiated frequency is out the restricted band.



A D T

### RESTRICTED BANDEDGE (802.11a MODE, CH36, HORIZONTAL)

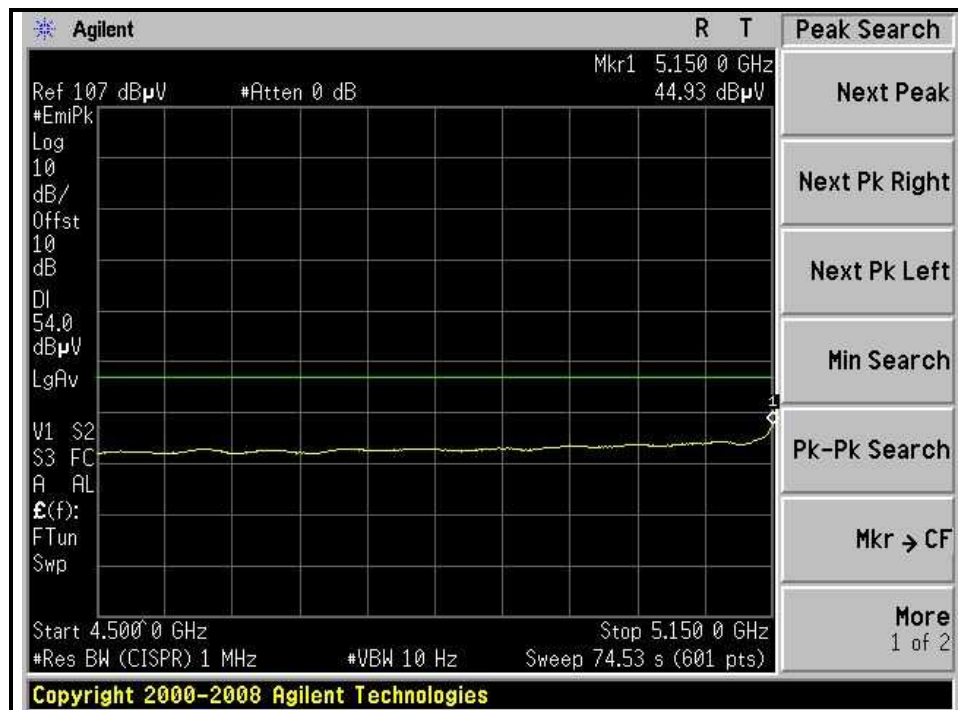
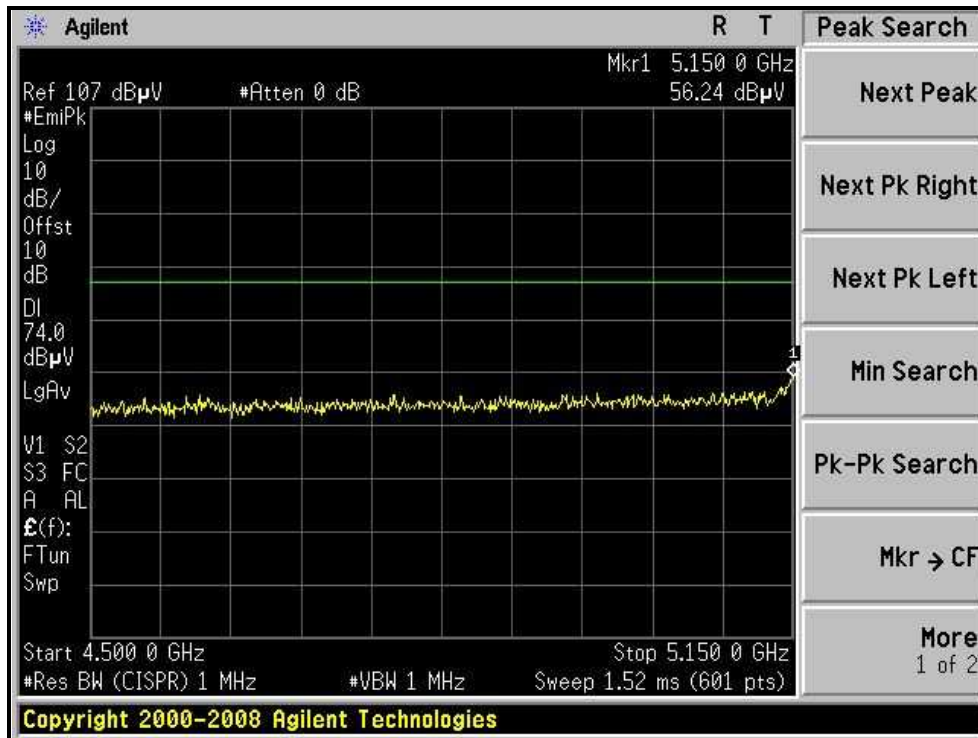



A D T

RESTRICTED BANDEDGE (802.11a MODE, CH36, VERTICAL)

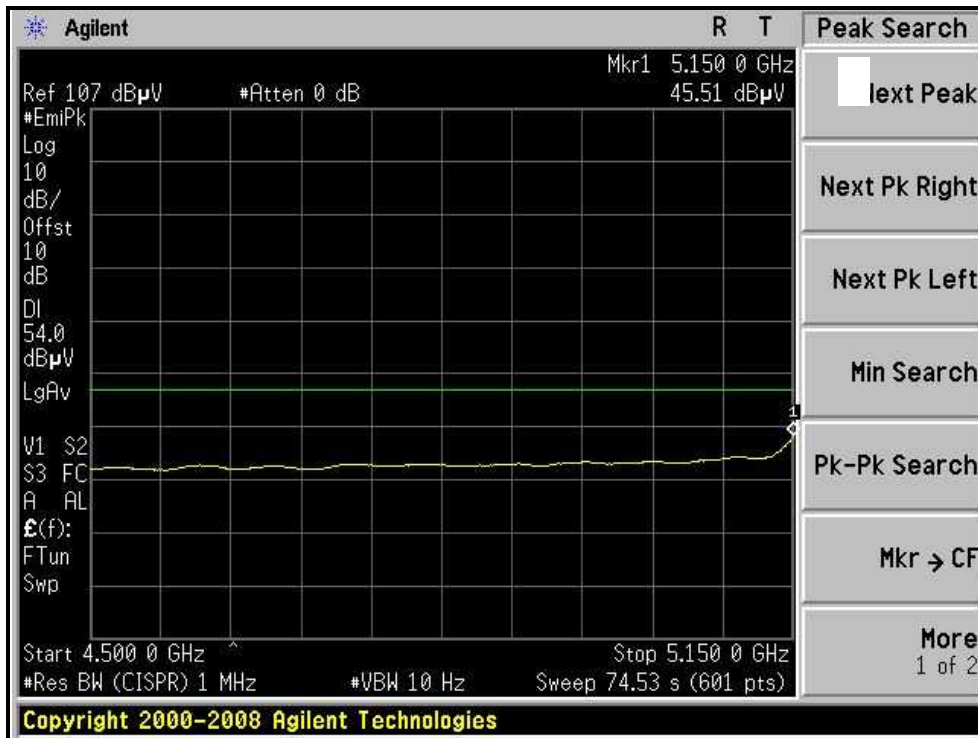
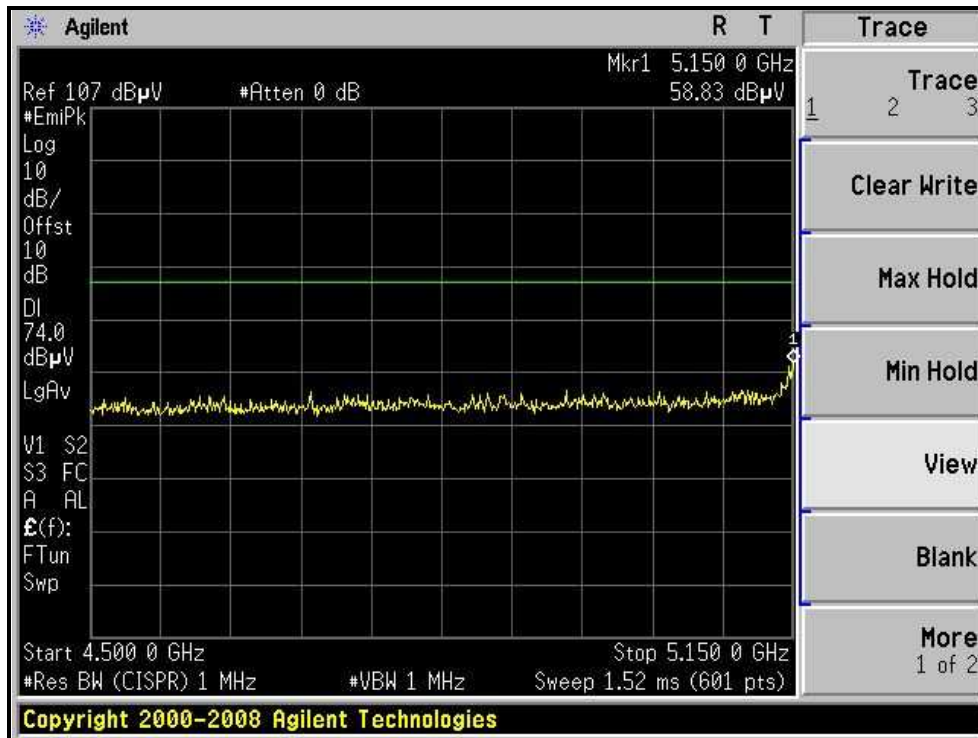



A D T

RESTRICTED BANDEDGE (802.11a MODE, CH64, HORIZONTAL)

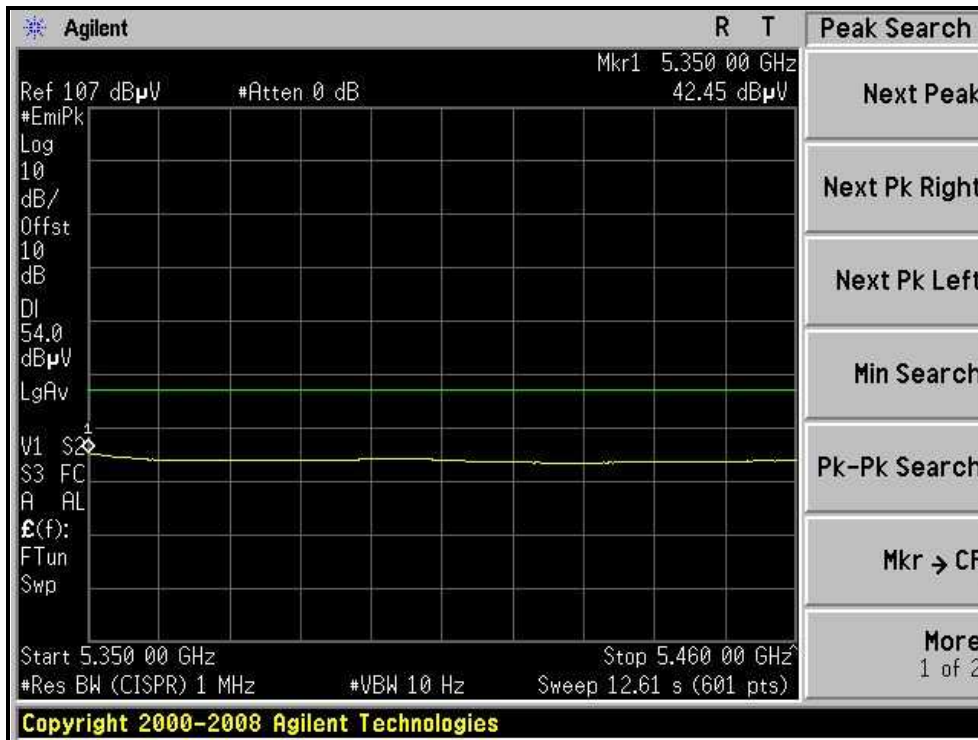
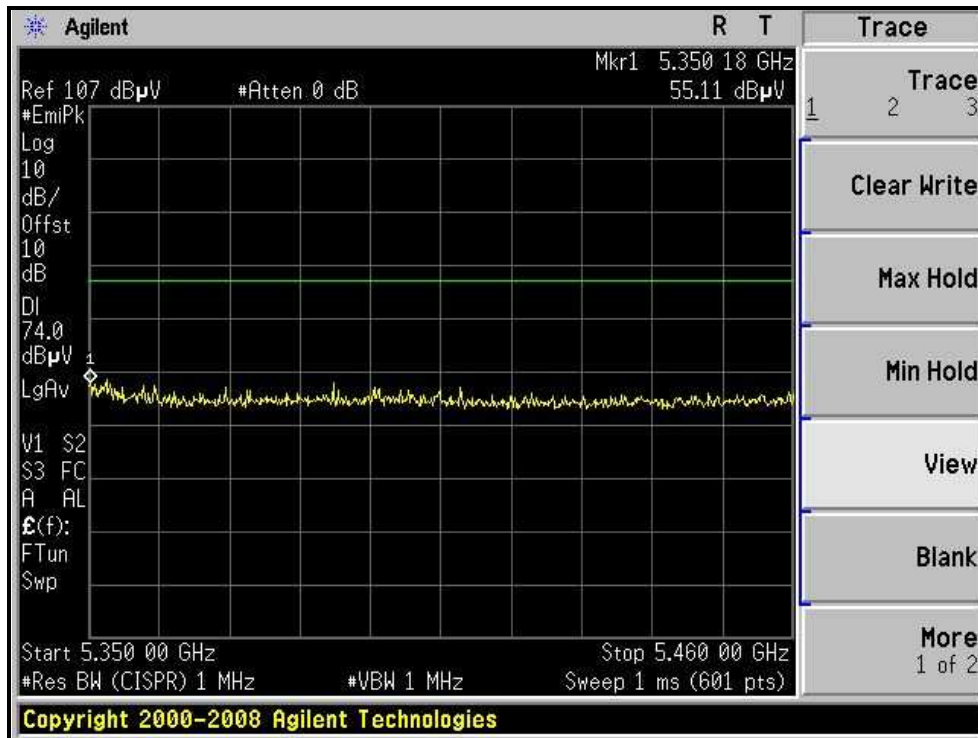



A D T

RESTRICTED BANDEDGE (802.11a MODE, CH64, VERTICAL)

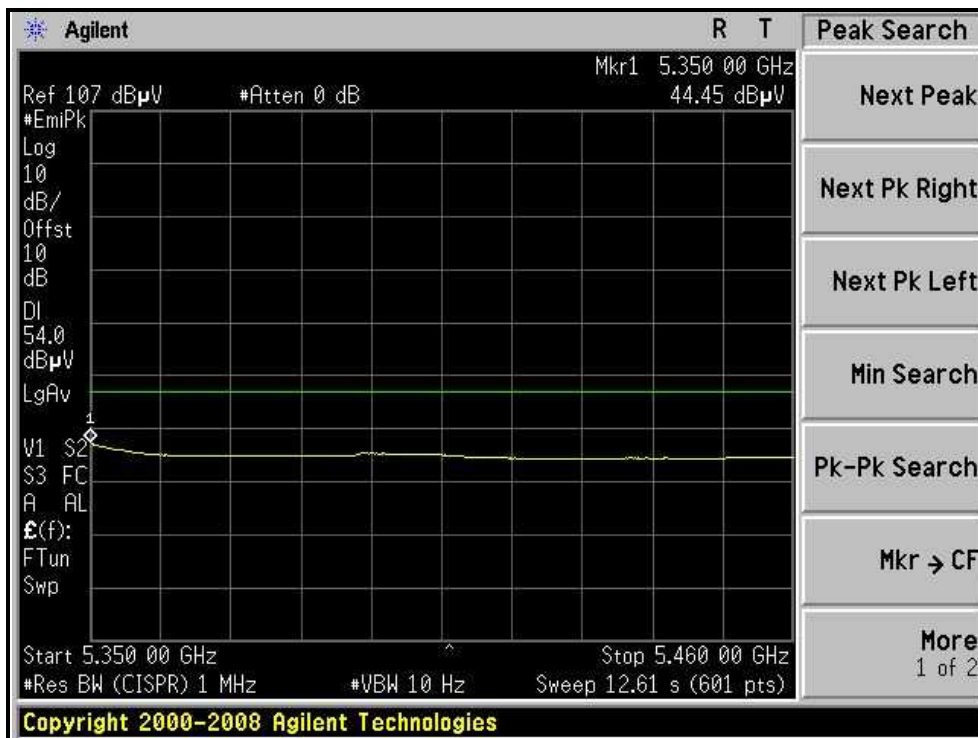
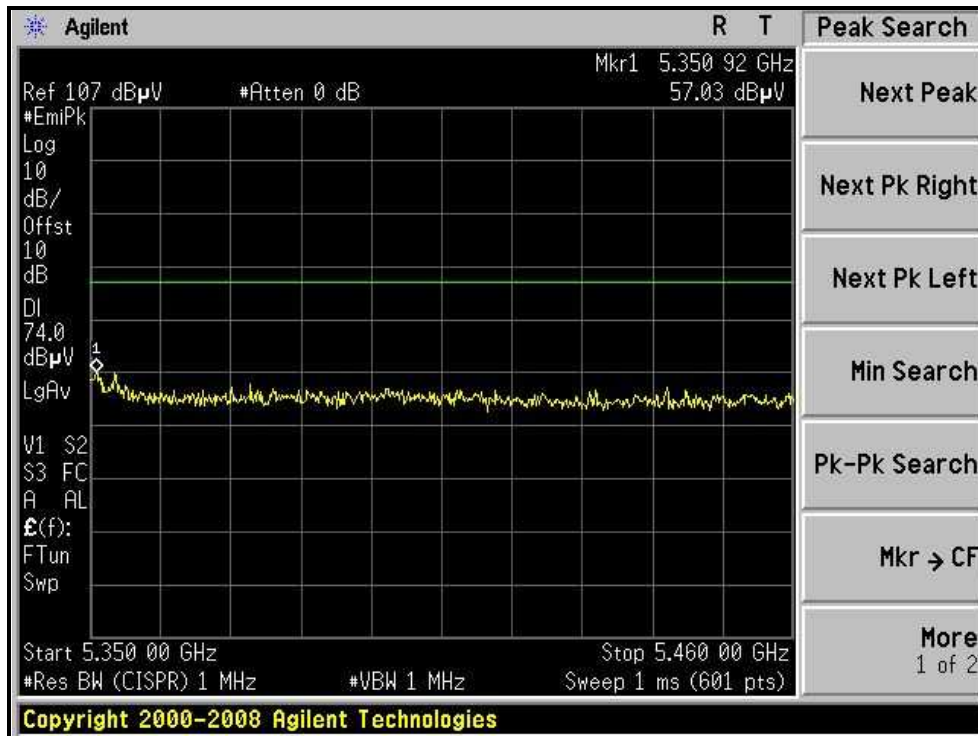





A D T

RESTRICTED BANDEDGE (802.11a MODE, CH100, HORIZONTAL)

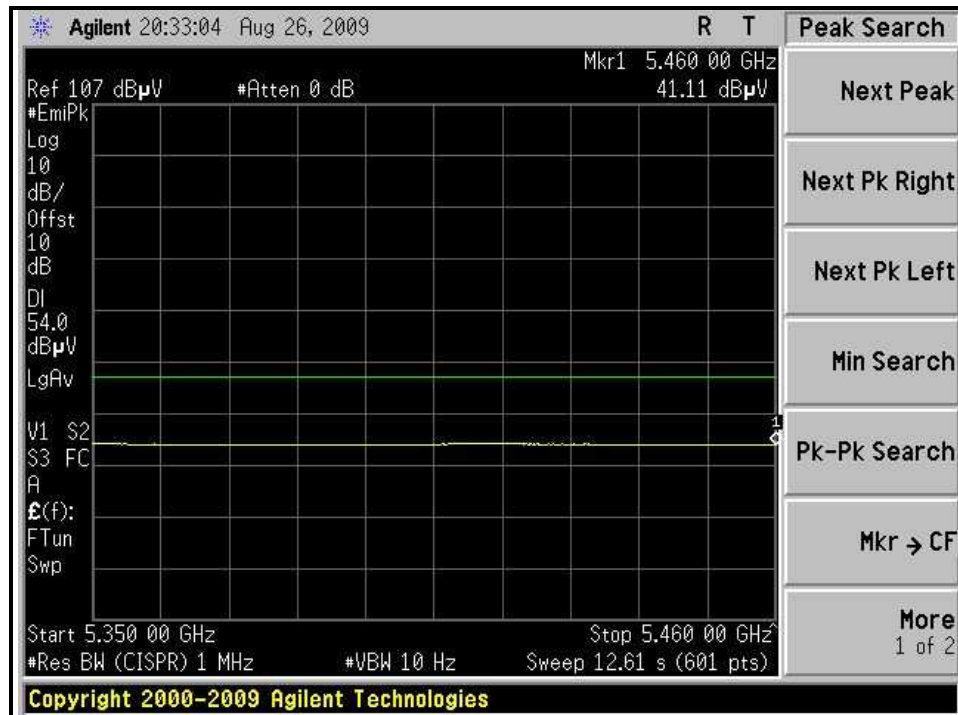
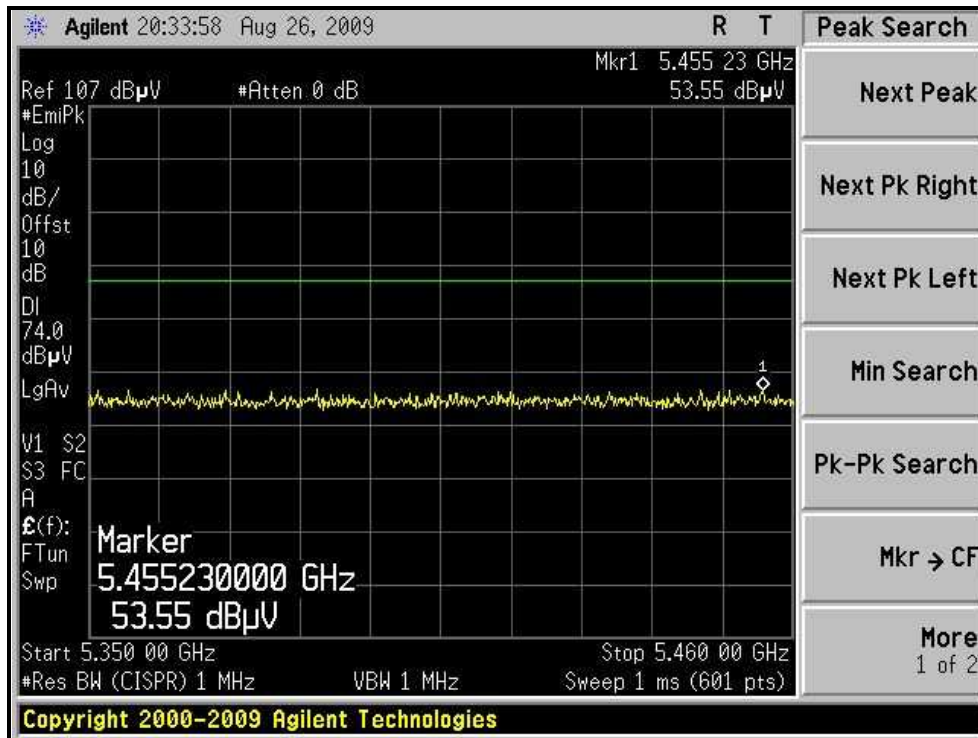



A D T

RESTRICTED BANDEDGE (802.11a MODE, CH100, VERTICAL)

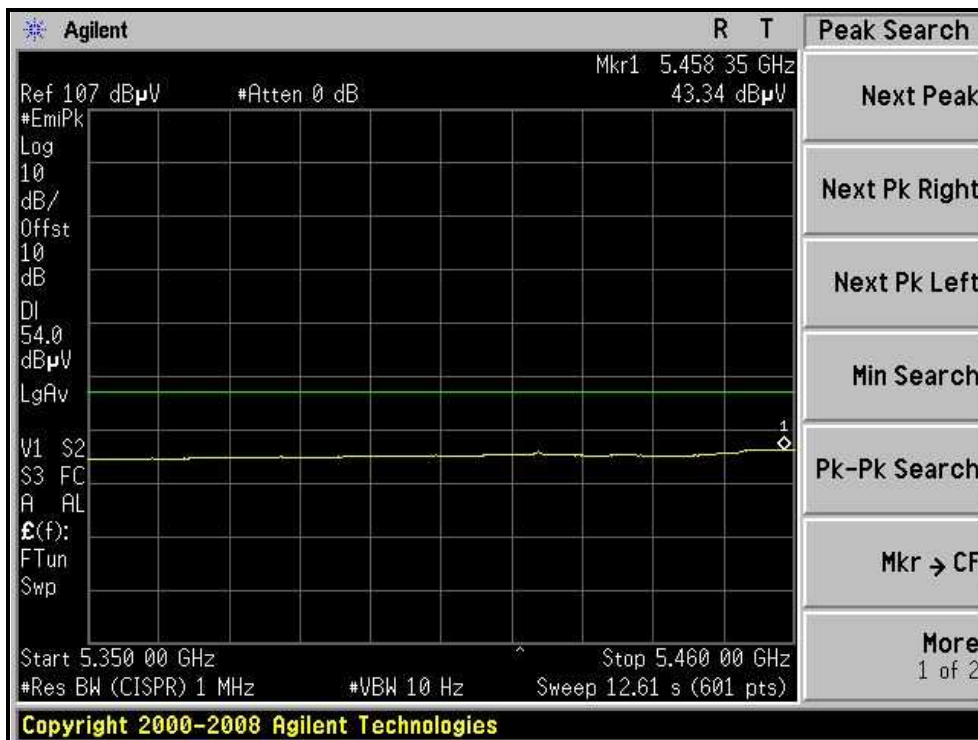
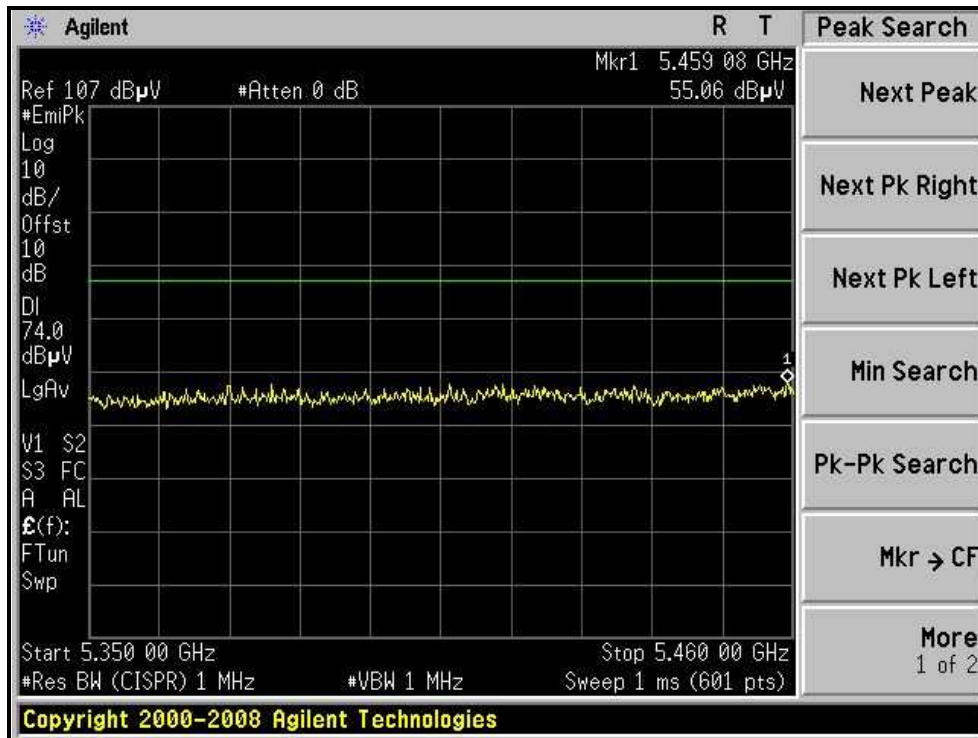

### 4.3 PEAK TRANSMIT POWER MEASUREMENT

#### 4.3.1 LIMITS OF PEAK TRANSMIT POWER MEASUREMENT

Frequency Band	Limit
5.15 – 5.25GHz	The lesser of 50mW (17dBm) or 4dBm + 10logB
5.25 – 5.35GHz	The lesser of 250mW (24dBm) or 11dBm + 10logB
5.47 – 5.725GHz	The lesser of 250mW (24dBm) or 11dBm + 10logB
5.725 – 5.825GHz	The lesser of 1W (30dBm) or 17dBm + 10logB

**NOTE:** Where B is the 26dB emission bandwidth in MHz.

#### 4.3.2 TEST INSTRUMENTS

DESCRIPTION & MANUFACTURER	MODEL NO.	SERIAL NO.	CALIBRATED DATE	CALIBRATED UNTIL
ADVANTEST SPECTRUM ANALYZER	U3772	160100280	Aug. 03, 2009	Aug. 02, 2010

**NOTE:**

1. The calibration interval of the above test instruments is 12 months and the calibrations are traceable to NML/ROC and NIST/USA.

#### 4.3.3 TEST PROCEDURE

1. The transmitter output was connected to the spectrum analyzer.
2. Set span to encompass the entire emission bandwidth of the signal.
3. Set RBW to 1MHz, VBW to 300kHz.
4. Using the spectrum analyzer's channel power measurement function to measure the output power.

**NOTE:**

The test is performed in accordance with FCC Public Notice: APPENDIX A Guidelines for Assessing Unlicensed National Information Infrastructure (U-NII) Devices – Part 15, Subpart E, August 2002.

The transmitter output operates continuously therefore Method # 1 is used.

#### 4.3.4 DEVIATION FROM TEST STANDARD

No deviation

#### 4.3.5 TEST SETUP

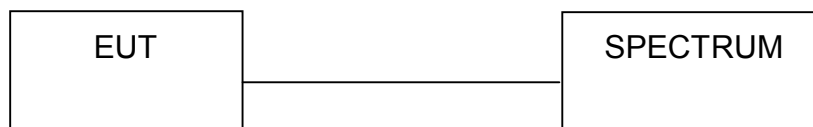

#### 4.3.6 EUT OPERATING CONDITIONS

The software provided by client to enable the EUT under transmission condition continuously at specific channel frequencies individually.



A D T

### 4.3.7 TEST RESULTS

#### 802.11a OFDM MODULATION:

<b>MODULATION TYPE</b>	BPSK	<b>TRANSFER RATE</b>	6Mbps
<b>INPUT POWER (SYSTEM)</b>	120Vac, 60 Hz	<b>ENVIRONMENTAL CONDITIONS</b>	25deg.C, 60%RH, 965hPa
<b>TESTED BY</b>	Rex Huang		

CHANNEL	CHANNEL FREQUENCY (MHz)	PEAK POWER OUTPUT (dBm)	PEAK POWER OUTPUT (mW)	PEAK POWER LIMIT (dBm)	26dBc Occupied Bandwidth (MHz)	PASS/FAIL
36	5180	12.52	17.865	17	20.67	PASS
40	5200	12.47	17.660	17	20.5	PASS
48	5240	12.62	18.281	17	20.5	PASS
52	5260	14.55	28.510	24	23.33	PASS
60	5300	11.62	14.521	24	20.5	PASS
64	5320	11.65	14.622	24	20.58	PASS
100	5500	11.57	14.355	24	20.42	PASS
120	5600	13.50	22.387	24	22.92	PASS
140	5700	8.31	6.776	24	20.33	PASS

**NOTE:** The 26dBc Occupied Bandwidth plot, please refer to the following pages.



A D T

### Peak Power Output: CH36

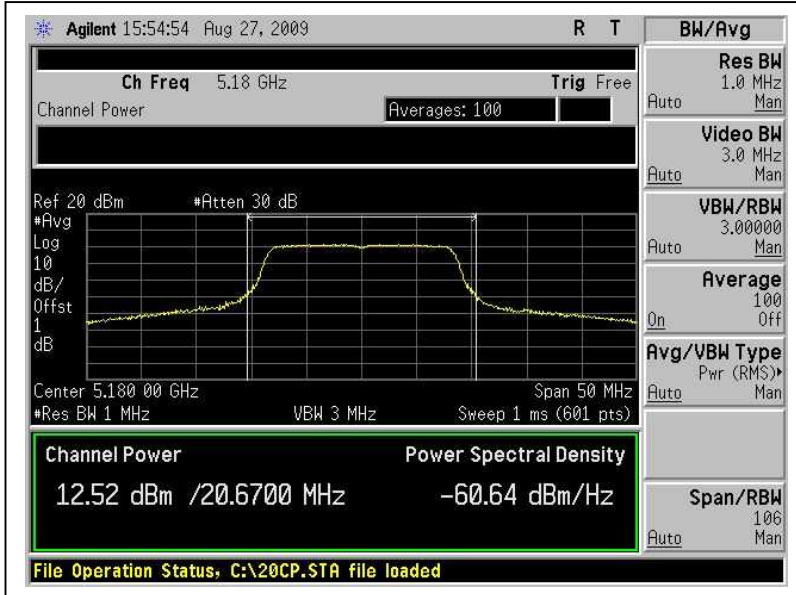

### CH40

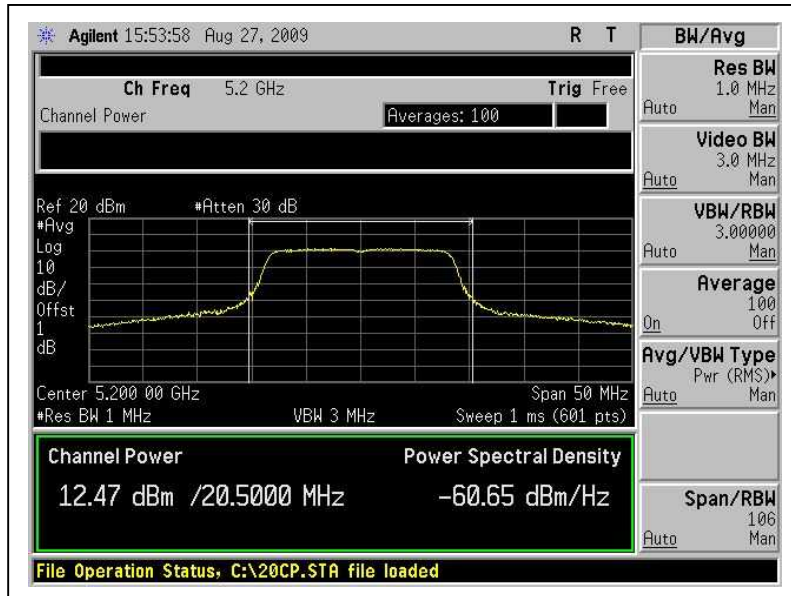



A D T

### CH48

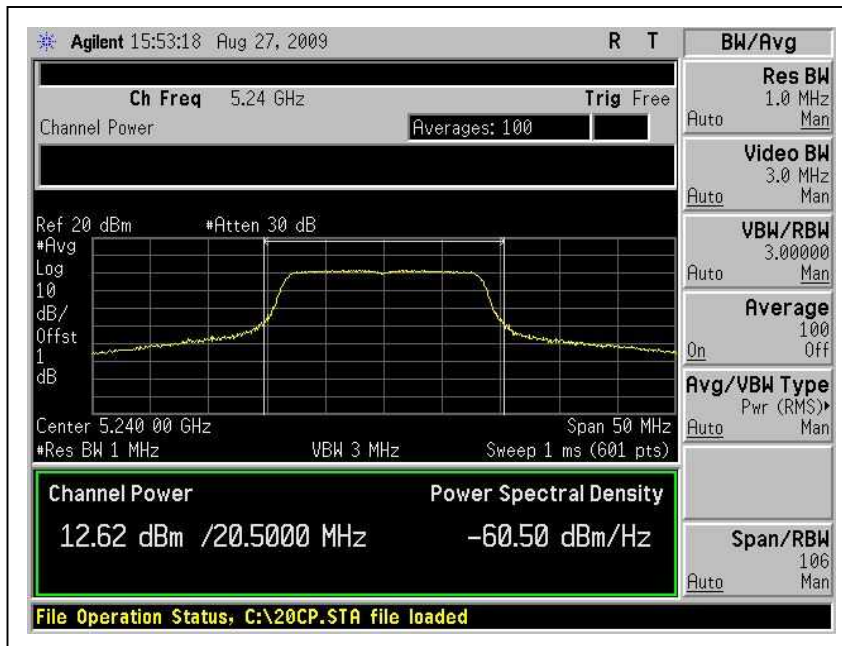

### CH52

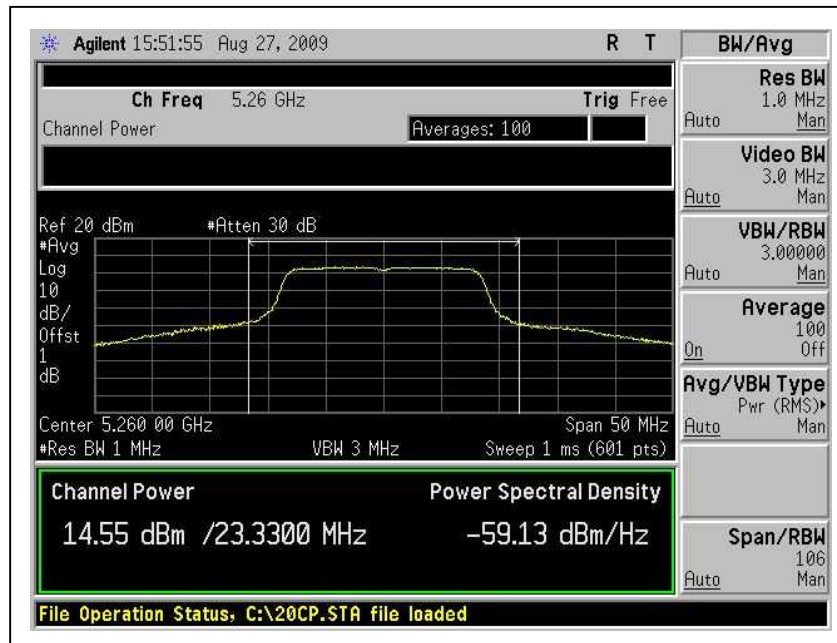



A D T

### CH60

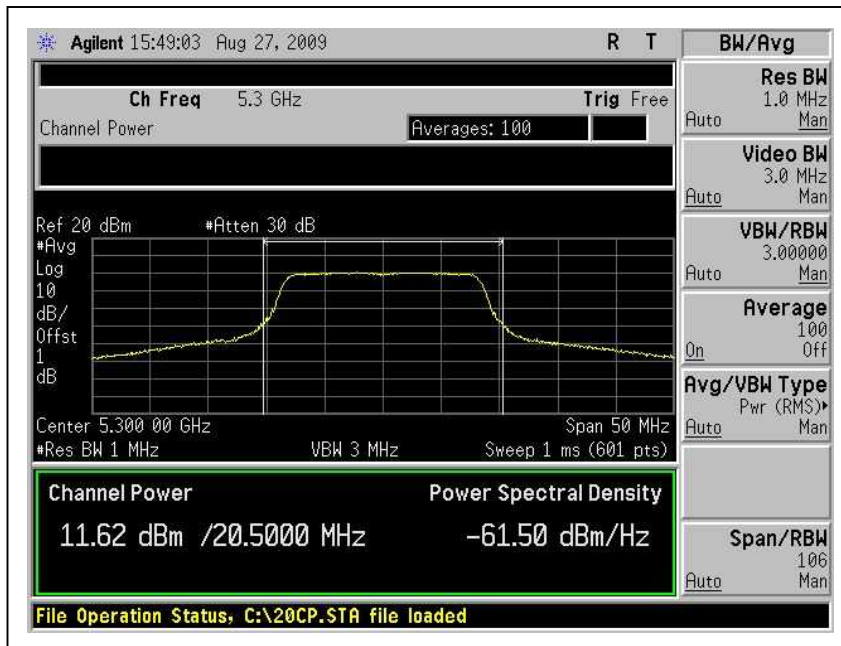

### CH64

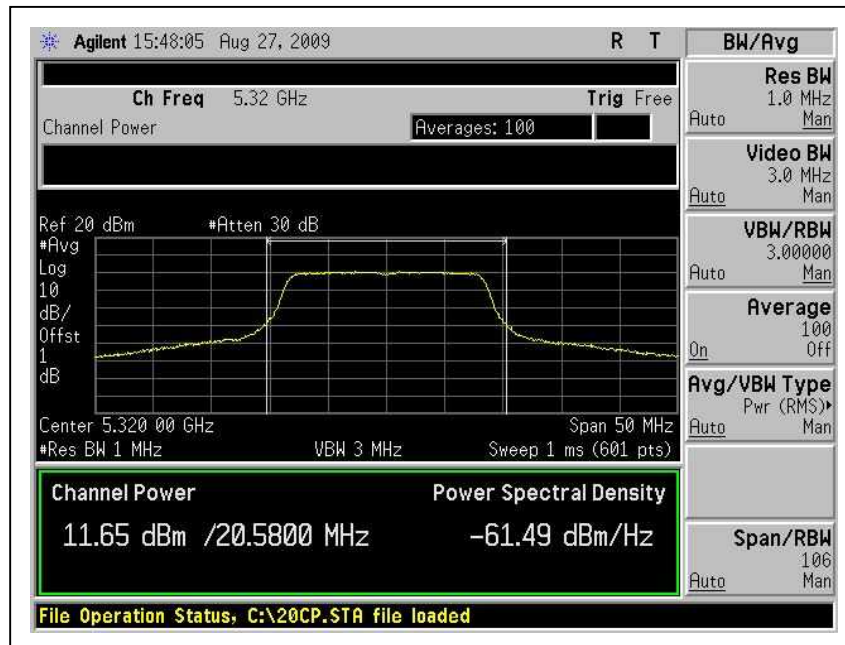





A D T

### CH100

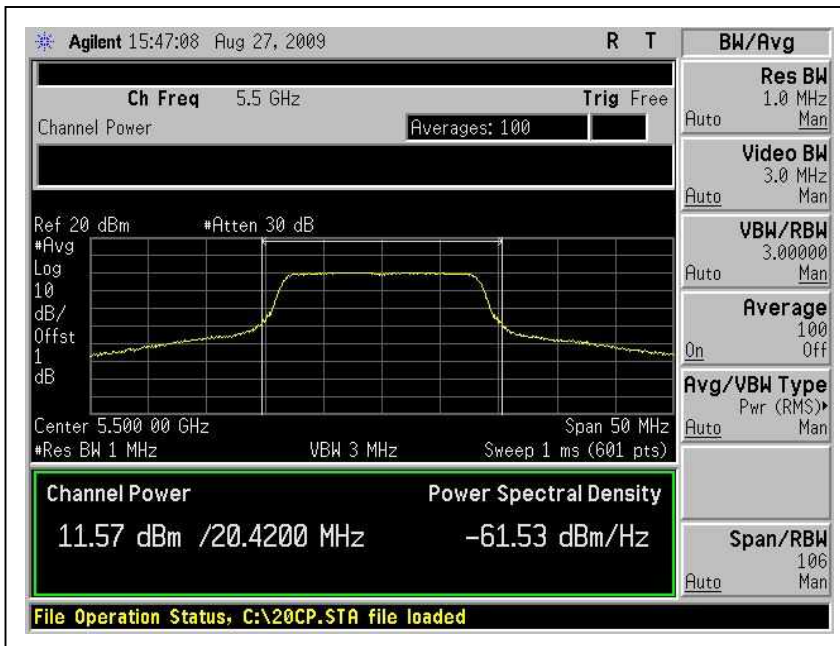

### CH120

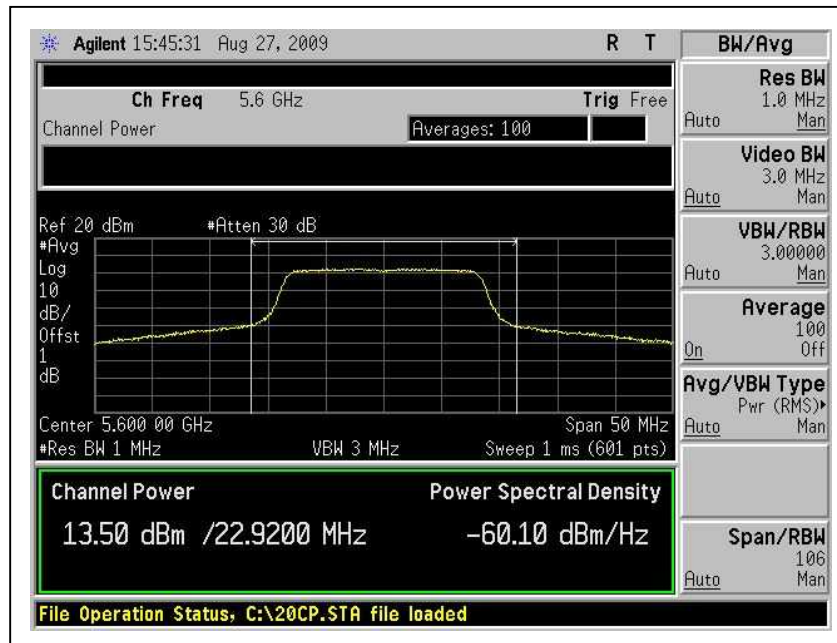



A D T

# CH140

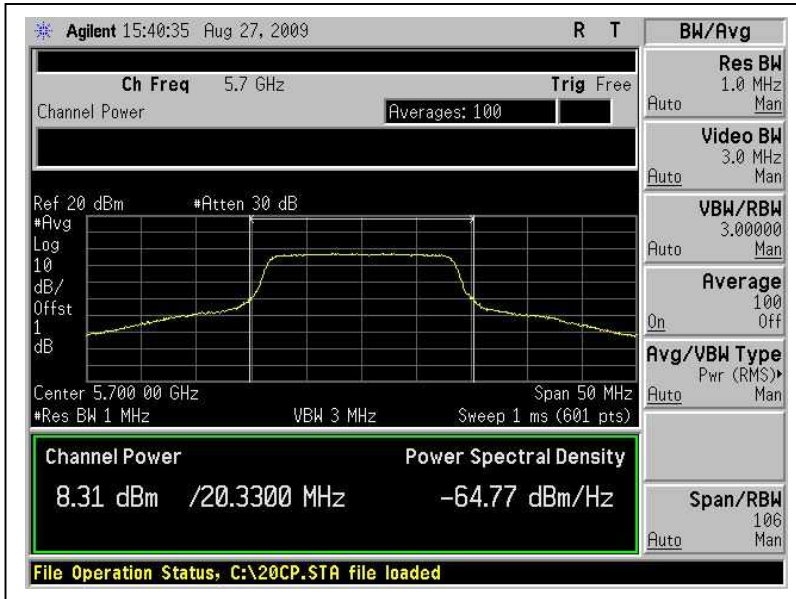

### 26dB Occupied Bandwidth: CH36

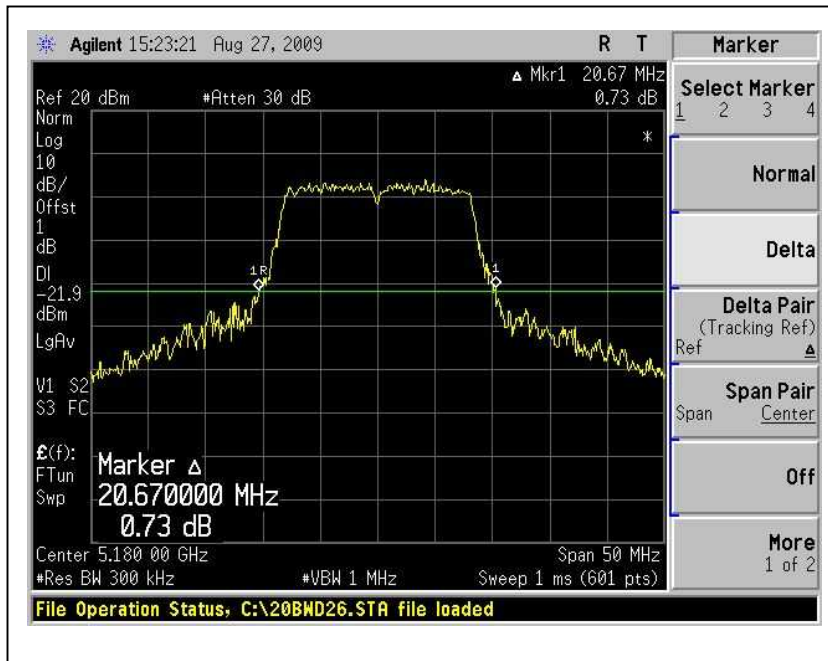

### CH40

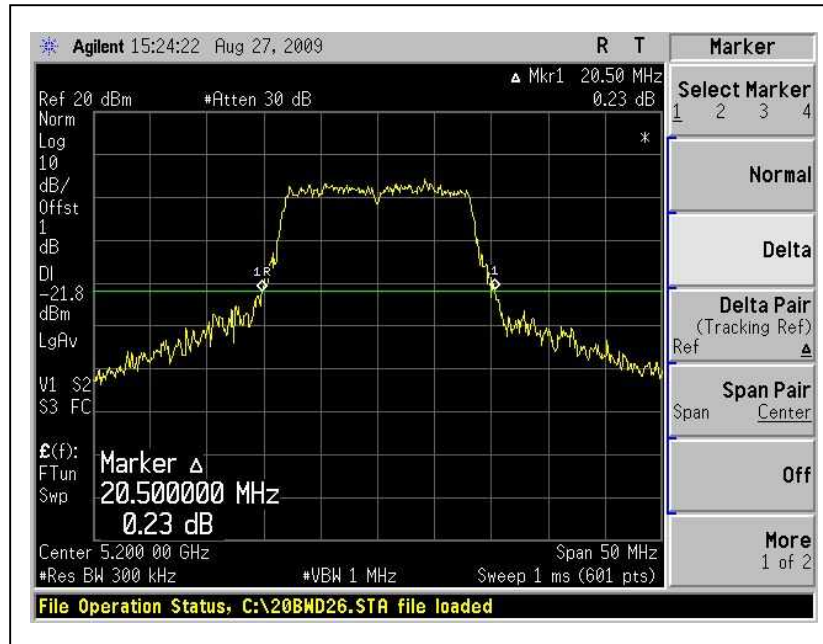



A D T

### CH48

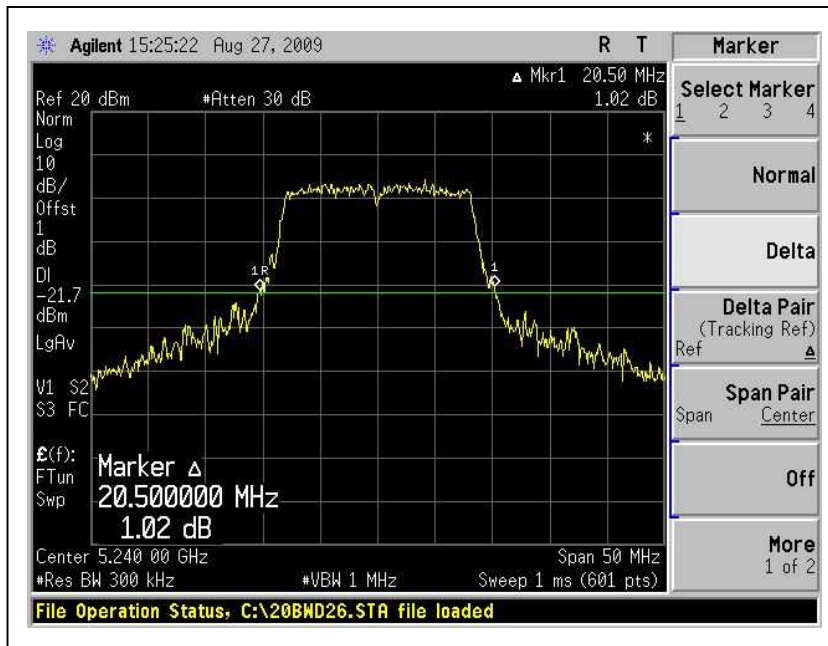

### CH52

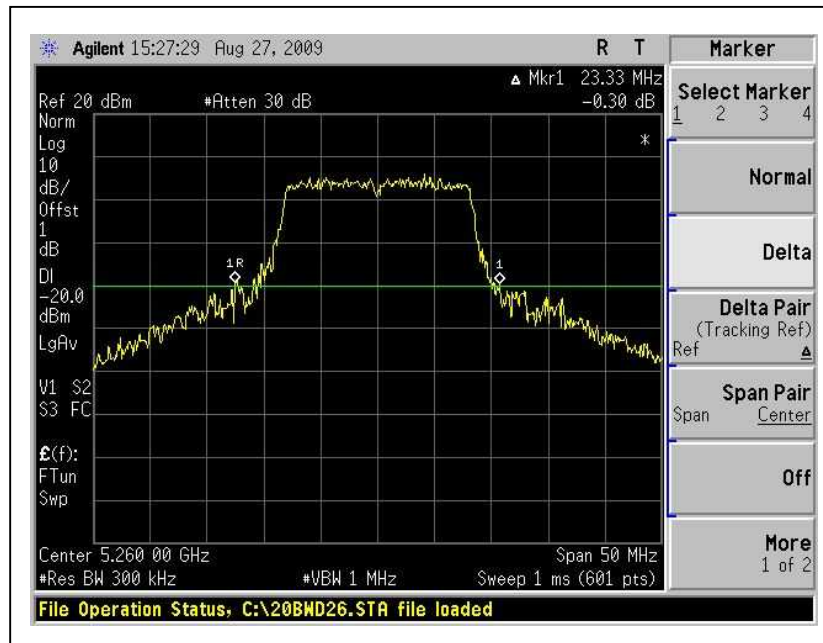



A D T

### CH60

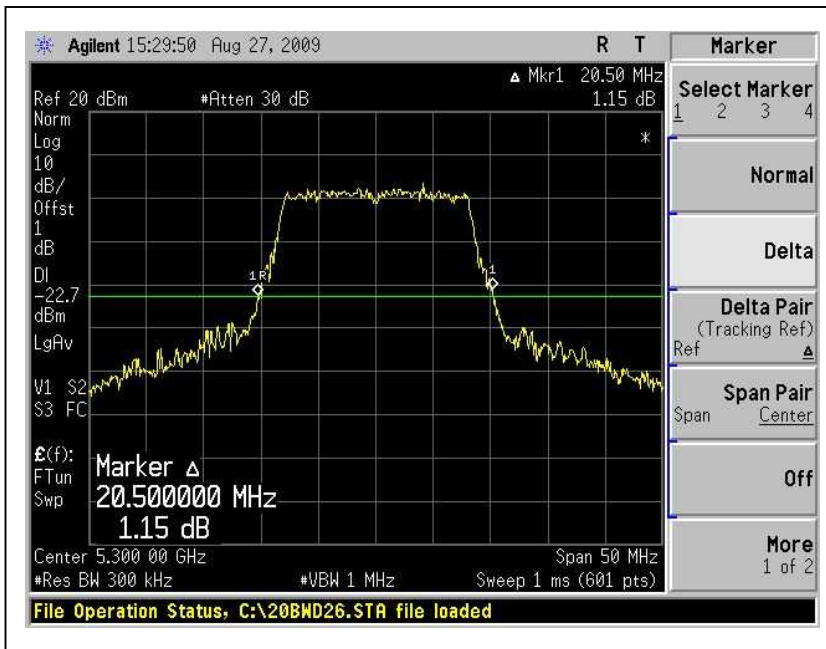

### CH64

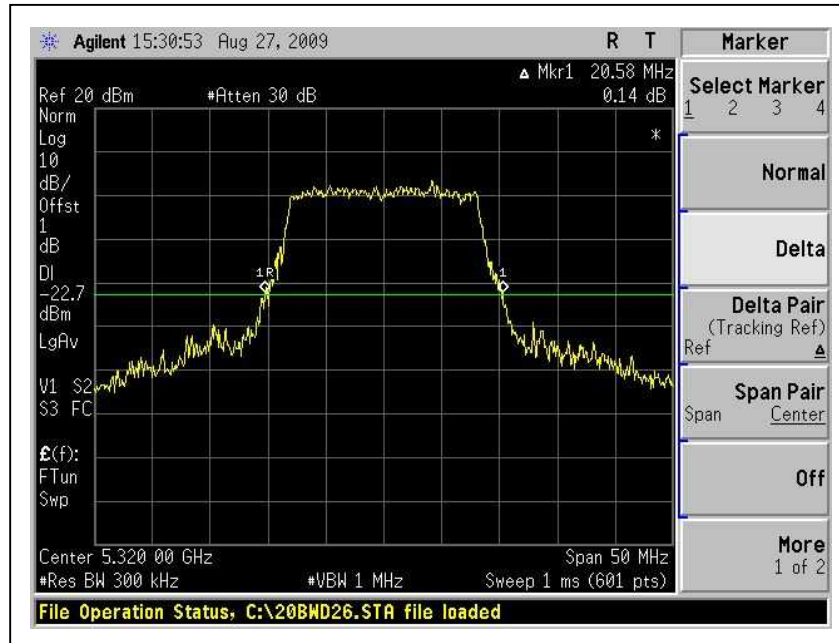



A D T

### CH100

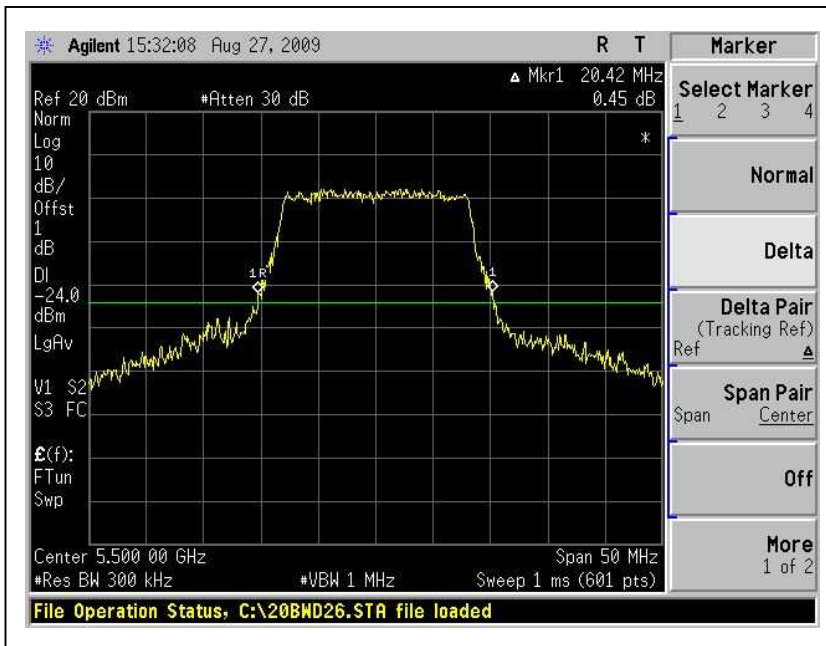

### CH120

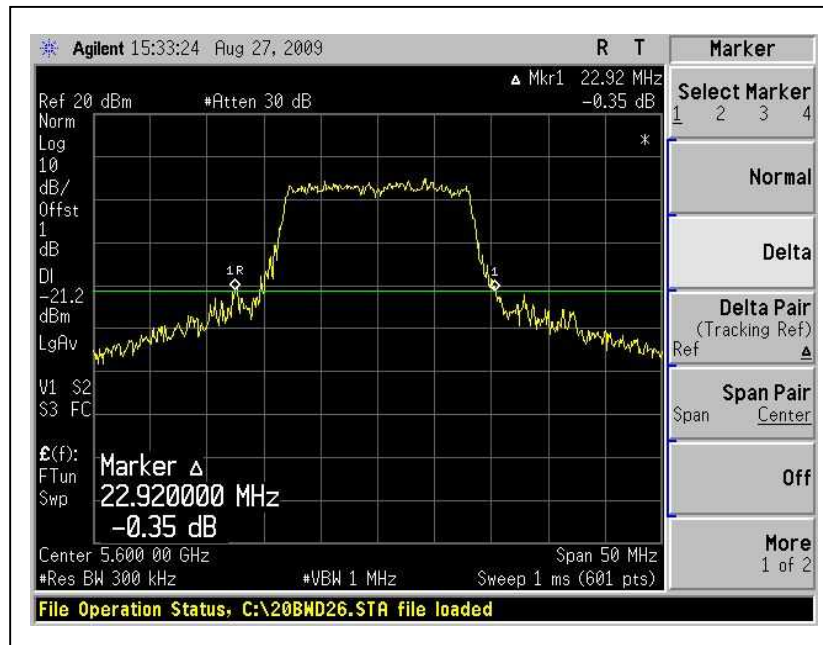



A D T

# CH140

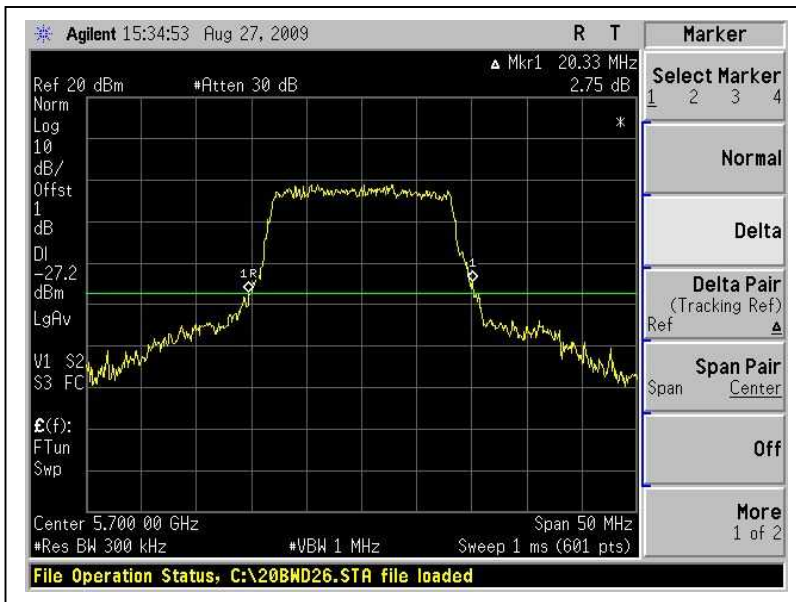



A D T

#### 4.4 PEAK POWER EXCURSION MEASUREMENT

##### 4.4.1 LIMITS OF PEAK POWER EXCURSION MEASUREMENT

Frequency Band	Limit
5.15 – 5.25 GHz	13dB
5.25 – 5.35 GHz	13dB
5.47 – 5.725GHz	13dB
5.725 – 5.825 GHz	13dB

##### 4.4.2 TEST INSTRUMENTS

DESCRIPTION & MANUFACTURER	MODEL NO.	SERIAL NO.	CALIBRATED DATE	CALIBRATED UNTIL
R&S SPECTRUM ANALYZER	FSP40	100037	Aug. 03, 2009	Aug. 02, 2010

**NOTE:**

- 1.The calibration interval of the above test instruments is 12 months and the calibrations are traceable to NML/ROC and NIST/USA.



#### 4.4.3 TEST PROCEDURE

1. The transmitter output was connected to the spectrum analyzer.
2. Set the spectrum bandwidth span to view the entire spectrum.
3. Using peak detector and Max-hold function for Trace 1 (RB=1MHz, VB=3MHz) and 2 (RB=1MHz, VB=300KHz).
4. The largest difference between Trace 1 and Trace 2 in any 1MHz band on any frequency was recorded.

#### 4.4.4 DEVIATION FROM TEST STANDARD

No deviation

#### 4.4.5 TEST SETUP

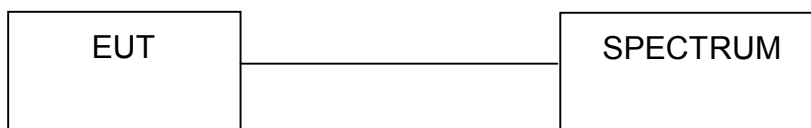

#### 4.4.6 EUT OPERATING CONDITIONS

The software provided by client to enable the EUT under transmission condition continuously at specific channel frequencies individually.



A D T

4.4.7 TEST RESULTS  
**802.11a OFDM modulation**

<b>MODULATION TYPE</b>	BPSK	<b>TRANSFER RATE</b>	6Mbps
<b>INPUT POWER (SYSTEM)</b>	120Vac, 60 Hz	<b>ENVIRONMENTAL CONDITIONS</b>	25deg.C, 60%RH, 965hPa
<b>TESTED BY</b>	Rex Huang		

CHANNEL	CHANNEL FREQUENCY (MHz)	PEAK POWER EXCURSION (dB)	PEAK to AVERAGE EXCURSION LIMIT (dB)	PASS/FAIL
36	5180	8.00	13	PASS
40	5200	8.09	13	PASS
48	5240	8.02	13	PASS
52	5260	8.09	13	PASS
60	5300	7.98	13	PASS
64	5320	8.37	13	PASS
100	5500	8.18	13	PASS
120	5600	7.91	13	PASS
140	5700	8.31	13	PASS

CH36

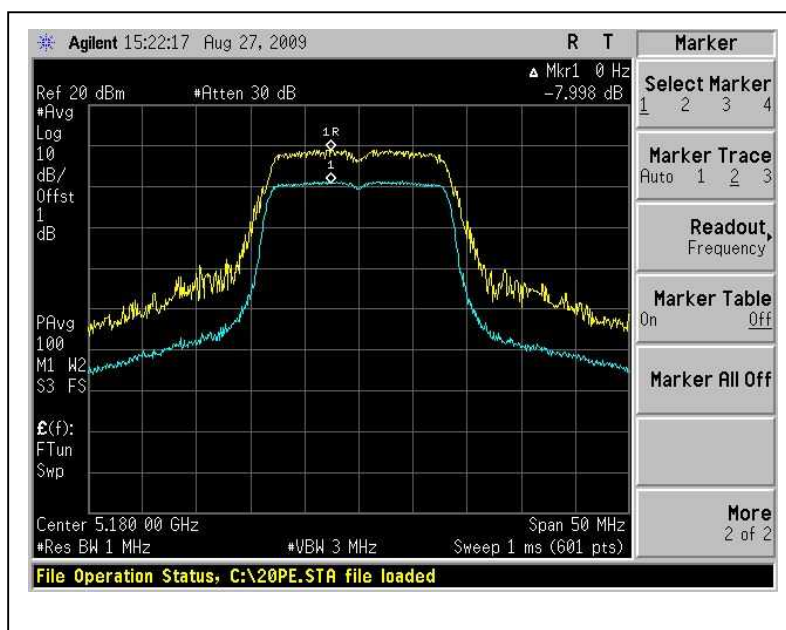

CH40

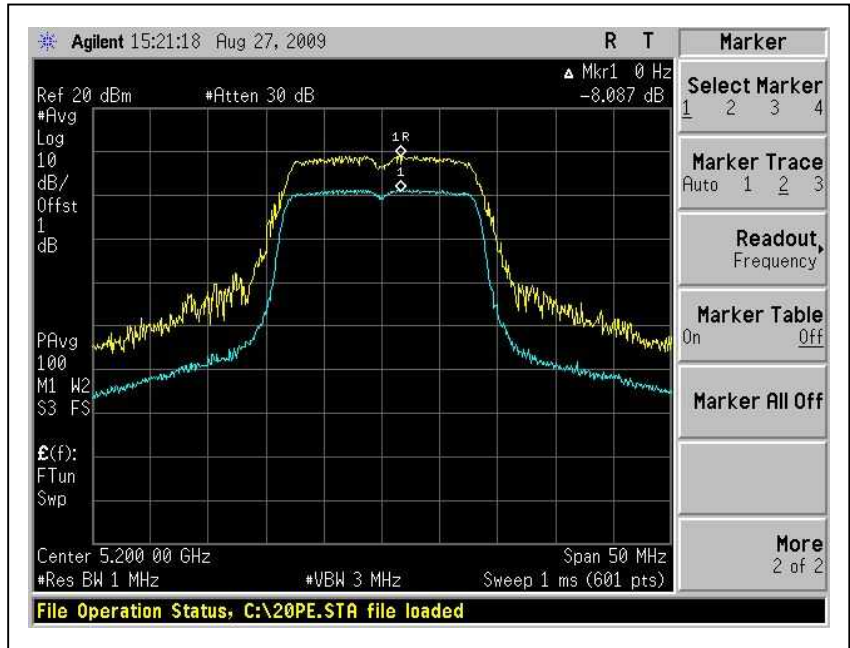

CH48

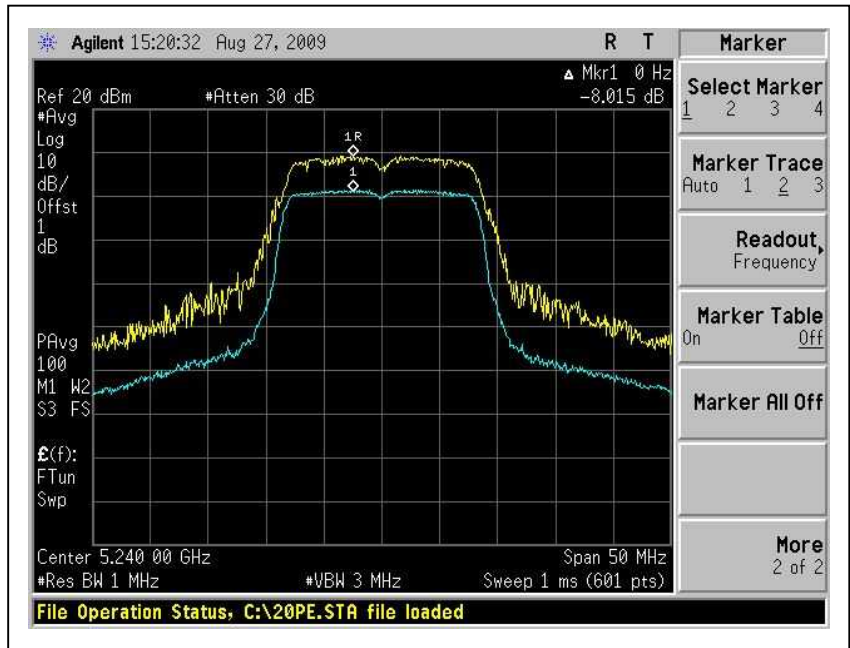



A D T

### CH52

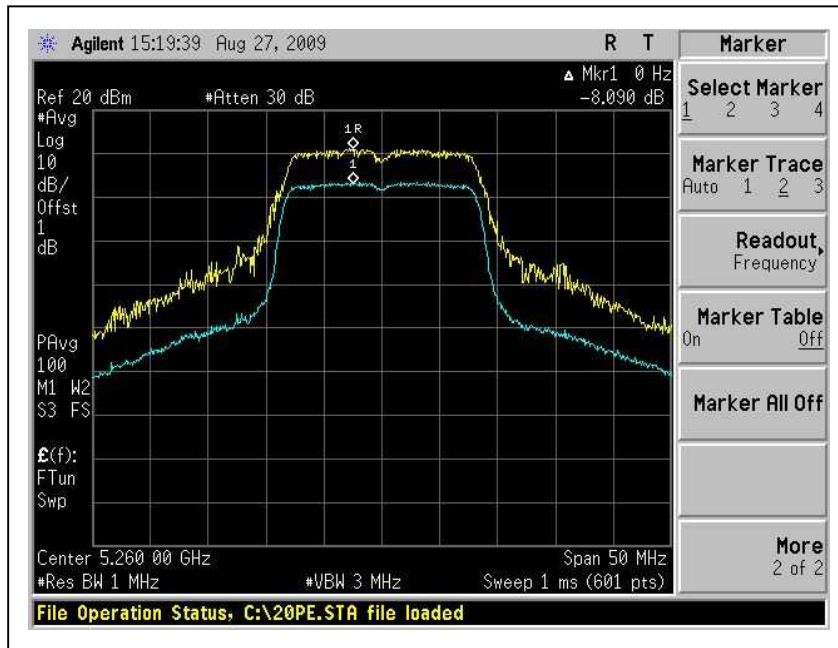

### CH60

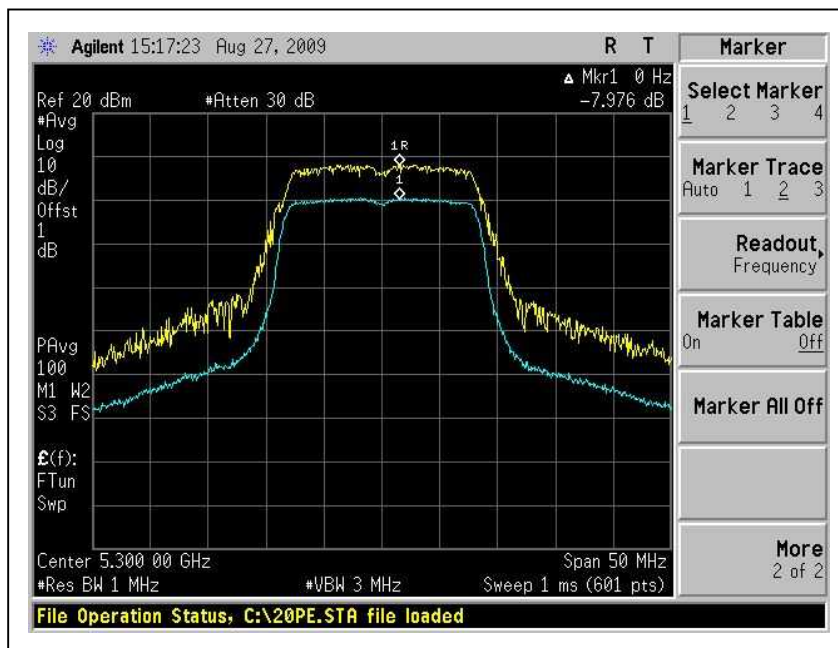



A D T

### CH64

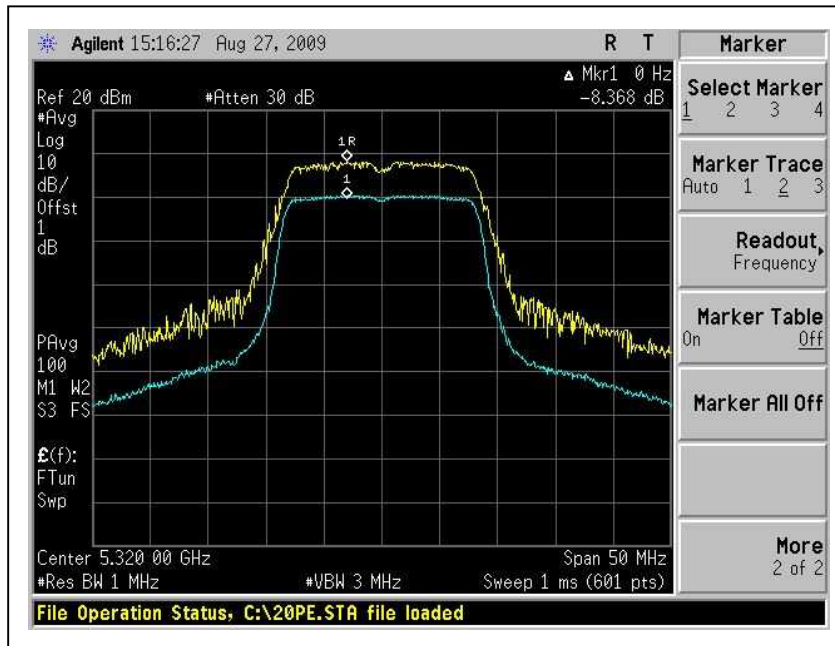

### CH100

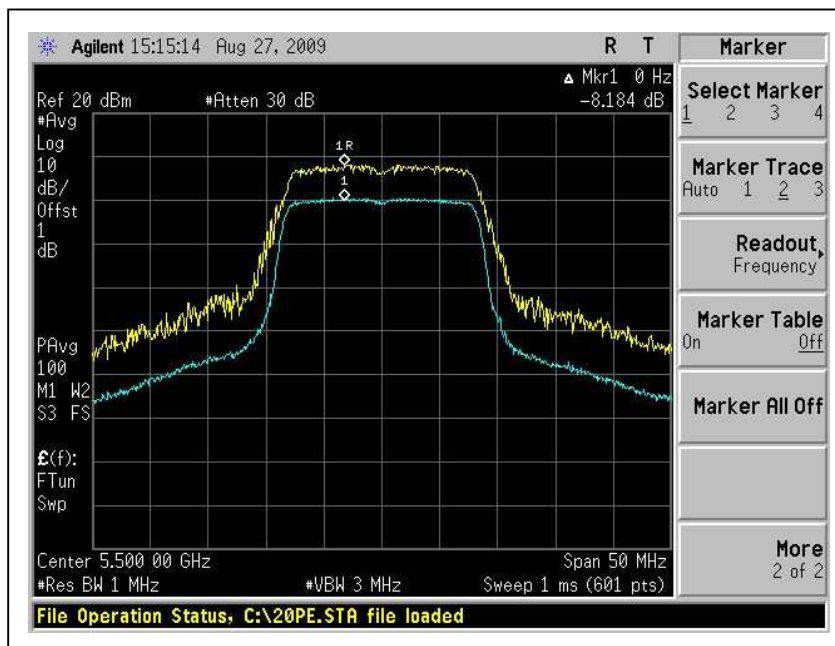



A D T

### CH120

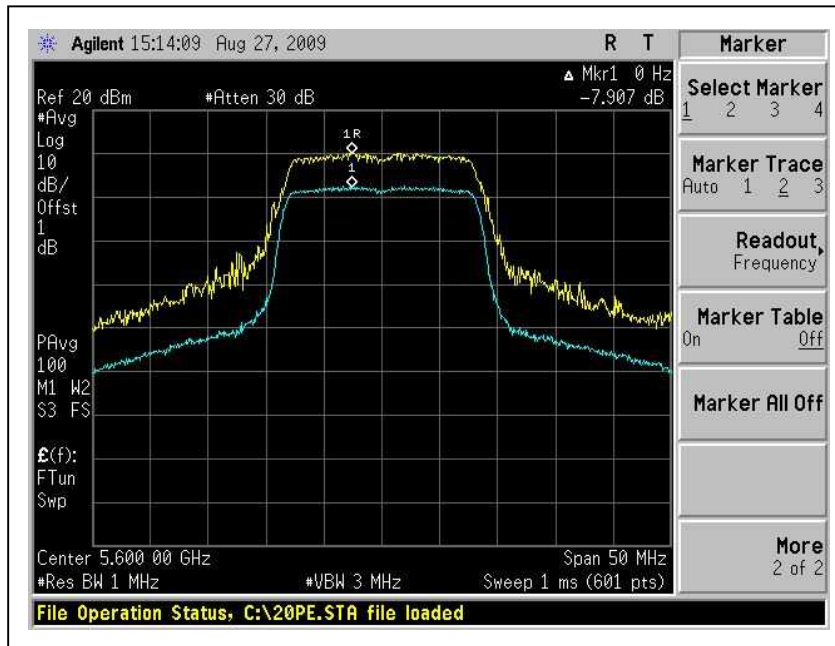

### CH140

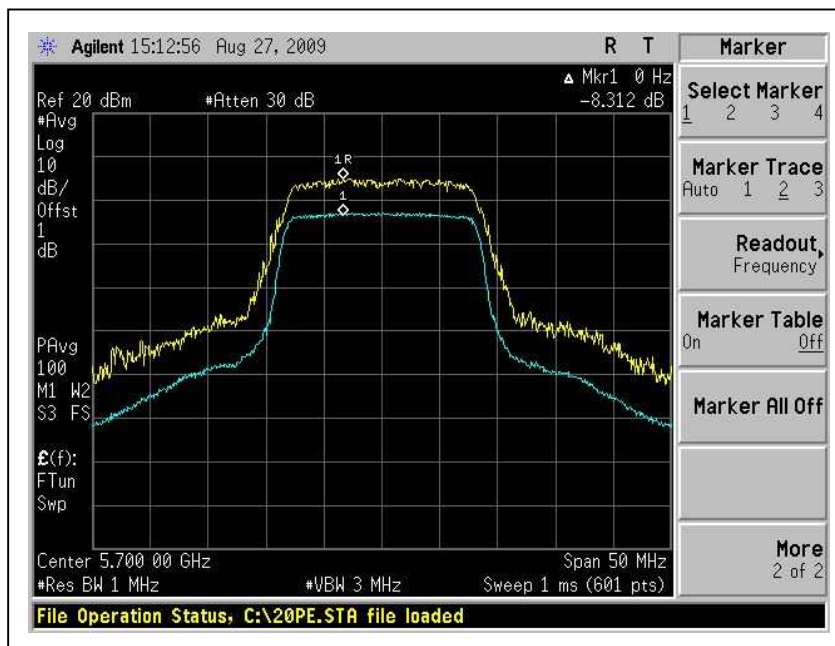



A D T

## 4.5 PEAK POWER SPECTRAL DENSITY MEASUREMENT

### 4.5.1 LIMITS OF PEAK POWER SPECTRAL DENSITY MEASUREMENT

Frequency Band	Limit
5.15 ~ 5.25GHz	4dBm
5.25 ~ 5.35GHz	11dBm
5.47 – 5.725GHz	11dBm
5.725 ~ 5.825GHz	17dBm

### 4.5.2 TEST INSTRUMENTS

DESCRIPTION & MANUFACTURER	MODEL NO.	SERIAL NO.	CALIBRATED DATE	CALIBRATED UNTIL
R&S SPECTRUM ANALYZER	FSP40	100037	Aug. 03, 2009	Aug. 02, 2010

**NOTE:**

- 1.The calibration interval of the above test instruments is 12 months and the calibrations are traceable to NML/ROC and NIST/USA.

#### 4.5.3 TEST PROCEDURES

1. The transmitter output was connected to the spectrum analyzer.
2. Set RBW=1MHz, VBW=3MHz. The PPSD is the highest level found across the emission in any 1MHz band.

#### 4.5.4 DEVIATION FROM TEST STANDARD

No deviation

#### 4.5.5 TEST SETUP



#### 4.5.6 EUT OPERATING CONDITIONS

Same as 4.3.6





A D T

#### 4.5.7 TEST RESULTS

##### 802.11a OFDM modulation

<b>MODULATION TYPE</b>	BPSK	<b>TRANSFER RATE</b>	6Mbps
<b>INPUT POWER (SYSTEM)</b>	120Vac, 60 Hz	<b>ENVIRONMENTAL CONDITIONS</b>	25deg.C, 60%RH, 965hPa
<b>TESTED BY</b>	Rex Huang		

<b>CHANNEL</b>	<b>CHANNEL FREQUENCY (MHz )</b>	<b>RF POWER LEVEL IN 1MHz BW (dBm)</b>	<b>MAXIMUM LIMIT (dBm)</b>	<b>PASS/FAIL</b>
36	5180	2.02	4	PASS
40	5200	1.43	4	PASS
48	5240	1.66	4	PASS
52	5260	3.58	11	PASS
60	5300	0.68	11	PASS
64	5320	0.64	11	PASS
100	5500	0.5	11	PASS
120	5600	2.3	11	PASS
140	5700	-2.8	11	PASS



A D T

### CH36

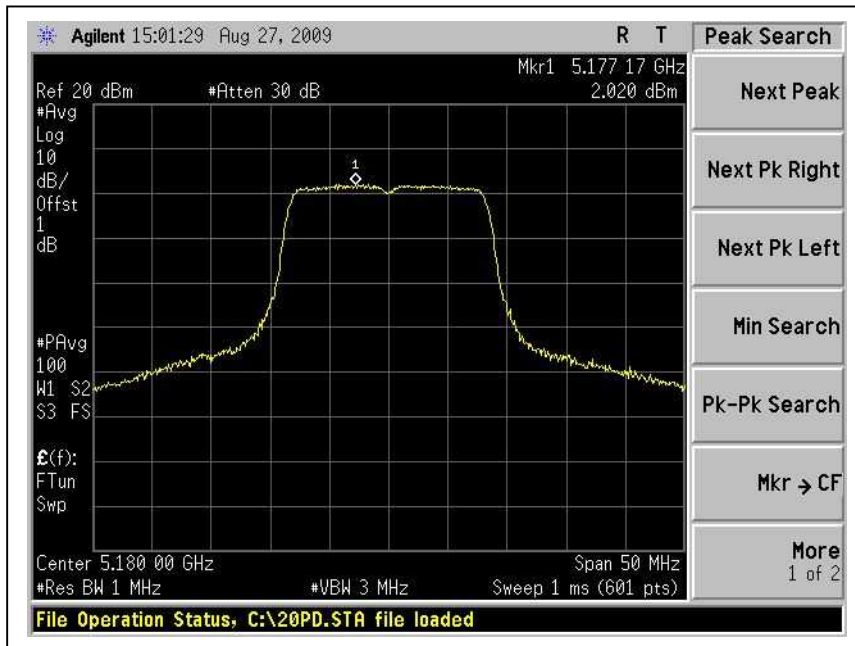

### CH40

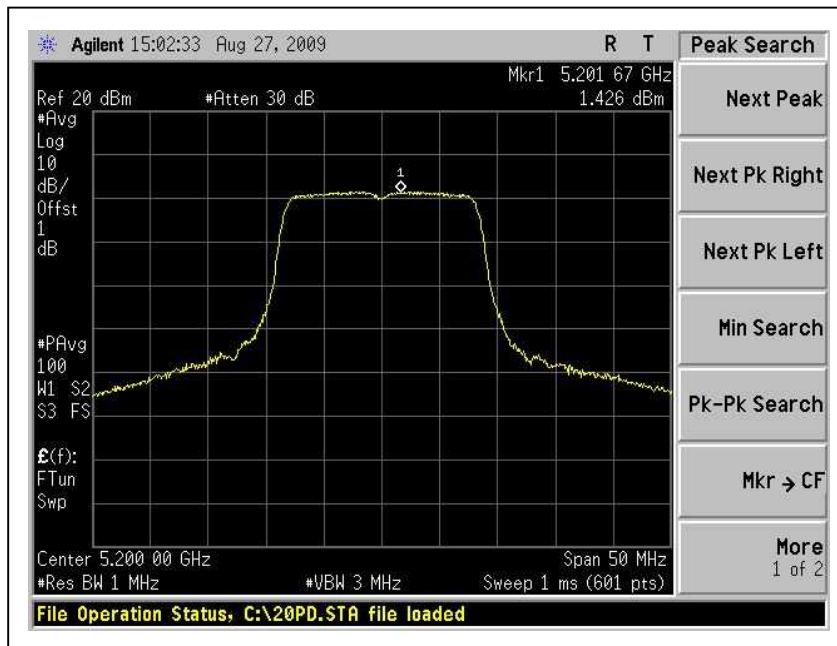



A D T

### CH48

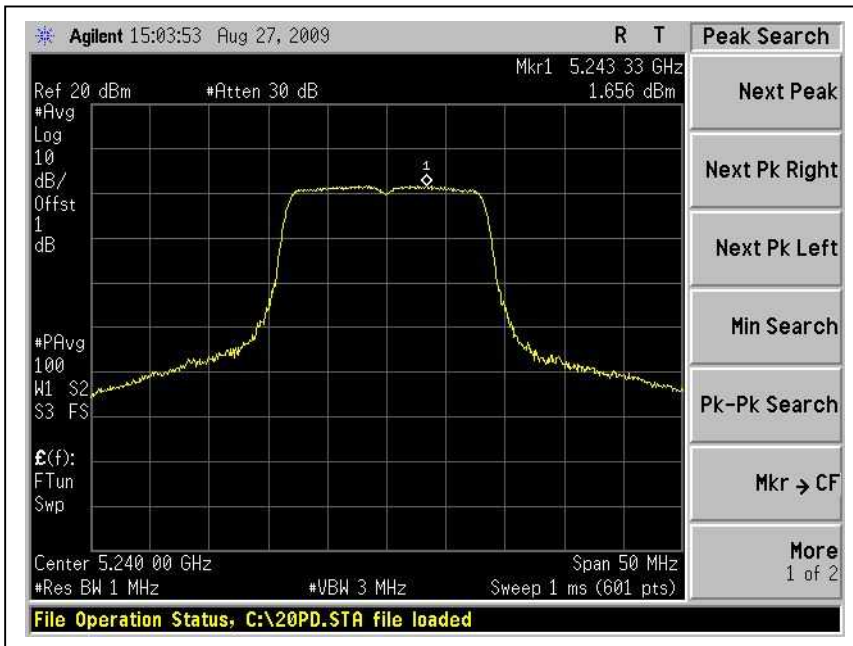

### CH52

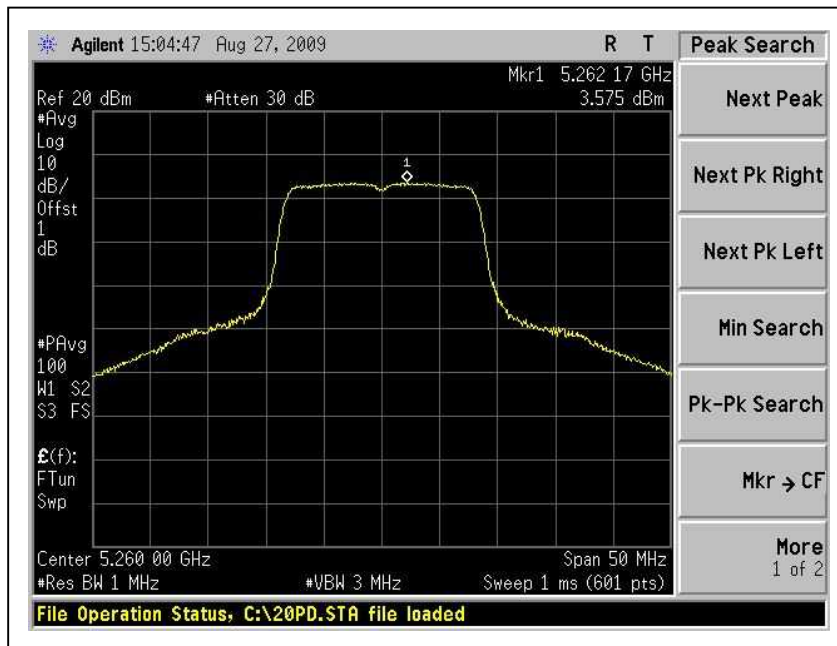



A D T

### CH60

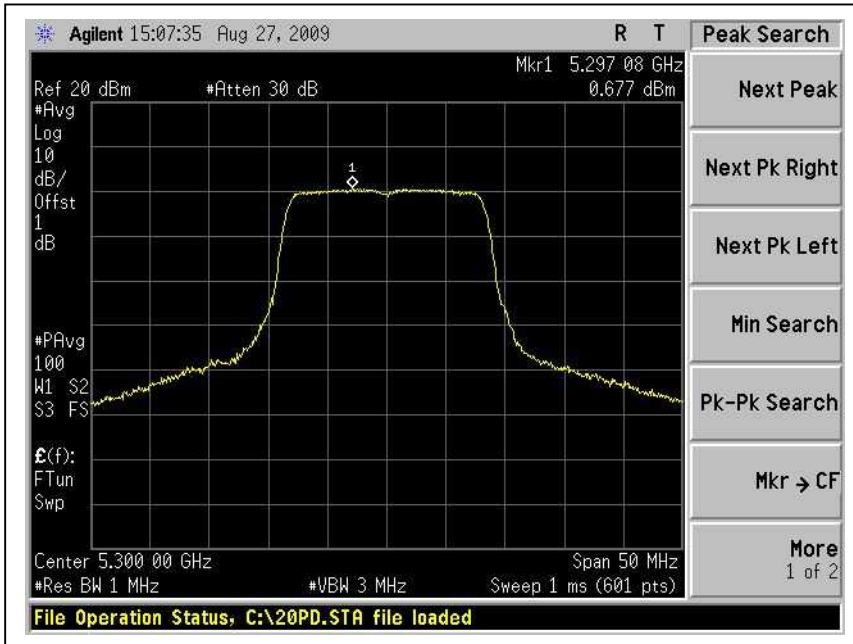

### CH64

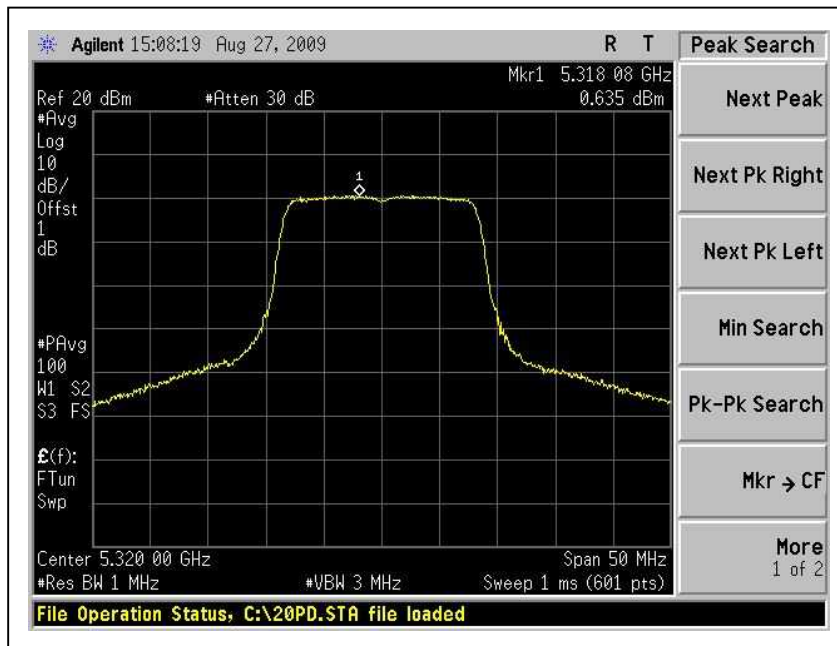



A D T

### CH100

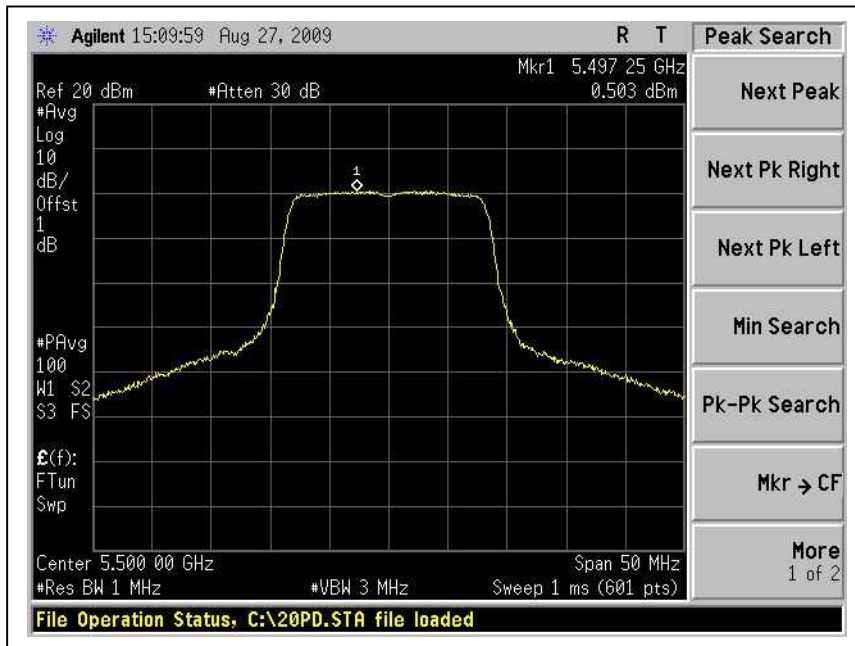

### CH120

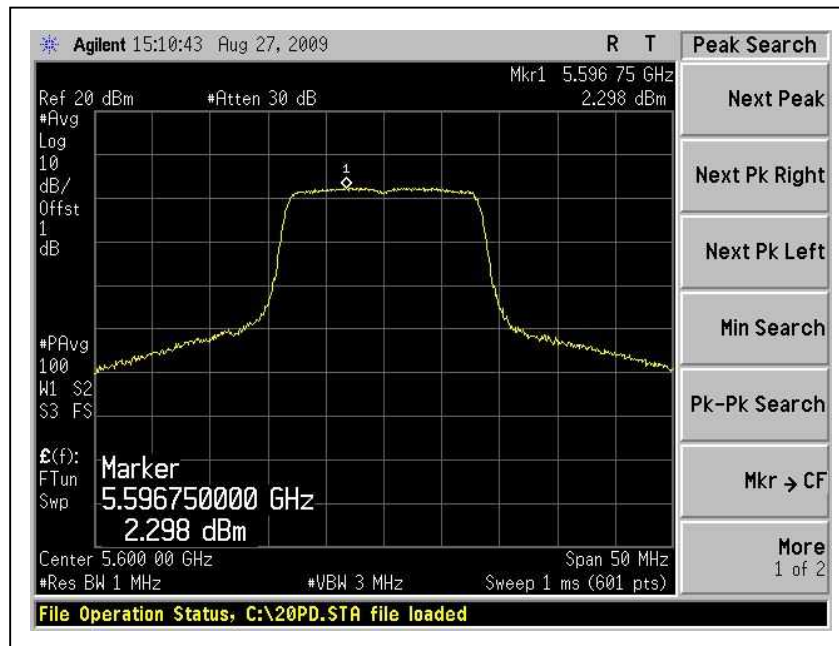



A D T

# CH140

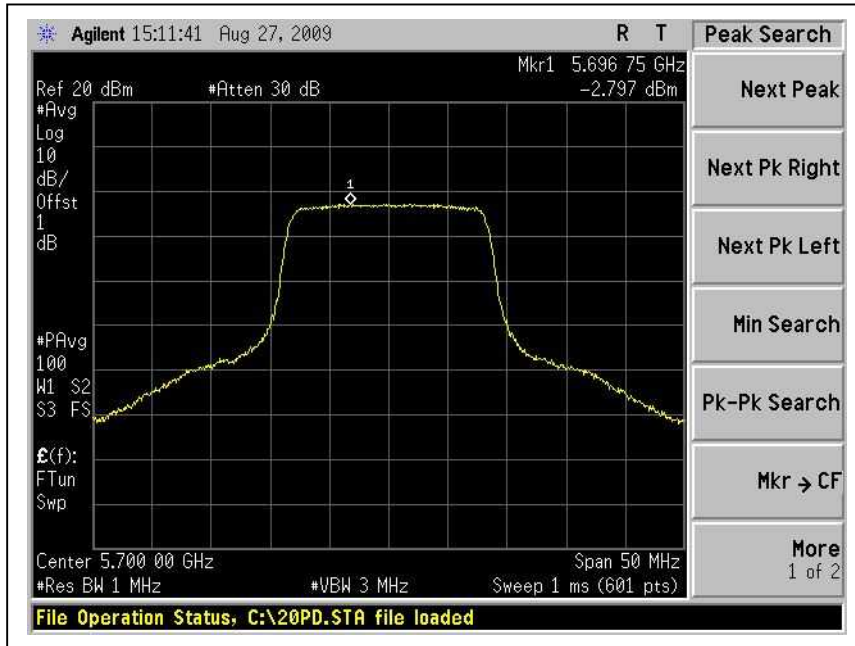

## 4.6 FREQUENCY STABILITY

### 4.6.1 LIMITS OF FREQUENCY STABILITY MEASUREMENT

The frequency tolerance of the carrier signal shall be maintained within +/- 0.02% of the operating frequency over a temperature variation of -30 degrees to 50 degrees C at normal supply voltage, and for a variation in the primary supply voltage from 85% to 115% of the rated supply voltage at a temperature of 20 degrees C.

### 4.6.2 TEST INSTRUMENTS

DESCRIPTION & MANUFACTURER	MODEL NO.	SERIAL NO.	CALIBRATED DATE	CALIBRATED UNTIL
R&S SPECTRUM ANALYZER	FSP40	100037	Aug. 03, 2009	Aug. 02, 2010

**NOTE:**

1. The calibration interval of the above test instruments is 12 months and the calibrations are traceable to NML/ROC and NIST/USA.

### 4.6.3 TEST PROCEDURE

1. The EUT was placed inside the environmental test chamber and powered by nominal DC voltage.
2. Turn the EUT on and couple its output to a spectrum analyzer.
3. Turn the EUT off and set the chamber to the highest temperature specified.
4. Allow sufficient time (approximately 30 min) for the temperature of the chamber to stabilize, turn the EUT on and measure the operating frequency after 2, 5, and 10 minutes.
5. Repeat step 2 and 3 with the temperature chamber set to the lowest temperature.
6. The test chamber was allowed to stabilize at +20 degree C for a minimum of 30 minutes. The supply voltage was then adjusted on the EUT from 85% to 115% and the frequency record.

#### 4.6.4 DEVIATION FROM TEST STANDARD

No deviation

#### 4.6.5 TEST SETUP

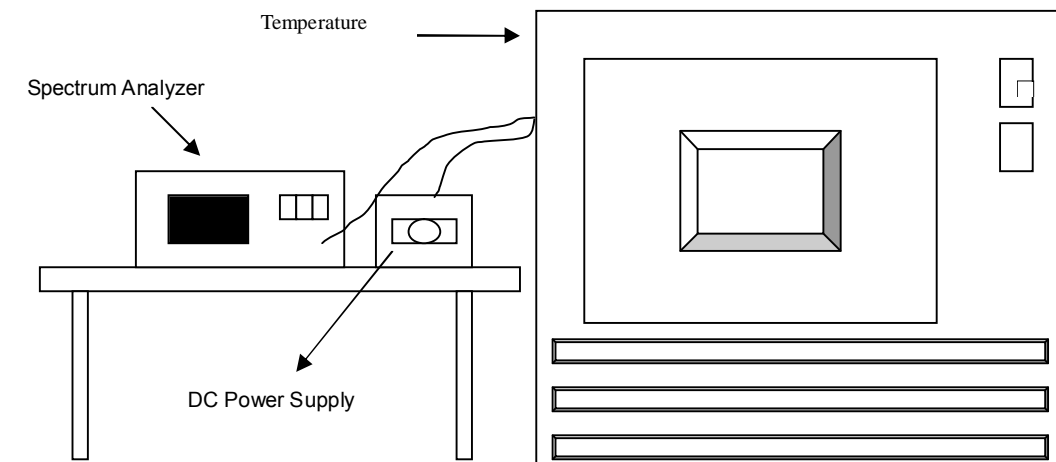

#### 4.6.6 EUT OPERATING CONDITION

The software provided by client to enable the EUT under transmission condition continuously at specific channel frequencies individually.





A D T

#### 4.6.7 TEST RESULTS

		Operating frequency: 5320MHz				Limit : $\pm 0.02\%$	
Temp. (°C)	Power supply (VAC)	2 minute		5 minute		10 minute	
		(MHz)	(%)	(MHz)	(%)	(MHz)	(%)
50	126.5	5320.0329	0.000618	5320.0332	0.000624	5320.0334	0.000628
	110	5320.0328	0.000617	5320.0332	0.000624	5320.0340	0.000639
	93.5	5320.0326	0.000613	5320.0332	0.000624	5320.0338	0.000635
40	126.5	5320.0212	0.000398	5320.0174	0.000327	5320.0168	0.000316
	110	5320.0242	0.000455	5320.0204	0.000383	5320.0192	0.000361
	93.5	5320.0202	0.000380	5320.0184	0.000346	5320.0178	0.000335
30	126.5	5320.0252	0.000474	5320.0234	0.000440	5320.0238	0.000447
	110	5320.0272	0.000511	5320.0254	0.000477	5320.0262	0.000492
	93.5	5320.0242	0.000455	5320.0234	0.000440	5320.0260	0.000489
20	126.5	5320.003	0.000056	5320.0029	0.000055	5320.0032	0.000060
	110	5320.0034	0.000064	5320.0033	0.000062	5320.0030	0.000056
	93.5	5320.003	0.000056	5320.0029	0.000055	5320.0027	0.000051
10	126.5	5319.9938	0.000117	5319.9937	0.000118	5319.9941	0.000111
	110	5319.9938	0.000117	5319.9939	0.000115	5319.9937	0.000118
	93.5	5319.9941	0.000111	5319.9936	0.000120	5319.9940	0.000113
0	126.5	5319.9881	0.000224	5319.9881	0.000224	5319.9870	0.000244
	110	5319.9883	0.000220	5319.9882	0.000222	5319.9878	0.000229
	93.5	5319.9881	0.000224	5319.9880	0.000226	5319.9872	0.000241
-10	126.5	5320.0142	0.000267	5320.0144	0.000271	5320.0148	0.000278
	110	5320.0172	0.000323	5320.0154	0.000289	5320.0154	0.000289
	93.5	5320.0142	0.000267	5320.0144	0.000271	5320.0152	0.000286
-20	126.5	5320.0084	0.000158	5320.0083	0.000156	5320.0074	0.000139
	110	5320.0084	0.000158	5320.0085	0.000160	5320.0072	0.000135
	93.5	5320.0083	0.000156	5320.0082	0.000154	5320.0070	0.000132
-30	126.5	5320.0073	0.000137	5320.0072	0.000135	5320.0062	0.000117
	110	5320.0075	0.000141	5320.0075	0.000141	5320.0060	0.000113
	93.5	5320.0073	0.000137	5320.0072	0.000135	5320.0057	0.000107



A D T

## 4.7 CONDUCTED OUT-BAND EMISSION MEASUREMENT

### 4.7.1 TEST INSTRUMENTS

DESCRIPTION & MANUFACTURER	MODEL NO.	SERIAL NO.	CALIBRATED DATE	CALIBRATED UNTIL
R&S SPECTRUM ANALYZER	FSP40	100037	Aug. 03, 2009	Aug. 02, 2010

**NOTE:**

1. The calibration interval of the above test instruments is 12 months and the calibrations are traceable to NML/ROC and NIST/USA.

### 4.7.2 TEST PROCEDURE

The transmitter output was connected to the spectrum analyzer via a low loss cable. Set RBW of spectrum analyzer to 1MHz with suitable frequency span including 100 MHz bandwidth from band edge. The band edges were measured and recorded.

### 4.7.3 EUT OPERATING CONDITION

The software provided by client to enable the EUT under transmission condition continuously at specific channel frequencies individually.

#### 4.7.4 TEST RESULTS

For 5.15 to 5.35GHz band:

The spectrum plots (Peak RBW=1MHz, VBW=3MHz) are attached on the following pages.



A D T

### 802.11a OFDM modulation

#### CH 36

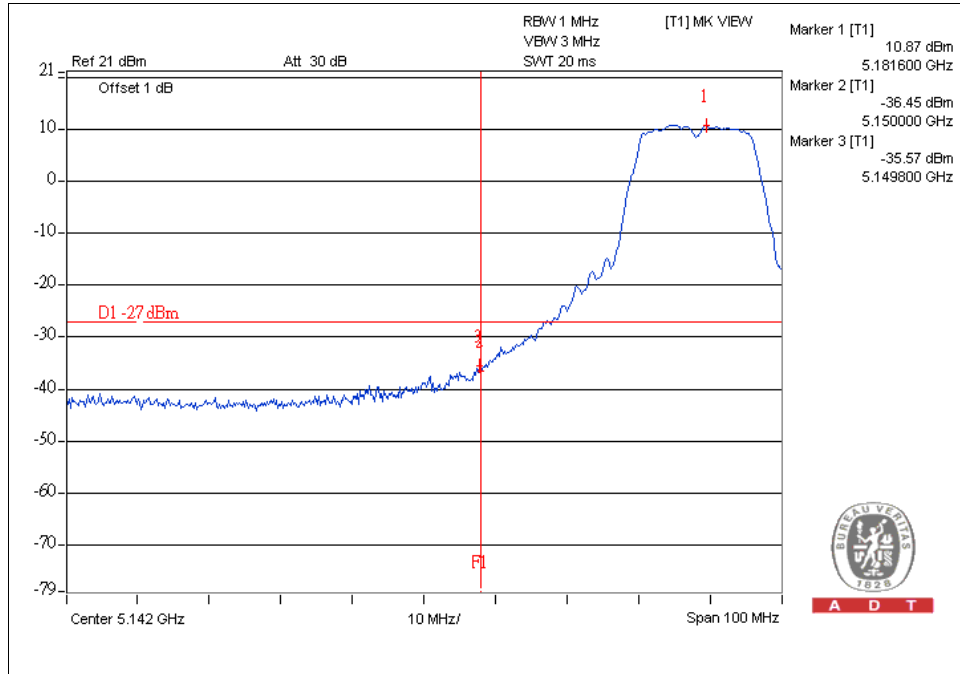

A D T

#### CH 64

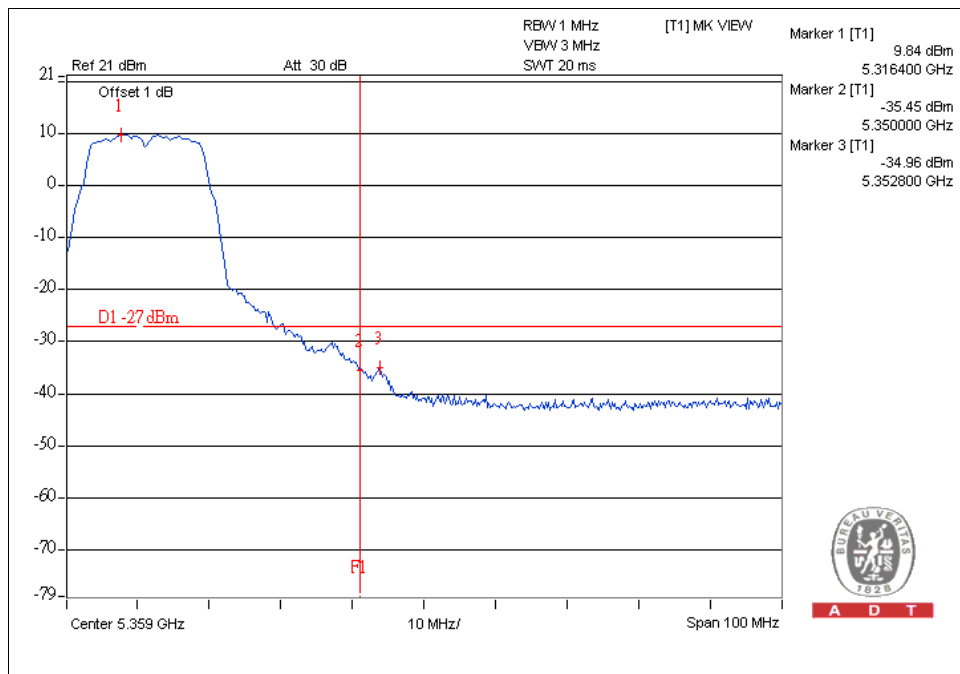

A D T



A D T

### CH 36

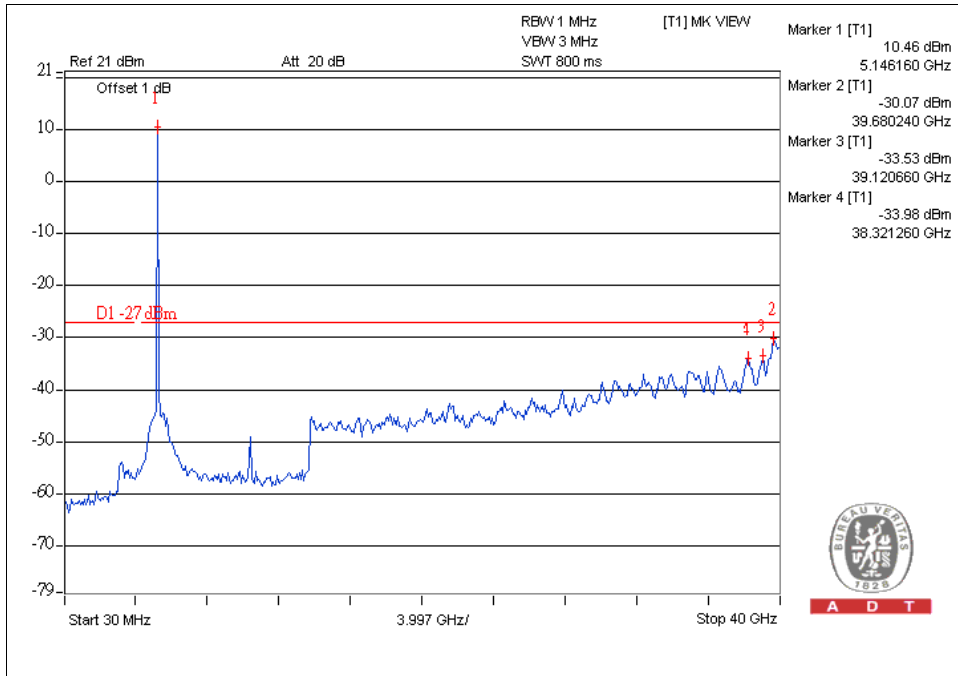

### CH 64

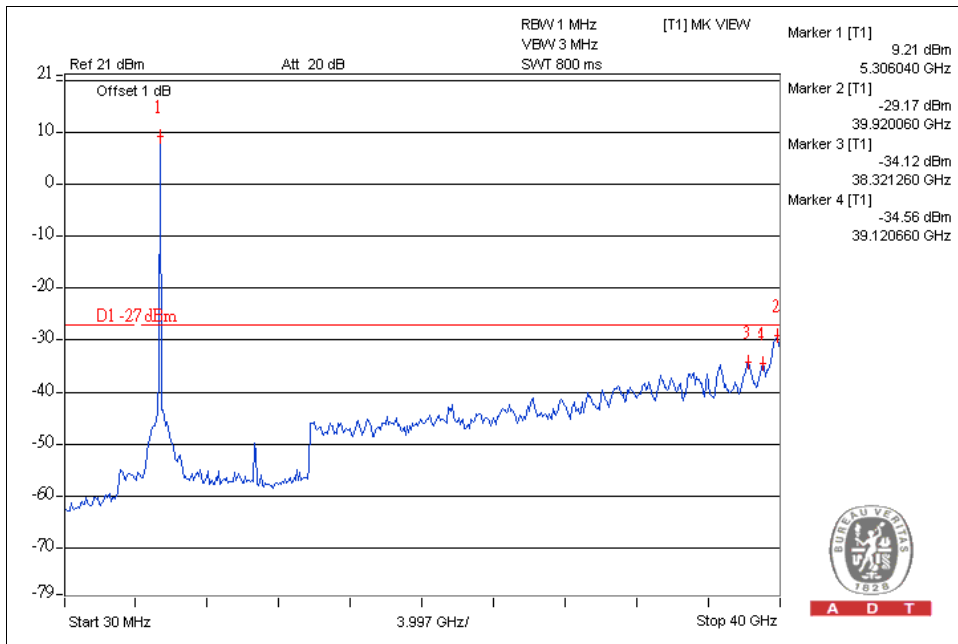

For 5.47 to 5.725GHz band:

The spectrum plots (Peak RBW=1MHz, VBW=3MHz) are attached on the following pages.



A D T

### 802.11a OFDM modulation

#### CH 100

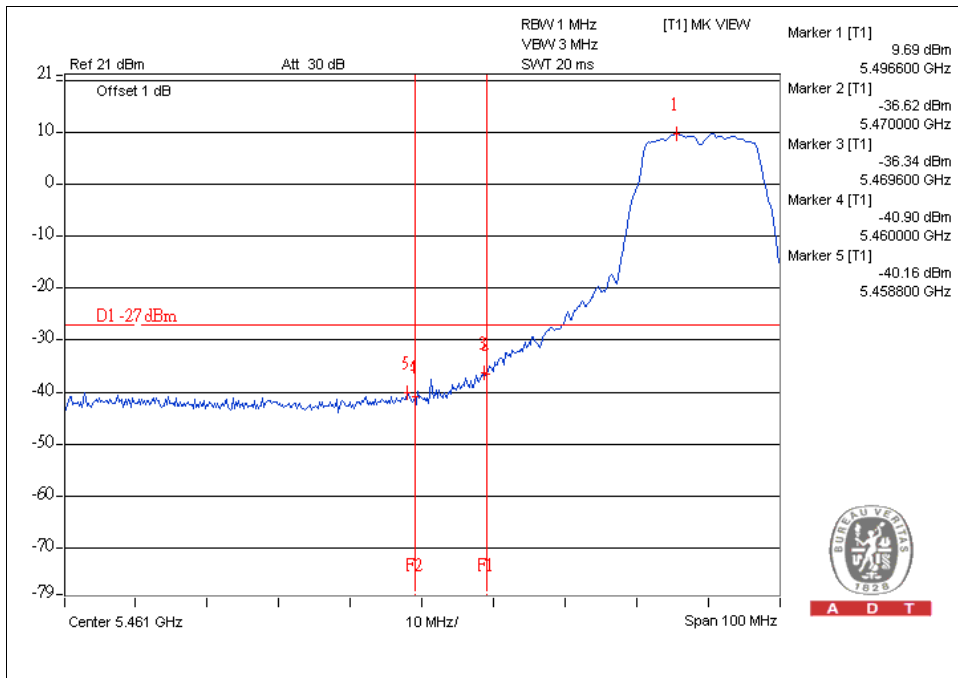

#### CH 140

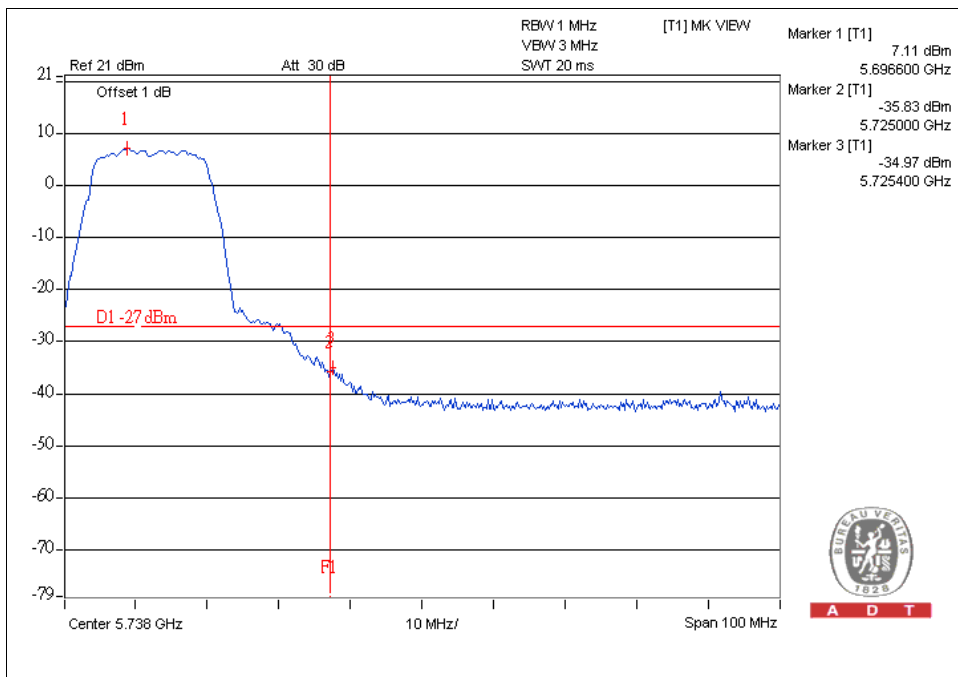



A D T

### CH 100

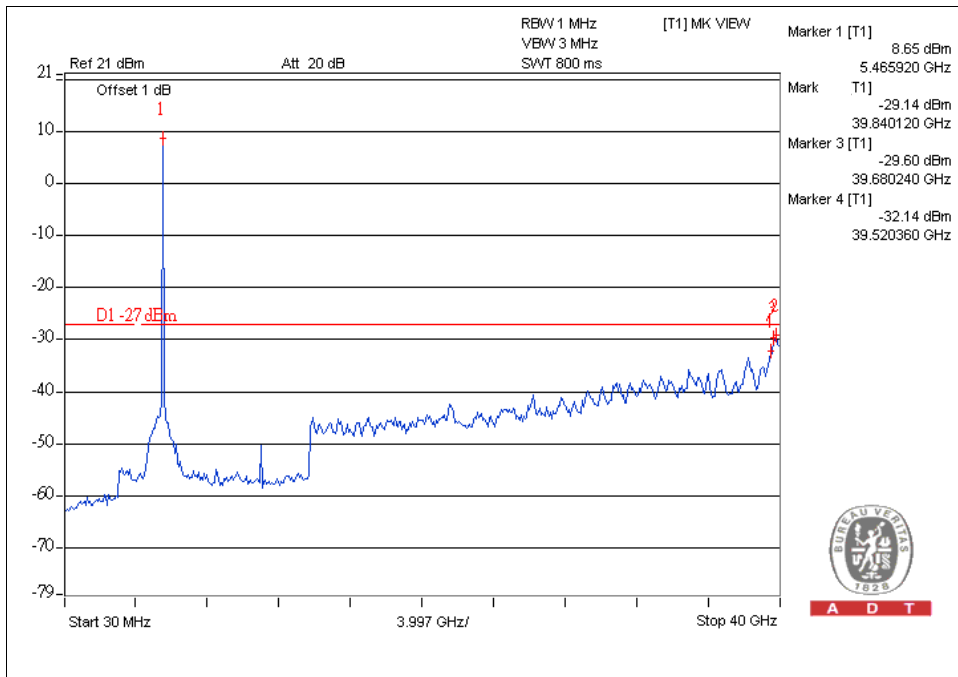

### CH 140

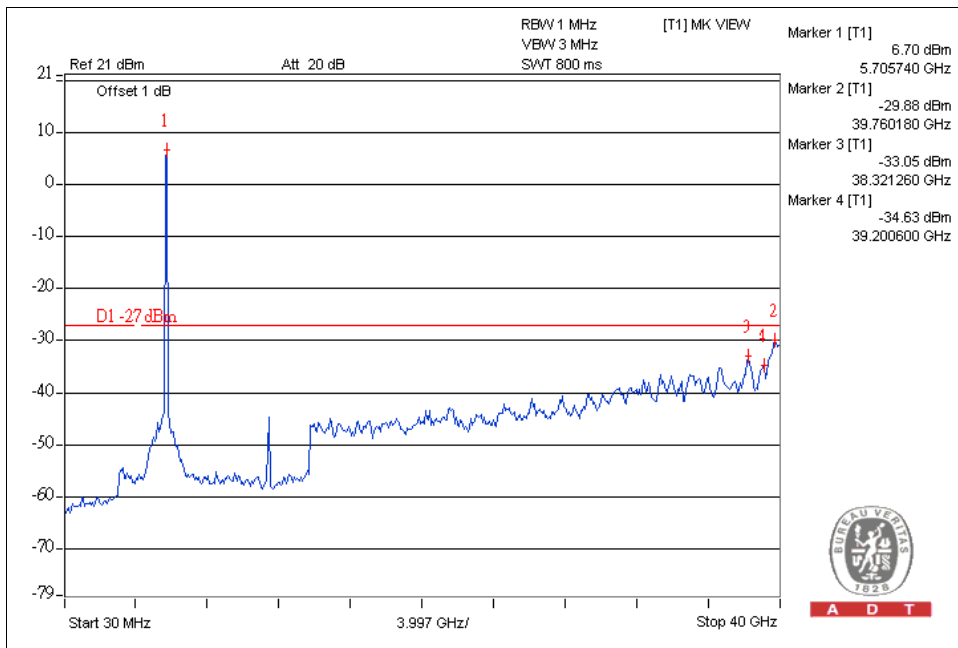



## 4.8 ANTENNA REQUIREMENT

### 4.8.1 STANDARD APPLICABLE

For intentional device, according to FCC 47 CFR Section 15.203, an intentional radiator shall be designed to ensure that no antenna other than that furnished by the responsible party shall be used with the device.

And according to FCC 47 CFR Section 15.407(a), if transmitting antennas of directional gain greater than 6dBi are used, the power shall be reduced by the amount in dB that the directional gain of the antenna exceeds 6dBi.

### 4.8.2 ANTENNA CONNECTED CONSTRUCTION

There are nine antennas provided to this EUT, please refer to the following table:

For WLAN								
No.	Brand	Model	Antenna Type	Gain (dBi)	Connector Type	Frequency range (MHz)	Cable Loss(dB)	Cable Length
1	Laird (R Type)	Rot main	PIFA	0.37(2.4G) 4.81(5G)	Hirose U.FL	2400~2500 4900~5850	0.1~0.15	25 ± 0.5mm
2	Laird (R Type)	Rot aux	PIFA	1.63(2.4G) 4.93(5G)	Hirose U.FL	2400~2500 4900~5850	0.1~0.15	61 +2/-1mm
3	Laird (S Type)	Str main	PIFA	0.89(2.4G) 4.34(5G)	Hirose U.FL	2400~2500 4900~5850	0.1~0.15	25 ± 0.5mm
4	Laird (S Type)	Str aux	PIFA	1.09(2.4G) 4.52(5G)	Hirose U.FL	2400~2500 4900~5850	0.1~0.15	61 +2/-1mm
5	Laird (G Type)	Gun main	PIFA	2.16(2.4G) 5.83(5G)	Hirose U.FL	2400~2500 4900~5850	0.1~0.15	25 ± 0.5mm
6	Laird (G Type)	Gun aux	PIFA	2.46(2.4G) 5.69(5G)	Hirose U.FL	2400~2500 4900~5850	0.1~0.15	61 +2/-1mm

**Note :**

1. For 2.4G: The antenna 6 was selected as representative antenna for the test.
2. For 5G: The antenna 5 was selected as representative antenna for the test.

**For Bluetooth**

No.	Brand	Model	Antenna Type	Gain (dBi)	Connector Type	Frequency range (MHz)	Cable Loss(dB)	Cable Length
1	Motorola	Rot type	PIFA	3.08	Hirose U.FL	2400~2480	0.1~0.15	35 ± 0.5mm
2	Motorola	Str type	PIFA	2.481	Hirose U.FL	2400~2480	0.1~0.15	35 ± 0.5mm
3	Motorola	Gun type	PIFA	2.885	Hirose U.FL	2400~2480	0.1~0.15	35 ± 0.5mm



A D T

## 5. INFORMATION ON THE TESTING LABORATORIES

We, Bureau Veritas Consumer Products Services (H.K.) Ltd., Taoyuan Branch, were founded in 1988 to provide our best service in EMC, Radio, Telecom and Safety consultation. Our laboratories are accredited and approved by the following approval agencies according to ISO/IEC 17025:

<b>USA</b>	FCC, NVLAP
<b>Germany</b>	TUV Rheinland
<b>Japan</b>	VCCI
<b>Norway</b>	NEMKO
<b>Canada</b>	INDUSTRY CANADA, CSA
<b>R.O.C.</b>	TAF, BSMI, NCC
<b>Netherlands</b>	Telefication
<b>Singapore</b>	GOST-ASIA (MOU)
<b>Russia</b>	CERTIS (MOU)

Copies of accreditation certificates of our laboratories obtained from approval agencies can be downloaded from our web site:

[www.adt.com.tw/index.5/phtml](http://www.adt.com.tw/index.5/phtml). If you have any comments, please feel free to contact us at the following:

**Linko EMC/RF Lab:**

Tel: 886-2-26052180

Fax: 886-2-26052943

**Hsin Chu EMC/RF Lab:**

Tel: 886-3-5935343

Fax: 886-3-5935342

**Hwa Ya EMC/RF/Safety Telecom Lab:**

Tel: 886-3-3183232

Fax: 886-3-3185050

**Web Site:** [www.adt.com.tw](http://www.adt.com.tw)

The address and road map of all our labs can be found in our web site also



A D T

## **6.APPENDIX-A- Modifications recorders for engineering changes to the eut BY THE LAB**

No any modifications are made to the EUT by the lab during the test.

**---END---**