



# FCC RADIO TEST REPORT

**FCC ID** : UZ7KC50A15  
**Equipment** : KC50A15 Kiosk Computer  
**Brand Name** : Zebra  
**Model Name** : KC50A15  
**Applicant** : Zebra Technologies Corporation  
3 Overlook Point, Lincolnshire, IL 60069 USA  
**Manufacturer** : Zebra Technologies Corporation  
3 Overlook Point, Lincolnshire, IL 60069 USA  
**Standard** : FCC Part 15 Subpart C §15.247

The product was received on May 14, 2024 and testing was performed from May 14, 2024 to Jul. 10, 2024. We, Sporton International Inc. Wensan Laboratory, would like to declare that the tested sample has been evaluated in accordance with the test procedures and has been in compliance with the applicable technical standards.

The test results in this report apply exclusively to the tested model / sample. Without written approval from Sporton International Inc. Wensan Laboratory, the test report shall not be reproduced except in full.

Approved by: Louis Wu

**Sporton International Inc. Wensan Laboratory**

No.58, Aly. 75, Ln. 564, Wenhua 3rd, Rd., Guishan Dist., Taoyuan City 333010, Taiwan (R.O.C.)



# Table of Contents

**History of this test report..... 3**

**Summary of Test Result..... 4**

**1 General Description..... 5**

    1.1 Product Feature of Equipment Under Test..... 5

    1.2 Product Specification of Equipment Under Test..... 6

    1.3 Modification of EUT ..... 6

    1.4 Testing Location ..... 7

    1.5 Applicable Standards..... 7

**2 Test Configuration of Equipment Under Test ..... 8**

    2.1 Carrier Frequency Channel ..... 8

    2.2 Test Mode..... 9

    2.3 Connection Diagram of Test System..... 11

    2.4 Support Unit used in test configuration and system ..... 12

    2.5 EUT Operation Test Setup ..... 12

    2.6 Measurement Results Explanation Example..... 12

**3 Test Result..... 13**

    3.1 Number of Channel Measurement ..... 13

    3.2 Hopping Channel Separation Measurement ..... 14

    3.3 Dwell Time Measurement..... 15

    3.4 20dB and 99% Bandwidth Measurement ..... 16

    3.5 Output Power Measurement..... 17

    3.6 Conducted Band Edges Measurement..... 18

    3.7 Conducted Spurious Emission Measurement ..... 19

    3.8 Radiated Band Edges and Spurious Emission Measurement ..... 20

    3.9 AC Conducted Emission Measurement..... 24

    3.10 Antenna Requirements ..... 26

**4 List of Measuring Equipment ..... 27**

**5 Measurement Uncertainty ..... 28**

**Appendix A. Conducted Test Results**

**Appendix B. AC Conducted Emission Test Result**

**Appendix C. Radiated Spurious Emission**

**Appendix D. Radiated Spurious Emission Plots**

**Appendix E. Duty Cycle Plots**

**Appendix F. Setup Photographs**



### History of this test report

Report No.	Version	Description	Issue Date
FR450111A	01	Initial issue of report	Jul. 29, 2024



## Summary of Test Result

Report Clause	Ref Std. Clause	Test Items	Result (PASS/FAIL)	Remark
3.1	15.247(a)(1)	Number of Channels	Pass	-
3.2	15.247(a)(1)	Hopping Channel Separation	Pass	-
3.3	15.247(a)(1)	Dwell Time of Each Channel	Pass	-
3.4	15.247(a)(1)	20dB Bandwidth	Pass	-
3.4	2.1049	99% Occupied Bandwidth	Pass	-
3.5	15.247(b)(1) 15.247(b)(4)	Peak Output Power	Pass	-
3.6	15.247(d)	Conducted Band Edges	Pass	-
3.7	15.247(d)	Conducted Spurious Emission	Pass	-
3.8	15.247(d)	Radiated Band Edges and Radiated Spurious Emission	Pass	4.99 dB under the limit at 49.55 MHz
3.9	15.207	AC Conducted Emission	Pass	9.80 dB under the limit at 13.56 MHz
3.10	15.203	Antenna Requirement	Pass	-

**Conformity Assessment Condition:**

1. The test results (PASS/FAIL) with all measurement uncertainty excluded are presented against the regulation limits or in accordance with the requirements stipulated by the applicant/manufacturer who shall bear all the risks of non-compliance that may potentially occur if measurement uncertainty is taken into account.
2. The measurement uncertainty please refer to each test result in the section "Measurement Uncertainty".

**Disclaimer:**

The product specifications of the EUT presented in the test report that may affect the test assessments are declared by the manufacturer who shall take full responsibility for the authenticity.

**Reviewed by: Yun Huang****Report Producer: Rebecca Wu**



# 1 General Description

## 1.1 Product Feature of Equipment Under Test

Product Feature	
Equipment	KC50A15 Kiosk Computer
Brand Name	Zebra
Model Name	KC50A15
FCC ID	UZ7KC50A15
EUT supports Radios application	NFC WLAN 11a/b/g/n HT20/HT40 WLAN 11ac VHT20/VHT40/VHT80/VHT160 WLAN 11ax HE20/HE40/HE80/HE160 Bluetooth BR/EDR/LE
HW Version	REV:PT
SW Version	13-29-29.00-TG-U00-STD-ATH-04
OS Version	Android 13
MFD	11MAY24
EUT Stage	Identical Prototype

Remark: The EUT's information above is declared by manufacturer.

Specification of Accessories				
AC Adapter	Brand Name	ZEBRA	Model Name	PS000088A01
USB C-C Cable	Brand Name	ZEBRA	Part Number	CBL-EC5X-USBC3A-01
Stand	Brand Name	ZEBRA	Part Number	3PTY-SC-2000-CF2-01
Printer	Brand Name	ZEBRA	Model Name	ZD230t
2nd display	Brand Name	ZEBRA	Model Name	TD50-15F00
Edge scanner	Brand Name	ZEBRA	Part Number	ZFLX-SCNR-E00
Edge LED Light Bar	Brand Name	ZEBRA	Part Number	ZFLX-LTBAR-200
USB Cable	Brand Name	ZEBRA	Part Number	300283-002



### 1.2 Product Specification of Equipment Under Test

Product Specification is subject to this standard	
<b>Tx/Rx Frequency Range</b>	2402 MHz ~ 2480 MHz
<b>Number of Channels</b>	79
<b>Carrier Frequency of Each Channel</b>	2402+n*1 MHz; n=0~78
<b>Maximum Output Power to Antenna</b>	<p><b>&lt;Ant. 1&gt;</b>  Bluetooth BR (1Mbps): 5.51 dBm (0.0036 W)  Bluetooth EDR (2Mbps): 4.80 dBm (0.0030 W)  Bluetooth EDR (3Mbps): 5.14 dBm (0.0033 W)</p> <p><b>&lt;Ant. 2&gt;</b>  Bluetooth BR (1Mbps): 5.19 dBm (0.0033 W)  Bluetooth EDR (2Mbps): 4.43 dBm (0.0028 W)  Bluetooth EDR (3Mbps): 4.85 dBm (0.0031 W)</p>
<b>99% Occupied Bandwidth</b>	<p><b>&lt;Ant. 1&gt;</b>  Bluetooth BR (1Mbps): 0.829 MHz  Bluetooth EDR (2Mbps): 1.169 MHz  Bluetooth EDR (3Mbps): 1.153 MHz</p> <p><b>&lt;Ant. 2&gt;</b>  Bluetooth BR (1Mbps): 0.829 MHz  Bluetooth EDR (2Mbps): 1.169 MHz  Bluetooth EDR (3Mbps): 1.153 MHz</p>
<b>Antenna Type / Gain</b>	<p><b>&lt;Ant. 1&gt;</b>: Coupling with gain 2.89 dBi  <b>&lt;Ant. 2&gt;</b>: PIFA with gain 2.98 dBi</p>
<b>Type of Modulation</b>	Bluetooth BR (1Mbps): GFSK Bluetooth EDR (2Mbps): $\pi/4$ -DQPSK Bluetooth EDR (3Mbps): 8-DPSK

**Remark:** The EUT's information above is declared by manufacturer. Please refer to Disclaimer in report summary.

### 1.3 Modification of EUT

No modifications made to the EUT during the testing.



### 1.4 Testing Location

<b>Test Site</b>	Sporton International Inc. Wensan Laboratory
<b>Test Site Location</b>	No.58, Aly. 75, Ln. 564, Wenhua 3rd, Rd., Guishan Dist., Taoyuan City 333010, Taiwan (R.O.C.) TEL: +886-3-327-0868 FAX: +886-3-327-0855
<b>Test Site No.</b>	<b>Sporton Site No.</b>
	TH05-HY, CO07-HY, 03CH20-HY

**Note:** The test site complies with ANSI C63.4 2014 requirement.

FCC designation No.: TW3786

### 1.5 Applicable Standards

According to the specifications declared by the manufacturer, the EUT must comply with the requirements of the following standards:

- ♦ FCC Part 15 Subpart C §15.247
- ♦ FCC KDB Publication No. 558074 D01 15.247 Meas Guidance v05r02
- ♦ FCC KDB 414788 D01 Radiated Test Site v01r01
- ♦ ANSI C63.10-2013

**Remark:**

1. All the test items were validated and recorded in accordance with the standards without any modification during the testing.
2. The TAF code is not including all the FCC KDB listed without accreditation.
3. This EUT has also been tested and complied with the requirements of FCC Part 15, Subpart B, recorded in a separate test report.



## 2 Test Configuration of Equipment Under Test

### 2.1 Carrier Frequency Channel

Frequency Band	Channel	Freq. (MHz)	Channel	Freq. (MHz)	Channel	Freq. (MHz)
2400-2483.5 MHz	0	2402	27	2429	54	2456
	1	2403	28	2430	55	2457
	2	2404	29	2431	56	2458
	3	2405	30	2432	57	2459
	4	2406	31	2433	58	2460
	5	2407	32	2434	59	2461
	6	2408	33	2435	60	2462
	7	2409	34	2436	61	2463
	8	2410	35	2437	62	2464
	9	2411	36	2438	63	2465
	10	2412	37	2439	64	2466
	11	2413	38	2440	65	2467
	12	2414	39	2441	66	2468
	13	2415	40	2442	67	2469
	14	2416	41	2443	68	2470
	15	2417	42	2444	69	2471
	16	2418	43	2445	70	2472
	17	2419	44	2446	71	2473
	18	2420	45	2447	72	2474
	19	2421	46	2448	73	2475
	20	2422	47	2449	74	2476
	21	2423	48	2450	75	2477
	22	2424	49	2451	76	2478
	23	2425	50	2452	77	2479
	24	2426	51	2453	78	2480
	25	2427	52	2454	-	-
	26	2428	53	2455	-	-





## **2.2 Test Mode**

- a. The EUT has been associated with peripherals and configuration operated in a manner tended to maximize its emission characteristics in a typical application. Frequency range investigated: conduction emission (150 kHz to 30 MHz), radiation emission (9 kHz to the 10th harmonic of the highest fundamental frequency or to 40 GHz, whichever is lower). For radiated measurement, the measured emission level of the EUT was maximized by rotating the EUT on a turntable, adjusting the orientation of the EUT and EUT antenna in three orthogonal axis (X: flat, Y: portrait, Z: landscape), and adjusting the measurement antenna orientation, following C63.10 exploratory test procedures and only the worst plane, and the worst mode of radiated spurious emissions is Bluetooth 1Mbps mode, and recorded in this report.
  
- b. AC power line Conducted Emission was tested under maximum output power.



The following summary table is showing all test modes to demonstrate in compliance with the standard.

Summary table of Test Cases			
Test Item	Data Rate / Modulation		
Conducted Test Cases	Bluetooth BR 1Mbps GFSK	Bluetooth EDR 2Mbps $\pi/4$ -DQPSK	Bluetooth EDR 3Mbps 8-DPSK
	Mode 1: CH00_2402 MHz	Mode 4: CH00_2402 MHz	Mode 7: CH00_2402 MHz
	Mode 2: CH39_2441 MHz	Mode 5: CH39_2441 MHz	Mode 8: CH39_2441 MHz
	Mode 3: CH78_2480 MHz	Mode 6: CH78_2480 MHz	Mode 9: CH78_2480 MHz
Radiated Test Cases	Bluetooth BR 1Mbps GFSK		
	<p><b>&lt;Ant. 1&gt;</b>            Mode 1: CH00_2402 MHz            Mode 2: CH39_2441 MHz            Mode 3: CH78_2480 MHz</p> <p><b>&lt;Ant. 2&gt;</b>            Mode 1: CH00_2402 MHz            Mode 2: CH39_2441 MHz            Mode 3: CH78_2480 MHz</p>		
AC Conducted Emission	Mode 1 :WLAN (2.4GHz) Link + Bluetooth Link + Scan Bar Code + USB C-C Cable Display with 2nd display + USB Cable with Printer + AC Adapter + LAN Link with Notebook + Edge USB-C with (Edge scanner + (Data Link with USB Flash Drive (USB to SD Card) + Edge LED Light Bar + Mouse) + Stand		
Remark:			
<ol style="list-style-type: none"> <li>For Radiated Test Cases, the worst mode data rate 1Mbps was reported only since the highest RF output power in the preliminary tests. The conducted spurious emissions and conducted band edge measurement for other data rates were not worse than 1Mbps, and no other significantly frequencies found in conducted spurious emission.</li> <li>Data Link with USB Flash Drive means data application transferred mode between EUT and USB Flash Drive.</li> </ol>			

## 2.3 Connection Diagram of Test System

### <AC Conducted Emission Mode>

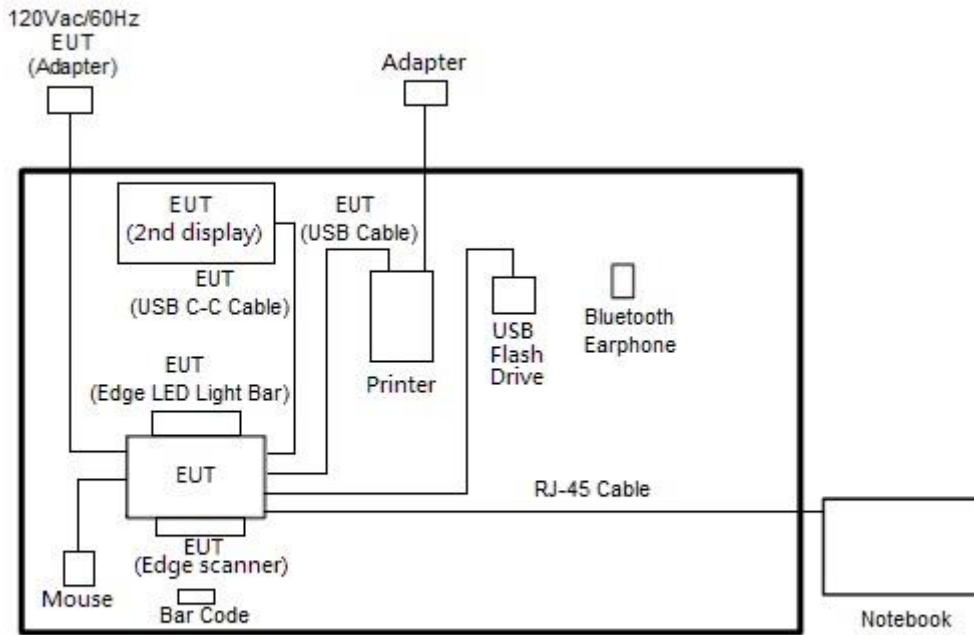

### <Bluetooth Tx Mode>

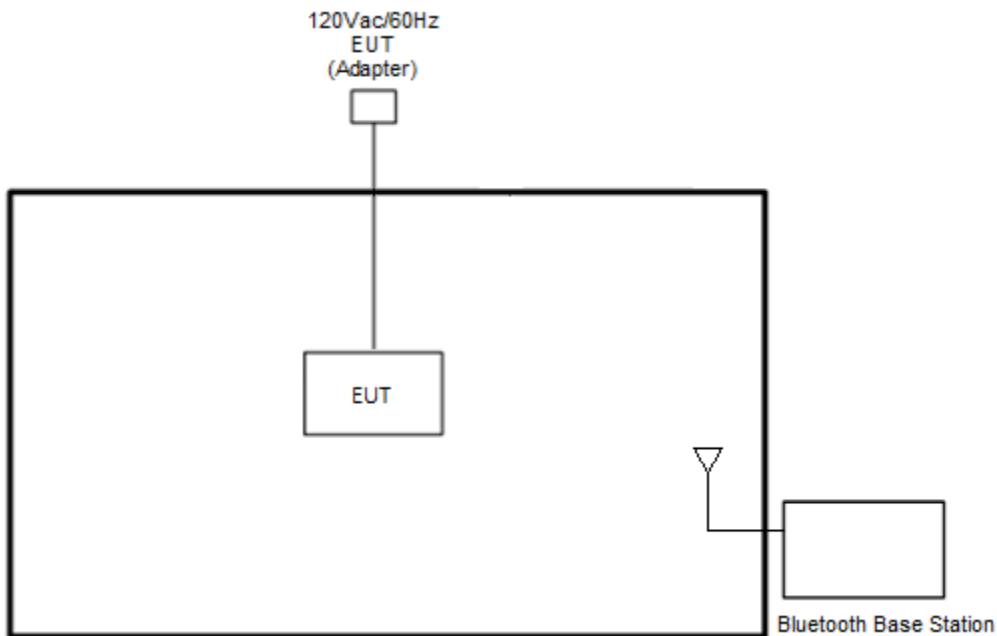



## 2.4 Support Unit used in test configuration and system

Item	Equipment	Brand Name	Model Name	FCC ID	Data Cable	Power Cord
1.	Bluetooth Base Station	Rohde & Schwarz	CBT	N/A	N/A	Unshielded, 1.8 m
2.	Bluetooth Earphone	Sony Ericsson	MW600	PY7DDA-2029	N/A	N/A
3.	WLAN AP	ASUS	RT-AC52	MSQ-RTAC4A00	N/A	Unshielded, 1.8 m
4.	Notebook	DELL	Latitude 3400	FCC DoC	N/A	AC I/P: Unshielded, 1.2 m DC O/P: Shielded, 1.8 m
5.	Notebook	DELL	Latitude 5310	FCC DoC	N/A	AC I/P: Unshielded, 1.2 m DC O/P: Shielded, 1.8 m
6.	Mouse	ACER	MOANUOA	FCC DoC	Shielded, 1.7m	N/A
7.	Barcode	N/A	N/A	N/A	N/A	N/A
8.	USB Flash Drive	SanDisk	E4BDC	FCC DoC	N/A	N/A
9.	SD Card	SanDisk	MicroSD HC	FCC DoC	N/A	N/A

## 2.5 EUT Operation Test Setup

The RF test items, utility “QRCT4.0.211.0” was installed in Notebook which was programmed in order to make the EUT get into the engineering modes to contact with base station to provide channel selection, power level, data rate and the application type and for continuous transmitting signals.

## 2.6 Measurement Results Explanation Example

**For all conducted test items:**

The offset level is set in the spectrum analyzer to compensate the RF cable loss and attenuator factor between EUT conducted output port and spectrum analyzer. With the offset compensation, the spectrum analyzer reading level is exactly the EUT RF output level.

Example:

The spectrum analyzer offset is derived from RF cable loss and attenuator factor.

*Offset = RF cable loss + attenuator factor.*

Following shows an offset computation example with cable loss 4.2 dB and 10 dB attenuator.

$$\begin{aligned} \text{Offset(dB)} &= \text{RF cable loss(dB)} + \text{attenuator factor(dB)}. \\ &= 4.2 + 10 = 14.2 \text{ (dB)} \end{aligned}$$

### 3 Test Result

#### 3.1 Number of Channel Measurement

##### 3.1.1 Limits of Number of Hopping Frequency

Frequency hopping systems in the 2400-2483.5 MHz band shall use at least 15 channels.

##### 3.1.2 Measuring Instruments

Please refer to the measuring equipment list in this test report.

##### 3.1.3 Test Procedure

1. The testing follows ANSI C63.10-2013 clause 7.8.3.
2. The RF output of EUT is connected to the spectrum analyzer by RF cable and attenuator. The path loss is compensated to the results for each measurement.
3. Set the maximum power setting and enable the EUT to transmit continuously.
4. Enable the EUT hopping function.
5. Use the following spectrum analyzer settings: Span = the frequency band of operation; RBW = 300 kHz; VBW  $\geq$  RBW; Sweep = auto; Detector function = peak; Trace = max hold.
6. The number of hopping frequency used is defined as the number of total channel.
7. Record the measurement data derived from spectrum analyzer.

##### 3.1.4 Test Setup

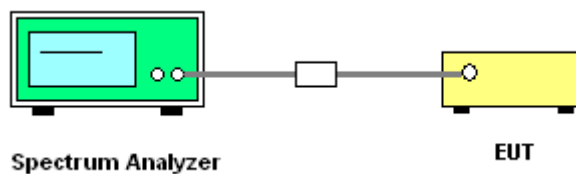

##### 3.1.5 Test Result of Number of Hopping Frequency

Please refer to Appendix A.

## 3.2 Hopping Channel Separation Measurement

### 3.2.1 Limit of Hopping Channel Separation

Frequency hopping systems operating in the 2400-2483.5 MHz band may have hopping channel carrier frequencies that are separated by 25 kHz or two-thirds of the 20 dB bandwidth of the hopping channel, whichever is greater.

### 3.2.2 Measuring Instruments

Please refer to the measuring equipment list in this test report.

### 3.2.3 Test Procedures

1. The testing follows ANSI C63.10-2013 clause 7.8.2.
2. The RF output of EUT is connected to the spectrum analyzer by RF cable and attenuator. The path loss is compensated to the results for each measurement.
3. Set the maximum power setting and enable the EUT to transmit continuously.
4. Enable the EUT hopping function.
5. Use the following spectrum analyzer settings:  
Span = wide enough to capture the peaks of two adjacent channels;  
RBW = 300 kHz; VBW  $\geq$  RBW; Sweep = auto; Detector function = peak; Trace = max hold.
6. Measure and record the results in the test report.

### 3.2.4 Test Setup

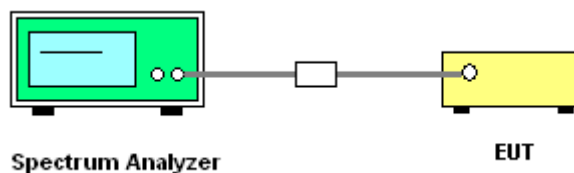

### 3.2.5 Test Result of Hopping Channel Separation

Please refer to Appendix A.

### 3.3 Dwell Time Measurement

#### 3.3.1 Limit of Dwell Time

The average time of occupancy on any channel shall not be greater than 0.4 seconds within a period of 0.4 seconds multiplied by the number of hopping channels employed.

#### 3.3.2 Measuring Instruments

Please refer to the measuring equipment list in this test report.

#### 3.3.3 Test Procedures

1. The testing follows ANSI C63.10-2013 clause 7.8.4.
2. The RF output of EUT is connected to the spectrum analyzer by RF cable and attenuator. The path loss is compensated to the results for each measurement.
3. Set the maximum power setting and enable the EUT to transmit continuously.
4. Enable the EUT hopping function.
5. Use the following spectrum analyzer settings: Span = zero span, centered on a hopping channel; RBW = 1 MHz; VBW  $\geq$  RBW; Sweep = as necessary to capture the entire dwell time per hopping channel; Detector function = peak; Trace = max hold.
6. Measure and record the results in the test report.

#### 3.3.4 Test Setup

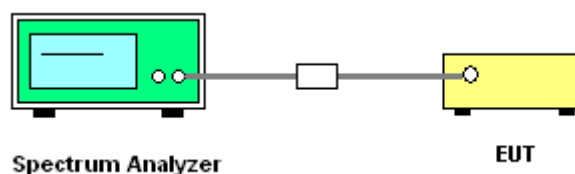

#### 3.3.5 Test Result of Dwell Time

Please refer to Appendix A.

### 3.4 20dB and 99% Bandwidth Measurement

#### 3.4.1 Limit of 20dB and 99% Bandwidth

Reporting only

#### 3.4.2 Measuring Instruments

Please refer to the measuring equipment list in this test report.

#### 3.4.3 Test Procedures

1. The testing follows ANSI C63.10-2013 clause 6.9.2 and 6.9.3.
2. The RF output of EUT is connected to the spectrum analyzer by RF cable and attenuator. The path loss is compensated to the results for each measurement.
3. Set the maximum power setting and enable the EUT to transmit continuously.
4. Use the following spectrum analyzer settings for 20 dB Bandwidth measurement.  
Span = approximately 2 to 5 times the 20 dB bandwidth, centered on a hopping channel;  
RBW  $\geq$  1% of the 20 dB bandwidth; VBW  $\geq$  RBW; Sweep = auto; Detector function = peak;  
Trace = max hold.
5. Use the following spectrum analyzer settings for 99 % Bandwidth measurement.  
Span = approximately 1.5 to 5 times the 99% bandwidth, centered on a hopping channel;  
RBW  $\geq$  1-5% of the 99% bandwidth; VBW  $\geq$  3 \* RBW; Sweep = auto; Detector function = peak;  
Trace = max hold.
6. Measure and record the results in the test report.

#### 3.4.4 Test Setup

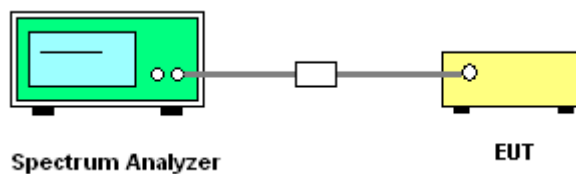

#### 3.4.5 Test Result of 20dB Bandwidth

Please refer to Appendix A.

#### 3.4.6 Test Result of 99% Occupied Bandwidth

Please refer to Appendix A.



## 3.5 Output Power Measurement

### 3.5.1 Limit of Output Power

The maximum peak conducted output power of the intentional radiator shall not exceed the following:  
For frequency hopping systems operating in the 2400-2483.5 MHz band employing at least 75 non-overlapping hopping channels, and all frequency hopping systems in the 5725-5850 MHz band: 1 watt. For all other frequency hopping systems in the 2400-2483.5 MHz band 0.125 watts.  
If directional gain of transmitting antennas is greater than 6 dBi, the power shall be reduced by the same level in dB comparing to gain minus 6 dBi.

### 3.5.2 Measuring Instruments

Please refer to the measuring equipment list in this test report.

### 3.5.3 Test Procedures

1. The testing follows ANSI C63.10-2013 clause 7.8.5.
2. The RF output of EUT is connected to the power meter by RF cable and attenuator. The path loss is compensated to the results for each measurement.
3. Set the maximum power setting and enable the EUT to transmit continuously.
4. Measure the conducted output power with cable loss and record the results in the test report.
5. Measure and record the results in the test report.

### 3.5.4 Test Setup

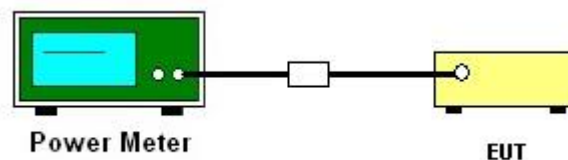

### 3.5.5 Test Result of Peak Output Power

Please refer to Appendix A.

### 3.5.6 Test Result of Average Output Power (Reporting Only)

Please refer to Appendix A.

## 3.6 Conducted Band Edges Measurement

### 3.6.1 Limit of Band Edges

In any 100 kHz bandwidth outside the intentional radiation frequency band, the radio frequency power shall be at least 20 dB below the highest level of the radiated power. In addition, radiated emissions which fall in the restricted bands must also comply with the radiated emission limits.

### 3.6.2 Measuring Instruments

Please refer to the measuring equipment list in this test report.

### 3.6.3 Test Procedures

1. The testing follows ANSI C63.10-2013 clause 7.8.6.
2. Set the maximum power setting and enable the EUT to transmit continuously.
3. Set RBW = 100 kHz, VBW = 300 kHz. Band edge emissions must be at least 20 dB down from the highest emission level within the authorized band as measured with a 100 kHz RBW. The attenuation shall be 30 dB instead of 20 dB when RMS conducted output power procedure is used.
4. Enable hopping function of the EUT and then repeat step 2 and 3.
5. Measure and record the results in the test report.

### 3.6.4 Test Setup

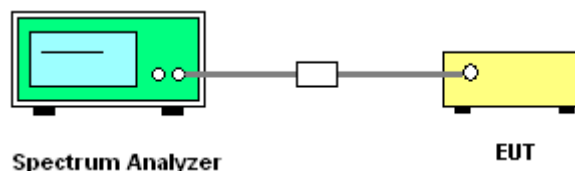

### 3.6.5 Test Result of Conducted Band Edges

Please refer to Appendix A.

### 3.6.6 Test Result of Conducted Hopping Mode Band Edges

Please refer to Appendix A.

## 3.7 Conducted Spurious Emission Measurement

### 3.7.1 Limit of Spurious Emission Measurement

In any 100 kHz bandwidth outside the intentional radiation frequency band, the radio frequency power shall be at least 20 dB below the highest level of the radiated power. In addition, radiated emissions which fall in the restricted bands must also comply with the radiated emission limits.

### 3.7.2 Measuring Instruments

Please refer to the measuring equipment list in this test report.

### 3.7.3 Test Procedure

1. The testing follows ANSI C63.10-2013 clause 7.8.8.
2. The RF output of EUT is connected to the spectrum analyzer by RF cable and attenuator. The path loss is compensated to the results for each measurement.
3. Set the maximum power setting and enable the EUT to transmit continuously.
4. Set RBW = 100 kHz, VBW = 300 kHz, scan up through 10th harmonic. All harmonics / spurious must be at least 20 dB down from the highest emission level within the authorized band as measured with a 100 kHz RBW.
5. Measure and record the results in the test report.
6. The RF fundamental frequency should be excluded against the limit line in the operating frequency band.

### 3.7.4 Test Setup



### 3.7.5 Test Result of Conducted Spurious Emission

Please refer to Appendix A.



### 3.8 Radiated Band Edges and Spurious Emission Measurement

#### 3.8.1 Limit of Radiated Band Edges and Spurious Emission

In any 100 kHz bandwidth outside the intentional radiator frequency band, all harmonics / spurious must be at least 20 dB below the highest emission level within the authorized band. In addition, radiated emissions which fall in the restricted bands must also comply with the limits as below.

Frequency (MHz)	Field Strength (microvolts/meter)	Measurement Distance (meters)
0.009 – 0.490	2400/F(kHz)	300
0.490 – 1.705	24000/F(kHz)	30
1.705 – 30.0	30	30
30 – 88	100	3
88 – 216	150	3
216 - 960	200	3
Above 960	500	3

#### 3.8.2 Measuring Instruments

Please refer to the measuring equipment list in this test report.



### 3.8.3 Test Procedures

1. The EUT is placed on a turntable with 0.8 meter for frequency below 1 GHz and 1.5 meter for frequency above 1 GHz respectively above ground.
2. The EUT is set 3 meters away from the receiving antenna, which is mounted on the top of a variable height antenna tower.
3. For each suspected emission, the EUT is arranged to its worst case and then tune the Antenna tower (from 1 m to 4 m) and turntable (from 0 degree to 360 degrees) to find the maximum reading. A pre-amp and a high pass filter are used for the test in order to get better signal level to comply with the guidelines.
4. Set the maximum power setting and enable the EUT to transmit continuously.
5. Use the following spectrum analyzer settings:
  - (1) Span shall wide enough to fully capture the emission being measured;
  - (2) Set RBW = 100 kHz for  $f < 1$  GHz, RBW = 1 MHz for  $f > 1$  GHz ; VBW  $\geq$  RBW; Sweep = auto; Detector function = peak; Trace = max hold for peak
  - (3) For average measurement: use duty cycle correction factor method per 15.35(c).  
Duty cycle = On time/100 milliseconds  
On time =  $N_1 * L_1 + N_2 * L_2 + \dots + N_{n-1} * L_{n-1} + N_n * L_n$   
Where  $N_1$  is number of type 1 pulses,  $L_1$  is length of type 1 pulses, etc.  
Average Emission Level = Peak Emission Level +  $20 * \log$  (Duty cycle)
6. Corrected Reading: Antenna Factor + Cable Loss + Read Level - Preamp Factor = Level
7. Radiated testing below 1 GHz is performed by adjusting the antenna tower from 1 m to 4 m and by rotating the turn table from 0 degree to 360 degrees to find the peak maximum hold reading. When there is no suspected emission found and the emission level is with at least 6 dB margin against QP limit line, the position is marked as “-“.
8. Radiated testing above 1 GHz is performed by adjusting the antenna tower from 1 m to 4 m and by rotating the turn table from 0 degree to 360 degrees to find the peak maximum hold reading for scanning all frequencies. When there is no suspected emission found and the harmonic emission level is with at least 6 dB margin against average limit line, the position is marked as “-“.

Note: The average levels are calculated from the peak level corrected with duty cycle correction factor (-24.79dB) derived from  $20 \log$  (dwell time/100ms). This correction is only for signals that hop with the fundamental signal, such as band-edge and harmonic. Other spurious signals that are independent of the hopping signal would not use this correction.

### 3.8.4 Test Setup

For radiated test below 30MHz

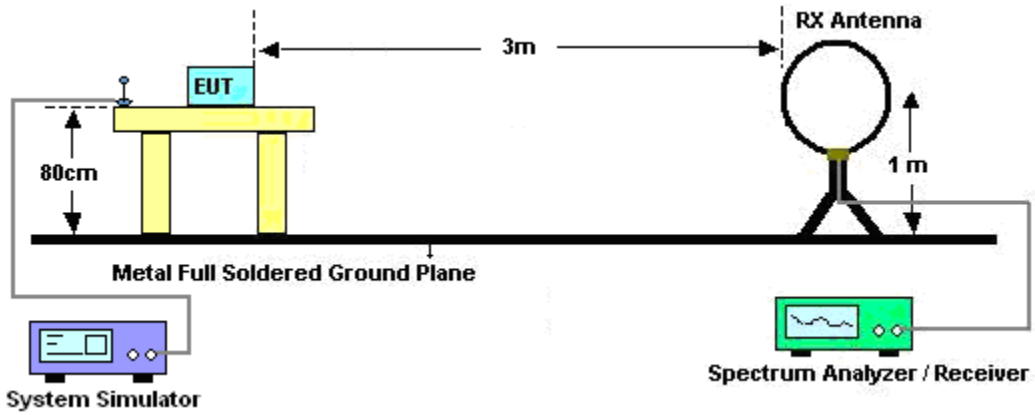

For radiated test from 30MHz to 1GHz

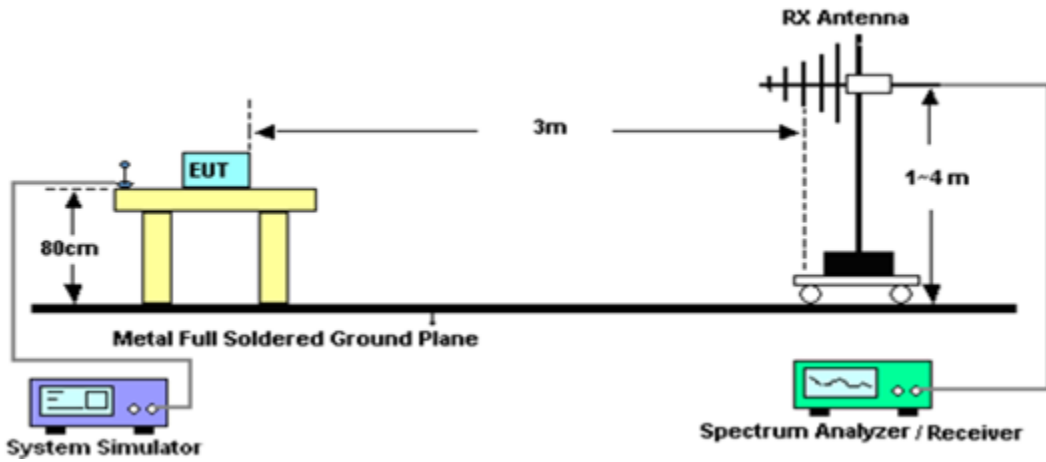

For radiated test from 1GHz to 18GHz

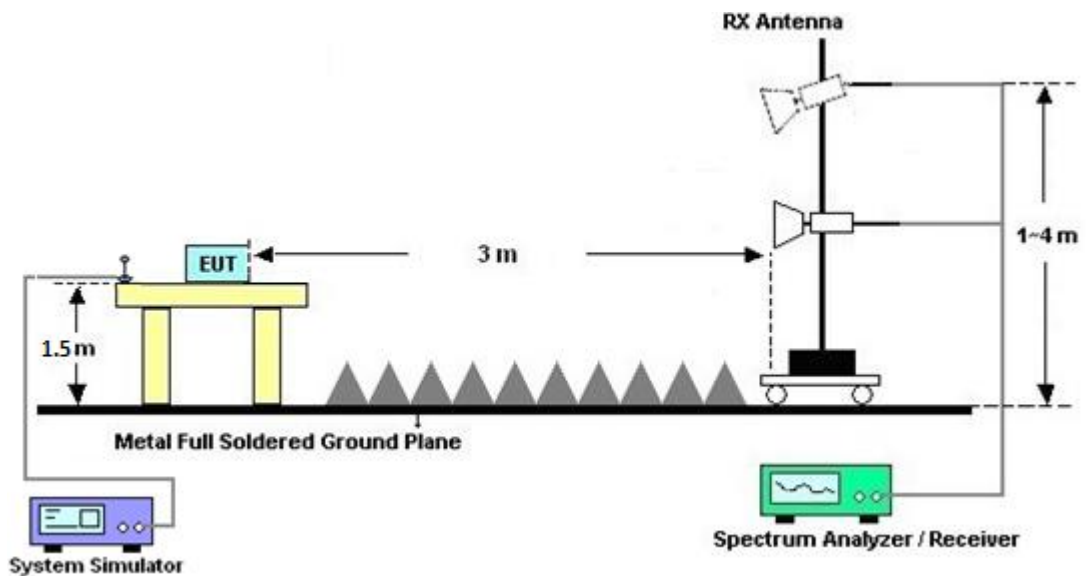

For radiated test above 18GHz

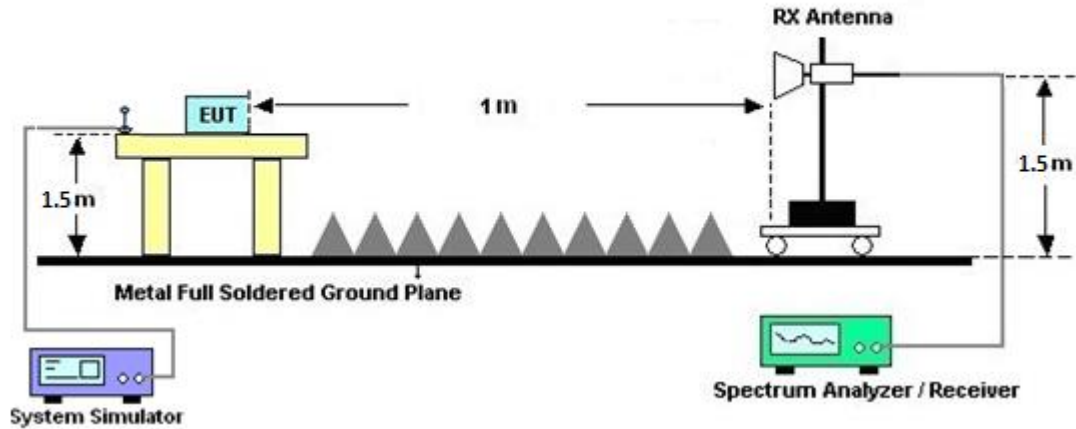

### 3.8.5 Test Results of Radiated Spurious Emissions (9 kHz ~ 30 MHz)

The low frequency, which starts from 9 kHz to 30 MHz, is pre-scanned and the result which is 20 dB lower than the limit line is not reported.

There is adequate comparison measurement of both open-field test site and alternative test site - semi-Anechoic chamber according to 414788 D01 Radiated Test Site v01r01, and the result comes out very similar.

### 3.8.6 Test Result of Radiated Spurious at Band Edges

Please refer to Appendix C and D.

### 3.8.7 Duty Cycle

Please refer to Appendix E.

### 3.8.8 Test Result of Radiated Spurious Emission (30MHz ~ 10<sup>th</sup> Harmonic)

Please refer to Appendix C and D.



### 3.9 AC Conducted Emission Measurement

#### 3.9.1 Limit of AC Conducted Emission

For equipment that is designed to be connected to the public utility (AC) power line, the radio frequency voltage that is conducted back onto the AC power line on any frequency or frequencies within the band 150 kHz to 30 MHz shall not exceed the limits in the following table.

Frequency of emission (MHz)	Conducted limit (dB $\mu$ V)	
	Quasi-peak	Average
0.15-0.5	66 to 56*	56 to 46*
0.5-5	56	46
5-30	60	50

\*Decreases with the logarithm of the frequency.

#### 3.9.2 Measuring Instruments

Please refer to the measuring equipment list in this test report.

#### 3.9.3 Test Procedures

1. The EUT is placed 0.4 meter away from the conducting wall of the shielding room, and is kept at least 80 centimeters from any other grounded conducting surface.
2. Connect EUT to the power mains through a line impedance stabilization network (LISN).
3. All the support units are connecting to the other LISN.
4. The LISN provides 50 ohm coupling impedance for the measuring instrument.
5. The FCC states that a 50 ohm, 50 microhenry LISN shall be used.
6. Both Line and Neutral shall be tested in order to find out the maximum conducted emission.
7. The frequency range from 150 kHz to 30 MHz is scanned.
8. Set the test-receiver system to Peak Detect Function and specified bandwidth (IF Bandwidth = 9 kHz) with Maximum Hold Mode. Then measurement is also conducted by Average Detector and Quasi-Peak Detector Function respectively.



### 3.9.4 Test Setup

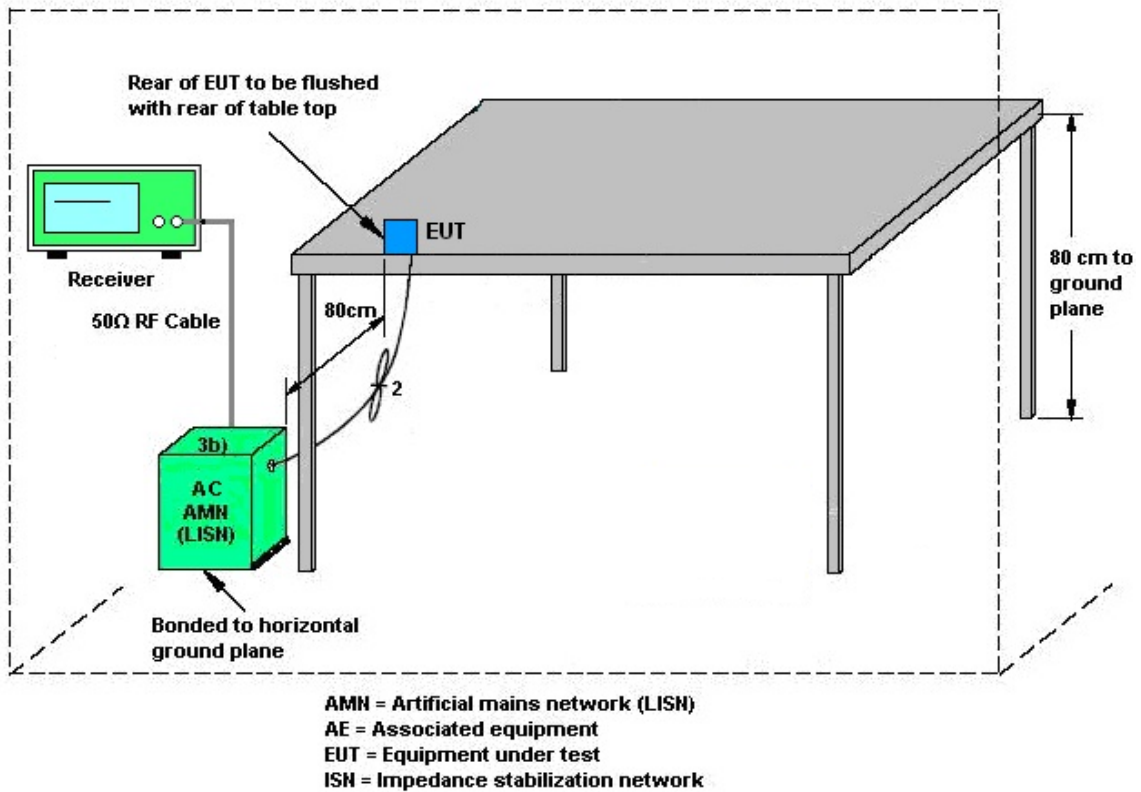

### 3.9.5 Test Result of AC Conducted Emission

Please refer to Appendix B.



## **3.10 Antenna Requirements**

### **3.10.1 Standard Applicable**

The use of a permanently attached antenna or of an antenna that uses a unique coupling to the intentional radiator shall be considered sufficient to comply with the rule.

### **3.10.2 Antenna Anti-Replacement Construction**

An embedded-in antenna design is used.



## 4 List of Measuring Equipment

Instrument	Brand Name	Model No.	Serial No.	Characteristics	Calibration Date	Test Date	Due Date	Remark
EMI Test Receiver	Keysight	N9038A(MXE)	MY54130085	N/A	Oct. 06, 2023	May 14, 2024~ Jul. 10, 2024	Oct. 05, 2024	Radiation (03CH20-HY)
Loop Antenna	Rohde & Schwarz	HFH2-Z2	100488	9 kHz~30 MHz	Sep. 12, 2023	May 14, 2024~ Jul. 10, 2024	Sep. 11, 2024	Radiation (03CH20-HY)
Preamplifier	EMEC	EM18G40G	060871	18GHz~40GHz	Aug. 30, 2023	May 14, 2024~ Jul. 10, 2024	Aug. 29, 2024	Radiation (03CH20-HY)
Controller	ChainTek	3000-1	N/A	Control Turn table & Ant Mast	N/A	May 14, 2024~ Jul. 10, 2024	N/A	Radiation (03CH20-HY)
Antenna Mast	ChainTek	MBS-520-1	N/A	1m~4m	N/A	May 14, 2024~ Jul. 10, 2024	N/A	Radiation (03CH20-HY)
Turn Table	ChainTek	T-200-S-1	N/A	0~360 Degree	N/A	May 14, 2024~ Jul. 10, 2024	N/A	Radiation (03CH20-HY)
Signal Analyzer	Keysight	N9010B	MY60240520	N/A	Dec. 12, 2023	May 14, 2024~ Jul. 10, 2024	Dec. 11, 2024	Radiation (03CH20-HY)
Bilog Antenna	TESEQ	CBL 6111D&00802 N1D01N-06	55606 & 08	30MHz~1GHz	Oct. 20, 2023	May 14, 2024~ Jul. 10, 2024	Oct. 19, 2024	Radiation (03CH20-HY)
Horn Antenna	SCHWARZBECK	BBHA 9120 D	02360	1GHz-18GHz	Oct. 30, 2023	May 14, 2024~ Jul. 10, 2024	Oct. 29, 2024	Radiation (03CH20-HY)
SHF-EHF Horn Antenna	SCHWARZBECK	BBHA 9170	00993	18GHz-40GHz	Nov. 24, 2023	May 14, 2024~ Jul. 10, 2024	Nov. 23, 2024	Radiation (03CH20-HY)
Preamplifier	COM-POWER	PAM-103	18020201	1MHz-1000MHz	Jan. 01, 2024	May 14, 2024~ Jul. 10, 2024	Dec. 31, 2024	Radiation (03CH20-HY)
Amplifier	EMCI	EMC118A45SE	980792	N/A	Nov. 13, 2023	May 14, 2024~ Jul. 10, 2024	Nov. 12, 2024	Radiation (03CH20-HY)
RF Cable	HUBER + SUHNER	SUCOFLEX 102	519229/2,804015/2,804027/2	N/A	Jan. 17, 2024	May 14, 2024~ Jul. 10, 2024	Jan. 16, 2025	Radiation (03CH20-HY)
Hygrometer	TECPEL	DTM-303A	TP211382	N/A	Mar. 27, 2024	May 14, 2024~ Jul. 10, 2024	Mar. 26, 2025	Radiation (03CH20-HY)
Software	Audix	N/A	RK-002156	N/A	N/A	May 14, 2024~ Jul. 10, 2024	N/A	Radiation (03CH20-HY)
Hygrometer	TECPEL	DTM-303A	TP201996	N/A	Nov. 07, 2023	May 14, 2024~ May 19, 2024	Nov. 06, 2024	Conducted (TH05-HY)
Power Meter	Agilent	E4416A	GB41292344	N/A	Jul. 12, 2023	May 14, 2024~ May 19, 2024	Jul. 11, 2024	Conducted (TH05-HY)
Power Sensor	Agilent	E9327A	US40441548	50MHz~18GHz	Jul. 12, 2023	May 14, 2024~ May 19, 2024	Jul. 11, 2024	Conducted (TH05-HY)
Signal Analyzer	Rohde & Schwarz	FSV40	101566	10Hz~40GHz	Aug. 23, 2023	May 14, 2024~ May 19, 2024	Aug. 22, 2024	Conducted (TH05-HY)
BT Base Station (Measure)	Rohde & Schwarz	CBT	101136	BT 3.0	Oct. 22, 2023	May 14, 2024~ May 19, 2024	Oct. 21, 2024	Conducted (TH05-HY)
AC Power Source	ACPOWER	AFC-11003G	F317040033	N/A	N/A	Jun. 26, 2024	N/A	Conduction (CO07-HY)
Software	Rohde & Schwarz	EMC32 V10.30	N/A	N/A	N/A	Jun. 26, 2024	N/A	Conduction (CO07-HY)
Pulse Limiter	SCHWARZBECK	VTSD 9561-F N	9561-F N00373	9kHz-200MHz	Oct. 20, 2023	Jun. 26, 2024	Oct. 19, 2024	Conduction (CO07-HY)
RF Cable	HUBER + SUHNER	RG 214/U	1358175	9kHz~30MHz	Mar. 14, 2024	Jun. 26, 2024	Mar. 13, 2025	Conduction (CO07-HY)
Two-Line V-Network	TESEQ	NNB 51	45051	N/A	Mar. 10, 2024	Jun. 26, 2024	Mar. 09, 2025	Conduction (CO07-HY)
Four-Line V-Network	TESEQ	NNB 52	36122	N/A	Mar. 07, 2024	Jun. 26, 2024	Mar. 06, 2025	Conduction (CO07-HY)
EMI Test Receiver	Rohde & Schwarz	ESR3	102317	9kHz~3.6GHz	Sep. 20, 2023	Jun. 26, 2024	Sep. 19, 2024	Conduction (CO07-HY)



## 5 Measurement Uncertainty

### Uncertainty of Conducted Emission Measurement (150 kHz ~ 30 MHz)

Measuring Uncertainty for a Level of Confidence of 95% ( $U = 2Uc(y)$ )	3.44 dB
---	---------

### Uncertainty of Radiated Emission Measurement (30 MHz ~ 1000 MHz)

Measuring Uncertainty for a Level of Confidence of 95% ( $U = 2Uc(y)$ )	6.40 dB
---	---------

### Uncertainty of Radiated Emission Measurement (1000 MHz ~ 6000 MHz)

Measuring Uncertainty for a Level of Confidence of 95% ( $U = 2Uc(y)$ )	4.50 dB
---	---------

### Uncertainty of Radiated Emission Measurement (6000 MHz ~ 18000 MHz)

Measuring Uncertainty for a Level of Confidence of 95% ( $U = 2Uc(y)$ )	4.60 dB
---	---------

### Uncertainty of Radiated Emission Measurement (18000 MHz ~ 40000 MHz)

Measuring Uncertainty for a Level of Confidence of 95% ( $U = 2Uc(y)$ )	5.40 dB
---	---------

**Appendix A. Test Result of Conducted Test Items**

Test Engineer:	Sylvia Li	Temperature:	21~25	°C
Test Date:	2024/05/13 ~ 2024/05/19	Relative Humidity:	51~54	%

&lt;Ant. 1&gt;

**TEST RESULTS DATA*****20dB and 99% Occupied Bandwidth and Hopping Channel Separation***

Mod.	Data Rate	NTX	CH.	Freq. (MHz)	20db BW (MHz)	99% Bandwidth (MHz)	Hopping Channel Separation Measurement (MHz)	Hopping Channel Separation Measurement Limit (MHz)	Pass/Fail
DH	1Mbps	1	0	2402	0.893	0.829	0.999	0.5950	Pass
DH	1Mbps	1	39	2441	0.895	0.829	1.298	0.5966	Pass
DH	1Mbps	1	78	2480	0.894	0.829	0.686	0.5960	Pass
2DH	2Mbps	1	0	2402	1.285	1.167	1.003	0.8564	Pass
2DH	2Mbps	1	39	2441	1.290	1.169	0.994	0.8598	Pass
2DH	2Mbps	1	78	2480	1.290	1.169	1.007	0.8600	Pass
3DH	3Mbps	1	0	2402	1.232	1.149	0.990	0.8210	Pass
3DH	3Mbps	1	39	2441	1.235	1.149	0.999	0.8232	Pass
3DH	3Mbps	1	78	2480	1.232	1.153	0.986	0.8210	Pass

**TEST RESULTS DATA*****Dwell Time***

Mod.	Hopping Channel Number Rate	Hops Over Occupancy Time (hops)	Package Transfer Time (msec)	Dwell Time (sec)	Limits (sec)	Pass/Fail
DH5	79	106.670	2.89	0.31	0.4	Pass
DH5 (AFH)	20	53.330	2.89	0.15	0.4	Pass

**TEST RESULTS DATA**

**Peak Power Table**

DH	CH.	NTX	Peak Power (dBm)	Power Limit (dBm)	Test Result
DH1	0	1	5.51	20.97	Pass
	39	1	4.92	20.97	Pass
	78	1	5.19	20.97	Pass
2DH1	0	1	4.80	20.97	Pass
	39	1	4.30	20.97	Pass
	78	1	4.47	20.97	Pass
3DH1	0	1	5.14	20.97	Pass
	39	1	4.60	20.97	Pass
	78	1	4.77	20.97	Pass

**TEST RESULTS DATA**

**Average Power Table**  
**(Reporting Only)**

DH	CH.	NTX	Average Power (dBm)	Duty Factor (dB)
DH1	0	1	5.13	5.20
	39	1	4.49	5.20
	78	1	4.70	5.20
2DH1	0	1	2.36	5.13
	39	1	1.73	5.13
	78	1	2.07	5.13
3DH1	0	1	2.48	5.13
	39	1	1.77	5.13
	78	1	2.10	5.13

**TEST RESULTS DATA**

**Number of Hopping Frequency**

Number of Hopping (Channel)	Adaptive Frequency Hopping (Channel)	Limits (Channel)	Pass/Fail
79	20	> 15	Pass

&lt;Ant. 2&gt;

**TEST RESULTS DATA****20dB and 99% Occupied Bandwidth and Hopping Channel Separation**

Mod.	Data Rate	NTX	CH.	Freq. (MHz)	20db BW (MHz)	99% Bandwidth (MHz)	Hopping Channel Separation Measurement (MHz)	Hopping Channel Separation Measurement Limit (MHz)	Pass/Fail
DH	1Mbps	1	0	2402	0.893	0.827	1.003	0.5952	Pass
DH	1Mbps	1	39	2441	0.894	0.827	0.999	0.5960	Pass
DH	1Mbps	1	78	2480	0.894	0.829	0.999	0.5958	Pass
2DH	2Mbps	1	0	2402	1.288	1.167	1.016	0.8584	Pass
2DH	2Mbps	1	39	2441	1.290	1.167	1.007	0.8602	Pass
2DH	2Mbps	1	78	2480	1.287	1.169	1.003	0.8582	Pass
3DH	3Mbps	1	0	2402	1.227	1.149	1.003	0.8182	Pass
3DH	3Mbps	1	39	2441	1.232	1.153	0.990	0.8216	Pass
3DH	3Mbps	1	78	2480	1.227	1.153	1.003	0.8182	Pass

**TEST RESULTS DATA****Dwell Time**

Mod.	Hopping Channel Number Rate	Hops Over Occupancy Time (hops)	Package Transfer Time (msec)	Dwell Time (sec)	Limits (sec)	Pass/Fail
2DH5	79	106.670	2.89	0.31	0.4	Pass
2DH5 (AFH)	20	53.330	2.89	0.15	0.4	Pass

**TEST RESULTS DATA**

**Peak Power Table**

DH	CH.	NTX	Peak Power (dBm)	Power Limit (dBm)	Test Result
DH1	0	1	4.71	20.97	Pass
	39	1	<b>5.19</b>	20.97	Pass
	78	1	4.74	20.97	Pass
2DH1	0	1	4.00	20.97	Pass
	39	1	<b>4.43</b>	20.97	Pass
	78	1	4.08	20.97	Pass
3DH1	0	1	4.23	20.97	Pass
	39	1	<b>4.85</b>	20.97	Pass
	78	1	4.43	20.97	Pass

**TEST RESULTS DATA**

**Average Power Table**  
**(Reporting Only)**

DH	CH.	NTX	Average Power (dBm)	Duty Factor (dB)
DH1	0	1	4.10	5.20
	39	1	<b>4.54</b>	5.20
	78	1	4.08	5.20
2DH1	0	1	1.20	5.13
	39	1	<b>1.83</b>	5.13
	78	1	1.42	5.13
3DH1	0	1	1.21	5.13
	39	1	<b>1.84</b>	5.13
	78	1	1.43	5.13

**TEST RESULTS DATA**

**Number of Hopping Frequency**

Number of Hopping (Channel)	Adaptive Frequency Hopping (Channel)	Limits (Channel)	Pass/Fail
79	20	> 15	Pass





<Ant. 1>

### Number of Hopping Frequency

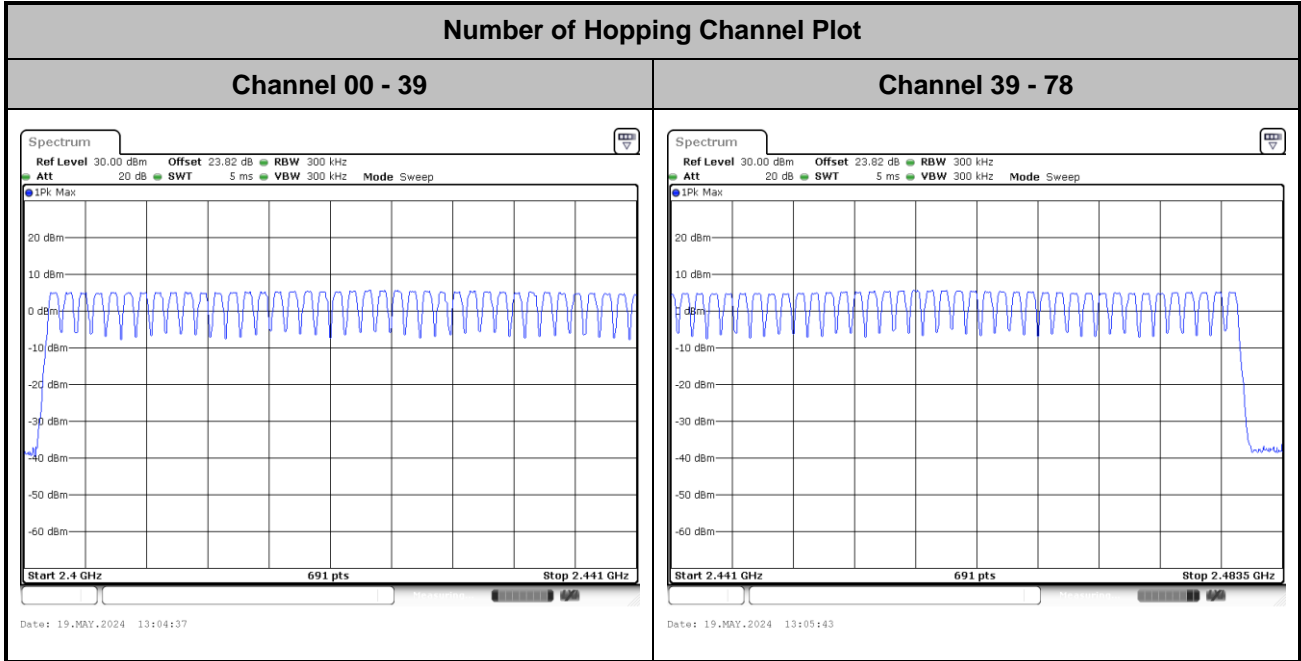



# Hopping Channel Separation

<1Mbps>

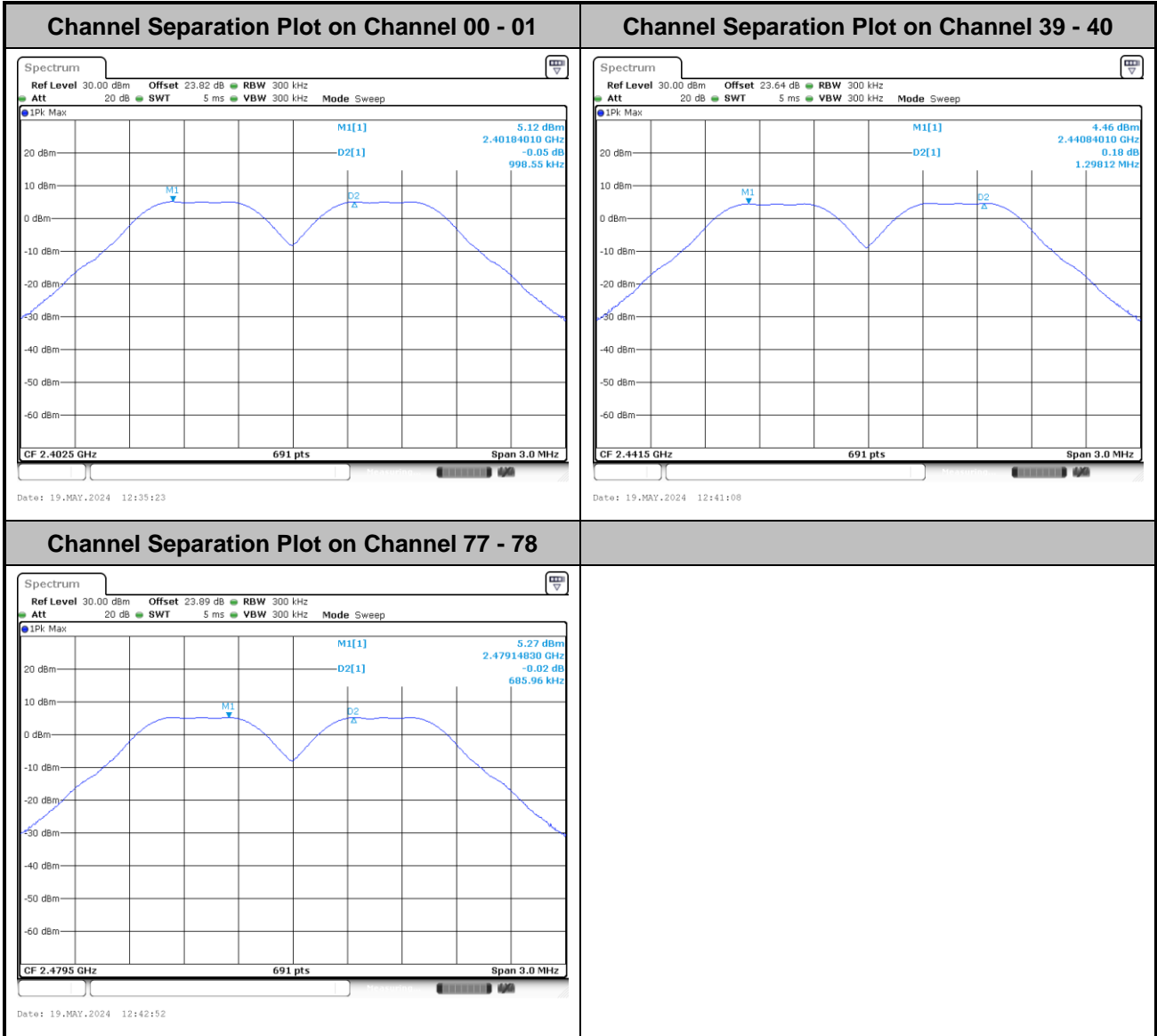



<2Mbps>

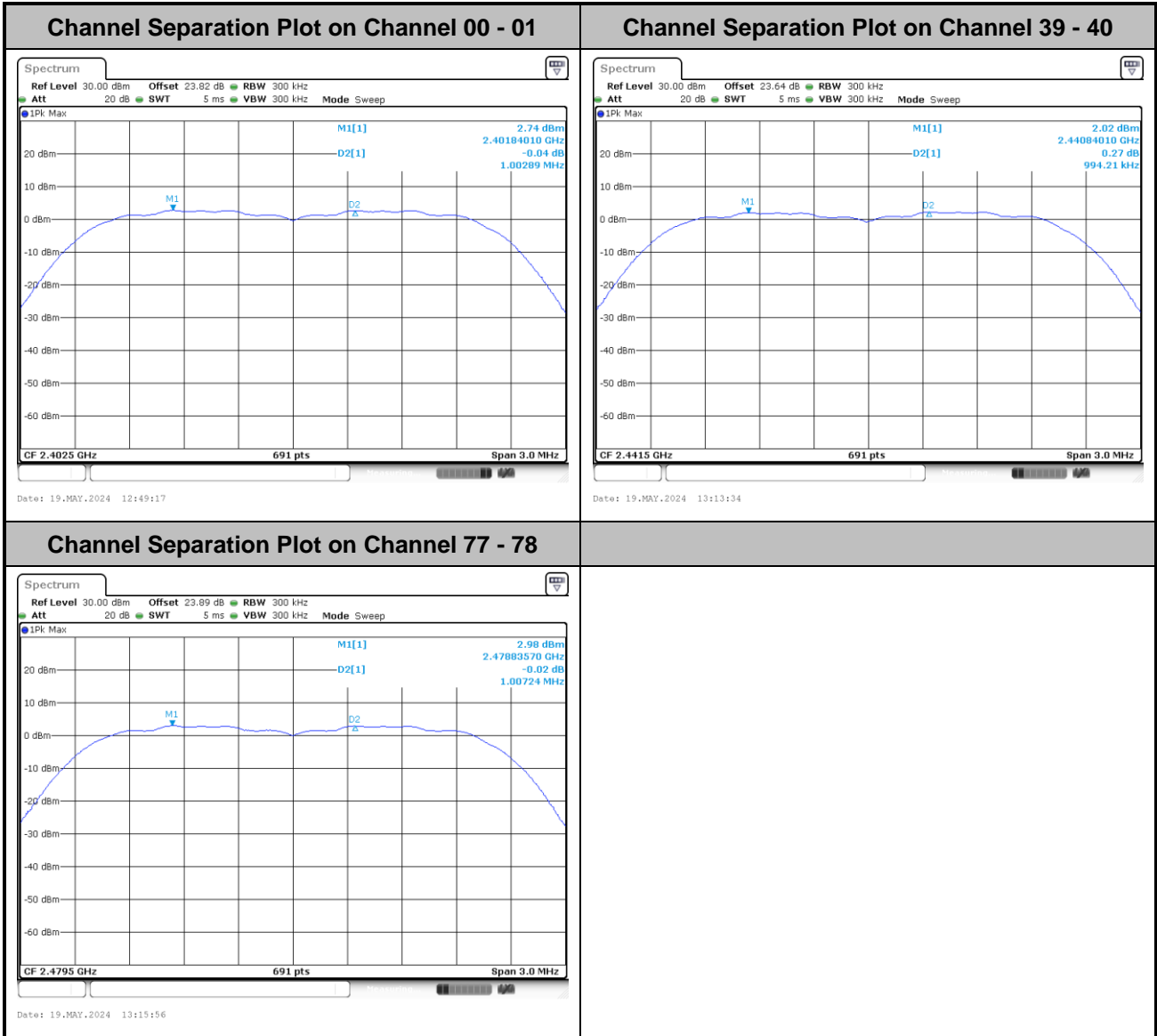



<3Mbps>

Channel Separation Plot on Channel 00 - 01

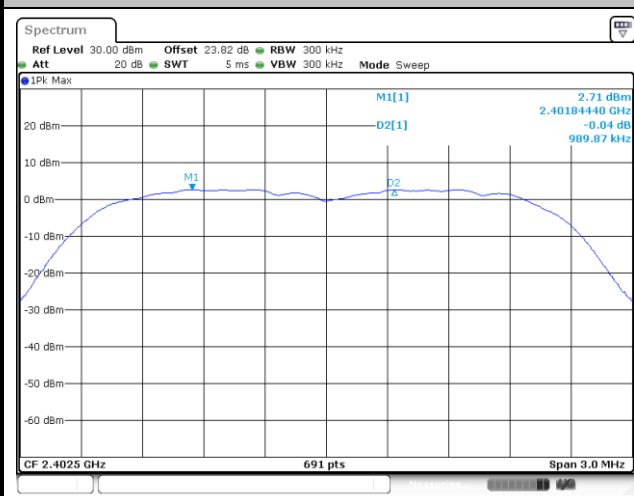

Date: 19.MAY.2024 13:17:29

Channel Separation Plot on Channel 39 - 40

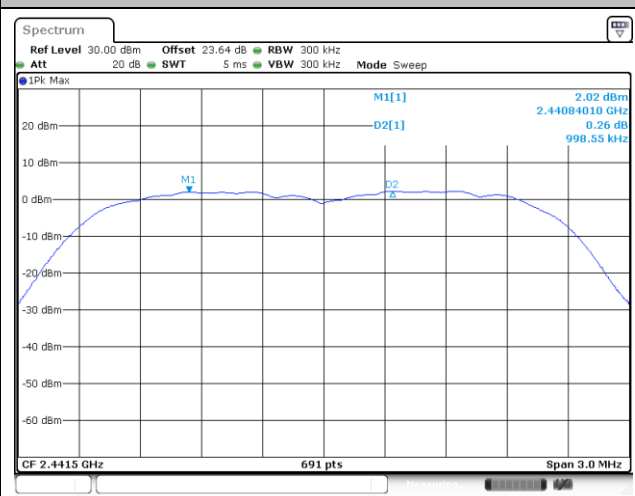

Date: 19.MAY.2024 13:18:37

Channel Separation Plot on Channel 77 - 78

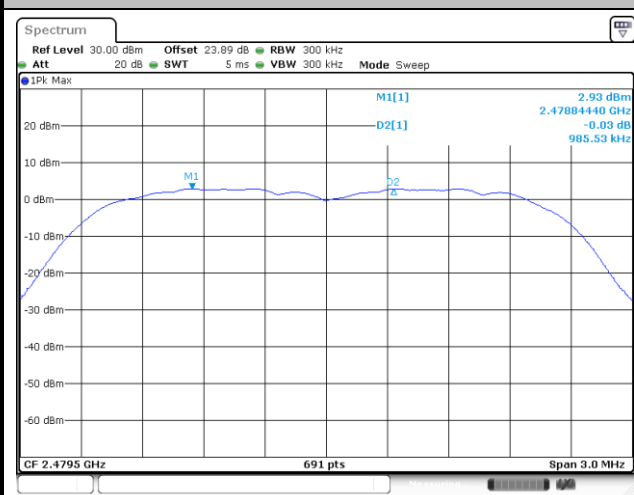

Date: 19.MAY.2024 13:28:23



Dwell Time

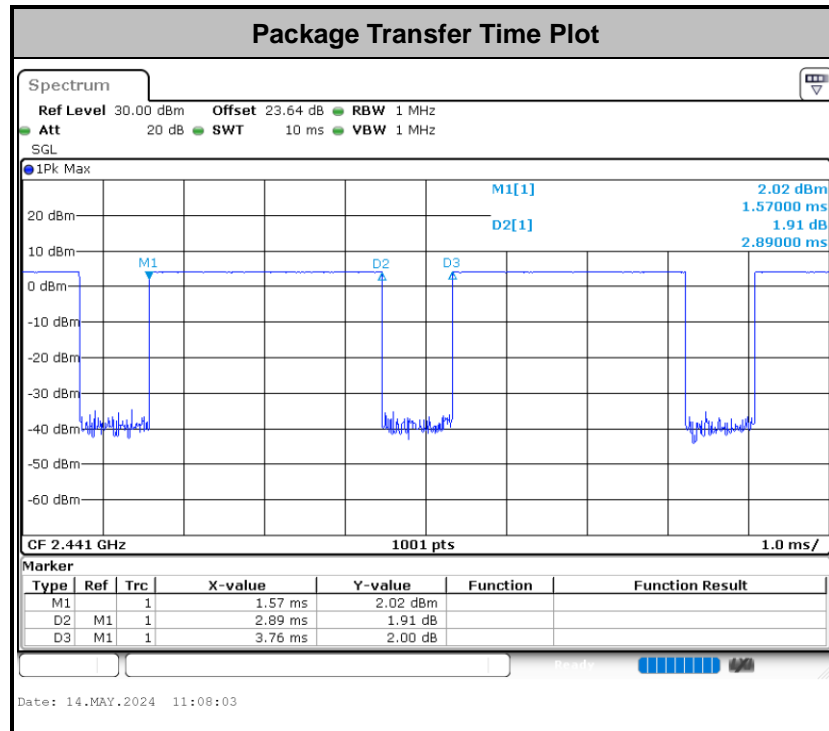

Remark:

1. In normal mode, hopping rate is 1600 hops/s with 6 slots in 79 hopping channels. With channel hopping rate (1600 / 6 / 79) in Occupancy Time Limit (0.4 x 79) (s), Hops Over Occupancy Time comes to (1600 / 6 / 79) x (0.4 x 79) = 106.67 hops.
2. In AFH mode, hopping rate is 800 hops/s with 6 slots in 20 hopping channels. With channel hopping rate (800 / 6 / 20) in Occupancy Time Limit (0.4 x 20) (s), Hops Over Occupancy Time comes to (800 / 6 / 20) x (0.4 x 20) = 53.33 hops.
3. Dwell Time(s) = Hops Over Occupancy Time (hops) x Package Transfer Time



# 20dB Bandwidth

<1Mbps>

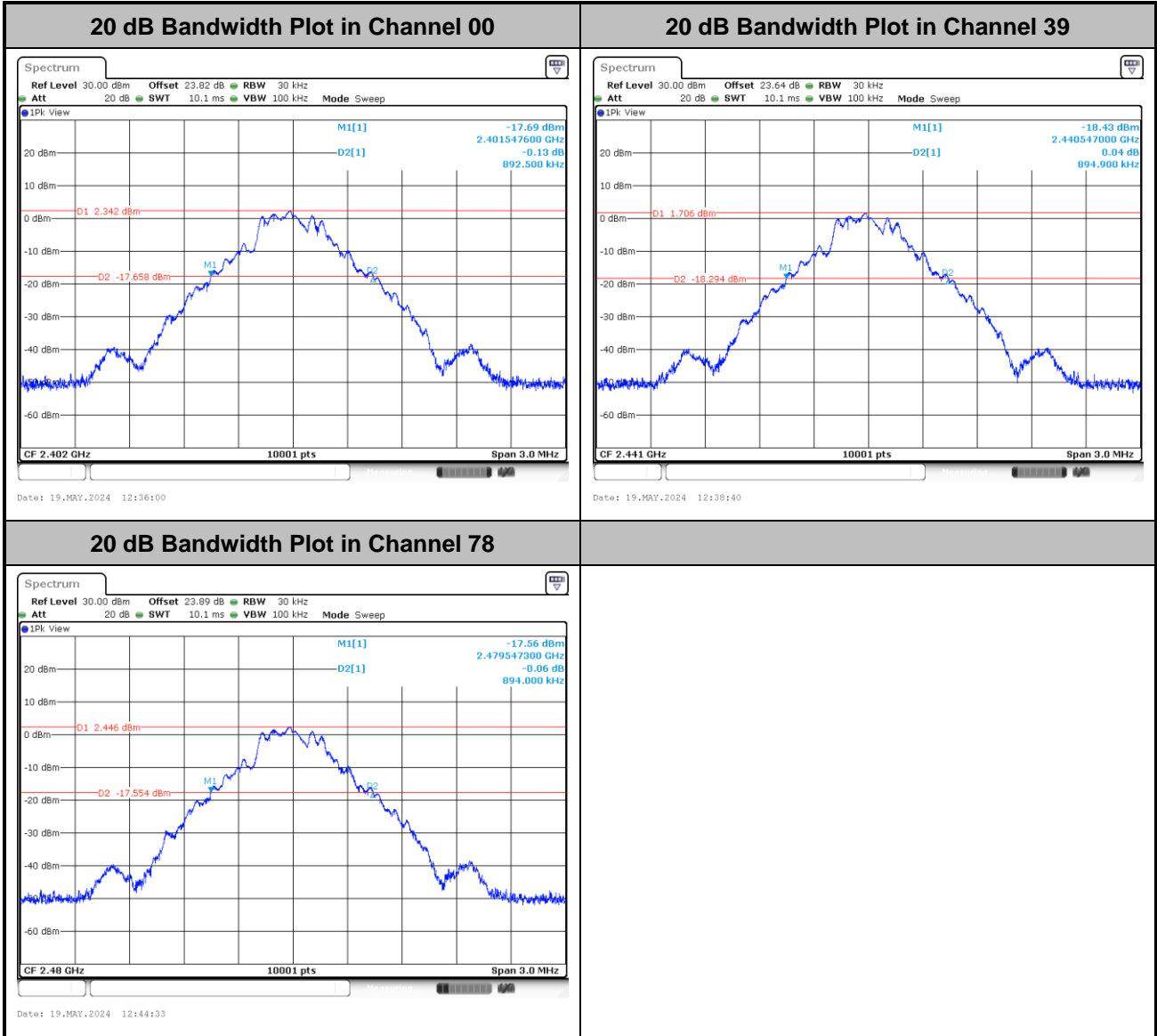



<2Mbps>

20 dB Bandwidth Plot in Channel 00

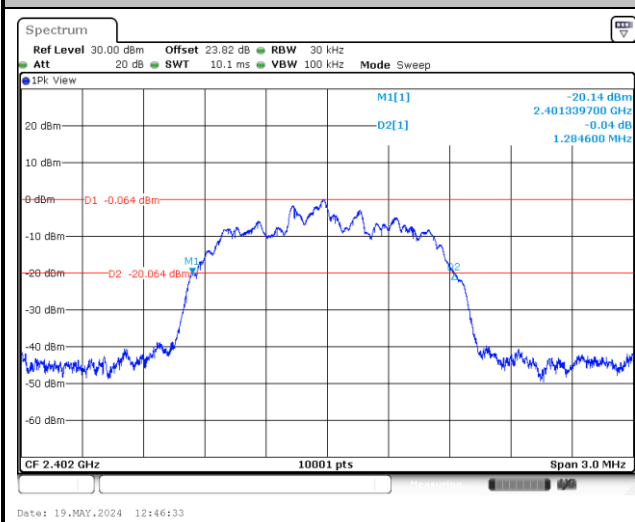

20 dB Bandwidth Plot in Channel 39

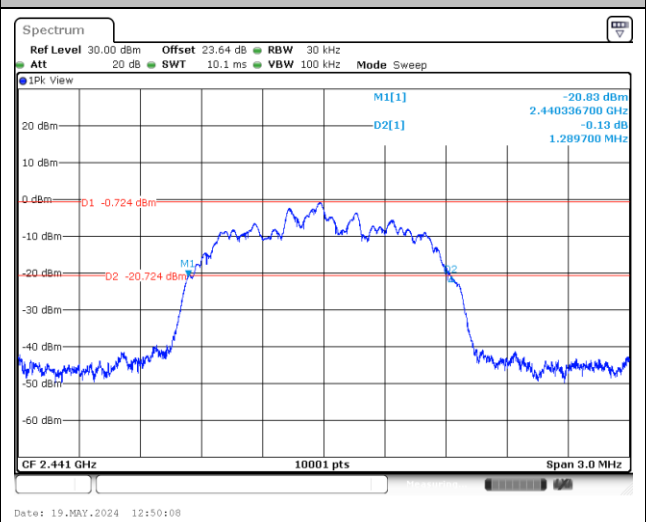

20 dB Bandwidth Plot in Channel 78

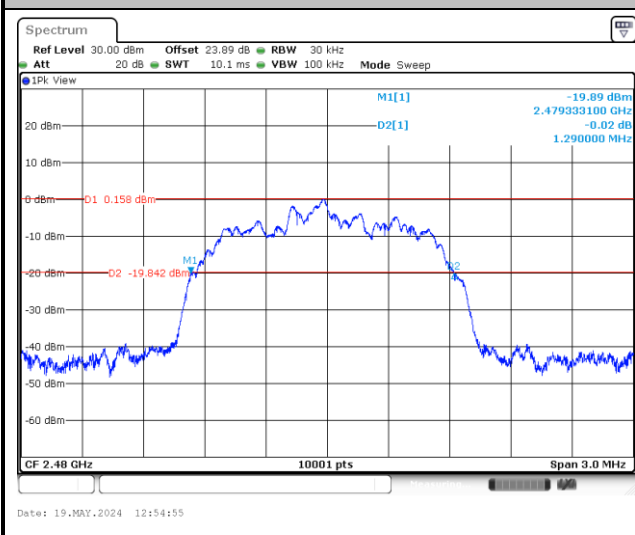



<3Mbps>

20 dB Bandwidth Plot in Channel 00

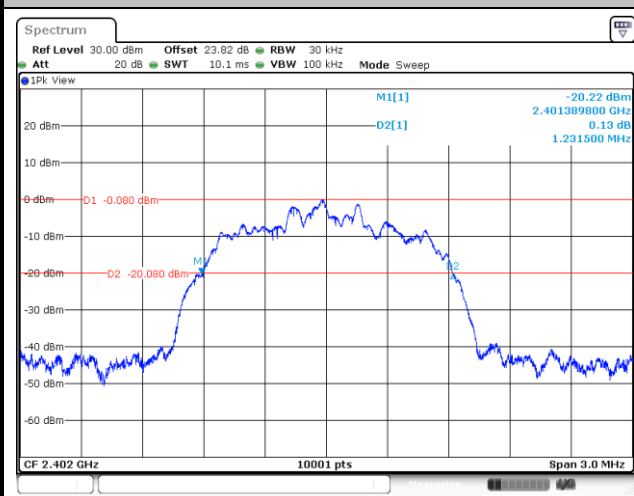

20 dB Bandwidth Plot in Channel 39

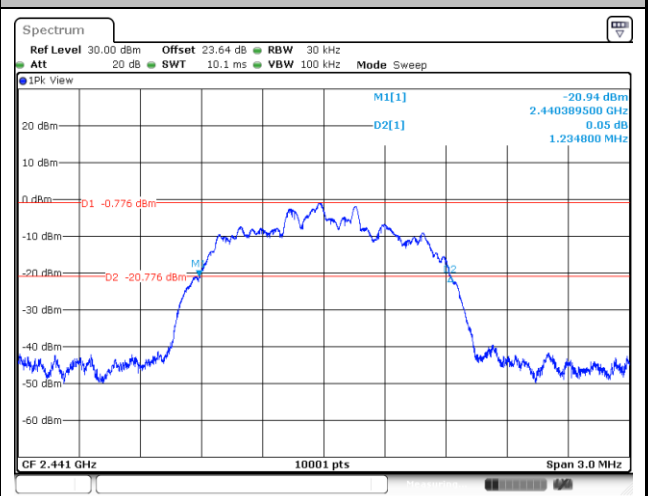

20 dB Bandwidth Plot in Channel 78

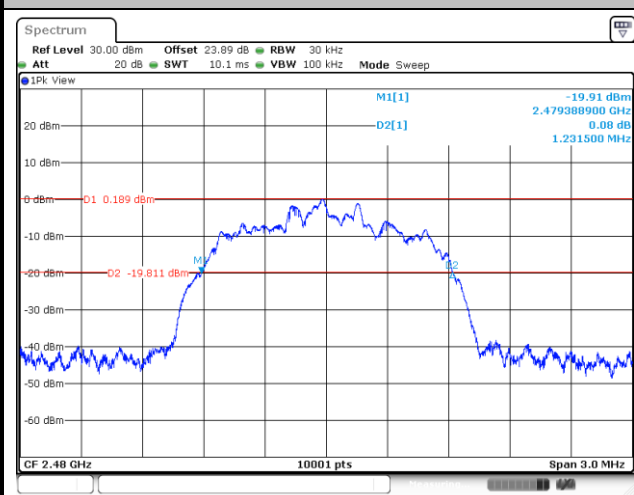





# 99% Occupied Bandwidth

<1Mbps>

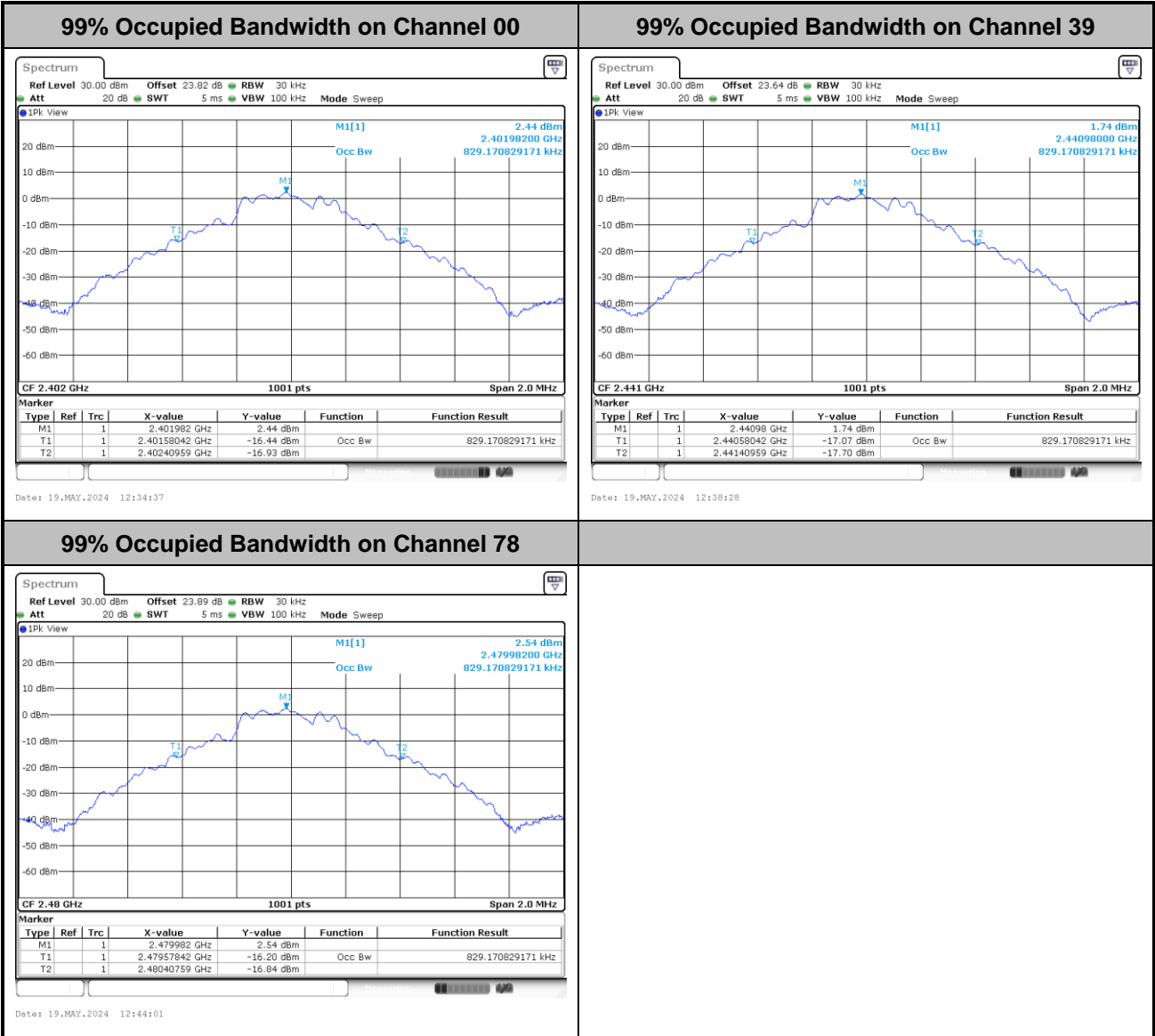



<2Mbps>

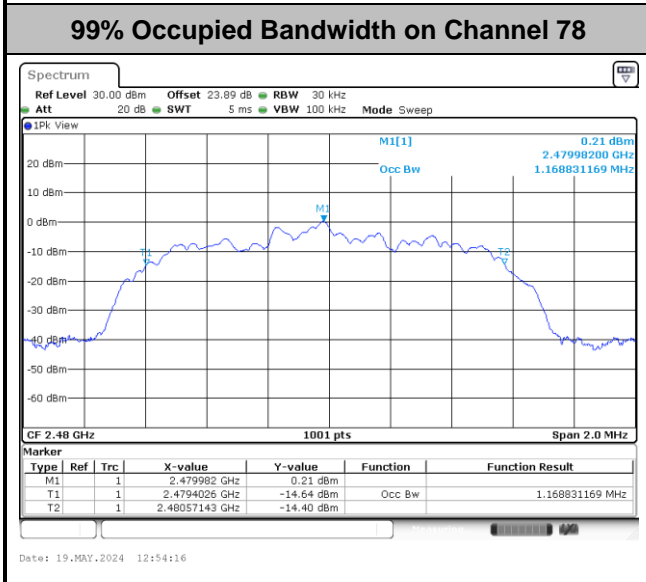
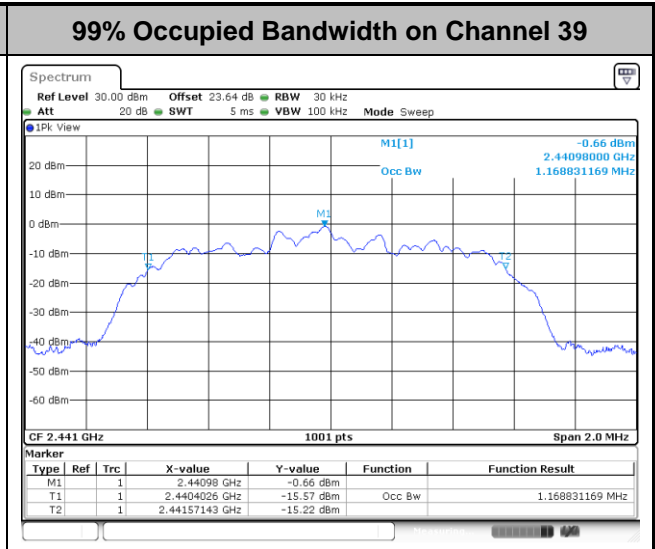
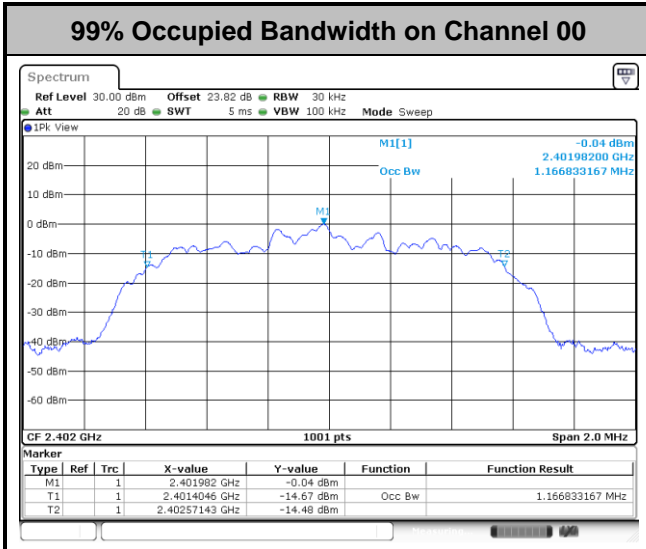



<3Mbps>

99% Occupied Bandwidth on Channel 00

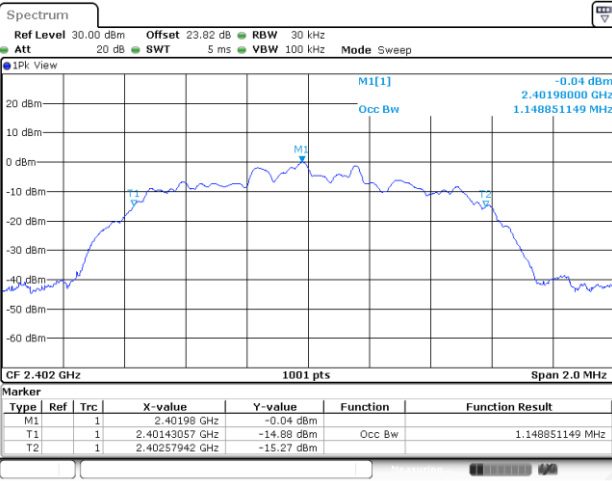

99% Occupied Bandwidth on Channel 39

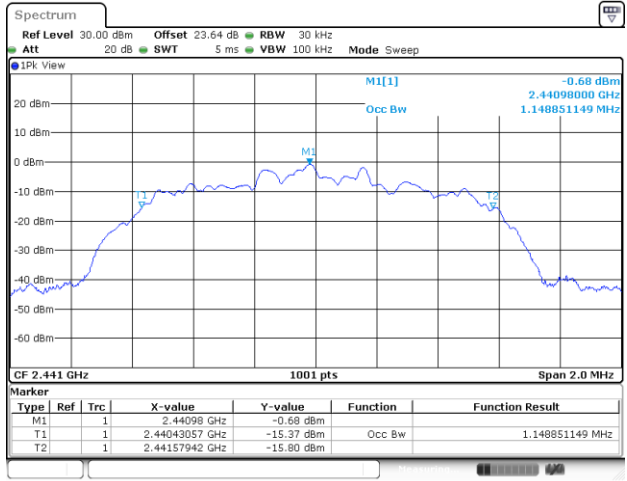

99% Occupied Bandwidth on Channel 78

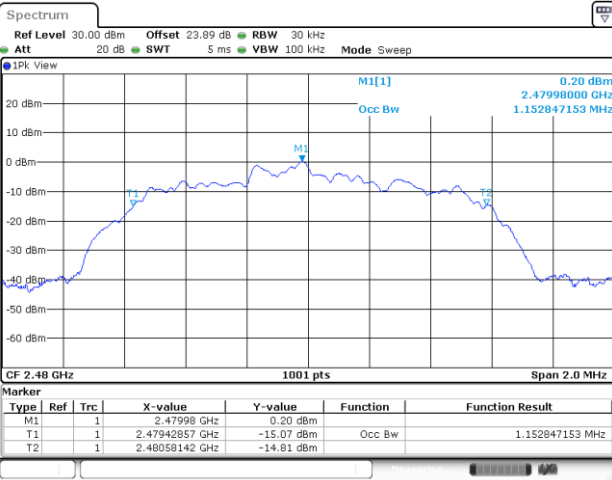



# Band Edges

<1Mbps>

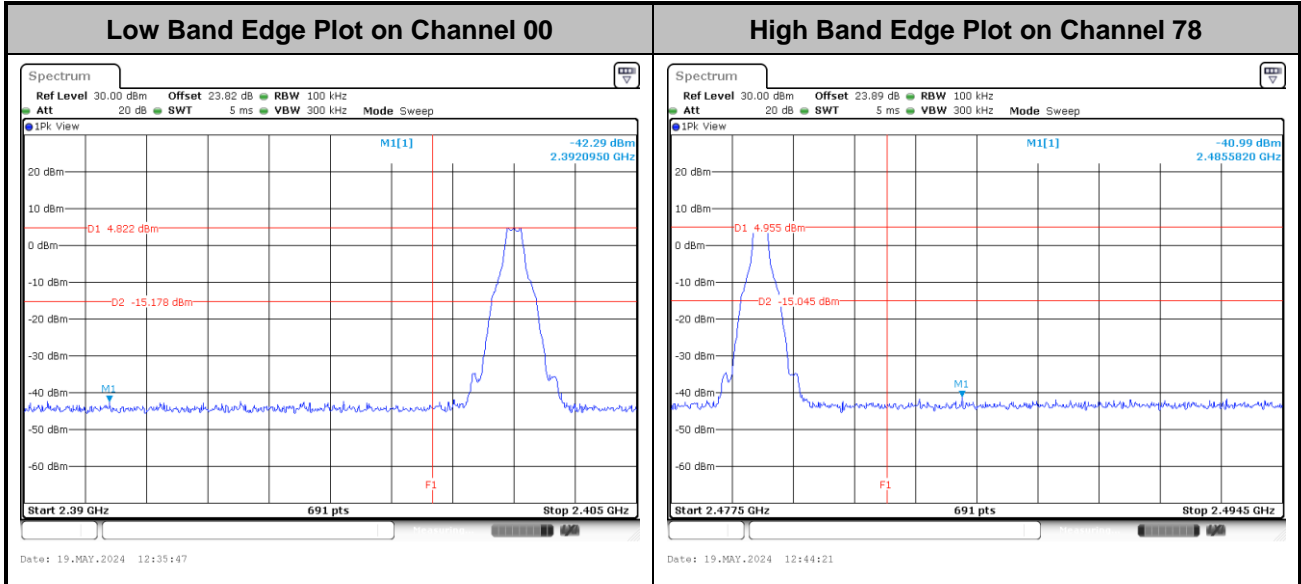

<2Mbps>

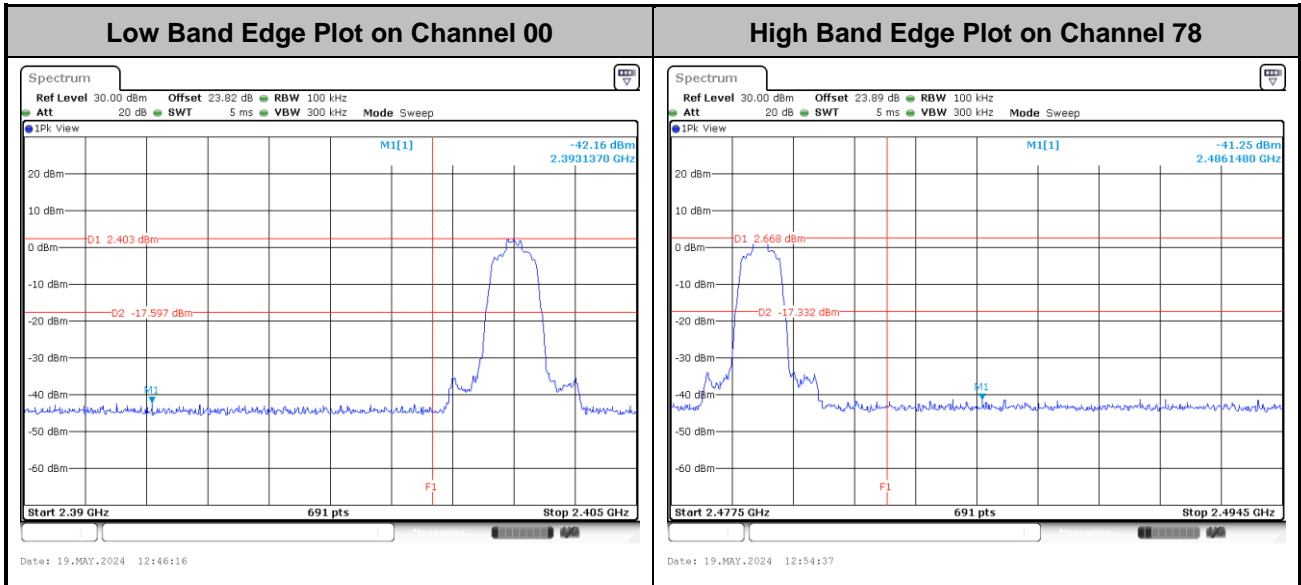



<3Mbps>

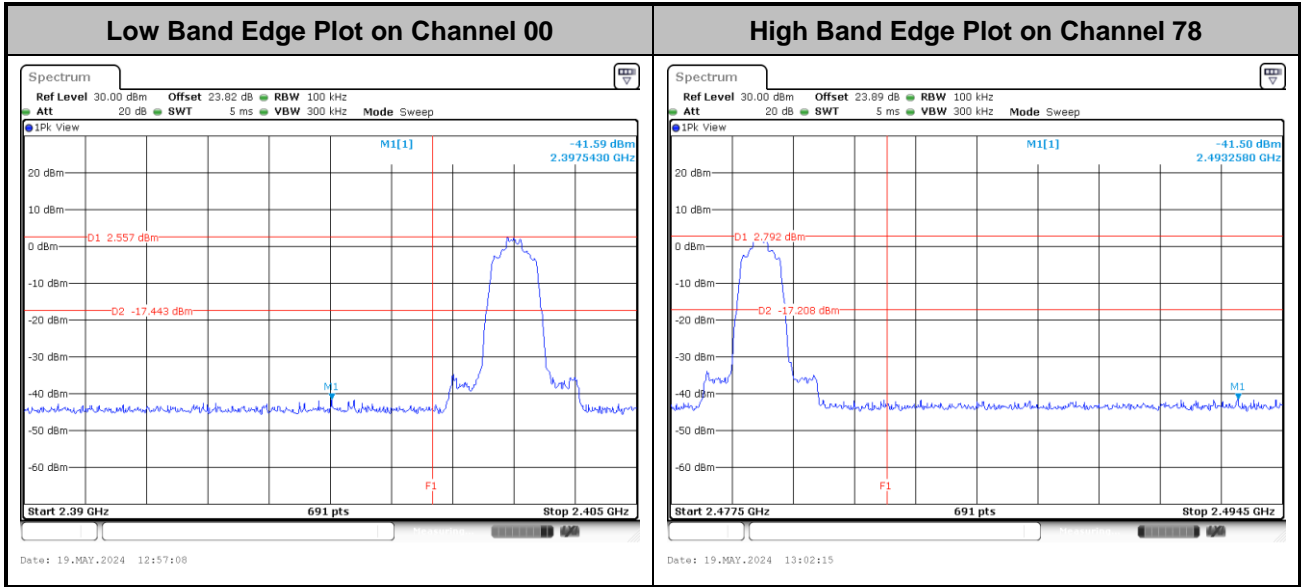



# Hopping Mode Band Edges

<1Mbps>

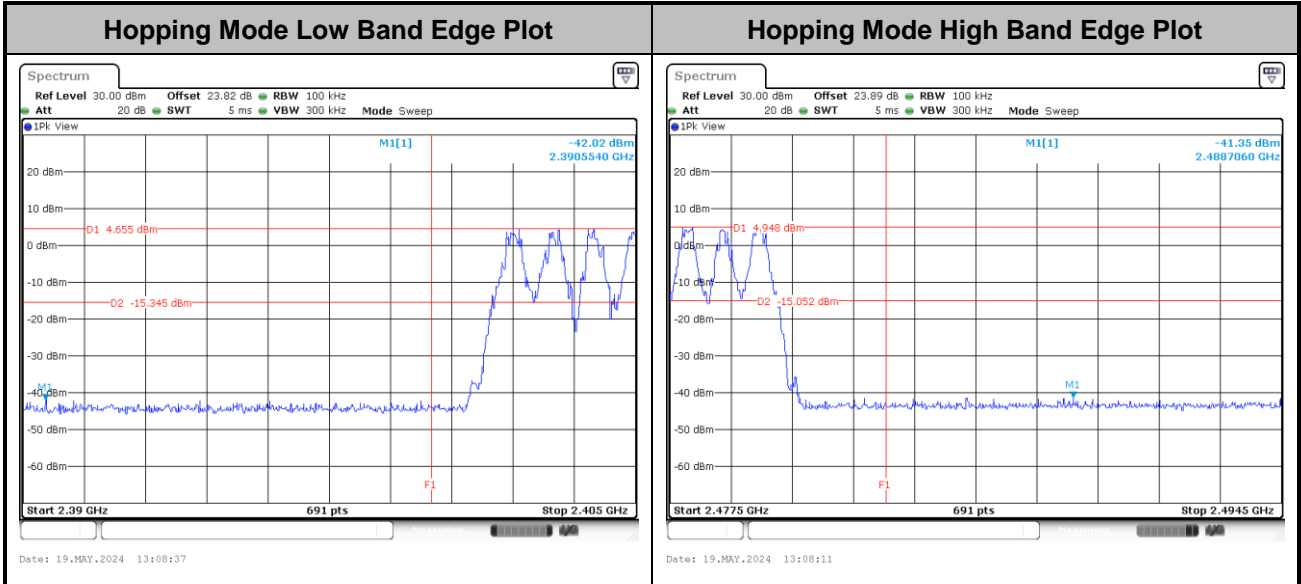

<2Mbps>

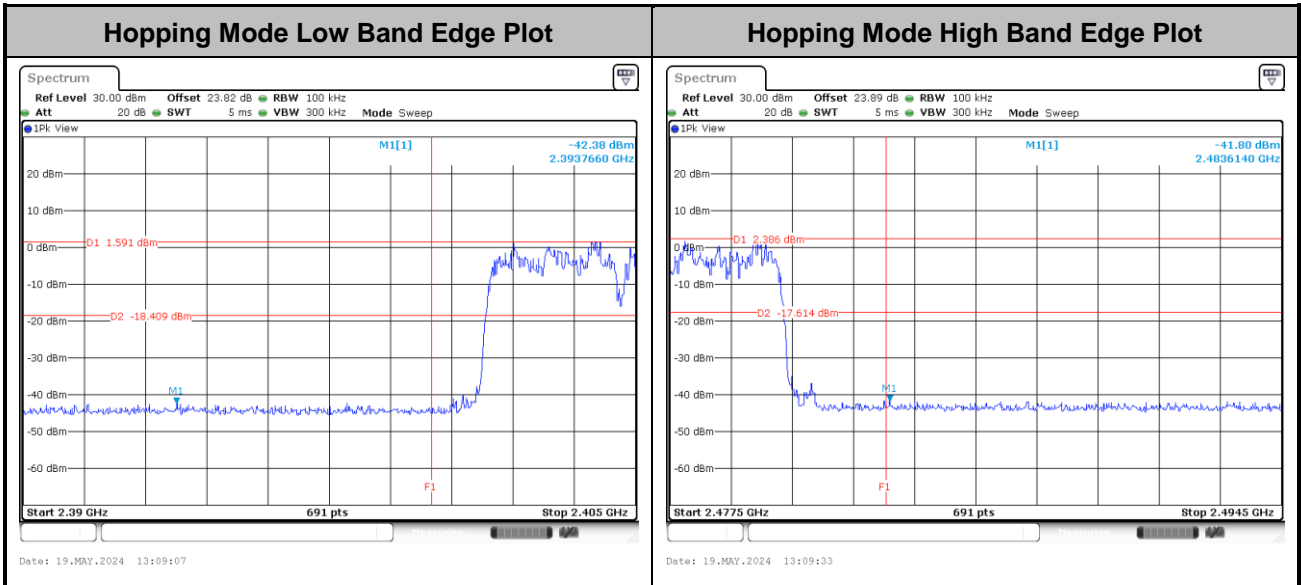



<3Mbps>

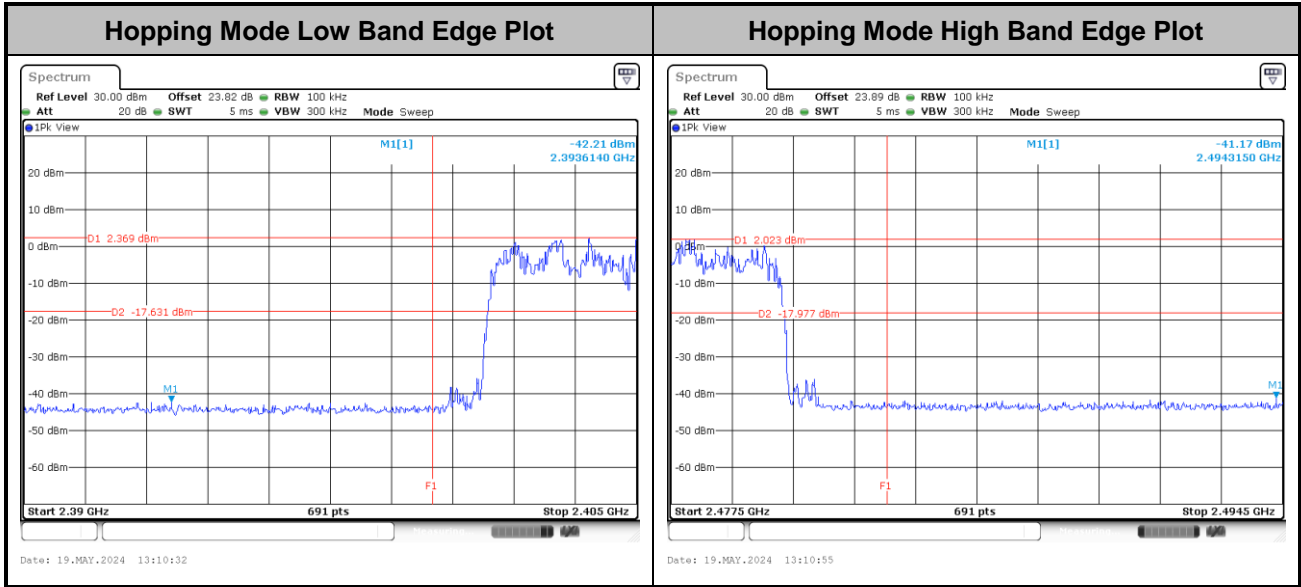



# Conducted Spurious Emission

<1Mbps>

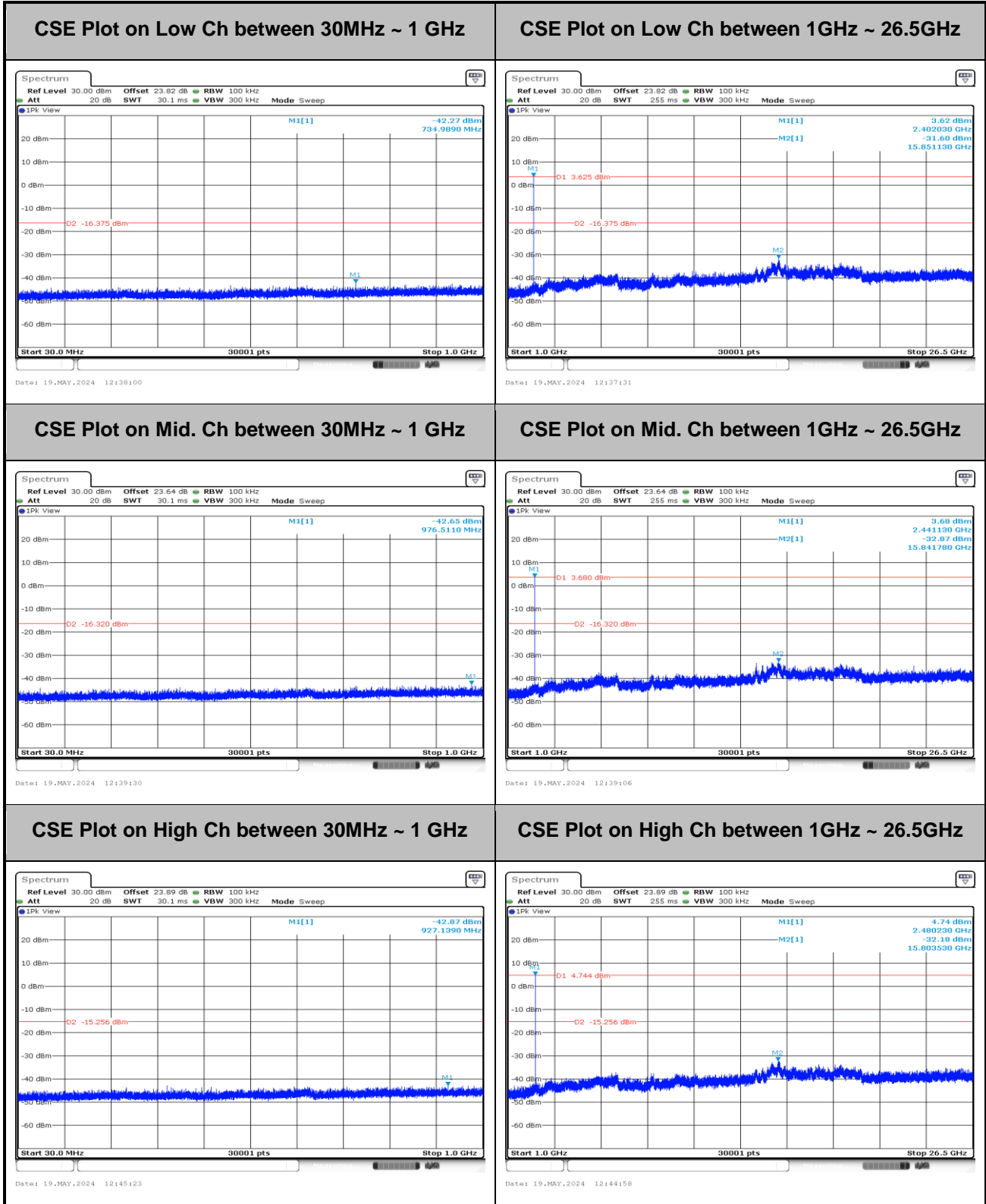





<2Mbps>

CSE Plot on Low Ch between 30MHz ~ 1 GHz

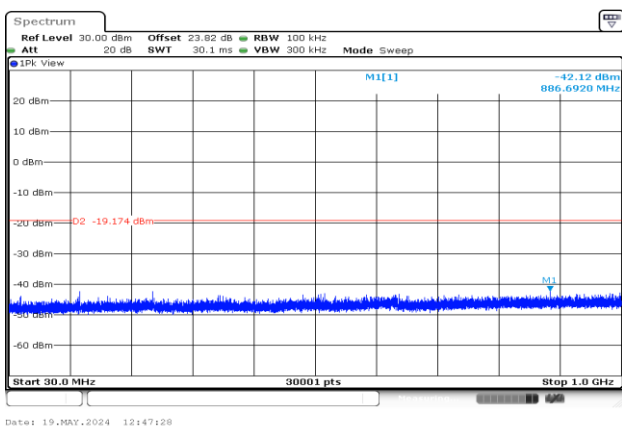

Date: 19.MAY.2024 12:47:28

CSE Plot on Low Ch between 1GHz ~ 26.5GHz

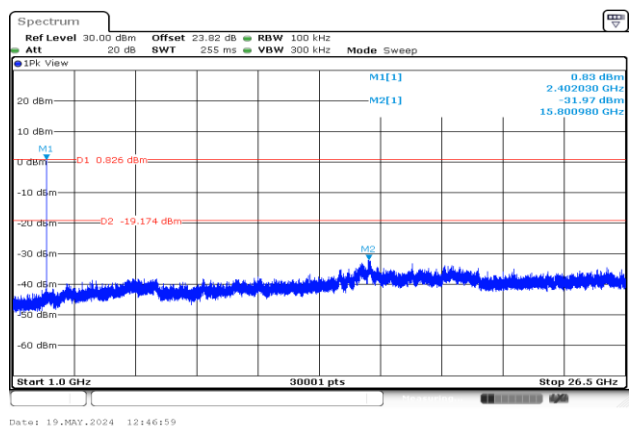

Date: 19.MAY.2024 12:46:59

CSE Plot on Mid. Ch between 30MHz ~ 1 GHz

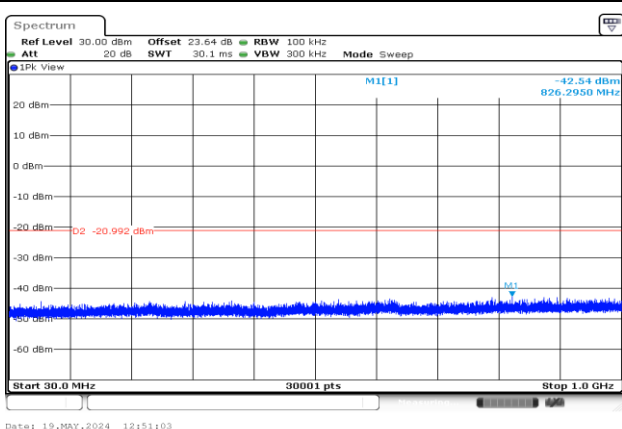

Date: 19.MAY.2024 12:51:03

CSE Plot on Mid. Ch between 1GHz ~ 26.5GHz

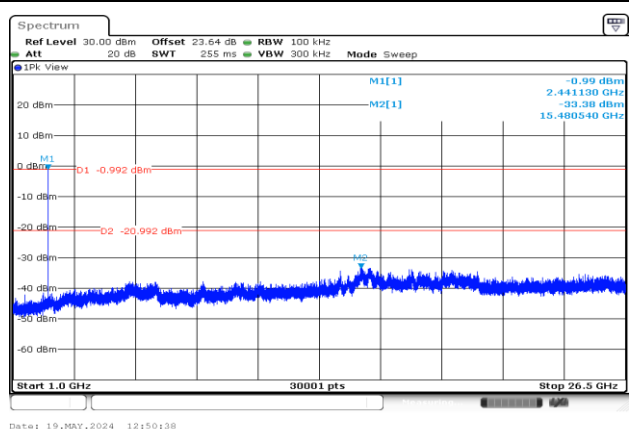

Date: 19.MAY.2024 12:50:38

CSE Plot on High Ch between 30MHz ~ 1 GHz

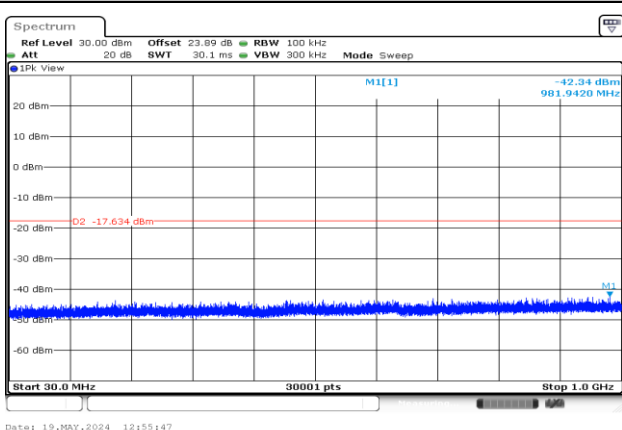

Date: 19.MAY.2024 12:55:47

CSE Plot on High Ch between 1GHz ~ 26.5GHz

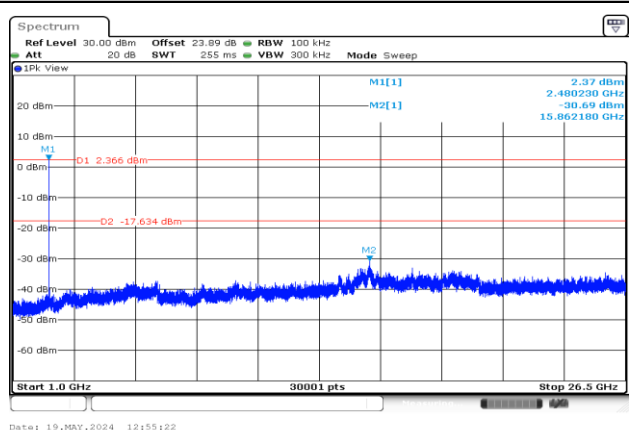

Date: 19.MAY.2024 12:55:28



<3Mbps>

CSE Plot on Low Ch between 30MHz ~ 1 GHz

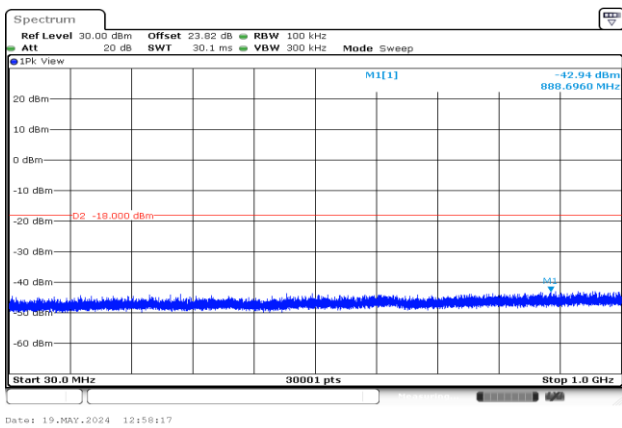

CSE Plot on Low Ch between 1GHz ~ 26.5GHz

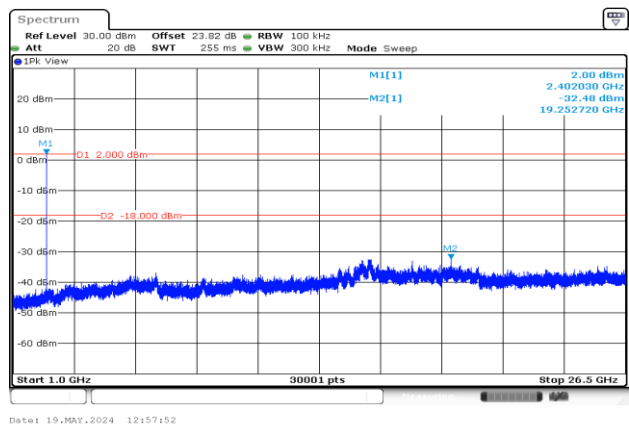

CSE Plot on Mid. Ch between 30MHz ~ 1 GHz

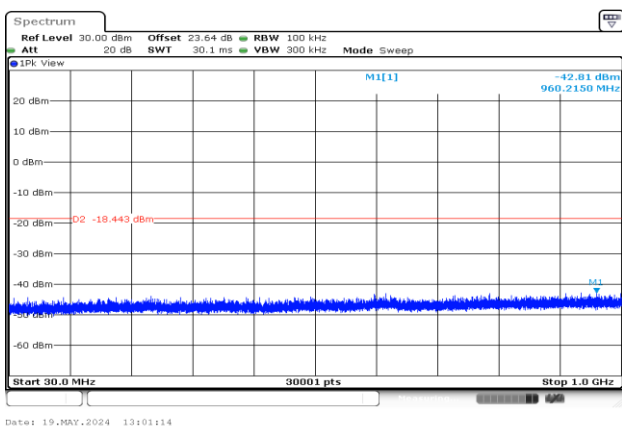

CSE Plot on Mid. Ch between 1GHz ~ 26.5GHz

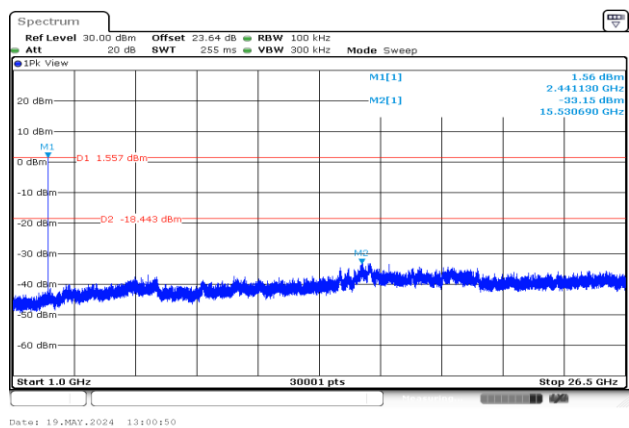

CSE Plot on High Ch between 30MHz ~ 1 GHz

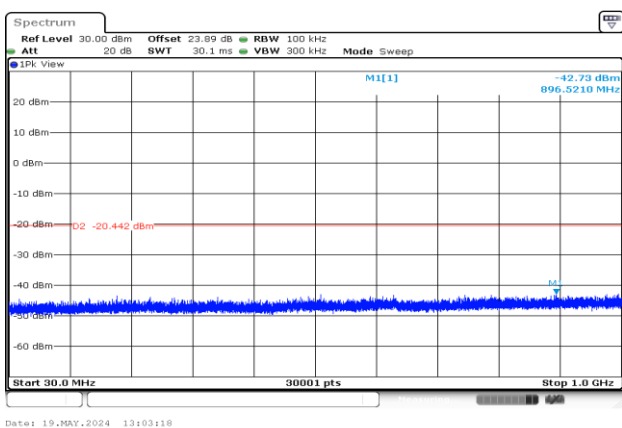

CSE Plot on High Ch between 1GHz ~ 26.5GHz

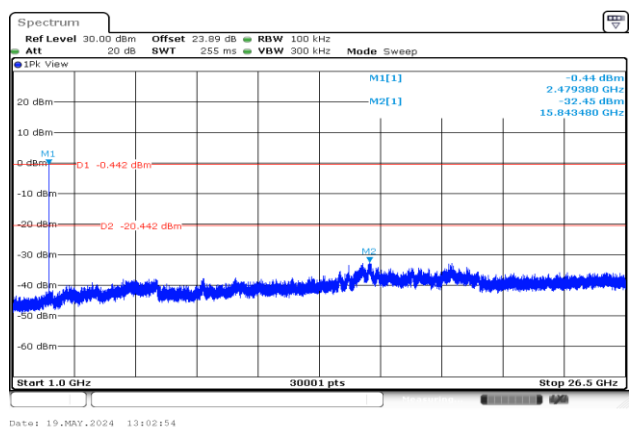



<Ant. 2>

### Number of Hopping Frequency

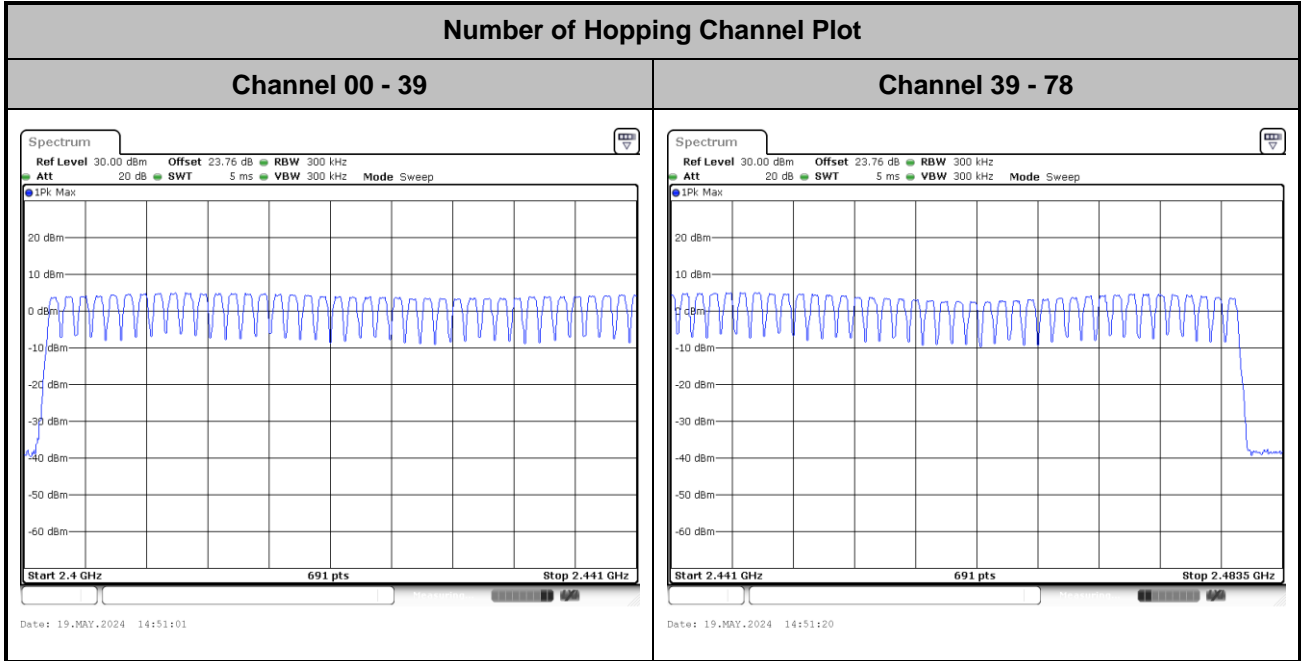



# Hopping Channel Separation

<1Mbps>

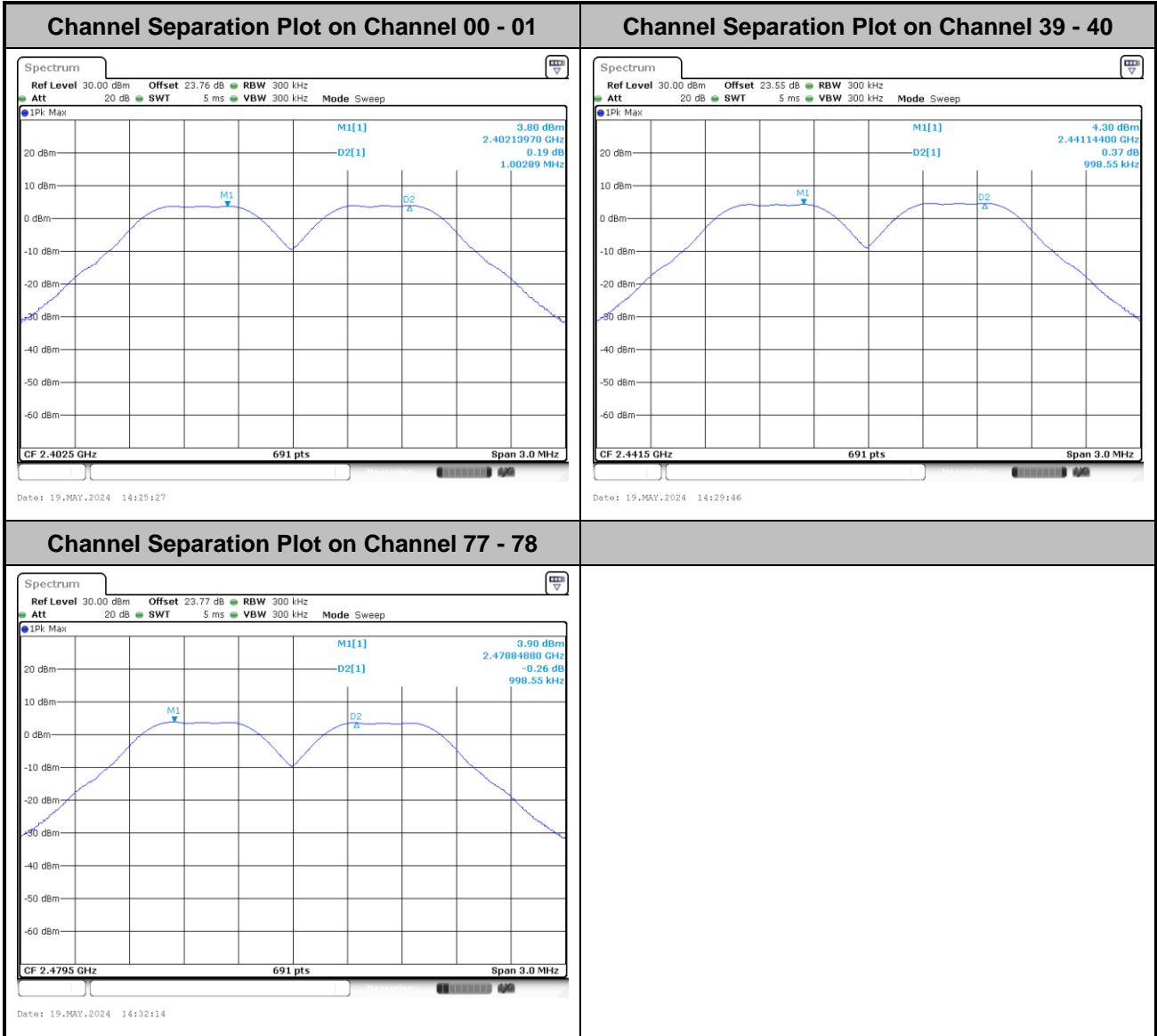



<2Mbps>

Channel Separation Plot on Channel 00 - 01

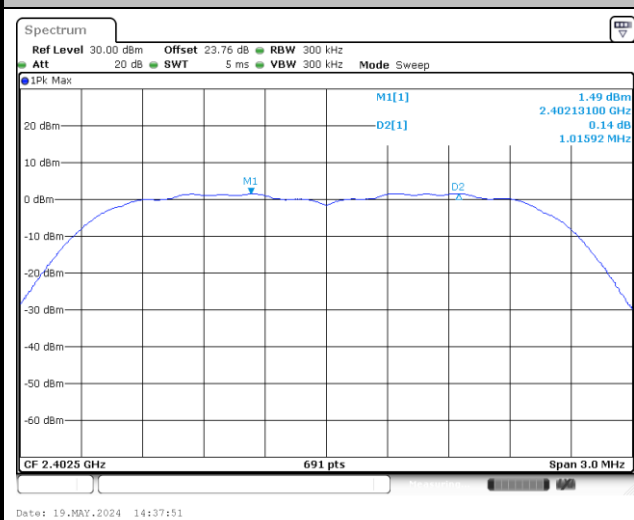

Date: 19.MAY.2024 14:37:51

Channel Separation Plot on Channel 39 - 40

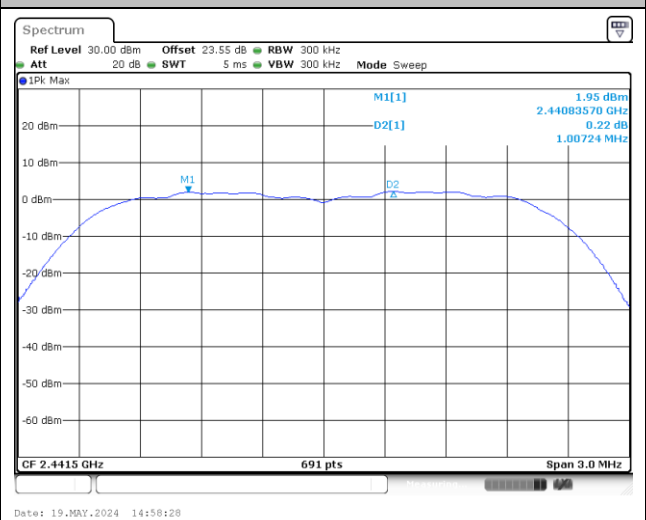

Date: 19.MAY.2024 14:58:28

Channel Separation Plot on Channel 77 - 78

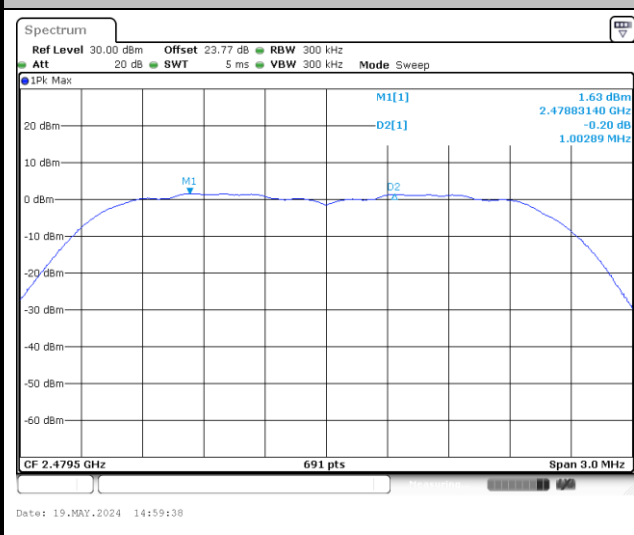

Date: 19.MAY.2024 14:59:38



<3Mbps>

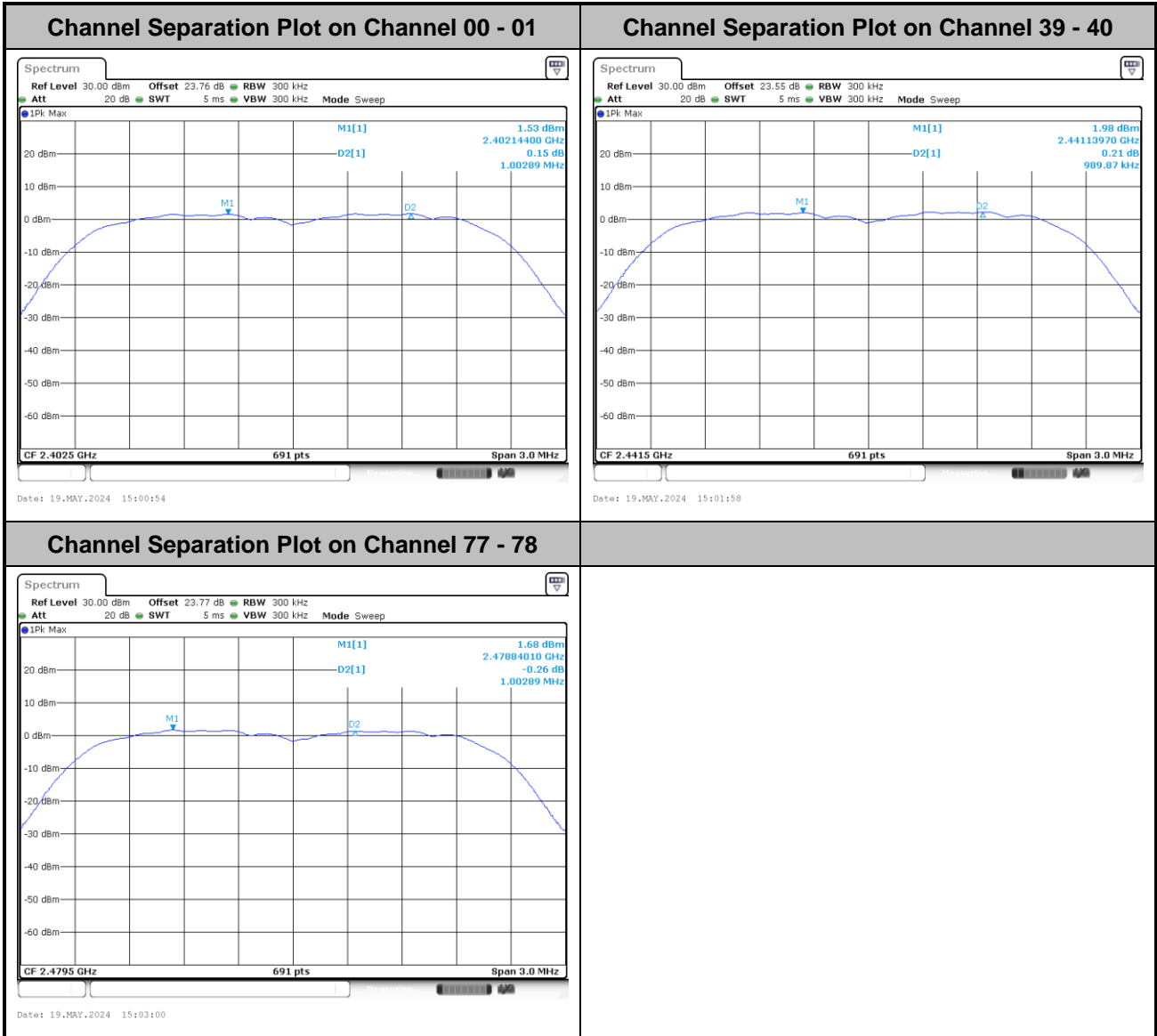



Dwell Time

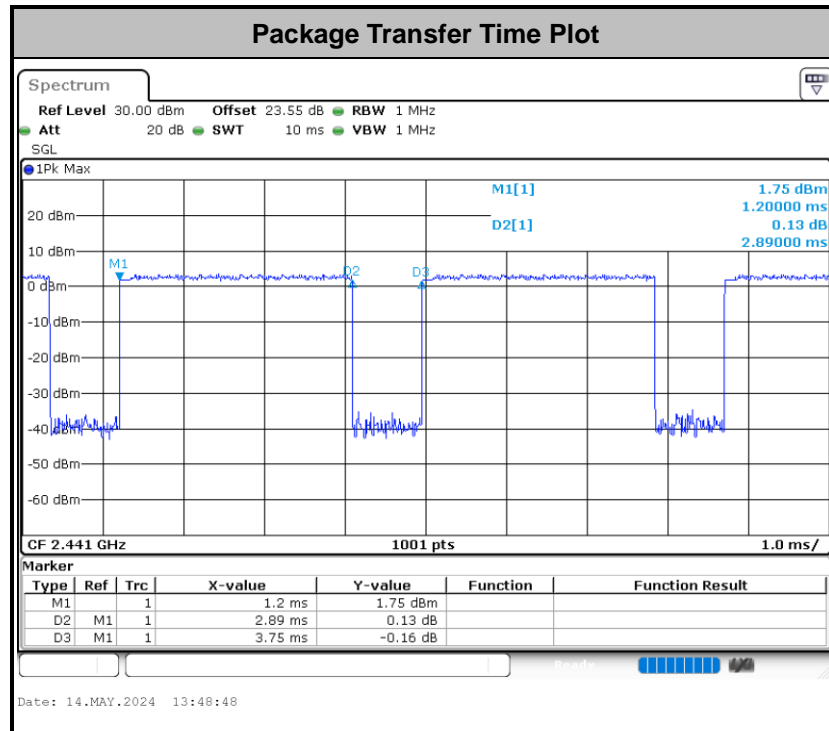

Remark:

1. In normal mode, hopping rate is 1600 hops/s with 6 slots in 79 hopping channels. With channel hopping rate (1600 / 6 / 79) in Occupancy Time Limit (0.4 x 79) (s), Hops Over Occupancy Time comes to (1600 / 6 / 79) x (0.4 x 79) = 106.67 hops.
2. In AFH mode, hopping rate is 800 hops/s with 6 slots in 20 hopping channels. With channel hopping rate (800 / 6 / 20) in Occupancy Time Limit (0.4 x 20) (s), Hops Over Occupancy Time comes to (800 / 6 / 20) x (0.4 x 20) = 53.33 hops.
3. Dwell Time(s) = Hops Over Occupancy Time (hops) x Package Transfer Time



# 20dB Bandwidth

<1Mbps>

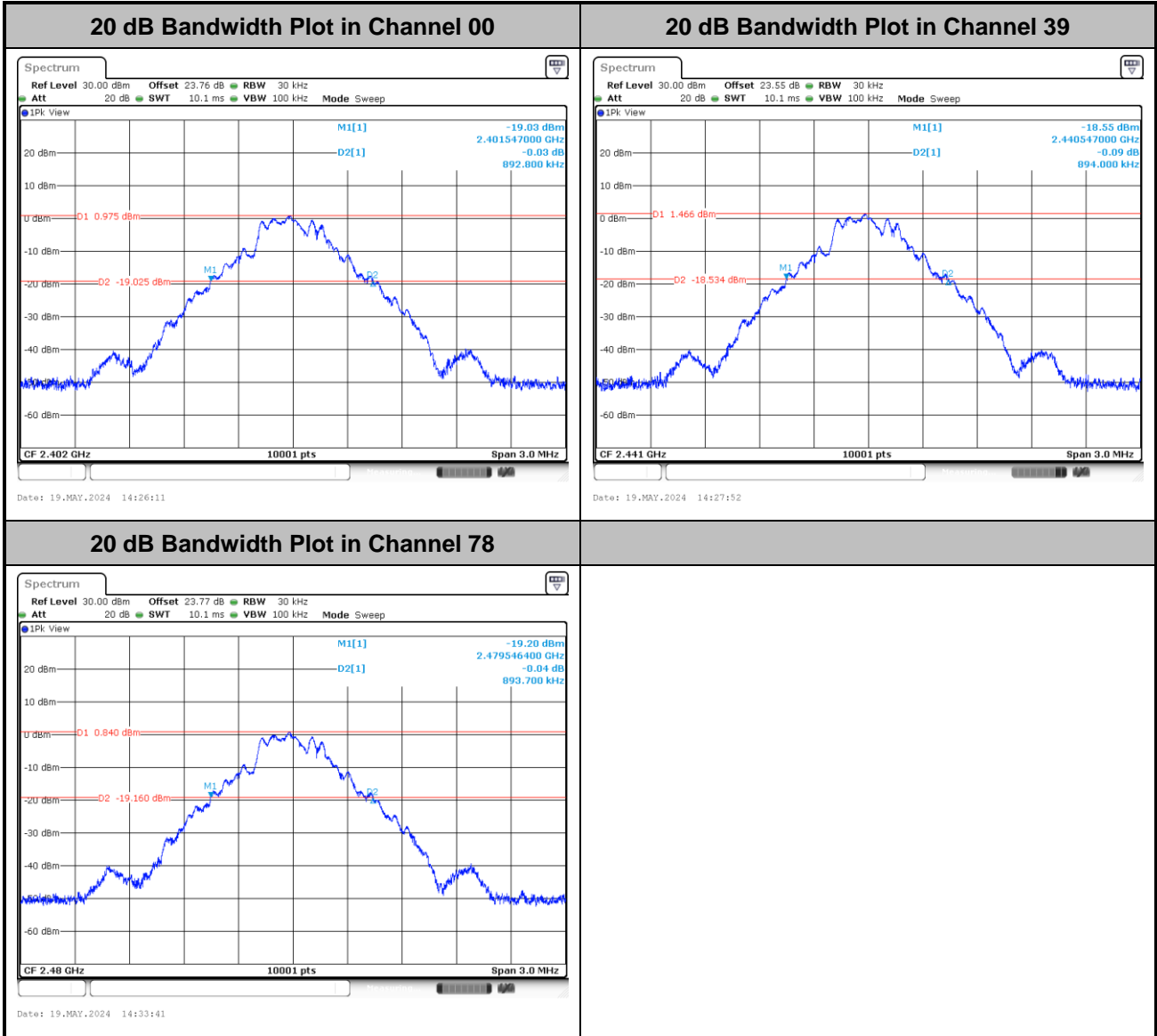





<2Mbps>

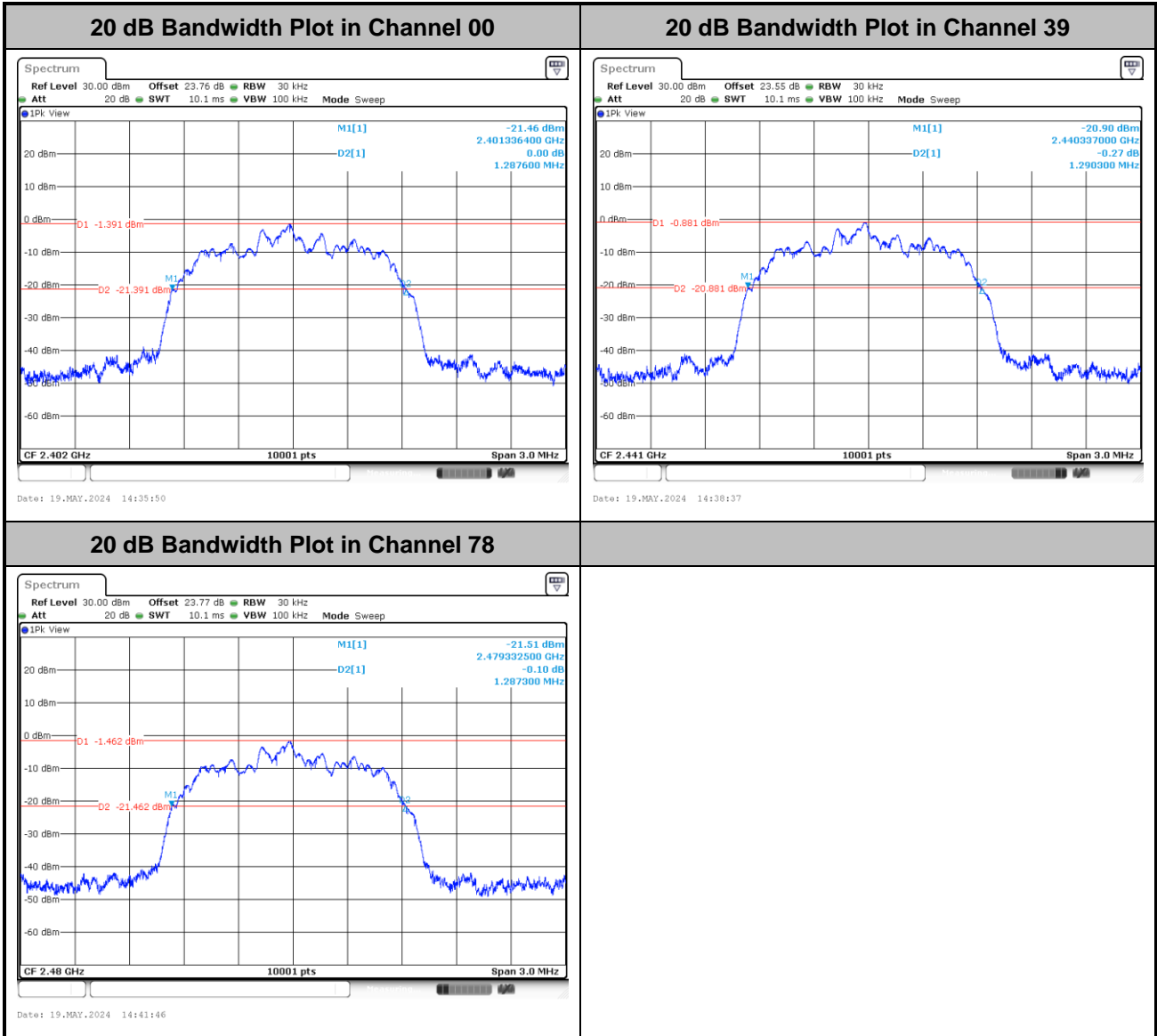



<3Mbps>

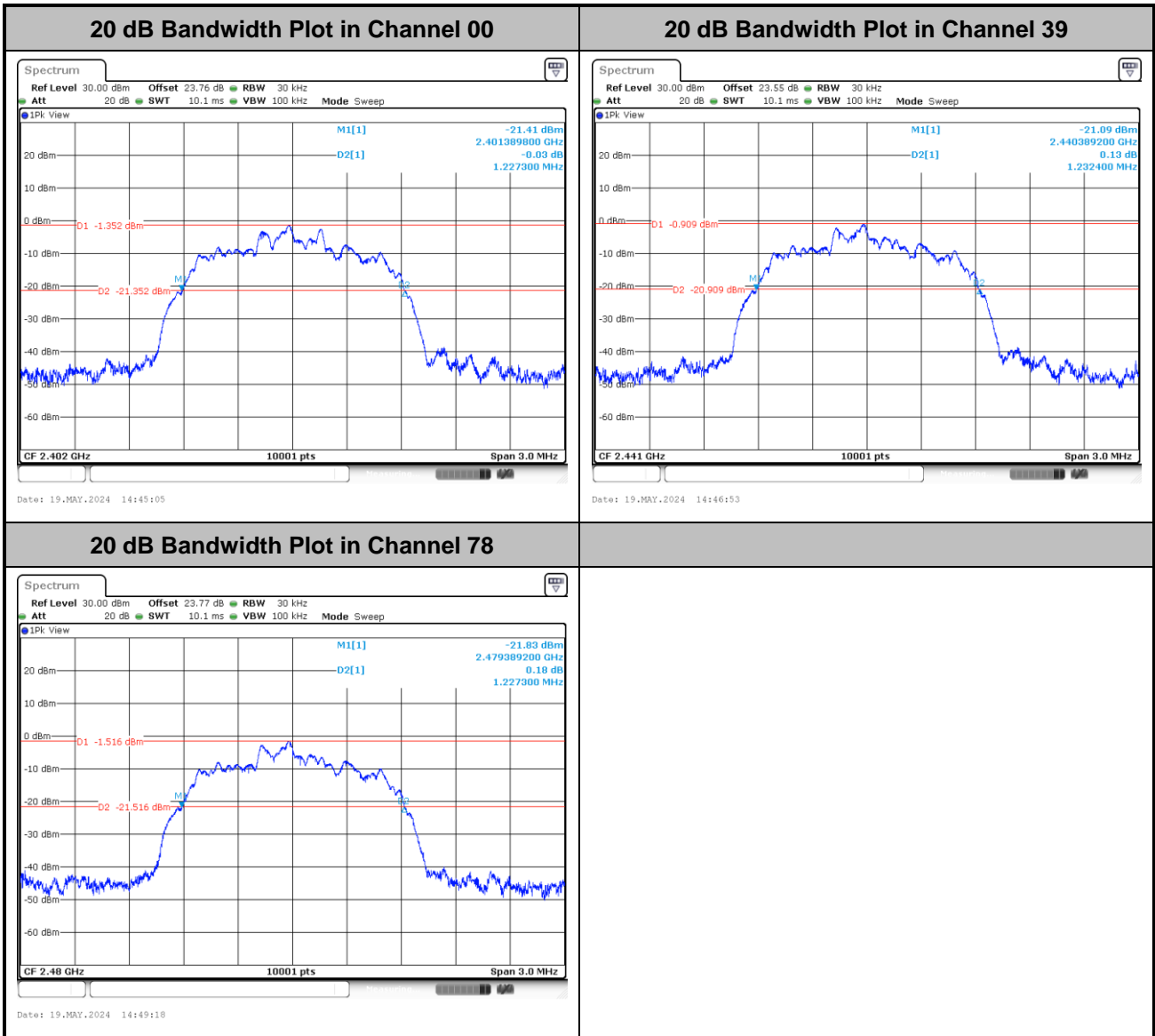



# 99% Occupied Bandwidth

<1Mbps>

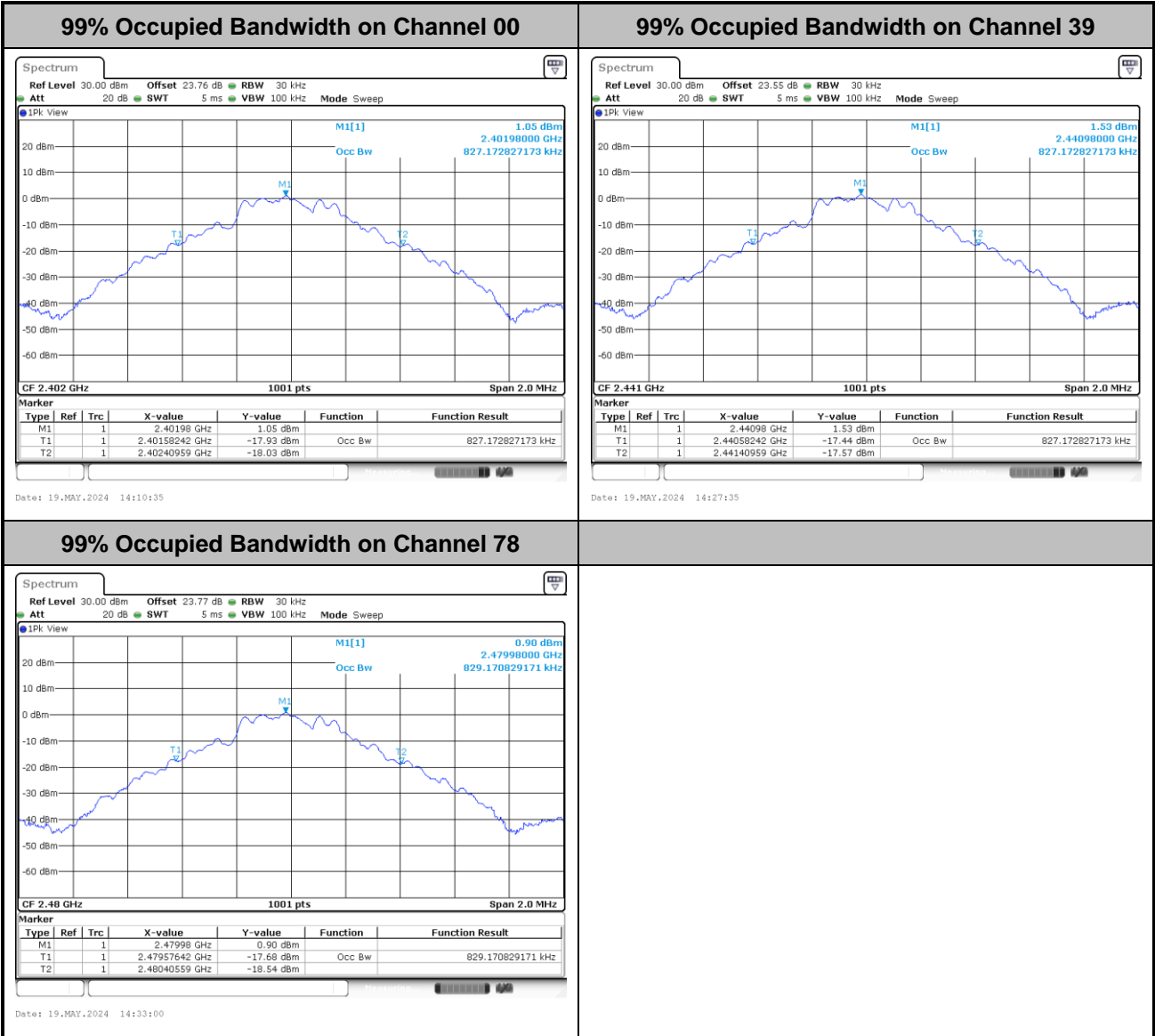



<2Mbps>

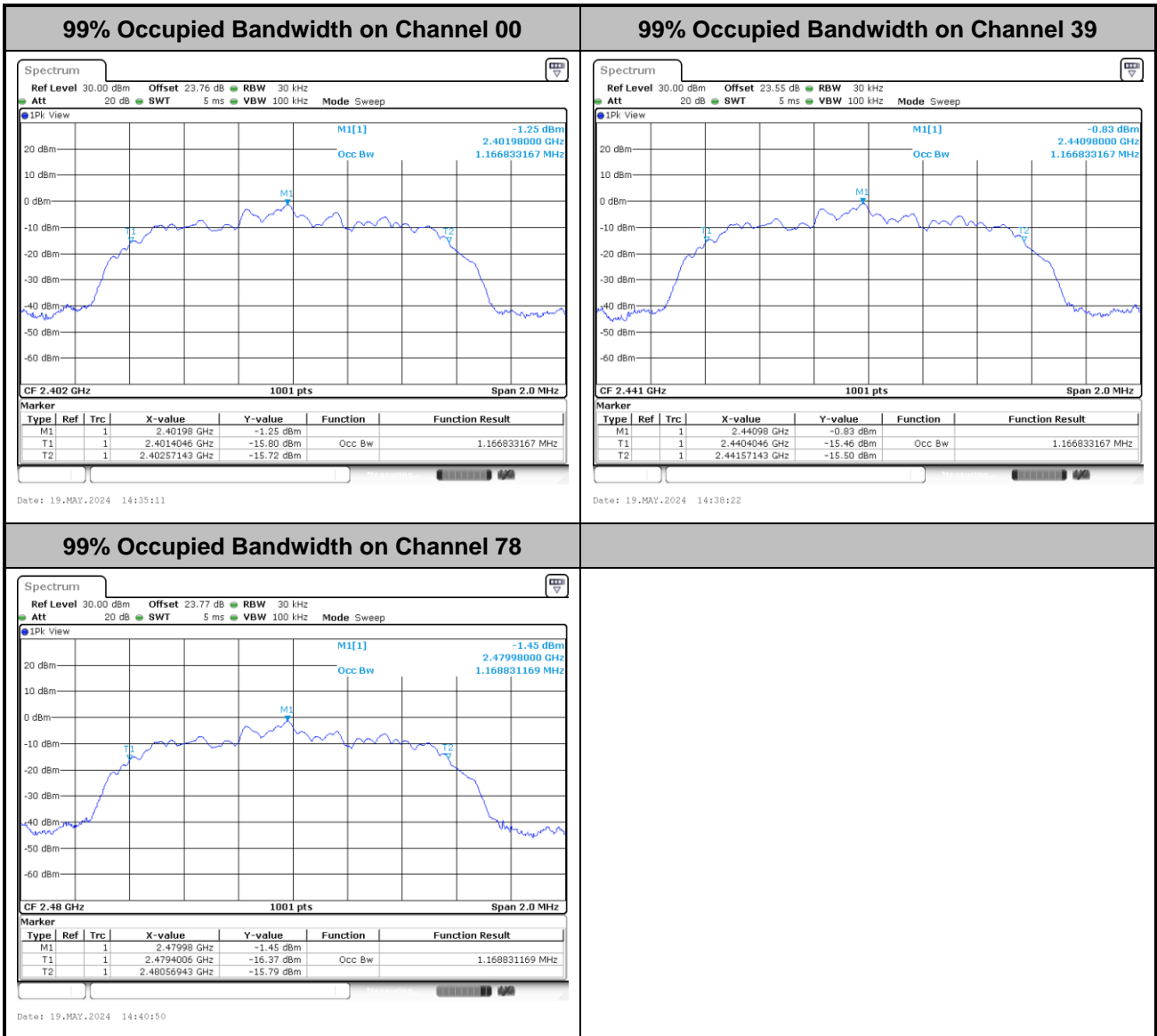



<3Mbps>

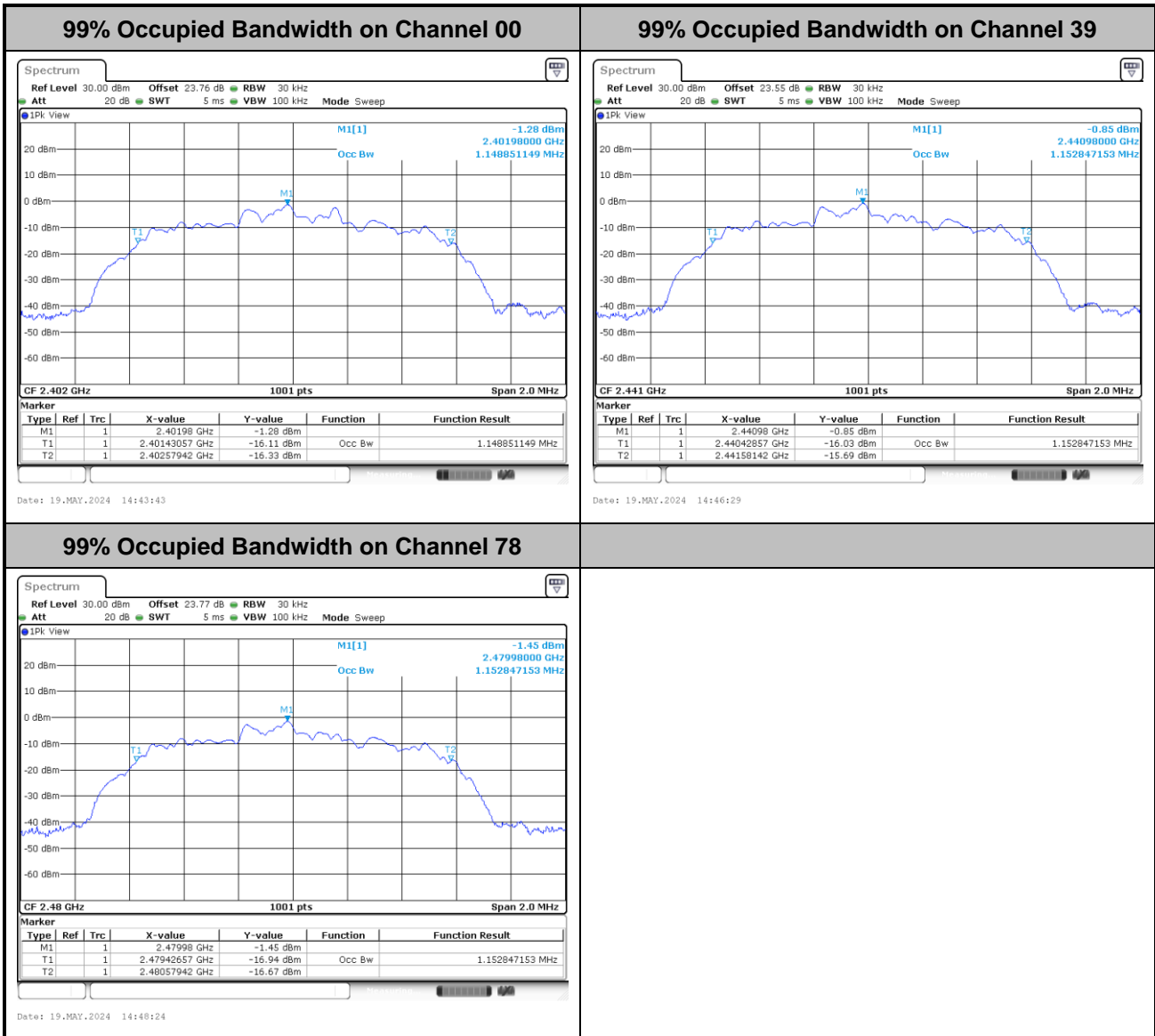



# Band Edges

<1Mbps>

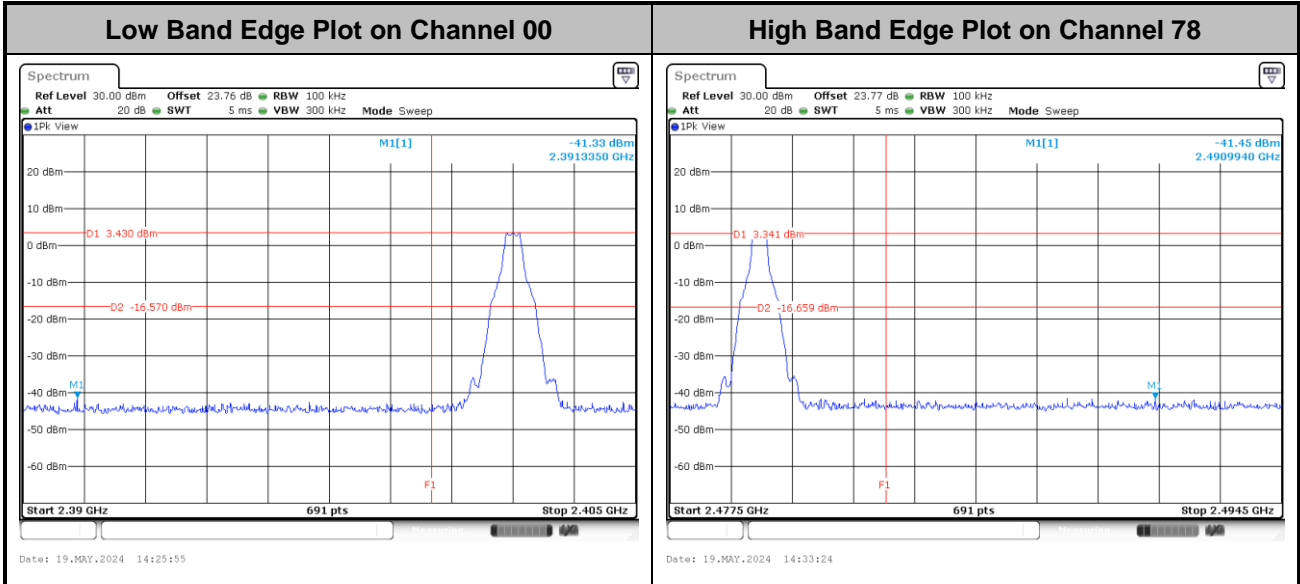

<2Mbps>

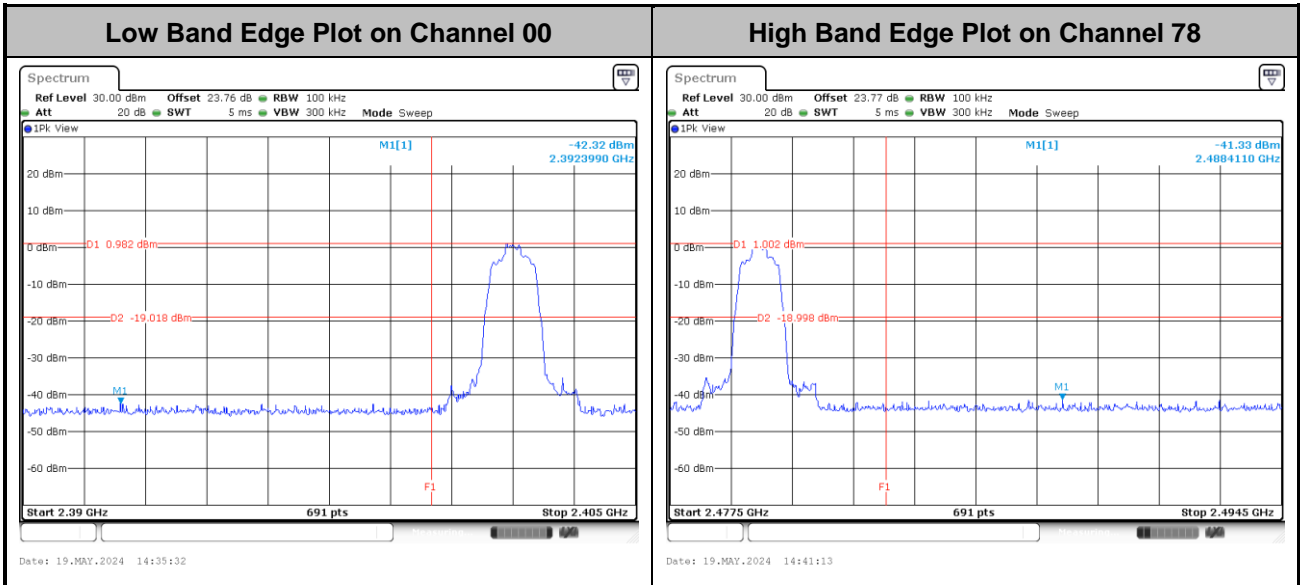



<3Mbps>

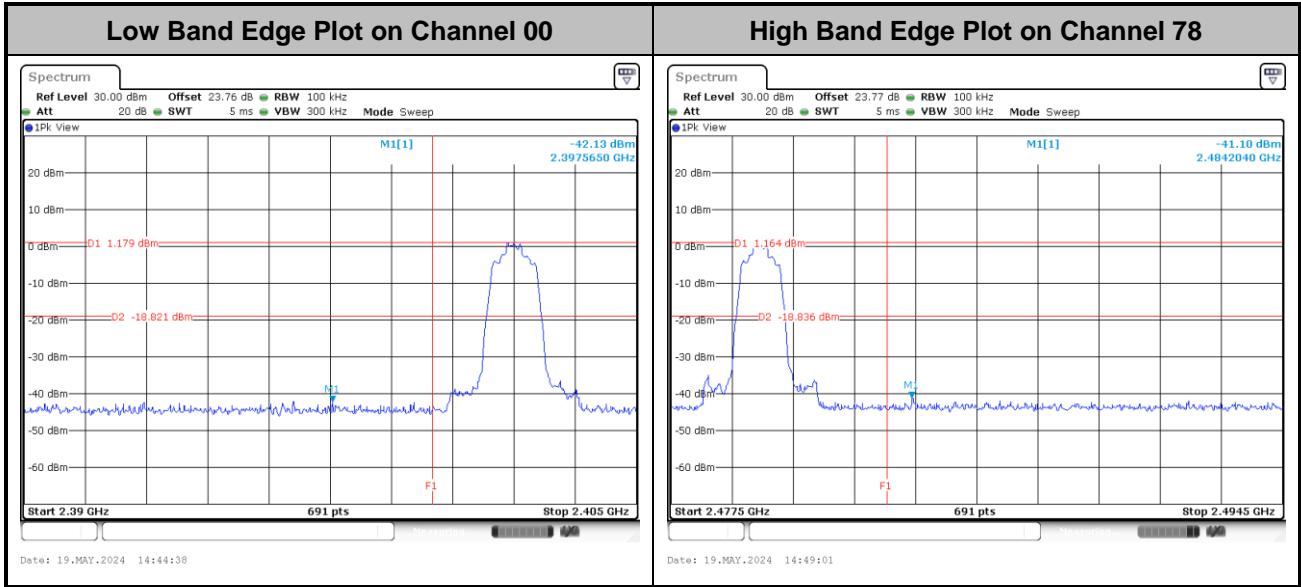



# Hopping Mode Band Edges

<1Mbps>

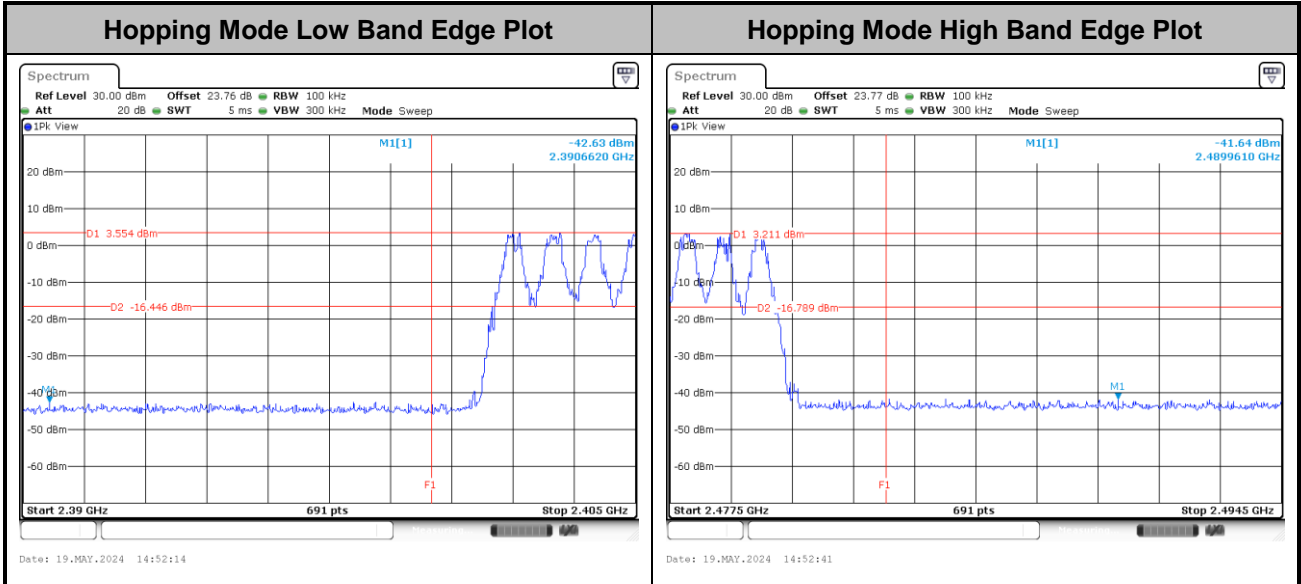

<2Mbps>

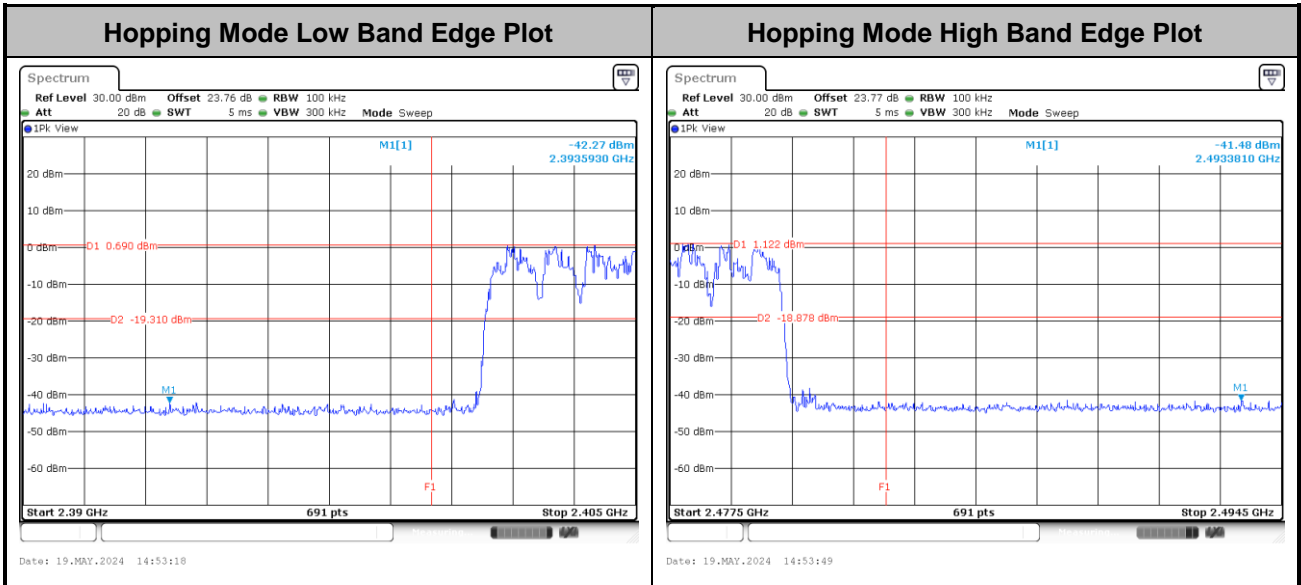





<3Mbps>

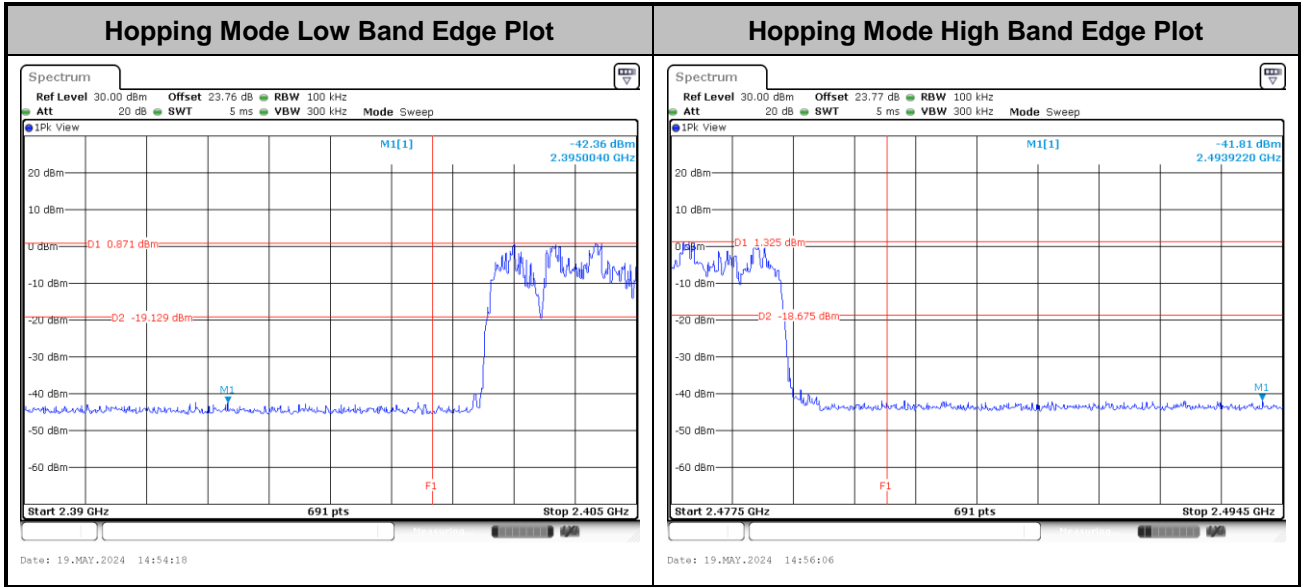



# Conducted Spurious Emission

<1Mbps>

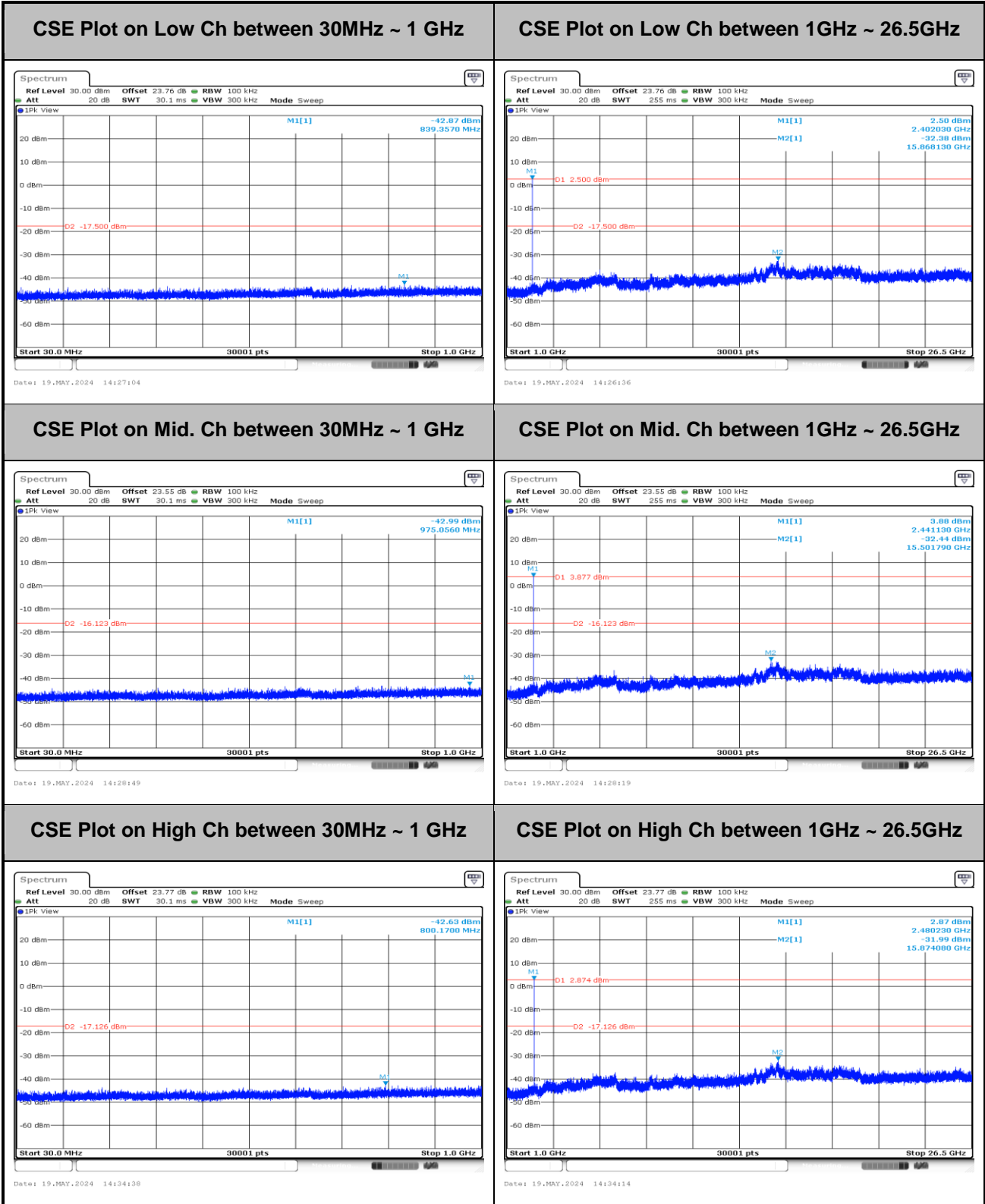



<2Mbps>

