



FCC RF Test Report

APPLICANT : Zebra Technologies Corporation
EQUIPMENT : Enterprise Tablet
BRAND NAME : Zebra
MODEL NAME : ET55BE
FCC ID : UZ7ET55BE
STANDARD : FCC Part 15 Subpart E §15.407
CLASSIFICATION : (NII) Unlicensed National Information Infrastructure

The product was received on May 03, 2016 and testing was completed on Jun. 29, 2016. We, SPORTON INTERNATIONAL INC., would like to declare that the tested sample has been evaluated in accordance with the test procedures and has been in compliance with the applicable technical standards.

The test results in this report apply exclusively to the tested model / sample. Without written approval of SPORTON INTERNATIONAL INC., the test report shall not be reproduced except in full.

Reviewed by: Joseph Lin / Supervisor

Approved by: Jones Tsai / Manager



SPORTON INTERNATIONAL INC.

No. 52, Hwa Ya 1st Rd., Hwa Ya Technology Park, Kwei-Shan District, Tao Yuan City, Taiwan, R.O.C.

SPORTON INTERNATIONAL INC.

TEL : 886-3-327-3456

FAX : 886-3-328-4978

FCC ID : UZ7ET55BE

Page Number : 1 of 49

Report Issued Date : Jul. 01, 2016

Report Version : Rev. 02

Report Template No.: BU5-FR15EWLB4 AC MA Version 1.2



TABLE OF CONTENTS

REVISION HISTORY 3

SUMMARY OF TEST RESULT 4

1 GENERAL DESCRIPTION 5

 1.1 Applicant 5

 1.2 Manufacturer 5

 1.3 Product Feature of Equipment Under Test 5

 1.4 Product Specification of Equipment Under Test 6

 1.5 Modification of EUT 7

 1.6 Testing Location 8

 1.7 Applicable Standards 8

2 TEST CONFIGURATION OF EQUIPMENT UNDER TEST 9

 2.1 Carrier Frequency and Channel 9

 2.2 Pre-Scanned RF Power 10

 2.3 Test Mode 18

 2.4 Connection Diagram of Test System 19

 2.5 Support Unit used in test configuration and system 21

 2.6 EUT Operation Test Setup 21

 2.7 Measurement Results Explanation Example 22

3 TEST RESULT 23

 3.1 6dB and 26dB and 99% Occupied Bandwidth Measurement 23

 3.2 Maximum Conducted Output Power Measurement 28

 3.3 Power Spectral Density Measurement 30

 3.4 Unwanted Emissions Measurement 34

 3.5 AC Conducted Emission Measurement 40

 3.6 Frequency Stability Measurement 44

 3.7 Automatically Discontinue Transmission 45

 3.8 Antenna Requirements 46

4 LIST OF MEASURING EQUIPMENT 48

5 UNCERTAINTY OF EVALUATION 49

APPENDIX A. CONDUCTED TEST RESULTS

APPENDIX B. RADIATED SPURIOUS EMISSION

APPENDIX C. RADIATED SPURIOUS EMISSION PLOTS

APPENDIX D. DUTY CYCLE PLOTS

APPENDIX E. SETUP PHOTOGRAPHS



SUMMARY OF TEST RESULT

Report Section	FCC Rule	Description	Limit	Result	Remark
3.1	15.403(i)	6dB, 26dB and 99% Occupied Bandwidth	> 500kHz	Pass	-
3.2	15.407(a)	Maximum Conducted Output Power	≤ 30 dBm	Pass	-
3.3	15.407(a)	Power Spectral Density	≤ 30 dBm/500kHz	Pass	-
3.4	15.407(b)	Unwanted Emissions	15.407(b)(4)(i) 15.209(a)	Pass	Under limit 1.39 dB at 5648.600 MHz
3.5	15.207	AC Conducted Emission	15.207(a)	Pass	Under limit 15.80 dB at 0.870 MHz
3.6	15.407(g)	Frequency Stability	Within Operation Band	Pass	-
3.7	15.407(c)	Automatically Discontinue Transmission	Discontinue Transmission	Pass	-
3.8	15.203 & 15.407(a)	Antenna Requirement	N/A	Pass	-



1 General Description

1.1 Applicant

Zebra Technologies Corporation
1 Zebra Plaza, Holtsville, NY 11742

1.2 Manufacturer

Zebra Technologies Corporation
1 Zebra Plaza, Holtsville, NY 11742

1.3 Product Feature of Equipment Under Test

Product Feature	
Equipment	Enterprise Tablet
Brand Name	Zebra
Model Name	ET55BE
FCC ID	UZ7ET55BE
Integrated WWAN Module	Brand Name: Sierra Model Name: EM7355 FCC ID: N7NEM7355
EUT supports Radios application	CDMA/EV-DO/GSM/EGPRS/WCDMA/HSPA/LTE/NFC WLAN 11a/b/g/n HT20/HT40 WLAN 11ac VHT20/VHT40/VHT80 Bluetooth v4.0 EDR/LE
HW Version	DV1
SW Version	5.1.1
FW Version	7.35.205.4
MFD	23-Mar-16
EUT Stage	Identical Prototype

Remark: The above EUT's information was declared by manufacturer. Please refer to the specifications or user's manual for more detailed description.



1.4 Product Specification of Equipment Under Test

Standards-related Product Specification	
Tx/Rx Channel Frequency Range	5745 MHz ~ 5825 MHz
Maximum Output Power <<Non-TXBF Modes>	<5745 MHz ~ 5825 MHz> SISO <Ant. Port 1> 802.11a : 11.96 dBm / 0.0157 W 802.11n HT20 : 11.90 dBm / 0.0155 W 802.11n HT40 : 11.92 dBm / 0.0156 W 802.11ac VHT20: 11.91 dBm / 0.0155 W 802.11ac VHT40: 11.94 dBm / 0.0156 W 802.11ac VHT80: 11.44 dBm / 0.0139 W SISO <Ant. Port 2> 802.11a : 12.92 dBm / 0.0196 W 802.11n HT20 : 12.94 dBm / 0.0197 W 802.11n HT40 : 12.95 dBm / 0.0197 W 802.11ac VHT20: 12.94 dBm / 0.0197 W 802.11ac VHT40: 12.96 dBm / 0.0198 W 802.11ac VHT80: 12.30 dBm / 0.0170 W MIMO <Ant. Port 1 + 2> 802.11a : 14.93 dBm / 0.0311 W 802.11n HT20 : 14.84 dBm / 0.0305 W 802.11ac VH40: 14.86 dBm / 0.0306 W 802.11ac VHT20: 14.85 dBm / 0.0305 W 802.11ac VHT40: 14.86 dBm / 0.0306 W 802.11ac VHT80: 14.41 dBm / 0.0276 W
	Maximum Output Power <TXBF Modes> <5745 MHz ~ 5825 MHz> MIMO <Ant. Port 1 + 2> 802.11a : 14.57 dBm / 0.0286 W 802.11n HT20 : 14.61 dBm / 0.0289 W 802.11n HT40 : 14.76 dBm / 0.0299 W 802.11ac VHT20: 14.76 dBm / 0.0299 W 802.11ac VHT40: 14.76 dBm / 0.0299 W 802.11ac VHT80: 14.36 dBm / 0.0273 W



Product Specification subjective to this standard										
99% Occupied Bandwidth <Non-TXBF Modes>	802.11a : 18.45 MHz 802.11n HT20 : 19.05 MHz 802.11n HT40 : 36.80 MHz 802.11ac VHT20 : 19.20 MHz 802.11ac VHT40 : 36.80 MHz 802.11ac VHT80 : 75.84 MHz									
99% Occupied Bandwidth <TXBF Modes>	802.11n HT20 : 19.10 MHz 802.11n HT40 : 36.80 MHz 802.11ac VHT20 : 19.20 MHz 802.11ac VHT40 : 36.80 MHz 802.11ac VHT80 : 76.20 MHz									
Type of Modulation	802.11a/n : OFDM (BPSK / QPSK / 16QAM / 64QAM) 802.11ac : OFDM (BPSK / QPSK / 16QAM / 64QAM / 256QAM)									
Antenna Type	Ceramic Chip Antenna									
Antenna Gain	Main Antenna : 0.50 dBi Aux. Antenna : 0.40 dBi									
Antenna Function Description	<table border="1"> <thead> <tr> <th></th> <th>Ant. 1</th> <th>Ant. 2</th> </tr> </thead> <tbody> <tr> <td>802.11 a/n/ac SISO</td> <td>V</td> <td>V</td> </tr> <tr> <td>802.11 a/n/ac MIMO</td> <td>V</td> <td>V</td> </tr> </tbody> </table>		Ant. 1	Ant. 2	802.11 a/n/ac SISO	V	V	802.11 a/n/ac MIMO	V	V
	Ant. 1	Ant. 2								
802.11 a/n/ac SISO	V	V								
802.11 a/n/ac MIMO	V	V								

1.5 Modification of EUT

No modifications are made to the EUT during all test items.



1.6 Testing Location

Sporton Lab is accredited to ISO 17025 by Taiwan Accreditation Foundation (TAF code : 1190) and the FCC designation No. TW1022 under the FCC 2.948(e) by Mutual Recognition Agreement (MRA) in FCC Test.

Test Site	SPORTON INTERNATIONAL INC.		
Test Site Location	No. 52, Hwa Ya 1 st Rd., Hwa Ya Technology Park, Kwei-Shan District, Tao Yuan City, Taiwan, R.O.C. TEL: +886-3-327-3456 FAX: +886-3-328-4978		
Test Site No.	Sporton Site No.		
	TH02-HY	CO05-HY	03CH07-HY

Note: The test site complies with ANSI C63.4 2014 requirement.

1.7 Applicable Standards

According to the specifications of the manufacturer, the EUT must comply with the requirements of the following standards:

- ♦ FCC Part 15 Subpart E
- ♦ FCC KDB 789033 D02 General UNII Test Procedures New Rules v01r02
- ♦ FCC KDB 662911 D01 Multiple Transmitter Output v02r01.
- ♦ ANSI C63.10-2013

Remark:

1. All test items were verified and recorded according to the standards and without any deviation during the test.
2. This EUT has also been tested and complied with the requirements of FCC Part 15, Subpart B, recorded in a separate test report.



2 Test Configuration of Equipment Under Test

The EUT has been associated with peripherals and configuration operated in a manner tended to maximize its emission characteristics in a typical application. Frequency range investigated: conducted emission (150 kHz to 30 MHz) and radiated emission (9 kHz to the 10th harmonic of the highest fundamental frequency or to 40 GHz, whichever is lower). For radiated measurement, pre-scanned in three orthogonal panels, X, Y, Z. The worst cases (X plane) were recorded in this report.

The final configuration from all the combinations and the worst-case data rates were investigated by measuring the maximum power across all the data rates and modulation modes under section 2.2.

Based on the worst configuration found above, the RF power setting is set individually to meet FCC compliance limit for the final conducted and radiated tests shown in section 2.3.

2.1 Carrier Frequency and Channel

Frequency Band	Channel	Freq. (MHz)	Channel	Freq. (MHz)
5725-5850 MHz Band 4 (U-NII-3)	149	5745	157	5785
	151	5755	159	5795
	153	5765	161	5805
	155	5775	165	5825

Note: The above Frequency and Channel in boldface were 802.11n HT40.



2.2 Pre-Scanned RF Power

Preliminary tests were performed in different data rate and data rate associated with the highest power were chosen for full test in the following tables. Final Output Power equals to Measured Output Power adds the duty factor.

<Non-TXBF Modes>

SISO <Ant. 1>

5GHz 802.11a mode									
Channel	Frequency	Data Rate (MHz)							
		6M bps	9M bps	12M bps	18M bps	24M bps	36M bps	48M bps	54M bps
CH 149	5745 MHz	11.75	11.72	11.74	11.73	10.08	9.96	10.10	10.08
CH 157	5785 MHz	11.96	11.94	11.78	11.74	10.04	9.93	10.26	10.11
CH 165	5825 MHz	11.90	11.88	11.84	11.69	10.10	10.03	10.19	10.02

5GHz 802.11n HT20 mode									
Channel	Frequency	Data Rate (MHz)							
		MCS0	MCS1	MCS2	MCS3	MCS4	MCS5	MCS6	MCS7
CH 149	5745 MHz	11.90	11.86	11.89	10.18	10.29	10.26	10.25	9.29
CH 157	5785 MHz	11.65	11.63	11.60	9.95	9.99	10.07	10.05	9.03
CH 165	5825 MHz	11.81	11.79	11.77	10.10	10.27	10.18	10.20	9.20

5GHz 802.11n HT40 mode									
Channel	Frequency	Data Rate (MHz)							
		MCS0	MCS1	MCS2	MCS3	MCS4	MCS5	MCS6	MCS7
CH 151	5755 MHz	11.90	11.87	11.85	10.76	10.71	10.78	10.79	9.73
CH 159	5795 MHz	11.92	11.91	11.88	10.83	10.83	10.90	10.88	9.80



5GHz 802.11ac VHT20 mode										
Channel	Frequency	Data Rate (MHz)								
		MCS0	MCS1	MCS2	MCS3	MCS4	MCS5	MCS6	MCS7	MCS8
CH 149	5745 MHz	11.91	11.89	11.90	10.31	10.36	10.46	10.16	9.51	9.42
CH 157	5785 MHz	11.73	11.71	11.67	10.13	10.09	10.30	9.86	9.40	9.33
CH 165	5825 MHz	11.76	11.72	11.75	10.24	10.29	10.36	10.06	9.46	9.43

5GHz 802.11ac VHT40 mode											
Channel	Frequency	Data Rate (MHz)									
		MCS0	MCS1	MCS2	MCS3	MCS4	MCS5	MCS6	MCS7	MCS8	MCS9
CH 151	5755 MHz	11.94	11.93	11.90	10.81	10.83	10.79	10.75	9.86	9.21	8.80
CH 159	5795 MHz	11.91	11.86	11.81	10.70	10.78	10.74	10.64	9.80	9.13	8.69

5GHz 802.11ac VHT80 mode											
Channel	Frequency	Data Rate (MHz)									
		MCS0	MCS1	MCS2	MCS3	MCS4	MCS5	MCS6	MCS7	MCS8	MCS9
CH 155	5775 MHz	11.44	11.41	11.43	11.37	11.41	11.42	11.38	10.73	9.05	8.94



SISO <Ant. 2>

5GHz 802.11a mode									
Channel	Frequency	Data Rate (MHz)							
		6M bps	9M bps	12M bps	18M bps	24M bps	36M bps	48M bps	54M bps
CH 149	5745 MHz	12.73	12.71	12.70	12.67	11.06	11.16	11.01	11.15
CH 157	5785 MHz	12.90	12.85	12.87	12.84	11.26	11.34	11.11	11.31
CH 165	5825 MHz	12.92	12.83	12.88	12.86	11.20	11.25	11.07	11.22

5GHz 802.11n HT20 mode									
Channel	Frequency	Data Rate (MHz)							
		MCS0	MCS1	MCS2	MCS3	MCS4	MCS5	MCS6	MCS7
CH 149	5745 MHz	12.93	12.90	12.88	11.49	11.37	11.39	11.35	10.36
CH 157	5785 MHz	12.92	12.87	12.83	11.48	11.40	11.29	11.19	10.32
CH 165	5825 MHz	12.94	12.93	12.91	11.59	11.49	11.40	11.39	10.40

5GHz 802.11n HT40 mode									
Channel	Frequency	Data Rate (MHz)							
		MCS0	MCS1	MCS2	MCS3	MCS4	MCS5	MCS6	MCS7
CH 151	5755 MHz	12.86	12.81	12.79	11.76	11.66	11.57	11.65	10.51
CH 159	5795 MHz	12.95	12.89	12.90	11.85	11.73	11.69	11.68	10.53



5GHz 802.11ac VHT20 mode										
Channel	Frequency	Data Rate (MHz)								
		MCS0	MCS1	MCS2	MCS3	MCS4	MCS5	MCS6	MCS7	MCS8
CH 149	5745 MHz	12.88	12.82	12.78	11.26	11.27	11.44	11.43	10.22	10.36
CH 157	5785 MHz	12.92	12.86	12.88	11.34	11.38	11.59	11.48	10.30	10.40
CH 165	5825 MHz	12.94	12.89	12.93	11.38	11.46	11.65	11.50	10.38	10.44

5GHz 802.11ac VHT40 mode											
Channel	Frequency	Data Rate (MHz)									
		MCS0	MCS1	MCS2	MCS3	MCS4	MCS5	MCS6	MCS7	MCS8	MCS9
CH 151	5755 MHz	12.86	12.70	12.67	11.28	11.18	11.23	11.26	10.24	12.57	9.46
CH 159	5795 MHz	12.96	12.82	12.75	11.37	11.31	11.32	11.35	10.37	12.72	9.59

5GHz 802.11ac VHT80 mode											
Channel	Frequency	Data Rate (MHz)									
		MCS0	MCS1	MCS2	MCS3	MCS4	MCS5	MCS6	MCS7	MCS8	MCS9
CH 155	5775 MHz	12.30	12.28	12.25	12.23	12.17	12.27	12.26	11.53	9.63	9.65



MIMO <Ant. 1+2>

5GHz 802.11a mode									
Channel	Frequency	Data Rate (MHz)							
		6M bps	9M bps	12M bps	18M bps	24M bps	36M bps	48M bps	54M bps
CH 149	5745 MHz	14.78	14.71	14.76	14.75	12.88	12.90	13.02	13.02
CH 157	5785 MHz	14.93	14.83	14.90	14.88	12.99	13.06	13.10	13.08
CH 165	5825 MHz	14.82	14.75	14.79	14.78	12.92	12.92	13.02	12.99

5GHz 802.11n HT20 mode									
Channel	Frequency	Data Rate (MHz)							
		MCS0	MCS1	MCS2	MCS3	MCS4	MCS5	MCS6	MCS7
CH 149	5745 MHz	14.66	14.65	14.61	12.92	13.11	13.01	13.12	12.04
CH 157	5785 MHz	14.66	14.64	14.63	12.94	13.09	13.05	13.17	12.07
CH 165	5825 MHz	14.84	14.82	14.81	13.12	13.31	13.24	13.32	12.24

5GHz 802.11n HT40 mode									
Channel	Frequency	Data Rate (MHz)							
		MCS0	MCS1	MCS2	MCS3	MCS4	MCS5	MCS6	MCS7
CH 151	5755 MHz	14.86	14.78	14.70	13.23	13.22	13.10	13.27	12.13
CH 159	5795 MHz	14.65	14.52	14.50	13.01	12.99	12.89	13.05	11.95



5GHz 802.11ac VHT20 mode										
Channel	Frequency	Data Rate (MHz)								
		MCS0	MCS1	MCS2	MCS3	MCS4	MCS5	MCS6	MCS7	MCS8
CH 149	5745 MHz	14.68	14.67	14.65	13.24	13.36	13.34	13.27	12.40	12.39
CH 157	5785 MHz	14.66	14.64	14.61	13.17	13.33	13.30	13.19	12.30	12.35
CH 165	5825 MHz	14.85	14.78	14.74	13.35	13.40	13.41	13.36	12.48	12.48

5GHz 802.11ac VHT40 mode											
Channel	Frequency	Data Rate (MHz)									
		MCS0	MCS1	MCS2	MCS3	MCS4	MCS5	MCS6	MCS7	MCS8	MCS9
CH 151	5755 MHz	14.83	14.77	14.74	13.31	13.32	13.20	13.24	12.30	11.75	11.18
CH 159	5795 MHz	14.86	14.85	14.81	13.35	13.37	13.27	13.30	12.37	11.81	11.22

5GHz 802.11ac VHT80 mode											
Channel	Frequency	Data Rate (MHz)									
		MCS0	MCS1	MCS2	MCS3	MCS4	MCS5	MCS6	MCS7	MCS8	MCS9
CH 155	5775 MHz	14.41	14.34	14.28	14.26	14.35	14.31	14.33	13.25	11.93	11.85

Note: MIMO Ant. 1+2 is a calculated result from sum of the power MIMO Ant. 1 and MIMO Ant. 2.



<TXBF Modes>

MIMO <Ant. 1+2>

5GHz 802.11a mode									
Channel	Frequency	Data Rate (MHz)							
		6M bps	9M bps	12M bps	18M bps	24M bps	36M bps	48M bps	54M bps
CH 149	5745 MHz	14.16	14.06	14.01	14.01	13.96	14.01	14.01	14.06
CH 157	5785 MHz	14.34	14.24	14.18	14.14	14.20	14.15	14.24	14.28
CH 165	5825 MHz	14.57	14.47	14.42	14.37	14.42	14.37	14.37	14.47

5GHz 802.11n HT20 mode									
Channel	Frequency	Data Rate (MHz)							
		MCS0	MCS1	MCS2	MCS3	MCS4	MCS5	MCS6	MCS7
CH 149	5745 MHz	14.36	14.26	14.21	14.21	14.26	14.16	14.16	14.16
CH 157	5785 MHz	14.61	14.51	14.46	14.36	14.31	14.31	14.51	14.41
CH 165	5825 MHz	14.51	14.31	14.31	14.26	14.31	14.31	14.21	14.41

5GHz 802.11n HT40 mode									
Channel	Frequency	Data Rate (MHz)							
		MCS0	MCS1	MCS2	MCS3	MCS4	MCS5	MCS6	MCS7
CH 151	5755 MHz	14.76	14.36	14.56	14.61	14.61	14.56	14.51	14.51
CH 159	5795 MHz	14.46	14.16	14.21	14.26	14.21	14.21	14.16	14.16



5GHz 802.11ac VHT20 mode										
Channel	Frequency	Data Rate (MHz)								
		MCS0	MCS1	MCS2	MCS3	MCS4	MCS5	MCS6	MCS7	MCS8
CH 149	5745 MHz	14.36	14.17	14.12	14.17	14.21	14.21	14.17	14.21	14.17
CH 157	5785 MHz	14.16	13.96	14.01	14.06	14.06	14.01	13.96	14.01	14.01
CH 165	5825 MHz	14.76	14.56	14.56	14.61	14.61	14.61	14.61	14.66	14.56

5GHz 802.11ac VHT40 mode											
Channel	Frequency	Data Rate (MHz)									
		MCS0	MCS1	MCS2	MCS3	MCS4	MCS5	MCS6	MCS7	MCS8	MCS9
CH 151	5755 MHz	14.62	14.52	14.42	14.37	14.37	14.47	14.37	14.32	14.37	14.43
CH 159	5795 MHz	14.76	14.66	14.51	14.61	14.61	14.46	14.51	14.56	14.56	14.46

5GHz 802.11ac VHT80 mode											
Channel	Frequency	Data Rate (MHz)									
		MCS0	MCS1	MCS2	MCS3	MCS4	MCS5	MCS6	MCS7	MCS8	MCS9
CH 155	5775 MHz	14.36	14.26	14.21	14.26	14.26	14.21	14.16	14.31	14.26	14.26

Note: MIMO Ant. 1+2 is a calculated result from sum of the power MIMO Ant. 1 and MIMO Ant. 2.



2.3 Test Mode

Final test mode of conducted test items and radiated spurious emissions are considering the modulation and worse data rates from the power table described in section 2.2.

Modulation	Data Rate
802.11a	6 Mbps
802.11n HT20	MCS0
802.11n HT40	MCS0
802.11ac VHT20	MCS0
802.11ac VHT40	MCS0
802.11ac VHT80	MCS0

AC Conducted Emission	Mode 1 : Bluetooth Link + WLAN (5GHz) Link + Battery + Earphone + USB Cable (Charging from Adapter)
--------------------------------------	---

Ch. #		Band IV : 5725-5850 MHz		
		802.11a	802.11n HT20	802.11n HT40
L	Low	149	149	151
M	Middle	157	157	-
H	High	165	165	159

Ch. #		Band IV : 5725-5850 MHz		
		802.11ac VHT20	802.11ac VHT40	802.11ac VHT80
L	Low	149	151	-
M	Middle	157	-	155
H	High	165	159	-

2.4 Connection Diagram of Test System

<WLAN Tx Non-TXBF Mode>

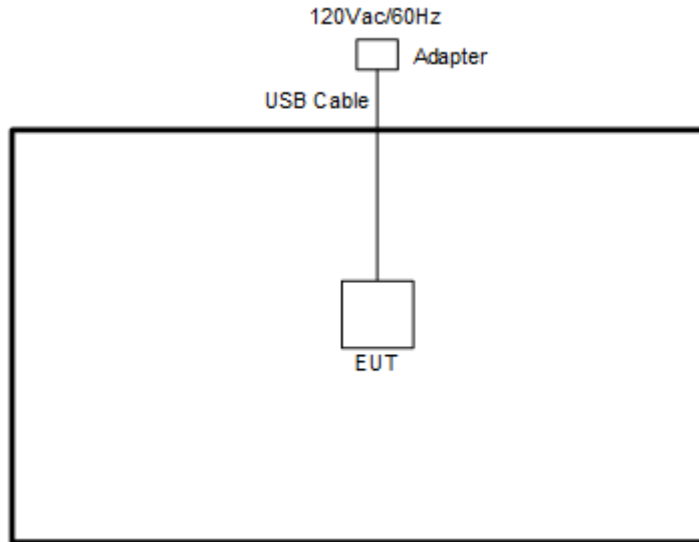

<WLAN Tx TXBF Mode>

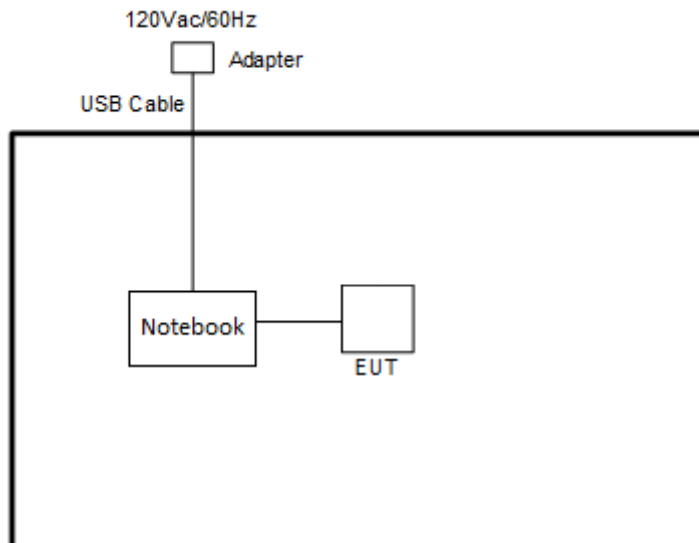

<AC Conducted Emission Mode>

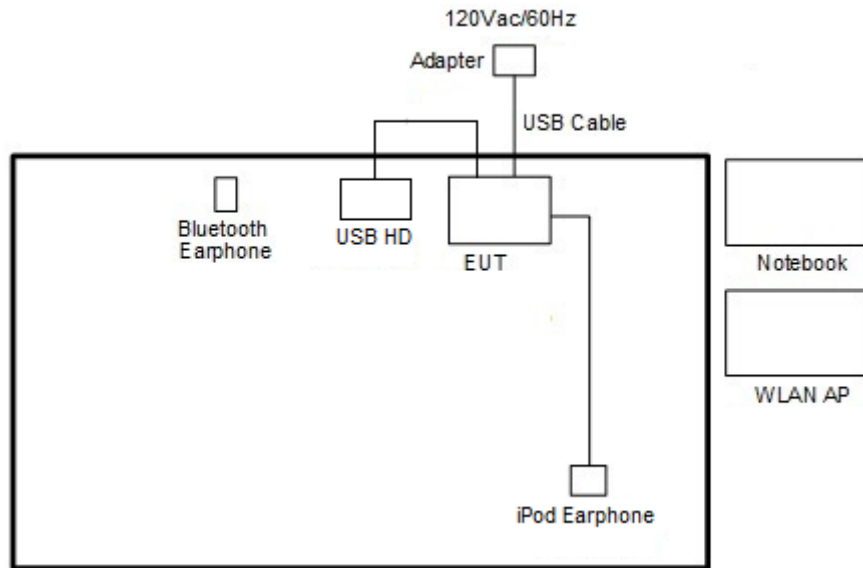



2.5 Support Unit used in test configuration and system

Item	Equipment	Trade Name	Model Name	FCC ID	Data Cable	Power Cord
1.	WLAN AP	D-Link	DIR-865L	KA2IR865LA1	N/A	Unshielded, 1.8 m
2.	Notebook	DELL	Latitude E6320	FCC DoC/ Contains FCC ID: QDS-BRCM1054	N/A	AC I/P: Unshielded, 1.2 m DC O/P: Shielded, 1.8 m
3.	iPod Earphone	Apple	N/A	Verification	Unshielded, 1.0 m	N/A
4.	Bluetooth Earphone	Sony Ericsson	MW600	PY7DDA-2029	N/A	N/A
5.	USB HD	WD	WDBAAR3200A BK-PESN	FCC DoC	Unshielded, 0.5 m	N/A
6.	Adapter	Delta Electronics	ADP-10BWC	FCC DoC	N/A	N/A
7.	SD Card	SanDisk	MicroSD HC	FCC DoC	N/A	N/A

2.6 EUT Operation Test Setup

For WLAN RF test items, an engineering test program was provided and enabled to make EUT continuous transmit/receive.

For WLAN MIMO TXBF modes, the EUT was tested under normal operation and link to another EUT with power, modulation modes and data rates controlled by engineer mode command lines. The iperf software tool was used to make EUT continuous transmitting signals.



2.7 Measurement Results Explanation Example

For all conducted test items:

The offset level is set in the spectrum analyzer to compensate the RF cable loss and attenuator factor between EUT conducted output port and spectrum analyzer. With the offset compensation, the spectrum analyzer reading level is exactly the EUT RF output level.

Example :

The spectrum analyzer offset is derived from RF cable loss and attenuator factor.

Offset = RF cable loss + attenuator factor.

Following shows an offset computation example with cable loss 4.2 dB and 10dB attenuator.

$$\begin{aligned} \text{Offset(dB)} &= \text{RF cable loss(dB)} + \text{attenuator factor(dB)}. \\ &= 4.2 + 10 = 14.2 \text{ (dB)} \end{aligned}$$

3 Test Result

3.1 6dB and 26dB and 99% Occupied Bandwidth Measurement

3.1.1 Description of 6dB and 26dB and 99% Occupied Bandwidth

The minimum 6 dB bandwidth shall be at least 500 kHz.

26dB and 99% Occupied bandwidth are reporting only.

3.1.2 Measuring Instruments

The measuring equipment is listed in the section 4 of this test report.

3.1.3 Test Procedures

1. The testing follows FCC KDB 789033 D02 General UNII Test Procedures New Rules v01r02. Section C) Emission bandwidth for the band 5.725-5.85GHz
2. Set RBW = 100kHz.
3. Set the VBW $\geq 3 \times$ RBW.
4. Detector = Peak.
5. Trace mode = max hold
6. Measure the maximum width of the emission that is 6 dB down from the peak of the emission.
7. Measure and record the results in the test report.

3.1.4 Test Setup

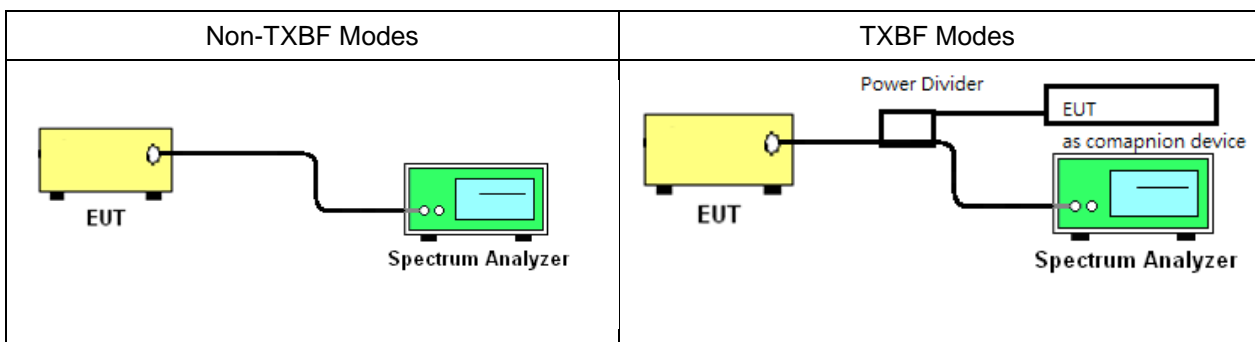



3.1.5 Test Result of 6dB Bandwidth

Please refer to Appendix A.

<Non-TXBF Modes>

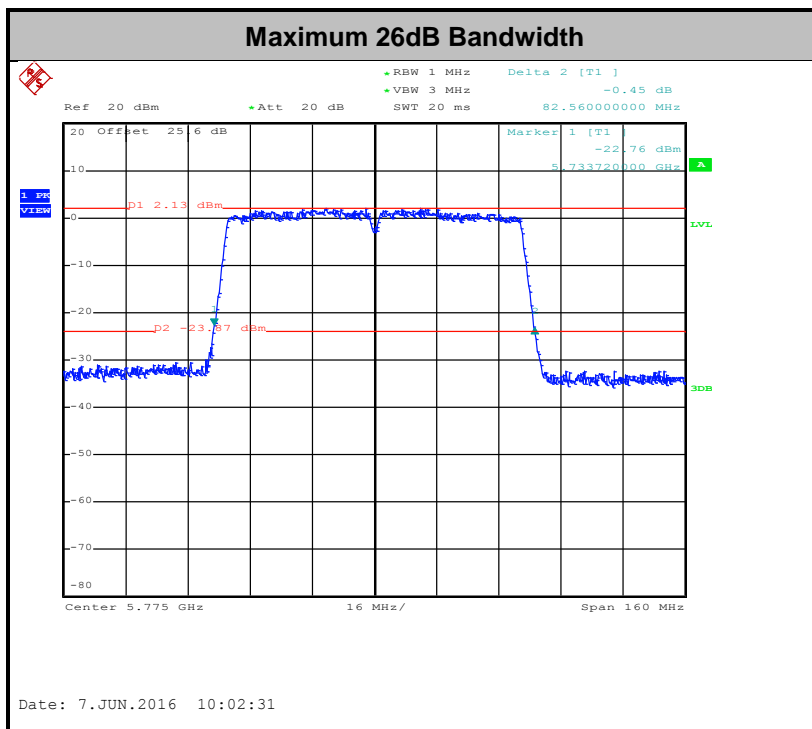
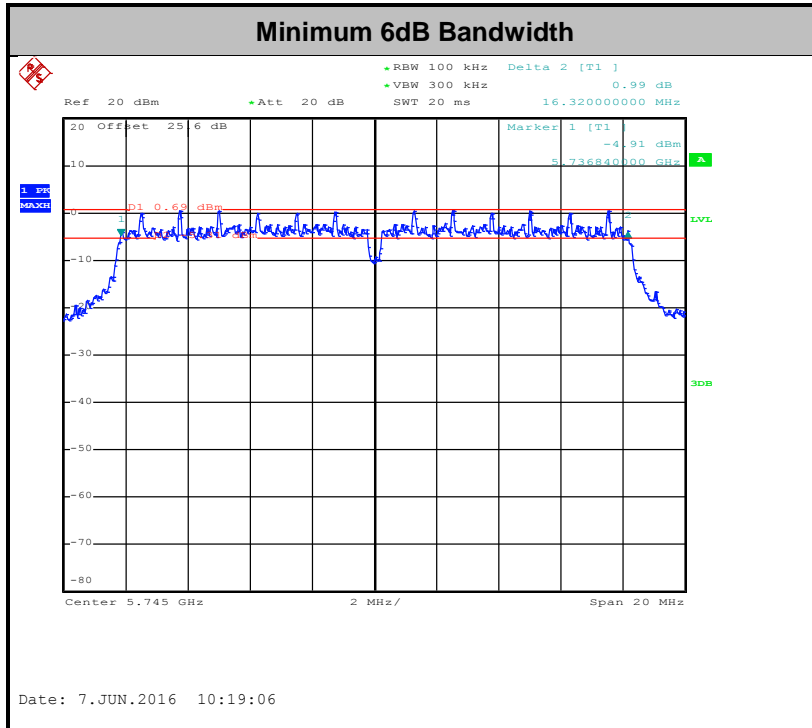

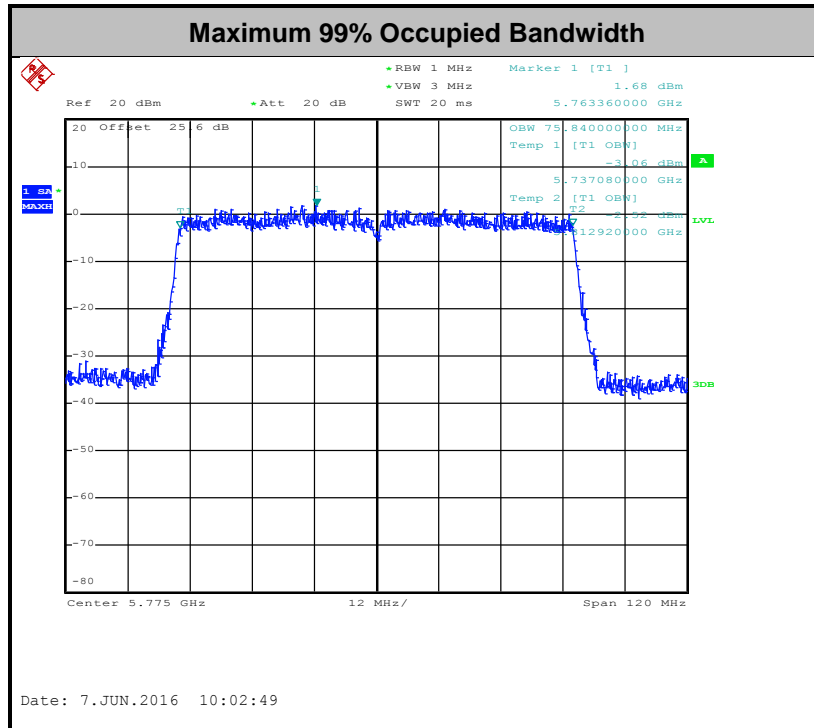

Note: The occupied channel bandwidth is maintained within the band of operation for all of the modulations.



<TXBF Modes>

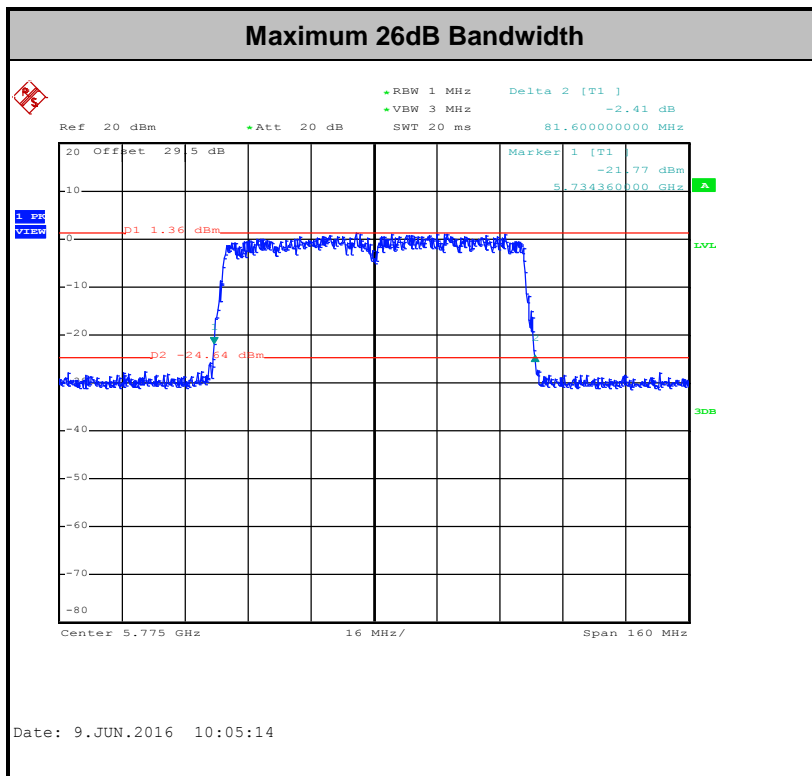
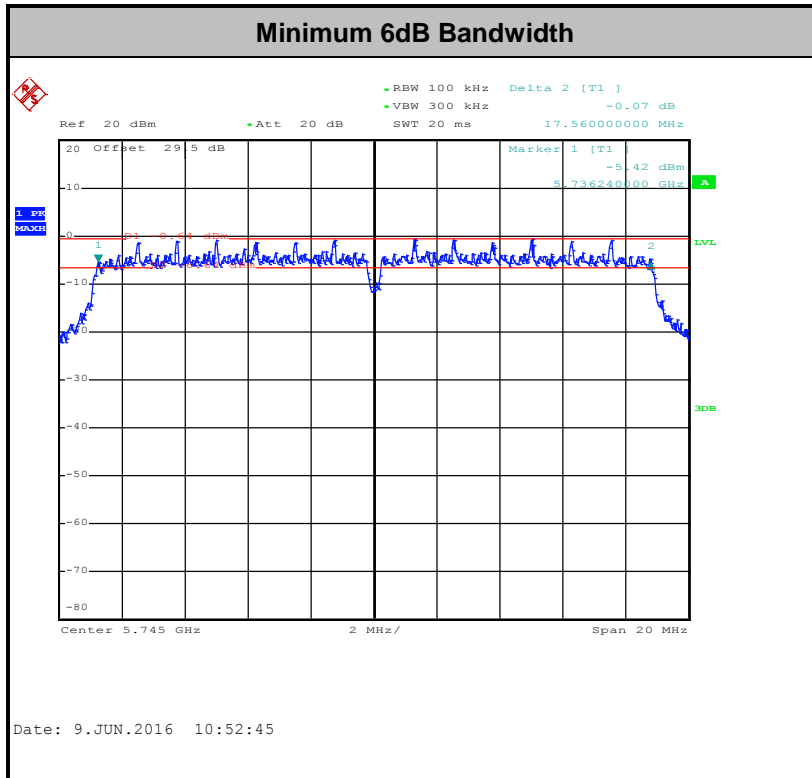

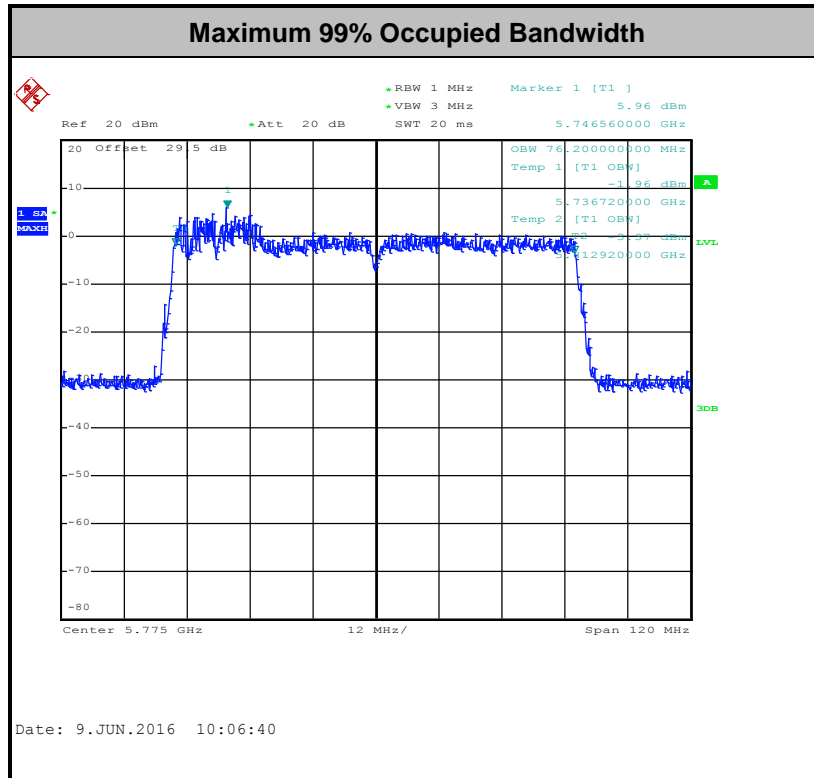

Note: The occupied channel bandwidth is maintained within the band of operation for all of the modulations.



3.2 Maximum Conducted Output Power Measurement

3.2.1 Limit of Maximum Conducted Output Power

For the band 5.725–5.85 GHz, the maximum conducted output power over the frequency band of operation shall not exceed 1 W.

If transmitting antennas of directional gain greater than 6 dBi are used, the peak output power shall be reduced by the amount in dB that the directional gain of the antenna exceeds 6 dBi.

3.2.2 Measuring Instruments

The measuring equipment is listed in the section 4 of this test report.

3.2.3 Test Procedures

Non-TXBF modes

The testing follows Method PM of FCC KDB 789033 D02 General UNII Test Procedures New Rules v01r02.

Method PM (Measurement using an RF average power meter):

1. Measurement is performed using a wideband RF power meter.
2. The EUT is configured to transmit continuously with a consistent duty cycle at its maximum power control level.
3. Measure the average power of the transmitter, and the average power is corrected with duty factor, $10 \log(1/x)$, where x is the duty cycle.

TXBF modes

The testing follows Method PM-G of FCC KDB 789033 D02 General UNII Test Procedures New Rules v01r02 for TXBF modes.

Method PM-G (Measurement using a gated RF average power meter):

1. Measurement is performed using a wideband RF power meter.
2. The EUT is configured to transmit continuously with a consistent duty cycle at its maximum power control level.
3. Measure the average power of the transmitter
4. Since the measurement is made only during the ON time of the transmitter, no duty cycle correction factor is required.

3.2.4 Test Setup

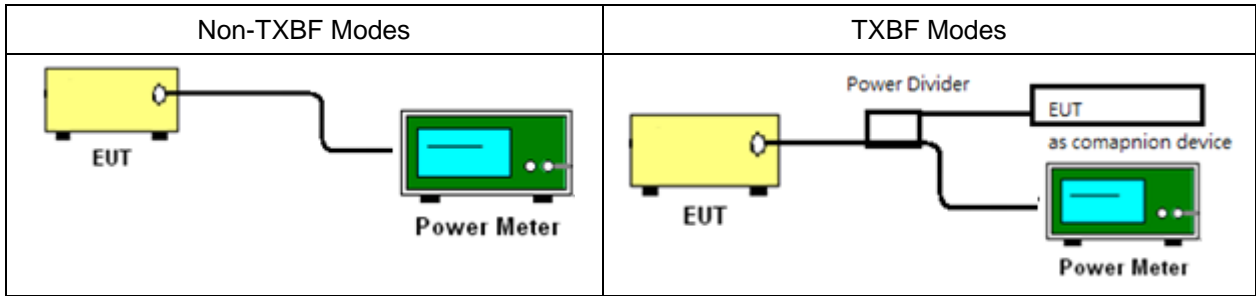

3.2.5 Test Result of Maximum Conducted Output Power

Please refer to Appendix A.



3.3 Power Spectral Density Measurement

3.3.1 Limit of Power Spectral Density

For the band 5.725–5.85 GHz, the maximum power spectral density shall not exceed 30 dBm in any 500-kHz band.

If transmitting antennas of directional gain greater than 6 dBi are used, the peak output power shall be reduced by the amount in dB that the directional gain of the antenna exceeds 6 dBi.

3.3.2 Measuring Instruments

The measuring equipment is listed in the section 4 of this test report.

3.3.3 Test Procedures

The testing follows FCC KDB 789033 D02 General UNII Test Procedures New Rules v01r02. Section F) Maximum power spectral density.

Non-TXBF modes

Method SA-2

(trace averaging across on and off times of the EUT transmissions, followed by duty cycle correction).

1. The testing follows Method SA-2 of FCC KDB 789033 D02 General UNII Test Procedures New Rules v01r02.
 - Measure the duty cycle.
 - Set span to encompass the entire emission bandwidth (EBW) of the signal.
 - Set RBW = 300 kHz.
 - Set VBW \geq 1 MHz.
 - Number of points in sweep \geq 2 Span / RBW.
 - Sweep time = auto.
 - Detector = RMS
 - Trace average at least 100 traces in power averaging mode.
 - Add $10 \log(500\text{kHz}/\text{RBW})$ to the test result.
 - Add $10 \log(1/x)$, where x is the duty cycle, to the measured power in order to compute the average power during the actual transmission times. For example, add $10 \log(1/0.25) = 6$ dB if the duty cycle is 25 percent.

TXBF modes

Method SA-3

(power averaging (rms) detection with max hold):

- Set span to encompass the entire emission bandwidth (EBW) of the signal.
- Set RBW = 300 kHz.
- Set VBW \geq 1 MHz.
- Number of points in sweep \geq 2 Span / RBW.
- Sweep time \leq (number of points in sweep) \times T, when duty cycle is less than 98 percent where T is the minimum transmission duration over which the transmitter is on and is transmitting at its maximum power control level for the tested mode of operation.
- Detector = power averaging (rms).
- Trace mode = max hold.
- Allow max hold to run for at least 60 seconds, or longer as needed to allow the trace to stabilize.

1. The RF output of EUT was connected to the spectrum analyzer by a low loss cable.
2. Each plot has already offset with cable loss, and attenuator loss. Measure the PPSD and record it.
3. For MIMO mode, calculation method follows FCC KDB 662911 D01 Multiple Transmitter Output v02r01.

Method (a): Measure and sum the spectra across the outputs.

The total final Power Spectral Density is from a device with 2 transmitter outputs. The spectrum measurements of the individual outputs are all performed with the same span and number of points, the spectrum value in the first spectral bin of output 1 is summed with that in the first spectral bin of output 2 to obtain the value for the first frequency bin of the summed spectrum.

3.3.4 Test Setup

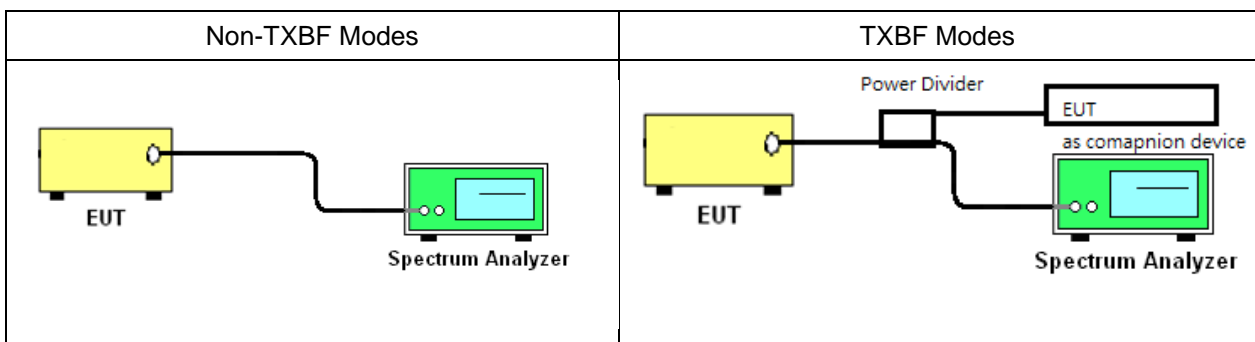



3.3.5 Test Result of Power Spectral Density

Please refer to Appendix A.

<Non-TXBF Modes>

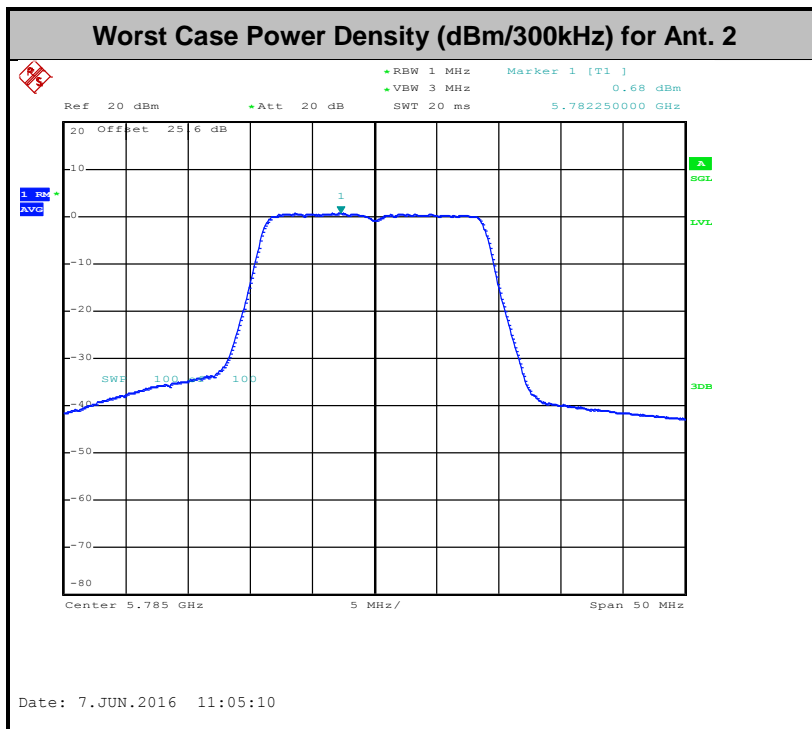
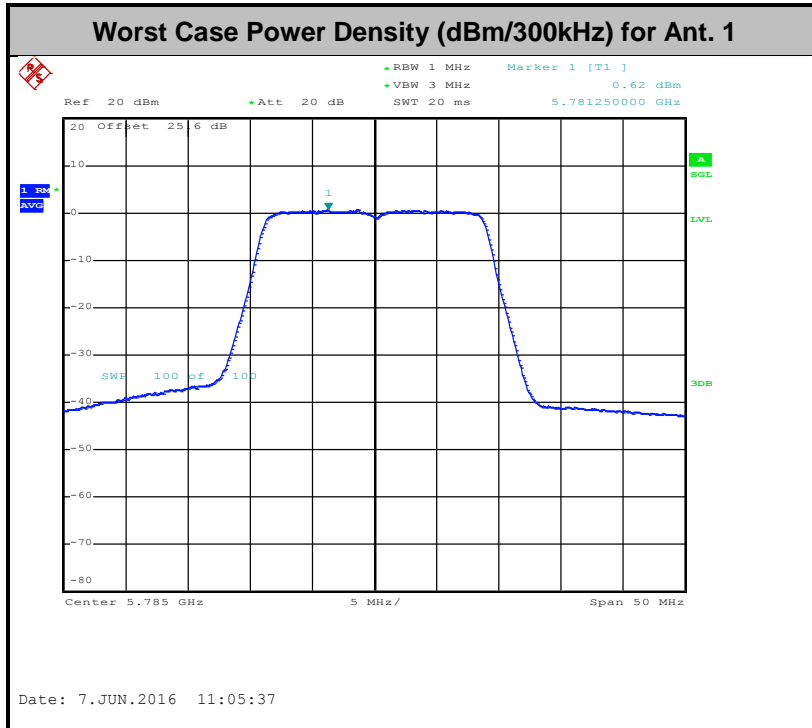



<TXBF Modes>

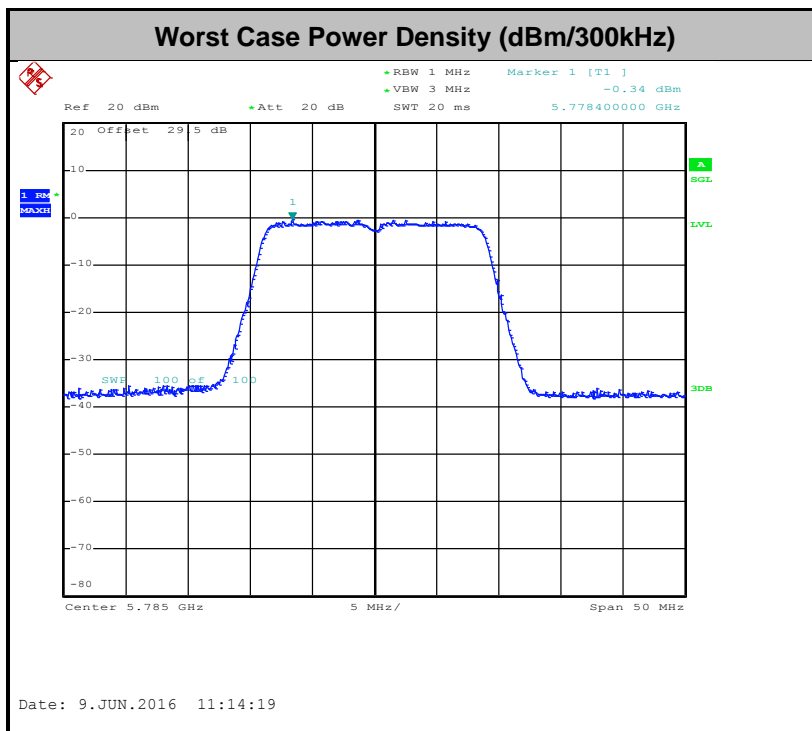
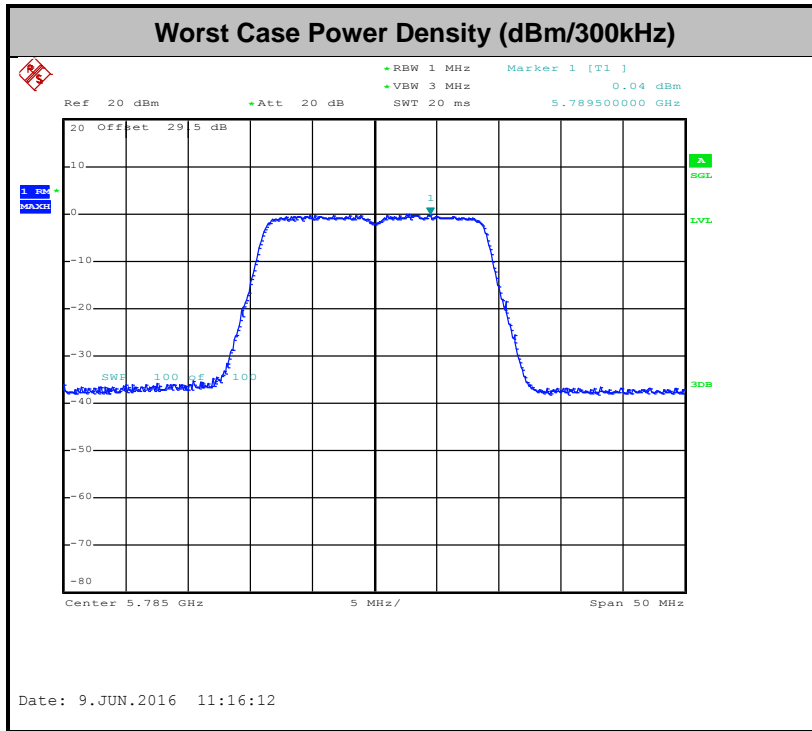



3.4 Unwanted Emissions Measurement

This section as specified in FCC Part 15.407(b) is to measure unwanted emissions through radiated measurement for band edge spurious emissions and out of band emissions measurement. The unwanted emissions shall comply with 15.407(b)(1) to (6), and restricted bands per FCC Part15.205.

3.4.1 Limit of Unwanted Emissions

(1) For transmitters operating in the 5.725-5.85 GHz band:

15.407(b)(4)(i) All emissions shall be limited to a level of -27 dBm/MHz at 75 MHz or more above or below the band edge increasing linearly to 10 dBm/MHz at 25 MHz above or below the band edge, and from 25 MHz above or below the band edge increasing linearly to a level of 15.6 dBm/MHz at 5 MHz above or below the band edge, and from 5 MHz above or below the band edge increasing linearly to a level of 27 dBm/MHz at the band edge.

(2) Unwanted spurious emissions fallen in restricted bands per FCC Part15.205 shall comply with the general field strength limits set forth in § 15.209 as below table,

Frequency (MHz)	Field Strength (microvolts/meter)	Measurement Distance (meters)
0.009 – 0.490	2400/F(kHz)	300
0.490 – 1.705	24000/F(kHz)	30
1.705 – 30.0	30	30
30 – 88	100	3
88 – 216	150	3
216 - 960	200	3
Above 960	500	3

Note: The following formula is used to convert the EIRP to field strength.

$$E = \frac{1000000\sqrt{30P}}{3} \mu\text{V/m, where P is the eirp (Watts)}$$

EIRP (dBm)	Field Strength at 3m (dBμV/m)
-17	78.3
- 27	68.3

(3) KDB 789033 D02 General UNII Test Procedures New Rules v01r02 G)2)c) As specified in 15.407(b), emissions above 1000 MHz that are outside of the restricted bands are subject to a peak emission limit of -27 dBm/MHz (or -17 dBm/MHz as specified in 15.407(b)(4)). However, an out-of-band emission that complies with both the average and peak limits of 15.209 is not required to satisfy the -27 dBm/MHz or -17 dBm/MHz peak emission limit.



3.4.2 Measuring Instruments

The measuring equipment is listed in the section 4 of this test report.

3.4.3 Test Procedures

1. The testing follows FCC KDB 789033 D02 General UNII Test Procedures New Rules v01r02. Section G) Unwanted emissions measurement.

(1) Procedure for Unwanted Emissions Measurements Below 1000MHz

- RBW = 120 kHz
- VBW = 300 kHz
- Detector = Peak
- Trace mode = max hold

(2) Procedure for Peak Unwanted Emissions Measurements Above 1000 MHz

- RBW = 1 MHz
- VBW \geq 3 MHz
- Detector = Peak
- Sweep time = auto
- Trace mode = max hold

(3) Procedures for Average Unwanted Emissions Measurements Above 1000MHz

- RBW = 1 MHz
- VBW = 10 Hz, when duty cycle is no less than 98 percent.
- VBW \geq 1/T, when duty cycle is less than 98 percent where T is the minimum transmission duration over which the transmitter is on and is transmitting at its maximum power control level for the tested mode of operation.



2. The EUT was placed on a turntable with 0.8 meter for frequency below 1GHz and 1.5 meter for frequency above 1GHz respectively above ground.
3. The EUT was set 3 meters from the interference receiving antenna which was mounted on the top of a variable height antenna tower.
4. The antenna is a broadband antenna and its height is adjusted between one meter and four meters above ground to find the maximum value of the field strength for both horizontal polarization and vertical polarization of the antenna.
5. For each suspected emission, the EUT was arranged to its worst case and then adjust the antenna tower (from 1 m to 4 m) and turntable (from 0 degree to 360 degrees) to find the maximum reading.
6. For testing below 1GHz, if the emission level of the EUT in peak mode was 3 dB lower than the limit specified, then peak values of EUT will be reported, otherwise, the emissions will be repeated one by one using the CISPR quasi-peak method and reported.
7. For testing above 1GHz, the emission level of the EUT in peak mode was 20dB lower than average limit (that means the emission level in average mode also complies with the limit in average mode), then peak values of EUT will be reported, otherwise, the emissions will be measured in average mode again and reported.

3.4.4 Test Setup

For radiated emissions below 30MHz



For radiated emissions from 30MHz to 1GHz

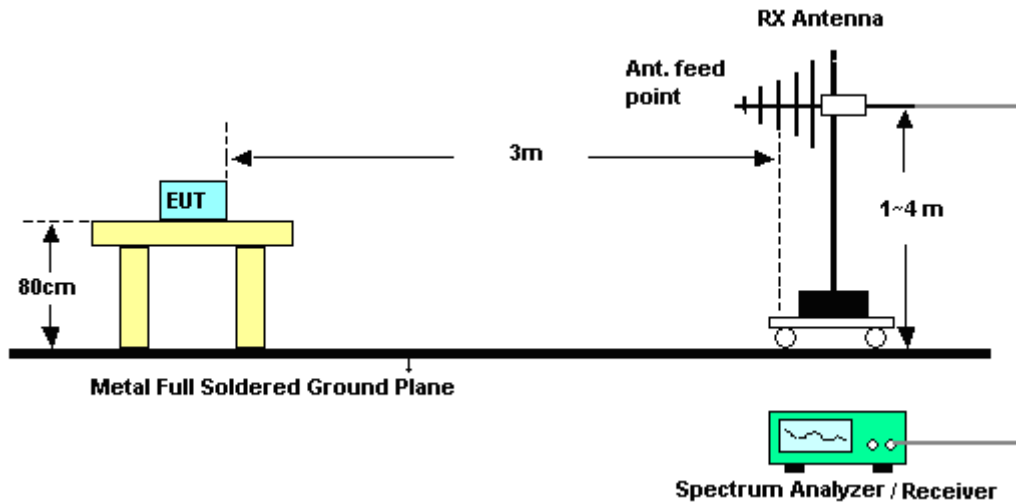

For radiated emissions above 1GHz

Non-TXBF mode

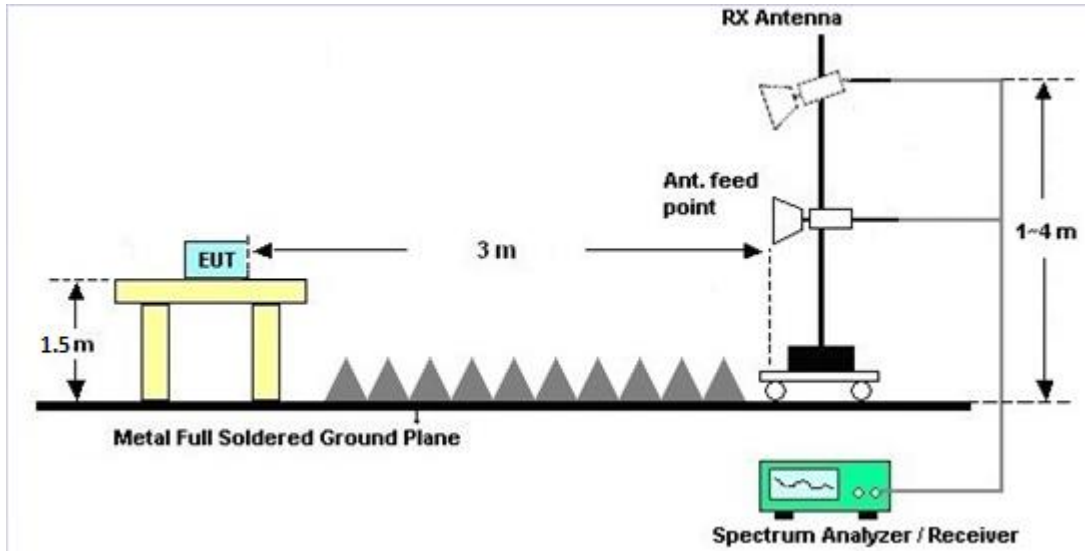

TXBF mode

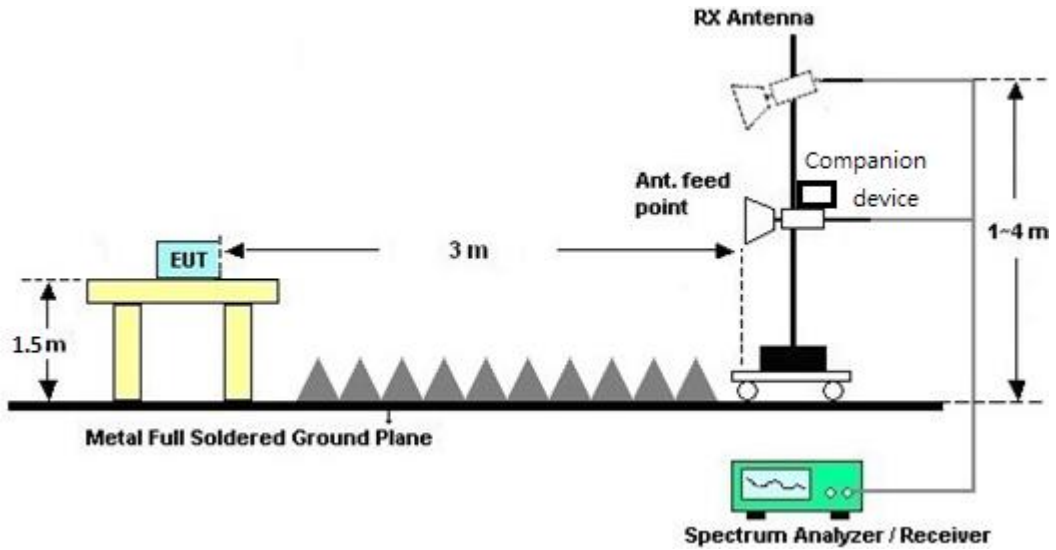



3.4.5 Test Results of Radiated Emissions (9 kHz ~ 30 MHz)

The low frequency, which started from 9 kHz to 30MHz, was pre-scanned and the result which was 20dB lower than the limit line per 15.31(o) was not reported.

3.4.6 Test Result of Radiated Band Edges

Please refer to Appendix B and C.

3.4.7 Duty Cycle

Please refer to Appendix D.

3.4.8 Test Result of Unwanted Radiated Emission (30MHz ~ 10th Harmonic)

Please refer to Appendix B and C.



3.5 AC Conducted Emission Measurement

3.5.1 Limit of AC Conducted Emission

For equipment that is designed to be connected to the public utility (AC) power line, the radio frequency voltage that is conducted back onto the AC power line on any frequency or frequencies within the band 150 kHz to 30 MHz shall not exceed the limits in the following table.

Frequency of emission (MHz)	Conducted limit (dB μ V)	
	Quasi-peak	Average
0.15-0.5	66 to 56*	56 to 46*
0.5-5	56	46
5-30	60	50

*Decreases with the logarithm of the frequency.

3.5.2 Measuring Instruments

The measuring equipment is listed in the section 4 of this test report.

3.5.3 Test Procedures

1. The EUT was placed 0.4 meter from the conducting wall of the shielding room was kept at least 80 centimeters from any other grounded conducting surface.
2. Connect EUT to the power mains through a line impedance stabilization network (LISN).
3. All the support units are connecting to the other LISN.
4. The LISN provides 50 ohm coupling impedance for the measuring instrument.
5. The FCC states that a 50 ohm, 50 microhenry LISN should be used.
6. Both sides of AC line were checked for maximum conducted interference.
7. The frequency range from 150 kHz to 30 MHz was searched.
8. Set the test-receiver system to Peak Detect Function and specified bandwidth with Maximum Hold Mode.

3.5.4 Test Setup

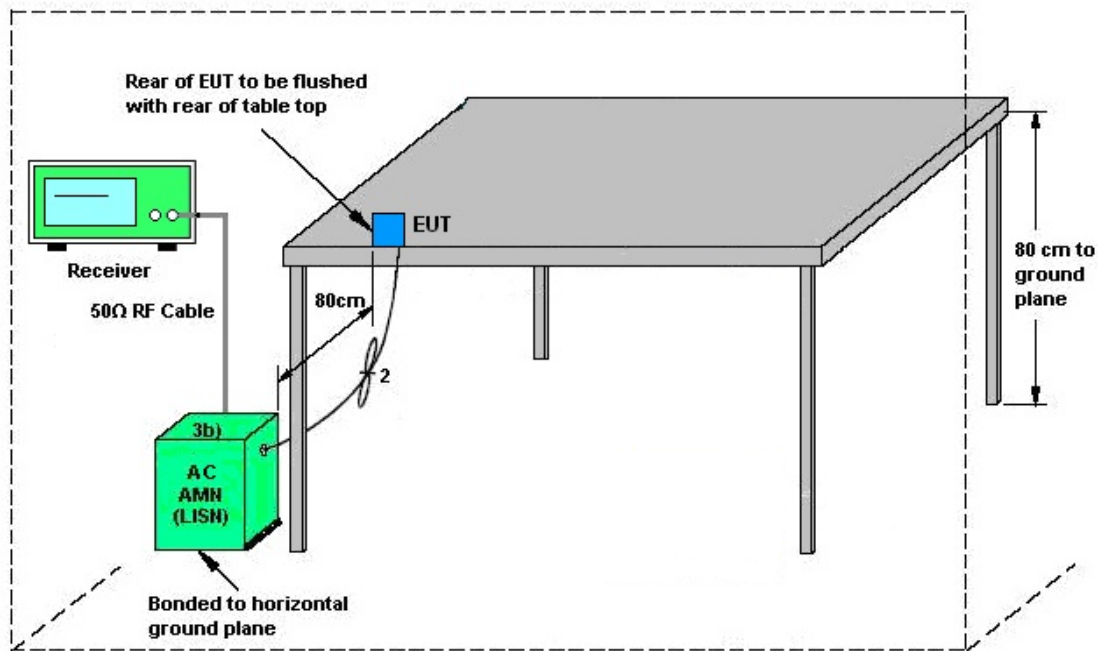

AMN = Artificial mains network (LISN)
AE = Associated equipment
EUT = Equipment under test
ISN = Impedance stabilization network

3.5.5 Test Result of AC Conducted Emission

Test Mode :	Mode 1	Temperature :	20~22°C
Test Engineer :	Kai-Chun Chu	Relative Humidity :	45~47%
Test Voltage :	120Vac / 60Hz	Phase :	Line
Function Type :	Bluetooth Link + WLAN (5GHz) Link + Battery + Earphone + USB Cable (Charging from Adapter)		

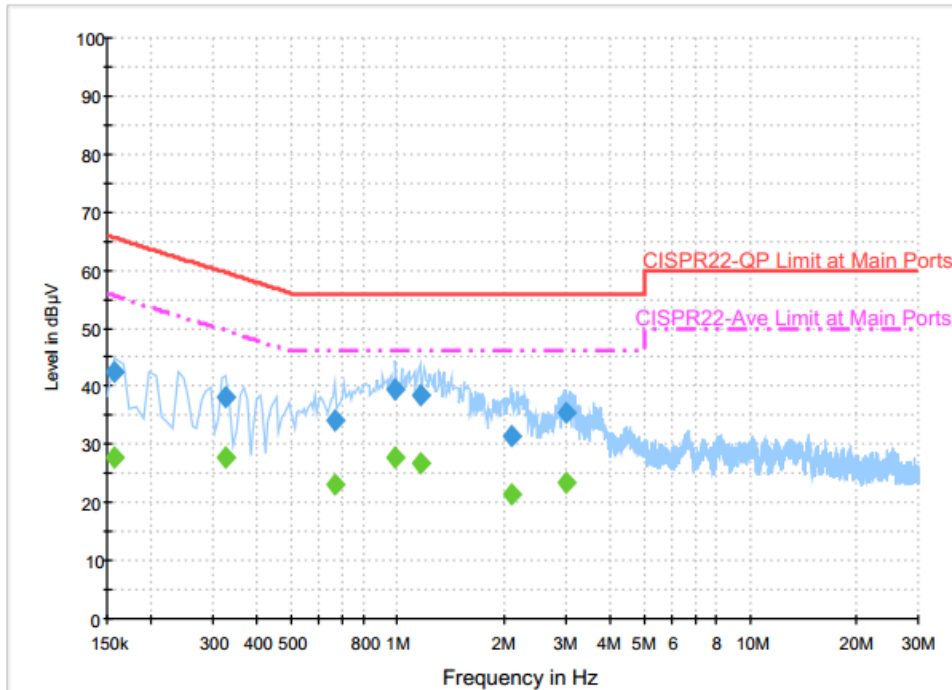

Final Result : QuasiPeak

Frequency (MHz)	QuasiPeak (dBµV)	Filter	Line	Corr. (dB)	Margin (dB)	Limit (dBµV)
0.158000	42.4	Off	L1	19.6	23.2	65.6
0.326000	38.1	Off	L1	19.6	21.5	59.6
0.662000	34.2	Off	L1	19.6	21.8	56.0
0.990000	39.4	Off	L1	19.6	16.6	56.0
1.158000	38.6	Off	L1	19.6	17.4	56.0
2.110000	31.4	Off	L1	19.5	24.6	56.0
3.006000	35.5	Off	L1	19.6	20.5	56.0

Final Result : Average

Frequency (MHz)	Average (dBµV)	Filter	Line	Corr. (dB)	Margin (dB)	Limit (dBµV)
0.158000	27.7	Off	L1	19.6	27.9	55.6
0.326000	27.8	Off	L1	19.6	21.8	49.6
0.662000	22.9	Off	L1	19.6	23.1	46.0
0.990000	27.7	Off	L1	19.6	18.3	46.0
1.158000	26.6	Off	L1	19.6	19.4	46.0
2.110000	21.3	Off	L1	19.5	24.7	46.0
3.006000	23.3	Off	L1	19.6	22.7	46.0



Test Mode :	Mode 1	Temperature :	20~22°C
Test Engineer :	Kai-Chun Chu	Relative Humidity :	45~47%
Test Voltage :	120Vac / 60Hz	Phase :	Neutral
Function Type :	Bluetooth Link + WLAN (5GHz) Link + Battery + Earphone + USB Cable (Charging from Adapter)		

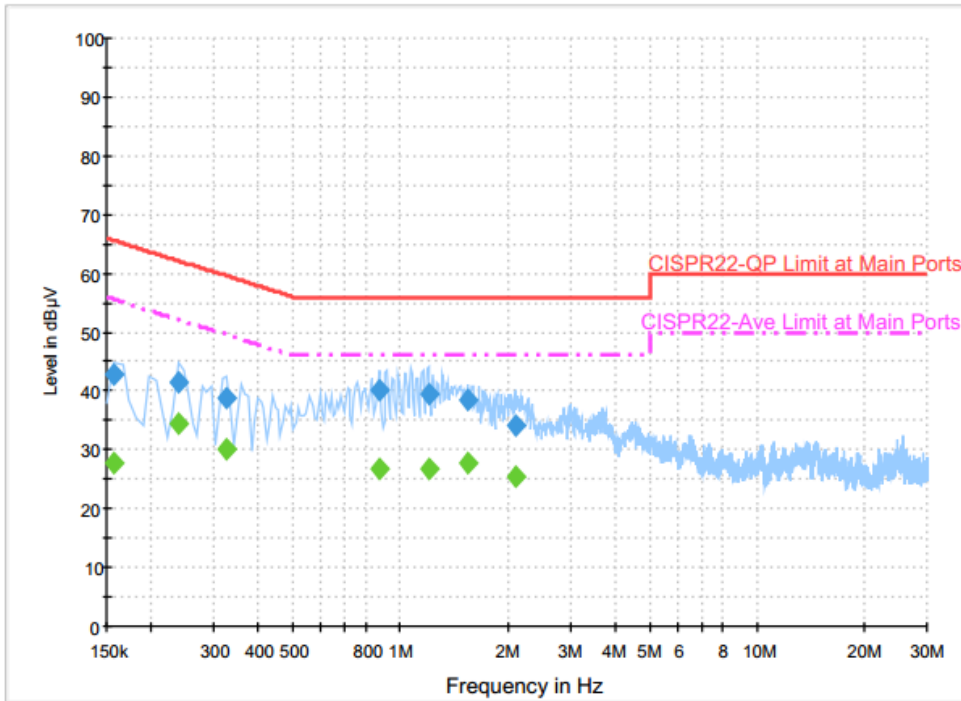

Final Result : QuasiPeak

Frequency (MHz)	QuasiPeak (dBµV)	Filter	Line	Corr. (dB)	Margin (dB)	Limit (dBµV)
0.158000	42.7	Off	N	19.6	22.9	65.6
0.238000	41.5	Off	N	19.6	20.7	62.2
0.326000	38.8	Off	N	19.6	20.8	59.6
0.870000	40.2	Off	N	19.6	15.8	56.0
1.198000	39.6	Off	N	19.6	16.4	56.0
1.542000	38.6	Off	N	19.6	17.4	56.0
2.102000	34.0	Off	N	19.5	22.0	56.0

Final Result : Average

Frequency (MHz)	Average (dBµV)	Filter	Line	Corr. (dB)	Margin (dB)	Limit (dBµV)
0.158000	27.7	Off	N	19.6	27.9	55.6
0.238000	34.5	Off	N	19.6	17.7	52.2
0.326000	30.1	Off	N	19.6	19.5	49.6
0.870000	26.7	Off	N	19.6	19.3	46.0
1.198000	26.6	Off	N	19.6	19.4	46.0
1.542000	27.9	Off	N	19.6	18.1	46.0
2.102000	25.3	Off	N	19.5	20.7	46.0

3.6 Frequency Stability Measurement

3.6.1 Limit of Frequency Stability

Manufacturers of U-NII devices are responsible for ensuring frequency stability such that an emission is maintained within the band of operation under all conditions of normal operation as specified in the user's manual.

3.6.2 Measuring Instruments

The measuring equipment is listed in the section 4 of this test report.

3.6.3 Test Procedures

1. To ensure emission at the band edge is maintained within the authorized band, those values shall be measured by radiation emissions at upper and lower frequency points, and finally compensated by frequency deviation as procedures below.
2. The EUT was operated at the maximum output power, and connected to the spectrum analyzer, which is set to maximum hold function and peak detector. The peak value of the power envelope was measured and noted. The upper and lower frequency points were respectively measured relatively 10dB lower than the measured peak value.
3. The frequency deviation was calculated by adding the upper frequency point and the lower frequency point divided by two. Those detailed values of frequency deviation are provided in table below.

3.6.4 Test Setup

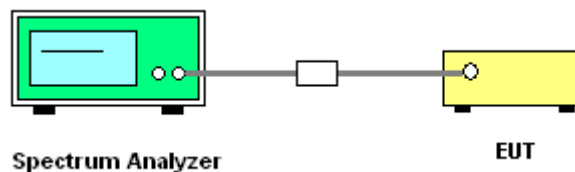

3.6.5 Test Result of Frequency Stability

Please refer to Appendix A.



3.7 Automatically Discontinue Transmission

3.7.1 Limit of Automatically Discontinue Transmission

The device shall automatically discontinue transmission in case of either absence of information to transmit or operational failure. These provisions are not intended to preclude the transmission of control or signaling information or the use of repetitive codes used by certain digital technologies to complete frame or burst intervals. Applicants shall include in their application for equipment authorization to describe how this requirement is met.

3.7.2 Measuring Instruments

The measuring equipment is listed in the section 4 of this test report.

3.7.3 Test Result of Automatically Discontinue Transmission

While the EUT is not transmitting any information, the EUT can automatically discontinue transmission and become standby mode for power saving. The EUT can detect the controlling signal of ACK message transmitting from remote device and verify whether it shall resend or discontinue transmission.



3.8 Antenna Requirements

3.8.1 Standard Applicable

According to FCC 47 CFR Section 15.407(a)(1)(2) ,if transmitting antenna directional gain is greater than 6 dBi, both the peak transmit power and the peak power spectral density shall be reduced by the amount in dB that the directional gain of the antenna exceeds 6 dBi.

3.8.2 Antenna Anti-Replacement Construction

An embedded-in antenna design is used.

3.8.3 Antenna Gain

Non-TXBF Mode

FCC KDB 662911 D01 Multiple Transmitter Output v02r01

For CDD transmissions, directional gain is calculated as

Directional gain = $G_{ANT} + \text{Array Gain}$, where Array Gain is as follows.

For power spectral density (PSD) measurements on all devices,

Array Gain = $10 \log(N_{ANT}/N_{SS}=1)$ dB.

For power measurements on IEEE 802.11 devices,

Array Gain = 0 dB (i.e., no array gain) for $N_{ANT} \leq 4$.

The EUT supports CDD mode.

The power and PSD limit should be modified if the directional gain of EUT is over 6 dBi,

The directional gain “DG” is calculated as following table.

			DG	DG	Power	PSD
			for	for	Limit	Limit
	Ant 1	Ant 2	Power	PSD	Reduction	Reduction
	(dBi)	(dBi)	(dBi)	(dBi)	(dB)	(dB)
Band IV	0.50	0.40	0.50	3.46	0.00	0.00

Power limit reduction = Composite gain – 6dBi, (min = 0)

PSD limit reduction = Composite gain + PSD Array gain – 6dBi, (min = 0)



TXBF Mode

FCC KDB 662911 D01 Multiple Transmitter Output v02r01

For CDD transmissions, directional gain is calculated as

$$DirectionalGain = 10 \cdot \log \left[\frac{\sum_{j=1}^{N_{SS}} \left\{ \sum_{k=1}^{N_{ANT}} g_{j,k} \right\}^2}{N_{ANT}} \right]$$

where

Each antenna is driven by no more than one spatial stream;

N_{SS} = the number of independent spatial streams of data;

N_{ANT} = the total number of antennas

$g_{j,k} = 10^{G_k / 20}$ if the k th antenna is being fed by spatial stream j , or zero if it is not;
 G_k is the gain in dBi of the k th antenna.

The EUT supports beamforming.

The power and PSD limit should be modified if the directional gain of EUT is over 6 dBi,

The directional gain “DG” is calculated as following table.

			DG	DG	Power	PSD
			for	for	Limit	Limit
	Ant 1	Ant 2	Power	PSD	Reduction	Reduction
	(dBi)	(dBi)	(dBi)	(dBi)	(dB)	(dB)
Band IV	0.50	0.40	3.46	3.46	0.00	0.00

Power Limit Reduction = DG(Power) – 6dBi, (min = 0)

PSD Limit Reduction = DG(PSD) – 6dBi, (min = 0)



4 List of Measuring Equipment

Instrument	Manufacturer	Model No.	Serial No.	Characteristics	Calibration Date	Test Date	Due Date	Remark
Power Meter	Anritsu	ML2495A	1132003	300MHz~40GHz	Aug. 12, 2015	Jun. 07, 2016 ~ Jun. 29, 2016	Aug. 11, 2016	Conducted (TH05-HY)
Power Sensor	Anritsu	MA2411B	1126017	300MHz~40GHz	Aug. 12, 2015	Jun. 07, 2016 ~ Jun. 29, 2016	Aug. 11, 2016	Conducted (TH05-HY)
Power Sensor	DARE	RadiPower	15100041SNO09	10MHz~6GHz	May. 03, 2016	Jun. 07, 2016 ~ Jun. 29, 2016	May. 02, 2017	Conducted (TH05-HY)
Power Sensor	DARE	RadiPower	15100041SNO10	10MHz~6GHz	May. 03, 2016	Jun. 07, 2016 ~ Jun. 29, 2016	May. 02, 2017	Conducted (TH05-HY)
Spectrum Analyzer	Rohde & Schwarz	FSP40	100057	9kHz-40GHz	Nov. 23, 2015	Jun. 07, 2016 ~ Jun. 29, 2016	Nov. 22, 2016	Conducted (TH05-HY)
Temperature Chamber	ESPEC	SU-241	92003713	-30℃ ~95℃	Jun. 15, 2015	Jun. 07, 2016 ~ Jun. 29, 2016	Jun. 14, 2016	Conducted (TH05-HY)
Bilog Antenna	TESEQ	CBL 6111D	35419	30MHz to 1GHz	Jan. 13, 2016	May 19, 2016 ~ Jun. 06, 2016	Jan. 12, 2017	Radiation (03CH07-HY)
Double Ridge Horn Antenna	ESCO	3117	00075962	1GHz ~ 18GHz	Aug. 21, 2015	May 19, 2016 ~ Jun. 06, 2016	Aug. 20, 2016	Radiation (03CH07-HY)
EMI Test Receiver	Keysight	N9038A(MXE)	MY54130085	20Hz ~ 8.4GHz	Nov. 04, 2015	May 19, 2016 ~ Jun. 06, 2016	Nov. 03, 2016	Radiation (03CH07-HY)
Loop Antenna	Rohde & Schwarz	HFH2-Z2	100315	9 kHz~30 MHz	Sep. 02, 2015	May 19, 2016 ~ Jun. 06, 2016	Sep. 01, 2016	Radiation (03CH07-HY)
Preamplifier	MITEQ	AMF-7D-0010 1800-30-10P	1590075	1GHz ~ 18GHz	Apr. 15, 2016	May 19, 2016 ~ Jun. 06, 2016	Apr. 14, 2017	Radiation (03CH07-HY)
Preamplifier	COM-POWER	PA-103A	161241	10MHz-1GHz	Mar. 18, 2016	May 19, 2016 ~ Jun. 06, 2016	Mar. 17, 2017	Radiation (03CH07-HY)
Preamplifier	Agilent	8449B	3008A02362	1GHz~ 26.5GHz	Oct. 19, 2015	May 19, 2016 ~ Jun. 06, 2016	Oct. 18, 2016	Radiation (03CH07-HY)
Spectrum Analyzer	Agilent	N9010A	MY53470118	10Hz~44GHz	Feb. 27, 2016	May 19, 2016 ~ Jun. 06, 2016	Feb. 26, 2017	Radiation (03CH07-HY)
Antenna Mast	Max-Full	MFA520BS	N/A	1m~4m	N/A	May 19, 2016 ~ Jun. 06, 2016	N/A	Radiation (03CH07-HY)
Turn Table	ChainTek	Chaintek 3000	N/A	0~360 Degree	N/A	May 19, 2016 ~ Jun. 06, 2016	N/A	Radiation (03CH07-HY)
Preamplifier	MITEQ	TTA0204	1872107	2GHz~40GHz	Feb. 15, 2015	May 19, 2016 ~ Jun. 06, 2016	Feb. 14, 2017	Radiation (03CH07-HY)
SHF-EHF Horn Antenna	SCHWARZBECK	BBHA 9170	BBHA9170584	18GHz- 40GHz	Nov. 02, 2015	May 19, 2016 ~ Jun. 06, 2016	Nov. 01, 2016	Radiation (03CH07-HY)
AC Power Source	ChainTek	APC-1000W	N/A	N/A	N/A	May 14, 2016	N/A	Conduction (CO05-HY)
EMI Test Receiver	Rohde & Schwarz	ESCI 7	100724	9kHz~7GHz	Aug. 26, 2015	May 14, 2016	Aug. 25, 2016	Conduction (CO05-HY)
LISN	Rohde & Schwarz	ENV216	100080	9kHz~30MHz	Dec. 02, 2015	May 14, 2016	Dec. 01, 2016	Conduction (CO05-HY)



5 Uncertainty of Evaluation

Uncertainty of Conducted Emission Measurement (150kHz ~ 30MHz)

Measuring Uncertainty for a Level of Confidence of 95% ($U = 2Uc(y)$)	2.26
---	------

Uncertainty of Radiated Emission Measurement (30 MHz ~ 1000 MHz)

Measuring Uncertainty for a Level of Confidence of 95% ($U = 2Uc(y)$)	4.50
---	------



Appendix A. Conducted Test Results

<Non-TXBF Modes>

Test Engineer:	Kenny Chen	Temperature:	21~25	°C
Test Date:	2016/6/7	Relative Humidity:	51~54	%

TEST RESULTS DATA
6dB and 26dB EBW and 99% OBW

Band IV													
Mod.	Data Rate	NTX	CH.	Freq. (MHz)	99% Bandwidth (MHz)		26dB Bandwidth (MHz)		6 dB Bandwidth (MHz)		6 dB Bandwidth Min. Limit (MHz)		Pass/Fail
					Ant 1	Ant 2	Ant 1	Ant 2	Ant 1	Ant 2	Ant 1	Ant 2	
11a	6Mbps	1	149	5745		18.15		22.90		16.36	0.5	0.4	Pass
11a	6Mbps	1	157	5785		18.20		23.00		16.36	0.5	0.4	Pass
11a	6Mbps	1	165	5825		18.25		23.10		16.36	0.5	0.4	Pass
HT20	MCS0	1	149	5745		19.00		23.30		17.56	0.5	0.4	Pass
HT20	MCS0	1	157	5785		19.00		23.30		17.56	0.5	0.4	Pass
HT20	MCS0	1	165	5825		19.05		23.20		17.56	0.5	0.4	Pass
HT40	MCS0	1	151	5755		36.70		41.40		36.24	0.5	0.4	Pass
HT40	MCS0	1	159	5795		36.80		41.40		36.32	0.5	0.4	Pass
VHT20	MCS0	1	149	5745		19.00		23.00		17.56	0.5	0.4	Pass
VHT20	MCS0	1	157	5785		19.20		23.30		17.56	0.5	0.4	Pass
VHT20	MCS0	1	165	5825		19.20		23.40		17.56	0.5	0.4	Pass
VHT40	MCS0	1	151	5755		36.70		41.04		36.32	0.5	0.4	Pass
VHT40	MCS0	1	159	5795		36.80		41.40		36.32	0.5	0.4	Pass
VHT80	MCS0	1	155	5775		75.84		82.56		75.60	0.5	0.4	Pass
11a	6Mbps	2	149	5745	18.35	18.20	22.90	23.10	16.32	16.36	0.5		Pass
11a	6Mbps	2	157	5785	18.45	18.15	22.80	22.80	16.32	16.36	0.5		Pass
11a	6Mbps	2	165	5825	18.25	18.15	23.00	23.10	16.36	16.36	0.5		Pass
HT20	MCS0	2	149	5745	18.95	18.90	23.05	23.10	17.56	17.58	0.5		Pass
HT20	MCS0	2	157	5785	19.00	18.85	23.20	23.20	17.56	17.60	0.5		Pass
HT20	MCS0	2	165	5825	18.95	18.90	23.50	23.05	17.56	17.56	0.5		Pass
HT40	MCS0	2	151	5755	36.60	36.70	41.22	41.04	36.32	36.32	0.5		Pass
HT40	MCS0	2	159	5795	36.70	36.70	41.22	41.04	36.32	36.32	0.5		Pass
VHT20	MCS0	2	149	5745	19.05	19.00	23.30	22.90	17.56	17.56	0.5		Pass
VHT20	MCS0	2	157	5785	19.00	18.80	23.40	23.20	17.56	17.56	0.5		Pass
VHT20	MCS0	2	165	5825	19.10	18.90	23.30	23.25	17.56	17.56	0.5		Pass
VHT40	MCS0	2	151	5755	36.70	36.60	41.67	41.40	36.32	36.32	0.5		Pass
VHT40	MCS0	2	159	5795	36.70	36.60	41.40	41.22	36.32	36.32	0.5		Pass
VHT80	MCS0	2	155	5775	75.72	75.72	82.40	82.40	75.44	75.68	0.5		Pass

TEST RESULTS DATA
Average Power Table

Band IV														
Mod.	Data Rate	NTX	CH.	Freq. (MHz)	Duty Factor (dB)		Average Conducted Power (dBm)			FCC Conducted Power Limit (dBm)		DG (dBi)		Pass/Fail
					Ant 1	Ant 2	Ant 1	Ant 2	SUM	Ant 1	Ant 2	Ant 1	Ant 2	
11a	6Mbps	1	149	5745	0.29	0.33	11.75	12.73		30.00	30.00	0.50	0.40	Pass
11a	6Mbps	1	157	5785	0.29	0.33	11.96	12.90		30.00	30.00	0.50	0.40	Pass
11a	6Mbps	1	165	5825	0.29	0.33	11.90	12.92		30.00	30.00	0.50	0.40	Pass
HT20	MCS0	1	149	5745	0.31	0.31	11.90	12.93		30.00	30.00	0.50	0.40	Pass
HT20	MCS0	1	157	5785	0.31	0.31	11.65	12.92		30.00	30.00	0.50	0.40	Pass
HT20	MCS0	1	165	5825	0.31	0.31	11.81	12.94		30.00	30.00	0.50	0.40	Pass
HT40	MCS0	1	151	5755	0.61	0.60	11.90	12.86		30.00	30.00	0.50	0.40	Pass
HT40	MCS0	1	159	5795	0.61	0.60	11.92	12.95		30.00	30.00	0.50	0.40	Pass
VHT20	MCS0	1	149	5745	0.35	0.31	11.91	12.88		30.00	30.00	0.50	0.40	Pass
VHT20	MCS0	1	157	5785	0.35	0.31	11.73	12.92		30.00	30.00	0.50	0.40	Pass
VHT20	MCS0	1	165	5825	0.35	0.31	11.76	12.94		30.00	30.00	0.50	0.40	Pass
VHT40	MCS0	1	151	5755	0.60	0.60	11.94	12.86		30.00	30.00	0.50	0.40	Pass
VHT40	MCS0	1	159	5795	0.60	0.60	11.91	12.96		30.00	30.00	0.50	0.40	Pass
VHT80	MCS0	1	155	5775	1.20	1.14	11.44	12.30		30.00	30.00	0.50	0.40	Pass
11a	6Mbps	2	149	5745	0.29	0.29	11.80	11.74	14.78	30.00		0.5		Pass
11a	6Mbps	2	157	5785	0.29	0.29	11.94	11.90	14.93	30.00		0.5		Pass
11a	6Mbps	2	165	5825	0.29	0.29	11.98	11.63	14.82	30.00		0.5		Pass
HT20	MCS0	2	149	5745	0.31	0.31	11.84	11.47	14.66	30.00		0.5		Pass
HT20	MCS0	2	157	5785	0.31	0.31	11.63	11.67	14.66	30.00		0.5		Pass
HT20	MCS0	2	165	5825	0.31	0.31	11.94	11.72	14.84	30.00		0.5		Pass
HT40	MCS0	2	151	5755	0.67	0.61	11.90	11.79	14.86	30.00		0.5		Pass
HT40	MCS0	2	159	5795	0.67	0.61	11.72	11.56	14.65	30.00		0.5		Pass
VHT20	MCS0	2	149	5745	0.35	0.31	11.81	11.53	14.68	30.00		0.5		Pass
VHT20	MCS0	2	157	5785	0.35	0.31	11.75	11.55	14.66	30.00		0.5		Pass
VHT20	MCS0	2	165	5825	0.35	0.31	11.94	11.73	14.85	30.00		0.5		Pass
VHT40	MCS0	2	151	5755	0.60	0.60	11.95	11.67	14.83	30.00		0.5		Pass
VHT40	MCS0	2	159	5795	0.60	0.60	11.98	11.70	14.86	30.00		0.5		Pass
VHT80	MCS0	2	155	5775	1.20	1.16	11.46	11.34	14.41	30.00		0.5		Pass

TEST RESULTS DATA
Power Spectral Density

Band IV																
Mod.	Data Rate	NTX	CH.	Freq. (MHz)	Duty Factor (dB)		10log (500kHz /RBW) Factor (dB)		Average Power Density (dBm/500kHz)			Average PSD Limit (dBm/500kHz)		DG (dBi)		Pass /Fail
					Ant 1	Ant 2	Ant 1	Ant 2	Ant 1	Ant 2	SUM	Ant 1	Ant 2	Ant 1	Ant 2	
11a	6Mbps	1	149	5745	0.29	0.33	2.22	2.22		3.81		30.00	30.00	0.50	0.40	Pass
11a	6Mbps	1	157	5785	0.29	0.33	2.22	2.22		3.65		30.00	30.00	0.50	0.40	Pass
11a	6Mbps	1	165	5825	0.29	0.33	2.22	2.22		3.81		30.00	30.00	0.50	0.40	Pass
HT20	MCS0	1	149	5745	0.31	0.31	2.22	2.22		3.67		30.00	30.00	0.50	0.40	Pass
HT20	MCS0	1	157	5785	0.31	0.31	2.22	2.22		3.43		30.00	30.00	0.50	0.40	Pass
HT20	MCS0	1	165	5825	0.31	0.31	2.22	2.22		3.51		30.00	30.00	0.50	0.40	Pass
HT40	MCS0	1	151	5755	0.61	0.60	2.22	2.22		0.75		30.00	30.00	0.50	0.40	Pass
HT40	MCS0	1	159	5795	0.61	0.60	2.22	2.22		0.24		30.00	30.00	0.50	0.40	Pass
VHT20	MCS0	1	149	5745	0.35	0.31	2.22	2.22		3.57		30.00	30.00	0.50	0.40	Pass
VHT20	MCS0	1	157	5785	0.35	0.31	2.22	2.22		3.59		30.00	30.00	0.50	0.40	Pass
VHT20	MCS0	1	165	5825	0.35	0.31	2.22	2.22		3.49		30.00	30.00	0.50	0.40	Pass
VHT40	MCS0	1	151	5755	0.60	0.60	2.22	2.22		-0.04		30.00	30.00	0.50	0.40	Pass
VHT40	MCS0	1	159	5795	0.60	0.60	2.22	2.22		0.17		30.00	30.00	0.50	0.40	Pass
VHT80	MCS0	1	155	5775	1.20	1.14	2.22	2.22		-4.29		30.00	30.00	0.50	0.40	Pass
11a	6Mbps	2	149	5745	0.29	0.29	2.22				5.61	30.00		3.46	Pass	
11a	6Mbps	2	157	5785	0.29	0.29	2.22				5.73	30.00		3.46	Pass	
11a	6Mbps	2	165	5825	0.29	0.29	2.22				5.61	30.00		3.46	Pass	
HT20	MCS0	2	149	5745	0.31	0.31	2.22				5.12	30.00		3.46	Pass	
HT20	MCS0	2	157	5785	0.31	0.31	2.22				5.03	30.00		3.46	Pass	
HT20	MCS0	2	165	5825	0.31	0.31	2.22				5.25	30.00		3.46	Pass	
HT40	MCS0	2	151	5755	0.67	0.61	2.22				2.22	30.00		3.46	Pass	
HT40	MCS0	2	159	5795	0.67	0.61	2.22				2.03	30.00		3.46	Pass	
VHT20	MCS0	2	149	5745	0.35	0.31	2.22				5.41	30.00		3.46	Pass	
VHT20	MCS0	2	157	5785	0.35	0.31	2.22				6.21	30.00		3.46	Pass	
VHT20	MCS0	2	165	5825	0.35	0.31	2.22				5.31	30.00		3.46	Pass	
VHT40	MCS0	2	151	5755	0.60	0.60	2.22				1.90	30.00		3.46	Pass	
VHT40	MCS0	2	159	5795	0.60	0.60	2.22				1.88	30.00		3.46	Pass	
VHT80	MCS0	2	155	5775	1.20	1.16	2.22				-0.69	30.00		3.46	Pass	

TEST RESULTS DATA
Frequency Stability

Band IV										
Mod.	Data Rate	NTX	CH.	Freq. (MHz)	Center Frequency (MHz)	Frequency Deviation (MHz)	Frequency Stability (ppm)	Temperature (°C)	Voltage (V)	Note
11a	6Mbps	1	149	5745	5745.050	0.050	8.70	20	3.5	
11a	6Mbps	1	149	5745	5745.025	0.025	4.35	20	4.35	
11a	6Mbps	1	149	5745	5745.050	0.050	8.70	20	3.8	
11a	6Mbps	1	149	5745	5745.050	0.050	8.70	-30	3.8	
11a	6Mbps	1	149	5745	5745.000	0.000	0.00	50	3.8	



<TXBF Modes>

Test Engineer:	Kenny Chen	Temperature:	21~25	°C
Test Date:	2016/6/9	Relative Humidity:	51~54	%

TEST RESULTS DATA
6dB and 26dB EBW and 99% OBW

Band IV													
Mod.	Data Rate	NTX	CH.	Freq. (MHz)	99% Bandwidth (MHz)		26dB Bandwidth (MHz)		6 dB Bandwidth (MHz)		6 dB Bandwidth Min. Limit (MHz)		Pass/Fail
					Ant 1	Ant 2	Ant 1	Ant 2	Ant 1	Ant 2	Ant 1	Ant 2	
HT20	MCS0	2	149	5745	19.00	19.10	23.10	23.10	17.68	17.64	0.5		Pass
HT20	MCS0	2	157	5785	18.95	18.80	23.00	22.90	17.60	17.64	0.5		Pass
HT20	MCS0	2	165	5825	19.05	19.10	22.90	23.25	17.64	17.64	0.5		Pass
HT40	MCS0	2	151	5755	36.60	36.70	40.32	40.50	35.60	35.64	0.5		Pass
HT40	MCS0	2	159	5795	36.70	36.80	40.59	40.68	35.76	35.36	0.5		Pass
VHT20	MCS0	2	149	5745	19.05	18.95	23.20	23.30	17.56	17.56	0.5		Pass
VHT20	MCS0	2	157	5785	19.00	18.85	23.30	23.25	17.56	17.56	0.5		Pass
VHT20	MCS0	2	165	5825	19.05	19.20	23.20	23.20	17.56	17.56	0.5		Pass
VHT40	MCS0	2	151	5755	36.60	36.60	40.77	40.68	35.64	35.04	0.5		Pass
VHT40	MCS0	2	159	5795	36.80	36.80	40.95	40.50	35.36	35.68	0.5		Pass
VHT80	MCS0	2	155	5775	76.20	75.96	81.60	80.00	74.08	74.48	0.5		Pass

TEST RESULTS DATA
Average Power Table

Band IV														
Mod.	Data Rate	NTX	CH.	Freq. (MHz)	Duty Factor (dB)		Average Conducted Power (dBm)			FCC Conducted Power Limit (dBm)		DG (dBi)		Pass/Fail
					Ant 1	Ant 2	Ant 1	Ant 2	SUM	Ant 1	Ant 2	Ant 1	Ant 2	
11a	6Mbps	2	149	5745	0.00	0.00	11.30	11.00	14.16	30.00		0.50		Pass
11a	6Mbps	2	157	5785	0.00	0.00	11.80	10.80	14.34	30.00		0.50		Pass
11a	6Mbps	2	165	5825	0.00	0.00	11.90	11.20	14.57	30.00		0.50		Pass
HT20	MCS0	2	149	5745	0.00	0.00	11.30	11.40	14.36	30.00		3.46		Pass
HT20	MCS0	2	157	5785	0.00	0.00	11.70	11.50	14.61	30.00		3.46		Pass
HT20	MCS0	2	165	5825	0.00	0.00	11.50	11.50	14.51	30.00		3.46		Pass
HT40	MCS0	2	151	5755	0.00	0.00	11.70	11.80	14.76	30.00		3.46		Pass
HT40	MCS0	2	159	5795	0.00	0.00	11.40	11.50	14.46	30.00		3.46		Pass
VHT20	MCS0	2	149	5745	0.00	0.00	11.20	11.50	14.36	30.00		3.46		Pass
VHT20	MCS0	2	157	5785	0.00	0.00	11.20	11.10	14.16	30.00		3.46		Pass
VHT20	MCS0	2	165	5825	0.00	0.00	11.80	11.70	14.76	30.00		3.46		Pass
VHT40	MCS0	2	151	5755	0.00	0.00	11.90	11.30	14.62	30.00		3.46		Pass
VHT40	MCS0	2	159	5795	0.00	0.00	11.70	11.80	14.76	30.00		3.46		Pass
VHT80	MCS0	2	155	5775	0.00	0.00	11.40	11.30	14.36	30.00		3.46		Pass

TEST RESULTS DATA
Power Spectral Density

Band IV																
Mod.	Data Rate	NTX	CH.	Freq. (MHz)	Duty Factor (dB)		10log (500kHz /RBW) Factor (dB)		Average Power Density (dBm/500kHz)			Average PSD Limit (dBm/500kHz)		DG (dBi)		Pass /Fail
					Ant 1	Ant 2	Ant 1	Ant 2	Ant 1	Ant 2	SUM	Ant 1	Ant 2	Ant 1	Ant 2	
HT20	MCS0	2	149	5745	0.00	0.00	2.22				5.24	30.00		3.46		Pass
HT20	MCS0	2	157	5785	0.00	0.00	2.22				5.27	30.00		3.46		Pass
HT20	MCS0	2	165	5825	0.00	0.00	2.22				4.79	30.00		3.46		Pass
HT40	MCS0	2	151	5755	0.00	0.00	2.22				5.19	30.00		3.46		Pass
HT40	MCS0	2	159	5795	0.00	0.00	2.22				5.00	30.00		3.46		Pass
VHT20	MCS0	2	149	5745	0.00	0.00	2.22				5.24	30.00		3.46		Pass
VHT20	MCS0	2	157	5785	0.00	0.00	2.22				5.19	30.00		3.46		Pass
VHT20	MCS0	2	165	5825	0.00	0.00	2.22				4.80	30.00		3.46		Pass
VHT40	MCS0	2	151	5755	0.00	0.00	2.22				5.10	30.00		3.46		Pass
VHT40	MCS0	2	159	5795	0.00	0.00	2.22				4.90	30.00		3.46		Pass
VHT80	MCS0	2	155	5775	0.00	0.00	2.22				4.77	30.00		3.46		Pass



Appendix B. Radiated Spurious Emission

Test Engineer :	Luke Chang/Jesse Wang/Derreck Chen/James Chiu	Temperature :	21~24°C
		Relative Humidity :	50~54%

<Non-TXBF Modes>

Band 4 - 5725~5850MHz

WIFI 802.11a (Band Edge @ 3m)

WIFI Ant. 2	Note	Frequency (MHz)	Level (dBμV/m)	Over Limit (dB)	Limit Line (dBμV/m)	Read Level (dBμV)	Antenna Factor (dB/m)	Cable Loss (dB)	Preamp Factor (dB)	Ant Pos (cm)	Table Pos (deg)	Peak Avg. (P/A)	Pol. (H/V)	
802.11a CH 149 5745MHz		5648.6	50.98	-17.32	68.3	38.77	35.53	11.95	35.27	100	286	P	H	
		5655	51.77	-20.24	72.01	39.56	35.53	11.95	35.27	100	286	P	H	
		5716.6	53.64	-56.31	109.95	41.32	35.54	12.06	35.28	100	286	P	H	
		5723.8	57.59	-61.97	119.56	45.27	35.54	12.06	35.28	100	286	P	H	
	*	5745	106.68	-	-	94.31	35.55	12.11	35.29	100	286	P	H	
	*	5745	98.63	-	-	86.26	35.55	12.11	35.29	100	286	A	H	
														H
														H
			5631.2	50.04	-18.26	68.3	37.84	35.52	11.95	35.27	266	64	P	V
			5697.4	50.73	-52.65	103.38	38.47	35.54	12	35.28	266	64	P	V
			5717.8	52.68	-57.6	110.28	40.36	35.54	12.06	35.28	266	64	P	V
			5724.4	60.34	-60.59	120.93	48.02	35.54	12.06	35.28	266	64	P	V
	*		5745	102.61	-	-	90.24	35.55	12.11	35.29	266	64	P	V
	*		5745	95.18	-	-	82.81	35.55	12.11	35.29	266	64	A	V
														V
													V	



WIFI Ant. 2	Note	Frequency (MHz)	Level (dBμV/m)	Over Limit (dB)	Limit Line (dBμV/m)	Read Level (dBμV)	Antenna Factor (dB/m)	Cable Loss (dB)	Preamp Factor (dB)	Ant Pos (cm)	Table Pos (deg)	Peak Avg. (P/A)	Pol. (H/V)
		5646	51.02	-17.28	68.3	38.81	35.53	11.95	35.27	102	289	P	H
		5685	50.41	-43.82	94.23	38.15	35.54	12	35.28	102	289	P	H
		5719.2	51.01	-59.67	110.68	38.69	35.54	12.06	35.28	102	289	P	H
		5720.6	50.83	-61.44	112.27	38.51	35.54	12.06	35.28	102	289	P	H
	*	5785	104.36	-	-	91.93	35.56	12.17	35.3	102	289	P	H
	*	5785	96.13	-	-	83.7	35.56	12.17	35.3	102	289	A	H
		5853.6	49.97	-64.12	114.09	37.43	35.57	12.28	35.31	102	289	P	H
		5861.4	51.79	-57.32	109.11	39.14	35.57	12.39	35.31	102	289	P	H
		5904.4	51.47	-32.04	83.51	38.7	35.58	12.51	35.32	102	289	P	H
		5949.8	52.21	-16.09	68.3	39.33	35.59	12.62	35.33	102	289	P	H
													H
													H
802.11a													
CH 157													
5785MHz		5630.2	50.42	-17.88	68.3	38.22	35.52	11.95	35.27	290	51	P	V
		5657.4	50.11	-23.69	73.8	37.9	35.53	11.95	35.27	290	51	P	V
		5718.8	51.14	-59.42	110.56	38.82	35.54	12.06	35.28	290	51	P	V
		5724.2	50.46	-70.02	120.48	38.14	35.54	12.06	35.28	290	51	P	V
	*	5785	104.51	-	-	92.08	35.56	12.17	35.3	290	51	P	V
	*	5785	96.85	-	-	84.42	35.56	12.17	35.3	290	51	A	V
		5852.8	49.39	-66.53	115.92	36.85	35.57	12.28	35.31	290	51	P	V
		5875	50.77	-54.53	105.3	38.12	35.58	12.39	35.32	290	51	P	V
		5899	51.24	-36.26	87.5	38.59	35.58	12.39	35.32	290	51	P	V
		5947.4	51.96	-16.34	68.3	39.08	35.59	12.62	35.33	290	51	P	V
													V
													V



WIFI Ant. 2	Note	Frequency (MHz)	Level (dBμV/m)	Over Limit (dB)	Limit Line (dBμV/m)	Read Level (dBμV)	Antenna Factor (dB/m)	Cable Loss (dB)	Preamp Factor (dB)	Ant Pos (cm)	Table Pos (deg)	Peak Avg. (P/A)	Pol. (H/V)	
802.11a CH 165 5825MHz	*	5825	105.65	-	-	93.11	35.57	12.28	35.31	229	293	P	H	
	*	5825	98.4	-	-	85.86	35.57	12.28	35.31	229	293	A	H	
		5850.4	57.56	-63.83	121.39	45.02	35.57	12.28	35.31	229	293	P	H	
		5861	52.84	-56.38	109.22	40.19	35.57	12.39	35.31	229	293	P	H	
		5894.2	51.48	-39.57	91.05	38.83	35.58	12.39	35.32	229	293	P	H	
		5928.8	50.55	-17.75	68.3	37.78	35.59	12.51	35.33	229	293	P	H	
														H
														H
	*	5825	103.04	-	-	90.5	35.57	12.28	35.31	374	29	P	V	
	*	5825	95.69	-	-	83.15	35.57	12.28	35.31	374	29	A	V	
		5851.6	52.49	-66.16	118.65	39.95	35.57	12.28	35.31	374	29	P	V	
		5856.2	51.37	-59.19	110.56	38.83	35.57	12.28	35.31	374	29	P	V	
		5877.2	50.24	-53.43	103.67	37.59	35.58	12.39	35.32	374	29	P	V	
		5932.2	50.86	-17.44	68.3	38.09	35.59	12.51	35.33	374	29	P	V	
														V
														V
													V	
Remark	1. No other spurious found. 2. All results are PASS against Peak and Average limit line.													



Band 4 5725~5850MHz
WIFI 802.11a (Harmonic @ 3m)

WIFI Ant. 2	Note	Frequency (MHz)	Level (dBμV/m)	Over Limit (dB)	Limit Line (dBμV/m)	Read Level (dBμV)	Antenna Factor (dB/m)	Cable Loss (dB)	Preamp Factor (dB)	Ant Pos (cm)	Table Pos (deg)	Peak Avg. (P/A)	Pol. (H/V)
802.11a CH 149 5745MHz		11490	40.24	-33.76	74	42.04	38.38	17.16	57.34	100	0	P	H
													H
													H
													H
		11490	41.33	-32.67	74	43.13	38.38	17.16	57.34	100	0	P	V
													V
													V
802.11a CH 157 5785MHz		11570	40.89	-33.11	74	42.45	38.47	17.16	57.19	100	0	P	H
		17355	41.26	-27.04	68.3	34.37	41.99	20.84	55.94	100	0	P	H
													H
													H
		11570	41.15	-32.85	74	42.71	38.47	17.16	57.19	100	0	P	V
		17355	39.74	-28.56	68.3	32.85	41.99	20.84	55.94	100	0	P	V
													V
802.11a CH 165 5825MHz		11650	40.09	-33.91	74	41.47	38.54	17.16	57.08	100	0	P	H
		17475	41.47	-26.83	68.3	34.61	41.92	20.93	55.99	100	0	P	H
													H
													H
		11650	40.26	-33.74	74	41.64	38.54	17.16	57.08	100	0	P	V
		17475	40.46	-27.84	68.3	33.6	41.92	20.93	55.99	100	0	P	V
													V
Remark	1. No other spurious found.												
	2. All results are PASS against Peak and Average limit line.												



Band 4 5725~5850MHz
WIFI 802.11ac VHT20 (Band Edge @ 3m)

WIFI Ant. 2	Note	Frequency (MHz)	Level (dBμV/m)	Over Limit (dB)	Limit Line (dBμV/m)	Read Level (dBμV)	Antenna Factor (dB/m)	Cable Loss (dB)	Preamp Factor (dB)	Ant Pos (cm)	Table Pos (deg)	Peak Avg. (P/A)	Pol. (H/V)	
802.11ac VHT20 CH 149 5745MHz		5628.2	49.89	-18.41	68.3	37.69	35.52	11.95	35.27	100	291	P	H	
		5699.8	52.19	-52.96	105.15	39.93	35.54	12	35.28	100	291	P	H	
		5701	52.97	-52.61	105.58	40.65	35.54	12.06	35.28	100	291	P	H	
		5724.6	60.11	-61.28	121.39	47.79	35.54	12.06	35.28	100	291	P	H	
	*	5745	103.92	-	-	91.55	35.55	12.11	35.29	100	291	P	H	
	*	5745	96.84	-	-	84.47	35.55	12.11	35.29	100	291	A	H	
														H
														H
			5603.4	50.81	-17.49	68.3	38.66	35.52	11.89	35.26	323	43	P	V
			5693.8	50.8	-49.93	100.73	38.54	35.54	12	35.28	323	43	P	V
			5715.6	54	-55.67	109.67	41.68	35.54	12.06	35.28	323	43	P	V
			5723.8	61.67	-57.89	119.56	49.35	35.54	12.06	35.28	323	43	P	V
	*		5745	104.25	-	-	91.88	35.55	12.11	35.29	323	43	P	V
	*		5745	97.31	-	-	84.94	35.55	12.11	35.29	323	43	A	V
														V
														V



WIFI Ant. 2	Note	Frequency (MHz)	Level (dBμV/m)	Over Limit (dB)	Limit Line (dBμV/m)	Read Level (dBμV)	Antenna Factor (dB/m)	Cable Loss (dB)	Preamp Factor (dB)	Ant Pos (cm)	Table Pos (deg)	Peak Avg. (P/A)	Pol. (H/V)
		5624.4	49.58	-18.72	68.3	37.37	35.52	11.95	35.26	102	290	P	H
		5674.6	51.21	-35.33	86.54	38.95	35.53	12	35.27	102	290	P	H
		5706.8	50.99	-56.22	107.21	38.67	35.54	12.06	35.28	102	290	P	H
		5724.2	49.14	-71.34	120.48	36.82	35.54	12.06	35.28	102	290	P	H
	*	5785	104.59	-	-	92.16	35.56	12.17	35.3	102	290	P	H
	*	5785	97.3	-	-	84.87	35.56	12.17	35.3	102	290	A	H
		5852	50.12	-67.62	117.74	37.58	35.57	12.28	35.31	102	290	P	H
		5863.8	50.64	-57.79	108.43	37.99	35.57	12.39	35.31	102	290	P	H
		5891	51.31	-42.12	93.43	38.66	35.58	12.39	35.32	102	290	P	H
		5932.8	50.48	-17.82	68.3	37.71	35.59	12.51	35.33	102	290	P	H
													H
													H
802.11ac													
VHT20													
CH 157		5623	49.34	-18.96	68.3	37.13	35.52	11.95	35.26	306	53	P	V
5785MHz		5692	49.99	-49.41	99.4	37.73	35.54	12	35.28	306	53	P	V
		5720	50.91	-59.99	110.9	38.59	35.54	12.06	35.28	306	53	P	V
		5720	50.91	-59.99	110.9	38.59	35.54	12.06	35.28	306	53	P	V
	*	5785	101.99	-	-	89.56	35.56	12.17	35.3	306	53	P	V
	*	5785	95.56	-	-	83.13	35.56	12.17	35.3	306	53	A	V
		5851.6	49.66	-68.99	118.65	37.12	35.57	12.28	35.31	306	53	P	V
		5865	50.47	-57.63	108.1	37.82	35.57	12.39	35.31	306	53	P	V
		5890.8	50.83	-42.74	93.57	38.18	35.58	12.39	35.32	306	53	P	V
		5932	50.56	-17.74	68.3	37.79	35.59	12.51	35.33	306	53	P	V
													V
													V



WIFI Ant. 2	Note	Frequency (MHz)	Level (dBμV/m)	Over Limit (dB)	Limit Line (dBμV/m)	Read Level (dBμV)	Antenna Factor (dB/m)	Cable Loss (dB)	Preamp Factor (dB)	Ant Pos (cm)	Table Pos (deg)	Peak Avg. (P/A)	Pol. (H/V)	
802.11ac VHT20 CH 165 5825MHz	*	5825	104.85	-	-	92.31	35.57	12.28	35.31	229	293	P	H	
	*	5825	97.88	-	-	85.34	35.57	12.28	35.31	229	293	A	H	
		5850	55.78	-66.52	122.3	43.24	35.57	12.28	35.31	229	293	P	H	
		5856.4	53.98	-56.53	110.51	41.44	35.57	12.28	35.31	229	293	P	H	
		5878.2	51.35	-51.57	102.92	38.7	35.58	12.39	35.32	229	293	P	H	
		5932.6	50.04	-18.26	68.3	37.27	35.59	12.51	35.33	229	293	P	H	
														H
														H
	*	5825	101.21	-	-	88.67	35.57	12.28	35.31	317	54	P	V	
	*	5825	95.4	-	-	82.86	35.57	12.28	35.31	317	54	A	V	
		5850.4	50.33	-71.06	121.39	37.79	35.57	12.28	35.31	317	54	P	V	
		5873.6	50.65	-55.04	105.69	37.99	35.58	12.39	35.31	317	54	P	V	
		5881.8	51.1	-49.15	100.25	38.45	35.58	12.39	35.32	317	54	P	V	
		5932.4	51.45	-16.85	68.3	38.68	35.59	12.51	35.33	317	54	P	V	
														V
													V	
Remark	1. No other spurious found. 2. All results are PASS against Peak and Average limit line.													



Band 4 5725~5850MHz
WIFI 802.11ac VHT20 (Harmonic @ 3m)

WIFI Ant. 2	Note	Frequency (MHz)	Level (dBμV/m)	Over Limit (dB)	Limit Line (dBμV/m)	Read Level (dBμV)	Antenna Factor (dB/m)	Cable Loss (dB)	Preamp Factor (dB)	Ant Pos (cm)	Table Pos (deg)	Peak Avg. (P/A)	Pol. (H/V)	
802.11ac VHT20 CH 149 5745MHz		11490	39.65	-34.35	74	41.45	38.38	17.16	57.34	100	0	P	H	
													H	
													H	
													H	
			11490	39.96	-34.04	74	41.76	38.38	17.16	57.34	100	0	P	V
														V
														V
802.11ac VHT20 CH 157 5785MHz		11570	40.55	-33.45	74	42.11	38.47	17.16	57.19	100	0	P	H	
		17355	39.69	-28.61	68.3	32.8	41.99	20.84	55.94	100	0	P	H	
													H	
													H	
			11570	42.01	-31.99	74	43.57	38.47	17.16	57.19	100	0	P	V
			17355	39.77	-28.53	68.3	32.88	41.99	20.84	55.94	100	0	P	V
														V
802.11ac VHT20 CH 165 5825MHz		11650	40.09	-33.91	74	41.47	38.54	17.16	57.08	100	0	P	H	
		17472	40.94	-27.36	68.3	34.08	41.92	20.93	55.99	100	0	P	H	
													H	
													H	
			11650	40.43	-33.57	74	41.81	38.54	17.16	57.08	100	0	P	V
			17472	40.62	-27.68	68.3	33.76	41.92	20.93	55.99	100	0	P	V
														V
Remark	1. No other spurious found.													
	2. All results are PASS against Peak and Average limit line.													



Band 4 5725~5850MHz
WIFI 802.11ac VHT40 (Band Edge @ 3m)

WIFI Ant. 2	Note	Frequency (MHz)	Level (dBμV/m)	Over Limit (dB)	Limit Line (dBμV/m)	Read Level (dBμV)	Antenna Factor (dB/m)	Cable Loss (dB)	Preamp Factor (dB)	Ant Pos (cm)	Table Pos (deg)	Peak Avg. (P/A)	Pol. (H/V)
		5650	49.27	-19.03	68.3	37.06	35.53	11.95	35.27	103	288	P	H
		5696.4	54.6	-48.05	102.65	42.34	35.54	12	35.28	103	288	P	H
		5714.8	60.47	-48.98	109.45	48.15	35.54	12.06	35.28	103	288	P	H
		5721.6	62.05	-52.5	114.55	49.73	35.54	12.06	35.28	103	288	P	H
	*	5755	100.76	-	-	88.39	35.55	12.11	35.29	103	288	P	H
	*	5755	93.54	-	-	81.17	35.55	12.11	35.29	103	288	A	H
		5851	49.93	-70.09	120.02	37.39	35.57	12.28	35.31	103	288	P	H
		5859.6	50.72	-58.89	109.61	38.18	35.57	12.28	35.31	103	288	P	H
		5904	51.47	-32.33	83.8	38.7	35.58	12.51	35.32	103	288	P	H
		5930.2	51.02	-17.28	68.3	38.25	35.59	12.51	35.33	103	288	P	H
													H
													H
802.11ac VHT40 CH 151 5755MHz		5630.6	50.81	-17.49	68.3	38.61	35.52	11.95	35.27	305	53	P	V
		5700	53.27	-52.03	105.3	41.01	35.54	12	35.28	305	53	P	V
		5719.6	60.14	-50.65	110.79	47.82	35.54	12.06	35.28	305	53	P	V
		5724.4	60.95	-59.98	120.93	48.63	35.54	12.06	35.28	305	53	P	V
	*	5755	100.86	-	-	88.49	35.55	12.11	35.29	305	53	P	V
	*	5755	93.92	-	-	81.55	35.55	12.11	35.29	305	53	A	V
		5852	49.57	-68.17	117.74	37.03	35.57	12.28	35.31	305	53	P	V
		5861	50	-59.22	109.22	37.35	35.57	12.39	35.31	305	53	P	V
		5907.6	50.38	-30.76	81.14	37.61	35.58	12.51	35.32	305	53	P	V
		5942.2	50.15	-18.15	68.3	37.27	35.59	12.62	35.33	305	53	P	V
													V
													V



WIFI Ant. 2	Note	Frequency (MHz)	Level (dBμV/m)	Over Limit (dB)	Limit Line (dBμV/m)	Read Level (dBμV)	Antenna Factor (dB/m)	Cable Loss (dB)	Preamp Factor (dB)	Ant Pos (cm)	Table Pos (deg)	Peak Avg. (P/A)	Pol. (H/V)
		5638.6	50.13	-18.17	68.3	37.92	35.53	11.95	35.27	102	291	P	H
		5699.6	51.19	-53.82	105.01	38.93	35.54	12	35.28	102	291	P	H
		5718	53.13	-57.21	110.34	40.81	35.54	12.06	35.28	102	291	P	H
		5722.6	56.05	-60.78	116.83	43.73	35.54	12.06	35.28	102	291	P	H
	*	5795	100.36	-	-	87.93	35.56	12.17	35.3	102	291	P	H
	*	5795	94.71	-	-	82.28	35.56	12.17	35.3	102	291	A	H
		5853.8	54.05	-59.59	113.64	41.51	35.57	12.28	35.31	102	291	P	H
		5856.2	53.28	-57.28	110.56	40.74	35.57	12.28	35.31	102	291	P	H
		5876	54.13	-50.43	104.56	41.48	35.58	12.39	35.32	102	291	P	H
		5931.6	50.93	-17.37	68.3	38.16	35.59	12.51	35.33	102	291	P	H
													H
													H
802.11ac													
VHT40													
CH 159		5610	49.66	-18.64	68.3	37.51	35.52	11.89	35.26	301	56	P	V
5795MHz		5684	50.09	-43.41	93.5	37.83	35.54	12	35.28	301	56	P	V
		5717.4	52.47	-57.7	110.17	40.15	35.54	12.06	35.28	301	56	P	V
		5720.2	52.11	-59.25	111.36	39.79	35.54	12.06	35.28	301	56	P	V
	*	5795	100.92	-	-	88.49	35.56	12.17	35.3	301	56	P	V
	*	5795	94.25	-	-	81.82	35.56	12.17	35.3	301	56	A	V
		5851	51.56	-68.46	120.02	39.02	35.57	12.28	35.31	301	56	P	V
		5858.2	51.47	-58.53	110	38.93	35.57	12.28	35.31	301	56	P	V
		5899.6	52.27	-34.79	87.06	39.62	35.58	12.39	35.32	301	56	P	V
		5935.4	51.01	-17.29	68.3	38.24	35.59	12.51	35.33	301	56	P	V
													V
													V
Remark	1. No other spurious found. 2. All results are PASS against Peak and Average limit line.												



Band 4 5725~5850MHz
WIFI 802.11ac VHT40 (Harmonic @ 3m)

WIFI Ant. 2	Note	Frequency (MHz)	Level (dBμV/m)	Over Limit (dB)	Limit Line (dBμV/m)	Read Level (dBμV)	Antenna Factor (dB/m)	Cable Loss (dB)	Preamp Factor (dB)	Ant Pos (cm)	Table Pos (deg)	Peak Avg. (P/A)	Pol. (H/V)	
802.11ac VHT40 CH 151 5755MHz		11510	40.46	-33.54	74	42.2	38.4	17.16	57.3	100	0	P	H	
		17265	39.22	-29.08	68.3	32.3	42.04	20.79	55.91	100	0	P	H	
													H	
													H	
			11510	40.78	-33.22	74	42.52	38.4	17.16	57.3	100	0	P	V
			17265	38.76	-29.54	68.3	31.84	42.04	20.79	55.91	100	0	P	V
														V
802.11ac VHT40 CH 159 5795MHz		11590	41.06	-32.94	74	42.57	38.49	17.16	57.16	100	0	P	H	
		17385	39.68	-28.62	68.3	32.79	41.97	20.87	55.95	100	0	P	H	
													H	
													H	
			11590	41.82	-32.18	74	43.33	38.49	17.16	57.16	100	0	P	V
			17385	39.71	-28.59	68.3	32.82	41.97	20.87	55.95	100	0	P	V
														V
Remark	1. No other spurious found.													
	2. All results are PASS against Peak and Average limit line.													



Band 4 5725~5850MHz
WIFI 802.11ac VHT80 (Band Edge @ 3m)

WIFI Ant. 2	Note	Frequency (MHz)	Level (dBμV/m)	Over Limit (dB)	Limit Line (dBμV/m)	Read Level (dBμV)	Antenna Factor (dB/m)	Cable Loss (dB)	Preamp Factor (dB)	Ant Pos (cm)	Table Pos (deg)	Peak Avg. (P/A)	Pol. (H/V)
		5648.6	54.33	-13.97	68.3	42.12	35.53	11.95	35.27	251	221	P	H
		5698	60.39	-43.44	103.83	48.13	35.54	12	35.28	251	221	P	H
		5715.8	60.79	-48.94	109.73	48.47	35.54	12.06	35.28	251	221	P	H
		5722	60.14	-55.32	115.46	47.82	35.54	12.06	35.28	251	221	P	H
	*	5775	98.07	-	-	85.7	35.56	12.11	35.3	251	221	P	H
	*	5775	90.54	-	-	78.17	35.56	12.11	35.3	251	221	A	H
		5853.8	56.78	-56.86	113.64	44.24	35.57	12.28	35.31	251	221	P	H
		5857.2	55.29	-54.99	110.28	42.75	35.57	12.28	35.31	251	221	P	H
		5879.8	55.12	-46.61	101.73	42.47	35.58	12.39	35.32	251	221	P	H
		5943	52.2	-16.1	68.3	39.32	35.59	12.62	35.33	251	221	P	H
													H
													H
802.11ac VHT80 CH 155 5775MHz		5638.4	53.29	-15.01	68.3	41.08	35.53	11.95	35.27	303	55	P	V
		5687.2	55.17	-40.69	95.86	42.91	35.54	12	35.28	303	55	P	V
		5717.8	56.72	-53.56	110.28	44.4	35.54	12.06	35.28	303	55	P	V
		5723	58.08	-59.66	117.74	45.76	35.54	12.06	35.28	303	55	P	V
	*	5775	97.44	-	-	85.07	35.56	12.11	35.3	303	55	P	V
	*	5775	89.76	-	-	77.39	35.56	12.11	35.3	303	55	A	V
		5854.2	52.4	-60.32	112.72	39.86	35.57	12.28	35.31	303	55	P	V
		5862.8	53.96	-54.75	108.71	41.31	35.57	12.39	35.31	303	55	P	V
		5888.4	52.07	-43.28	95.35	39.42	35.58	12.39	35.32	303	55	P	V
		5929	51.53	-16.77	68.3	38.76	35.59	12.51	35.33	303	55	P	V
													V
													V
Remark	1. No other spurious found. 2. All results are PASS against Peak and Average limit line.												



Band 4 5725~5850MHz

WIFI 802.11ac VHT80 (Harmonic @ 3m)

WIFI Ant. 2	Note	Frequency (MHz)	Level (dBμV/m)	Over Limit (dB)	Limit Line (dBμV/m)	Read Level (dBμV)	Antenna Factor (dB/m)	Cable Loss (dB)	Preamp Factor (dB)	Ant Pos (cm)	Table Pos (deg)	Peak Avg. (P/A)	Pol. (H/V)	
802.11ac VHT80 CH 155 5775MHz		11550	41.15	-32.85	74	42.76	38.45	17.16	57.22	100	0	P	H	
		17325	39.53	-28.77	68.3	32.64	42.01	20.81	55.93	100	0	P	H	
													H	
													H	
			11550	40.83	-33.17	74	42.44	38.45	17.16	57.22	100	0	P	V
			17325	39.43	-28.87	68.3	32.54	42.01	20.81	55.93	100	0	P	V
														V
Remark	1. No other spurious found. 2. All results are PASS against Peak and Average limit line.													



Emission below 1GHz
5GHz WIFI 802.11a (LF @ 3m)

WIFI	Note	Frequency	Level	Over	Limit	Read	Antenna	Cable	Preamp	Ant	Table	Peak	Pol.	
Ant.				Limit	Line	Level	Factor	Loss	Factor	Pos	Pos	Avg.		
2		(MHz)	(dBμV/m)	(dB)	(dBμV/m)	(dBμV)	(dB/m)	(dB)	(dB)	(cm)	(deg)	(P/A)	(H/V)	
5GHz 802.11a LF		30.54	27.73	-12.27	40	32.56	25.46	1.07	31.36	-	-	P	H	
		106.14	23.61	-19.89	43.5	36.64	16.94	1.55	31.52	-	-	P	H	
		300	26.06	-19.94	46	35.21	19.8	2.32	31.27	-	-	P	H	
		659.8	29.78	-16.22	46	30.97	26	3.57	30.76	-	-	P	H	
		778.1	32.84	-13.16	46	32.16	27.48	3.82	30.62	-	-	P	H	
		895	34.66	-11.34	46	32.06	28.97	4.17	30.54	100	0	P	H	
														H
														H
														H
														H
														H
														H
			30	29.74	-10.26	40	34.02	26	1.07	31.35	100	0	P	V
			139.89	24.77	-18.73	43.5	36.72	18	1.55	31.5	-	-	P	V
			240.06	25.96	-20.04	46	37.2	18.09	2.07	31.4	-	-	P	V
			737.5	30.9	-15.1	46	30.83	27	3.74	30.67	-	-	P	V
			862.8	32.72	-13.28	46	30.33	28.78	4.17	30.56	-	-	P	V
			939.8	33.21	-12.79	46	29.66	29.96	4.12	30.53	-	-	P	V
														V
														V
													V	
													V	
													V	
													V	
Remark	1. No other spurious found. 2. All results are PASS against limit line.													



Emission below 1GHz

5GHz WIFI 802.11ac VHT20 (LF @ 3m)

WIFI	Note	Frequency	Level	Over	Limit	Read	Antenna	Cable	Preamp	Ant	Table	Peak	Pol.	
Ant.				Limit	Line	Level	Factor	Loss	Factor	Pos	Pos	Avg.		
2		(MHz)	(dBμV/m)	(dB)	(dBμV/m)	(dBμV)	(dB/m)	(dB)	(dB)	(cm)	(deg)	(P/A)	(H/V)	
5GHz 802.11 VHT20 LF		30.54	27.97	-12.03	40	32.8	25.46	1.07	31.36	100	0	P	H	
		148.8	23.39	-20.11	43.5	35.36	17.75	1.78	31.5	-	-	P	H	
		240.06	25.25	-20.75	46	36.49	18.09	2.07	31.4	-	-	P	H	
		741	30.09	-15.91	46	29.88	27.06	3.82	30.67	-	-	P	H	
		854.4	33.71	-12.29	46	31.44	28.73	4.1	30.56	-	-	P	H	
		899.2	33.67	-12.33	46	31.05	28.99	4.17	30.54	-	-	P	H	
														H
														H
														H
														H
														H
														H
			30	29.91	-10.09	40	34.19	26	1.07	31.35	100	0	P	V
			139.62	23.88	-19.62	43.5	35.83	18	1.55	31.5	-	-	P	V
			240.06	26.83	-19.17	46	38.07	18.09	2.07	31.4	-	-	P	V
			622	31.3	-14.7	46	32.91	25.62	3.57	30.8	-	-	P	V
			754.3	33.4	-12.6	46	32.98	27.25	3.82	30.65	-	-	P	V
			903.4	34.84	-11.16	46	32.19	29.07	4.12	30.54	-	-	P	V
													V	
													V	
													V	
													V	
													V	
													V	
Remark	1. No other spurious found. 2. All results are PASS against limit line.													



Emission below 1GHz

5GHz WIFI 802.11ac VHT40 (LF @ 3m)

WIFI	Note	Frequency	Level	Over	Limit	Read	Antenna	Cable	Preamp	Ant	Table	Peak	Pol.	
Ant.				Limit	Line	Level	Factor	Loss	Factor	Pos	Pos	Avg.		
2		(MHz)	(dBμV/m)	(dB)	(dBμV/m)	(dBμV)	(dB/m)	(dB)	(dB)	(cm)	(deg)	(P/A)	(H/V)	
5GHz 802.11ac VHT40 LF		30.81	28.96	-11.04	40	33.79	25.46	1.07	31.36	-	-	P	H	
		155.82	23.3	-20.2	43.5	35.74	17.28	1.78	31.5	-	-	P	H	
		245.46	26.43	-19.57	46	37.19	18.55	2.07	31.38	-	-	P	H	
		792.1	33.08	-12.92	46	32.16	27.62	3.9	30.6	-	-	P	H	
		873.3	34.58	-11.42	46	32.12	28.84	4.17	30.55	-	-	P	H	
		938.4	35.46	-10.54	46	31.95	29.92	4.12	30.53	100	0	P	H	
														H
														H
														H
														H
														H
														H
			30	29.15	-10.85	40	33.43	26	1.07	31.35	100	0	P	V
			143.67	25.36	-18.14	43.5	37.19	17.89	1.78	31.5	-	-	P	V
			226.56	24.99	-21.01	46	37.38	16.96	2.07	31.42	-	-	P	V
			674.5	30.63	-15.37	46	31.59	26.14	3.65	30.75	-	-	P	V
			799.1	35.14	-10.86	46	34.14	27.69	3.9	30.59	-	-	P	V
			890.1	34.78	-11.22	46	32.21	28.94	4.17	30.54	-	-	P	V
													V	
													V	
													V	
													V	
													V	
													V	
Remark	1. No other spurious found. 2. All results are PASS against limit line.													



Emission below 1GHz

5GHz WIFI 802.11ac VHT80 (LF @ 3m)

WIFI	Note	Frequency	Level	Over	Limit	Read	Antenna	Cable	Preamp	Ant	Table	Peak	Pol.	
Ant.				Limit	Line	Level	Factor	Loss	Factor	Pos	Pos	Avg.		
2		(MHz)	(dBμV/m)	(dB)	(dBμV/m)	(dBμV)	(dB/m)	(dB)	(dB)	(cm)	(deg)	(P/A)	(H/V)	
5GHz 802.11ac VHT80 LF		30.81	27.95	-12.05	40	32.78	25.46	1.07	31.36	-	-	P	H	
		151.5	21.99	-21.51	43.5	34.08	17.63	1.78	31.5	-	-	P	H	
		237.09	25.88	-20.12	46	37.45	17.76	2.07	31.4	-	-	P	H	
		684.3	29.96	-16.04	46	30.8	26.25	3.65	30.74	-	-	P	H	
		847.4	32.34	-13.66	46	30.15	28.66	4.1	30.57	-	-	P	H	
		923	33.98	-12.02	46	30.84	29.56	4.12	30.54	100	0	P	H	
														H
														H
														H
														H
														H
														H
														H
														H
			30	28.29	-11.71	40	32.57	26	1.07	31.35	100	0	P	V
			143.67	24.63	-18.87	43.5	36.46	17.89	1.78	31.5	-	-	P	V
			226.56	24.96	-21.04	46	37.35	16.96	2.07	31.42	-	-	P	V
			881	32.63	-13.37	46	30.13	28.88	4.17	30.55	-	-	P	V
			893.6	32.67	-13.33	46	30.08	28.96	4.17	30.54	-	-	P	V
		940.5	33.81	-12.19	46	30.28	29.99	4.07	30.53	-	-	P	V	
													V	
													V	
													V	
													V	
													V	
													V	
Remark	1. No other spurious found. 2. All results are PASS against limit line.													



Note symbol

*	Fundamental Frequency which can be ignored. However, the level of any unwanted emissions shall not exceed the level of the fundamental frequency.
!	Test result is over limit line.
P/A	Peak or Average
H/V	Horizontal or Vertical



A calculation example for radiated spurious emission is shown as below:

WIFI	Note	Frequency	Level	Over	Limit	Read	Antenna	Cable	Preamp	Ant	Table	Peak	Pol.
Ant.				Limit	Line	Level	Factor	Loss	Factor	Pos	Pos	Avg.	
2		(MHz)	(dBμV/m)	(dB)	(dBμV/m)	(dBμV)	(dB/m)	(dB)	(dB)	(cm)	(deg)	(P/A)	(H/V)
802.11b		2390	55.45	-18.55	74	54.51	32.22	4.58	35.86	103	308	P	H
CH 01													
2412MHz		2390	43.54	-10.46	54	42.6	32.22	4.58	35.86	103	308	A	H

- Level(dBμV/m) =
Antenna Factor(dB/m) + Cable Loss(dB) + Read Level(dBμV) - Preamp Factor(dB)
- Over Limit(dB) = Level(dBμV/m) – Limit Line(dBμV/m)

For Peak Limit @ 2390MHz:

- Level(dBμV/m)
= Antenna Factor(dB/m) + Cable Loss(dB) + Read Level(dBμV) - Preamp Factor(dB)
= 32.22(dB/m) + 4.58(dB) + 54.51(dBμV) – 35.86 (dB)
= 55.45 (dBμV/m)
- Over Limit(dB)
= Level(dBμV/m) – Limit Line(dBμV/m)
= 55.45(dBμV/m) – 74(dBμV/m)
= -18.55(dB)

For Average Limit @ 2390MHz:

- Level(dBμV/m)
= Antenna Factor(dB/m) + Cable Loss(dB) + Read Level(dBμV) - Preamp Factor(dB)
= 32.22(dB/m) + 4.58(dB) + 42.6(dBμV) – 35.86 (dB)
= 43.54 (dBμV/m)
- Over Limit(dB)
= Level(dBμV/m) – Limit Line(dBμV/m)
= 43.54(dBμV/m) – 54(dBμV/m)
= -10.46(dB)

Both peak and average measured complies with the limit line, so test result is “PASS”.



<Non-TXBF Modes>

Band 4 - 5725~5850MHz

WIFI 802.11a (Band Edge @ 3m)

WIFI Ant.	Note	Frequency	Level	Over Limit	Limit Line	Read Level	Antenna Factor	Cable Loss	Preamp Factor	Ant Pos	Table Pos	Peak Avg.	Pol.	
1+2		(MHz)	(dBµV/m)	(dB)	(dBµV/m)	(dBµV)	(dB/m)	(dB)	(dB)	(cm)	(deg)	(P/A)	(H/V)	
802.11a CH 149 5745MHz		5648.6	58.73	-9.57	68.3	46.52	35.53	11.95	35.27	103	296	P	H	
		5699.6	71.85	-33.16	105.01	59.59	35.54	12	35.28	103	296	P	H	
		5718.2	85.39	-25.01	110.4	73.07	35.54	12.06	35.28	103	296	P	H	
		5723.6	89.9	-29.21	119.11	77.58	35.54	12.06	35.28	103	296	P	H	
	*	5745	117.76	-	-	105.39	35.55	12.11	35.29	103	296	P	H	
	*	5745	110.63	-	-	98.26	35.55	12.11	35.29	103	296	A	H	
														H
														H
			5639.6	53.9	-14.4	68.3	41.69	35.53	11.95	35.27	349	46	P	V
			5699.8	65.3	-39.85	105.15	53.04	35.54	12	35.28	349	46	P	V
			5719.2	82.51	-28.17	110.68	70.19	35.54	12.06	35.28	349	46	P	V
			5724	91.44	-28.58	120.02	79.12	35.54	12.06	35.28	349	46	P	V
	*		5745	112.32	-	-	99.95	35.55	12.11	35.29	349	46	P	V
	*		5745	106.78	-	-	94.41	35.55	12.11	35.29	349	46	A	V
														V
													V	



WIFI Ant. 1+2	Note	Frequency (MHz)	Level (dBμV/m)	Over Limit (dB)	Limit Line (dBμV/m)	Read Level (dBμV)	Antenna Factor (dB/m)	Cable Loss (dB)	Preamp Factor (dB)	Ant Pos (cm)	Table Pos (deg)	Peak Avg. (P/A)	Pol. (H/V)	
		5601	53.23	-15.07	68.3	41.08	35.52	11.89	35.26	102	300	P	H	
		5695.6	58.07	-43.99	102.06	45.81	35.54	12	35.28	102	300	P	H	
		5717.6	60.93	-49.3	110.23	48.61	35.54	12.06	35.28	102	300	P	H	
		5723.6	62.74	-56.37	119.11	50.42	35.54	12.06	35.28	102	300	P	H	
	*	5785	116.46	-	-	104.03	35.56	12.17	35.3	102	300	P	H	
	*	5785	108.55	-	-	96.12	35.56	12.17	35.3	102	300	A	H	
		5852.8	58.56	-57.36	115.92	46.02	35.57	12.28	35.31	102	300	P	H	
		5859	56.2	-53.58	109.78	43.66	35.57	12.28	35.31	102	300	P	H	
		5878.8	53.76	-48.72	102.48	41.11	35.58	12.39	35.32	102	300	P	H	
		5941.6	52.11	-16.19	68.3	39.23	35.59	12.62	35.33	102	300	P	H	
													H	
													H	
802.11a CH 157 5785MHz		5637.6	51.18	-17.12	68.3	38.97	35.53	11.95	35.27	300	234	P	V	
		5680	53.71	-36.83	90.54	41.46	35.53	12	35.28	300	234	P	V	
		5718.8	60.45	-50.11	110.56	48.13	35.54	12.06	35.28	300	234	P	V	
		5724.2	60.77	-59.71	120.48	48.45	35.54	12.06	35.28	300	234	P	V	
		* 5785	111.08	-	-	98.65	35.56	12.17	35.3	300	234	P	V	
		* 5785	103.74	-	-	91.31	35.56	12.17	35.3	300	234	A	V	
			5853.2	54.78	-60.22	115	42.24	35.57	12.28	35.31	300	234	P	V
			5855.4	54.3	-56.49	110.79	41.76	35.57	12.28	35.31	300	234	P	V
			5877.8	52.57	-50.65	103.22	39.92	35.58	12.39	35.32	300	234	P	V
			5925.2	50.8	-17.5	68.3	38.03	35.59	12.51	35.33	300	234	P	V
														V
														V



WiFi Ant. 1+2	Note	Frequency (MHz)	Level (dBμV/m)	Over Limit (dB)	Limit Line (dBμV/m)	Read Level (dBμV)	Antenna Factor (dB/m)	Cable Loss (dB)	Preamp Factor (dB)	Ant Pos (cm)	Table Pos (deg)	Peak Avg. (P/A)	Pol. (H/V)	
802.11a CH 165 5825MHz	*	5825	117.35	-	-	104.81	35.57	12.28	35.31	100	299	P	H	
	*	5825	109.75	-	-	97.21	35.57	12.28	35.31	100	299	A	H	
		5853	87.24	-28.22	115.46	74.7	35.57	12.28	35.31	100	299	P	H	
		5858.2	82.28	-27.72	110	69.74	35.57	12.28	35.31	100	299	P	H	
		5875.8	68.87	-35.84	104.71	56.22	35.58	12.39	35.32	100	299	P	H	
		5940.2	53.56	-14.74	68.3	40.68	35.59	12.62	35.33	100	299	P	H	
														H
														H
	*	5825	112.3	-	-	99.76	35.57	12.28	35.31	300	235	P	V	
	*	5825	105.32	-	-	92.78	35.57	12.28	35.31	300	235	A	V	
		5850.8	87.13	-33.35	120.48	74.59	35.57	12.28	35.31	300	235	P	V	
		5855.8	79.33	-31.35	110.68	66.79	35.57	12.28	35.31	300	235	P	V	
		5875.2	64.15	-41	105.15	51.5	35.58	12.39	35.32	300	235	P	V	
		5949.4	52.32	-15.98	68.3	39.44	35.59	12.62	35.33	300	235	P	V	
														V
														V
													V	
Remark	1. No other spurious found. 2. All results are PASS against Peak and Average limit line.													



Band 4 5725~5850MHz
WIFI 802.11a (Harmonic @ 3m)

WIFI Ant. 1+2	Note	Frequency (MHz)	Level (dBμV/m)	Over Limit (dB)	Limit Line (dBμV/m)	Read Level (dBμV)	Antenna Factor (dB/m)	Cable Loss (dB)	Preamp Factor (dB)	Ant Pos (cm)	Table Pos (deg)	Peak Avg. (P/A)	Pol. (H/V)
802.11a CH 149 5745MHz		11482	42.63	-31.37	74	44.43	38.38	17.16	57.34	100	0	P	H
		17242	47.84	-20.46	68.3	40.91	42.06	20.76	55.89	100	0	P	H
													H
													H
		11482	44.95	-29.05	74	46.75	38.38	17.16	57.34	100	0	P	V
		17242	47.59	-20.71	68.3	40.66	42.06	20.76	55.89	100	0	P	V
													V
													V
802.11a CH 157 5785MHz		11570	41.77	-32.23	74	43.33	38.47	17.16	57.19	100	0	P	H
		17355	45.84	-22.46	68.3	38.95	41.99	20.84	55.94	100	0	P	H
													H
													H
		11570	43.83	-30.17	74	45.39	38.47	17.16	57.19	100	0	P	V
		17355	50.03	-18.27	68.3	43.14	41.99	20.84	55.94	100	0	P	V
													V
													V
802.11a CH 165 5825MHz		11650	42.03	-31.97	74	43.41	38.54	17.16	57.08	100	0	P	H
		17476	46.01	-22.29	68.3	39.15	41.92	20.93	55.99	100	0	P	H
													H
													H
		11650	42.77	-31.23	74	44.15	38.54	17.16	57.08	100	0	P	V
		17475	47.11	-21.19	68.3	40.25	41.92	20.93	55.99	100	0	P	V
													V
													V
Remark	1. No other spurious found. 2. All results are PASS against Peak and Average limit line.												



Band 4 5725~5850MHz
WIFI 802.11ac VHT20 (Band Edge @ 3m)

WIFI Ant. 1+2	Note	Frequency (MHz)	Level (dBμV/m)	Over Limit (dB)	Limit Line (dBμV/m)	Read Level (dBμV)	Antenna Factor (dB/m)	Cable Loss (dB)	Preamp Factor (dB)	Ant Pos (cm)	Table Pos (deg)	Peak Avg. (P/A)	Pol. (H/V)	
802.11ac VHT20 CH 149 5745MHz		5646.2	58.82	-9.48	68.3	46.61	35.53	11.95	35.27	102	296	P	H	
		5698.8	71.71	-32.71	104.42	59.45	35.54	12	35.28	102	296	P	H	
		5720	85.52	-25.38	110.9	73.2	35.54	12.06	35.28	102	296	P	H	
		5725	94.97	-27.33	122.3	82.65	35.54	12.06	35.28	102	296	P	H	
	*	5745	114.67	-	-	102.3	35.55	12.11	35.29	102	296	P	H	
	*	5745	108.07	-	-	95.7	35.55	12.11	35.29	102	296	A	H	
														H
														H
														H
														H
														H
														H
			5646.4	54.49	-13.81	68.3	42.28	35.53	11.95	35.27	287	236	P	V
			5697.2	69.39	-33.85	103.24	57.13	35.54	12	35.28	287	236	P	V
			5718.2	80.65	-29.75	110.4	68.33	35.54	12.06	35.28	287	236	P	V
			5724.4	89.15	-31.78	120.93	76.83	35.54	12.06	35.28	287	236	P	V
		*	5745	111.75	-	-	99.38	35.55	12.11	35.29	287	236	P	V
		*	5745	104.46	-	-	92.09	35.55	12.11	35.29	287	236	A	V
													V	
													V	
													V	
													V	
													V	
													V	



WIFI Ant. 1+2	Note	Frequency (MHz)	Level (dBμV/m)	Over Limit (dB)	Limit Line (dBμV/m)	Read Level (dBμV)	Antenna Factor (dB/m)	Cable Loss (dB)	Preamp Factor (dB)	Ant Pos (cm)	Table Pos (deg)	Peak Avg. (P/A)	Pol. (H/V)	
802.11ac VHT20 CH 157 5785MHz		5639.2	53.75	-14.55	68.3	41.54	35.53	11.95	35.27	112	296	P	H	
		5670.6	57.75	-25.83	83.58	45.49	35.53	12	35.27	112	296	P	H	
		5718.6	62.3	-48.21	110.51	49.98	35.54	12.06	35.28	112	296	P	H	
		5721.6	66.12	-48.43	114.55	53.8	35.54	12.06	35.28	112	296	P	H	
	*	5785	107.72	-	-	95.29	35.56	12.17	35.3	112	296	QP	H	
	*	5785	114.8	-	-	102.37	35.56	12.17	35.3	112	296	P	H	
		5850	63.72	-58.58	122.3	51.18	35.57	12.28	35.31	112	296	P	H	
		5855	58.54	-52.36	110.9	46	35.57	12.28	35.31	112	296	P	H	
		5892.2	54.62	-37.92	92.54	41.97	35.58	12.39	35.32	112	296	P	H	
		5946	51.81	-16.49	68.3	38.93	35.59	12.62	35.33	112	296	P	H	
														H
														H
			5647	52.95	-15.35	68.3	40.74	35.53	11.95	35.27	290	236	P	V
			5697.8	54.95	-48.73	103.68	42.69	35.54	12	35.28	290	236	P	V
			5719.8	57.66	-53.18	110.84	45.34	35.54	12.06	35.28	290	236	P	V
			5723.8	61.17	-58.39	119.56	48.85	35.54	12.06	35.28	290	236	P	V
	*		5785	111.65	-	-	99.22	35.56	12.17	35.3	290	236	P	V
	*		5785	104.22	-	-	91.79	35.56	12.17	35.3	290	236	A	V
			5850.2	57.67	-64.17	121.84	45.13	35.57	12.28	35.31	290	236	P	V
			5855	56.53	-54.37	110.9	43.99	35.57	12.28	35.31	290	236	P	V
		5888.8	53.38	-41.68	95.06	40.73	35.58	12.39	35.32	290	236	P	V	
		5943.2	51.12	-17.18	68.3	38.24	35.59	12.62	35.33	290	236	P	V	
													V	
													V	



WIFI Ant. 1+2	Note	Frequency (MHz)	Level (dBμV/m)	Over Limit (dB)	Limit Line (dBμV/m)	Read Level (dBμV)	Antenna Factor (dB/m)	Cable Loss (dB)	Preamp Factor (dB)	Ant Pos (cm)	Table Pos (deg)	Peak Avg. (P/A)	Pol. (H/V)	
802.11ac VHT20 CH 165 5825MHz	*	5825	114.92	-	-	102.38	35.57	12.28	35.31	110	296	P	H	
	*	5825	107.38	-	-	94.84	35.57	12.28	35.31	110	296	A	H	
		5852	89.72	-28.02	117.74	77.18	35.57	12.28	35.31	110	296	P	H	
		5856	82.9	-27.72	110.62	70.36	35.57	12.28	35.31	110	296	P	H	
		5875	68.18	-37.12	105.3	55.53	35.58	12.39	35.32	110	296	P	H	
		5944.4	52.53	-15.77	68.3	39.65	35.59	12.62	35.33	110	296	P	H	
														H
														H
														H
														H
														H
														H
	*	5825	110.31	-	-	97.77	35.57	12.28	35.31	290	236	P	V	
	*	5825	103.94	-	-	91.4	35.57	12.28	35.31	290	236	A	V	
		5851.4	83.05	-36.06	119.11	70.51	35.57	12.28	35.31	290	236	P	V	
		5858.2	80.23	-29.77	110	67.69	35.57	12.28	35.31	290	236	P	V	
		5875.2	66.31	-38.84	105.15	53.66	35.58	12.39	35.32	290	236	P	V	
		5927.8	52.07	-16.23	68.3	39.3	35.59	12.51	35.33	290	236	P	V	
													V	
													V	
													V	
													V	
													V	
													V	
Remark	1. No other spurious found. 2. All results are PASS against Peak and Average limit line.													



Band 4 5725~5850MHz
WIFI 802.11ac VHT20 (Harmonic @ 3m)

WIFI Ant. 1+2	Note	Frequency (MHz)	Level (dBμV/m)	Over Limit (dB)	Limit Line (dBμV/m)	Read Level (dBμV)	Antenna Factor (dB/m)	Cable Loss (dB)	Preamp Factor (dB)	Ant Pos (cm)	Table Pos (deg)	Peak Avg. (P/A)	Pol. (H/V)	
802.11ac VHT20 CH 149 5745MHz		11490	42.87	-31.13	74	44.67	38.38	17.16	57.34	100	0	P	H	
		17235	45.95	-22.35	68.3	39.02	42.06	20.76	55.89	100	0	P	H	
													H	
													H	
			11490	43.77	-30.23	74	45.57	38.38	17.16	57.34	100	0	P	V
			17235	46.42	-21.88	68.3	39.49	42.06	20.76	55.89	100	0	P	V
														V
802.11ac VHT20 CH 157 5785MHz		11570	43.05	-30.95	74	44.61	38.47	17.16	57.19	100	0	P	H	
		17355	45.76	-22.54	68.3	38.87	41.99	20.84	55.94	100	0	P	H	
													H	
													H	
			11570	43.51	-30.49	74	45.07	38.47	17.16	57.19	100	0	P	V
			17355	46.3	-22	68.3	39.41	41.99	20.84	55.94	100	0	P	V
														V
802.11ac VHT20 CH 165 5825MHz		11650	42.84	-31.16	74	44.22	38.54	17.16	57.08	100	0	P	H	
		17475	46.94	-21.36	68.3	40.08	41.92	20.93	55.99	100	0	P	H	
													H	
													H	
			11650	42.36	-31.64	74	43.74	38.54	17.16	57.08	100	0	P	V
			17475	45.9	-22.4	68.3	39.04	41.92	20.93	55.99	100	0	P	V
														V
Remark	1. No other spurious found.													
	2. All results are PASS against Peak and Average limit line.													



Band 4 5725~5850MHz
WIFI 802.11ac VHT40 (Band Edge @ 3m)

WIFI Ant. 1+2	Note	Frequency (MHz)	Level (dBμV/m)	Over Limit (dB)	Limit Line (dBμV/m)	Read Level (dBμV)	Antenna Factor (dB/m)	Cable Loss (dB)	Preamp Factor (dB)	Ant Pos (cm)	Table Pos (deg)	Peak Avg. (P/A)	Pol. (H/V)	
		5650	64.88	-3.42	68.3	52.67	35.53	11.95	35.27	105	296	P	H	
		5697.6	87.19	-16.34	103.53	74.93	35.54	12	35.28	105	296	P	H	
		5717.4	92.91	-17.26	110.17	80.59	35.54	12.06	35.28	105	296	P	H	
		5722	95.86	-19.6	115.46	83.54	35.54	12.06	35.28	105	296	P	H	
	*	5755	112.54	-	-	100.17	35.55	12.11	35.29	105	296	P	H	
	*	5755	105.23	-	-	92.86	35.55	12.11	35.29	105	296	A	H	
		5850.8	69.18	-51.3	120.48	56.64	35.57	12.28	35.31	105	296	P	H	
		5858	67.97	-42.09	110.06	55.43	35.57	12.28	35.31	105	296	P	H	
		5875.2	62.76	-42.39	105.15	50.11	35.58	12.39	35.32	105	296	P	H	
		5926.2	54.53	-13.77	68.3	41.76	35.59	12.51	35.33	105	296	P	H	
802.11ac VHT40 CH 151 5755MHz													H	
													H	
			5641.6	61.02	-7.28	68.3	48.81	35.53	11.95	35.27	289	236	P	V
			5699	80.51	-24.05	104.56	68.25	35.54	12	35.28	289	236	P	V
			5714.2	87.83	-21.45	109.28	75.51	35.54	12.06	35.28	289	236	P	V
			5722.6	88.98	-27.85	116.83	76.66	35.54	12.06	35.28	289	236	P	V
		*	5755	108.58	-	-	96.21	35.55	12.11	35.29	289	236	P	V
		*	5755	101.83	-	-	89.46	35.55	12.11	35.29	289	236	A	V
			5851.6	66.36	-52.29	118.65	53.82	35.57	12.28	35.31	289	236	P	V
			5855.4	64.22	-46.57	110.79	51.68	35.57	12.28	35.31	289	236	P	V
			5881.6	59.9	-40.5	100.4	47.25	35.58	12.39	35.32	289	236	P	V
			5932.8	51.86	-16.44	68.3	39.09	35.59	12.51	35.33	289	236	P	V
														V
														V



WIFI Ant. 1+2	Note	Frequency (MHz)	Level (dBμV/m)	Over Limit (dB)	Limit Line (dBμV/m)	Read Level (dBμV)	Antenna Factor (dB/m)	Cable Loss (dB)	Preamp Factor (dB)	Ant Pos (cm)	Table Pos (deg)	Peak Avg. (P/A)	Pol. (H/V)	
802.11ac VHT40 CH 159 5795MHz		5645	58.84	-9.46	68.3	46.63	35.53	11.95	35.27	112	296	P	H	
		5699	70.91	-33.65	104.56	58.65	35.54	12	35.28	112	296	P	H	
		5719.6	75.81	-34.98	110.79	63.49	35.54	12.06	35.28	112	296	P	H	
		5724.4	79.75	-41.18	120.93	67.43	35.54	12.06	35.28	112	296	P	H	
	*	5795	111.66	-	-	99.23	35.56	12.17	35.3	112	296	P	H	
	*	5795	104.73	-	-	92.3	35.56	12.17	35.3	112	296	A	H	
		5852.6	87.9	-28.47	116.37	75.36	35.57	12.28	35.31	112	296	P	H	
		5857	80.6	-29.74	110.34	68.06	35.57	12.28	35.31	112	296	P	H	
		5875.2	73.5	-31.65	105.15	60.85	35.58	12.39	35.32	112	296	P	H	
		5928.2	59.21	-9.09	68.3	46.44	35.59	12.51	35.33	112	296	P	H	
														H
														H
			5622.6	54.55	-13.75	68.3	42.34	35.52	11.95	35.26	286	236	P	V
			5695	68.69	-32.92	101.61	56.43	35.54	12	35.28	286	236	P	V
			5707.8	72.88	-34.61	107.49	60.56	35.54	12.06	35.28	286	236	P	V
			5722.8	71.17	-46.11	117.28	58.85	35.54	12.06	35.28	286	236	P	V
	*		5795	109.55	-	-	97.12	35.56	12.17	35.3	286	236	P	V
	*		5795	101.66	-	-	89.23	35.56	12.17	35.3	286	236	A	V
			5850.6	80.3	-40.63	120.93	67.76	35.57	12.28	35.31	286	236	P	V
			5858.2	78.63	-31.37	110	66.09	35.57	12.28	35.31	286	236	P	V
		5875.2	71.87	-33.28	105.15	59.22	35.58	12.39	35.32	286	236	P	V	
		5931.2	58.94	-9.36	68.3	46.17	35.59	12.51	35.33	286	236	P	V	
													V	
													V	
Remark	1. No other spurious found. 2. All results are PASS against Peak and Average limit line.													



Band 4 5725~5850MHz

WIFI 802.11ac VHT40 (Harmonic @ 3m)

WIFI Ant. 1+2	Note	Frequency (MHz)	Level (dBμV/m)	Over Limit (dB)	Limit Line (dBμV/m)	Read Level (dBμV)	Antenna Factor (dB/m)	Cable Loss (dB)	Preamp Factor (dB)	Ant Pos (cm)	Table Pos (deg)	Peak Avg. (P/A)	Pol. (H/V)	
802.11ac VHT40 CH 151 5755MHz		11510	42.18	-31.82	74	43.92	38.4	17.16	57.3	100	0	P	H	
		17265	46.57	-21.73	68.3	39.65	42.04	20.79	55.91	100	0	P	H	
													H	
													H	
			11510	42.64	-31.36	74	44.38	38.4	17.16	57.3	100	0	P	V
			17265	46.27	-22.03	68.3	39.35	42.04	20.79	55.91	100	0	P	V
														V
802.11ac VHT40 CH 159 5795MHz		11590	42.5	-31.5	74	44.01	38.49	17.16	57.16	100	0	P	H	
		17385	46.53	-21.77	68.3	39.64	41.97	20.87	55.95	100	0	P	H	
													H	
													H	
			11590	42.66	-31.34	74	44.17	38.49	17.16	57.16	100	0	P	V
			17385	46.32	-21.98	68.3	39.43	41.97	20.87	55.95	100	0	P	V
														V
Remark	1. No other spurious found.													
	2. All results are PASS against Peak and Average limit line.													



Band 4 5725~5850MHz
WIFI 802.11ac VHT80 (Band Edge @ 3m)

WIFI Ant. 1+2	Note	Frequency (MHz)	Level (dBμV/m)	Over Limit (dB)	Limit Line (dBμV/m)	Read Level (dBμV)	Antenna Factor (dB/m)	Cable Loss (dB)	Preamp Factor (dB)	Ant Pos (cm)	Table Pos (deg)	Peak Avg. (P/A)	Pol. (H/V)	
		5648.6	66.91	-1.39	68.3	54.7	35.53	11.95	35.27	102	302	P	H	
		5683.2	83.4	-9.5	92.9	71.15	35.53	12	35.28	102	302	P	H	
		5719	88.98	-21.64	110.62	76.66	35.54	12.06	35.28	102	302	P	H	
		5723.8	86.71	-32.85	119.56	74.39	35.54	12.06	35.28	102	302	P	H	
	*	5775	107.18	-	-	94.81	35.56	12.11	35.3	102	302	P	H	
	*	5775	103.56	-	-	91.19	35.56	12.11	35.3	102	302	A	H	
		5851	80.91	-39.11	120.02	68.37	35.57	12.28	35.31	102	302	P	H	
		5862.6	79.3	-29.47	108.77	66.65	35.57	12.39	35.31	102	302	P	H	
		5875.4	75.39	-29.61	105	62.74	35.58	12.39	35.32	102	302	P	H	
		5925	60.35	-7.95	68.3	47.58	35.59	12.51	35.33	102	302	P	H	
802.11ac VHT80 CH 155 5775MHz													H	
													H	
			5631.8	59.08	-9.22	68.3	46.88	35.52	11.95	35.27	301	192	P	V
			5683.2	74.99	-17.91	92.9	62.74	35.53	12	35.28	301	192	P	V
			5719.2	80.95	-29.73	110.68	68.63	35.54	12.06	35.28	301	192	P	V
			5723.2	80.87	-37.33	118.2	68.55	35.54	12.06	35.28	301	192	P	V
		*	5775	104.72	-	-	92.35	35.56	12.11	35.3	301	192	P	V
		*	5775	98.46	-	-	86.09	35.56	12.11	35.3	301	192	A	V
			5850.6	76.33	-44.6	120.93	63.79	35.57	12.28	35.31	301	192	P	V
			5872.6	75.53	-30.44	105.97	62.87	35.58	12.39	35.31	301	192	P	V
			5878.2	69.87	-33.05	102.92	57.22	35.58	12.39	35.32	301	192	P	V
			5927.8	55.65	-12.65	68.3	42.88	35.59	12.51	35.33	301	192	P	V
														V
														V
	Remark	1. No other spurious found. 2. All results are PASS against Peak and Average limit line.												



Band 4 5725~5850MHz
WIFI 802.11ac VHT80 (Harmonic @ 3m)

WIFI Ant. 1+2	Note	Frequency (MHz)	Level (dBμV/m)	Over Limit (dB)	Limit Line (dBμV/m)	Read Level (dBμV)	Antenna Factor (dB/m)	Cable Loss (dB)	Preamp Factor (dB)	Ant Pos (cm)	Table Pos (deg)	Peak Avg. (P/A)	Pol. (H/V)	
802.11ac VHT80 CH 155 5775MHz		11550	41.99	-32.01	74	43.6	38.45	17.16	57.22	100	0	P	H	
		17325	45.62	-22.68	68.3	38.73	42.01	20.81	55.93	100	0	P	H	
													H	
													H	
			11550	41.89	-32.11	74	43.5	38.45	17.16	57.22	100	0	P	V
			17325	45.63	-22.67	68.3	38.74	42.01	20.81	55.93	100	0	P	V
														V
Remark	1. No other spurious found. 2. All results are PASS against Peak and Average limit line.													



Emission below 1GHz
5GHz WIFI 802.11a (LF @ 3m)

WIFI	Note	Frequency	Level	Over	Limit	Read	Antenna	Cable	Preamp	Ant	Table	Peak	Pol.	
Ant.				Limit	Line	Level	Factor	Loss	Factor	Pos	Pos	Avg.		
1+2		(MHz)	(dBμV/m)	(dB)	(dBμV/m)	(dBμV)	(dB/m)	(dB)	(dB)	(cm)	(deg)	(P/A)	(H/V)	
5GHz 802.11a LF		30.54	27.46	-12.54	40	32.29	25.46	1.07	31.36	-	-	P	H	
		106.14	23.21	-20.29	43.5	36.24	16.94	1.55	31.52	-	-	P	H	
		240.06	29.08	-16.92	46	40.32	18.09	2.07	31.4	-	-	P	H	
		780.2	34.07	-11.93	46	33.29	27.5	3.9	30.62	-	-	P	H	
		899.9	34.59	-11.41	46	31.96	29	4.17	30.54	100	0	P	H	
		937	32.86	-13.14	46	29.38	29.89	4.12	30.53	-	-	P	H	
														H
														H
														H
														H
														H
														H
			30	29.66	-10.34	40	33.94	26	1.07	31.35	100	0	P	V
			139.62	23.7	-19.8	43.5	35.65	18	1.55	31.5	-	-	P	V
			240.06	25.79	-20.21	46	37.03	18.09	2.07	31.4	-	-	P	V
			822.9	31.1	-14.9	46	29.43	28.15	4.1	30.58	-	-	P	V
			895.7	32.81	-13.19	46	30.21	28.97	4.17	30.54	-	-	P	V
			939.8	32.88	-13.12	46	29.33	29.96	4.12	30.53	-	-	P	V
														V
														V
													V	
													V	
													V	
													V	
Remark	1. No other spurious found. 2. All results are PASS against limit line.													



Emission below 1GHz

5GHz WIFI 802.11ac VHT20 (LF @ 3m)

WIFI	Note	Frequency	Level	Over	Limit	Read	Antenna	Cable	Preamp	Ant	Table	Peak	Pol.	
Ant.				Limit	Line	Level	Factor	Loss	Factor	Pos	Pos	Avg.		
1+2		(MHz)	(dBμV/m)	(dB)	(dBμV/m)	(dBμV)	(dB/m)	(dB)	(dB)	(cm)	(deg)	(P/A)	(H/V)	
5GHz 802.11ac VHT20 LF		31.62	27.45	-12.55	40	32.84	24.92	1.07	31.38	-	-	P	H	
		106.14	22.05	-21.45	43.5	35.08	16.94	1.55	31.52	-	-	P	H	
		240.06	29.33	-16.67	46	40.57	18.09	2.07	31.4	-	-	P	H	
		780.2	33.78	-12.22	46	33	27.5	3.9	30.62	100	0	P	H	
		864.2	32.5	-13.5	46	30.1	28.79	4.17	30.56	-	-	P	H	
		931.4	33.51	-12.49	46	30.17	29.75	4.12	30.53	-	-	P	H	
														H
														H
														H
														H
														H
														V
			30.54	30.03	-9.97	40	34.86	25.46	1.07	31.36	100	0	P	V
			106.41	23.91	-19.59	43.5	36.85	17.03	1.55	31.52	-	-	P	V
			240.06	25.52	-20.48	46	36.76	18.09	2.07	31.4	-	-	P	V
			821.5	31.5	-14.5	46	29.85	28.13	4.1	30.58	-	-	P	V
			864.2	32.87	-13.13	46	30.47	28.79	4.17	30.56	-	-	P	V
			941.2	33.08	-12.92	46	29.55	29.99	4.07	30.53	-	-	P	V
														V
													V	
													V	
													V	
													V	
Remark	1. No other spurious found. 2. All results are PASS against limit line.													



Emission below 1GHz

5GHz WIFI 802.11ac VHT40 (LF @ 3m)

WIFI	Note	Frequency	Level	Over	Limit	Read	Antenna	Cable	Preamp	Ant	Table	Peak	Pol.	
Ant.				Limit	Line	Level	Factor	Loss	Factor	Pos	Pos	Avg.		
1+2		(MHz)	(dBμV/m)	(dB)	(dBμV/m)	(dBμV)	(dB/m)	(dB)	(dB)	(cm)	(deg)	(P/A)	(H/V)	
5GHz 802.11ac VHT40 LF		30.54	27.37	-12.63	40	32.2	25.46	1.07	31.36	-	-	P	H	
		106.14	22.73	-20.77	43.5	35.76	16.94	1.55	31.52	-	-	P	H	
		240.06	29.3	-16.7	46	40.54	18.09	2.07	31.4	-	-	P	H	
		780.2	34.52	-11.48	46	33.74	27.5	3.9	30.62	100	0	P	H	
		849.5	32.25	-13.75	46	30.02	28.7	4.1	30.57	-	-	P	H	
		899.9	34.05	-11.95	46	31.42	29	4.17	30.54	-	-	P	H	
														H
														H
														H
														H
														H
														H
														H
														H
														H
			30.27	28.68	-11.32	40	32.96	26	1.07	31.35	100	0	P	V
			134.49	23.49	-20.01	43.5	35.3	18.15	1.55	31.51	-	-	P	V
			240.06	25.75	-20.25	46	36.99	18.09	2.07	31.4	-	-	P	V
		768.3	30.56	-15.44	46	29.99	27.38	3.82	30.63	-	-	P	V	
		862.1	32.24	-13.76	46	29.85	28.78	4.17	30.56	-	-	P	V	
		928.6	33.35	-12.65	46	30.08	29.68	4.12	30.53	-	-	P	V	
													V	
													V	
													V	
													V	
													V	
													V	
Remark	1. No other spurious found. 2. All results are PASS against limit line.													



Emission below 1GHz

5GHz WIFI 802.11ac VHT80 (LF @ 3m)

WIFI	Note	Frequency	Level	Over	Limit	Read	Antenna	Cable	Preamp	Ant	Table	Peak	Pol.	
Ant.				Limit	Line	Level	Factor	Loss	Factor	Pos	Pos	Avg.		
1+2		(MHz)	(dBμV/m)	(dB)	(dBμV/m)	(dBμV)	(dB/m)	(dB)	(dB)	(cm)	(deg)	(P/A)	(H/V)	
5GHz 802.11ac VHT80 LF		30.27	27.56	-12.44	40	31.84	26	1.07	31.35			P	H	
		106.14	23.04	-20.46	43.5	36.07	16.94	1.55	31.52			P	H	
		240.06	28.24	-17.76	46	39.48	18.09	2.07	31.4			P	H	
		780.2	34.44	-11.56	46	33.66	27.5	3.9	30.62	100	0	P	H	
		844.6	31.93	-14.07	46	29.8	28.6	4.1	30.57			P	H	
		899.9	33.6	-12.4	46	30.97	29	4.17	30.54			P	H	
													H	
													H	
													H	
													H	
													H	
													H	
													H	
			30	29.48	-10.52	40	33.76	26	1.07	31.35	100	0	P	V
			139.89	24.09	-19.41	43.5	36.04	18	1.55	31.5			P	V
			240.06	24.93	-21.07	46	36.17	18.09	2.07	31.4			P	V
			821.5	31.89	-14.11	46	30.24	28.13	4.1	30.58			P	V
			895	32.19	-13.81	46	29.59	28.97	4.17	30.54			P	V
		941.2	32.97	-13.03	46	29.44	29.99	4.07	30.53			P	V	
													V	
													V	
													V	
													V	
													V	
													V	
Remark	1. No other spurious found. 2. All results are PASS against limit line.													



Note symbol

*	Fundamental Frequency which can be ignored. However, the level of any unwanted emissions shall not exceed the level of the fundamental frequency.
!	Test result is over limit line.
P/A	Peak or Average
H/V	Horizontal or Vertical



A calculation example for radiated spurious emission is shown as below:

WIFI	Note	Frequency	Level	Over	Limit	Read	Antenna	Cable	Preamp	Ant	Table	Peak	Pol.
Ant.				Limit	Line	Level	Factor	Loss	Factor	Pos	Pos	Avg.	
1+2		(MHz)	(dBμV/m)	(dB)	(dBμV/m)	(dBμV)	(dB/m)	(dB)	(dB)	(cm)	(deg)	(P/A)	(H/V)
802.11b		2390	55.45	-18.55	74	54.51	32.22	4.58	35.86	103	308	P	H
CH 01													
2412MHz		2390	43.54	-10.46	54	42.6	32.22	4.58	35.86	103	308	A	H

- Level(dBμV/m) =
Antenna Factor(dB/m) + Cable Loss(dB) + Read Level(dBμV) - Preamp Factor(dB)
- Over Limit(dB) = Level(dBμV/m) – Limit Line(dBμV/m)

For Peak Limit @ 2390MHz:

- Level(dBμV/m)
= Antenna Factor(dB/m) + Cable Loss(dB) + Read Level(dBμV) - Preamp Factor(dB)
= 32.22(dB/m) + 4.58(dB) + 54.51(dBμV) – 35.86 (dB)
= 55.45 (dBμV/m)
- Over Limit(dB)
= Level(dBμV/m) – Limit Line(dBμV/m)
= 55.45(dBμV/m) – 74(dBμV/m)
= -18.55(dB)

For Average Limit @ 2390MHz:

- Level(dBμV/m)
= Antenna Factor(dB/m) + Cable Loss(dB) + Read Level(dBμV) - Preamp Factor(dB)
= 32.22(dB/m) + 4.58(dB) + 42.6(dBμV) – 35.86 (dB)
= 43.54 (dBμV/m)
- Over Limit(dB)
= Level(dBμV/m) – Limit Line(dBμV/m)
= 43.54(dBμV/m) – 54(dBμV/m)
= -10.46(dB)

Both peak and average measured complies with the limit line, so test result is “PASS”.



<TXBF Modes>

Band 4 - 5725~5850MHz

WIFI 802.11ac VHT20 (Band Edge @ 3m)

WIFI Ant.	Note	Frequency	Level	Over Limit	Limit Line	Read Level	Antenna Factor	Cable Loss	Preamp Factor	Ant Pos	Table Pos	Peak Avg.	Pol.	
1+2		(MHz)	(dBµV/m)	(dB)	(dBµV/m)	(dBµV)	(dB/m)	(dB)	(dB)	(cm)	(deg)	(P/A)	(H/V)	
802.11ac VHT20 CH 149 5745MHz		5648.6	55.07	-13.23	68.3	42.86	35.53	11.95	35.27	100	300	P	H	
		5698	66.79	-37.04	103.83	54.53	35.54	12	35.28	100	300	P	H	
		5719.8	80.11	-30.73	110.84	67.79	35.54	12.06	35.28	100	300	P	H	
		5724.6	91.83	-29.56	121.39	79.51	35.54	12.06	35.28	100	300	P	H	
	*	5745	117.06	-	-	104.69	35.55	12.11	35.29	100	300	P	H	
	*	5745	110.34	-	-	97.97	35.55	12.11	35.29	100	300	A	H	
														H
														H
			5643.6	52.43	-15.87	68.3	40.22	35.53	11.95	35.27	100	63	P	V
			5698.4	62.32	-41.8	104.12	50.06	35.54	12	35.28	100	63	P	V
			5719.2	73.13	-37.55	110.68	60.81	35.54	12.06	35.28	100	63	P	V
			5723.4	83.11	-35.54	118.65	70.79	35.54	12.06	35.28	100	63	P	V
		*	5745	111.03	-	-	98.66	35.55	12.11	35.29	100	63	P	V
		*	5745	104.7	-	-	92.33	35.55	12.11	35.29	100	63	A	V
													V	
													V	



WIFI Ant. 1+2	Note	Frequency (MHz)	Level (dBµV/m)	Over Limit (dB)	Limit Line (dBµV/m)	Read Level (dBµV)	Antenna Factor (dB/m)	Cable Loss (dB)	Preamp Factor (dB)	Ant Pos (cm)	Table Pos (deg)	Peak Avg. (P/A)	Pol. (H/V)
802.11ac VHT20 CH 157 5785MHz		5633	51.89	-16.41	68.3	39.68	35.53	11.95	35.27	100	297	P	H
		5696.4	57.4	-45.25	102.65	45.14	35.54	12	35.28	100	297	P	H
		5712.4	59.04	-49.73	108.77	46.72	35.54	12.06	35.28	100	297	P	H
		5721.4	61.53	-52.56	114.09	49.21	35.54	12.06	35.28	100	297	P	H
	*	5785	116.51	-	-	104.08	35.56	12.17	35.3	100	297	P	H
	*	5785	110.74	-	-	98.31	35.56	12.17	35.3	100	297	A	H
		5855	58.91	-51.99	110.9	46.37	35.57	12.28	35.31	100	297	P	H
		5855.6	60.07	-50.66	110.73	47.53	35.57	12.28	35.31	100	297	P	H
		5902	54.3	-30.98	85.28	41.53	35.58	12.51	35.32	100	297	P	H
		5931.2	52.69	-15.61	68.3	39.92	35.59	12.51	35.33	100	297	P	H
		5618.4	50.16	-18.14	68.3	38.01	35.52	11.89	35.26	100	72	P	V
		5699.6	51.79	-53.22	105.01	39.53	35.54	12	35.28	100	72	P	V
		5710	53.85	-54.25	108.1	41.53	35.54	12.06	35.28	100	72	P	V
		5722.2	54.26	-61.66	115.92	41.94	35.54	12.06	35.28	100	72	P	V
	*	5785	109.52	-	-	97.09	35.56	12.17	35.3	100	72	P	V
	*	5785	103.8	-	-	91.37	35.56	12.17	35.3	100	72	A	V
		5850.4	52.08	-69.31	121.39	39.54	35.57	12.28	35.31	100	72	P	V
		5856.6	51.91	-58.54	110.45	39.37	35.57	12.28	35.31	100	72	P	V
	5899.2	51.98	-35.37	87.35	39.33	35.58	12.39	35.32	100	72	P	V	
	5933.2	51.38	-16.92	68.3	38.61	35.59	12.51	35.33	100	72	P	V	



WIFI Ant. 1+2	Note	Frequency (MHz)	Level (dBµV/m)	Over Limit (dB)	Limit Line (dBµV/m)	Read Level (dBµV)	Antenna Factor (dB/m)	Cable Loss (dB)	Preamp Factor (dB)	Ant Pos (cm)	Table Pos (deg)	Peak Avg. (P/A)	Pol. (H/V)	
802.11ac VHT20 CH 165 5825MHz	*	5825	117	-	-	104.46	35.57	12.28	35.31	100	298	P	H	
	*	5825	110.75	-	-	98.21	35.57	12.28	35.31	100	298	A	H	
		5850.6	80.02	-40.91	120.93	67.48	35.57	12.28	35.31	100	298	P	H	
		5856.6	73.58	-36.87	110.45	61.04	35.57	12.28	35.31	100	298	P	H	
		5876.4	62.69	-41.57	104.26	50.04	35.58	12.39	35.32	100	298	P	H	
		5944.2	53.68	-14.62	68.3	40.8	35.59	12.62	35.33	100	298	P	H	
														H
														H
	*	5825	108.98	-	-	96.44	35.57	12.28	35.31	100	83	83	P	V
	*	5825	102.72	-	-	90.18	35.57	12.28	35.31	100	83	83	A	V
		5850.8	72.8	-47.68	120.48	60.26	35.57	12.28	35.31	100	83	83	P	V
		5858.6	69.25	-40.64	109.89	56.71	35.57	12.28	35.31	100	83	83	P	V
		5875.6	56.58	-48.27	104.85	43.93	35.58	12.39	35.32	100	83	83	P	V
		5942.6	51.87	-16.43	68.3	38.99	35.59	12.62	35.33	100	83	83	P	V
														V
													V	
Remark	<ol style="list-style-type: none"> No other spurious found. All results are PASS against Peak and Average limit line. 													



Band 4 5725~5850MHz
WIFI 802.11ac VHT20 (Harmonic @ 3m)

WIFI Ant. 1+2	Note	Frequency (MHz)	Level (dBµV/m)	Over Limit (dB)	Limit Line (dBµV/m)	Read Level (dBµV)	Antenna Factor (dB/m)	Cable Loss (dB)	Preamp Factor (dB)	Ant Pos (cm)	Table Pos (deg)	Peak Avg. (P/A)	Pol. (H/V)	
802.11ac VHT20 CH 149 5745MHz		11490	42.26	-31.74	74	44.06	38.38	17.16	57.34	100	0	P	H	
		17235	52.38	-15.92	68.3	45.45	42.06	20.76	55.89	100	0	P	H	
													H	
													H	
			11490	45.22	-28.78	74	47.02	38.38	17.16	57.34	100	0	P	V
			17235	52.12	-16.18	68.3	45.19	42.06	20.76	55.89	100	0	P	V
														V
802.11ac VHT20 CH 157 5785MHz		11570	42.47	-31.53	74	44.03	38.47	17.16	57.19	100	0	P	H	
		17355	49.99	-18.31	68.3	43.1	41.99	20.84	55.94	100	0	P	H	
													H	
													H	
			11570	45.25	-28.75	74	46.81	38.47	17.16	57.19	100	0	P	V
			17355	50.83	-17.47	68.3	43.94	41.99	20.84	55.94	100	0	P	V
														V
802.11ac VHT20 CH 165 5825MHz		11650	41.72	-32.28	74	43.1	38.54	17.16	57.08	100	0	P	H	
		17475	50.84	-17.46	68.3	43.98	41.92	20.93	55.99	100	0	P	H	
													H	
													H	
			11650	45.15	-28.85	74	46.53	38.54	17.16	57.08	100	0	P	V
			17475	47.84	-20.46	68.3	40.98	41.92	20.93	55.99	100	0	P	V
														V
Remark	1. No other spurious found.													
	2. All results are PASS against Peak and Average limit line.													



Band 4 5725~5850MHz
WIFI 802.11ac VHT40 (Band Edge @ 3m)

WIFI Ant. 1+2	Note	Frequency (MHz)	Level (dBμV/m)	Over Limit (dB)	Limit Line (dBμV/m)	Read Level (dBμV)	Antenna Factor (dB/m)	Cable Loss (dB)	Preamp Factor (dB)	Ant Pos (cm)	Table Pos (deg)	Peak Avg. (P/A)	Pol. (H/V)	
		5638.4	65.55	-2.75	68.3	53.34	35.53	11.95	35.27	100	300	P	H	
		5696.4	83.46	-19.19	102.65	71.2	35.54	12	35.28	100	300	P	H	
		5711.2	91.14	-17.3	108.44	78.82	35.54	12.06	35.28	100	300	P	H	
		5721.4	90.88	-23.21	114.09	78.56	35.54	12.06	35.28	100	300	P	H	
	*	5755	114.79	-	-	102.42	35.55	12.11	35.29	100	300	P	H	
	*	5755	109.31	-	-	96.94	35.55	12.11	35.29	100	300	A	H	
		5852.8	69.44	-46.48	115.92	56.9	35.57	12.28	35.31	100	300	P	H	
		5855.4	70.73	-40.06	110.79	58.19	35.57	12.28	35.31	100	300	P	H	
		5876.2	64.42	-39.99	104.41	51.77	35.58	12.39	35.32	100	300	P	H	
		5935	54.45	-13.85	68.3	41.68	35.59	12.51	35.33	100	300	P	H	
802.11ac VHT40 CH 151 5755MHz													H	
													H	
			5649.8	57.64	-10.66	68.3	45.43	35.53	11.95	35.27	100	82	P	V
			5697.8	70.08	-33.6	103.68	57.82	35.54	12	35.28	100	82	P	V
			5718	80.47	-29.87	110.34	68.15	35.54	12.06	35.28	100	82	P	V
			5721.8	83.48	-31.52	115	71.16	35.54	12.06	35.28	100	82	P	V
		*	5755	108.97	-	-	96.6	35.55	12.11	35.29	100	82	P	V
		*	5755	103.1	-	-	90.73	35.55	12.11	35.29	100	82	A	V
			5854.4	64.87	-47.4	112.27	52.33	35.57	12.28	35.31	100	82	P	V
			5864.6	61.85	-46.36	108.21	49.2	35.57	12.39	35.31	100	82	P	V
			5884.8	55.53	-42.49	98.02	42.88	35.58	12.39	35.32	100	82	P	V
			5929.8	52.77	-15.53	68.3	40	35.59	12.51	35.33	100	82	P	V
														V
														V



WIFI Ant. 1+2	Note	Frequency (MHz)	Level (dBμV/m)	Over Limit (dB)	Limit Line (dBμV/m)	Read Level (dBμV)	Antenna Factor (dB/m)	Cable Loss (dB)	Preamp Factor (dB)	Ant Pos (cm)	Table Pos (deg)	Peak Avg. (P/A)	Pol. (H/V)
		5648.4	61.56	-6.74	68.3	49.35	35.53	11.95	35.27	100	300	P	H
		5699.4	68.41	-36.45	104.86	56.15	35.54	12	35.28	100	300	P	H
		5715.2	76.01	-33.55	109.56	63.69	35.54	12.06	35.28	100	300	P	H
		5724.2	76.62	-43.86	120.48	64.3	35.54	12.06	35.28	100	300	P	H
	*	5795	114.38	-	-	101.95	35.56	12.17	35.3	100	300	P	H
	*	5795	109.1	-	-	96.67	35.56	12.17	35.3	100	300	A	H
		5852.4	80.8	-36.03	116.83	68.26	35.57	12.28	35.31	100	300	P	H
		5858.8	80.02	-29.81	109.83	67.48	35.57	12.28	35.31	100	300	P	H
		5875	75.29	-30.01	105.3	62.64	35.58	12.39	35.32	100	300	P	H
		5927	61.01	-7.29	68.3	48.24	35.59	12.51	35.33	100	300	P	H
802.11ac													H
VHT40													H
CH 159		5637.4	52.31	-15.99	68.3	40.1	35.53	11.95	35.27	100	67	P	V
5795MHz		5692.4	58.33	-41.37	99.7	46.07	35.54	12	35.28	100	67	P	V
		5718	67.16	-43.18	110.34	54.84	35.54	12.06	35.28	100	67	P	V
		5724.8	69.03	-52.81	121.84	56.71	35.54	12.06	35.28	100	67	P	V
	*	5795	109.57	-	-	97.14	35.56	12.17	35.3	100	67	P	V
	*	5795	102.92	-	-	90.49	35.56	12.17	35.3	100	67	A	V
		5850.2	74.46	-47.38	121.84	61.92	35.57	12.28	35.31	100	67	P	V
		5857.4	72	-38.23	110.23	59.46	35.57	12.28	35.31	100	67	P	V
		5882	67.06	-33.04	100.1	54.41	35.58	12.39	35.32	100	67	P	V
		5926	53.79	-14.51	68.3	41.02	35.59	12.51	35.33	100	67	P	V
													V
													V
Remark	1. No other spurious found. 2. All results are PASS against Peak and Average limit line.												



Band 4 5725~5850MHz
WIFI 802.11ac VHT40 (Harmonic @ 3m)

WIFI Ant. 1+2	Note	Frequency (MHz)	Level (dBμV/m)	Over Limit (dB)	Limit Line (dBμV/m)	Read Level (dBμV)	Antenna Factor (dB/m)	Cable Loss (dB)	Preamp Factor (dB)	Ant Pos (cm)	Table Pos (deg)	Peak Avg. (P/A)	Pol. (H/V)	
802.11ac VHT40 CH 151 5755MHz		11510	43.93	-30.07	74	45.67	38.4	17.16	57.3	100	0	P	H	
		17265	50.52	-17.78	68.3	43.6	42.04	20.79	55.91	100	0	P	H	
													H	
													H	
			11510	44.7	-29.3	74	46.44	38.4	17.16	57.3	100	0	P	V
			17265	49.2	-19.1	68.3	42.28	42.04	20.79	55.91	100	0	P	V
														V
802.11ac VHT40 CH 159 5795MHz		11590	42.19	-31.81	74	43.7	38.49	17.16	57.16	100	0	P	H	
		17385	50.19	-18.11	68.3	43.3	41.97	20.87	55.95	100	0	P	H	
													H	
													H	
			11590	43.27	-30.73	74	44.78	38.49	17.16	57.16	100	0	P	V
			17385	49.4	-18.9	68.3	42.51	41.97	20.87	55.95	100	0	P	V
														V
Remark	1. No other spurious found.													
	2. All results are PASS against Peak and Average limit line.													



Band 4 5725~5850MHz
WIFI 802.11ac VHT80 (Band Edge @ 3m)

WIFI Ant. 1+2	Note	Frequency (MHz)	Level (dBμV/m)	Over Limit (dB)	Limit Line (dBμV/m)	Read Level (dBμV)	Antenna Factor (dB/m)	Cable Loss (dB)	Preamp Factor (dB)	Ant Pos (cm)	Table Pos (deg)	Peak Avg. (P/A)	Pol. (H/V)	
		5642.6	65.75	-2.55	68.3	53.54	35.53	11.95	35.27	100	300	P	H	
		5688	82.93	-13.52	96.45	70.67	35.54	12	35.28	100	300	P	H	
		5716	88	-21.78	109.78	75.68	35.54	12.06	35.28	100	300	P	H	
		5724.4	85.24	-35.69	120.93	72.92	35.54	12.06	35.28	100	300	P	H	
	*	5775	110.23	-	-	97.86	35.56	12.11	35.3	100	300	P	H	
	*	5775	106.07	-	-	93.7	35.56	12.11	35.3	100	300	A	H	
		5850.8	82.23	-38.25	120.48	69.69	35.57	12.28	35.31	100	300	P	H	
		5863	82.36	-26.3	108.66	69.71	35.57	12.39	35.31	100	300	P	H	
		5876.6	79.61	-24.5	104.11	66.96	35.58	12.39	35.32	100	300	P	H	
		5938.2	63.1	-5.2	68.3	50.33	35.59	12.51	35.33	100	300	P	H	
802.11ac VHT80 CH 155 5775MHz													H	
													H	
			5643.8	49.96	-18.34	68.3	37.75	35.53	11.95	35.27	100	80	P	V
			5692	73.87	-25.53	99.4	61.61	35.54	12	35.28	100	80	P	V
			5718.8	75.14	-35.42	110.56	62.82	35.54	12.06	35.28	100	80	P	V
			5722.4	76.18	-40.19	116.37	63.86	35.54	12.06	35.28	100	80	P	V
		*	5775	103.26	-	-	90.89	35.56	12.11	35.3	100	80	P	V
		*	5775	98.29	-	-	85.92	35.56	12.11	35.3	100	80	A	V
			5850.2	78.26	-43.58	121.84	65.72	35.57	12.28	35.31	100	80	P	V
			5871.6	76.05	-30.2	106.25	63.39	35.58	12.39	35.31	100	80	P	V
			5875.2	72.87	-32.28	105.15	60.22	35.58	12.39	35.32	100	80	P	V
			5930.2	58.27	-10.03	68.3	45.5	35.59	12.51	35.33	100	80	P	V
														V
														V
	Remark	1. No other spurious found. 2. All results are PASS against Peak and Average limit line.												



Band 4 5725~5850MHz
WIFI 802.11ac VHT80 (Harmonic @ 3m)

WIFI Ant. 1+2	Note	Frequency (MHz)	Level (dBμV/m)	Over Limit (dB)	Limit Line (dBμV/m)	Read Level (dBμV)	Antenna Factor (dB/m)	Cable Loss (dB)	Preamp Factor (dB)	Ant Pos (cm)	Table Pos (deg)	Peak Avg. (P/A)	Pol. (H/V)	
802.11ac VHT80 CH 155 5775MHz		11550	42.52	-31.48	74	44.13	38.45	17.16	57.22	100	0	P	H	
		17325	45.91	-22.39	68.3	39.02	42.01	20.81	55.93	100	0	P	H	
													H	
													H	
			11550	42.12	-31.88	74	43.73	38.45	17.16	57.22	100	0	P	V
			17325	45.32	-22.98	68.3	38.43	42.01	20.81	55.93	100	0	P	V
														V
Remark	1. No other spurious found. 2. All results are PASS against Peak and Average limit line.													



Emission below 1GHz

5GHz WIFI 802.11ac VHT20 (LF @ 3m)

WIFI	Note	Frequency	Level	Over	Limit	Read	Antenna	Cable	Preamp	Ant	Table	Peak	Pol.	
Ant.				Limit	Line	Level	Factor	Loss	Factor	Pos	Pos	Avg.		
1+2		(MHz)	(dBμV/m)	(dB)	(dBμV/m)	(dBμV)	(dB/m)	(dB)	(dB)	(cm)	(deg)	(P/A)	(H/V)	
5GHz 802.11ac VHT 20 LF		30	26.83	-13.17	40	31.11	26	1.07	31.35			P	H	
		161.49	21.93	-21.57	43.5	34.85	16.8	1.78	31.5			P	H	
		240.06	31.98	-14.02	46	43.22	18.09	2.07	31.4			P	H	
		780.2	34.98	-11.02	46	34.2	27.5	3.9	30.62	100	0	P	H	
		876.8	32.91	-13.09	46	30.43	28.86	4.17	30.55			P	H	
		917.4	33.14	-12.86	46	30.14	29.42	4.12	30.54			P	H	
														H
														H
														H
														H
														H
														H
														H
														H
			32.43	29.94	-10.06	40	35.88	24.38	1.07	31.39	100	0	P	V
			116.94	23.15	-20.35	43.5	35.37	17.74	1.55	31.51			P	V
			240.06	27.4	-18.6	46	38.64	18.09	2.07	31.4			P	V
			741	30.58	-15.42	46	30.37	27.06	3.82	30.67			P	V
			854.4	32.5	-13.5	46	30.23	28.73	4.1	30.56			P	V
			922.3	33.18	-12.82	46	30.06	29.54	4.12	30.54			P	V
													V	
													V	
													V	
													V	
													V	
													V	
Remark	1. No other spurious found. 2. All results are PASS against limit line.													



Emission below 1GHz

5GHz WIFI 802.11ac VHT40 (LF @ 3m)

WIFI	Note	Frequency	Level	Over	Limit	Read	Antenna	Cable	Preamp	Ant	Table	Peak	Pol.	
Ant.				Limit	Line	Level	Factor	Loss	Factor	Pos	Pos	Avg.		
1+2		(MHz)	(dBμV/m)	(dB)	(dBμV/m)	(dBμV)	(dB/m)	(dB)	(dB)	(cm)	(deg)	(P/A)	(H/V)	
5GHz 802.11ac VHT40 LF		30.27	28.04	-11.96	40	32.32	26	1.07	31.35			P	H	
		148.53	21.93	-21.57	43.5	33.9	17.75	1.78	31.5			P	H	
		240.06	30.94	-15.06	46	42.18	18.09	2.07	31.4			P	H	
		780.2	36.11	-9.89	46	35.33	27.5	3.9	30.62	100	0	P	H	
		882.4	32.21	-13.79	46	29.69	28.9	4.17	30.55			P	H	
		899.9	33.21	-12.79	46	30.58	29	4.17	30.54			P	H	
													H	
													H	
													H	
													H	
													H	
													H	
													H	
													H	
													H	
													H	
			31.08	30.42	-9.58	40	35.25	25.46	1.07	31.36	100	0	P	V
			117.21	23.18	-20.32	43.5	35.4	17.74	1.55	31.51			P	V
		240.06	29.03	-16.97	46	40.27	18.09	2.07	31.4			P	V	
		780.2	31.78	-14.22	46	31	27.5	3.9	30.62			P	V	
		878.9	32.28	-13.72	46	29.79	28.87	4.17	30.55			P	V	
		899.9	32.88	-13.12	46	30.25	29	4.17	30.54			P	V	
													V	
													V	
													V	
													V	
													V	
													V	
Remark	1. No other spurious found. 2. All results are PASS against limit line.													



Emission below 1GHz

5GHz WIFI 802.11ac VHT80 (LF @ 3m)

WIFI	Note	Frequency	Level	Over	Limit	Read	Antenna	Cable	Preamp	Ant	Table	Peak	Pol.	
Ant.				Limit	Line	Level	Factor	Loss	Factor	Pos	Pos	Avg.		
1+2		(MHz)	(dBμV/m)	(dB)	(dBμV/m)	(dBμV)	(dB/m)	(dB)	(dB)	(cm)	(deg)	(P/A)	(H/V)	
5GHz 802.11ac VHT80 LF		30	27.75	-12.25	40	32.03	26	1.07	31.35			P	H	
		156.36	21.62	-21.88	43.5	34.06	17.28	1.78	31.5			P	H	
		240.06	32.13	-13.87	46	43.37	18.09	2.07	31.4			P	H	
		780.2	35.14	-10.86	46	34.36	27.5	3.9	30.62	100	0	P	H	
		899.9	33.68	-12.32	46	31.05	29	4.17	30.54			P	H	
		951	33.88	-12.12	46	30.14	30.2	4.07	30.53			P	H	
													H	
													H	
													H	
													H	
													H	
													H	
													H	
													H	
													H	
			31.08	31.73	-8.27	40	36.56	25.46	1.07	31.36	100	0	P	V
			113.43	22.84	-20.66	43.5	35.28	17.52	1.55	31.51			P	V
			240.06	28.03	-17.97	46	39.27	18.09	2.07	31.4			P	V
		780.2	32.05	-13.95	46	31.27	27.5	3.9	30.62			P	V	
		836.9	32.31	-13.69	46	30.33	28.45	4.1	30.57			P	V	
		931.4	33.53	-12.47	46	30.19	29.75	4.12	30.53			P	V	
													V	
													V	
													V	
													V	
													V	
													V	
Remark	1. No other spurious found. 2. All results are PASS against limit line.													



Note symbol

*	Fundamental Frequency which can be ignored. However, the level of any unwanted emissions shall not exceed the level of the fundamental frequency.
!	Test result is over limit line.
P/A	Peak or Average
H/V	Horizontal or Vertical



A calculation example for radiated spurious emission is shown as below:

WIFI	Note	Frequency	Level	Over	Limit	Read	Antenna	Cable	Preamp	Ant	Table	Peak	Pol.
Ant.				Limit	Line	Level	Factor	Loss	Factor	Pos	Pos	Avg.	
1+2		(MHz)	(dBμV/m)	(dB)	(dBμV/m)	(dBμV)	(dB/m)	(dB)	(dB)	(cm)	(deg)	(P/A)	(H/V)
802.11b		2390	55.45	-18.55	74	54.51	32.22	4.58	35.86	103	308	P	H
CH 01													
2412MHz		2390	43.54	-10.46	54	42.6	32.22	4.58	35.86	103	308	A	H

- Level(dBμV/m) =
Antenna Factor(dB/m) + Cable Loss(dB) + Read Level(dBμV) - Preamp Factor(dB)
- Over Limit(dB) = Level(dBμV/m) – Limit Line(dBμV/m)

For Peak Limit @ 2390MHz:

- Level(dBμV/m)
= Antenna Factor(dB/m) + Cable Loss(dB) + Read Level(dBμV) - Preamp Factor(dB)
= 32.22(dB/m) + 4.58(dB) + 54.51(dBμV) – 35.86 (dB)
= 55.45 (dBμV/m)
- Over Limit(dB)
= Level(dBμV/m) – Limit Line(dBμV/m)
= 55.45(dBμV/m) – 74(dBμV/m)
= -18.55(dB)

For Average Limit @ 2390MHz:

- Level(dBμV/m)
= Antenna Factor(dB/m) + Cable Loss(dB) + Read Level(dBμV) - Preamp Factor(dB)
= 32.22(dB/m) + 4.58(dB) + 42.6(dBμV) – 35.86 (dB)
= 43.54 (dBμV/m)
- Over Limit(dB)
= Level(dBμV/m) – Limit Line(dBμV/m)
= 43.54(dBμV/m) – 54(dBμV/m)
= -10.46(dB)

Both peak and average measured complies with the limit line, so test result is “PASS”.



Appendix C. Radiated Spurious Emission Plots

Note symbol

-L	Low channel location
-R	High channel location



Band 4 - 5725~5850MHz
WIFI 802.11a (Band Edge @ 3m)

WIFI	Band 4 5725~5850MHz Band Edge @ 3m	
ANT	802.11a CH149 5745MHz	
2	Horizontal	Vertical
Peak	<p>Site : 03CH07HY Condition : FCC PART 15E_BAND4_N 3m HF ANT_130829 HORIZONTAL Detector : Peak Project : 650305</p>	<p>Site : 03CH07HY Condition : FCC PART 15E_BAND4_N 3m HF ANT_130829 VERTICAL Detector : Peak Project : 650305</p>



WIFI	Band 4 5725~5850MHz Fundamental @ 3m	
ANT	802.11a CH149 5745MHz	
2	Horizontal	Vertical
Peak Avg.	<div style="display: flex; justify-content: space-around;"> <div data-bbox="343 600 758 907"> <p>Site : 03CH07HY Condition : FCC PART 15E_BAND4_N 3m HF-ANT_130829 HORIZONTAL Detector : Peak Project : 650305</p> </div> <div data-bbox="933 600 1348 907"> <p>Site : 03CH07HY Condition : FCC PART 15E_BAND4_N 3m HF-ANT_130829 VERTICAL Detector : Peak Project : 650305</p> </div> </div>	



WIFI	Band 4 5725~5850MHz Band Edge @ 3m	
ANT	802.11a CH157 5785MHz – L	
2	Horizontal	Vertical
Peak	<p>Site : 03CH074Y Condition : FCC PART 15E_BAND4_N 3m HF-ANT_130829 HORIZONTAL Detector : Peak Project : 650305</p>	<p>Site : 03CH074Y Condition : FCC PART 15E_BAND4_N 3m HF-ANT_130829 VERTICAL Detector : Peak Project : 650305</p>



WIFI	Band 4 5725~5850MHz Band Edge @ 3m	
ANT	802.11a CH157 5785MHz – R	
2	Horizontal	Vertical
Peak	<p style="font-size: small;">Date: 2016-06-04</p> <p style="font-size: x-small;">Site : 03CH074Y Condition : FCC PART 15E_BAND4_N 3m HF-ANT_130829 HORIZONTAL RBW:1000.000kHz VBW:3000.000kHz SWT:Auto Detector : Peak Project : 650305</p>	<p style="font-size: small;">Date: 2016-06-04</p> <p style="font-size: x-small;">Site : 03CH074Y Condition : FCC PART 15E_BAND4_N 3m HF-ANT_130829 VERTICAL RBW:1000.000kHz VBW:3000.000kHz SWT:Auto Detector : Peak Project : 650305</p>



WIFI	Band 4 5725~5850MHz Fundamental @ 3m	
ANT	802.11a CH157 5785MHz	
2	Horizontal	Vertical
Peak Avg.	<p>Site : 03CH07-HY Condition : FCC PART 15E, BAND4, N 3m HF-ANT, 130829 HORIZONTAL Detector : Peak Project : 650305</p>	<p>Site : 03CH07-HY Condition : FCC PART 15E, BAND4, N 3m HF-ANT, 130829 VERTICAL Detector : Peak Project : 650305</p>



WIFI	Band 4 5725~5850MHz Band Edge @ 3m	
ANT	802.11a CH165 5825MHz	
2	Horizontal	Vertical
Peak	<p style="font-size: small;">Date: 2016-06-04</p> <p style="font-size: x-small;">Site : 03CH07-HY Condition : FCC PART 15E, BAND4, N 3m HF-ANT, 130829 HORIZONTAL RBW: 1000.000kHz VBW: 3000.000kHz SWT: Auto Detector : Peak Project : 650305</p>	<p style="font-size: small;">Date: 2016-06-04</p> <p style="font-size: x-small;">Site : 03CH07-HY Condition : FCC PART 15E, BAND4, N 3m HF-ANT, 130829 VERTICAL RBW: 1000.000kHz VBW: 3000.000kHz SWT: Auto Detector : Peak Project : 650305</p>

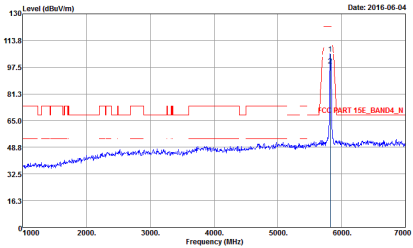
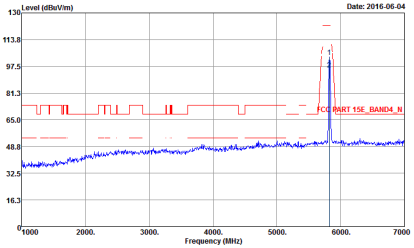

WIFI	Band 4 5725~5850MHz Fundamental @ 3m	
ANT	802.11a CH165 5825MHz	
2	Horizontal	Vertical
Peak Avg.	 <p>Date: 2016-06-04</p> <p>Site : 03CH07-HY Condition : FCC PART 15E_BAND4_N 3m HF-ANT_130829 HORIZONTAL RBW:1000.000kHz VBW:3000.000kHz SWT:Auto Detector : Peak Project : 650305</p>	 <p>Date: 2016-06-04</p> <p>Site : 03CH07-HY Condition : FCC PART 15E_BAND4_N 3m HF-ANT_130829 VERTICAL RBW:1000.000kHz VBW:3000.000kHz SWT:Auto Detector : Peak Project : 650305</p>



Band 4 5725~5850MHz
WIFI 802.11ac VHT20 (Band Edge @ 3m)

Table with 3 columns: WIFI, ANT, and two measurement columns (Horizontal and Vertical). It contains two spectral plots showing Level (dBuV/m) vs Frequency (MHz) for FCC PART 15E_BAND4_N. The left plot is for a horizontal antenna and the right for a vertical antenna. Both plots show a peak at approximately 5745 MHz.



WIFI	Band 4 5725~5850MHz Fundamental @ 3m	
ANT	802.11ac VHT20 CH149 5745MHz	
2	Horizontal	Vertical
Peak Avg.	<p>Site : 03CH07HY Condition : FCC PART 15E, BAND4, N 3m HF-ANT, 130829 HORIZONTAL Detector : Peak Project : 650305</p>	<p>Site : 03CH07HY Condition : FCC PART 15E, BAND4, N 3m HF-ANT, 130829 VERTICAL Detector : Peak Project : 650305</p>



WIFI	Band 4 5725~5850MHz Band Edge @ 3m	
ANT	802.11ac VHT20 CH157 5785MHz - L	
2	Horizontal	Vertical
Peak	<p>Site : 03CH07HY Condition : FCC PART 15E_BAND4_N 3m HF-ANT_130829 HORIZONTAL Detector : Peak Project : 650305</p>	<p>Site : 03CH07HY Condition : FCC PART 15E_BAND4_N 3m HF-ANT_130829 VERTICAL Detector : Peak Project : 650305</p>



WIFI	Band 4 5725~5850MHz Band Edge @ 3m	
ANT	802.11ac VHT20 CH157 5785MHz - R	
2	Horizontal	Vertical
Peak	<p>Site : 03CH074Y Condition : FCC PART 15E_BAND4_N 3m HF-ANT_130829 HORIZONTAL Detector : Peak Project : 650305</p>	<p>Site : 03CH074Y Condition : FCC PART 15E_BAND4_N 3m HF-ANT_130829 VERTICAL Detector : Peak Project : 650305</p>



WIFI	Band 4 5725~5850MHz Fundamental @ 3m	
ANT	802.11ac VHT20 CH157 5785MHz	
2	Horizontal	Vertical
Peak Avg.	<p>Site : 03CH074Y Condition : FCC PART 15E, BAND4, N 3m HF-ANT, 130829 HORIZONTAL Detector : Peak Project : 650305</p>	<p>Site : 03CH074Y Condition : FCC PART 15E, BAND4, N 3m HF-ANT, 130829 VERTICAL Detector : Peak Project : 650305</p>



WIFI	Band 4 5725~5850MHz Band Edge @ 3m	
ANT	802.11ac VHT20 CH165 5825MHz	
2	Horizontal	Vertical
Peak	<p>Site : 03CH074Y Condition : FCC PART 15E_BAND4_N 3m HF-ANT_130829 HORIZONTAL RBW: 1000.000kHz VBW: 3000.000kHz SWT: Auto Detector : Peak Project : 650305</p>	<p>Site : 03CH074Y Condition : FCC PART 15E_BAND4_N 3m HF-ANT_130829 VERTICAL RBW: 1000.000kHz VBW: 3000.000kHz SWT: Auto Detector : Peak Project : 650305</p>



WIFI	Band 4 5725~5850MHz Fundamental @ 3m	
ANT	802.11ac VHT20 CH165 5825MHz	
2	Horizontal	Vertical
Peak Avg.	<p>Site : 03CH074Y Condition : FCC PART 15E_BAND4_N 3m HF-ANT_130829 HORIZONTAL Detector : Peak Project : 650305</p>	<p>Site : 03CH074Y Condition : FCC PART 15E_BAND4_N 3m HF-ANT_130829 VERTICAL Detector : Peak Project : 650305</p>



Band 4 5725~5850MHz
WIFI 802.11ac VHT40 (Band Edge @ 3m)

Table with 3 columns: WIFI, ANT, and measurement results for Horizontal and Vertical orientations. Includes spectral plots and technical details like Site, Condition, Detector, and Project.



WIFI	Band 4 5725~5850MHz Band Edge @ 3m	
ANT	802.11ac VHT40 CH151 5755MHz- R	
2	Horizontal	Vertical
Peak	<p>Site : 03CH074Y Condition : FCC PART 15E_BAND4_N 3m HF-ANT_130829 HORIZONTAL Detector : Peak Project : 650305</p>	<p>Site : 03CH074Y Condition : FCC PART 15E_BAND4_N 3m HF-ANT_130829 VERTICAL Detector : Peak Project : 650305</p>



WIFI	Band 4 5725~5850MHz Fundamental @ 3m	
ANT	802.11ac VHT40 CH151 5755MHz	
2	Horizontal	Vertical
Peak Avg.	<p>Site : 03CH07HY Condition : FCC PART 15E, BAND4, N 3m HF-ANT, 130829 HORIZONTAL Detector : Peak Project : 650305</p>	<p>Site : 03CH07HY Condition : FCC PART 15E, BAND4, N 3m HF-ANT, 130829 VERTICAL Detector : Peak Project : 650305</p>



WIFI	Band 4 5725~5850MHz Band Edge @ 3m	
ANT	802.11ac VHT40 CH159 5795MHz- L	
2	Horizontal	Vertical
Peak	<p>Site : 03CH074Y Condition : FCC PART 15E_BAND4_N 3m HF-ANT_130829 HORIZONTAL Detector : Peak Project : 650305</p>	<p>Site : 03CH074Y Condition : FCC PART 15E_BAND4_N 3m HF-ANT_130829 VERTICAL Detector : Peak Project : 650305</p>

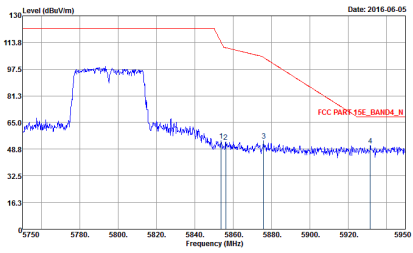
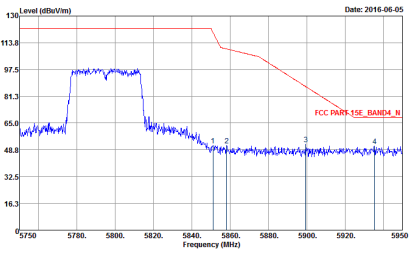

WIFI	Band 4 5725~5850MHz Band Edge @ 3m	
ANT	802.11ac VHT40 CH159 5795MHz- R	
2	Horizontal	Vertical
Peak	 <p data-bbox="347 896 762 952"> Site : 03CH074Y Condition : FCC PART 15E_BAND4_N 3m HF-ANT_130829 HORIZONTAL Detector : Peak Project : 650305 </p>	 <p data-bbox="946 896 1361 952"> Site : 03CH074Y Condition : FCC PART 15E_BAND4_N 3m HF-ANT_130829 VERTICAL Detector : Peak Project : 650305 </p>



WIFI	Band 4 5725~5850MHz Fundamental @ 3m	
ANT	802.11ac VHT40 CH159 5795MHz	
2	Horizontal	Vertical
Peak Avg.	<p>Site : 03CH074Y Condition : FCC PART 15E_BAND4_N 3m HF-ANT_130829 HORIZONTAL Detector : Peak Project : 650305</p>	<p>Site : 03CH074Y Condition : FCC PART 15E_BAND4_N 3m HF-ANT_130829 VERTICAL Detector : Peak Project : 650305</p>



**Band 4 5725~5850MHz
WIFI 802.11ac VHT80 (Band Edge @ 3m)**

WIFI	Band 4 5725~5850MHz Band Edge @ 3m	
ANT	802.11ac VHT80 CH155 5775MHz - L	
2	Horizontal	Vertical
Peak	<p> Date: 2016-06-02 Site : 03CH07-HY Condition : FCC PART 15E_BAND4_N 3m HF-ANT_130829 HORIZONTAL Detector : Peak Project : 650305 </p>	<p> Date: 2016-06-02 Site : 03CH07-HY Condition : FCC PART 15E_BAND4_N 3m HF-ANT_130829 VERTICAL Detector : Peak Project : 650305 </p>



WIFI	Band 4 5725~5850MHz Band Edge @ 3m	
ANT	802.11ac VHT80 CH155 5775MHz - R	
2	Horizontal	Vertical
Peak	<p>Site : 03CH07HY Condition : FCC PART 15E_BAND4_N 3m HF-ANT_130829 HORIZONTAL Detector : Peak Project : 650305</p>	<p>Site : 03CH07HY Condition : FCC PART 15E_BAND4_N 3m HF-ANT_130829 VERTICAL Detector : Peak Project : 650305</p>



WIFI	Band 4 5725~5850MHz Fundamental @ 3m	
ANT	802.11ac VHT80 CH155 5775MHz	
2	Horizontal	Vertical
<p>Peak Avg.</p>	<p>Date: 2016-06-02</p> <p>Site : 03CH074Y Condition : FCC PART 15E, BAND4, N 3m HF-ANT, 130829 HORIZONTAL Detector : Peak Project : 650305</p>	<p>Date: 2016-06-02</p> <p>Site : 03CH074Y Condition : FCC PART 15E, BAND4, N 3m HF-ANT, 130829 VERTICAL Detector : Peak Project : 650305</p>



Band 4 - 5725~5850MHz
WIFI 802.11a (Harmonic @ 3m)

Table with 3 columns: WIFI, ANT, and measurement results for Horizontal and Vertical orientations. Includes spectral plots and site information.



WIFI	Band 4 5725-5850MHz Harmonic @ 3m	
ANT	802.11a CH157 5785MHz	
2	Horizontal	Vertical
Peak Avg.		

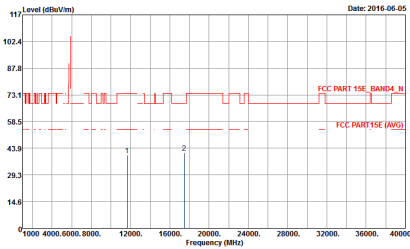
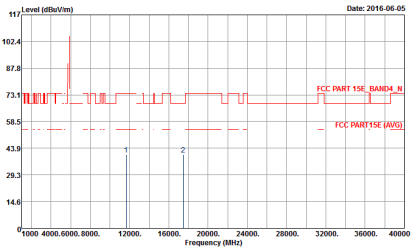

WIFI	Band 4 5725-5850MHz Harmonic @ 3m	
ANT	802.11a CH165 5825MHz	
2	Horizontal	Vertical
<p>Peak Avg.</p>	 <p>Site : 03CH07-HY Condition : FCC PART 15E_BAND4_N 3m SHF-EHF_131029 HORIZONTAL Detector : Peak Project : 650305</p>	 <p>Site : 03CH07-HY Condition : FCC PART 15E_BAND4_N 3m SHF-EHF_131029 VERTICAL Detector : Peak Project : 650305</p>



**Band 4 5725~5850MHz
WIFI 802.11ac VHT20 (Harmonic @ 3m)**

WIFI	Band 4 5725~5850MHz Harmonic @ 3m	
ANT	802.11ac VHT20 CH149 5745MHz	
2	Horizontal	Vertical
<p>Peak Avg.</p>	<p>Site : 03CH07-HY Condition : FCC PART 15E_BAND4_N 3m SHF/EHF_131029 HORIZONTAL Detector : Peak Project : 650305</p>	<p>Site : 03CH07-HY Condition : FCC PART 15E_BAND4_N 3m HF-ANT_130829 VERTICAL Detector : Peak Project : 650305</p>



WIFI	Band 4 5725-5850MHz Harmonic @ 3m	
ANT	802.11ac VHT20 CH157 5785MHz	
2	Horizontal	Vertical
<p>Peak Avg.</p>	<p>Site : 03CH07-HY Condition : FCC PART 15E_BAND4_N 3m SHF-EHF_131029 HORIZONTAL Detector : Peak Project : 650305</p>	<p>Site : 03CH07-HY Condition : FCC PART 15E_BAND4_N 3m SHF-EHF_131029 VERTICAL Detector : Peak Project : 650305</p>



WIFI	Band 4 5725-5850MHz Harmonic @ 3m	
ANT	802.11ac VHT20 CH165 5825MHz	
2	Horizontal	Vertical
<p>Peak Avg.</p>	<p>Site : 03CH07-HY Condition : FCC PART 15E_BAND4_N 3m SHF-EHF_131029 HORIZONTAL Detector : Peak Project : 650305</p>	<p>Site : 03CH07-HY Condition : FCC PART 15E_BAND4_N 3m SHF-EHF_131029 VERTICAL Detector : Peak Project : 650305</p>

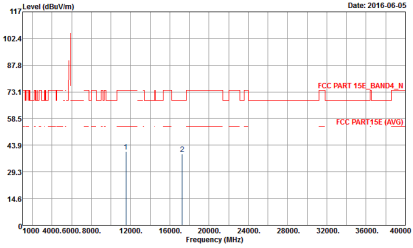
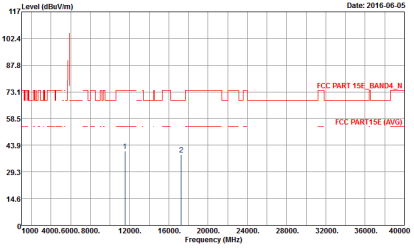

**Band 4 5725~5850MHz
WIFI 802.11ac VHT40 (Harmonic @ 3m)**

WIFI	Band 4 5725~5850MHz Harmonic @ 3m	
ANT	802.11ac VHT40 CH151 5755MHz	
2	Horizontal	Vertical
<p>Peak</p> <p>Avg.</p>	 <p>Site : 63CH7JHY Condition : FCC PART 15E_BAND4_N 3m SHF-EHF_131029 HORIZONTAL Detector : Peak Project : 650305</p>	 <p>Site : 63CH7JHY Condition : FCC PART 15E_BAND4_N 3m SHF-EHF_131029 VERTICAL Detector : Peak Project : 650305</p>



WIFI	Band 4 5725-5850MHz Harmonic @ 3m	
ANT	802.11ac VHT40 CH159 5795MHz	
2	Horizontal	Vertical
Peak Avg.	<p>Site : 03CH07.HY Condition : FCC PART 15E_BAND4_N 3m SHF-EHF_131029 HORIZONTAL Detector : Peak Project : 650305</p>	<p>Site : 03CH07.HY Condition : FCC PART 15E_BAND4_N 3m SHF-EHF_131029 VERTICAL Detector : Peak Project : 650305</p>



Band 4 5725~5850MHz
WIFI 802.11ac VHT80 (Harmonic @ 3m)

Table with 3 columns: WIFI, ANT, and measurement results for Horizontal and Vertical orientations. Includes peak and average level graphs for FCC Part 15E Band 4.



Emission below 1GHz
5GHz WIFI 802.11a (LF)

WIFI	5GHz 5725~5850MHz	
ANT	802.11a LF	
2	Horizontal	Vertical
QP / Peak	<p>Site : 03CH07-HY Condition : FCC CLASS-B 3m LF-ANT-35419(6) HORIZONTAL Detector : Peak Project : 650305</p>	<p>Site : 03CH07-HY Condition : FCC CLASS-B 3m LF-ANT-35419(6) VERTICAL Detector : Peak Project : 650305</p>



Emission below 1GHz
5GHz WIFI 802.11ac VHT20 (LF)

WIFI	5GHz 5725~5850MHz	
ANT	802.11ac VHT20 LF	
2	Horizontal	Vertical
QP / Peak	<p>Site : 03CH07-HY Condition : FCC CLASS-B 3m LF-ANT-35419(6) HORIZONTAL Detector : Peak Project : 650305</p>	<p>Site : 03CH07-HY Condition : FCC CLASS-B 3m LF-ANT-35419(6) VERTICAL Detector : Peak Project : 650305</p>



Emission below 1GHz
5GHz WIFI 802.11ac VHT40 (LF)

Table with 3 columns: WIFI (5GHz 5725~5850MHz), ANT (802.11ac VHT40 LF), and 2 (Horizontal/Vertical). It contains two graphs showing Level (dBuV/m) vs Frequency (MHz) for QP / Peak, with FCC CLASS B limits and site details.



Emission below 1GHz
5GHz WIFI 802.11ac VHT80 (LF)

Table with 3 columns: WIFI (5GHz 5725~5850MHz), ANT (802.11ac VHT80 LF), and 2 (Horizontal/Vertical). It contains two graphs showing Level (dBuV/m) vs Frequency (MHz) for QP / Peak, with FCC CLASS B limits and test parameters.



Band 4 - 5725~5850MHz
WIFI 802.11a (Band Edge @ 3m)

Table with 3 columns: WIFI, ANT, and Peak. It contains two spectral plots: Horizontal and Vertical. Each plot shows Level (dBm/m) vs Frequency (MHz) with a red line for the limit and a blue line for the actual signal. Includes site and condition details for each plot.

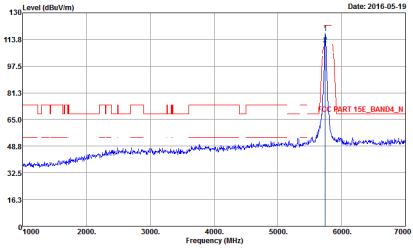
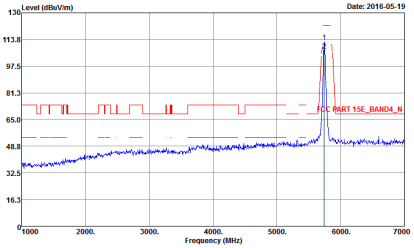

WIFI	Band 4 5725~5850MHz Fundamental @ 3m	
ANT	802.11a CH149 5745MHz	
1+2	Horizontal	Vertical
<p>Peak Avg.</p>	 <p>Date: 2016-05-19</p> <p>Site : 03CH074Y Condition : FCC PART 15E_BAND4_N 3m HF-ANT_130829 HORIZONTAL Detector : Peak Project : 650305</p>	 <p>Date: 2016-05-19</p> <p>Site : 03CH074Y Condition : FCC PART 15E_BAND4_N 3m HF-ANT_130829 VERTICAL Detector : Peak Project : 650305</p>



WIFI	Band 4 5725~5850MHz Band Edge @ 3m	
ANT	802.11a CH157 5785MHz – L	
1+2	Horizontal	Vertical
Peak	<p style="font-size: small;"> Date: 2016-05-23 Site : 03CH07.HY Condition : FCC PART 15E_BAND4_N 3m HF-ANT, 130829 HORIZONTAL RBW: 1000.000kHz VBW:3000.000kHz SWT:Auto Detector : Peak Project : 650305 </p>	<p style="font-size: small;"> Date: 2016-05-23 Site : 03CH07.HY Condition : FCC PART 15E_BAND4_N 3m HF-ANT, 130829 VERTICAL RBW: 1000.000kHz VBW:3000.000kHz SWT:Auto Detector : Peak Project : 650305 </p>



WIFI	Band 4 5725~5850MHz Band Edge @ 3m	
ANT	802.11a CH157 5785MHz – R	
1+2	Horizontal	Vertical
Peak	<p>Site : 03CH07HY Condition : FCC PART 15E_BAND4_N 3m HF-ANT_130829 HORIZONTAL RBW: 1000.000kHz VBW: 3000.000kHz SWT: Auto Detector : Peak Project : 650305</p>	<p>Site : 03CH07HY Condition : FCC PART 15E_BAND4_N 3m HF-ANT_130829 VERTICAL RBW: 1000.000kHz VBW: 3000.000kHz SWT: Auto Detector : Peak Project : 650305</p>



WIFI	Band 4 5725~5850MHz Fundamental @ 3m	
ANT	802.11a CH157 5785MHz	
1+2	Horizontal	Vertical
Peak Avg.	<p>Site : 03CH07HY Condition : FCC PART 15E_BAND4_N 3m HF-ANT_130829 HORIZONTAL RBW: 1000.000kHz VBW: 3000.000kHz SWT: Auto Detector : Peak Project : 650305</p>	<p>Site : 03CH07HY Condition : FCC PART 15E_BAND4_N 3m HF-ANT_130829 VERTICAL RBW: 1000.000kHz VBW: 3000.000kHz SWT: Auto Detector : Peak Project : 650305</p>



WIFI	Band 4 5725~5850MHz Band Edge @ 3m	
ANT	802.11a CH165 5825MHz	
1+2	Horizontal	Vertical
Peak	<p>Site : 03CH07HY Condition : FCC PART 15E_BAND4_N 3m HF-ANT_130829 HORIZONTAL RBW: 1000.000kHz VBW:3000.000kHz SWT:Auto Detector : Peak Project : 650305</p>	<p>Site : 03CH07HY Condition : FCC PART 15E_BAND4_N 3m HF-ANT_130829 VERTICAL RBW: 1000.000kHz VBW:3000.000kHz SWT:Auto Detector : Peak Project : 650305</p>



WIFI	Band 4 5725~5850MHz Fundamental @ 3m	
ANT	802.11a CH165 5825MHz	
1+2	Horizontal	Vertical
Peak Avg.	<p style="font-size: small;">Date: 2016-05-19</p> <p style="font-size: x-small;">Site : 03CH07HY Condition : FCC PART 15E_BAND4_N 3m HF-ANT_130829 HORIZONTAL RBW: 1000.000kHz VBW: 3000.000kHz SWT: Auto Detector : Peak Project : 650305</p>	<p style="font-size: small;">Date: 2016-05-19</p> <p style="font-size: x-small;">Site : 03CH07HY Condition : FCC PART 15E_BAND4_N 3m HF-ANT_130829 VERTICAL RBW: 1000.000kHz VBW: 3000.000kHz SWT: Auto Detector : Peak Project : 650305</p>

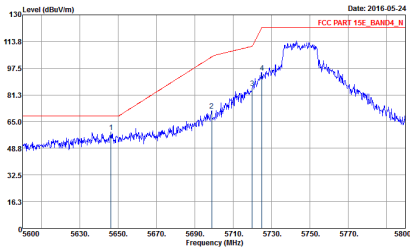
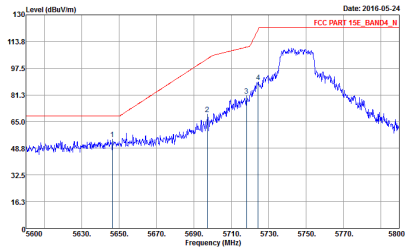

**Band 4 5725~5850MHz
WIFI 802.11ac VHT20 (Band Edge @ 3m)**

WIFI	Band 4 5725~5850MHz Band Edge @ 3m	
ANT	802.11ac VHT20 CH149 5745MHz	
1+2	Horizontal	Vertical
Peak	 <p>Date: 2016-05-24 FCC PART 15E_BAND4_N</p> <p>Site : 03CH07-HY Condition : FCC PART 15E_BAND4_N 3m HF-ANT_130829 HORIZONTAL RBW: 1000.000kHz VBW: 3000.000kHz SWT: Auto Detector : Peak Project : 650305</p>	 <p>Date: 2016-05-24 FCC PART 15E_BAND4_N</p> <p>Site : 03CH07-HY Condition : FCC PART 15E_BAND4_N 3m HF-ANT_130829 VERTICAL RBW: 1000.000kHz VBW: 3000.000kHz SWT: Auto Detector : Peak Project : 650305</p>



WIFI	Band 4 5725~5850MHz Fundamental @ 3m	
ANT	802.11ac VHT20 CH149 5745MHz	
1+2	Horizontal	Vertical
Peak Avg.	<p>Site : 03CH074Y Condition : FCC PART 15E_BAND4_N 3m HF-ANT_130829 HORIZONTAL Detector : Peak Project : 650305</p>	<p>Site : 03CH074Y Condition : FCC PART 15E_BAND4_N 3m HF-ANT_130829 VERTICAL Detector : Peak Project : 650305</p>



WIFI	Band 4 5725~5850MHz Band Edge @ 3m	
ANT	802.11ac VHT20 CH157 5785MHz - L	
1+2	Horizontal	Vertical
Peak	<p>Site : 03CH074Y Condition : FCC PART 15E_BAND4_N 3m HF-ANT, 130829 HORIZONTAL RBW: 1000.000KHz, VBW: 3000.000KHz, SWT: Auto Detector : Peak Project : 650305 Date: 2016-05-24</p>	<p>Site : 03CH074Y Condition : FCC PART 15E_BAND4_N 3m HF-ANT, 130829 VERTICAL RBW: 1000.000KHz, VBW: 3000.000KHz, SWT: Auto Detector : Peak Project : 650305 Date: 2016-05-24</p>



WIFI	Band 4 5725~5850MHz Band Edge @ 3m	
ANT	802.11ac VHT20 CH157 5785MHz - R	
1+2	Horizontal	Vertical
Peak	<p>Site : 03CH074Y Condition : FCC PART 15E_BAND4_N 3m HF-ANT_130829 HORIZONTAL RBW: 1000.000kHz VBW: 3000.000kHz SWT: Auto Detector : Peak Project : 650305</p>	<p>Site : 03CH074Y Condition : FCC PART 15E_BAND4_N 3m HF-ANT_130829 VERTICAL RBW: 1000.000kHz VBW: 3000.000kHz SWT: Auto Detector : Peak Project : 650305</p>



WIFI	Band 4 5725~5850MHz Fundamental @ 3m	
ANT	802.11ac VHT20 CH157 5785MHz	
1+2	Horizontal	Vertical
<p>Peak Avg.</p>	<p>Date: 2016-05-24</p> <p>Site : 03CH074Y Condition : FCC PART 15E_BAND4_N 3m HF-ANT_130829 HORIZONTAL Detector : Peak Project : 650305</p>	<p>Date: 2016-05-24</p> <p>Site : 03CH074Y Condition : FCC PART 15E_BAND4_N 3m HF-ANT_130829 VERTICAL Detector : Peak Project : 650305</p>



WIFI	Band 4 5725~5850MHz Band Edge @ 3m	
ANT	802.11ac VHT20 CH165 5825MHz	
1+2	Horizontal	Vertical
Peak	<p>Site : 03CH67.HY Condition : FCC PART 15E_BAND4_N 3m HF-ANT_130829 HORIZONTAL RBW: 1000.000kHz VBW: 3000.000kHz SWT: Auto Detector : Peak Project : 650305</p>	<p>Site : 03CH67.HY Condition : FCC PART 15E_BAND4_N 3m HF-ANT_130829 VERTICAL RBW: 1000.000kHz VBW: 3000.000kHz SWT: Auto Detector : Peak Project : 650305</p>



WIFI	Band 4 5725~5850MHz Fundamental @ 3m	
ANT	802.11ac VHT20 CH165 5825MHz	
1+2	Horizontal	Vertical
Peak Avg.	<p>Site : 03CH07.HY Condition : FCC PART 15E_BAND4_N 3m HF-ANT_130829 HORIZONTAL RBW: 1000.000kHz VBW: 3000.000kHz SWT: Auto Detector : Peak Project : 650305</p>	<p>Site : 03CH07.HY Condition : FCC PART 15E_BAND4_N 3m HF-ANT_130829 VERTICAL RBW: 1000.000kHz VBW: 3000.000kHz SWT: Auto Detector : Peak Project : 650305</p>



Band 4 5725~5850MHz
WIFI 802.11ac VHT40 (Band Edge @ 3m)

Table with 3 columns: WIFI, ANT, and 1+2. It contains two spectral plots: Horizontal and Vertical. Each plot shows Level (dBuV/m) vs Frequency (MHz) with a red line for the limit and a blue line for the actual signal. The word 'Peak' is written vertically on the left side of the plots.

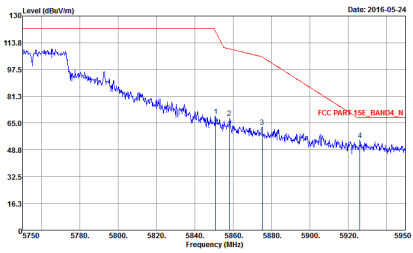
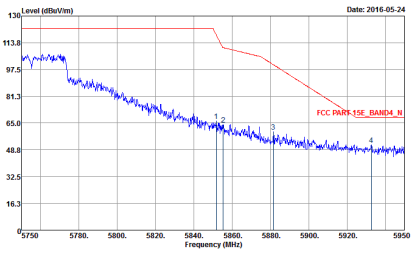

WIFI	Band 4 5725~5850MHz Band Edge @ 3m	
ANT	802.11ac VHT40 CH151 5755MHz- R	
1+2	Horizontal	Vertical
Peak	 <p>Date: 2016-05-24</p> <p>Site : 03CH07HY Condition : FCC PART 15E_BAND4_N 3m HF-ANT_130829 HORIZONTAL RBW:1000.000KHz VBW:3000.000KHz SWT:Auto Detector : Peak Project : 650305</p>	 <p>Date: 2016-05-24</p> <p>Site : 03CH07HY Condition : FCC PART 15E_BAND4_N 3m HF-ANT_130829 VERTICAL RBW:1000.000KHz VBW:3000.000KHz SWT:Auto Detector : Peak Project : 650305</p>



WIFI	Band 4 5725~5850MHz Fundamental @ 3m	
ANT	802.11ac VHT40 CH151 5755MHz	
1+2	Horizontal	Vertical
Peak Avg.	<p>Site : 03CH074Y Condition : FCC PART 15E_BAND4_N 3m HF-ANT_130829 HORIZONTAL Detector : Peak Project : 650305</p>	<p>Site : 03CH074Y Condition : FCC PART 15E_BAND4_N 3m HF-ANT_130829 VERTICAL Detector : Peak Project : 650305</p>



WIFI	Band 4 5725~5850MHz Band Edge @ 3m	
ANT	802.11ac VHT40 CH159 5795MHz- L	
1+2	Horizontal	Vertical
Peak	<p>Site : 03CH07HY Condition : FCC PART 15E_BAND4_N 3m HF-ANT_130829 HORIZONTAL RBW: 1000.000kHz VBW: 3000.000kHz SWT: Auto Detector : Peak Project : 650305</p>	<p>Site : 03CH07HY Condition : FCC PART 15E_BAND4_N 3m HF-ANT_130829 VERTICAL RBW: 1000.000kHz VBW: 3000.000kHz SWT: Auto Detector : Peak Project : 650305</p>



WIFI	Band 4 5725~5850MHz Band Edge @ 3m	
ANT	802.11ac VHT40 CH159 5795MHz- R	
1+2	Horizontal	Vertical
Peak	<p>Site : 03CH074Y Condition : FCC PART 15E_BAND4_N 3m HF-ANT_130829 HORIZONTAL Detector : Peak Project : 650305</p>	<p>Site : 03CH074Y Condition : FCC PART 15E_BAND4_N 3m HF-ANT_130829 VERTICAL Detector : Peak Project : 650305</p>



WIFI	Band 4 5725~5850MHz Fundamental @ 3m	
ANT	802.11ac VHT40 CH159 5795MHz	
1+2	Horizontal	Vertical
<p>Peak Avg.</p>	<p>Date: 2016-05-24</p> <p>Site : 03CH07HY Condition : FCC PART 15E_BAND4_N 3m HF-ANT_130829 HORIZONTAL Detector : Peak Project : 650305</p>	<p>Date: 2016-05-24</p> <p>Site : 03CH07HY Condition : FCC PART 15E_BAND4_N 3m HF-ANT_130829 VERTICAL Detector : Peak Project : 650305</p>



Band 4 5725~5850MHz
WIFI 802.11ac VHT80 (Band Edge @ 3m)

Table with 2 columns: Horizontal and Vertical. Row 1: WIFI, Band 4 5725~5850MHz Band Edge @ 3m. Row 2: ANT, 802.11ac VHT80 CH155 5775MHz - L. Row 3: 1+2, Peak. Contains two spectral plots and technical details for Site, Condition, Detector, and Project.



WIFI	Band 4 5725~5850MHz Band Edge @ 3m	
ANT	802.11ac VHT80 CH155 5775MHz - R	
1+2	Horizontal	Vertical
Peak	<p>Site : 03CH07HY Condition : FCC PART 15E_BAND4_N 3m HF-ANT_130829 HORIZONTAL RBW:1000.000kHz VBW:3000.000kHz SWT:Auto Detector : Peak Project : 650305</p>	<p>Site : 03CH07HY Condition : FCC PART 15E_BAND4_N 3m HF-ANT_130829 VERTICAL RBW:1000.000kHz VBW:3000.000kHz SWT:Auto Detector : Peak Project : 650305</p>



WIFI	Band 4 5725~5850MHz Fundamental @ 3m	
ANT	802.11ac VHT80 CH155 5775MHz	
1+2	Horizontal	Vertical
<p>Peak Avg.</p>	<p>Date: 2016-05-26</p> <p>Site : 03CH07HY Condition : FCC PART 15E_BAND4_N 3m HF-ANT_130829 HORIZONTAL Defector : Peak Project : 650305</p>	<p>Date: 2016-05-26</p> <p>Site : 03CH07HY Condition : FCC PART 15E_BAND4_N 3m HF-ANT_130829 VERTICAL Defector : Peak Project : 650305</p>



Band 4 - 5725~5850MHz
WIFI 802.11a (Harmonic @ 3m)

WIFI	Band 4 5725~5850MHz Harmonic @ 3m	
ANT	802.11a CH149 5745MHz	
1+2	Horizontal	Vertical
Peak Avg.	<p>Site : 03CH07-HY Condition : FCC PART 15E_BAND4_N 3m SHF-EHF_131029 HORIZONTAL Detector : Peak Project : 650305</p>	<p>Site : 03CH07-HY Condition : FCC PART 15E_BAND4_N 3m SHF-EHF_131029 VERTICAL Detector : Peak Project : 650305</p>

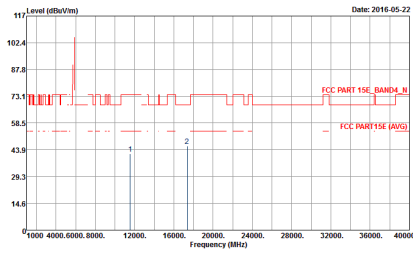
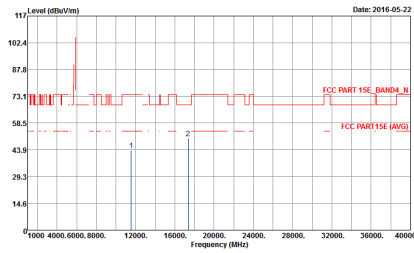

WIFI	Band 4 5725-5850MHz Harmonic @ 3m	
ANT	802.11a CH157 5785MHz	
1+2	Horizontal	Vertical
Peak Avg.	 <p style="font-size: small;"> Date: 2016-05-22 Site : 03CH07HY Condition : FCC PART 15E, BAND4, N 3m HF-ANT, 130829 HORIZONTAL Detector : Peak Project : 650305 </p>	 <p style="font-size: small;"> Date: 2016-05-22 Site : 03CH07HY Condition : FCC PART 15E, BAND4, N 3m HF-ANT, 130829 VERTICAL Detector : Peak Project : 650305 </p>

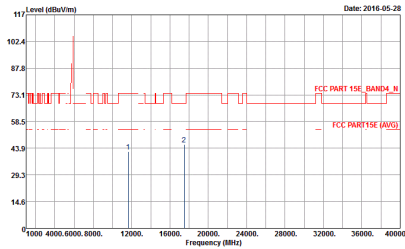
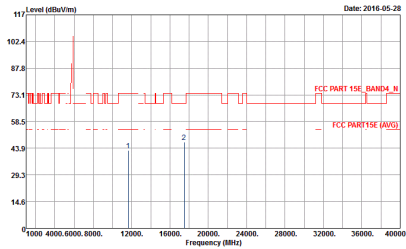

WIFI	Band 4 5725-5850MHz Harmonic @ 3m	
ANT	802.11a CH165 5825MHz	
1+2	Horizontal	Vertical
<p>Peak</p> <p>Avg.</p>	 <p>Site : 03CH07-HY Condition : FCC PART 15E_BAND4_N 3m SHF-EHF_131029 HORIZONTAL Detector : Peak Project : 650305</p>	 <p>Site : 03CH07-HY Condition : FCC PART 15E_BAND4_N 3m SHF-EHF_131029 VERTICAL Detector : Peak Project : 650305</p>



**Band 4 5725~5850MHz
WIFI 802.11ac VHT20 (Harmonic @ 3m)**

WIFI	Band 4 5725~5850MHz Harmonic @ 3m	
ANT	802.11ac VHT20 CH149 5745MHz	
1+2	Horizontal	Vertical
<p>Peak Avg.</p>	<p>Date: 2016-05-28</p> <p>Site : 03CH07.HY Condition : FCC PART 15E_BAND4_N 3m SHF-EHF_131029 HORIZONTAL Detector : Peak Project : 650305</p>	<p>Date: 2016-05-28</p> <p>Site : 03CH07.HY Condition : FCC PART 15E_BAND4_N 3m SHF-EHF_131029 VERTICAL Detector : Peak Project : 650305</p>

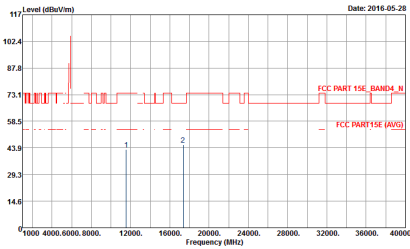
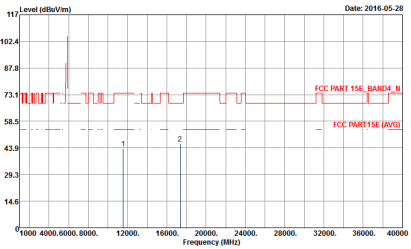

WIFI	Band 4 5725-5850MHz Harmonic @ 3m	
ANT	802.11ac VHT20 CH157 5785MHz	
1+2	Horizontal	Vertical
Peak Avg.	 <p style="font-size: small;">Date: 2016-05-28</p> <p style="font-size: x-small;">Site : 03CH07-HY Condition : FCC PART 15E_BAND4_N 3m SHF-EHF_131029 HORIZONTAL Detector : Peak Project : 650305</p>	 <p style="font-size: small;">Date: 2016-05-28</p> <p style="font-size: x-small;">Site : 03CH07-HY Condition : FCC PART 15E_BAND4_N 3m SHF-EHF_131029 VERTICAL Detector : Peak Project : 650305</p>

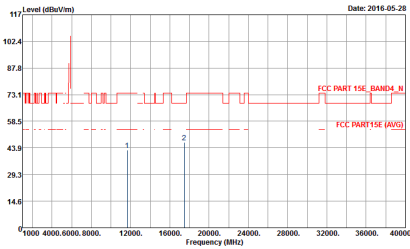
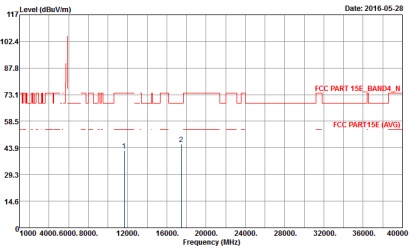

WIFI	Band 4 5725-5850MHz Harmonic @ 3m	
ANT	802.11ac VHT20 CH165 5825MHz	
1+2	Horizontal	Vertical
Peak Avg.	 <p>Site : 03CH07-HY Condition : FCC PART 15E_BAND4_N 3m SHF-EHF_131029 HORIZONTAL Detector : Peak Project : 650305</p>	 <p>Site : 03CH07-HY Condition : FCC PART 15E_BAND4_N 3m SHF-EHF_131029 VERTICAL Detector : Peak Project : 650305</p>

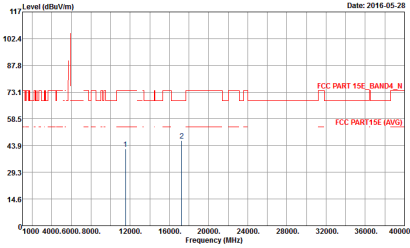
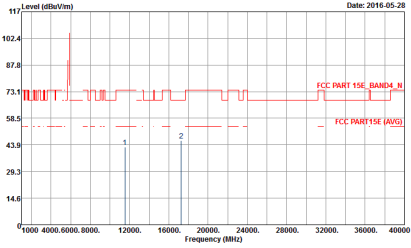

**Band 4 5725~5850MHz
WIFI 802.11ac VHT40 (Harmonic @ 3m)**

WIFI	Band 4 5725~5850MHz Harmonic @ 3m	
ANT	802.11ac VHT40 CH151 5755MHz	
1+2	Horizontal	Vertical
<p>Peak Avg.</p>	 <p>Date: 2016-05-28</p> <p>Site : 03CH07.HY Condition : FCC PART 15E_BAND4_N 3m SHF-EHF_131029 HORIZONTAL Detector : Peak Project : 650305</p>	 <p>Date: 2016-05-28</p> <p>Site : 03CH07.HY Condition : FCC PART 15E_BAND4_N 3m SHF-EHF_131029 VERTICAL Detector : Peak Project : 650305</p>



WIFI	Band 4 5725-5850MHz Harmonic @ 3m	
ANT	802.11ac VHT40 CH159 5795MHz	
1+2	Horizontal	Vertical
Peak Avg.	<p>Site : 03CH07-HY Condition : FCC PART 15E_BAND4_N 3m SHF-EHF_131029 HORIZONTAL Detector : Peak Project : 650305</p>	<p>Site : 03CH07-HY Condition : FCC PART 15E_BAND4_N 3m SHF-EHF_131029 VERTICAL Detector : Peak Project : 650305</p>



**Band 4 5725~5850MHz
WIFI 802.11ac VHT80 (Harmonic @ 3m)**

WIFI	Band 4 5725~5850MHz Harmonic @ 3m	
ANT	802.11ac VHT80 CH155 5775MHz	
1+2	Horizontal	Vertical
<p>Peak Avg.</p>	<p>Site : 03CH07.HY Condition : FCC PART 15E_BAND4_N 3m SHF-EHF_131029 HORIZONTAL Detector : Peak Project : 650305</p>	<p>Site : 03CH07.HY Condition : FCC PART 15E_BAND4_N 3m SHF-EHF_131029 VERTICAL Detector : Peak Project : 650305</p>



Emission below 1GHz
5GHz WIFI 802.11a (LF)

WIFI	5GHz 5725~5850MHz	
ANT	802.11a LF	
1+2	Horizontal	Vertical
QP / Peak	<p>Site : 63CH7-HY Condition : FCC CLASS-B 3m LF-ANT:35419(6) HORIZONTAL Detector : Peak</p>	<p>Site : 63CH7-HY Condition : FCC CLASS-B 3m LF-ANT:35419(6) VERTICAL Detector : Peak</p>



**Emission below 1GHz
5GHz WIFI 802.11ac VHT20 (LF)**

WIFI	5GHz 5725~5850MHz	
ANT	802.11ac VHT20 LF	
1+2	Horizontal	Vertical
QP / Peak	<p>Site : 03CH07-HY Condition : FCC CLASS-B 3m LF-ANT-35419(6) HORIZONTAL Detector : Peak Project : 650305</p>	<p>Site : 03CH07-HY Condition : FCC CLASS-B 3m LF-ANT-35419(6) VERTICAL Detector : Peak Project : 650305</p>



Emission below 1GHz
5GHz WIFI 802.11ac VHT40 (LF)

WIFI	5GHz 5725~5850MHz	
ANT	802.11ac VHT40 LF	
1+2	Horizontal	Vertical
QP / Peak	<p>Site : 03CH07-HY Condition : FCC CLASS-B 3m LF-ANT-35419(6) HORIZONTAL Detector : Peak Project : 650305</p>	<p>Site : 03CH07-HY Condition : FCC CLASS-B 3m LF-ANT-35419(6) VERTICAL Detector : Peak Project : 650305</p>



**Emission below 1GHz
5GHz WIFI 802.11ac VHT80 (LF)**

WIFI	5GHz 5725~5850MHz	
ANT	802.11ac VHT80 LF	
1+2	Horizontal	Vertical
QP / Peak	<p>Site : 03CH07-HY Condition : FCC CLASS-B 3m LF-ANT-35419(6) HORIZONTAL Detector : Peak Project : 650305</p>	<p>Site : 03CH07-HY Condition : FCC CLASS-B 3m LF-ANT-35419(6) VERTICAL Detector : Peak Project : 650305</p>



Band 4 - 5725~5850MHz
WIFI 802.11ac VHT20 (Band Edge @ 3m)

WIFI	Band 4 5725~5850MHz Band Edge @ 3m	
ANT	802.11ac VHT20 CH149 5745MHz	
1+2	Horizontal	Vertical
Peak	<p align="right">Date: 2016-05-26</p> <p align="center">FCC PART 15E BAND 4</p> <p>Site : 03CH07HY Condition : FCC PART 15E BAND 4, N 3m HF ANT, 130829 HORIZONTAL RBW: 1000.000kHz VBW: 3000.000kHz SWT: Auto Detector : Peak Project : 650305</p>	<p align="right">Date: 2016-05-26</p> <p align="center">FCC PART 15E BAND 4</p> <p>Site : 03CH07HY Condition : FCC PART 15E BAND 4, N 3m HF ANT, 130829 VERTICAL RBW: 1000.000kHz VBW: 3000.000kHz SWT: Auto Detector : Peak Project : 650305</p>

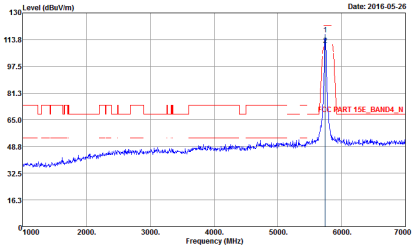
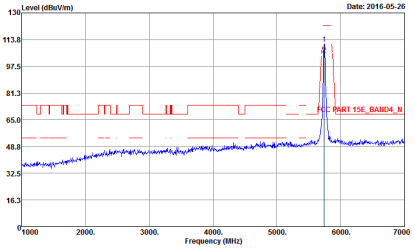

WIFI	Band 4 5725~5850MHz Fundamental @ 3m	
ANT	802.11ac VHT20 CH149 5745MHz	
1+2	Horizontal	Vertical
Peak Avg.	 <p>Date: 2016-05-26</p> <p>Site : 03CH07-HY Condition : FCC PART 15E, BAND4, N 3m HF-ANT, 130829 HORIZONTAL RBW: 1000.000kHz VBW: 3000.000kHz SWT: Auto Detector : Peak Project : 650305</p>	 <p>Date: 2016-05-26</p> <p>Site : 03CH07-HY Condition : FCC PART 15E, BAND4, N 3m HF-ANT, 130829 VERTICAL RBW: 1000.000kHz VBW: 3000.000kHz SWT: Auto Detector : Peak Project : 650305</p>



WIFI	Band 4 5725~5850MHz Band Edge @ 3m	
ANT	802.11ac VHT20 CH157 5785MHz - L	
1+2	Horizontal	Vertical
Peak	<p>Site : 03CH07HY Condition : FCC PART 15E_BAND4_N 3m HF-ANT_130829 HORIZONTAL Detector : Peak Project : 650305</p>	<p>Site : 03CH07HY Condition : FCC PART 15E_BAND4_N 3m HF-ANT_130829 VERTICAL Detector : Peak Project : 650305</p>

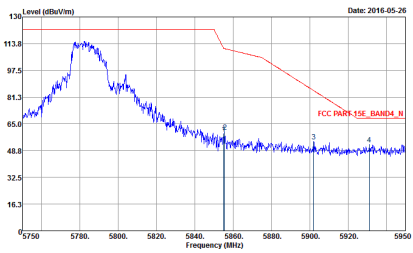
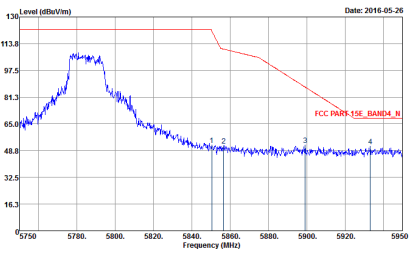

WIFI	Band 4 5725~5850MHz Band Edge @ 3m	
ANT	802.11ac VHT20 CH157 5785MHz - R	
1+2	Horizontal	Vertical
Peak	 <p>Site : 03CH07.HY Condition : FCC PART 15E, BAND4, N 3m HF-ANT, 130829 HORIZONTAL Detector : Peak Project : 650305</p>	 <p>Site : 03CH07.HY Condition : FCC PART 15E, BAND4, N 3m HF-ANT, 130829 VERTICAL Detector : Peak Project : 650305</p>



WIFI	Band 4 5725~5850MHz Fundamental @ 3m	
ANT	802.11ac VHT20 CH157 5785MHz	
1+2	Horizontal	Vertical
Peak Avg.	<p>Site : 03CH07-HY Condition : FCC PART 15E, BAND4, N 3m HF-ANT, 130829 HORIZONTAL Detector : Peak Project : 650305</p>	<p>Site : 03CH07-HY Condition : FCC PART 15E, BAND4, N 3m HF-ANT, 130829 VERTICAL Detector : Peak Project : 650305</p>



WIFI	Band 4 5725~5850MHz Band Edge @ 3m	
ANT	802.11ac VHT20 CH165 5825MHz	
1+2	Horizontal	Vertical
Peak	<p>Site : 03CH07-HY Condition : FCC PART 15E_BAND4_N 3m HF-ANT_130829 HORIZONTAL Detector : Peak Project : 650305</p>	<p>Site : 03CH07-HY Condition : FCC PART 15E_BAND4_N 3m HF-ANT_130829 VERTICAL Detector : Peak Project : 650305</p>



WIFI	Band 4 5725~5850MHz Fundamental @ 3m	
ANT	802.11ac VHT20 CH165 5825MHz	
1+2	Horizontal	Vertical
Peak Avg.	<p>Site : 03CH07HY Condition : FCC PART 15E BAND4_N 3m HF-ANT_130829 HORIZONTAL Detector : Peak Project : 650305</p>	<p>Site : 03CH07HY Condition : FCC PART 15E BAND4_N 3m HF-ANT_130829 VERTICAL Detector : Peak Project : 650305</p>



Band 4 5725~5850MHz
WIFI 802.11ac VHT40 (Band Edge @ 3m)

Table with 3 columns: WIFI, ANT, and 1+2. The 1+2 column contains two graphs: Horizontal and Vertical. Both graphs show Level (dBuV/m) vs Frequency (MHz) with a peak at approximately 5770 MHz. The word 'Peak' is written vertically on the left side of the table.

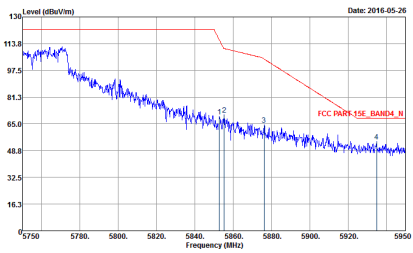
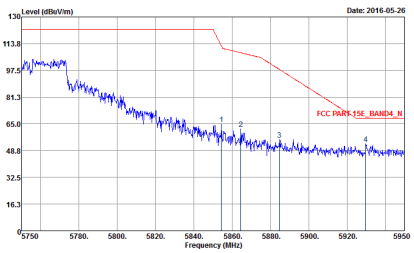

WIFI	Band 4 5725~5850MHz Band Edge @ 3m	
ANT	802.11ac VHT40 CH151 5755MHz- R	
1+2	Horizontal	Vertical
Peak	 <p style="font-size: small;">Date: 2016-05-26</p> <p style="font-size: x-small;">Site : 03CH07.HY Condition : FCC PART 15E BAND4_N 3m HF-ANT_130829 HORIZONTAL Detector : Peak Project : 650305</p>	 <p style="font-size: small;">Date: 2016-05-26</p> <p style="font-size: x-small;">Site : 03CH07.HY Condition : FCC PART 15E BAND4_N 3m HF-ANT_130829 VERTICAL Detector : Peak Project : 650305</p>

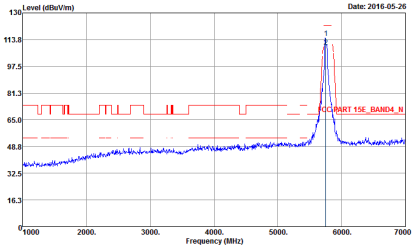
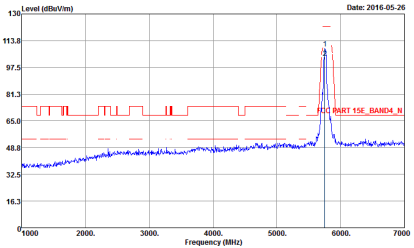

WIFI	Band 4 5725~5850MHz Fundamental @ 3m	
ANT	802.11ac VHT40 CH151 5755MHz	
1+2	Horizontal	Vertical
<p>Peak Avg.</p>	 <p>Date: 2016-05-26</p> <p>Site : 03CH07-HY Condition : FCC PART 15E, BAND4, N 3m HF-ANT, 130829 HORIZONTAL RBW: 1000.000kHz VBW: 3000.000kHz SWT: Auto Detector : Peak Project : 650305</p>	 <p>Date: 2016-05-26</p> <p>Site : 03CH07-HY Condition : FCC PART 15E, BAND4, N 3m HF-ANT, 130829 VERTICAL RBW: 1000.000kHz VBW: 3000.000kHz SWT: Auto Detector : Peak Project : 650305</p>



WIFI	Band 4 5725~5850MHz Band Edge @ 3m	
ANT	802.11ac VHT40 CH159 5795MHz- L	
1+2	Horizontal	Vertical
Peak	<p>Site : 03CH07HY Condition : FCC PART 15E BAND4_N 3m HF-ANT_130829 HORIZONTAL Detector : Peak Project : 650305</p>	<p>Site : 03CH07HY Condition : FCC PART 15E BAND4_N 3m HF-ANT_130829 VERTICAL Detector : Peak Project : 650305</p>



WIFI	Band 4 5725~5850MHz Band Edge @ 3m	
ANT	802.11ac VHT40 CH159 5795MHz- R	
1+2	Horizontal	Vertical
Peak	<p style="font-size: small;">Date: 2016-05-26</p> <p style="font-size: x-small;">Site : 03CH07HY Condition : FCC PART 15E, BAND4, N 3m HF-ANT, 130829 HORIZONTAL RBW: 1000.000kHz VBW: 3000.000kHz SWT: Auto Detector : Peak Project : 650305</p>	<p style="font-size: small;">Date: 2016-05-26</p> <p style="font-size: x-small;">Site : 03CH07HY Condition : FCC PART 15E, BAND4, N 3m HF-ANT, 130829 VERTICAL RBW: 1000.000kHz VBW: 3000.000kHz SWT: Auto Detector : Peak Project : 650305</p>



WIFI	Band 4 5725~5850MHz Fundamental @ 3m	
ANT	802.11ac VHT40 CH159 5795MHz	
1+2	Horizontal	Vertical
<p>Peak Avg.</p>	<p>Date: 2016-05-26</p> <p>Site : 03CH07-HY Condition : FCC PART 15E, BAND4, N 3m HF-ANT, 130829 HORIZONTAL RBW: 1000.000kHz VBW: 3000.000kHz SWT: Auto Detector : Peak Project : 650305</p>	<p>Date: 2016-05-26</p> <p>Site : 03CH07-HY Condition : FCC PART 15E, BAND4, N 3m HF-ANT, 130829 VERTICAL RBW: 1000.000kHz VBW: 3000.000kHz SWT: Auto Detector : Peak Project : 650305</p>



Band 4 5725~5850MHz
WIFI 802.11ac VHT80 (Band Edge @ 3m)

Table with 3 columns: WIFI, ANT, and 1+2. The 1+2 column is split into Horizontal and Vertical. It contains two spectral plots showing Level (dBuV/m) vs Frequency (MHz) for FCC PART 15E_BAND4_N. Includes site and condition details for both plots.

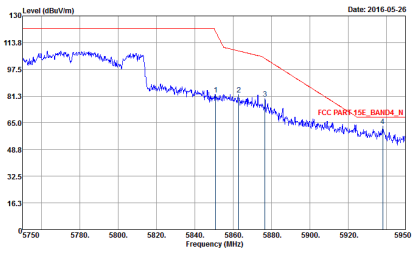
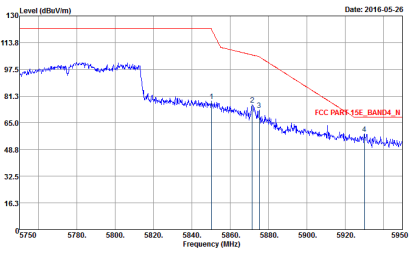

WIFI	Band 4 5725~5850MHz Band Edge @ 3m	
ANT	802.11ac VHT80 CH155 5775MHz - R	
1+2	Horizontal	Vertical
Peak	 <p>Site : 03CH07-HY Condition : FCC PART 15E_BAND4_N 3m HF-ANT_130829 HORIZONTAL Detector : RBW:1000.000kHz VBW:3000.000kHz SWT:Auto Project : 650305</p>	 <p>Site : 03CH07-HY Condition : FCC PART 15E_BAND4_N 3m HF-ANT_130829 VERTICAL Detector : RBW:1000.000kHz VBW:3000.000kHz SWT:Auto Project : 650305</p>



WIFI	Band 4 5725~5850MHz Fundamental @ 3m	
ANT	802.11ac VHT80 CH155 5775MHz	
1+2	Horizontal	Vertical
Peak Avg.	<p>Site : 03CH07-HY Condition : FCC PART 15E, BAND4, N 3m HF-ANT, 130829 HORIZONTAL RBW: 1000.000kHz VBW: 3000.000kHz SWT: Auto Detector : Peak Project : 650305</p>	<p>Site : 03CH07-HY Condition : FCC PART 15E, BAND4, N 3m HF-ANT, 130829 VERTICAL RBW: 1000.000kHz VBW: 3000.000kHz SWT: Auto Detector : Peak Project : 650305</p>

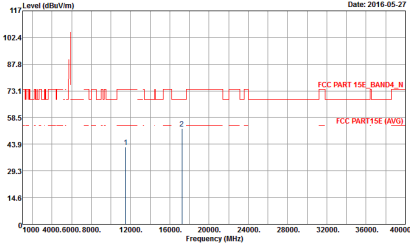
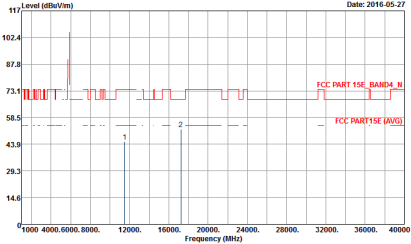

Band 4 - 5725~5850MHz
WIFI 802.11ac VHT20 (Harmonic @ 3m)

WIFI	Band 4 5725~5850MHz Harmonic @ 3m	
ANT	802.11ac VHT20 CH149 5745MHz	
1+2	Horizontal	Vertical
<p>Peak Avg.</p>	 <p>Site : 03CH07-HY Condition : FCC PART 15E_BAND4_N 3m SHF-EHF_131029 HORIZONTAL Detector : Peak Project : 650305</p>	 <p>Site : 03CH07-HY Condition : FCC PART 15E_BAND4_N 3m SHF-EHF_131029 VERTICAL Detector : Peak Project : 650305</p>

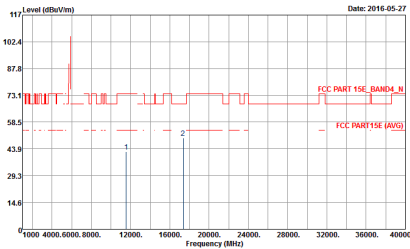
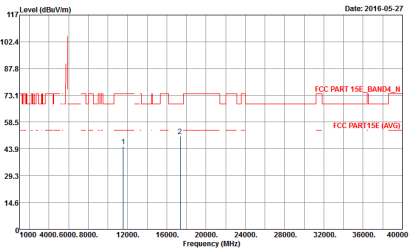

WIFI	Band 4 5725-5850MHz Harmonic @ 3m	
ANT	802.11ac VHT20 CH157 5785MHz	
1+2	Horizontal	Vertical
Peak Avg.	 <p style="font-size: small;">Date: 2016-05-27</p> <p style="font-size: x-small;">Site : 03CH07-HY Condition : FCC PART 15E_BAND4_N 3m SHF-EHF_131029 HORIZONTAL Detector : Peak Project : 650305</p>	 <p style="font-size: small;">Date: 2016-05-27</p> <p style="font-size: x-small;">Site : 03CH07-HY Condition : FCC PART 15E_BAND4_N 3m SHF-EHF_131029 VERTICAL Detector : Peak Project : 650305</p>



WIFI	Band 4 5725-5850MHz Harmonic @ 3m	
ANT	802.11ac VHT20 CH165 5825MHz	
1+2	Horizontal	Vertical
Peak Avg.	<p>Site : 03CH07-HY Condition : FCC PART 15E_BAND4_N 3m SHF-EHF_131029 HORIZONTAL Detector : Peak Project : 650305</p>	<p>Site : 03CH07-HY Condition : FCC PART 15E_BAND4_N 3m SHF-EHF_131029 VERTICAL Detector : Peak Project : 650305</p>



**Band 4 5725~5850MHz
WIFI 802.11ac VHT40 (Harmonic @ 3m)**

WIFI	Band 4 5725~5850MHz Harmonic @ 3m	
ANT	802.11ac VHT40 CH151 5755MHz	
1+2	Horizontal	Vertical
<p>Peak Avg.</p>	<p align="right">Date: 2016-05-27</p> <p>Site : 03CH07-HY Condition : FCC PART 15E_BAND4_N 3m SHF-EHF_131029 HORIZONTAL Detector : Peak Project : 650305</p>	<p align="right">Date: 2016-05-27</p> <p>Site : 03CH07-HY Condition : FCC PART 15E_BAND4_N 3m SHF-EHF_131029 VERTICAL Detector : Peak Project : 650305</p>



WIFI	Band 4 5725-5850MHz Harmonic @ 3m	
ANT	802.11ac VHT40 CH159 5795MHz	
1+2	Horizontal	Vertical
Peak Avg.	<p style="font-size: small;">Date: 2016-05-27</p> <p style="font-size: x-small;">Site : 03CH07.HY Condition : FCC PART 15E_BAND4_N 3m SHF-EHF_131029 HORIZONTAL Detector : Peak Project : 650305</p>	<p style="font-size: small;">Date: 2016-05-27</p> <p style="font-size: x-small;">Site : 03CH07.HY Condition : FCC PART 15E_BAND4_N 3m SHF-EHF_131029 VERTICAL Detector : Peak Project : 650305</p>



Band 4 5725~5850MHz
WIFI 802.11ac VHT80 (Harmonic @ 3m)

Table with 2 columns: Horizontal and Vertical. Each column contains a spectral plot showing Level (dBuV/m) vs Frequency (MHz) with FCC Part 15e limits and test parameters.



Emission below 1GHz
5GHz WIFI 802.11ac VHT20 (LF)

Table with 3 columns: WIFI (5GHz 5725~5850MHz), ANT (802.11ac VHT20 LF), and 1+2 (Horizontal/Vertical). It contains two graphs showing Level (dBuV/m) vs Frequency (MHz) for QP / Peak, with FCC CLASS B limits indicated.



**Emission below 1GHz
5GHz WIFI 802.11ac VHT40 (LF)**

WIFI	5GHz 5725~5850MHz	
ANT	802.11ac VHT40 LF	
1+2	Horizontal	Vertical
QP / Peak	<p>Site : 03CH07-HY Condition : FCC CLASS-B 3m LF-ANT-35419(6) HORIZONTAL Detector : Peak Project : 650305</p>	<p>Site : 03CH07-HY Condition : FCC CLASS-B 3m LF-ANT-35419(6) VERTICAL Detector : Peak Project : 650305</p>



**Emission below 1GHz
5GHz WIFI 802.11ac VHT80 (LF)**

WIFI	5GHz 5725~5850MHz	
ANT	802.11ac VHT80 LF	
1+2	Horizontal	Vertical
QP / Peak	<p align="right">Date: 2016-06-01</p> <p align="center">FCC CLASS B</p> <p>Site : 03CH07-HY Condition : FCC CLASS-B 3m LF-ANT-35419(6) HORIZONTAL Detector : Peak Project : 650305</p>	<p align="right">Date: 2016-06-01</p> <p align="center">FCC CLASS B</p> <p>Site : 03CH07-HY Condition : FCC CLASS-B 3m LF-ANT-35419(6) VERTICAL Detector : Peak Project : 650305</p>



Appendix D. Duty Cycle Plots

<Non-TXBF Modes>

Antenna	Band	Duty Cycle(%)	T(us)	1/T(kHz)	VBW Setting
2	802.11a	92.73	1428	0.700280112	1kHz
1+2	802.11a for Ant 1	93.58	1428	0.700280112	1kHz
1+2	802.11a for Ant 2	93.58	1428	0.700280112	1kHz
2	5GHz 802.11ac VHT20	93.14	1344	0.744047619	1kHz
1+2	5GHz 802.11ac VHT20 for Ant 1	92.23	1330	0.751879699	2kHz
1+2	5GHz 802.11ac VHT20 for Ant 2	93.2	1344	0.744047619	2kHz
2	5GHz 802.11ac VHT40	87.01	670	1.492537313	2kHz
1+2	5GHz 802.11ac VHT40 for Ant 1	87.01	670	1.492537313	3kHz
1+2	5GHz 802.11ac VHT40 for Ant 2	87.01	670	1.492537313	3kHz
2	5GHz 802.11ac VHT80	76.85	332	3.012048193	5kHz
1+2	5GHz 802.11ac VHT80 for Ant 1	75.93	328	3.048780488	10kHz
1+2	5GHz 802.11ac VHT80 for Ant 2	76.5	332	3.012048193	10kHz



SISO <Ant. 2>

802.11a

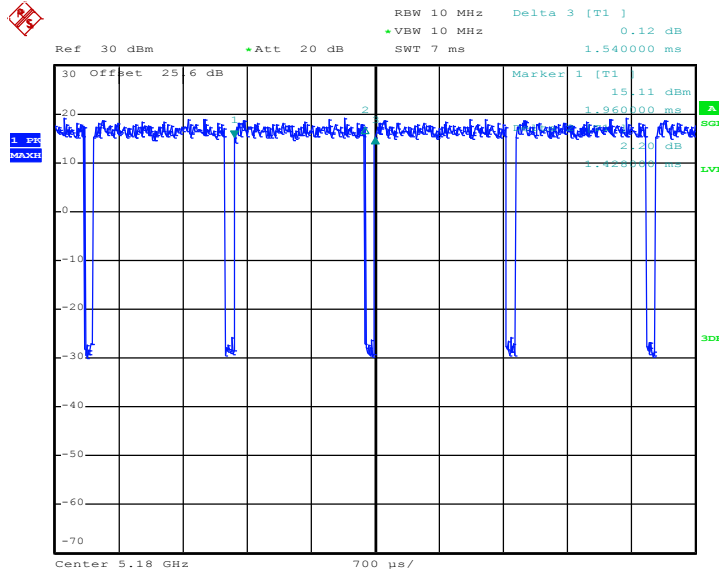

Date: 26.MAY.2016 01:08:11

802.11ac VHT20

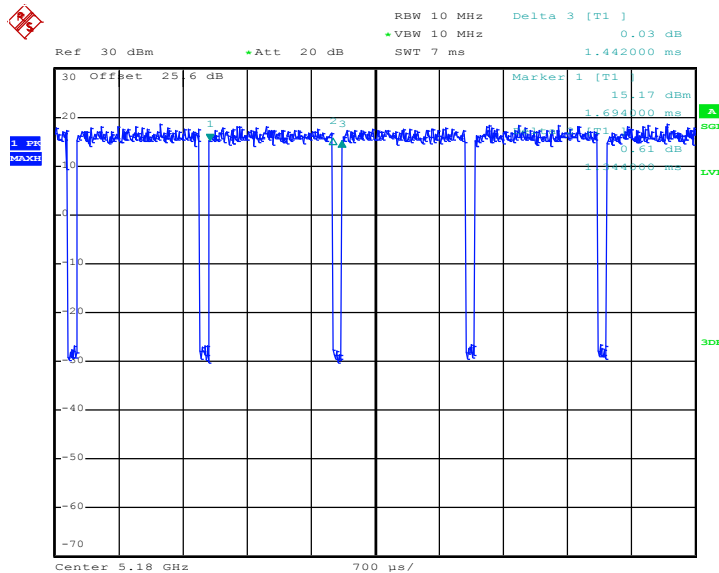

Date: 26.MAY.2016 01:24:16



802.11ac VHT40

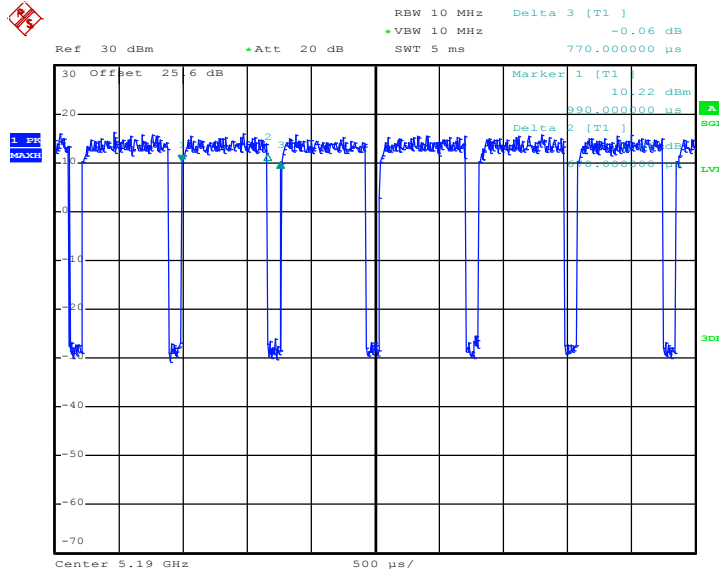

Date: 26.MAY.2016 01:29:25

802.11ac VHT80

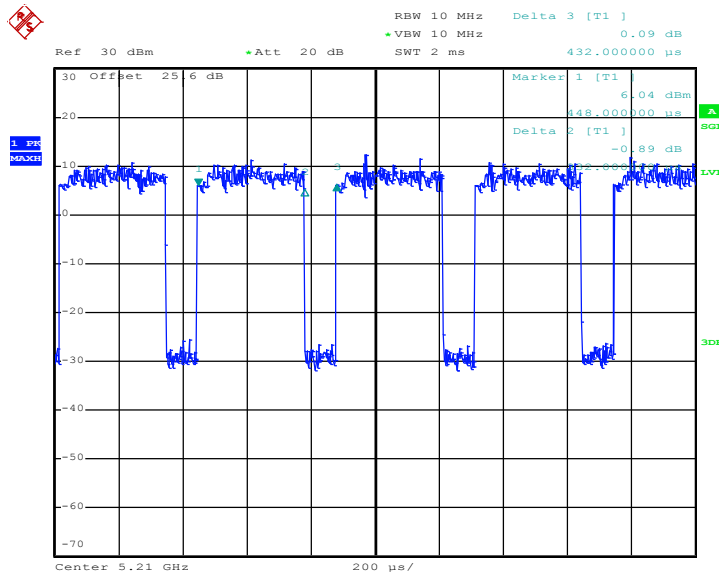

Date: 26.MAY.2016 01:35:20



MIMO <Ant. 1+2(1)>

802.11a

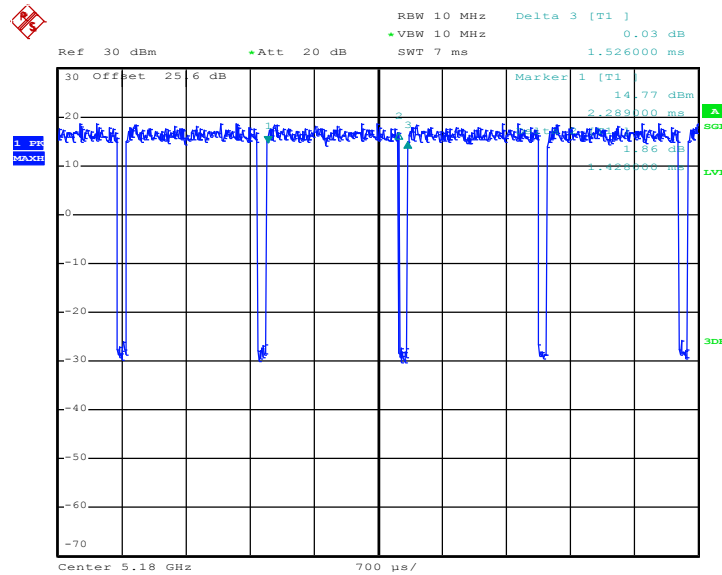

Date: 26.MAY.2016 01:09:11

802.11ac VHT20

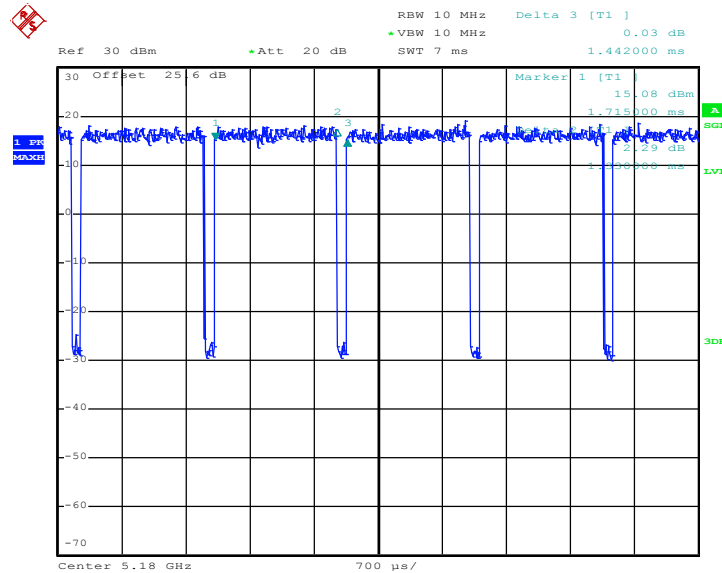

Date: 26.MAY.2016 01:25:12



802.11ac VHT40

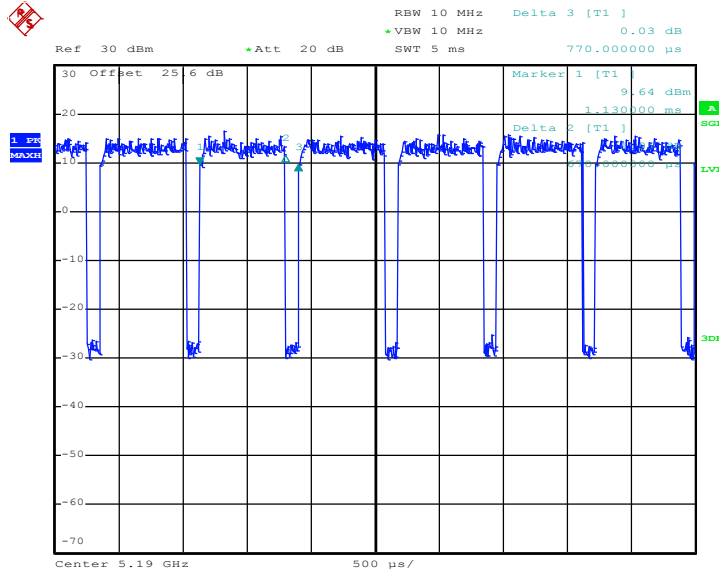

Date: 26.MAY.2016 01:33:09

802.11ac VHT80

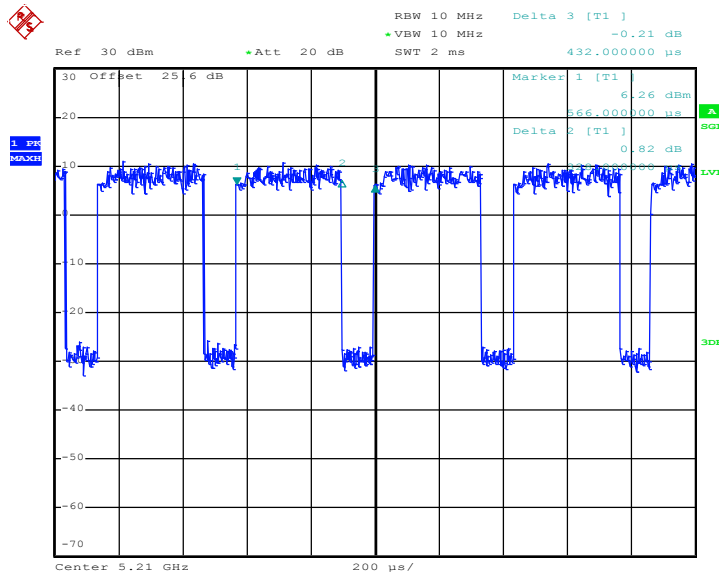

Date: 26.MAY.2016 01:38:19



MIMO <Ant. 1+2(2)>

802.11a

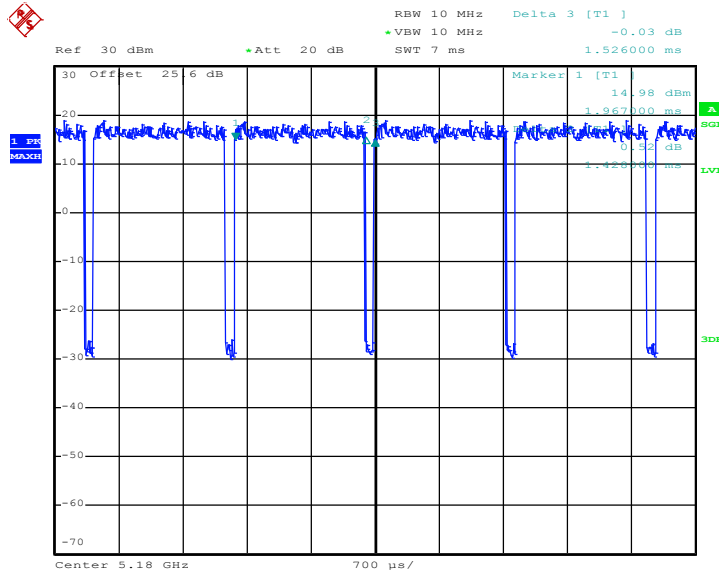

Date: 26.MAY.2016 01:09:55

802.11ac VHT20

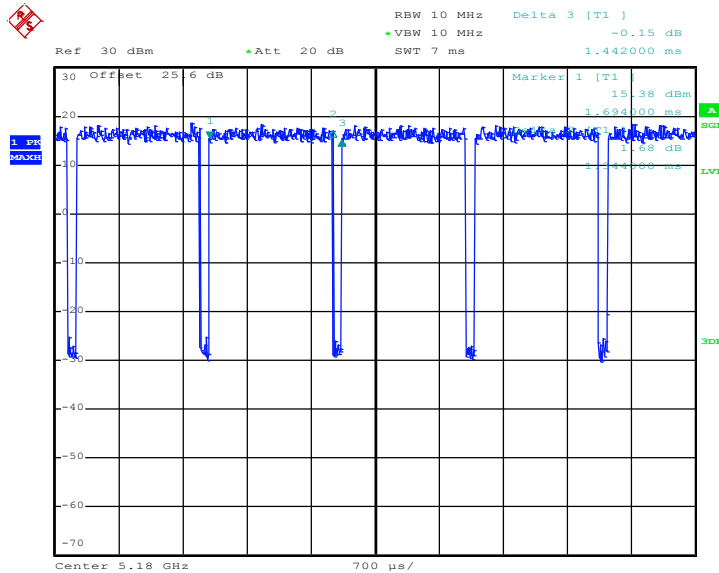

Date: 26.MAY.2016 01:26:01



802.11ac VHT40

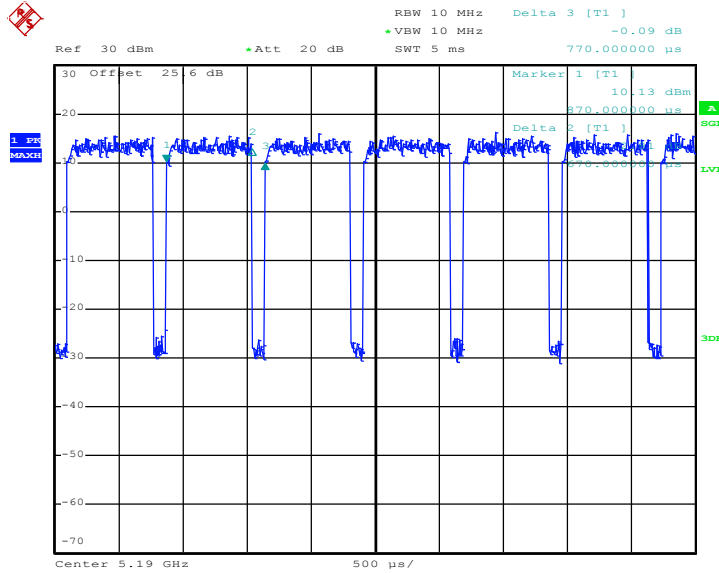

Date: 26.MAY.2016 01:32:13

802.11ac VHT80

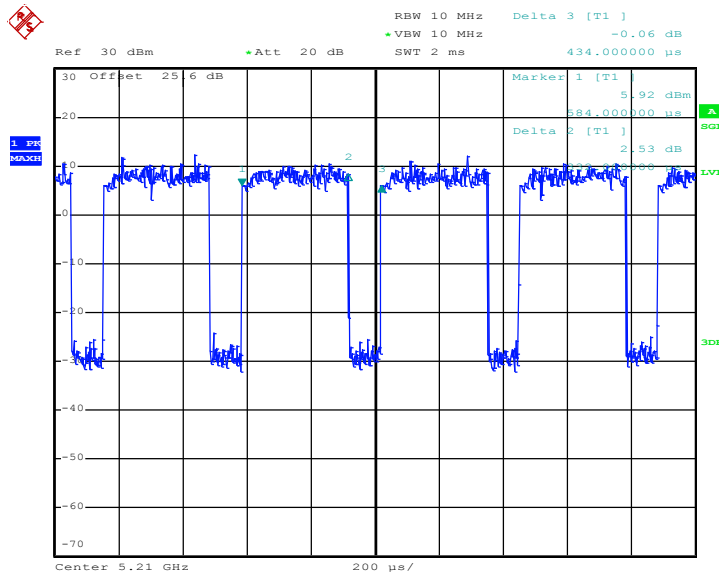

Date: 26.MAY.2016 01:37:24



<TXBF Modes>

Antenna	Band	Duty Cycle(%)	T(us)	1/T(kHz)	VBW Setting
1+2	5GHz 802.11ac VHT20	97.22	3830	0.261096606	300Hz
1+2	5GHz 802.11ac VHT40	90.77	4575	0.218579235	300Hz
1+2	5GHz 802.11ac VHT80	97.15	5073	0.197122019	300Hz

802.11ac VHT20

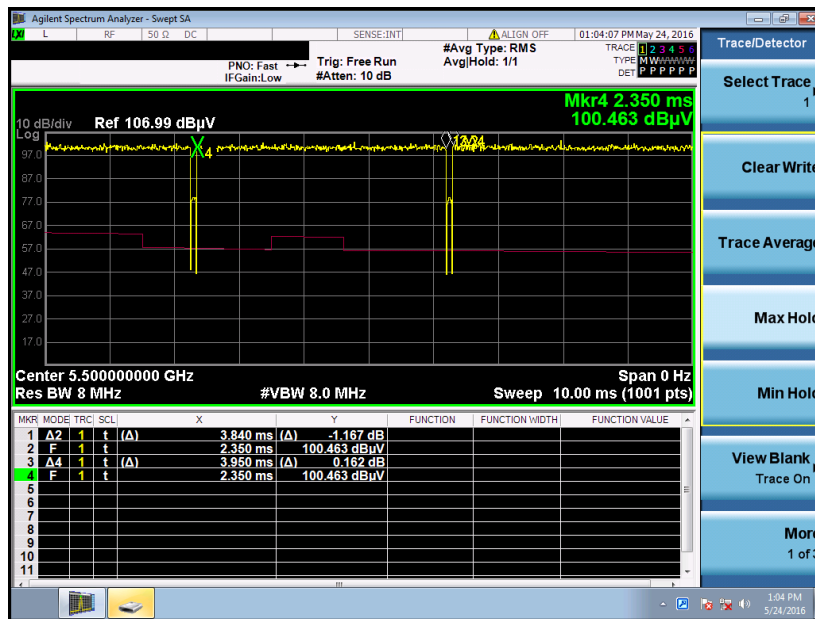



802.11ac VHT40

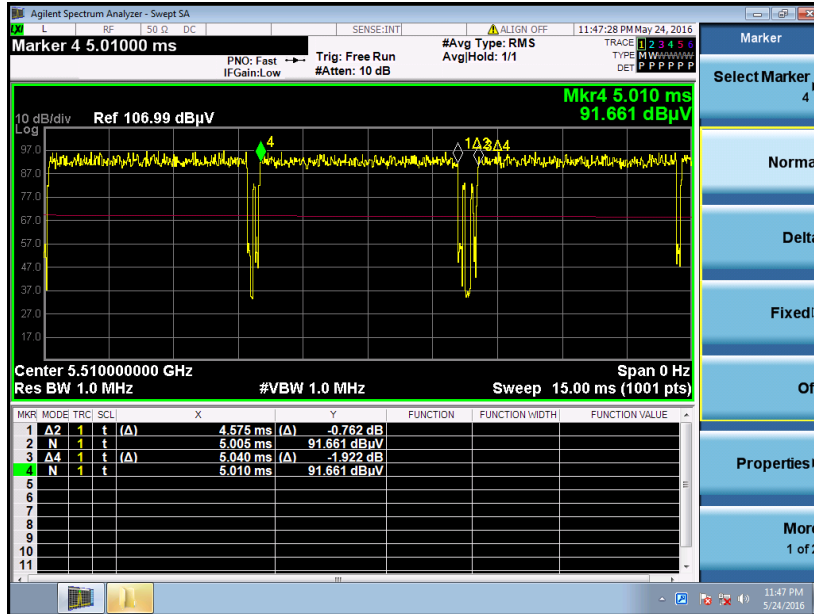

802.11ac VHT80

