



FCC RF Test Report

FCC ID : UZ7EM45A2
EQUIPMENT : Enterprise Mobile
BRAND NAME : Zebra
MODEL NAME : EM45A2
APPLICANT : Zebra Technologies Corporation
3 Overlook Point, Lincolnshire, IL 60069 USA
MANUFACTURER : Zebra Technologies Corporation
3 Overlook Point, Lincolnshire, IL 60069 USA
STANDARD : 47 CFR Part 2, 27 Subpart O (3700-3980MHz)
CLASSIFICATION : PCS Licensed Transmitter Held to Ear (PCE)
Test Date(s) : Jun. 19, 2024 ~ Jul. 06, 2024

We, Sporton International Inc. (KunShan), would like to declare that the tested sample has been evaluated in accordance with the procedures given in ANSI C63.26-2015 and shown compliance with the applicable technical standards.

This report contains data that were produced under subcontract by Sporton International Inc (Shenzhen).

The test results in this report apply exclusively to the tested model / sample. Without written approval of Sporton International Inc. (KunShan), the test report shall not be reproduced except in full.

Jason Jia

Approved by: Jason Jia



Sporton International Inc. (Kunshan)

**No. 1098, Pengxi North Road, Kunshan Economic Development Zone Jiangsu Province 215300
People's Republic of China**



TABLE OF CONTENTS

REVISION HISTORY...3
SUMMARY OF TEST RESULT...4
1 GENERAL DESCRIPTION...5
1.1 Product Feature of Equipment Under Test...5
1.2 Product Specification of Equipment Under Test...6
1.3 Modification of EUT...6
1.4 Maximum EIRP and Emission Designator...7
1.5 Testing Location...9
1.6 Test Software...9
1.7 Applicable Standards...9
2 TEST CONFIGURATION OF EQUIPMENT UNDER TEST...10
2.1 Test Mode...10
2.2 Connection Diagram of Test System...11
2.3 Support Unit used in test configuration and system...11
2.4 Measurement Results Explanation Example...11
2.5 Frequency List of Low/Middle/High Channels...12
3 CONDUCTED TEST ITEMS...13
3.1 Measuring Instruments...13
3.2 Test Setup...13
3.3 Test Result of Conducted Test...13
3.4 Conducted Output Power and EIRP...14
3.5 Peak-to-Average Ratio...15
3.6 Occupied Bandwidth...16
3.7 Conducted Band Edge...17
3.8 Conducted Spurious Emission...18
3.9 Frequency Stability...19
4 RADIATED TEST ITEMS...20
4.1 Measuring Instruments...20
4.2 Test Setup...20
4.3 Test Result of Radiated Test...21
4.4 Radiated Spurious Emission...22
5 LIST OF MEASURING EQUIPMENT...23
6 UNCERTAINTY OF EVALUATION...24
APPENDIX A. TEST RESULTS OF CONDUCTED TEST
APPENDIX B. TEST RESULTS OF RADIATED TEST
APPENDIX C. TEST SETUP PHOTOGRAPHS



REVISION HISTORY

REPORT NO.	VERSION	DESCRIPTION	ISSUED DATE
FG460505R	Rev. 01	Initial issue of report	Sep. 05, 2024



SUMMARY OF TEST RESULT

Report Section	FCC Rule	Description	Limit	Result	Remark
3.4	§2.1046	Conducted Output Power	Reporting Only	PASS	-
	§27.50(j)(3)	Equivalent Isotropic Radiated Power	EIRP < 1Watt		
3.5	§27.50(j)(4)	Peak-to-Average Ratio	<13 dB	PASS	-
3.6	§2.1049	Occupied Bandwidth	Reporting Only	PASS	-
3.7	§2.1051	Conducted Band Edge Measurement	< 43+10log ₁₀ (P[Watts])	PASS	-
	§27.53(l)(2)				
3.8	§2.1051	Conducted Spurious Emission	< 43+10log ₁₀ (P[Watts])	PASS	-
	§27.53(l)(2)				
3.9	§27.54	Frequency Stability Temperature & Voltage	Within Authorized Band	PASS	-
4.4	§2.1053 §27.53(l)(2)	Radiated Spurious Emission	< 43+10log ₁₀ (P[Watts])	PASS	Under limit 32.99 dB at 11378.00 MHz

Conformity Assessment Condition:

- The test results (PASS/FAIL) with all measurement uncertainty excluded are presented against the regulation limits or in accordance with the requirements stipulated by the applicant/manufacturer who shall bear all the risks of non-compliance that may potentially occur if measurement uncertainty is taken into account.
- The measurement uncertainty please refer to each test result in the section "Measurement Uncertainty"

Disclaimer:

The product specifications of the EUT presented in the test report that may affect the test assessments are declared by the manufacturer who shall take full responsibility for the authenticity.



1 General Description

1.1 Product Feature of Equipment Under Test

Product Feature	
Equipment	Enterprise Mobile
Brand Name	Zebra
Model Name	EM45A2
FCC ID	UZ7EM45A2
IMEI Code	Conducted: 352991990028965/352991990029377 Radiation: 352991990029096/352991990029708
HW Version	EV2.5
SW Version	13-32-08.00-TG-U06-STD-ATH-04
MFD	08AUG24
EUT Stage	Identical Prototype

Remark: The above EUT's information was declared by manufacturer. Please refer to the specifications or user's manual for more detailed description.

Specification of Accessory				
Battery	Brand Name	Zebra	Model	BT-000501
			Part Number	BT-000501-2000

Supported Unit used in test configuration and system				
AC Adapter 1 (Type C Wall Charger 1)	Brand Name	Zebra	Model	SAWA-102-22520A
			Part Number	PWR-WUA5V45W1US
AC Adapter 2 (Type A Wall Charger 2)	Brand Name	Zebra	Model	SAWA-65-20005A
			Part Number	PWR-WUA5V12W0US
Earphone 1 (Wired headset USB-C)	Brand Name	Zebra	Part Number	HDST-USBC-PTT1-01
Earphone 2 (Rugged Bluetooth Headset)	Brand Name	Zebra	Part Number	HS3100-OTH
Earphone 3 (3.5mm PTT Headset)	Brand Name	Zebra	Part Number	HDST-35MM-PTT1-02
Earphone 4 (Rugged Headset)	Brand Name	Zebra	Part Number	HS2100-OTH
3.5mm to 3.5mm audio connector	Brand Name	Zebra	Part Number	CBL-HS2100-3MS1-01
Type C-Audio Cable (Type C to 3.5mm)	Brand Name	Zebra	Part Number	ADP-USBC-35MM1-01
USB Cable 1 (USB-C to C Cable)	Brand Name	Zebra	Part Number	CBL-EC5X-USBC3A-01
USB Cable 2 (USB-A to C Cable)	Brand Name	Zebra	Part Number	CBL-TC5X-USBC2A-01
EM45 Protective Case	Brand Name	Zebra	Part Number	SG-EM45EXO1-01



1.2 Product Specification of Equipment Under Test

Standards-related Product Specification	
Tx/Rx Frequency	5G NR n77: 3700 MHz ~ 3980 MHz 5G NR n78: 3700 MHz ~ 3800 MHz
SCS	30kHz
Bandwidth	20 / 30 / 40 / 50 / 60 / 70 / 80 / 90 / 100MHz
Antenna Gain	5G NR n77: <Ant. 2>: -4.00 dBi <Ant. 3>: -0.07 dBi <Ant. 4>: -0.05 dBi <Ant. 6>: 0.74 dBi 5G NR n78: <Ant. 2>: -4.00 dBi <Ant. 3>: -0.92 dBi <Ant. 4>: -0.25 dBi <Ant. 6>: 0.65 dBi
Type of Modulation	CP-OFDM: QPSK / 16QAM / 64QAM / 256QAM DFT-s-OFDM: PI/2 BPSK / QPSK / 16QAM / 64QAM / 256QAM

Remark:

1. The maximum EIRP is calculated from max output power and max antenna gain, only the EIRP is shown in the report, 5G NR n77/n78 for Antenna 4 and UL MIMO for Ant.(4+6).
2. The device supports n77/n78(1T4R) SRS resources on Ant.2/3/4/6, only the test data of worst Ant.4 is showed in the report according to the maximum power.
3. 5G NR n77 & n78 supports PC2.
4. 5G NR nn77/n78 UL MIMO mode only supports CP-OFDM Modulation, and the UL MIMO mode is completely uncorrelated, the directional gain is selected the maximum gain among the MIMO antennas.
5. For n77/n78 UL MIMO mode, the conducted BE/Spurious are tested at single antenna port and add 10*log(NANT) according to KDB 662911 D01.
6. 5G NR n77/n78 support SA and NSA mode. The whole testing has assessed NSA mode by referring to the higher conducted power for conducted test items.
7. All the supported EN-DC combinations are verified conducted power, only the EN-DC combination with highest power are shown in the report.
8. The EN-DC mode combination could be referred to the product spec
9. For NSA mode of RSE testing, we only choose the combination of the maximum power among all NSA combinations to test.

1.3 Modification of EUT

No modifications are made to the EUT during all test items.



1.4 Maximum EIRP and Emission Designator

ENDC_2A_n77A		PI/2 BPSK / QPSK		16QAM / 64QAM / 256QAM	
BW (MHz)	Frequency Range (MHz)	Maximum EIRP(W)	Emission Designator (99%OBW)	Maximum EIRP(W)	Emission Designator (99%OBW)
20	3710.01 ~ 3969.99	0.4121	18M2G7D	0.3420	18M3W7D
30	3715.02 ~ 3964.98	0.4036	27M8G7D	0.3436	27M9W7D
40	3720.00 ~ 3960.00	0.4083	37M9G7D	0.3565	37M9W7D
50	3725.01 ~ 3954.99	0.3936	47M6G7D	0.3289	47M5W7D
60	3730.02 ~ 3949.98	0.3819	57M8G7D	0.3112	57M8W7D
70	3735.00 ~ 3945.00	0.3698	67M5G7D	0.3126	67M5W7D
80	3740.01 ~ 3939.99	0.3631	77M4G7D	0.3041	77M4W7D
90	3745.02 ~ 3934.98	0.3656	87M3G7D	0.3105	87M7W7D
100	3750.00 ~ 3930.00	0.4150	97M4G7D	0.3048	97M7W7D

ENDC_2A_n78A		PI/2 BPSK / QPSK		16QAM / 64QAM / 256QAM	
BW (MHz)	Frequency Range (MHz)	Maximum EIRP(W)	Emission Designator (99%OBW)	Maximum EIRP(W)	Emission Designator (99%OBW)
20	3710.01 ~ 3789.99	0.3758	18M2G7D	0.3221	18M3W7D
30	3715.02 ~ 3784.98	0.3758	27M8G7D	0.3221	27M9W7D
40	3720.00 ~ 3780.00	0.3475	37M9G7D	0.2904	37M9W7D
50	3725.01 ~ 3774.99	0.3656	47M6G7D	0.3013	47M5W7D
60	3730.02 ~ 3769.98	0.3565	57M8G7D	0.2992	57M8W7D
70	3735.00 ~ 3765.00	0.3556	67M5G7D	0.2917	67M5W7D
80	3740.01 ~ 3759.99	0.3540	77M4G7D	0.2944	77M4W7D
90	3745.02 ~ 3754.98	0.3491	87M3G7D	0.2904	87M7W7D
100	3750.00 ~ 3750.00	0.3767	97M4G7D	0.2844	97M7W7D



5G NR n77 UL MIMO		QPSK		16QAM / 64QAM / 256QAM	
BW (MHz)	Frequency Range (MHz)	Maximum EIRP(W)	Emission Designator (99%OBW)	Maximum EIRP(W)	Emission Designator (99%OBW)
20	3710.01 ~ 3969.99	0.3475	18M2G7D	0.3155	18M2W7D
30	3715.02 ~ 3964.98	0.3459	27M9G7D	0.3076	27M8W7D
40	3720.00 ~ 3960.00	0.3475	37M8G7D	0.3133	37M8W7D
50	3725.01 ~ 3954.99	0.3357	47M5G7D	0.2904	47M5W7D
60	3730.02 ~ 3949.98	0.3266	58M0G7D	0.2825	58M0W7D
70	3735.00 ~ 3945.00	0.3221	67M5G7D	0.2851	67M6W7D
80	3740.01 ~ 3939.99	0.3105	77M4G7D	0.2735	77M6W7D
90	3745.02 ~ 3934.98	0.3069	87M5G7D	0.2624	87M8W7D
100	3750.00 ~ 3930.00	0.3499	97M6G7D	0.3155	97M5W7D

5G NR n78 UL MIMO		QPSK		16QAM / 64QAM / 256QAM	
BW (MHz)	Frequency Range (MHz)	Maximum EIRP(W)	Emission Designator (99%OBW)	Maximum EIRP(W)	Emission Designator (99%OBW)
20	3710.01 ~ 3789.99	0.3258	18M2G7D	0.2897	18M2W7D
30	3715.02 ~ 3784.98	0.3304	27M9G7D	0.2884	27M8W7D
40	3720.00 ~ 3780.00	0.3342	37M8G7D	0.2965	37M8W7D
50	3725.01 ~ 3774.99	0.3105	47M5G7D	0.2761	47M5W7D
60	3730.02 ~ 3769.98	0.3041	58M0G7D	0.2710	58M0W7D
70	3735.00 ~ 3765.00	0.3041	67M5G7D	0.2704	67M6W7D
80	3740.01 ~ 3759.99	0.2972	77M4G7D	0.2600	77M6W7D
90	3745.02 ~ 3754.98	0.2999	87M5G7D	0.2642	87M8W7D
100	3750.00 ~ 3750.00	0.3357	97M6G7D	0.2965	97M5W7D

Note:

1. All modulations have been tested, and only the worst test results of PSK & QAM are shown in the report.
2. 5G NR Band n77 overlaps the entire frequency range of Band n78, and n77 power > n78 power, therefore the conducted test results of n77 provided in this report cover n78.



1.5 Testing Location

Sporton International Inc. (Kunshan) is accredited to ISO/IEC 17025:2017 by American Association for Laboratory Accreditation with Certificate Number 5145.02.

Test Firm	Sporton International Inc. (Kunshan)		
Test Site Location	No. 1098, Pengxi North Road, Kunshan Economic Development Zone Jiangsu Province 215300 People's Republic of China TEL : +86-512-57900158		
Test Site No.	Sporton Site No.	FCC Designation No.	FCC Test Firm Registration No.
	03CH04-KS	CN1257	314309

Sporton International Inc. (ShenZhen) is accredited to ISO/IEC 17025:2017 by American Association for Laboratory Accreditation with Certificate Number 5145.01.

Test Firm	Sporton International Inc. (ShenZhen)		
Test Site Location	1/F, 2/F, Bldg 5, Shiling Industrial Zone, Xinwei Village, Xili, Nanshan, Shenzhen, 518055 People's Republic of China TEL: +86-755-86379589 FAX: +86-755-86379595		
Test Site No.	Sporton Site No.	FCC Designation No.	FCC Test Firm Registration No.
	TH01-SZ	CN1256	421272

Note: Test data subcontracted: Conducted test cases in section 3.3~3.9 of this report.

1.6 Test Software

Item	Site	Manufacturer	Name	Version
1.	03CH04-KS	AUDIX	E3	6.2009-8-24al

1.7 Applicable Standards

According to the specifications of the manufacturer, the EUT must comply with the requirements of the following standards:

- 47 CFR Part 2, 270
- ANSI C63.26-2015
- FCC KDB 971168 D01 Power Meas License Digital Systems v03r01
- FCC KDB 412172 D01 Determining ERP and EIRP v01r01

Remark: All test items were verified and recorded according to the standards and without any deviation during the test.



2 Test Configuration of Equipment Under Test

2.1 Test Mode

Antenna port conducted and radiated test items are performed according to KDB 971168 D01 Power Meas License Digital Systems v03r01 with maximum output power.

For radiated measurement, pre-scanned in three orthogonal panels, X, Y, Z. The worst cases (X plane) were recorded in this report.

The device is investigated from 30MHz to 10 times of fundamental signal for radiated spurious emission test under different RB size/offset and modulations in exploratory test. Subsequently, only the worst case emissions are reported.

Orthogonal Planes of EUT	X Plane	Y Plane	Z Plane
			

Test Items	5G NR	Bandwidth (MHz)												Modulation				RB #		Test Channel					
		10	15	20	25	30	40	50	60	70	80	90	100	PI/2 BPSK	QPSK	16 QAM	64 QAM	256 QAM	1	Full	L	M	H		
Max. Output Power	n77	-	-	v	-	v	v	v	v	v	v	v	v	v	v	v	v	v	v	v	v	v	v	v	
	n78	-	-	v	-	v	v	v	v	v	v	v	v	v	v	v	v	v	v	v	v	v	v	v	
Peak-to-Average Ratio	n77	-	-	v	-					-			v	v	v				v				v		
26dB and 99% Bandwidth	n77	-	-	v	-	v	v	v	v	v	v	v		v	v	v	v		v				v		
Conducted Band Edge	n77	-	-		-			v					v	v	v				v	v	v			v	
Conducted Spurious Emission	n77	-	-		-			v					v	v	v				v			v	v	v	
Frequency Stability	n77	-	-	v	-									v						v			v		
E.I.R.P	n77	-	-	v	-	v	v	v	v	v	v	v	v	v	v	v	v	v	v	v	v	v	v	v	
	n78	-	-	v	-	v	v	v	v	v	v	v	v	v	v	v	v	v	v	v	v	v	v	v	
Radiated Spurious Emission	n77	Worst Case																					v	v	v
	n78	Worst Case																						v	
Note	<ol style="list-style-type: none"> The mark "v" means that this configuration is chosen for testing The mark "-" means that this bandwidth is not supported. The device is investigated from 30MHz to 10 times of fundamental signal for radiated spurious emission test under different RB size/offset and modulations in exploratory test. Subsequently, only the worst case emissions are reported. Based on engineering evaluation, only the worst modulations test results are shown in the report. Frequency Stability: Normal Voltage: 3.85Vdc, Extreme Voltage: 3.50Vdc ~4.41Vdc. 																								

2.2 Connection Diagram of Test System

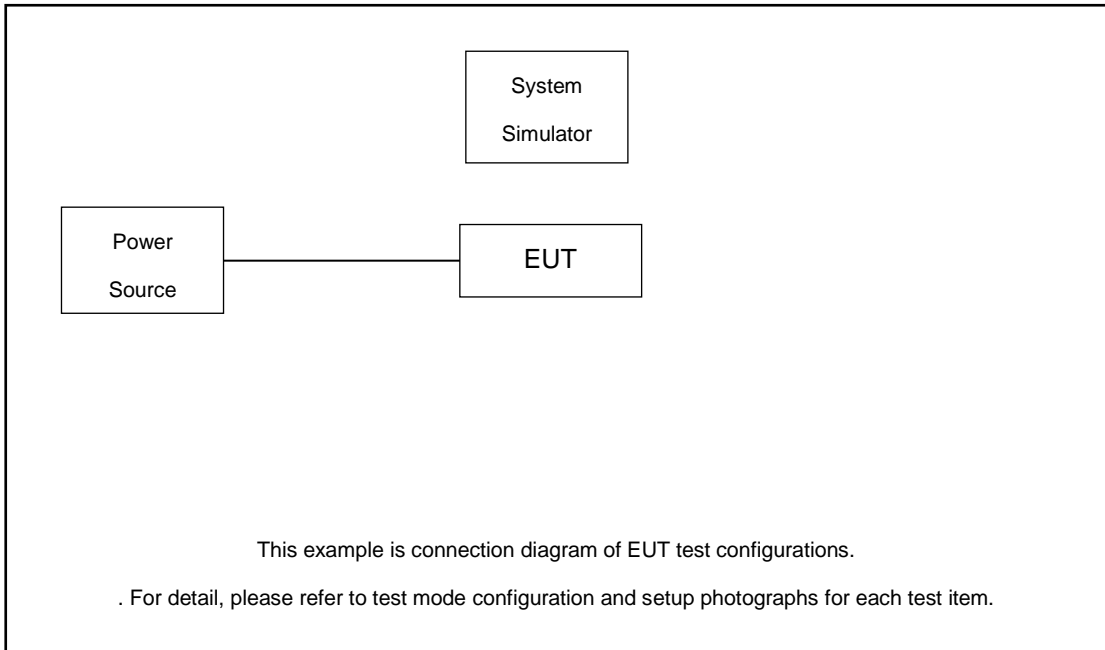

2.3 Support Unit used in test configuration and system

Item	Equipment	Trade Name	Model No.	FCC ID	Data Cable	Power Cord
1.	DC Power Supply	GW	GPS-3030D	N/A	N/A	Unshielded, 1.8 m
2.	LTE Base Station	Anritsu	MT8821C	N/A	N/A	Unshielded, 1.8 m
3.	NR Base Station	Anritsu	MT8000A	N/A	N/A	Unshielded, 1.8 m

2.4 Measurement Results Explanation Example

For all conducted test items:

The offset level is set in the spectrum analyzer to compensate the RF cable loss between EUT conducted output port and spectrum analyzer. With the offset compensation, the spectrum analyzer reading level is exactly the EUT RF output level.

The spectrum analyzer offset is derived from RF cable loss.

$$\text{Offset} = \text{RF cable loss.}$$

Following shows an offset computation example with cable loss 8.9 dB.

Example :

$$\begin{aligned} \text{Offset(dB)} &= \text{RF cable loss(dB)}. \\ &= 8.9 \text{ (dB)} \end{aligned}$$



2.5 Frequency List of Low/Middle/High Channels

5G n77 Channel and Frequency List				
BW [MHz]	Channel/Frequency(MHz)	Lowest	Middle	Highest
100	Channel	650000	656000	662000
	Frequency	3750	3840	3930
90	Channel	649668	656000	662332
	Frequency	3745.02	3840	3934.98
80	Channel	649334	656000	662666
	Frequency	3740.01	3840	3939.99
70	Channel	649000	656000	663000
	Frequency	3735	3840	3945
60	Channel	648668	656000	663332
	Frequency	3730.02	3840	3949.98
50	Channel	648334	656000	663666
	Frequency	3725.01	3840	3954.99
40	Channel	648000	656000	664000
	Frequency	3720	3840	3960
30	Channel	647668	656000	664332
	Frequency	3715.02	3840	3964.98
20	Channel	647334	656000	664666
	Frequency	3710.01	3840	3969.99

5G n78 Channel and Frequency List				
BW [MHz]	Channel/Frequency(MHz)	Lowest	Middle	Highest
100	Channel	650000		
	Frequency	3750		
90	Channel	649668	650000	650332
	Frequency	3745.02	3750	3754.98
80	Channel	649334	650000	650666
	Frequency	3740.01	3750	3759.99
70	Channel	649000	650000	651000
	Frequency	3735	3750	3765
60	Channel	648668	650000	651332
	Frequency	3730.02	3750	3769.98
50	Channel	648334	650000	651666
	Frequency	3725.01	3750	3774.99
40	Channel	648000	650000	652000
	Frequency	3720	3750	3780
30	Channel	647668	650000	652332
	Frequency	3715.02	3750	3784.98
20	Channel	647334	650000	652666
	Frequency	3710.01	3750	3789.99

3 Conducted Test Items

3.1 Measuring Instruments

See list of measuring instruments of this test report.

3.2 Test Setup

3.2.1 Conducted Output Power



3.2.2 Peak-to-Average Ratio, Occupied Bandwidth, Conducted Band-Edge and Conducted Spurious Emission



3.2.3 Frequency Stability

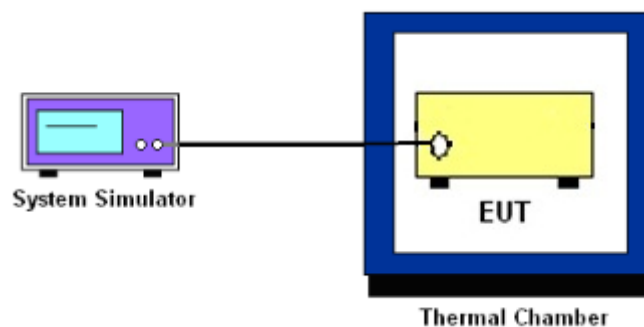

3.3 Test Result of Conducted Test

Please refer to Appendix A.



3.4 Conducted Output Power and EIRP

3.4.1 Description of the Conducted Output Power Measurement and EIRP Measurement

A system simulator was used to establish communication with the EUT. Its parameters were set to force the EUT transmitting at maximum output power. The measured power in the radio frequency on the transmitter output terminals shall be reported.

The EIRP of mobile transmitters must not exceed 1 Watts for 5G NR n77/n78.

According to KDB 412172 D01 Power Approach,

$EIRP = P_T + G_T - L_C$, $ERP = EIRP - 2.15$, where

P_T = transmitter output power in dBm

G_T = gain of the transmitting antenna in dBi

L_C = signal attenuation in the connecting cable between the transmitter and antenna in dB

3.4.2 Test Procedures

1. The testing follows ANSI C63.26 Section 5.2
2. The transmitter output port was connected to the system simulator.
3. Set EUT at maximum power through the system simulator.
4. Select lowest, middle, and highest channels for each band and different modulation.
5. Measure and record the power level from the system simulator.



3.5 Peak-to-Average Ratio

3.5.1 Description of the PAR Measurement

Power Complementary Cumulative Distribution Function (CCDF) curves provide a means for characterizing the power peaks of a digitally modulated signal on a statistical basis. A CCDF curve depicts the probability of the peak signal amplitude exceeding the average power level. Most contemporary measurement instrumentation include the capability to produce CCDF curves for an input signal provided that the instrument's resolution bandwidth can be set wide enough to accommodate the entire input signal bandwidth. In measuring transmissions in this band using an average power technique, the peak-to-average ratio (PAR) of the transmission may not exceed 13 dB.

3.5.2 Test Procedures

1. The testing follows ANSI C63.26 Section 5.2.3.4 (CCDF).
2. The EUT was connected to spectrum and system simulator via a power divider.
3. Set the CCDF (Complementary Cumulative Distribution Function) option in spectrum analyzer.
4. The highest RF powers were measured and recorded the maximum PAPR level associated with a probability of 0.1 %.
5. Record the deviation as Peak to Average Ratio.



3.6 Occupied Bandwidth

3.6.1 Description of Occupied Bandwidth Measurement

The occupied bandwidth is the width of a frequency band such that, below the lower and above the upper frequency limits, the mean powers emitted are each equal to a specified percentage 0.5% of the total mean transmitted power.

The 26 dB emission bandwidth is defined as the frequency range between two points, one above and one below the carrier frequency, at which the spectral density of the emission is attenuated 26 dB below the maximum in-band spectral density of the modulated signal. Spectral density (power per unit bandwidth) is to be measured with a detector of resolution bandwidth equal to approximately 1.0% of the emission bandwidth.

3.6.2 Test Procedures

1. The testing follows ANSI C63.26 Section 5.4
2. The EUT was connected to spectrum analyzer and system simulator via a power divider.
3. The spectrum analyzer center frequency is set to the nominal EUT channel center frequency. The span range for the spectrum analyzer shall be between two and five times the anticipated OBW.
4. The nominal resolution bandwidth (RBW) shall be in the range of 1 to 5 % of the anticipated OBW, and the VBW shall be at least 3 times the RBW.
5. Set the detection mode to peak, and the trace mode to max hold.
6. Determine the reference value: Set the EUT to transmit a modulated signal. Allow the trace to stabilize. Set the spectrum analyzer marker to the highest level of the displayed trace.
(this is the reference value)
7. Determine the “-26 dB down amplitude” as equal to (Reference Value – X).
8. Place two markers, one at the lowest and the other at the highest frequency of the envelope of the spectral display such that each marker is at or slightly below the “-X dB down amplitude” determined in step 6. If a marker is below this “-X dB down amplitude” value it shall be placed as close as possible to this value. The OBW is the positive frequency difference between the two markers.
9. Use the 99 % power bandwidth function of the spectrum analyzer and report the measured bandwidth.



3.7 Conducted Band Edge

3.7.1 Description of Conducted Band Edge Measurement

27.53(l)(2)

For mobile operations in the 3700-3980 MHz band, the conducted power of any emission outside the licensee's authorized bandwidth shall not exceed -13 dBm/MHz. Compliance with this paragraph is based on the use of measurement instrumentation employing a resolution bandwidth of 1 megahertz or greater. However, in the 1 megahertz bands immediately outside and adjacent to the licensee's frequency block, the minimum resolution bandwidth for the measurement shall be either one percent of the emission bandwidth of the fundamental emission of the transmitter or 350 kHz. In the bands between 1 and 5 MHz removed from the licensee's frequency block, the minimum resolution bandwidth for the measurement shall be 500 kHz.

3.7.2 Test Procedures

1. The testing follows ANSI C63.26 section 5.7
2. The EUT was connected to spectrum analyzer and system simulator via a power divider.
3. The band edges of low and high channels for the highest RF powers were measured.
4. Set RBW \geq 1% EBW in the 1MHz band immediately outside and adjacent to the band edge.
5. Beyond the 1 MHz band from the band edge, RBW=1MHz was used or a narrower RBW was used (generally limited to no less than 1% of the OBW) and the measured power was integrated over the full required measurement bandwidth.
6. Set spectrum analyzer with RMS detector.
7. The RF fundamental frequency should be excluded against the limit line in the operating frequency band.
8. Checked that all the results comply with the emission limit line.

Example:

$$\begin{aligned} & \text{The limit line is derived from } 43 + 10\log(P)\text{dB below the transmitter power } P(\text{Watts}) \\ & = P(\text{W}) - [43 + 10\log(P)] \text{ (dB)} \\ & = [30 + 10\log(P)] \text{ (dBm)} - [43 + 10\log(P)] \text{ (dB)} = -13\text{dBm}. \end{aligned}$$

9. When using the integration method, the starting frequency of the integration shall be centered at one-half of the RBW away from the band edge.



3.8 Conducted Spurious Emission

3.8.1 Description of Conducted Spurious Emission Measurement

The power of any emission outside of the authorized operating frequency ranges must be lower than the transmitter power (P) by a factor of at least $43 + 10 \log (P)$ dB.

It is measured by means of a calibrated spectrum analyzer and scanned from 30 MHz up to a frequency including its 10th harmonic.

3.8.2 Test Procedures

1. The testing follows ANSI C63.26 section 5.7
2. The EUT was connected to spectrum analyzer and system simulator via a power divider.
3. The RF output of EUT was connected to the spectrum analyzer by RF cable and attenuator. The path loss was compensated to the results for each measurement.
4. The middle channel for the highest RF power within the transmitting frequency was measured.
5. The conducted spurious emission for the whole frequency range was taken.
6. Make the measurement with the spectrum analyzer's RBW = 1MHz, VBW = 3MHz.
7. Set spectrum analyzer with RMS detector.
8. Taking the record of maximum spurious emission.
9. The RF fundamental frequency should be excluded against the limit line in the operating frequency band.
10. The limit line is derived from $43 + 10\log(P)$ dB below the transmitter power P(Watts)
= $P(W) - [43 + 10\log(P)]$ (dB)
= $[30 + 10\log(P)]$ (dBm) - $[43 + 10\log(P)]$ (dB)
= -13dBm.



3.9 Frequency Stability

3.9.1 Description of Frequency Stability Measurement

The frequency stability shall be measured by variation of ambient temperature and variation of primary supply voltage to ensure that the fundamental emission stays within the authorized frequency block. The frequency stability of the transmitter shall be maintained within $\pm 0.00025\%$ ($\pm 2.5\text{ppm}$) of the center frequency.

3.9.2 Test Procedures for Temperature Variation

1. The testing follows ANSI C63.26 section 5.6.4
2. The EUT was set up in the thermal chamber and connected with the system simulator.
3. With power OFF, the temperature was decreased to -30°C and the EUT was stabilized before testing. Power was applied and the maximum change in frequency was recorded within one minute.
4. With power OFF, the temperature was raised in 10°C step up to 50°C . The EUT was stabilized at each step for at least half an hour. Power was applied and the maximum frequency change was recorded within one minute.

3.9.3 Test Procedures for Voltage Variation

1. The testing follows ANSI C63.26 section 5.6.5
2. The EUT was placed in a temperature chamber at $20\pm 5^{\circ}\text{C}$ and connected with the system simulator.
3. The power supply voltage to the EUT was varied from 85% to 115% of the nominal value for other than hand carried battery equipment.
4. For hand carried, battery powered equipment, reduce the primary ac or dc supply voltage to the battery operating end point, which shall be specified by the manufacturer.
5. The variation in frequency was measured for the worst case.

4 Radiated Test Items

4.1 Measuring Instruments

See list of measuring instruments of this test report.

4.2 Test Setup

4.2.1 For radiated test below 30MHz

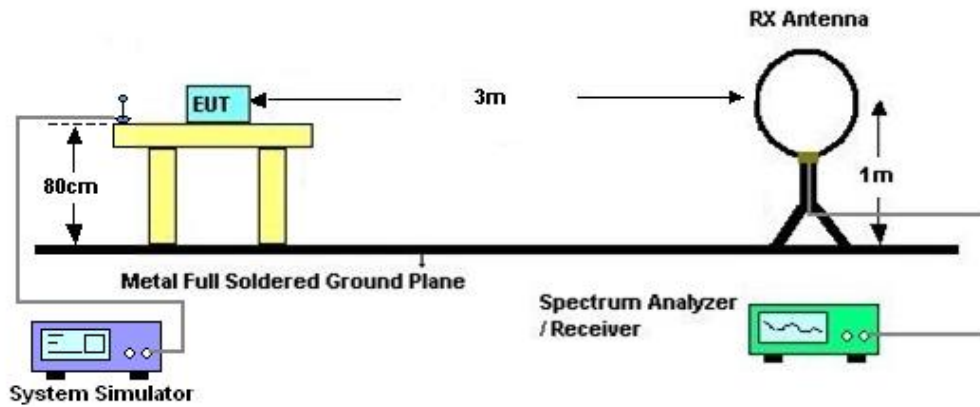

4.2.2 For radiated test from 30MHz to 1GHz

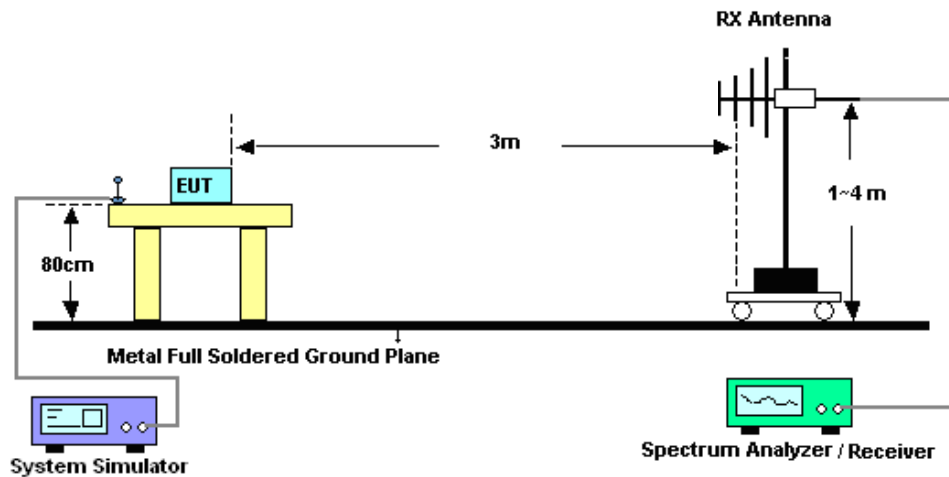

4.2.3 For radiated test above 1GHz

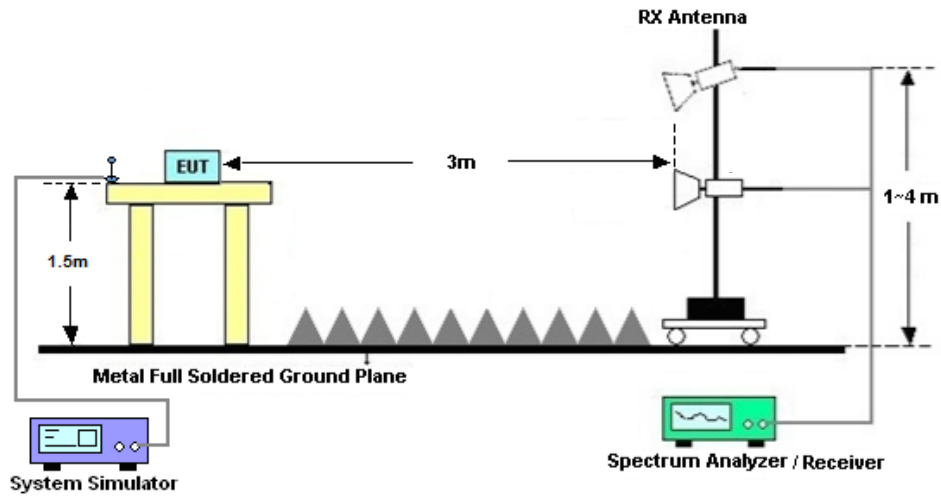

4.3 Test Result of Radiated Test

The low frequency, which started from 9 kHz to 30MHz, was pre-scanned and the result which was 20dB lower than the limit line was not reported.

Please refer to Appendix B.



4.4 Radiated Spurious Emission

4.4.1 Description of Radiated Spurious Emission

The radiated spurious emission was measured by substitution method according to ANSI C63.26. The power of any emission outside of the authorized operating frequency ranges must be attenuated below the transmitter power (P) by a factor of at least $43 + 10 \log (P)$ dB.

The spectrum is scanned from 30 MHz up to a frequency including its 10th harmonic.

4.4.2 Test Procedures

1. The testing follows ANSI C63.26 Section 5.5
2. The EUT was placed on a turntable with 0.8 meter height for frequency below 1GHz and 1.5 meter height for frequency above 1GHz respectively above ground.
3. The EUT was set 3 meters from the receiving antenna mounted on the antenna tower.
4. The table was rotated 360 degrees to determine the position of the highest spurious emission.
5. The height of the receiving antenna is varied between 1m to 4m to search the maximum spurious emission for both horizontal and vertical polarizations.
6. During the measurement, the system simulator parameters were set to force the EUT transmitting at maximum output power.
7. Make the measurement with the spectrum analyzer's RBW = 1MHz, VBW = 3MHz, taking the record of maximum spurious emission.
8. A horn antenna was substituted in place of the EUT and was driven by a signal generator.
9. Tune the output power of signal generator to the same emission level with EUT maximum spurious emission.
10. $EIRP \text{ (dBm)} = S.G. \text{ Power} - Tx \text{ Cable Loss} + Tx \text{ Antenna Gain}$
11. $ERP \text{ (dBm)} = EIRP - 2.15$
12. The RF fundamental frequency should be excluded against the limit line in the operating frequency band.

The limit line is derived from $43 + 10\log(P)$ dB below the transmitter power P(Watts)
= $P(W) - [43 + 10\log(P)] \text{ (dB)}$
= $[30 + 10\log(P)] \text{ (dBm)} - [43 + 10\log(P)] \text{ (dB)}$
= -13dBm.



5 List of Measuring Equipment

Instrument	Manufacturer	Model No.	Serial No.	Characteristics	Calibration Date	Test Date	Due Date	Remark
Spectrum Analyzer	R&S	FSV40	101078	10Hz~40GHz	Apr. 09, 2024	Jun. 19, 2024~Jul. 06, 2024	Apr. 08, 2025	Conducted (TH01-SZ)
DC Power Supply	TTI	PL330P	290070	Max 32V , 3A	Oct. 16, 2023	Jun. 19, 2024~Jul. 06, 2024	Oct. 15, 2024	Conducted (TH01-SZ)
Power Divider	TOJOIN	PS-2SM-04265	60.06.020.0077	0.4GHz~26.5GHz	Dec. 25, 2023	Jun. 19, 2024~Jul. 06, 2024	Dec. 24, 2024	Conducted (TH01-SZ)
Thermal Chamber	Ten Billion Hongzhangroup	LP-150U	H2014081803	-40~+150°C	Jul. 04, 2024	Jun. 19, 2024~Jul. 06, 2024	Jul. 03, 2025	Conducted (TH01-SZ)
EXA Spectrum Analyzer	Keysight	N9010B	MY57471079	10Hz-44G,MAX 30dB	Oct. 11, 2023	Jul. 05, 2024	Oct. 10, 2024	Radiation (03CH04-KS)
Loop Antenna	R&S	HFH2-Z2E	101125	9kHz~30MHz	Sep. 11 2023	Jul. 05, 2024	Sep. 10, 2024	Radiation (03CH04-KS)
Bilog Antenna	TeseQ	CBL6111D	59913	30MHz-1GHz	Aug. 19, 2023	Jul. 05, 2024	Aug. 18, 2024	Radiation (03CH04-KS)
Double Ridge Horn Antenna	ETS-Lindgren	3117	75957	1GHz~18GHz	Oct. 23, 2023	Jul. 05, 2024	Oct. 22, 2024	Radiation (03CH04-KS)
SHF-EHF Horn	Com-power	AH-840	101070	18GHz~40GHz	Jan. 27, 2024	Jul. 05, 2024	Jan. 26, 2025	Radiation (03CH04-KS)
Amplifier	SONOMA	310N	413740	9KHz-1GHz	Jan. 03, 2024	Jul. 05, 2024	Jan. 02, 2025	Radiation (03CH04-KS)
Amplifier	EM	EM18G40G A	060728	18~40GHz	Jan. 02, 2024	Jul. 05, 2024	Jan. 01, 2025	Radiation (03CH04-KS)
high gain Amplifier	EM	EM01G18G A	060840	1Ghz-18Ghz	Oct. 11, 2023	Jul. 05, 2024	Oct. 10, 2024	Radiation (03CH04-KS)
Amplifier	EM	EM01G18G A	060892	1Ghz-18Ghz	Oct. 11, 2023	Jul. 05, 2024	Oct. 10, 2024	Radiation (03CH04-KS)
AC Power Source	Chroma	61601	F104090004	N/A	NCR	Jul. 05, 2024	NCR	Radiation (03CH04-KS)
Turn Table	ChamPro	EM 1000-T	060762-T	0~360 degree	NCR	Jul. 05, 2024	NCR	Radiation (03CH04-KS)
Antenna Mast	ChamPro	EM 1000-A	060762-A	1 m~4 m	NCR	Jul. 05, 2024	NCR	Radiation (03CH04-KS)

NCR: No Calibration Required.



6 Uncertainty of Evaluation

The measurement uncertainties shown below were calculated in accordance with the requirements of ANSI 63.26-2015. All the measurement uncertainty value were shown with a coverage K=2 to indicate 95% level of confidence. The measurement data show herein meets or exceeds the CISPR measurement uncertainty values specified in CISPR 16-4-2 and can be compared directly to specified limit to determine compliance.

Uncertainty of Conducted Measurement

Test Item	Uncertainty
Conducted Spurious Emission & Bandedge	±1.34 dB
Occupied Channel Bandwidth	±0.012 MHz
Conducted Power	±1.34 dB
Conducted Power Density	±1.32 dB
Peak to Average Ratio	±1.34 dB
Frequency Stability	±1.3 Hz

Uncertainty of Radiated Emission Measurement (30 MHz ~ 1000 MHz)

Measuring Uncertainty for a Level of Confidence of 95% (U = 2Uc(y))	2.83 dB
---	---------

Uncertainty of Radiated Emission Measurement (1 GHz ~ 18 GHz)

Measuring Uncertainty for a Level of Confidence of 95% (U = 2Uc(y))	2.83 dB
---	---------

Uncertainty of Radiated Emission Measurement (18 GHz ~ 40 GHz)

Measuring Uncertainty for a Level of Confidence of 95% (U = 2Uc(y))	2.82 dB
---	---------

----- THE END -----



Appendix A. Test Results of Conducted Test

Test Engineer :	Khan	Temperature :	22~23°C
		Relative Humidity :	40~42%



Software Version: 23.06.1602

FR1 N77 SISO (Ant4)

LTE Band: 2, LTE BW: 10M, LTE ARFCN: Mid

Transmitter Conducted Output Power And EIRP, (G_T - L_C)=-0.05dB

NR Band	SCS (kHz)	Bandwidth (MHz)	Arfcn	Freq (MHz)	Modulation	RB	Conducted Power(dBm)	EIRP (dBm)	EIRP (W)
77	30	20	647334	3710.01	DFT-s-OFDM QPSK	1@1	25.9	25.85	0.3846
77	30	20	647334	3710.01	DFT-s-OFDM 16 QAM	1@1	25.19	25.14	0.3266
77	30	20	656000	3840	DFT-s-OFDM QPSK	1@1	25.85	25.8	0.3802
77	30	20	656000	3840	DFT-s-OFDM 16 QAM	1@1	25.15	25.1	0.3236
77	30	20	664666	3969.99	DFT-s-OFDM QPSK	1@1	26.2	26.15	0.4121
77	30	20	664666	3969.99	DFT-s-OFDM 16 QAM	1@1	25.39	25.34	0.3420
77	30	30	647668	3715.02	DFT-s-OFDM QPSK	1@1	25.58	25.53	0.3573
77	30	30	647668	3715.02	DFT-s-OFDM 16 QAM	1@1	24.82	24.77	0.2999
77	30	30	656000	3840	DFT-s-OFDM QPSK	1@1	25.96	25.91	0.3899
77	30	30	656000	3840	DFT-s-OFDM 16 QAM	1@1	25.18	25.13	0.3258
77	30	30	664332	3964.98	DFT-s-OFDM QPSK	1@1	26.11	26.06	0.4036
77	30	30	664332	3964.98	DFT-s-OFDM 16 QAM	1@1	25.41	25.36	0.3436
77	30	40	648000	3720	DFT-s-OFDM QPSK	1@1	25.69	25.64	0.3664
77	30	40	648000	3720	DFT-s-OFDM 16 QAM	1@1	24.97	24.92	0.3105
77	30	40	656000	3840	DFT-s-OFDM QPSK	1@1	26.05	26	0.3981
77	30	40	656000	3840	DFT-s-OFDM 16 QAM	1@1	25.29	25.24	0.3342
77	30	40	664000	3960	DFT-s-OFDM QPSK	1@1	26.16	26.11	0.4083
77	30	40	664000	3960	DFT-s-OFDM 16 QAM	1@1	25.57	25.52	0.3565
77	30	50	648334	3725.01	DFT-s-OFDM QPSK	1@1	25.86	25.81	0.3811
77	30	50	648334	3725.01	DFT-s-OFDM 16 QAM	1@1	25.09	25.04	0.3192
77	30	50	656000	3840	DFT-s-OFDM QPSK	1@1	25.82	25.77	0.3776
77	30	50	656000	3840	DFT-s-OFDM 16 QAM	1@1	24.95	24.9	0.3090
77	30	50	663666	3954.99	DFT-s-OFDM QPSK	1@1	26	25.95	0.3936
77	30	50	663666	3954.99	DFT-s-OFDM 16 QAM	1@1	25.22	25.17	0.3289
77	30	60	648668	3730.02	DFT-s-OFDM QPSK	1@1	25.82	25.77	0.3776
77	30	60	648668	3730.02	DFT-s-OFDM 16 QAM	1@1	24.97	24.92	0.3105



77	30	60	656000	3840	DFT-s-OFDM QPSK	1@1	25.87	25.82	0.3819
77	30	60	656000	3840	DFT-s-OFDM 16 QAM	1@1	24.98	24.93	0.3112
77	30	60	663332	3949.98	DFT-s-OFDM QPSK	1@1	25.72	25.67	0.3690
77	30	60	663332	3949.98	DFT-s-OFDM 16 QAM	1@1	24.92	24.87	0.3069
77	30	70	649000	3735	DFT-s-OFDM QPSK	1@1	25.67	25.62	0.3648
77	30	70	649000	3735	DFT-s-OFDM 16 QAM	1@1	25	24.95	0.3126
77	30	70	656000	3840	DFT-s-OFDM QPSK	1@1	25.73	25.68	0.3698
77	30	70	656000	3840	DFT-s-OFDM 16 QAM	1@1	24.89	24.84	0.3048
77	30	70	663000	3945	DFT-s-OFDM QPSK	1@1	25.65	25.6	0.3631
77	30	70	663000	3945	DFT-s-OFDM 16 QAM	1@1	24.84	24.79	0.3013
77	30	80	649334	3740.01	DFT-s-OFDM QPSK	1@1	25.62	25.57	0.3606
77	30	80	649334	3740.01	DFT-s-OFDM 16 QAM	1@1	24.88	24.83	0.3041
77	30	80	656000	3840	DFT-s-OFDM QPSK	1@1	25.65	25.6	0.3631
77	30	80	656000	3840	DFT-s-OFDM 16 QAM	1@1	24.87	24.82	0.3034
77	30	80	662666	3939.99	DFT-s-OFDM QPSK	1@1	25.54	25.49	0.3540
77	30	80	662666	3939.99	DFT-s-OFDM 16 QAM	1@1	24.76	24.71	0.2958
77	30	90	649668	3745.02	DFT-s-OFDM QPSK	1@1	25.67	25.62	0.3648
77	30	90	649668	3745.02	DFT-s-OFDM 16 QAM	1@1	24.92	24.87	0.3069
77	30	90	656000	3840	DFT-s-OFDM QPSK	1@1	25.68	25.63	0.3656
77	30	90	656000	3840	DFT-s-OFDM 16 QAM	1@1	24.97	24.92	0.3105
77	30	90	662332	3934.98	DFT-s-OFDM QPSK	1@1	25.45	25.4	0.3467
77	30	90	662332	3934.98	DFT-s-OFDM 16 QAM	1@1	24.73	24.68	0.2938
77	30	100	650000	3750	DFT-s-OFDM PI/2 BPSK	135@67	25.7	25.65	0.3673
77	30	100	650000	3750	DFT-s-OFDM PI/2 BPSK	1@1	25.67	25.62	0.3648
77	30	100	650000	3750	DFT-s-OFDM PI/2 BPSK	1@271	25.76	25.71	0.3724
77	30	100	650000	3750	DFT-s-OFDM QPSK	135@67	25.75	25.7	0.3715
77	30	100	650000	3750	DFT-s-OFDM QPSK	1@1	25.66	25.61	0.3639
77	30	100	650000	3750	DFT-s-OFDM QPSK	1@271	25.58	25.53	0.3573
77	30	100	650000	3750	DFT-s-OFDM 16 QAM	135@67	24.78	24.73	0.2972
77	30	100	650000	3750	DFT-s-OFDM 16 QAM	1@1	24.86	24.81	0.3027
77	30	100	650000	3750	DFT-s-OFDM 16 QAM	1@271	24.8	24.75	0.2985
77	30	100	650000	3750	DFT-s-OFDM 64 QAM	135@67	23.37	23.32	0.2148
77	30	100	650000	3750	DFT-s-OFDM 64 QAM	1@1	23.23	23.18	0.2080



77	30	100	650000	3750	DFT-s-OFDM 64 QAM	1@271	23.17	23.12	0.2051
77	30	100	650000	3750	DFT-s-OFDM 256 QAM	135@67	21.22	21.17	0.1309
77	30	100	650000	3750	DFT-s-OFDM 256 QAM	1@1	20.95	20.9	0.1230
77	30	100	650000	3750	DFT-s-OFDM 256 QAM	1@271	21.04	20.99	0.1256
77	30	100	650000	3750	CP-OFDM QPSK	137@68	24.2	24.15	0.2600
77	30	100	650000	3750	CP-OFDM QPSK	1@1	24.21	24.16	0.2606
77	30	100	650000	3750	CP-OFDM QPSK	1@271	24.13	24.08	0.2559
77	30	100	656000	3840	DFT-s-OFDM PI/2 BPSK	135@67	25.49	25.44	0.3499
77	30	100	656000	3840	DFT-s-OFDM PI/2 BPSK	1@1	26.23	26.18	0.4150
77	30	100	656000	3840	DFT-s-OFDM PI/2 BPSK	1@271	25.24	25.19	0.3304
77	30	100	656000	3840	DFT-s-OFDM QPSK	135@67	25.46	25.41	0.3475
77	30	100	656000	3840	DFT-s-OFDM QPSK	1@1	25.68	25.63	0.3656
77	30	100	656000	3840	DFT-s-OFDM QPSK	1@271	25.25	25.2	0.3311
77	30	100	656000	3840	DFT-s-OFDM 16 QAM	135@67	24.52	24.47	0.2799
77	30	100	656000	3840	DFT-s-OFDM 16 QAM	1@1	24.89	24.84	0.3048
77	30	100	656000	3840	DFT-s-OFDM 16 QAM	1@271	24.55	24.5	0.2818
77	30	100	656000	3840	DFT-s-OFDM 64 QAM	135@67	23.14	23.09	0.2037
77	30	100	656000	3840	DFT-s-OFDM 64 QAM	1@1	23.39	23.34	0.2158
77	30	100	656000	3840	DFT-s-OFDM 64 QAM	1@271	22.93	22.88	0.1941
77	30	100	656000	3840	DFT-s-OFDM 256 QAM	135@67	21.01	20.96	0.1247
77	30	100	656000	3840	DFT-s-OFDM 256 QAM	1@1	21.05	21	0.1259
77	30	100	656000	3840	DFT-s-OFDM 256 QAM	1@271	20.57	20.52	0.1127
77	30	100	656000	3840	CP-OFDM QPSK	137@68	24.06	24.01	0.2518
77	30	100	656000	3840	CP-OFDM QPSK	1@1	24.22	24.17	0.2612
77	30	100	656000	3840	CP-OFDM QPSK	1@271	23.75	23.7	0.2344
77	30	100	662000	3930	DFT-s-OFDM PI/2 BPSK	135@67	25.79	25.74	0.3750
77	30	100	662000	3930	DFT-s-OFDM PI/2 BPSK	1@1	25.56	25.51	0.3556
77	30	100	662000	3930	DFT-s-OFDM PI/2 BPSK	1@271	25.68	25.63	0.3656
77	30	100	662000	3930	DFT-s-OFDM QPSK	135@67	25.62	25.57	0.3606
77	30	100	662000	3930	DFT-s-OFDM QPSK	1@1	25.55	25.5	0.3548
77	30	100	662000	3930	DFT-s-OFDM QPSK	1@271	25.62	25.57	0.3606
77	30	100	662000	3930	DFT-s-OFDM 16 QAM	135@67	24.7	24.65	0.2917
77	30	100	662000	3930	DFT-s-OFDM 16 QAM	1@1	24.84	24.79	0.3013



77	30	100	662000	3930	DFT-s-OFDM 16 QAM	1@271	24.8	24.75	0.2985
77	30	100	662000	3930	DFT-s-OFDM 64 QAM	135@67	23.15	23.1	0.2042
77	30	100	662000	3930	DFT-s-OFDM 64 QAM	1@1	23.2	23.15	0.2065
77	30	100	662000	3930	DFT-s-OFDM 64 QAM	1@271	23.13	23.08	0.2032
77	30	100	662000	3930	DFT-s-OFDM 256 QAM	135@67	21.27	21.22	0.1324
77	30	100	662000	3930	DFT-s-OFDM 256 QAM	1@1	20.91	20.86	0.1219
77	30	100	662000	3930	DFT-s-OFDM 256 QAM	1@271	21.06	21.01	0.1262
77	30	100	662000	3930	CP-OFDM QPSK	137@68	24.25	24.2	0.2630
77	30	100	662000	3930	CP-OFDM QPSK	1@1	24.13	24.08	0.2559
77	30	100	662000	3930	CP-OFDM QPSK	1@271	24.09	24.04	0.2535



Frequency Stability

NR Band	SCS (kHz)	Bandwidth (MHz)	Arfcn	Freq (MHz)	Modulation	RB	Deviation (ppm)	Verdict	Environment
77	30	20	656000	3840.0	DFT-s-OFDM QPSK	50@0	0.0034	PASS	NV
77	30	20	656000	3840.0	DFT-s-OFDM QPSK	50@0	0.0055	PASS	LV
77	30	20	656000	3840.0	DFT-s-OFDM QPSK	50@0	0.0026	PASS	HV
77	30	20	656000	3840.0	DFT-s-OFDM QPSK	50@0	0.0060	PASS	-30°C
77	30	20	656000	3840.0	DFT-s-OFDM QPSK	50@0	0.0042	PASS	-20°C
77	30	20	656000	3840.0	DFT-s-OFDM QPSK	50@0	0.0062	PASS	-10°C
77	30	20	656000	3840.0	DFT-s-OFDM QPSK	50@0	0.0069	PASS	0°C
77	30	20	656000	3840.0	DFT-s-OFDM QPSK	50@0	0.0035	PASS	10°C
77	30	20	656000	3840.0	DFT-s-OFDM QPSK	50@0	0.0034	PASS	20°C
77	30	20	656000	3840.0	DFT-s-OFDM QPSK	50@0	0.0069	PASS	30°C
77	30	20	656000	3840.0	DFT-s-OFDM QPSK	50@0	0.0049	PASS	40°C
77	30	20	656000	3840.0	DFT-s-OFDM QPSK	50@0	0.0039	PASS	50°C



Peak to Average Ratio

NR Band	SCS (kHz)	Bandwidth (MHz)	Arfcn	Freq (MHz)	Modulation	RB	Result (dB)	Limit (dB)	Verdict
77	30	20	656000	3840.0	DFT-s-OFDM PI/2 BPSK	50@0	4.6	13	PASS
77	30	20	656000	3840.0	DFT-s-OFDM QPSK	50@0	5.33	13	PASS

B2_N77(20M)_DFT-s-OFDM_PI_2-BPSK_Outer_Full_Mid_CH



B2_N77(20M)_DFT-s-OFDM_QPSK_Outer_Full_Mid_CH





Occupied Bandwidth

NR Band	SCS (kHz)	Bandwidth (MHz)	Arfcn	Freq (MHz)	Modulation	RB	OBW (MHz)	26dB BW (MHz)
77	30	20	656000	3840.0	CP-OFDM QPSK	51@0	18.201	19.35
77	30	20	656000	3840.0	CP-OFDM 16 QAM	51@0	18.263	19.05
77	30	20	656000	3840.0	CP-OFDM 64 QAM	51@0	18.243	19.26
77	30	20	656000	3840.0	CP-OFDM 256 QAM	51@0	18.219	18.95
77	30	30	656000	3840.0	CP-OFDM QPSK	78@0	27.843	29.12
77	30	30	656000	3840.0	CP-OFDM 16 QAM	78@0	27.873	29.08
77	30	30	656000	3840.0	CP-OFDM 64 QAM	78@0	27.829	29.28
77	30	30	656000	3840.0	CP-OFDM 256 QAM	78@0	27.796	28.96
77	30	40	656000	3840.0	CP-OFDM QPSK	106@0	37.863	39.17
77	30	40	656000	3840.0	CP-OFDM 16 QAM	106@0	37.908	39.08
77	30	40	656000	3840.0	CP-OFDM 64 QAM	106@0	37.859	39.51
77	30	40	656000	3840.0	CP-OFDM 256 QAM	106@0	37.707	39.21
77	30	50	656000	3840.0	CP-OFDM QPSK	133@0	47.578	49.17
77	30	50	656000	3840.0	CP-OFDM 16 QAM	133@0	47.54	49.09
77	30	50	656000	3840.0	CP-OFDM 64 QAM	133@0	47.537	49.18
77	30	50	656000	3840.0	CP-OFDM 256 QAM	133@0	47.436	49.07
77	30	60	656000	3840.0	CP-OFDM QPSK	162@0	57.754	59.7
77	30	60	656000	3840.0	CP-OFDM 16 QAM	162@0	57.764	59.71
77	30	60	656000	3840.0	CP-OFDM 64 QAM	162@0	57.835	59.79
77	30	60	656000	3840.0	CP-OFDM 256 QAM	162@0	57.838	59.65
77	30	70	656000	3840.0	CP-OFDM QPSK	189@0	67.496	69.66
77	30	70	656000	3840.0	CP-OFDM 16 QAM	189@0	67.461	69.91
77	30	70	656000	3840.0	CP-OFDM 64 QAM	189@0	67.491	69.66



77	30	70	656000	3840.0	CP-OFDM 256 QAM	189@0	67.331	69.73
77	30	80	656000	3840.0	CP-OFDM QPSK	217@0	77.413	80.07
77	30	80	656000	3840.0	CP-OFDM 16 QAM	217@0	77.356	79.86
77	30	80	656000	3840.0	CP-OFDM 64 QAM	217@0	77.449	79.96
77	30	80	656000	3840.0	CP-OFDM 256 QAM	217@0	77.317	79.89
77	30	90	656000	3840.0	CP-OFDM QPSK	245@0	87.328	90.3
77	30	90	656000	3840.0	CP-OFDM 16 QAM	245@0	87.467	90.27
77	30	90	656000	3840.0	CP-OFDM 64 QAM	245@0	87.568	90.21
77	30	90	656000	3840.0	CP-OFDM 256 QAM	245@0	87.742	90.22
77	30	100	656000	3840.0	CP-OFDM QPSK	273@0	97.44	100.4
77	30	100	656000	3840.0	CP-OFDM 16 QAM	273@0	97.595	100.4
77	30	100	656000	3840.0	CP-OFDM 64 QAM	273@0	97.491	100.5
77	30	100	656000	3840.0	CP-OFDM 256 QAM	273@0	97.745	100.4



B2_N77(20M)_CP-OFDM_QPSK_Outer_Full_Mid_CH

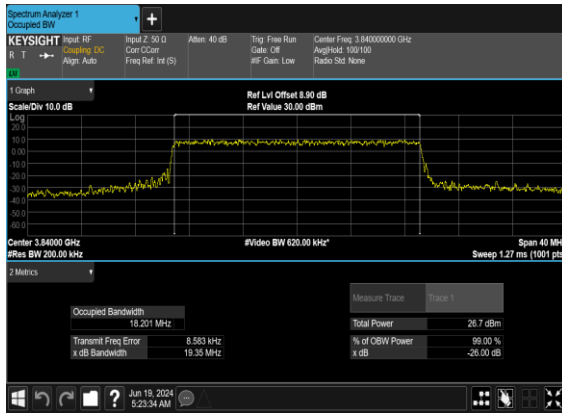

B2_N77(20M)_CP-OFDM_16QAM_Outer_Full_Mid_CH

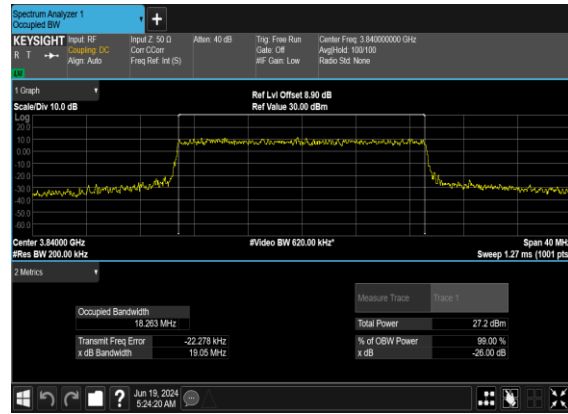

B2_N77(20M)_CP-OFDM_64QAM_Outer_Full_Mid_CH

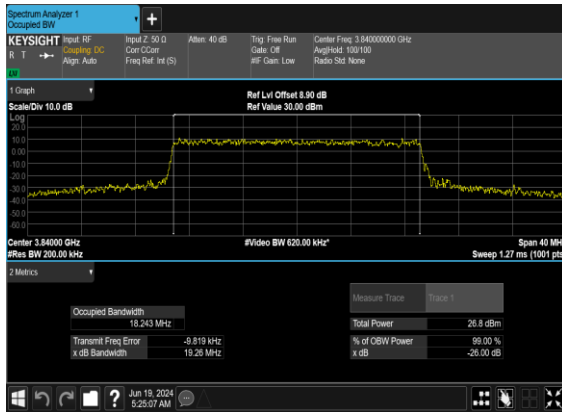

B2_N77(20M)_CP-OFDM_256QAM_Outer_Full_Mid_CH

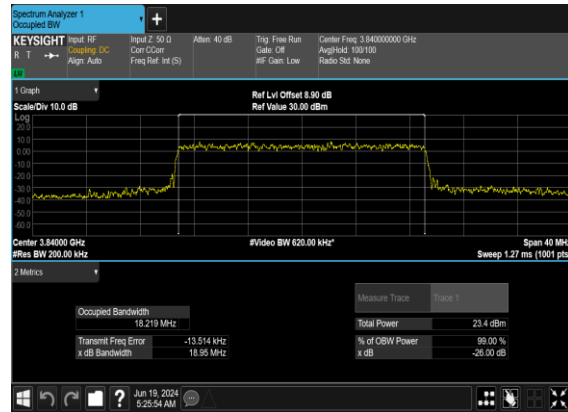



B2_N77(30M)_CP-OFDM_QPSK_Outer_Full_Mid_CH

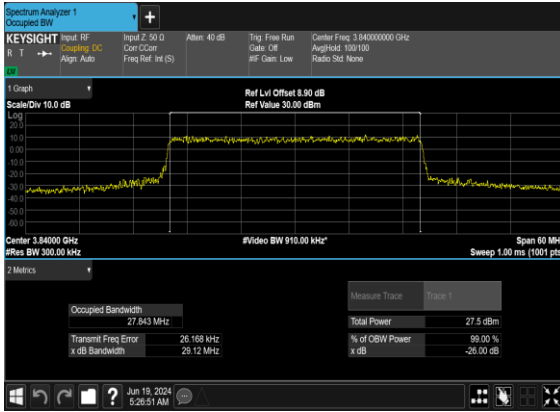

B2_N77(30M)_CP-OFDM_16QAM_Outer_Full_Mid_CH

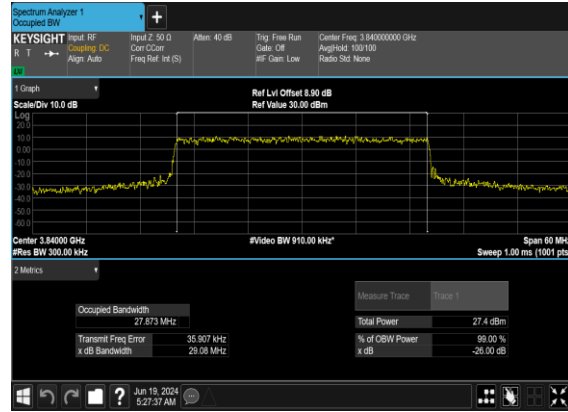

B2_N77(30M)_CP-OFDM_64QAM_Outer_Full_Mid_CH



B2_N77(30M)_CP-OFDM_256QAM_Outer_Full_Mid_CH

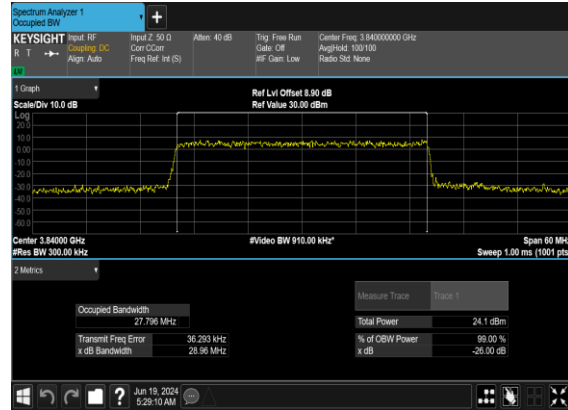



B2_N77(40M)_CP-OFDM_QPSK_Outer_Full_Mid_CH

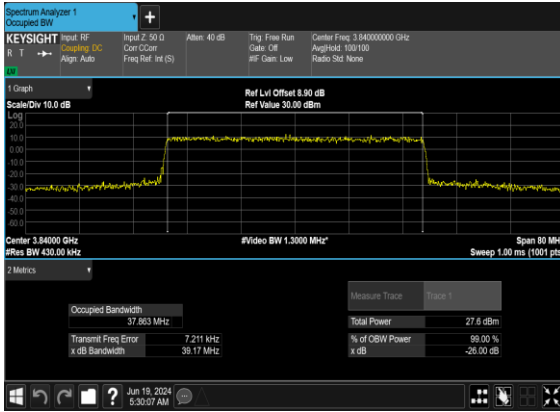

B2_N77(40M)_CP-OFDM_16QAM_Outer_Full_Mid_CH



B2_N77(40M)_CP-OFDM_64QAM_Outer_Full_Mid_CH

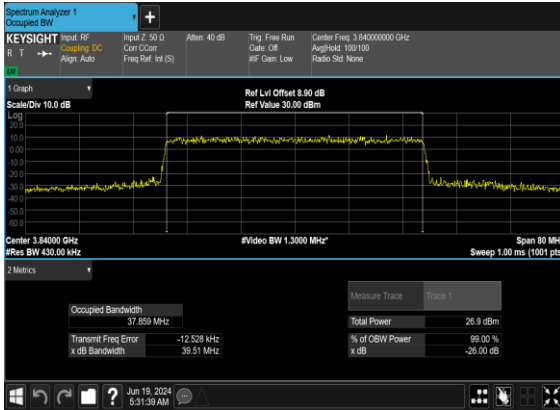

B2_N77(40M)_CP-OFDM_256QAM_Outer_Full_Mid_CH

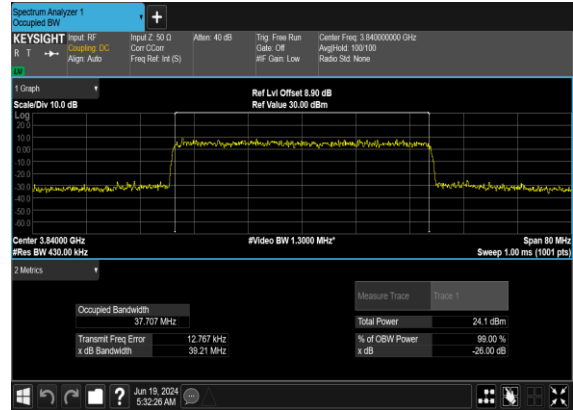



B2_N77(50M)_CP-OFDM_QPSK_Outer_Full_Mid_CH

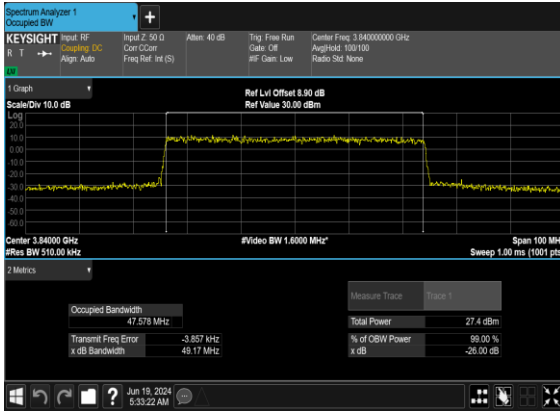

B2_N77(50M)_CP-OFDM_16_QAM_Outer_Full_Mid_CH



B2_N77(50M)_CP-OFDM_64_QAM_Outer_Full_Mid_CH

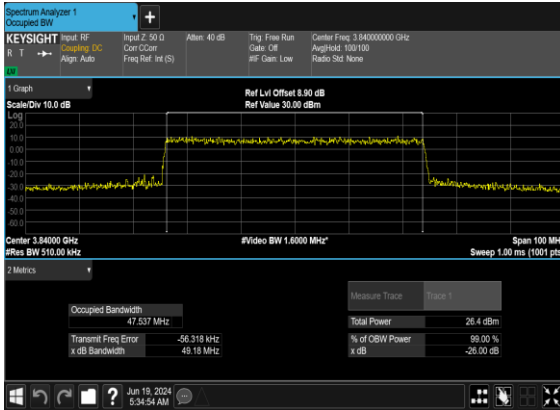

B2_N77(50M)_CP-OFDM_256_QAM_Outer_Full_Mid_CH

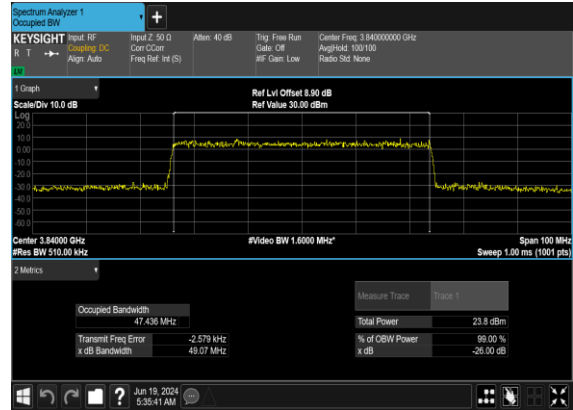



B2_N77(60M)_CP-OFDM_QPSK_Outer_Full_Mid_CH

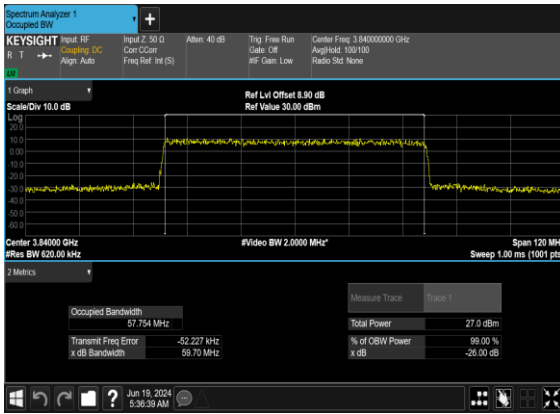

B2_N77(60M)_CP-OFDM_16QAM_Outer_Full_Mid_CH

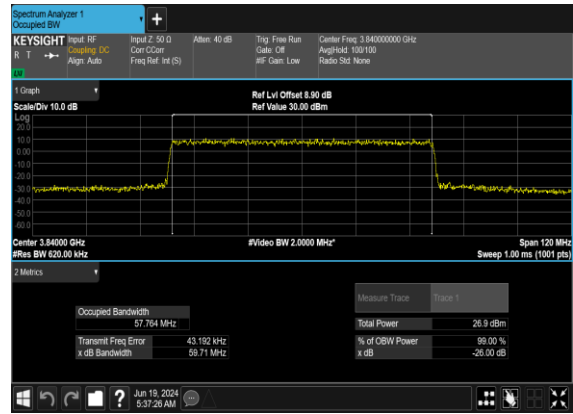

B2_N77(60M)_CP-OFDM_64QAM_Outer_Full_Mid_CH

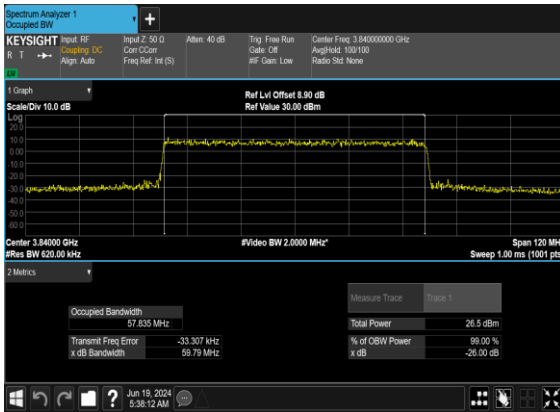

B2_N77(60M)_CP-OFDM_256QAM_Outer_Full_Mid_CH

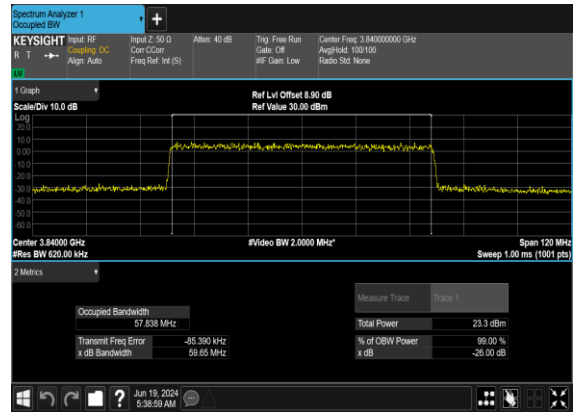



B2_N77(70M)_CP-OFDM_QPSK_Outer_Full_Mid_CH



B2_N77(70M)_CP-OFDM_16QAM_Outer_Full_Mid_CH



B2_N77(70M)_CP-OFDM_64QAM_Outer_Full_Mid_CH



B2_N77(70M)_CP-OFDM_256QAM_Outer_Full_Mid_CH

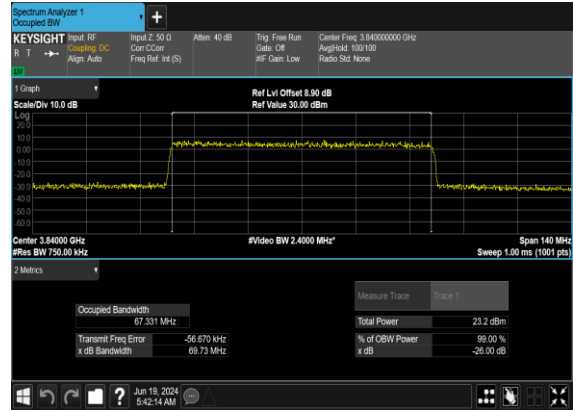



B2_N77(80M)_CP-OFDM_QPSK_Outer_Full_Mid_CH

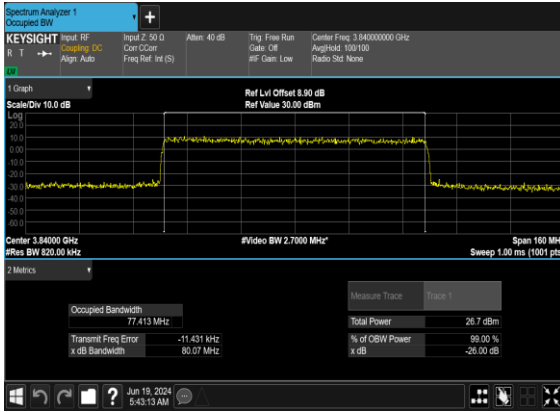

B2_N77(80M)_CP-OFDM_16QAM_Outer_Full_Mid_CH



B2_N77(80M)_CP-OFDM_64QAM_Outer_Full_Mid_CH



B2_N77(80M)_CP-OFDM_256QAM_Outer_Full_Mid_CH

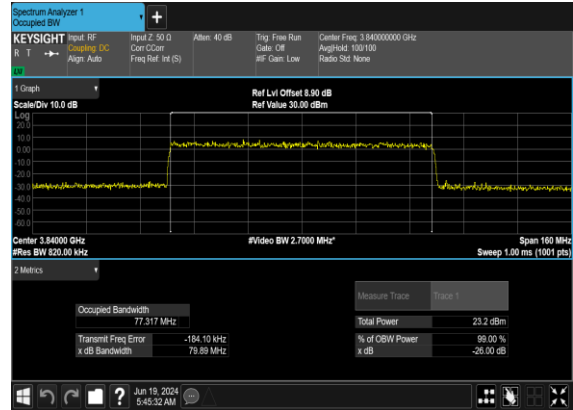



B2_N77(90M)_CP-OFDM_QPSK_Outer_Full_Mid_CH

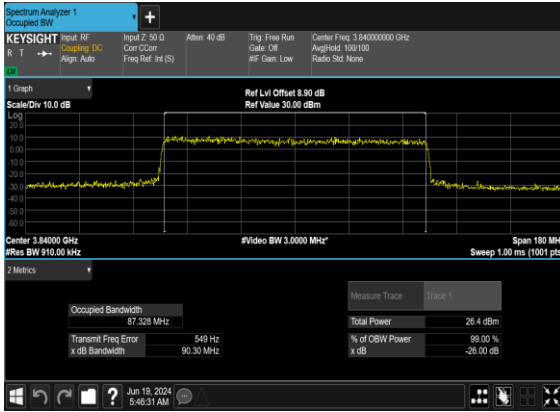

B2_N77(90M)_CP-OFDM_16_QAM_Outer_Full_Mid_CH



B2_N77(90M)_CP-OFDM_64_QAM_Outer_Full_Mid_CH

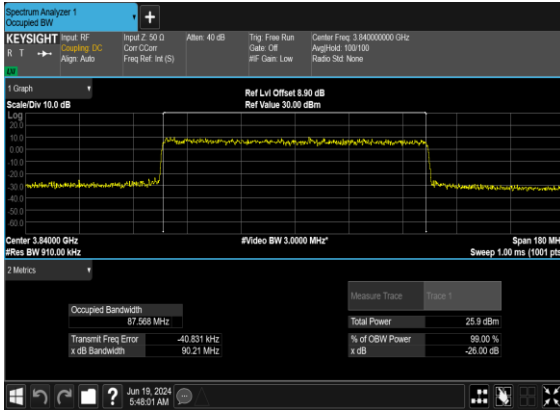

B2_N77(90M)_CP-OFDM_256_QAM_Outer_Full_Mid_CH

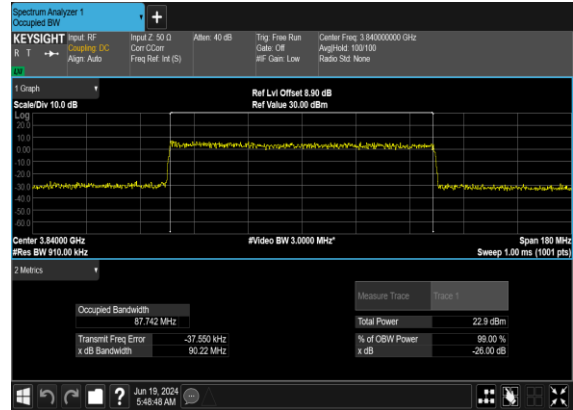



B2_N77(100M)_CP-OFDM_QPSK_Outer_Full_Mid_CH

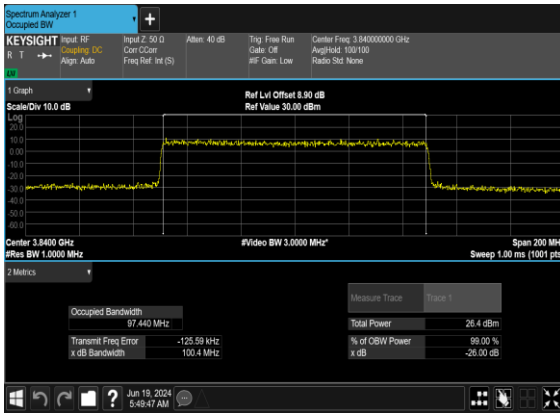

B2_N77(100M)_CP-OFDM_16_QAM_Outer_Full_Mid_CH

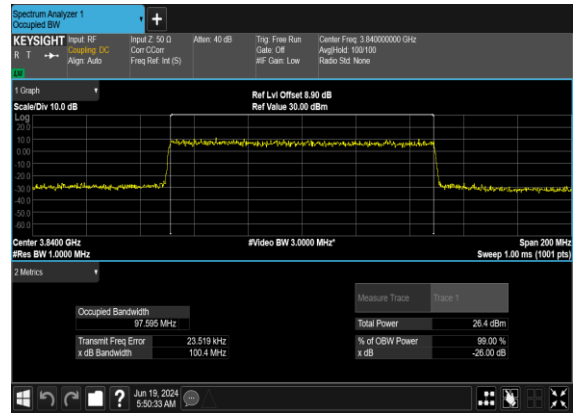

B2_N77(100M)_CP-OFDM_64_QAM_Outer_Full_Mid_CH



B2_N77(100M)_CP-OFDM_256_QAM_Outer_Full_Mid_CH

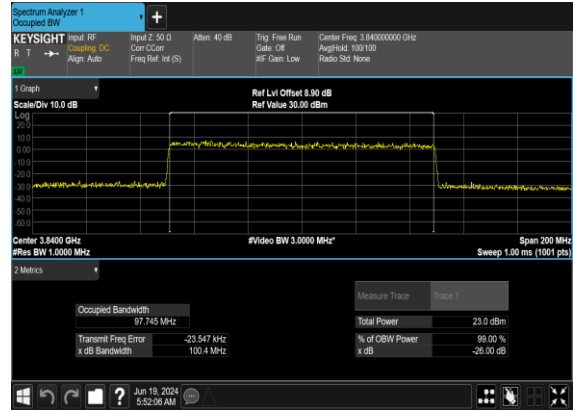



Conducted Spurious Emissions

NR Band	SCS (kHz)	Bandwidth (MHz)	Arfcn	Freq (MHz)	Modulation	RB	Result	Verdict
77	30	20	647334	3710.01	DFT-s-OFDM BPSK	1@0	see graph	---
77	30	20	647334	3710.01	DFT-s-OFDM BPSK	1@0	see graph	PASS
77	30	20	647334	3710.01	DFT-s-OFDM BPSK	1@0	see graph	PASS
77	30	20	647334	3710.01	DFT-s-OFDM QPSK	1@0	see graph	---
77	30	20	647334	3710.01	DFT-s-OFDM QPSK	1@0	see graph	PASS
77	30	20	647334	3710.01	DFT-s-OFDM QPSK	1@0	see graph	PASS
77	30	20	656000	3840.0	DFT-s-OFDM BPSK	1@0	see graph	---
77	30	20	656000	3840.0	DFT-s-OFDM BPSK	1@0	see graph	PASS
77	30	20	656000	3840.0	DFT-s-OFDM BPSK	1@0	see graph	PASS
77	30	20	656000	3840.0	DFT-s-OFDM QPSK	1@0	see graph	---
77	30	20	656000	3840.0	DFT-s-OFDM QPSK	1@0	see graph	PASS
77	30	20	656000	3840.0	DFT-s-OFDM QPSK	1@0	see graph	PASS
77	30	20	664666	3969.99	DFT-s-OFDM BPSK	1@0	see graph	---
77	30	20	664666	3969.99	DFT-s-OFDM BPSK	1@0	see graph	PASS
77	30	20	664666	3969.99	DFT-s-OFDM BPSK	1@0	see graph	PASS
77	30	20	664666	3969.99	DFT-s-OFDM QPSK	1@0	see graph	---
77	30	20	664666	3969.99	DFT-s-OFDM QPSK	1@0	see graph	PASS
77	30	20	664666	3969.99	DFT-s-OFDM QPSK	1@0	see graph	PASS
77	30	60	648668	3730.02	DFT-s-OFDM BPSK	1@0	see graph	---
77	30	60	648668	3730.02	DFT-s-OFDM BPSK	1@0	see graph	PASS



77	30	60	648668	3730.02	DFT-s-OFDM BPSK	1@0	see graph	PASS
77	30	60	648668	3730.02	DFT-s-OFDM QPSK	1@0	see graph	---
77	30	60	648668	3730.02	DFT-s-OFDM QPSK	1@0	see graph	PASS
77	30	60	648668	3730.02	DFT-s-OFDM QPSK	1@0	see graph	PASS
77	30	60	656000	3840.0	DFT-s-OFDM BPSK	1@0	see graph	---
77	30	60	656000	3840.0	DFT-s-OFDM BPSK	1@0	see graph	PASS
77	30	60	656000	3840.0	DFT-s-OFDM BPSK	1@0	see graph	PASS
77	30	60	656000	3840.0	DFT-s-OFDM QPSK	1@0	see graph	---
77	30	60	656000	3840.0	DFT-s-OFDM QPSK	1@0	see graph	PASS
77	30	60	656000	3840.0	DFT-s-OFDM QPSK	1@0	see graph	PASS
77	30	60	663332	3949.98	DFT-s-OFDM BPSK	1@0	see graph	---
77	30	60	663332	3949.98	DFT-s-OFDM BPSK	1@0	see graph	PASS
77	30	60	663332	3949.98	DFT-s-OFDM BPSK	1@0	see graph	PASS
77	30	60	663332	3949.98	DFT-s-OFDM QPSK	1@0	see graph	---
77	30	60	663332	3949.98	DFT-s-OFDM QPSK	1@0	see graph	PASS
77	30	60	663332	3949.98	DFT-s-OFDM QPSK	1@0	see graph	PASS
77	30	100	650000	3750.0	DFT-s-OFDM BPSK	1@0	see graph	---
77	30	100	650000	3750.0	DFT-s-OFDM BPSK	1@0	see graph	PASS
77	30	100	650000	3750.0	DFT-s-OFDM BPSK	1@0	see graph	PASS
77	30	100	650000	3750.0	DFT-s-OFDM QPSK	1@0	see graph	---
77	30	100	650000	3750.0	DFT-s-OFDM QPSK	1@0	see graph	PASS
77	30	100	650000	3750.0	DFT-s-OFDM QPSK	1@0	see graph	PASS



77	30	100	656000	3840.0	DFT-s-OFDM BPSK	1@0	see graph	---
77	30	100	656000	3840.0	DFT-s-OFDM BPSK	1@0	see graph	PASS
77	30	100	656000	3840.0	DFT-s-OFDM BPSK	1@0	see graph	PASS
77	30	100	656000	3840.0	DFT-s-OFDM QPSK	1@0	see graph	---
77	30	100	656000	3840.0	DFT-s-OFDM QPSK	1@0	see graph	PASS
77	30	100	656000	3840.0	DFT-s-OFDM QPSK	1@0	see graph	PASS
77	30	100	662000	3930.0	DFT-s-OFDM BPSK	1@0	see graph	---
77	30	100	662000	3930.0	DFT-s-OFDM BPSK	1@0	see graph	PASS
77	30	100	662000	3930.0	DFT-s-OFDM BPSK	1@0	see graph	PASS
77	30	100	662000	3930.0	DFT-s-OFDM QPSK	1@0	see graph	---
77	30	100	662000	3930.0	DFT-s-OFDM QPSK	1@0	see graph	PASS
77	30	100	662000	3930.0	DFT-s-OFDM QPSK	1@0	see graph	PASS



B2_N77(20M)_DFT-s-OFDM_BPSK_Edge_1RB_Left_Low_CH

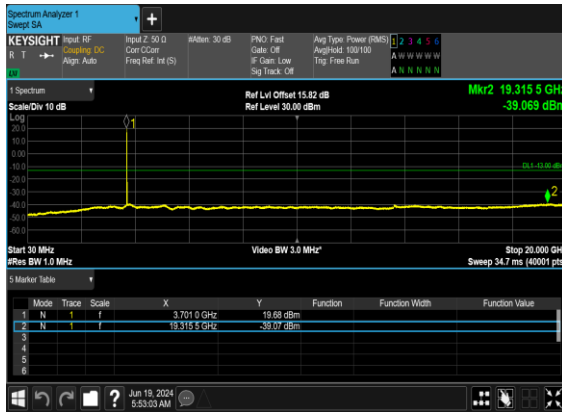

B2_N77(20M)_DFT-s-OFDM_BPSK_Edge_1RB_Left_Low_CH

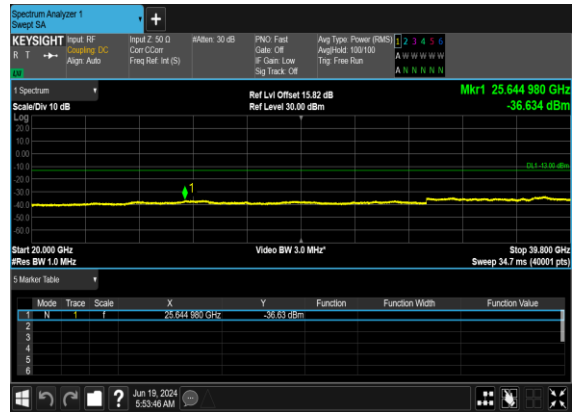

B2_N77(20M)_DFT-s-OFDM_QPSK_Edge_1RB_Left_Low_CH



B2_N77(20M)_DFT-s-OFDM_QPSK_Edge_1RB_Left_Low_CH

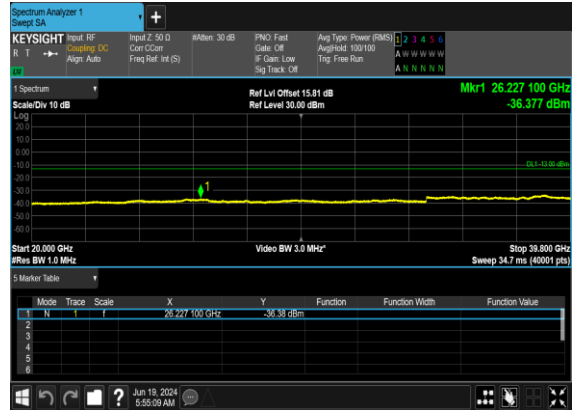



B2_N77(20M)_DFT-s-OFDM_BPSK_Edge_1RB_Left_Mid_CH

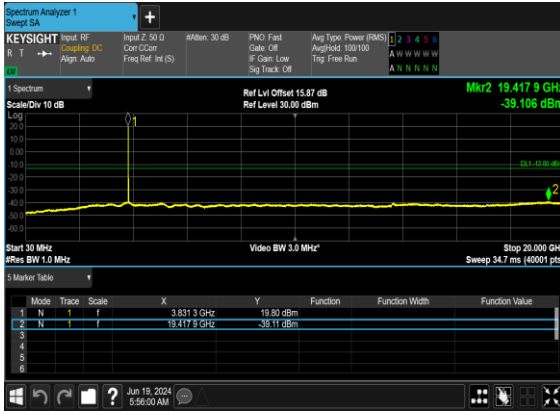

B2_N77(20M)_DFT-s-OFDM_BPSK_Edge_1RB_Left_Mid_CH

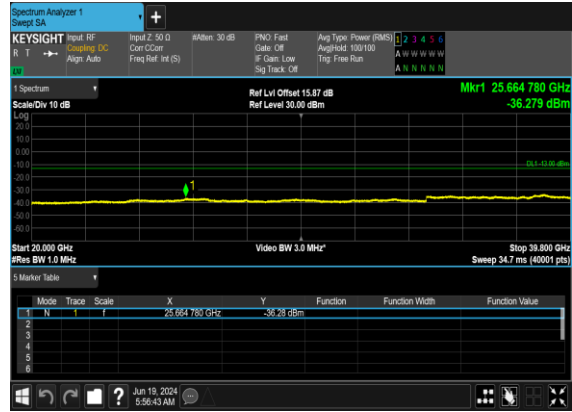

B2_N77(20M)_DFT-s-OFDM_QPSK_Edge_1RB_Left_Mid_CH

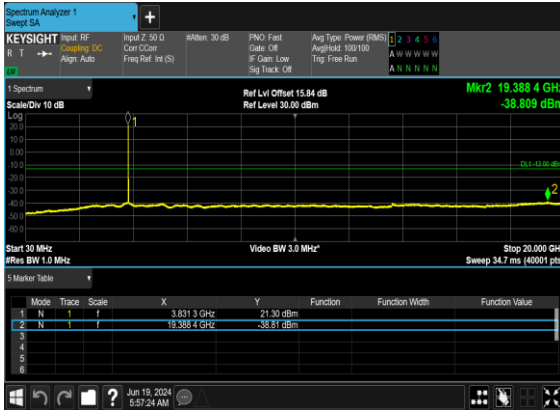

B2_N77(20M)_DFT-s-OFDM_QPSK_Edge_1RB_Left_Mid_CH

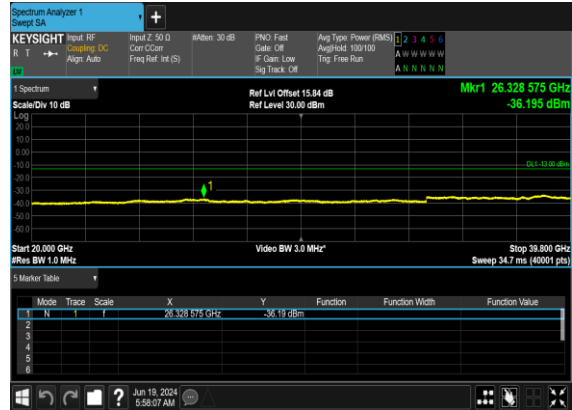



B2_N77(20M)_DFT-s-OFDM_BPSK_Edge_1RB_Left_High_CH

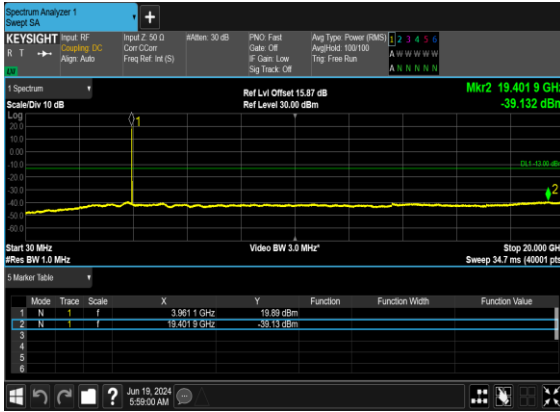

B2_N77(20M)_DFT-s-OFDM_BPSK_Edge_1RB_Left_High_CH

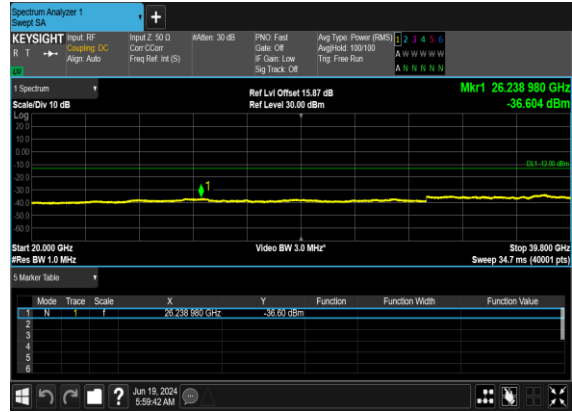

B2_N77(20M)_DFT-s-OFDM_QPSK_Edge_1RB_Left_High_CH

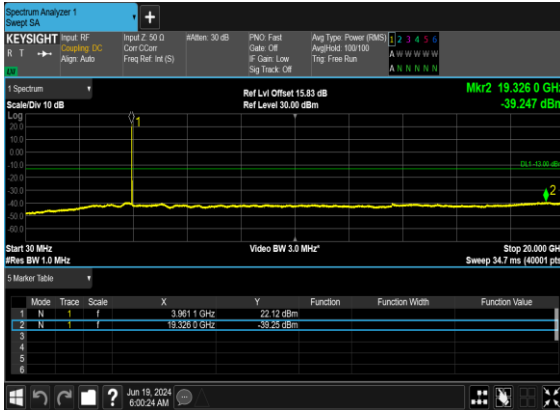

B2_N77(20M)_DFT-s-OFDM_QPSK_Edge_1RB_Left_High_CH

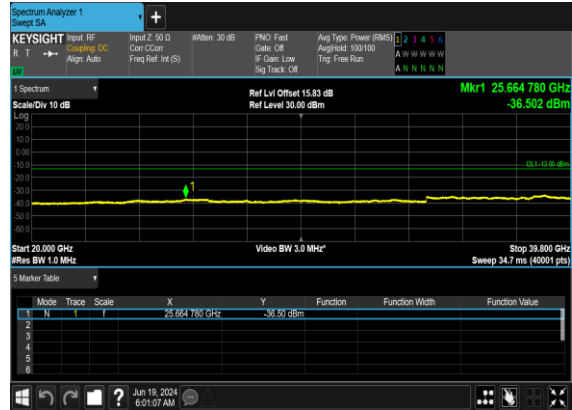



B2_N77(60M)_DFT-s-OFDM_BPSK_Edge_1RB_Left_Low_CH

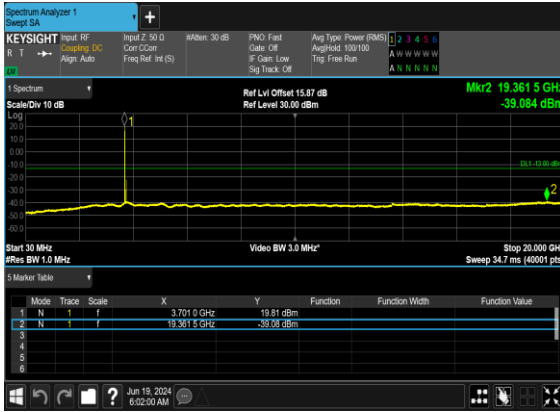

B2_N77(60M)_DFT-s-OFDM_BPSK_Edge_1RB_Left_Low_CH

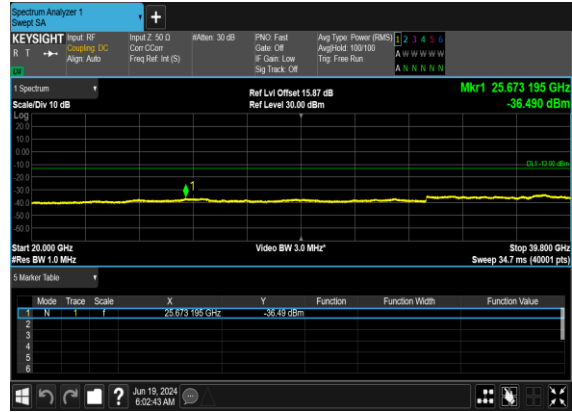

B2_N77(60M)_DFT-s-OFDM_QPSK_Edge_1RB_Left_Low_CH

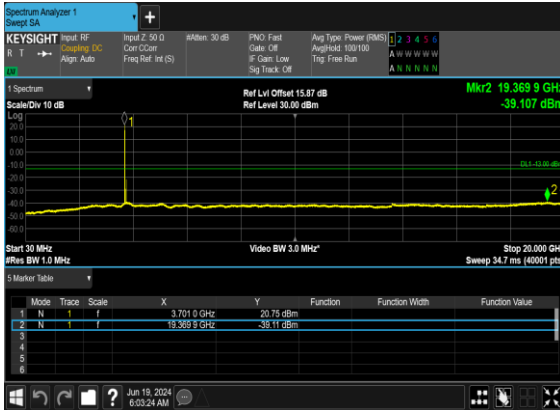

B2_N77(60M)_DFT-s-OFDM_QPSK_Edge_1RB_Left_Low_CH





B2_N77(60M)_DFT-s-OFDM_BPSK_Edge_1RB_Left_Mid_CH

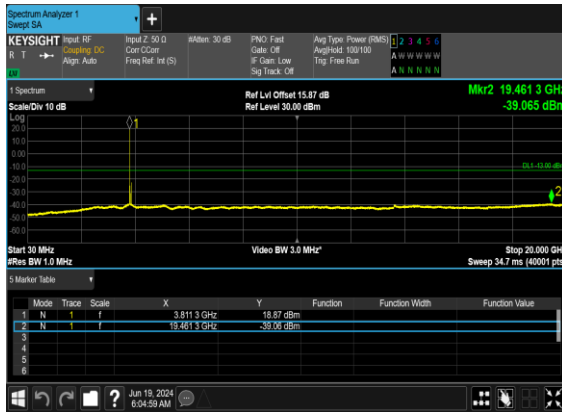

B2_N77(60M)_DFT-s-OFDM_BPSK_Edge_1RB_Left_Mid_CH

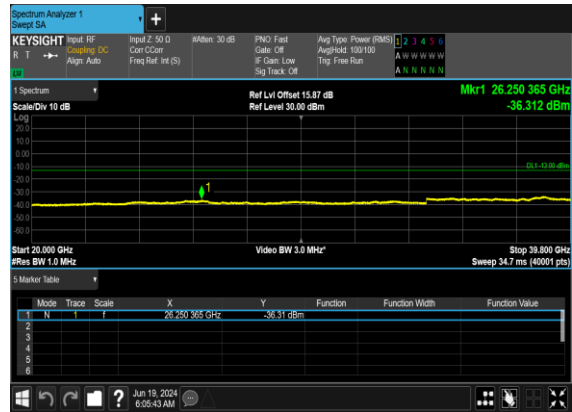

B2_N77(60M)_DFT-s-OFDM_QPSK_Edge_1RB_Left_Mid_CH

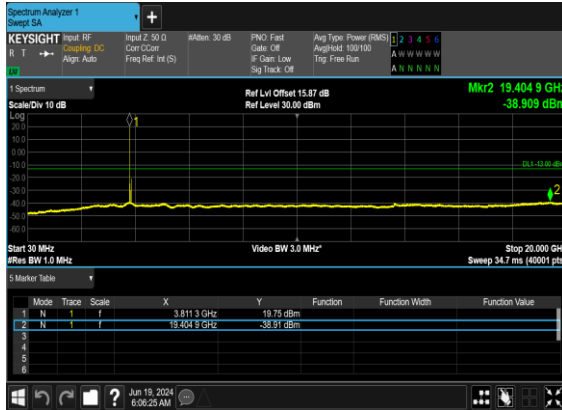

B2_N77(60M)_DFT-s-OFDM_QPSK_Edge_1RB_Left_Mid_CH

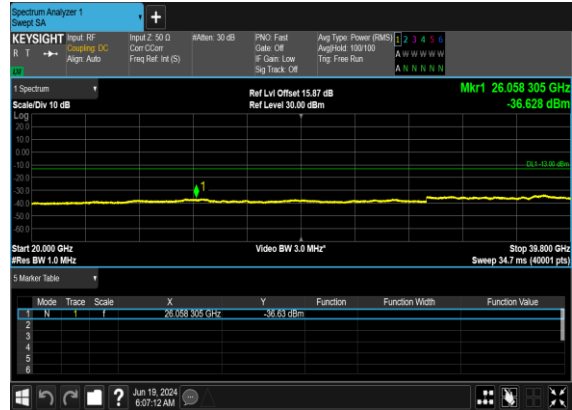



B2_N77(60M)_DFT-s-OFDM_BPSK_Edge_1RB_Left_High_CH

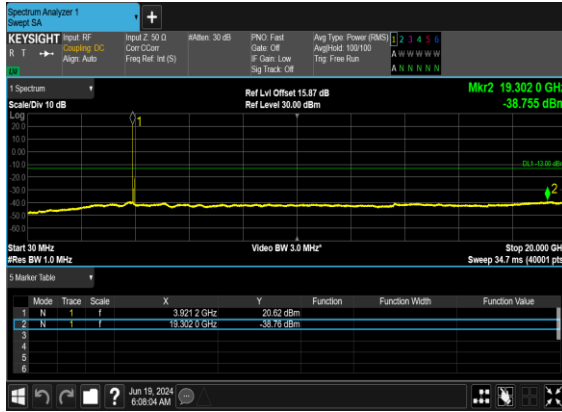

B2_N77(60M)_DFT-s-OFDM_BPSK_Edge_1RB_Left_High_CH

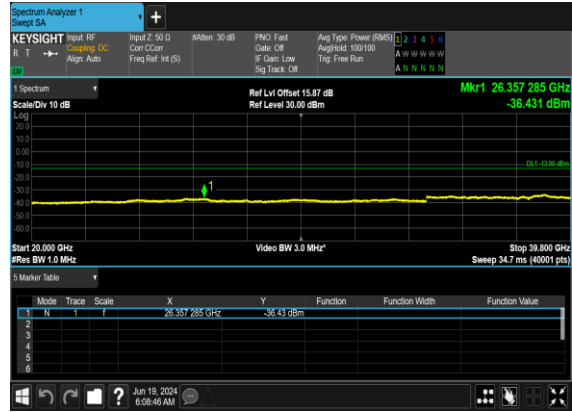

B2_N77(60M)_DFT-s-OFDM_QPSK_Edge_1RB_Left_High_CH



B2_N77(60M)_DFT-s-OFDM_QPSK_Edge_1RB_Left_High_CH

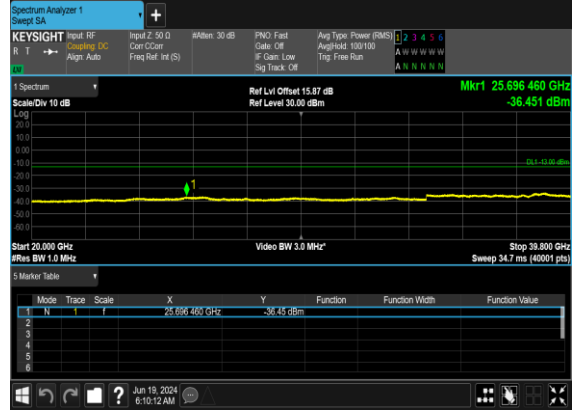



B2_N77(100M)_DFT-s-OFDM_BPSK_Edge_1RB_Left_Low_CH

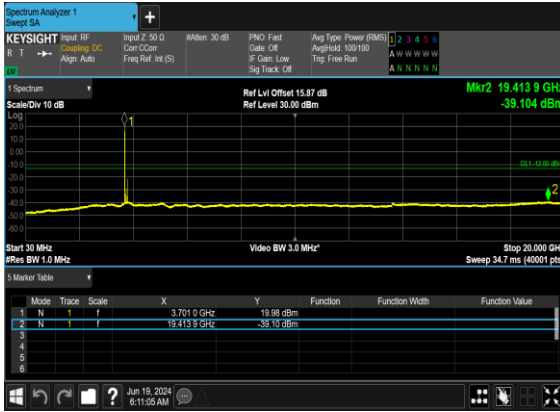

B2_N77(100M)_DFT-s-OFDM_BPSK_Edge_1RB_Left_Low_CH

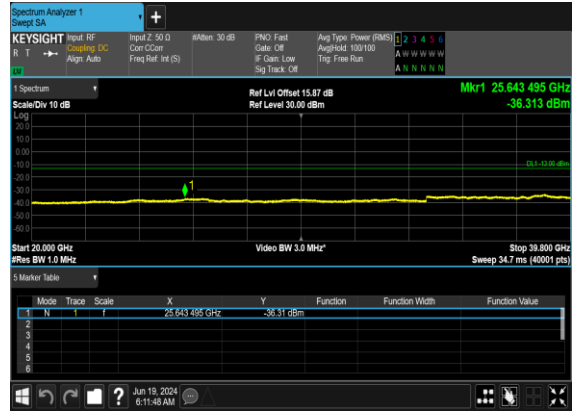

B2_N77(100M)_DFT-s-OFDM_QPSK_Edge_1RB_Left_Low_CH



B2_N77(100M)_DFT-s-OFDM_QPSK_Edge_1RB_Left_Low_CH

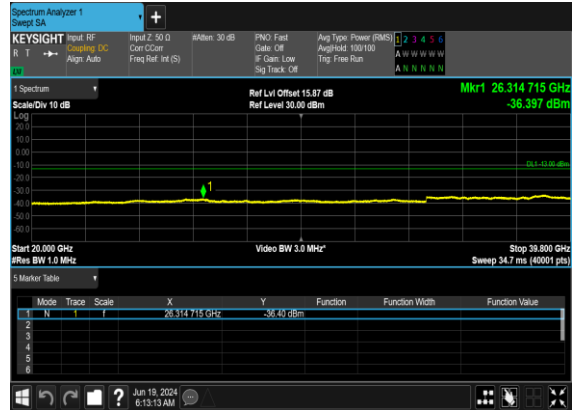



B2_N77(100M)_DFT-s-OFDM_BPSK_Edge_1RB_Left_Mid_CH

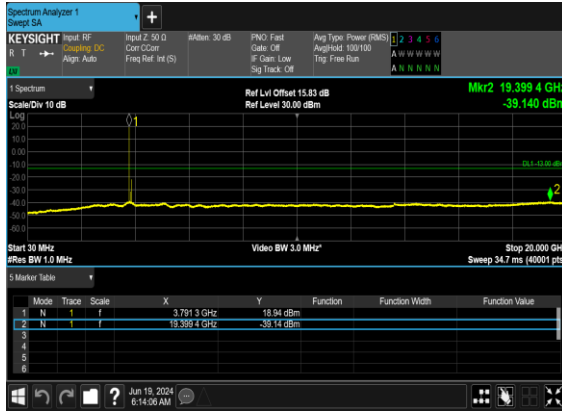

B2_N77(100M)_DFT-s-OFDM_BPSK_Edge_1RB_Left_Mid_CH

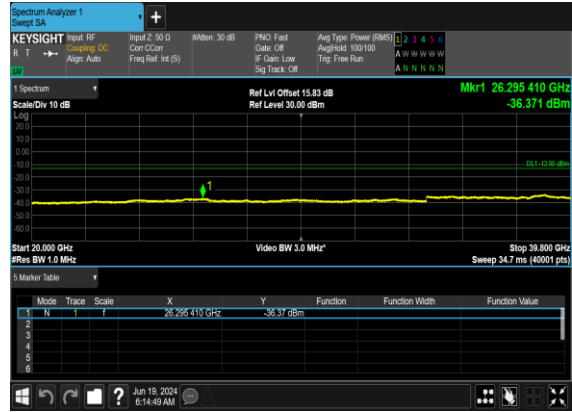

B2_N77(100M)_DFT-s-OFDM_QPSK_Edge_1RB_Left_Mid_CH

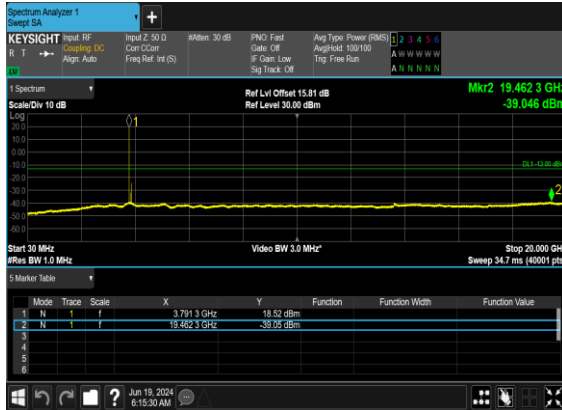

B2_N77(100M)_DFT-s-OFDM_QPSK_Edge_1RB_Left_Mid_CH

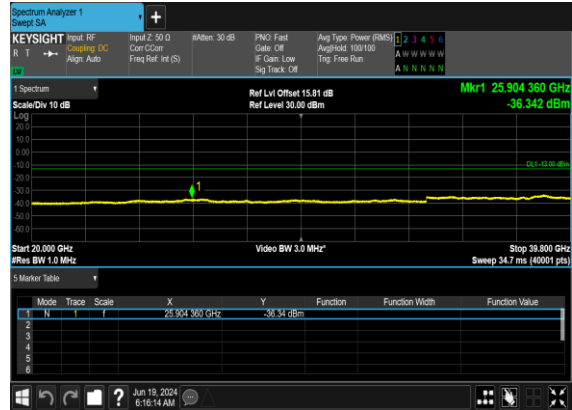



B2_N77(100M)_DFT-s-OFDM_BPSK_Edge_1RB_Left_High_CH

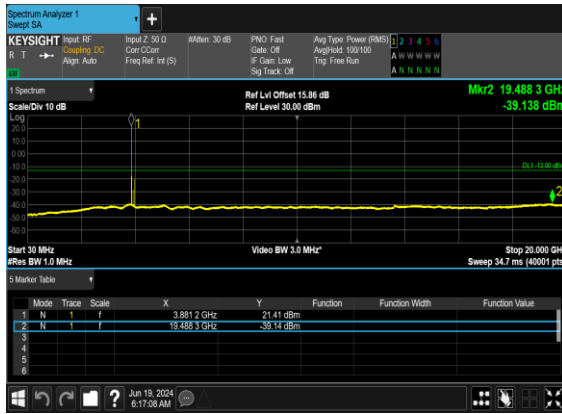

B2_N77(100M)_DFT-s-OFDM_BPSK_Edge_1RB_Left_High_CH

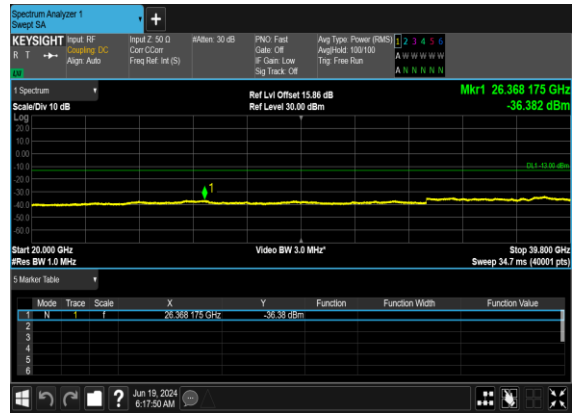

B2_N77(100M)_DFT-s-OFDM_QPSK_Edge_1RB_Left_High_CH



B2_N77(100M)_DFT-s-OFDM_QPSK_Edge_1RB_Left_High_CH

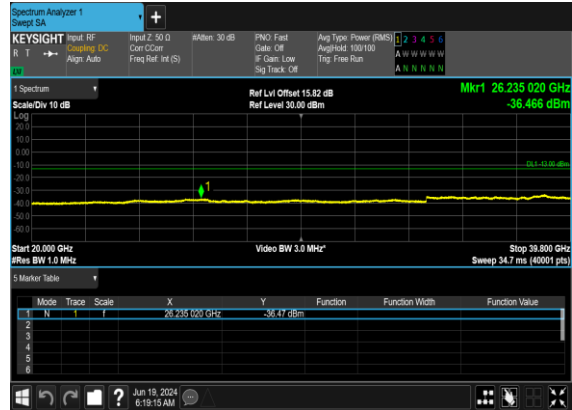



Conducted Band Edge

NR Band	SCS (kHz)	Bandwidth (MHz)	Arfcn	Freq (MHz)	Modulation	RB	Result	Verdict
77	30	20	647334	3710.01	DFT-s-OFDM BPSK	1@0	see graph	PASS
77	30	20	647334	3710.01	DFT-s-OFDM QPSK	1@0	see graph	PASS
77	30	20	647334	3710.01	DFT-s-OFDM BPSK	50@0	see graph	PASS
77	30	20	647334	3710.01	DFT-s-OFDM QPSK	50@0	see graph	PASS
77	30	20	664666	3969.99	DFT-s-OFDM BPSK	1@50	see graph	PASS
77	30	20	664666	3969.99	DFT-s-OFDM QPSK	1@50	see graph	PASS
77	30	20	664666	3969.99	DFT-s-OFDM BPSK	50@0	see graph	PASS
77	30	20	664666	3969.99	DFT-s-OFDM QPSK	50@0	see graph	PASS
77	30	60	648668	3730.02	DFT-s-OFDM BPSK	1@0	see graph	PASS
77	30	60	648668	3730.02	DFT-s-OFDM QPSK	1@0	see graph	PASS
77	30	60	648668	3730.02	DFT-s-OFDM BPSK	162@0	see graph	PASS
77	30	60	648668	3730.02	DFT-s-OFDM QPSK	162@0	see graph	PASS
77	30	60	663332	3949.98	DFT-s-OFDM BPSK	1@161	see graph	PASS
77	30	60	663332	3949.98	DFT-s-OFDM QPSK	1@161	see graph	PASS
77	30	60	663332	3949.98	DFT-s-OFDM BPSK	162@0	see graph	PASS
77	30	60	663332	3949.98	DFT-s-OFDM QPSK	162@0	see graph	PASS
77	30	100	650000	3750.0	DFT-s-OFDM BPSK	1@0	see graph	PASS
77	30	100	650000	3750.0	DFT-s-OFDM QPSK	1@0	see graph	PASS
77	30	100	650000	3750.0	DFT-s-OFDM BPSK	270@0	see graph	PASS
77	30	100	650000	3750.0	DFT-s-OFDM QPSK	270@0	see graph	PASS
77	30	100	662000	3930.0	DFT-s-OFDM BPSK	1@272	see graph	PASS
77	30	100	662000	3930.0	DFT-s-OFDM QPSK	1@272	see graph	PASS
77	30	100	662000	3930.0	DFT-s-OFDM BPSK	270@0	see graph	PASS
77	30	100	662000	3930.0	DFT-s-OFDM QPSK	270@0	see graph	PASS



B2_N77(20M)_DFT-s-OFDM_BPSK_Edge_1RB_Left_Low_CH

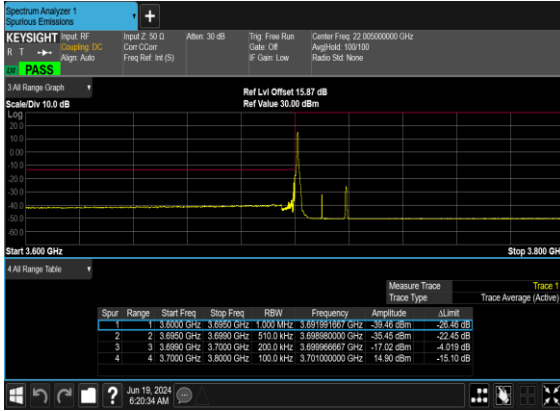

B2_N77(20M)_DFT-s-OFDM_QPSK_Edge_1RB_Left_Low_CH



B2_N77(20M)_DFT-s-OFDM_BPSK_Outer_Full_Low_CH

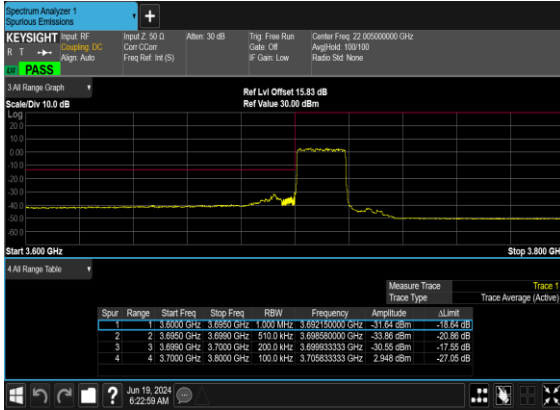

B2_N77(20M)_DFT-s-OFDM_QPSK_Outer_Full_Low_CH

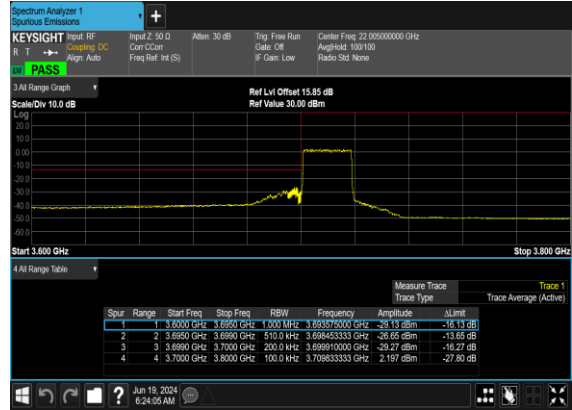



B2_N77(20M)_DFT-s-OFDM_BPSK_Edge_1RB_Right_High_CH



B2_N77(20M)_DFT-s-OFDM_QPSK_Edge_1RB_Right_High_CH

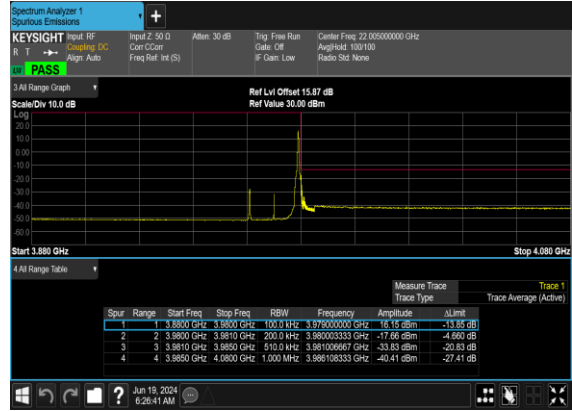

B2_N77(20M)_DFT-s-OFDM_BPSK_Outer_Full_High_CH

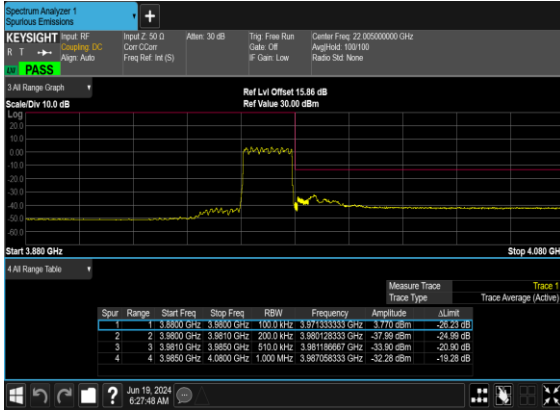

B2_N77(20M)_DFT-s-OFDM_QPSK_Outer_Full_High_CH





B2_N77(60M)_DFT-s-OFDM_BPSK_Edge_1RB_Left_Low_CH

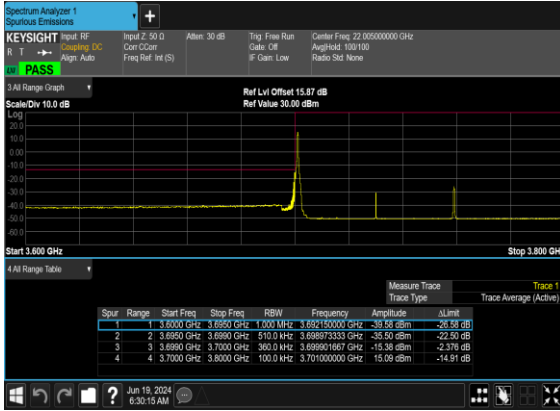

B2_N77(60M)_DFT-s-OFDM_QPSK_Edge_1RB_Left_Low_CH



B2_N77(60M)_DFT-s-OFDM_BPSK_Outer_Full_Low_CH

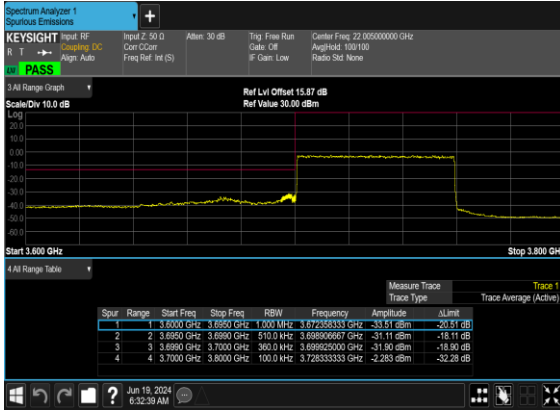

B2_N77(60M)_DFT-s-OFDM_QPSK_Outer_Full_Low_CH





B2_N77(60M)_DFT-s-OFDM_BPSK_Edge_1RB_Right_High_CH



B2_N77(60M)_DFT-s-OFDM_QPSK_Edge_1RB_Right_High_CH

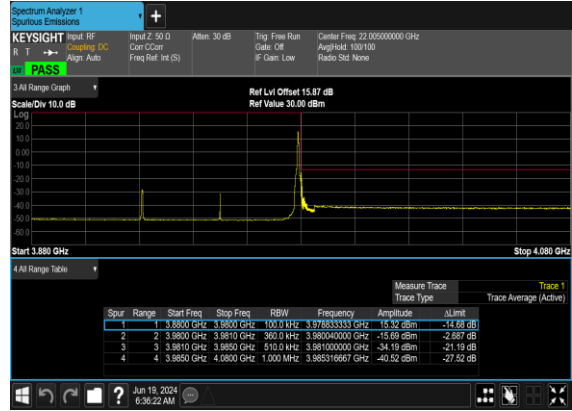

B2_N77(60M)_DFT-s-OFDM_BPSK_Outer_Full_High_CH

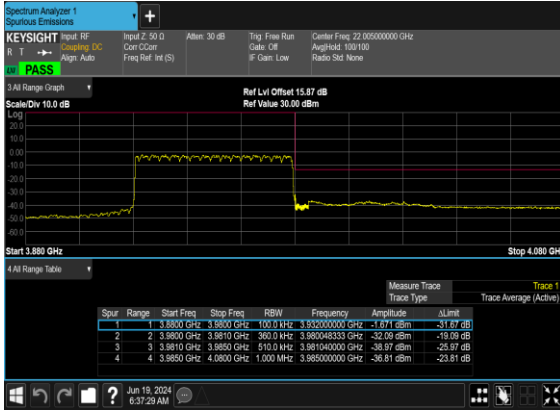

B2_N77(60M)_DFT-s-OFDM_QPSK_Outer_Full_High_CH

