

Slate R1260U

RFID UHF Desktop Reader



easy2read®

PRELIMINARY

Technical Information Manual

Revision n. 00

22/03/2011



Scope of Manual

The goal of this manual is to provide the basic information to work with the UHF Desktop Reader SLATE R1260U.

Change Document Record

Date	Revision	Changes
22 Mar 2011	00	Preliminary release.

CAEN RFID srl

Via Vetraia, 11 55049 Viareggio (LU) - ITALY
Tel. +39.0584.388.398 Fax +39.0584.388.959
info@caenrfid.it
www.caenrfid.it

© CAEN RFID srl – 2010

Disclaimer

No part of this manual may be reproduced in any form or by any means, electronic, mechanical, recording, or otherwise, without the prior written permission of CAEN RFID.

The information contained herein has been carefully checked and is believed to be accurate; however, no responsibility is assumed for inaccuracies. CAEN RFID reserves the right to modify its products specifications without giving any notice; for up to date information please visit www.caenrfid.it.

Federal Communications Commission (FCC) Notice (Preliminary)

This device was tested and found to comply with the limits set forth in Part 15 of the FCC Rules. Operation is subject to the following conditions: (1) this device may not cause harmful interference, and (2) this device must accept any interference received including interference that may cause undesired operation. These limits are designed to provide reasonable protection against harmful interference when the equipment is operated in a commercial environment.

This device generates, uses, and can radiate radio frequency energy. If not installed and used in accordance with the instruction manual, the product may cause harmful interference to radio communications. Operation of this product in a residential area is likely to cause harmful interference, in which case, the user is required to correct the interference at their own expense. The authority to operate this product is conditioned by the requirements that no modifications be made to the equipment unless the changes or modifications are expressly approved by CAEN RFID.

Preliminary Product Information

This document contains information for a new product. CAEN RFID reserves the right to modify this product without notice.

“Preliminary” product information describes products that are ready for production, but for which full characterization data is not yet available. CAEN RFID believes that the information contained in this document is accurate and reliable. However, the information is subject to change without notice and is provided “AS IS” without warranty of any kind (Express or implied). You are advised to obtain the latest version of relevant information to verify, before placing orders, that information being relied on is current and complete. All products are sold subject to the terms and conditions of sale supplied at the time of order acknowledgement, including those pertaining to warranty, patent infringement, and limitation of liability. No responsibility is assumed by CAEN RFID for the use of this information, including use of this information as the basis for manufacture or sale of any items, or for infringement of patents or other rights of third parties.

Disposal of the product

Do not dispose the product in municipal or household waste. Please check your local regulations for disposal/recycle of electronic products.



Index

Scope of Manual	2
Change Document Record	2
Index.....	3
List of Figures	3
List of Tables	3
1 Introduction	4
General Information	5
Ordering Code.....	5
Accessories	6
Installation Notice.....	6
2 SLATE R1260U Functional Description	8
Main Features.....	9
External Connection	9
Front Panel Leds	9
Serial Port Emulator.....	9
Driver installation.....	9
Firmware Upgrade	14
3 SLATE R1260U Technical Specifications	15
Technical Specifications Table	16
Reader – Tag Link Profiles.....	16
Radiation Patterns	17
4 SLATE R1260U Regulatory Compliance	18
FCC Compliance	19

List of Figures

Fig. 1.1: Slate R1260U UHF Desktop Reader	5
Fig. 1.2: Slate R1260U Technical drawings: top view	6
Fig. 1.3: Slate R1260U Wall mounting	7
Fig. 3.1: Slate R1260U Radiation pattern H plane	17
Fig. 3.2: Slate R1260U Radiation pattern V plane.....	17

List of Tables

Tab. 2.1: Slate R1260U Front Panel Leds	9
Tab. 3.1: Slate R1260U Technical Specifications.....	16
Tab. 3.2: Slate R1260U Reader to tag link profiles	16

1 Introduction

This Chapter gives general information about the **SLATE R1260U UHF Desktop Reader**. It contains these topics:

- [General Information](#)
- [Ordering Code](#)
- [Accessories](#)
- [Installation Notice](#)



General Information

The Slate (Model R1260U), the new desktop reader of the easy2read© Family, is an UHF RFID reader with integrated antenna for short range applications.

The Slate Reader is powered and controlled directly by an USB cable, thus allowing to read EPC Class 1 Gen 2 UHF RFID tags in an easy desktop environment.

Thanks to its low profile (15 mm) and its size (approximately an A4 page), the Slate reader is the perfect choice for various applications such as point-of-sales, document tracking, RFID programming stations, access control and so on. It can be used as a building block for smart shelves and smart displays.

The core component of the Slate is the new CAEN RFID Quark module, the smallest and lowest power consuming module available on the market.



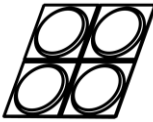
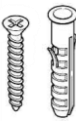

Fig. 1.1: Slate R1260U UHF Desktop Reader

Ordering Code

Code	Description
WR1260UYAAAA	R1260U - RFID UHF Desktop Reader (FCC part 15)

Accessories

Check for the supplied accessories below:

 <p>No. 2 wall hooks</p>	 <p>No. 4 rubber feet</p>
 <p>No. 2 rawlplugs (ø 4 mm) + screws</p>	 <p>No. 2 small screws (ø 3 mm)</p>

Installation Notice

The Slate R1260U can be easily placed on a table for desktop applications or it is possible to hang it on the wall.

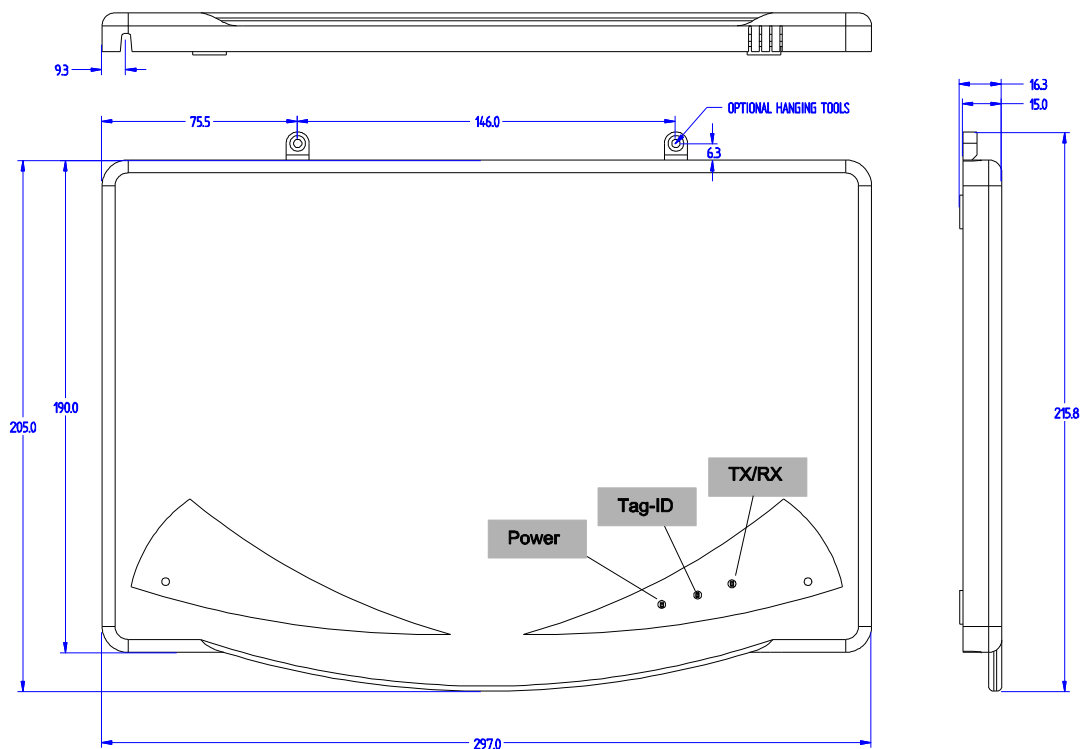

Fig. 1.2: Slate R1260U Technical drawings: top view

Horizontal Installation:

The Slate can be easily placed on a table for desktop applications affixing the 4 rubber feet to the bottom of the Slate R1260U to prevent it from sliding.

Vertical Installation:

The Slate can be hanged on the wall (see *Fig. 1.3: Slate R1260U Wall mounting*).

First of all, use the two small screws (\varnothing 3 mm) to fix the 2 hooks on the Slate.

Then, to hang the Slate on the wall, fix the hooks to the wall using the 2 rawlplugs (\varnothing 4 mm) + screws at a distance of 146 mm each others.

If you want to hang the Slate on a wood panelling, fix the hooks to the wall just using the 2 screws.

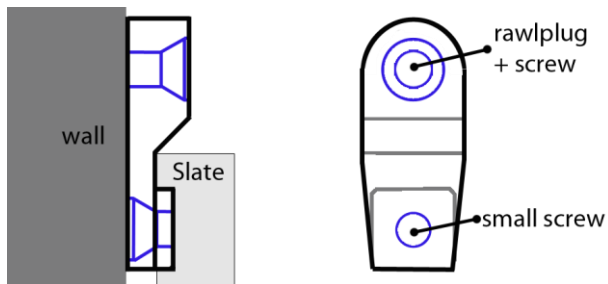

Fig. 1.3: Slate R1260U Wall mounting

2 SLATE R1260U Functional Description

This Chapter gives a functional description of the **SLATE R1260U UHF Desktop Reader**. It contains these topics:

- [Main Features](#)
- [External Connection](#)
- [Front Panel Leds](#)
- [Serial Port Emulator](#)
- [Firmware Upgrade](#)



Main Features

- FCC part 15 compliant
- EPC C1 G2/ISO18000-6C Compliant
- Integrated circular polarized antenna
- Programmable output RF power
- Powered by USB
- Low profile

External Connection

The external connection is via USB port.

The USB cable is located in the back side of the Slate. You can pass the USB cable through the opening at the bottom or at the top of the Slate back side. The mechanical specification of the USB Port is as follows:

- USB Port: USB Type A plug connector

The Slate R1260U is powered through the USB host.

Front Panel Leds

The Slate R1260U front panel houses the following Leds (see *Fig. 1.2: Slate R1260U Technical drawings: top view*):

LEDS	FUNCTION	TYPE
POWER	Power ON	Green Led
TAG-ID	Tag detection	Blinking Red Led
TX/RX	USB communication activity	Blinking Yellow Led

Tab. 2.1: Slate R1260U Front Panel Leds

Serial Port Emulator

The SLATE R1260U can be connected to a PC via USB connection. The RFID reader emulates a serial port. In the next paragraph the procedure to install the required driver is presented.

Driver installation

The procedure to install the USB driver is presented below:

1. Verify that the USB cable is correctly plugged into the PC.
2. If the USB to Serial driver is not installed on the PC the following pop-up window is displayed.



3. Insert the CD provided together with the SLATE R1260U. Select “No, not this time” and click on next.
4. Select “Install from a list or specific location and click on next.



5. Select “Search removable media” and click on next.

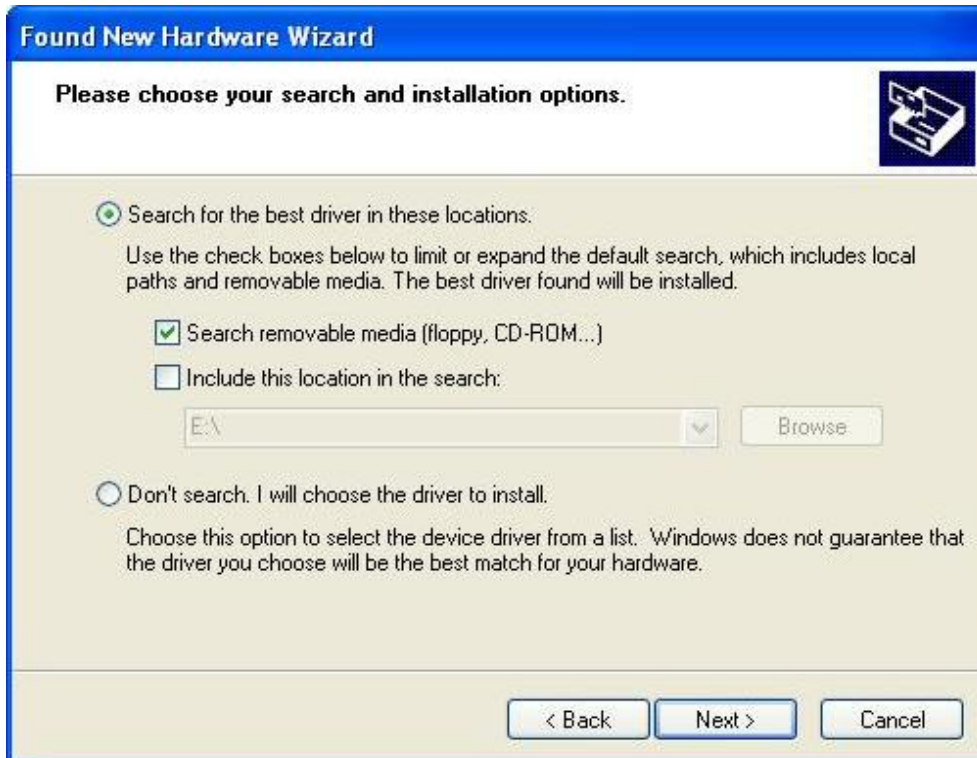

6. When the installation is successfully terminated, press on Finish.



7. Now the driver installation procedure is completed. Open the System properties (right click on "My computer" icon) → Hardware → Device Manager.



8. See the emulated serial port in the “USB serial port(COM X)”, in the case below COM4.

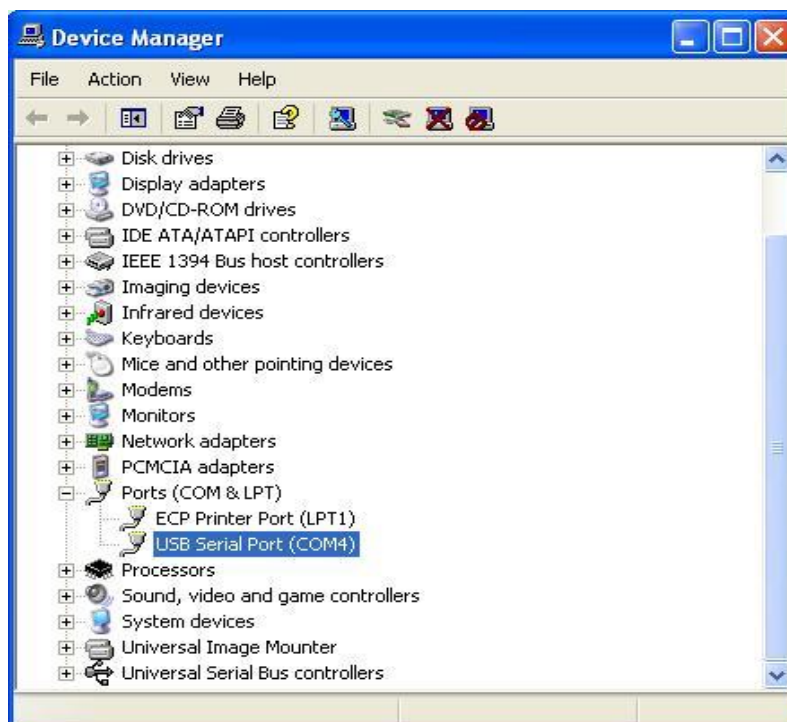

9. Once the serial port connection is established, CAEN RFID Show software can be used to interface the reader:
- Open CAEN RFID Show
 - Click on File -> Connect
 - Type the COM port the reader is using (in the example COM4) and click on Connect button.



10. Now the Slate R1260U is ready to perform tag scanning and read/write operations.

Firmware Upgrade

The Slate R1260U firmware upgrade can be managed via USB.

In order to upgrade the firmware follow the steps below:

- Verify the virtual COM port associated to the reader
- Open the FW upgrade program
- Select the COM port
- Select the image file by clicking on "Open" button

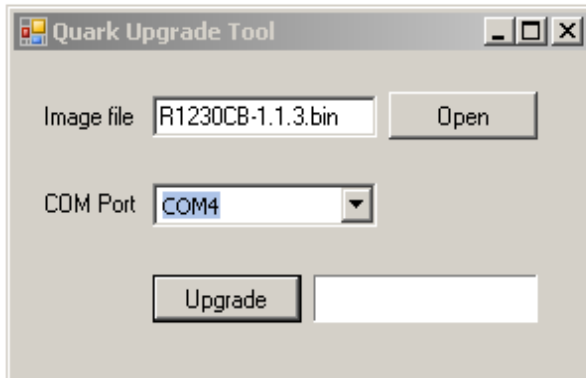

- Click on "Upgrade" button
- Wait for the upgrade to be completed

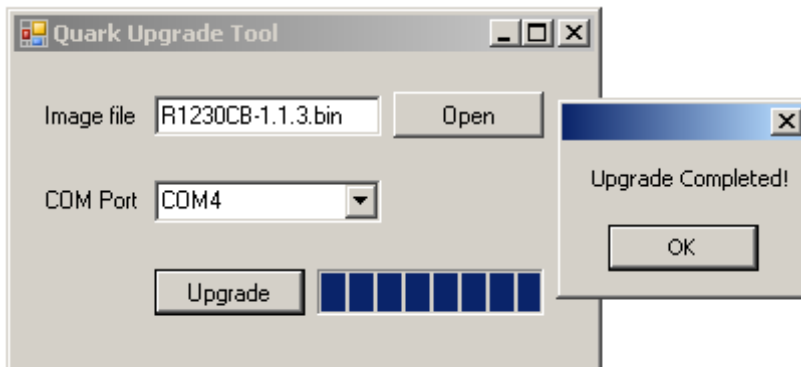

- Disconnect the USB cable
- Connect again the USB cable: now the reader is ready

3 SLATE R1260U Technical Specifications

This Chapter introduces the technical specifications of the **SLATE R1260U UHF Desktop Reader**. It contains these topics:

- [Technical Specifications Table](#)
- [Reader – Tag Link Profiles](#)
- [Radiation Patterns](#)



Technical Specifications Table

Frequency Band	902-928 MHz (FCC part 15)
RF Power	Programmable in 15 levels (1dB step) from 4dBm ERP to 18dBm ERP (from 2.5mW ERP to 67mW ERP)
Antenna	Integrated Circular Polarized Antenna
Number of Channels	50 hopping channels (compliant to FCC part 15.247). All subsets of FCC band are supported via FW upgrade
Standard Compliance	EPC C1G2/ISO 18000-6C
User Interface	Green LED: Power Blinking red LED: Tag detection Blinking yellow LED: USB communication activity Buzzer: user programmable event signaling
USB Device Port	USB Type A plug connector Bus powered USB 2.0 device Must be connected to High-power Port (500 mA @ VBUS) It appears as USB serial port Virtual Com Port (VCP) drivers for Windows XP/Vista/Seven (7), Windows CE 4.2, Linux 2.40 and greater Baudrate: 115200 Databits: 8 Stopbits: 1 Parity: none Flow control: none
Dimensions	(W)297 x (L)205 x (H)15 mm ³ (11.7 x 8 x 0.6 inch ³)
Electrical Power	5 V DC bus powered (USB) Max 400 mA
Operating Temperature	-10 °C to +55 °C
Weight	525 g
Length of USB cable	1,5 m

Tab. 3.1: Slate R1260U Technical Specifications

Reader – Tag Link Profiles

Slate R1260U reader supports different modulation and return link profiles according to EPC Class1 Gen2 protocol.

In the following table are reported all profiles that have been tested for the compliance FCC regulations.

Link profile #	Regulation	Modulation	Return Link
0	FCC	DSB-ASK; f=40kHz	FM0; f = 40kHz
1	FCC	DSB-ASK; f=40kHz	Miller (M=4); f = 256kHz

Tab. 3.2: Slate R1260U Reader to tag link profiles

Radiation Patterns

The radiation patterns of Slate R1260U are shown in the following figures.

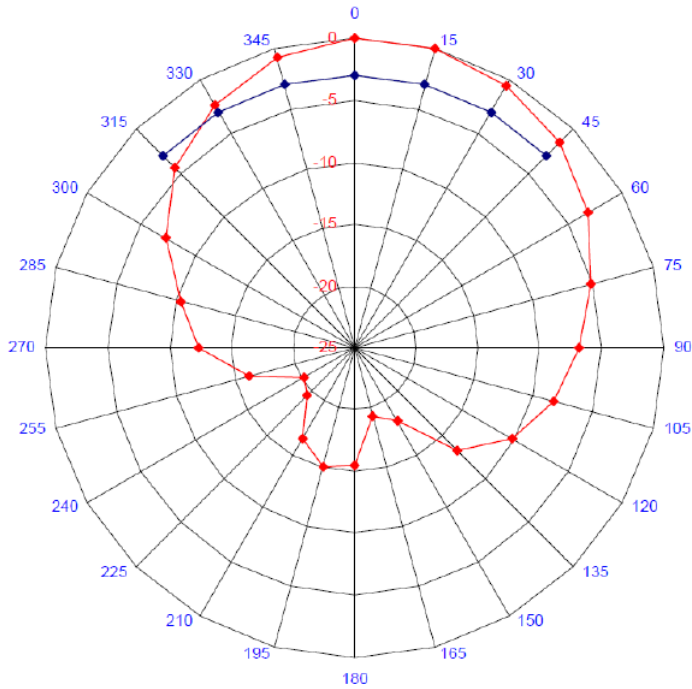

Fig. 3.1: Slate R1260U Radiation pattern H plane

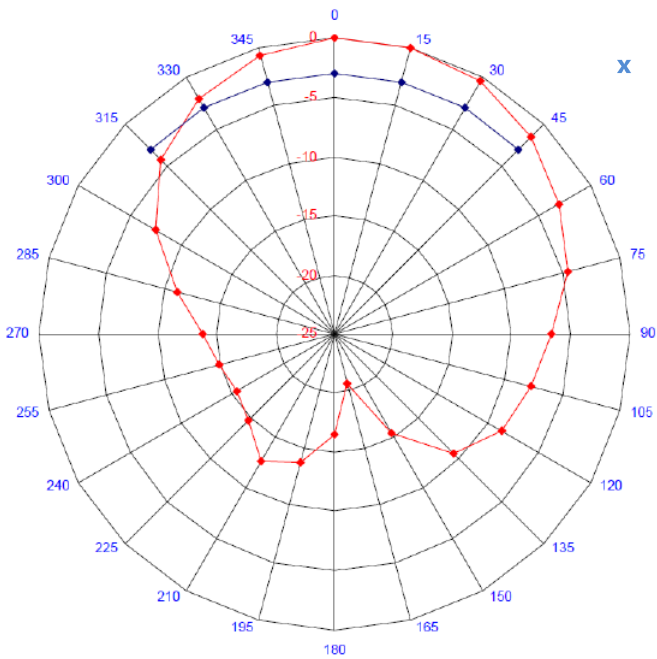
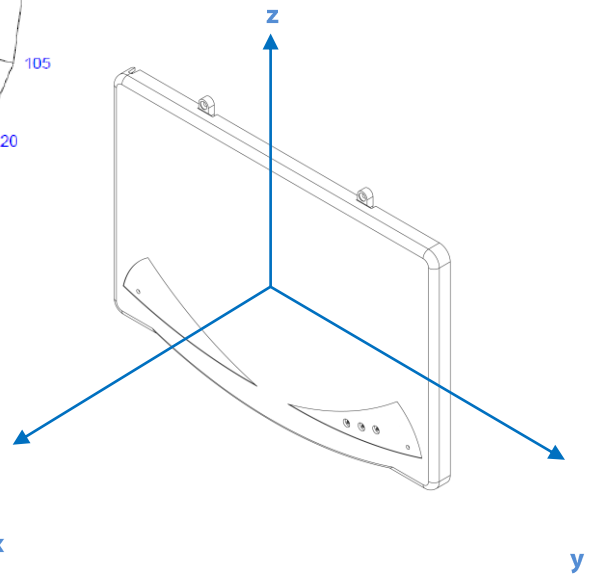

Fig. 3.2: Slate R1260U Radiation pattern V plane

4 SLATE R1260U

Regulatory Compliance





FCC Compliance

This equipment has been tested and found to comply with Part 15 of the FCC Rules.

NOTE:

- (a) Any changes or modification not approved by CAEN RFID could void the user's authority to operate the equipment.
- (b) The Slate R1260U reader contains an integrated circular antenna with -2.6dBi gain. The maximum radiated power is $67\text{mW e.r.p. (110 mW e.i.r.p.)}$. Use of other than the approved antenna with this unit may result in harmful interference with other users, and cause the unit to fail to meet regulatory requirements.