

FCC Test Report (WLAN)

Report No.: RF180704E02-1

FCC ID: UDX-60083010

Test Model: MR55-HW

Received Date: July 05, 2018

Test Date: Aug. 08 to Oct. 19, 2018

Issued Date: Dec. 24, 2018

Applicant: Cisco Systems, Inc.

Address: 170 West Tasman Drive, San Jose, CA 95134 USA

Issued By: Bureau Veritas Consumer Products Services (H.K.) Ltd., Taoyuan Branch
Hsin Chu Laboratory

Lab Address: E-2, No.1, Li Hsin 1st Road, Hsinchu Science Park, Hsinchu City 300,
Taiwan R.O.C.

Test Location: E-2, No.1, Li Hsin 1st Road, Hsinchu Science Park, Hsinchu City 300,
Taiwan R.O.C.

**FCC Registration /
Designation Number:** 723255 / TW2022



This report is for your exclusive use. Any copying or replication of this report to or for any other person or entity, or use of our name or trademark, is permitted only with our prior written permission. This report sets forth our findings solely with respect to the test samples identified herein. The results set forth in this report are not indicative or representative of the quality or characteristics of the lot from which a test sample was taken or any similar or identical product specifically and expressly noted. Our report includes all of the tests requested by you and the results thereof based upon the information that you provided to us. You have 60 days from date of issuance of this report to notify us of any material error or omission caused by our negligence, provided, however, that such notice shall be in writing and shall specifically address the issue you wish to raise. A failure to raise such issue within the prescribed time shall constitute your unqualified acceptance of the completeness of this report, the tests conducted and the correctness of the report contents. Unless specific mention, the uncertainty of measurement has been explicitly taken into account to declare the compliance or non-compliance to the specification. The report must not be used by the client to claim product certification, approval, or endorsement by TAF or any government agencies.

Table of Contents

Release Control Record	4
1 Certificate of Conformity	5
2 Summary of Test Results	6
2.1 Measurement Uncertainty	6
2.2 Modification Record	6
3 General Information	7
3.1 General Description of EUT (WLAN)	7
3.2 Description of Test Modes	13
3.2.1 Test Mode Applicability and Tested Channel Detail	14
3.3 Duty Cycle of Test Signal	17
3.4 Description of Support Units	19
3.4.1 Configuration of System under Test	20
3.5 General Description of Applied Standard	22
4 Test Types and Results	23
4.1 Radiated Emission and Bandedge Measurement.....	23
4.1.1 Limits of Radiated Emission and Bandedge Measurement	23
4.1.2 Test Instruments	24
4.1.3 Test Procedure	26
4.1.4 Deviation from Test Standard	27
4.1.5 Test Setup.....	27
4.1.6 EUT Operating Condition	28
4.1.7 Test Results (Mode 1).....	29
4.1.8 Test Results (Mode 2).....	50
4.1.9 Test Results (Mode 3).....	69
4.1.10 Test Results (Mode 4).....	87
4.2 Conducted Emission Measurement	105
4.2.1 Limits of Conducted Emission Measurement	105
4.2.2 Test Instruments	105
4.2.3 Test Procedure	106
4.2.4 Deviation from Test Standard	106
4.2.5 Test Setup.....	106
4.2.6 EUT Operating Condition	106
4.2.7 Test Results	107
4.3 Transmit Power Measurement	109
4.3.1 Limits of Transmit Power Measurement	109
4.3.2 Test Setup.....	109
4.3.3 Test Instruments	109
4.3.4 Test Procedure	109
4.3.5 Deviation from Test Standard	109
4.3.6 EUT Operating Condition	109
4.3.7 Test Results (Mode 1).....	110
4.3.8 Test Results (Mode 2).....	117
4.3.9 Test Results (Mode 3).....	123
4.3.10 Test Results (Mode 4).....	128
4.4 Occupied Bandwidth Measurement	131
4.4.1 Test Setup.....	131
4.4.2 Test Instruments	131
4.4.3 Test Procedure	131
4.4.4 Test Results (Mode 1).....	132
4.4.5 Test Results (Mode 2).....	145
4.4.6 Test Results (Mode 3).....	154
4.4.7 Test Results (Mode 4).....	158
4.5 Peak Power Spectral Density Measurement	162

4.5.1	Limits of Peak Power Spectral Density Measurement	162
4.5.2	Test Setup	162
4.5.3	Test Instruments	162
4.5.4	Test Procedure	162
4.5.5	Deviation from Test Standard	163
4.5.6	EUT Operating Condition	163
4.5.7	Test Results (Mode 1).....	164
4.5.8	Test Results (Mode 2).....	174
4.5.9	Test Results (Mode 3).....	185
4.5.10	Test Results (Mode 4).....	193
4.6	Frequency Stability Measurement	199
4.6.1	Limits of Frequency Stability Measurement	199
4.6.2	Test Setup.....	199
4.6.3	Test Instruments	199
4.6.4	Test Procedure	199
4.6.5	Deviation from Test Standard	199
4.6.6	EUT Operating Condition	199
4.6.7	Test Results	200
4.7	6dB Bandwidth Measurement.....	201
4.7.1	Limits of 6dB Bandwidth Measurement.....	201
4.7.2	Test Setup.....	201
4.7.3	Test Instruments	201
4.7.4	Test Procedure	201
4.7.5	Deviation from Test Standard	201
4.7.6	EUT Operating Condition	201
4.7.7	Test Results (Mode 1).....	202
4.7.8	Test Results (Mode 2).....	204
4.7.9	Test Results (Mode 3).....	206
4.7.10	Test Results (Mode 4).....	208
5	Pictures of Test Arrangements.....	210
	Annex A- Radiated Out of Band Emission (OOBE) Measurement (For U-NII-3 band).....	211
	Appendix – Information on the Testing Laboratories	225

Release Control Record

Issue No.	Description	Date Issued
RF180704E02-1	Original release.	Dec. 24, 2018

1 Certificate of Conformity

Product: 8x8 802.11a/b/g/n/ac/ax Access Point

Brand: Cisco

Test Model: MR55-HW

Sample Status: ENGINEERING SAMPLE

Applicant: Cisco Systems, Inc.

Test Date: Aug. 08 to Oct. 19, 2018

Standard: 47 CFR FCC Part 15, Subpart E (Section 15.407)
ANSI C63.10: 2013

The above equipment has been tested by **Bureau Veritas Consumer Products Services (H.K.) Ltd., Taoyuan Branch**, and found compliance with the requirement of the above standards. The test record, data evaluation & Equipment Under Test (EUT) configurations represented herein are true and accurate accounts of the measurements of the sample's EMC characteristics under the conditions specified in this report.

Prepared by : Phoenix Huang , **Date:** Dec. 24, 2018
Phoenix Huang / Specialist

Approved by : Max Chen , **Date:** Dec. 24, 2018
Max Chen / Manager

2 Summary of Test Results

47 CFR FCC Part 15, Subpart E (Section 15.407)			
FCC Clause	Test Item	Result	Remarks
15.407(b)(6)	AC Power Conducted Emissions	Pass	Meet the requirement of limit. Minimum passing margin is -5.29dB at 28.68750MHz.
15.407(b) (1/2/3/4(i/ii)/6)	Radiated Emissions & Band Edge Measurement*	Pass	Meet the requirement of limit. Minimum passing margin is -0.1dB at 5150.00MHz, 5640.49MHz and 5928.10MHz.
15.407(a)(1/2/3)	Max Average Transmit Power	Pass	Meet the requirement of limit.
---	Occupied Bandwidth Measurement	-	Reference only.
15.407(a)(1/2/3)	Peak Power Spectral Density	Pass	Meet the requirement of limit.
15.407(e)	6dB bandwidth	Pass	Meet the requirement of limit. (U-NII-3 Band only)
15.407(g)	Frequency Stability	Pass	Meet the requirement of limit.
15.203	Antenna Requirement	Pass	Antenna connector is i-pex(MHF) not a standard connector.

*For U-NII-3 band compliance with rule part 15.407(b)(4)(i), the OOB test plots were recorded in Annex A.

2.1 Measurement Uncertainty

Where relevant, the following measurement uncertainty levels have been estimated for tests performed on the EUT as specified in CISPR 16-4-2:

Measurement	Frequency	Expanded Uncertainty (k=2) (\pm)
Conducted Emissions at mains ports	150kHz ~ 30MHz	1.84 dB
Radiated Emissions up to 1 GHz	30MHz ~ 1GHz	5.53 dB
Radiated Emissions above 1 GHz	1GHz ~ 6GHz	5.08 dB
	6GHz ~ 18GHz	4.98 dB
	18GHz ~ 40GHz	5.19 dB

2.2 Modification Record

There were no modifications required for compliance.

3 General Information

3.1 General Description of EUT (WLAN)

Product	8x8 802.11a/b/g/n/ac/ax Access Point
Brand	Cisco
Test Model	MR55-HW
Status of EUT	ENGINEERING SAMPLE
Power Supply Rating	12Vdc from power adapter or 55Vdc from PoE
Modulation Type	CCK, DQPSK, DBPSK for DSSS 64QAM, 16QAM, QPSK, BPSK for OFDM 256QAM for OFDM in 11ac mode and VHT (20/40) mode in 2.4GHz 1024QAM for OFDMA in 11ax HE mode
Modulation Technology	DSSS, OFDM, OFDMA
Transfer Rate	802.11b: up to 11Mbps 802.11a/g: up to 54Mbps 802.11n: up to 600Mbps 802.11ac: up to 3466.7Mbps 802.11ax: up to 4803.9Mbps
Operating Frequency	2.4GHz: 2.412 ~ 2.462GHz 5GHz: 5.18~ 5.24GHz, 5.745 ~ 5.825GHz
Number of Channel	2.4GHz: 802.11b, 802.11g, 802.11n (HT20), VHT20, 802.11ax (HE20): 11 802.11n (HT40),VHT40, 802.11ax (HE40): 7 5GHz: 802.11a, 802.11n (HT20), 802.11ac (VHT20), 802.11ax (HE20): 9 802.11n (HT40), 802.11ac (VHT40), 802.11ax (HE40): 4 802.11ac (VHT80), 802.11ax (HE80): 2 802.11ac (VHT80+80), 802.11ax (HE80+80): 1 set
Output Power	2.412 ~ 2.462GHz: Non-Beamforming Mode: 4TX: 864.55mW 2TX: 456.82mW 1TX: 204.174mW Beamforming Mode 4TX: 482.48mW 2TX: 264.316mW 5.18 ~ 5.24GHz: Non-Beamforming Mode: 8TX: 432.724mW 4TX: 430.677mW 2TX: 376.099mW 1TX: 224.905mW Beamforming Mode 8TX: 432.724mW 4TX: 334.441mW 2TX: 376.099mW 5.745 ~ 5.825GHz: Non-Beamforming Mode: 8TX: 412.219mW 4TX: 902.442mW 2TX: 440.884mW 1TX: 238.781mW

Output Power	Beamforming Mode 8TX: 409.847mW 4TX: 338.338mW 2TX: 440.884mW
Antenna Type	Refer to Note
Antenna Connector	Refer to Note
Accessory Device	Adapter x 1 (option)
Data Cable Supplied	NA

Note:

1. The EUT has below radios as following table:

Radio 1	Radio 2	Radio 3	Radio 4
WLAN (2.4GHz)	WLAN (5GHz)	2.4GHz / 5GHz Scanning (only RX)	Bluetooth

2. Simultaneously transmission condition.

Condition	Technology		
1	WLAN (2.4GHz)	WLAN (5GHz)	Bluetooth

Note: The emission of the simultaneous operation has been evaluated and no non-compliance was found.

3. The EUT must be supplied with a power adapter or POE as following table:

Adapter (Option)			
No.	Brand	Model No.	Spec.
1	UMEC	MA-PWR-30W-US	Input: 100-240Vac, 0.8A, 50/60Hz Output: 12Vdc, 2.5A DC Output cable: Unshielded, 1.4m
2	Ktec	KSAS0361200250HU	Input: 100-240Vac, 1.0A, 50/60Hz Output: 12Vdc, 2.5A DC Output cable: Unshielded, 1.8m

POE (Only for test not for sale)

No.	Brand	Model No.	Spec.
1	CISCO	MA-INJ-5	Input: 100-240Vac, 1.5A, 50-60Hz Output: 55Vdc, 0.63A
2	CISCO	MA-INJ-4	Input: 100-240Vac, 0.67A, 50/60Hz Output: 55Vdc, 0.6A

Note:

- From the above conditions, the conducted emissions worse case was found in **POE No. 2**. Therefore only the test data of the mode was recorded in this report.
- From the above conditions, the radiated emissions worse case was found in **Adapter No. 2**. Therefore only the test data of the mode was recorded in this report.

4. The antennas provided to the EUT, please refer to the following table:

WLAN Directional gain table – 8TX				
Frequency range (GHz)	Directional Antenna Gain (dBi)	Antenna Type	Antenna Connector	
5.15 ~ 5.25	9.29	PIFA	i-pex(MHF)	
5.725 ~ 5.85	9.2			
WLAN Directional gain table – 4TX				
Frequency range (GHz)	Antenna Combine Type	Directional Antenna Gain (dBi)	Antenna Type	Antenna Connector
2.4 ~ 2.4835	Dual_1+Dual_2+Dual_3+Dual_4	5.43	PIFA	i-pex(MHF)
5.15 ~ 5.25	Single_1+Single_2+Single_3+Single_4	10.73		
5.725 ~ 5.85		10.68		
WLAN Directional gain table – 2TX				
Frequency range (GHz)	Antenna Combine Type	Directional Antenna Gain (dBi)	Antenna Type	Antenna Connector
2.4 ~ 2.4835	Dual_1+Dual_3	6.33	PIFA	i-pex(MHF)
5.15 ~ 5.25	Dual_2+Dual_3	8.47		
5.725 ~ 5.85		8.59		
Bluetooth antenna spec.				
Antenna Net Gain (dBi)	Frequency range (GHz)	Antenna Type	Antenna Connector	
3.61	2.4~2.4835	PIFA	i-pex(MHF)	
Note: More detailed information, please refer to operating description.				

5. The EUT incorporates a MIMO function.

2.4GHz Band			
MODULATION MODE	DATA RATE (MCS)	TX & RX CONFIGURATION	
802.11b	1 ~ 11Mbps	4TX	4RX
802.11g	6 ~ 54Mbps	4TX	4RX
802.11n (HT20)	MCS 0~7	4TX	4RX
	MCS 8~15	4TX	4RX
	MCS 16~23	4TX	4RX
	MCS 24~31	4TX	4RX
802.11n (HT40)	MCS 0~7	4TX	4RX
	MCS 8~15	4TX	4RX
	MCS 16~23	4TX	4RX
	MCS 24~31	4TX	4RX
VHT20	MCS 0~8, Nss=1	4TX	4RX
	MCS 0~8, Nss=2	4TX	4RX
	MCS 0~9, Nss=3	4TX	4RX
	MCS 0~8, Nss=4	4TX	4RX
VHT40	MCS 0~9, Nss=1	4TX	4RX
	MCS 0~9, Nss=2	4TX	4RX
	MCS 0~9, Nss=3	4TX	4RX
	MCS 0~9, Nss=4	4TX	4RX
802.11ax (HE20)	MCS 0~11, Nss=1	4TX	4RX
	MCS 0~11, Nss=2	4TX	4RX
	MCS 0~11, Nss=3	4TX	4RX
	MCS 0~11, Nss=4	4TX	4RX
802.11ax (HE40)	MCS 0~11, Nss=1	4TX	4RX
	MCS 0~11, Nss=2	4TX	4RX
	MCS 0~11, Nss=3	4TX	4RX
	MCS 0~11, Nss=4	4TX	4RX
5GHz Band			
MODULATION MODE	DATA RATE (MCS)	TX & RX CONFIGURATION	
802.11a	6 ~ 54Mbps	8TX	8RX
802.11n (HT20)	MCS 0~7	8TX	8RX
	MCS 8~15	8TX	8RX
	MCS 16~23	8TX	8RX
	MCS 24~31	8TX	8RX
802.11n (HT40)	MCS 0~7	8TX	8RX
	MCS 8~15	8TX	8RX
	MCS 16~23	8TX	8RX
	MCS 24~31	8TX	8RX
802.11ac (VHT20)	MCS 0~8, Nss=1	8TX	8RX
	MCS 0~8, Nss=2	8TX	8RX
	MCS 0~9, Nss=3	8TX	8RX
	MCS 0~8, Nss=4	8TX	8RX
	MCS 0~8, Nss=5	8TX	8RX
	MCS 0~9, Nss=6	8TX	8RX
	MCS 0~8, Nss=7	8TX	8RX
	MCS 0~8, Nss=8	8TX	8RX
802.11ac (VHT40)	MCS 0~9, Nss=1	8TX	8RX
	MCS 0~9, Nss=2	8TX	8RX
	MCS 0~9, Nss=3	8TX	8RX
	MCS 0~9, Nss=4	8TX	8RX
	MCS 0~9, Nss=5	8TX	8RX
	MCS 0~9, Nss=6	8TX	8RX
	MCS 0~9, Nss=7	8TX	8RX
	MCS 0~9, Nss=8	8TX	8RX

802.11ac (VHT80)	MCS 0~9, Nss=1	8TX	8RX
	MCS 0~9, Nss=2	8TX	8RX
	MCS 0~9, Nss=3	8TX	8RX
	MCS 0~9, Nss=4	8TX	8RX
	MCS 0~9, Nss=5	8TX	8RX
	MCS 0~8, Nss=6	8TX	8RX
	MCS 0~9, Nss=7	8TX	8RX
	MCS 0~9, Nss=8	8TX	8RX
802.11ac (VHT80+VHT80)	MCS 0~9, Nss=1	4TX+4TX	4RX +4RX
	MCS 0~9, Nss=2	4TX+4TX	4RX +4RX
	MCS 0~9, Nss=3	4TX+4TX	4RX +4RX
	MCS 0~9, Nss=4	4TX+4TX	4RX +4RX
802.11ax (HE20)	MCS 0~11, Nss=1	8TX	8RX
	MCS 0~11, Nss=2	8TX	8RX
	MCS 0~11, Nss=3	8TX	8RX
	MCS 0~11, Nss=4	8TX	8RX
	MCS 0~11, Nss=5	8TX	8RX
	MCS 0~11, Nss=6	8TX	8RX
	MCS 0~11, Nss=7	8TX	8RX
	MCS 0~11, Nss=8	8TX	8RX
802.11ax (HE40)	MCS 0~11, Nss=1	8TX	8RX
	MCS 0~11, Nss=2	8TX	8RX
	MCS 0~11, Nss=3	8TX	8RX
	MCS 0~11, Nss=4	8TX	8RX
	MCS 0~11, Nss=5	8TX	8RX
	MCS 0~11, Nss=6	8TX	8RX
	MCS 0~11, Nss=7	8TX	8RX
	MCS 0~11, Nss=8	8TX	8RX
802.11ax (HE80)	MCS 0~11, Nss=1	8TX	8RX
	MCS 0~11, Nss=2	8TX	8RX
	MCS 0~11, Nss=3	8TX	8RX
	MCS 0~11, Nss=4	8TX	8RX
	MCS 0~11, Nss=5	8TX	8RX
	MCS 0~11, Nss=6	8TX	8RX
	MCS 0~11, Nss=7	8TX	8RX
	MCS 0~11, Nss=8	8TX	8RX
802.11ax (HE80+HE80)	MCS 0~11, Nss=1	4TX+4TX	4RX +4RX
	MCS 0~11, Nss=2	4TX+4TX	4RX +4RX
	MCS 0~11, Nss=3	4TX+4TX	4RX +4RX
	MCS 0~11, Nss=4	4TX+4TX	4RX +4RX

Note:

1. All of modulation mode support beamforming function except 802.11a/b/g modulation mode.
2. The EUT support Beamforming and Non-Beamforming mode, therefore both mode were investigated and the worst case scenario was identified. The worst case data were presented in test report.
3. The modulation and bandwidth are similar for 802.11n mode for 20MHz (40MHz) and 802.11ac mode for 20MHz (40MHz), therefore investigated worst case to representative mode in test report. (Final test mode refer section 3.2.1)

2.4GHz Scanning	
MODULATION MODE	RX CONFIGURATION
802.11b	1RX
802.11g	1RX
802.11n (HT20)	1RX
802.11n (HT40)	1RX
VHT20	1RX
VHT40	1RX
5GHz Scanning	
MODULATION MODE	RX CONFIGURATION
802.11a	1RX
802.11n (HT20)	1RX
802.11n (HT40)	1RX
802.11ac (VHT20)	1RX
802.11ac (VHT40)	1RX
802.11ac (VHT80)	1RX

6. The above EUT information is declared by manufacturer and for more detailed features description, please refer to the manufacturer's specifications or user's manual.

3.2 Description of Test Modes

FOR 5180 ~ 5240MHz

4 channels are provided for 802.11a, 802.11n (HT20), 802.11ac (VHT20), 802.11ax (HE20):

Channel	Frequency	Channel	Frequency
36	5180 MHz	44	5220 MHz
40	5200 MHz	48	5240 MHz

2 channels are provided for 802.11n (HT40), 802.11ac (VHT40), 802.11ax (HE40):

Channel	Frequency	Channel	Frequency
38	5190 MHz	46	5230 MHz

1 channel is provided for 802.11ac (VHT80), 802.11ax (HE80):

Channel	Frequency
42	5210 MHz

FOR 5745 ~ 5825MHz:

5 channels are provided for 802.11a, 802.11n (HT20), 802.11ac (VHT20), 802.11ax (HE20):

Channel	Frequency	Channel	Frequency
149	5745 MHz	161	5805 MHz
153	5765 MHz	165	5825 MHz
157	5785 MHz		

2 channels are provided for 802.11n (HT40), 802.11ac (VHT40), 802.11ax (HE40):

Channel	Frequency	Channel	Frequency
151	5755 MHz	159	5795 MHz

1 channel is provided for 802.11ac (VHT80), 802.11ax (HE80):

Channel	Frequency
155	5775 MHz

For simultaneous transmission:

1 set is provided for 802.11ac (VHT80+80), 802.11ax (HE80+80):

Channel	Frequency
42+155	5210MHz + 5775MHz

Note: The transmission is for noncontiguous transmission using two nonadjacent 80MHz channels.

3.2.1 Test Mode Applicability and Tested Channel Detail

EUT Configure Mode	Applicable To				Description
	RE \geq 1G	RE<1G	PLC	APCM	
1	√	√	√	√	8TX (PLC: POE mode; RE: adapter mode)
2	√	-	-	√	4TX (RE: adapter mode)
3	√	-	-	√	2TX (RE: adapter mode)
4	√	-	-	√	1TX (RE: adapter mode)

Where **RE \geq 1G**: Radiated Emission above 1GHz

RE<1G: Radiated Emission below 1GHz

PLC: Power Line Conducted Emission

APCM: Antenna Port Conducted Measurement

Note: 1. The EUT had been pre-tested on the positioned of each 3 axis. The worst case was found when positioned on **X-plane (below 1GHz) & Z-plane (above 1GHz)**.

2. "-" means no effect.

Radiated Emission Test (Above 1GHz):

- Pre-Scan has been conducted to determine the worst-case mode from all possible combinations between available modulations, data rates and antenna ports (if EUT with antenna diversity architecture).
- Following channel(s) was (were) selected for the final test as listed below.

Non-Beamforming Mode						
Mode	FREQ. Band (MHz)	Available Channel	Tested Channel	Modulation Technology	Modulation Type	Data Rate Parameter
802.11a	5180-5240	36 to 48	36, 40, 48	OFDM	BPSK	6Mb/s
802.11ax (HE20)		36 to 48	36, 40, 48	OFDMA	BPSK	MCS0
802.11ax (HE40)		38 to 46	38, 46	OFDMA	BPSK	MCS0
802.11ax (HE80)		42	42	OFDMA	BPSK	MCS0
802.11a	5745-5825	149 to 165	149, 157, 165	OFDM	BPSK	6Mb/s
802.11ax (HE20)		149 to 165	149, 157, 165	OFDMA	BPSK	MCS0
802.11ax (HE40)		151 to 159	151, 159	OFDMA	BPSK	MCS0
802.11ax (HE80)		155	155	OFDMA	BPSK	MCS0
802.11ax (HE80+80) (only 8TX, 4TX)	5180-5240 5745-5825	42 + 155	42 + 155	OFDMA	BPSK	MCS0

Radiated Emission Test (Below 1GHz):

- Pre-Scan has been conducted to determine the worst-case mode from all possible combinations between available modulations, data rates and antenna ports (if EUT with antenna diversity architecture).
- Following channel(s) was (were) selected for the final test as listed below.

Non-Beamforming Mode						
Mode	FREQ. Band (MHz)	Available Channel	Tested Channel	Modulation Technology	Modulation Type	Data Rate (Mbps)
802.11a	5180-5240 5745-5825	36 to 48 149 to 165	165	OFDM	BPSK	6Mb/s

Power Line Conducted Emission Test:

- Pre-Scan has been conducted to determine the worst-case mode from all possible combinations between available modulations, data rates and antenna ports (if EUT with antenna diversity architecture).
- Following channel(s) was (were) selected for the final test as listed below.

Non-Beamforming Mode						
Mode	FREQ. Band (MHz)	Available Channel	Tested Channel	Modulation Technology	Modulation Type	Data Rate (Mbps)
802.11a	5180-5240 5745-5825	36 to 48 149 to 165	165	OFDM	BPSK	6Mb/s

Antenna Port Conducted Measurement:

- This item includes all test value of each mode, but only includes spectrum plot of worst value of each mode.
- Pre-Scan has been conducted to determine the worst-case mode from all possible combinations between available modulations, data rates and antenna ports (if EUT with antenna diversity architecture).
- Following channel(s) was (were) selected for the final test as listed below.

Non-Beamforming Mode						
Mode	FREQ. Band (MHz)	Available Channel	Tested Channel	Modulation Technology	Modulation Type	Data Rate Parameter
802.11a	5180-5240	36 to 48	36, 40, 48	OFDM	BPSK	6Mb/s
802.11ac (VHT20)		36 to 48	36, 40, 48	OFDM	BPSK	MCS0
802.11ac (VHT40)		38 to 46	38, 46	OFDM	BPSK	MCS0
802.11ac (VHT80)		42	42	OFDM	BPSK	MCS0
802.11ax (HE20)		36 to 48	36, 40, 48	OFDMA	BPSK	MCS0
802.11ax (HE40)		38 to 46	38, 46	OFDMA	BPSK	MCS0
802.11ax (HE80)		42	42	OFDMA	BPSK	MCS0
802.11a	5745-5825	149 to 165	149, 157, 165	OFDM	BPSK	6Mb/s
802.11ac (VHT20)		149 to 165	149, 157, 165	OFDM	BPSK	MCS0
802.11ac (VHT40)		151 to 159	151, 159	OFDM	BPSK	MCS0
802.11ac (VHT80)		155	155	OFDM	BPSK	MCS0
802.11ax (HE20)		149 to 165	149, 157, 165	OFDMA	BPSK	MCS0
802.11ax (HE40)		151 to 159	151, 159	OFDMA	BPSK	MCS0
802.11ax (HE80)		155	155	OFDMA	BPSK	MCS0
802.11ac (VHT80+80) (only 8TX, 4TX)	5180-5240 5745-5825	42 + 155	42 + 155	OFDM	BPSK	MCS0
802.11ax (HE80+80) (only 8TX, 4TX)	5180-5240 5745-5825	42 + 155	42 + 155	OFDMA	BPSK	MCS0
Beamforming Mode (output power only)						
Mode	FREQ. Band (MHz)	Available Channel	Tested Channel	Modulation Technology	Modulation Type	Data Rate Parameter
802.11ac (VHT20)	5180-5240	36 to 48	36, 40, 48	OFDM	BPSK	MCS0
802.11ac (VHT40)		38 to 46	38, 46	OFDM	BPSK	MCS0
802.11ac (VHT80)		42	42	OFDM	BPSK	MCS0
802.11ax (HE20)		36 to 48	36, 40, 48	OFDMA	BPSK	MCS0
802.11ax (HE40)		38 to 46	38, 46	OFDMA	BPSK	MCS0
802.11ax (HE80)		42	42	OFDMA	BPSK	MCS0

802.11ac (VHT20)	5745-5825	149 to 165	149, 157, 165	OFDM	BPSK	MCS0
802.11ac (VHT40)		151 to 159	151, 159	OFDM	BPSK	MCS0
802.11ac (VHT80)		155	155	OFDM	BPSK	MCS0
802.11ax (HE20)		149 to 165	149, 157, 165	OFDMA	BPSK	MCS0
802.11ax (HE40)		151 to 159	151, 159	OFDMA	BPSK	MCS0
802.11ax (HE80)		155	155	OFDMA	BPSK	MCS0
802.11ac (VHT80+80) (only 8TX, 4TX)	5180-5240 5745-5825	42 + 155	42 + 155	OFDM	BPSK	MCS0
802.11ax (HE80+80) (only 8TX, 4TX)	5180-5240 5745-5825	42 + 155	42 + 155	OFDMA	BPSK	MCS0

Test Condition:

Applicable To	Environmental Conditions	Input Power	Tested By
RE\geq1G	25deg. C, 69%RH	120Vac, 60Hz	Weiwei Lo
	23deg. C, 68%RH	120Vac, 60Hz	Weiwei Lo
	21deg. C, 66%RH	120Vac, 60Hz	Weiwei Lo
	22deg. C, 67%RH	120Vac, 60Hz	Weiwei Lo
	23deg. C, 69%RH	120Vac, 60Hz	Weiwei Lo
	21deg. C, 68%RH	120Vac, 60Hz	Weiwei Lo
	23deg. C, 66%RH	120Vac, 60Hz	Weiwei Lo
RE$<$1G	22deg. C, 68%RH	120Vac, 60Hz	Frank Chuang
PLC	25deg. C, 75%RH	120Vac, 60Hz	Frank Chuang
APCM	25deg. C, 60%RH	120Vac, 60Hz	Jyunchun Lin

3.3 Duty Cycle of Test Signal

Duty cycle of test signal is < 98%, duty factor shall be considered.

- 802.11a:** Duty cycle = 1.432 ms/1.557 ms = 0.92, Duty factor = $10 * \log(1/\text{Duty cycle}) = 0.36$
- 802.11ac (VHT20):** Duty cycle = 5.418 ms/5.678 ms = 0.954, Duty factor = $10 * \log(1/\text{Duty cycle}) = 0.2$
- 802.11ac (VHT40):** Duty cycle = 5.423 ms/5.7 ms = 0.951, Duty factor = $10 * \log(1/\text{Duty cycle}) = 0.22$
- 802.11ac (VHT80):** Duty cycle = 5.419 ms/5.657 ms = 0.958, Duty factor = $10 * \log(1/\text{Duty cycle}) = 0.19$
- 802.11ac (VHT80+80):** Duty cycle = 5.421/5.888 = 0.921, Duty factor = $10 * \log(1/\text{Duty cycle}) = 0.36$
- 802.11ax (HE20):** Duty cycle = 5.447 ms/5.705 ms = 0.955, Duty factor = $10 * \log(1/\text{Duty cycle}) = 0.2$
- 802.11ax (HE40):** Duty cycle = 5.45 ms/5.655 ms = 0.964, Duty factor = $10 * \log(1/\text{Duty cycle}) = 0.16$
- 802.11ax (HE80):** Duty cycle = 5.447 ms/5.682 ms = 0.959, Duty factor = $10 * \log(1/\text{Duty cycle}) = 0.18$
- 802.11ax (HE80+80):** Duty cycle = 5.448/5.688 = 0.958, Duty factor = $10 * \log(1/\text{Duty cycle}) = 0.19$

802.11a

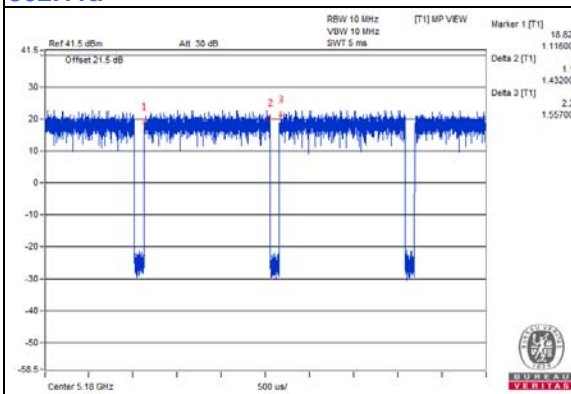

802.11ac (VHT20)

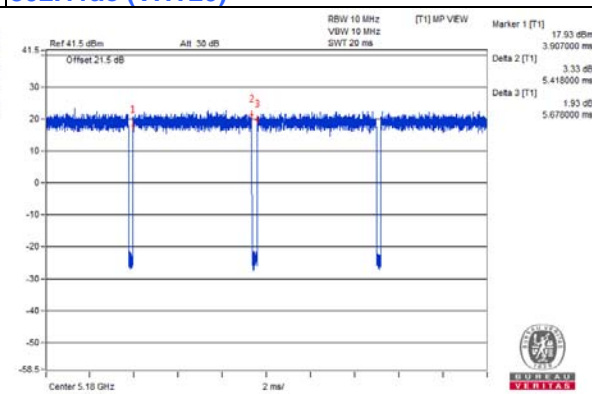

802.11ac (VHT40)

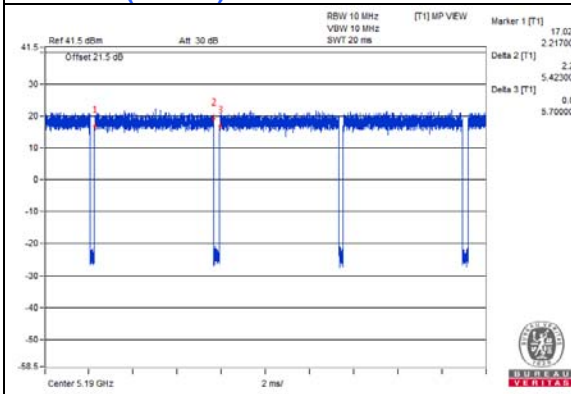

802.11ac (VHT80)

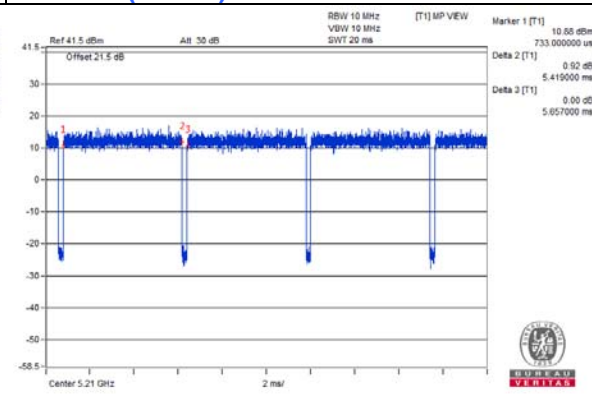

802.11ac (VHT80+80)

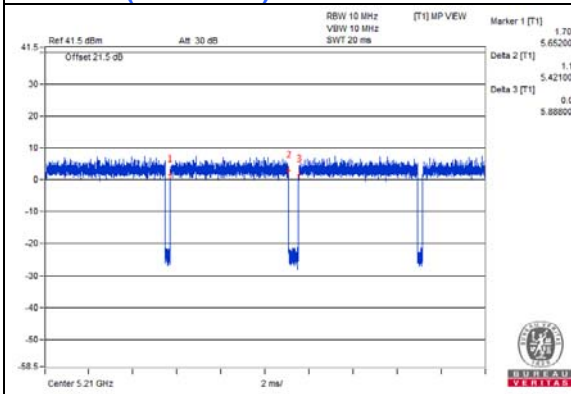

802.11ax (HE20)

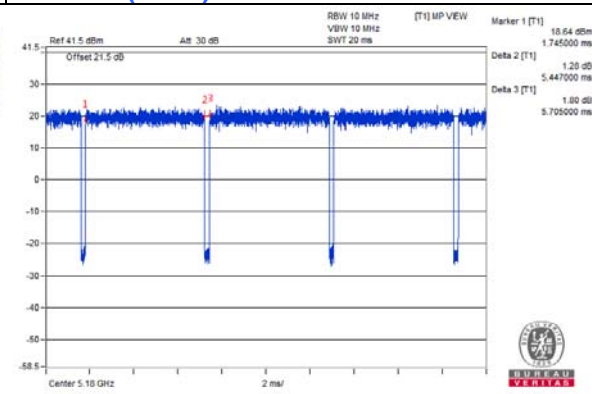

802.11ax (HE40)

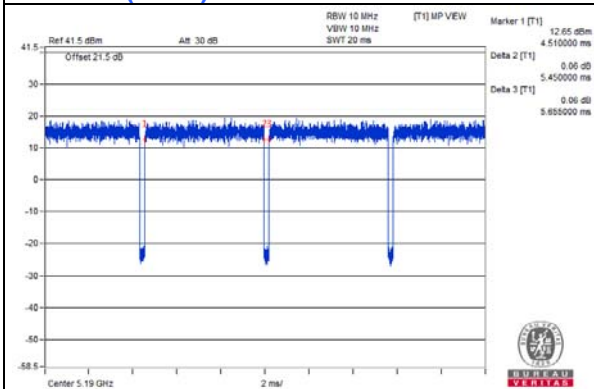

802.11ax (HE80)

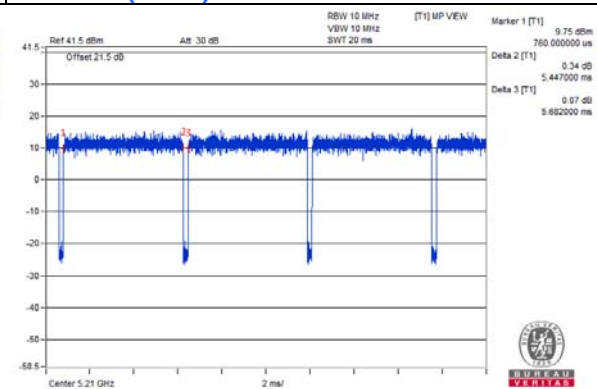

802.11ax (HE80+80)

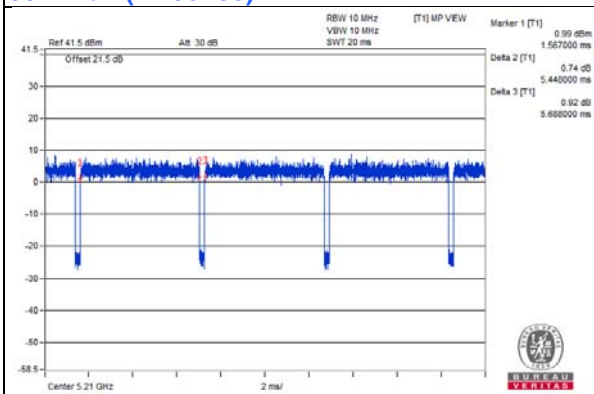

3.4 Description of Support Units

The EUT has been tested as an independent unit together with other necessary accessories or support units. The following support units or accessories were used to form a representative test configuration during the tests.

ID	Product	Brand	Model No.	Serial No.	FCC ID	Remarks
A.	Laptop	DELL	E6420	B92T3R1	FCC DoC	Provided by Lab
B.	POE Adapter	CISCO	MA-INJ-4	NA	NA	Supplied by client

Note:

1. All power cords of the above support units are non-shielded (1.8m).

ID	Descriptions	Qty.	Length (m)	Shielding (Yes/No)	Cores (Qty.)	Remarks
1.	RJ-45 Cable	1	10	No	0	Provided by Lab
2.	DC Cable	1	1.8	No	0	Supplied by client
3.	RJ-45 Cable	1	0.5	No	0	Provided by Lab

3.4.1 Configuration of System under Test

POE mode:

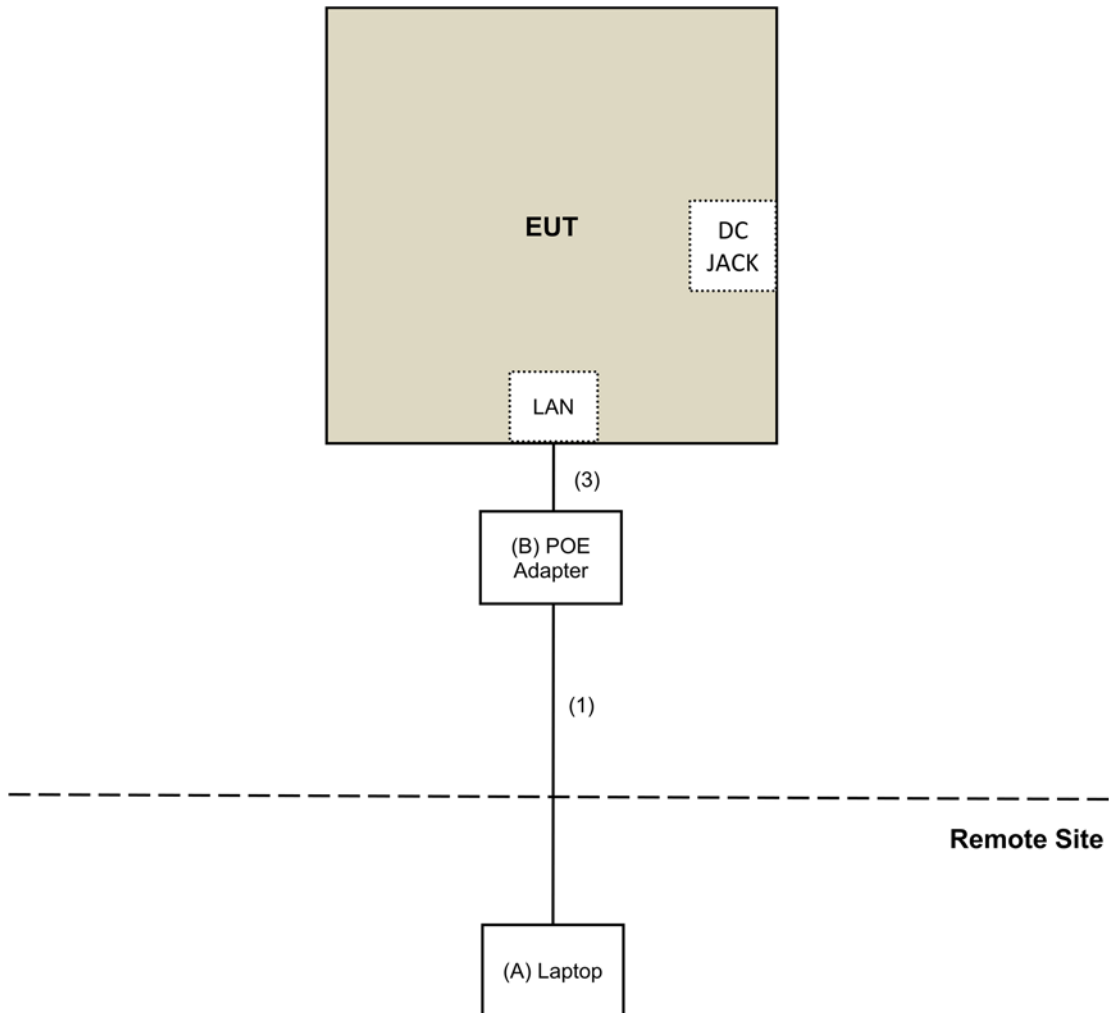

Adapter mode:

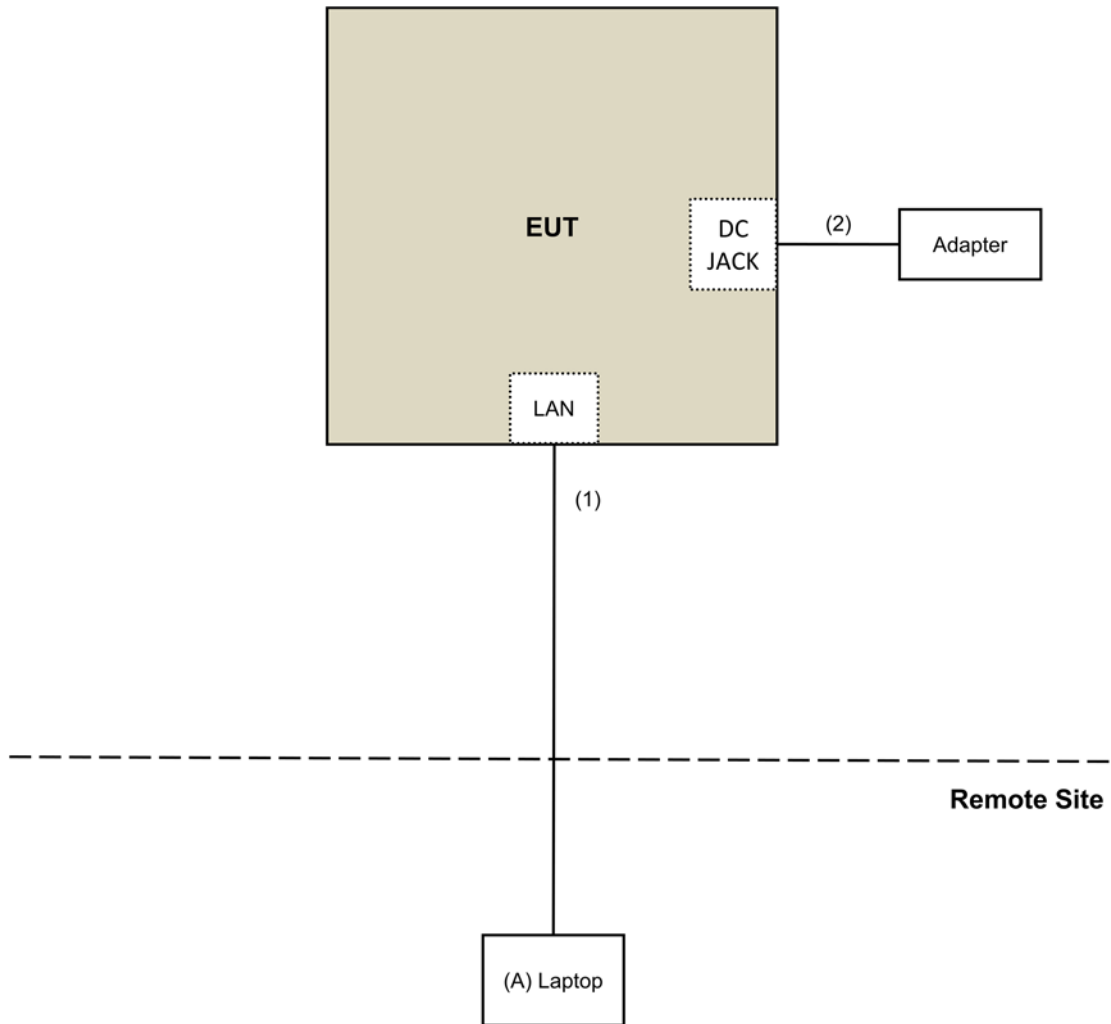

3.5 General Description of Applied Standard

The EUT is a RF Product. According to the specifications of the manufacturer, it must comply with the requirements of the following standards:

FCC Part 15, Subpart E (15.407)

KDB 789033 D02 General UNII Test Procedure New Rules v02r01

KDB 662911 D01 Multiple Transmitter Output v02r01

ANSI C63.10-2013

All test items have been performed and recorded as per the above standards.

4 Test Types and Results

4.1 Radiated Emission and Bandedge Measurement

4.1.1 Limits of Radiated Emission and Bandedge Measurement

Radiated emissions which fall in the restricted bands must comply with the radiated emission limits specified as below table.

Frequencies (MHz)	Field Strength (microvolts/meter)	Measurement Distance (meters)
0.009 ~ 0.490	2400/F(kHz)	300
0.490 ~ 1.705	24000/F(kHz)	30
1.705 ~ 30.0	30	30
30 ~ 88	100	3
88 ~ 216	150	3
216 ~ 960	200	3
Above 960	500	3

NOTE:

- The lower limit shall apply at the transition frequencies.
- Emission level (dBuV/m) = 20 log Emission level (uV/m).
- For frequencies above 1000MHz, the field strength limits are based on average detector, however, the peak field strength of any emission shall not exceed the maximum permitted average limits, specified above by more than 20dB under any condition of modulation.

Limits of unwanted emission out of the restricted bands

Applicable To		Limit	
789033 D02 General UNII Test Procedure New Rules v02r01		Field Strength at 3m	
		PK:74 (dBuV/m)	AV:54 (dBuV/m)
Frequency Band	Applicable To	EIRP Limit	Equivalent Field Strength at 3m
5150~5250 MHz	15.407(b)(1)	PK:-27 (dBm/MHz)	PK:68.2(dBuV/m)
5250~5350 MHz	15.407(b)(2)		
5470~5725 MHz	15.407(b)(3)		
5725~5850 MHz	<input checked="" type="checkbox"/> 15.407(b)(4)(i)	PK:-27 (dBm/MHz) ^{*1} PK:10 (dBm/MHz) ^{*2} PK:15.6 (dBm/MHz) ^{*3} PK:27 (dBm/MHz) ^{*4}	PK: 68.2(dBuV/m) ^{*1} PK:105.2 (dBuV/m) ^{*2} PK: 110.8(dBuV/m) ^{*3} PK:122.2 (dBuV/m) ^{*4}
	<input type="checkbox"/> 15.407(b)(4)(ii)	Emission limits in section 15.247(d)	
^{*1} beyond 75 MHz or more above of the band edge.		^{*2} below the band edge increasing linearly to 10 dBm/MHz at 25 MHz above.	
^{*3} below the band edge increasing linearly to a level of 15.6 dBm/MHz at 5 MHz above.		^{*4} from 5 MHz above or below the band edge increasing linearly to a level of 27 dBm/MHz at the band edge.	

Note:

The following formula is used to convert the equipment isotropic radiated power (eirp) to field strength:

$$E = \frac{1000000\sqrt{30P}}{3} \mu\text{V/m, where } P \text{ is the eirp (Watts).}$$

4.1.2 Test Instruments

For radiated emission test:

DESCRIPTION & MANUFACTURER	MODEL NO.	SERIAL NO.	CALIBRATED DATE	CALIBRATED UNTIL
Test Receiver Agilent	N9038A	MY50010156	July 12, 2018	July 11, 2019
Pre-Amplifier EMCI	EMC001340	980142	Feb. 09, 2018	Feb. 08, 2019
Loop Antenna(*) Electro-Metrics	EM-6879	264	Dec. 16, 2016	Dec. 15, 2018
RF Cable	NA	LOOPCAB-001	Jan. 15, 2018	Jan. 14, 2019
RF Cable	NA	LOOPCAB-002	Jan. 15, 2018	Jan. 14, 2019
Pre-Amplifier Mini-Circuits	ZFL-1000VH2B	AMP-ZFL-05	May 05, 2018	May 04, 2019
Trilog Broadband Antenna SCHWARZBECK	VULB 9168	9168-361	Nov. 29, 2017	Nov. 28, 2018
RF Cable	8D	966-3-1	Mar. 20, 2018	Mar. 19, 2019
RF Cable	8D	966-3-2	Mar. 20, 2018	Mar. 19, 2019
RF Cable	8D	966-3-3	Mar. 20, 2018	Mar. 19, 2019
Fixed attenuator Mini-Circuits	UNAT-5+	PAD-3m-3-01	Oct. 03, 2017	Oct. 02, 2018
Horn_Antenna SCHWARZBECK	BBHA9120-D	9120D-406	Dec. 12, 2017	Dec. 11, 2018
Pre-Amplifier EMCI	EMC12630SE	980384	Jan. 29, 2018	Jan. 28, 2019
RF Cable	EMC104-SM-SM-1200	160922	Jan. 29, 2018	Jan. 28, 2019
RF Cable	EMC104-SM-SM-2000	150317	Jan. 29, 2018	Jan. 28, 2019
RF Cable	EMC104-SM-SM-5000	150322	Jan. 29, 2018	Jan. 28, 2019
Spectrum Analyzer Keysight	N9030A	MY54490679	July 23, 2018	July 22, 2019
Pre-Amplifier EMCI	EMC184045SE	980386	Jan. 29, 2018	Jan. 28, 2019
Horn_Antenna SCHWARZBECK	BBHA 9170	BBHA9170608	Dec. 14, 2017	Dec. 13, 2018
RF Cable	EMC102-KM-KM-1200	160924	Jan. 29, 2018	Jan. 28, 2019
Attenuator STI	STI02-3310-10	013	Feb. 12, 2018	Feb. 11, 2019
Software	ADT_Radiated_V8.7.08	NA	NA	NA
Antenna Tower & Turn Table Max-Full	MF-7802	MF780208406	NA	NA
Boresight Antenna Fixture	FBA-01	FBA-SIP01	NA	NA

Note:

1. The calibration interval of the above test instruments is 12 months and the calibrations are traceable to NML/ROC and NIST/USA.
2. *The calibration interval of the above test instruments is 24 months and the calibrations are traceable to NML/ROC and NIST/USA.
3. The test was performed in 966 Chamber No. 3.
4. The CANADA Site Registration No. is 20331-1
5. Loop antenna was used for all emissions below 30 MHz.
6. Tested Date: Aug. 08 to Sep. 06, 2018

For other test:

DESCRIPTION & MANUFACTURER	MODEL NO.	SERIAL NO.	CALIBRATED DATE	CALIBRATED UNTIL
Spectrum Analyzer R&S	FSV40	100964	June 20, 2018	June 19, 2019
Power meter Anritsu	ML2495A	1014008	May 09, 2018	May 08, 2019
Power sensor Anritsu	MA2411B	0917122	May 09, 2018	May 08, 2019
Attenuator STI	STI02-3310-10	013	Feb. 12, 2018	Feb. 11, 2019
AC Power Source Extech Electronics	6205	1440452	NA	NA
Temperature & Humidity Chamber Giant Force	GTH-150-40-SP- AR	MAA0812-008	Jan. 10, 2018	Jan. 09, 2019
True RMS Clamp Meter FLUKE	325	31130711WS	May 22, 2018	May 21, 2019

- Note:**
1. The test was performed in Oven room 2.
 2. The calibration interval of the above test instruments is 12 months and the calibrations are traceable to NML/ROC and NIST/USA.
 3. Tested Date: Oct. 18 to 19, 2018

4.1.3 Test Procedure

For Radiated emission below 30MHz

- a. The EUT was placed on the top of a rotating table 0.8 meters above the ground at a 3 meter chamber room. The table was rotated 360 degrees to determine the position of the highest radiation.
- b. The EUT was set 3 meters away from the interference-receiving antenna, which was mounted on the top of a variable-height antenna tower.
- c. Parallel, perpendicular, and ground-parallel orientations of the antenna are set to make the measurement.
- d. For each suspected emission, the EUT was arranged to its worst case and the rotatable table was turned from 0 degrees to 360 degrees to find the maximum reading.
- e. The test-receiver system was set to Quasi-Peak Detect Function and Specified Bandwidth with Maximum Hold Mode.

Note:

1. The resolution bandwidth and video bandwidth of test receiver/spectrum analyzer is 9kHz at frequency below 30MHz.

For Radiated emission above 30MHz

- a. The EUT was placed on the top of a rotating table 0.8 meters (for 30MHz ~ 1GHz) / 1.5 meters (for above 1GHz) above the ground at 3 meter chamber room for test. The table was rotated 360 degrees to determine the position of the highest radiation.
- b. The EUT was set 3 meters away from the interference-receiving antenna, which was mounted on the top of a variable-height antenna tower.
- c. The height of antenna is varied from one meter to four meters above the ground to determine the maximum value of the field strength. Both horizontal and vertical polarizations of the antenna are set to make the measurement.
- d. For each suspected emission, the EUT was arranged to its worst case and then the antenna was tuned to heights from 1 meter to 4 meters and the rotatable table was turned from 0 degrees to 360 degrees to find the maximum reading.
- e. The test-receiver system was set to quasi-peak detect function and specified bandwidth with maximum hold mode when the test frequency is below 1 GHz.
- f. The test-receiver system was set to peak and average detects function and specified bandwidth with maximum hold mode when the test frequency is above 1 GHz. If the peak reading value also meets average limit, measurement with the average detector is unnecessary.

Note:

1. The resolution bandwidth and video bandwidth of test receiver/spectrum analyzer is 120kHz for Quasi-peak detection (QP) at frequency below 1GHz.
2. The resolution bandwidth of test receiver/spectrum analyzer is 1 MHz and the video bandwidth is 3 MHz for Peak detection (PK) at frequency above 1GHz.
3. The resolution bandwidth of test receiver/spectrum analyzer is 1MHz and the video bandwidth is $\geq 1/T$ (Duty cycle < 98%) or 10Hz (Duty cycle $\geq 98\%$) for Average detection (AV) at frequency above 1GHz.
4. All modes of operation were investigated and the worst-case emissions are reported.

4.1.4 Deviation from Test Standard

No deviation.

4.1.5 Test Setup

For Radiated emission below 30MHz

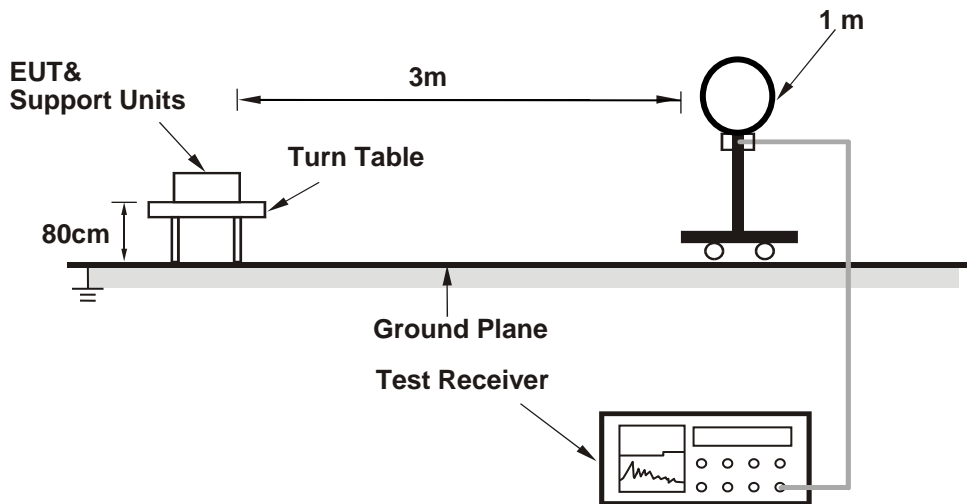

For Radiated emission 30MHz to 1GHz

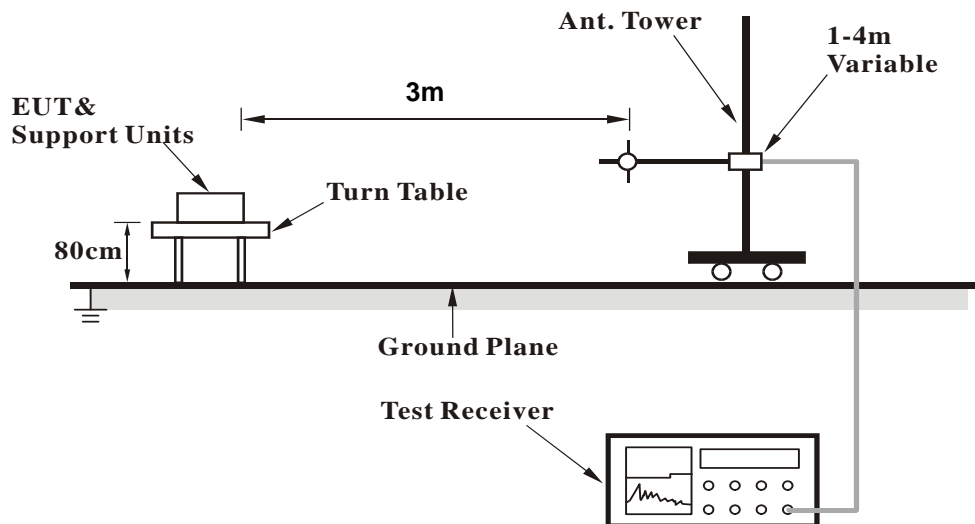

For Radiated emission above 1GHz

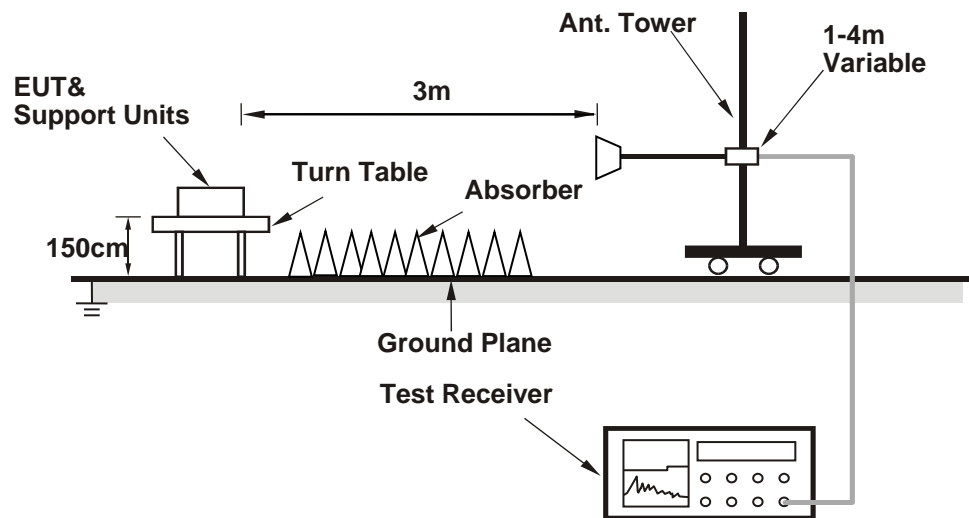

For the actual test configuration, please refer to the attached file (Test Setup Photo).

4.1.6 EUT Operating Condition

- a. Connected the EUT with the Laptop which is placed on remote site.
- b. Controlling software (QSPR (5.0-00161)) has been activated to set the EUT on specific status.

4.1.7 Test Results (Mode 1)

Above 1GHz Data:

802.11a

CHANNEL	TX Channel 36	DETECTOR FUNCTION	Peak (PK)
FREQUENCY RANGE	1GHz ~ 40GHz		Average (AV)

ANTENNA POLARITY & TEST DISTANCE: HORIZONTAL AT 3 M								
NO.	FREQ. (MHz)	EMISSION LEVEL (dBuV/m)	LIMIT (dBuV/m)	MARGIN (dB)	ANTENNA HEIGHT (m)	TABLE ANGLE (Degree)	RAW VALUE (dBuV)	CORRECTION FACTOR (dB/m)
1	5150.00	61.4 PK	74.0	-12.6	1.79 H	237	58.8	2.6
2	5150.00	49.7 AV	54.0	-4.3	1.79 H	237	47.1	2.6
3	*5180.00	122.0 PK			1.79 H	237	119.5	2.5
4	*5180.00	109.9 AV			1.79 H	237	107.4	2.5
5	#10360.00	51.6 PK	68.2	-16.6	2.34 H	226	39.7	11.9
6	15540.00	53.0 PK	74.0	-21.0	1.60 H	319	40.6	12.4
7	15540.00	40.8 AV	54.0	-13.2	1.60 H	319	28.4	12.4

ANTENNA POLARITY & TEST DISTANCE: VERTICAL AT 3 M								
NO.	FREQ. (MHz)	EMISSION LEVEL (dBuV/m)	LIMIT (dBuV/m)	MARGIN (dB)	ANTENNA HEIGHT (m)	TABLE ANGLE (Degree)	RAW VALUE (dBuV)	CORRECTION FACTOR (dB/m)
1	5150.00	59.8 PK	74.0	-14.2	1.28 V	289	57.2	2.6
2	5150.00	47.9 AV	54.0	-6.1	1.28 V	289	45.3	2.6
3	*5180.00	121.4 PK			1.28 V	289	118.9	2.5
4	*5180.00	109.2 AV			1.28 V	289	106.7	2.5
5	#10360.00	51.9 PK	68.2	-16.3	1.54 V	266	40.0	11.9
6	15540.00	53.2 PK	74.0	-20.8	1.55 V	18	40.8	12.4
7	15540.00	40.7 AV	54.0	-13.3	1.55 V	18	28.3	12.4

REMARKS:

1. Emission Level(dBuV/m) = Raw Value(dBuV) + Correction Factor(dB/m)
2. Correction Factor(dB/m) = Antenna Factor(dB/m) + Cable Factor(dB) – Pre-Amplifier Factor(dB)
3. The other emission levels were very low against the limit.
4. Margin value = Emission Level – Limit value
5. " * ": Fundamental frequency.
6. " # ": The radiated frequency is out of the restricted band.

CHANNEL	TX Channel 40	DETECTOR FUNCTION	Peak (PK)
FREQUENCY RANGE	1GHz ~ 40GHz		Average (AV)

ANTENNA POLARITY & TEST DISTANCE: HORIZONTAL AT 3 M

NO.	FREQ. (MHz)	EMISSION LEVEL (dBuV/m)	LIMIT (dBuV/m)	MARGIN (dB)	ANTENNA HEIGHT (m)	TABLE ANGLE (Degree)	RAW VALUE (dBuV)	CORRECTION FACTOR (dB/m)
1	5150.00	54.6 PK	74.0	-19.4	1.56 H	256	52.0	2.6
2	5150.00	44.3 AV	54.0	-9.7	1.56 H	256	41.7	2.6
3	*5200.00	120.8 PK			1.56 H	256	118.4	2.4
4	*5200.00	109.5 AV			1.56 H	256	107.1	2.4
5	5376.00	53.7 PK	74.0	-20.3	1.56 H	256	51.3	2.4
6	5376.00	42.2 AV	54.0	-11.8	1.56 H	256	39.8	2.4
7	#10400.00	52.8 PK	68.2	-15.4	2.42 H	199	40.6	12.2
8	15600.00	53.2 PK	74.0	-20.8	1.56 H	311	40.3	12.9
9	15600.00	40.5 AV	54.0	-13.5	1.56 H	311	27.6	12.9

ANTENNA POLARITY & TEST DISTANCE: VERTICAL AT 3 M

NO.	FREQ. (MHz)	EMISSION LEVEL (dBuV/m)	LIMIT (dBuV/m)	MARGIN (dB)	ANTENNA HEIGHT (m)	TABLE ANGLE (Degree)	RAW VALUE (dBuV)	CORRECTION FACTOR (dB/m)
1	5150.00	53.0 PK	74.0	-21.0	1.26 V	299	50.4	2.6
2	5150.00	42.5 AV	54.0	-11.5	1.26 V	299	39.9	2.6
3	*5200.00	120.2 PK			1.26 V	299	117.8	2.4
4	*5200.00	108.8 AV			1.26 V	299	106.4	2.4
5	5376.00	52.1 PK	74.0	-21.9	1.26 V	299	49.7	2.4
6	5376.00	40.4 AV	54.0	-13.6	1.26 V	299	38.0	2.4
7	#10400.00	53.1 PK	68.2	-15.1	1.58 V	258	40.9	12.2
8	15600.00	53.4 PK	74.0	-20.6	1.53 V	19	40.5	12.9
9	15600.00	40.4 AV	54.0	-13.6	1.53 V	19	27.5	12.9

REMARKS:

1. Emission Level(dBuV/m) = Raw Value(dBuV) + Correction Factor(dB/m)
2. Correction Factor(dB/m) = Antenna Factor(dB/m) + Cable Factor(dB) – Pre-Amplifier Factor(dB)
3. The other emission levels were very low against the limit.
4. Margin value = Emission Level – Limit value
5. " * ": Fundamental frequency.
6. " # ": The radiated frequency is out of the restricted band.

CHANNEL	TX Channel 48	DETECTOR FUNCTION	Peak (PK)
FREQUENCY RANGE	1GHz ~ 40GHz		Average (AV)

ANTENNA POLARITY & TEST DISTANCE: HORIZONTAL AT 3 M

NO.	FREQ. (MHz)	EMISSION LEVEL (dBuV/m)	LIMIT (dBuV/m)	MARGIN (dB)	ANTENNA HEIGHT (m)	TABLE ANGLE (Degree)	RAW VALUE (dBuV)	CORRECTION FACTOR (dB/m)
1	*5240.00	122.4 PK			1.90 H	269	120.2	2.2
2	*5240.00	109.2 AV			1.90 H	269	107.0	2.2
3	5350.00	55.7 PK	74.0	-18.3	1.90 H	269	53.4	2.3
4	5350.00	46.5 AV	54.0	-7.5	1.90 H	269	44.2	2.3
5	#10480.00	52.3 PK	68.2	-15.9	2.37 H	221	39.9	12.4
6	15720.00	52.7 PK	74.0	-21.3	1.54 H	301	40.7	12.0
7	15720.00	40.6 AV	54.0	-13.4	1.54 H	301	28.6	12.0

ANTENNA POLARITY & TEST DISTANCE: VERTICAL AT 3 M

NO.	FREQ. (MHz)	EMISSION LEVEL (dBuV/m)	LIMIT (dBuV/m)	MARGIN (dB)	ANTENNA HEIGHT (m)	TABLE ANGLE (Degree)	RAW VALUE (dBuV)	CORRECTION FACTOR (dB/m)
1	*5240.00	121.8 PK			1.35 V	291	119.6	2.2
2	*5240.00	108.5 AV			1.35 V	291	106.3	2.2
3	5350.00	54.1 PK	74.0	-19.9	1.35 V	291	51.8	2.3
4	5350.00	44.7 AV	54.0	-9.3	1.35 V	291	42.4	2.3
5	#10480.00	52.6 PK	68.2	-15.6	1.53 V	261	40.2	12.4
6	15720.00	52.9 PK	74.0	-21.1	1.51 V	18	40.9	12.0
7	15720.00	40.5 AV	54.0	-13.5	1.51 V	18	28.5	12.0

REMARKS:

1. Emission Level(dBuV/m) = Raw Value(dBuV) + Correction Factor(dB/m)
2. Correction Factor(dB/m) = Antenna Factor(dB/m) + Cable Factor(dB) – Pre-Amplifier Factor(dB)
3. The other emission levels were very low against the limit.
4. Margin value = Emission Level – Limit value
5. " * ": Fundamental frequency.
6. " # ": The radiated frequency is out of the restricted band.

CHANNEL	TX Channel 149	DETECTOR FUNCTION	Peak (PK)
FREQUENCY RANGE	1GHz ~ 40GHz		Average (AV)

ANTENNA POLARITY & TEST DISTANCE: HORIZONTAL AT 3 M

NO.	FREQ. (MHz)	EMISSION LEVEL (dBuV/m)	LIMIT (dBuV/m)	MARGIN (dB)	ANTENNA HEIGHT (m)	TABLE ANGLE (Degree)	RAW VALUE (dBuV)	CORRECTION FACTOR (dB/m)
1	#5648.99	59.4 PK	68.2	-8.8	1.42 H	293	56.7	2.7
2	*5745.00	120.0 PK			1.42 H	293	117.1	2.9
3	*5745.00	111.1 AV			1.42 H	293	108.2	2.9
4	#5955.67	57.8 PK	68.2	-10.4	1.42 H	293	54.6	3.2
5	11490.00	51.5 PK	74.0	-22.5	2.37 H	226	39.2	12.3
6	11490.00	44.7 AV	54.0	-9.3	2.37 H	226	32.4	12.3
7	#17235.00	52.0 PK	68.2	-16.2	1.55 H	321	36.7	15.3

ANTENNA POLARITY & TEST DISTANCE: VERTICAL AT 3 M

NO.	FREQ. (MHz)	EMISSION LEVEL (dBuV/m)	LIMIT (dBuV/m)	MARGIN (dB)	ANTENNA HEIGHT (m)	TABLE ANGLE (Degree)	RAW VALUE (dBuV)	CORRECTION FACTOR (dB/m)
1	#5612.32	57.7 PK	68.2	-10.5	1.32 V	284	54.9	2.8
2	*5745.00	119.4 PK			1.32 V	284	116.5	2.9
3	*5745.00	110.4 AV			1.32 V	284	107.5	2.9
4	#5970.09	57.5 PK	68.2	-10.7	1.32 V	284	54.3	3.2
5	11490.00	51.8 PK	74.0	-22.2	1.47 V	263	39.5	12.3
6	11490.00	45.2 AV	54.0	-8.8	1.47 V	263	32.9	12.3
7	#17235.00	52.2 PK	68.2	-16.0	1.59 V	10	36.9	15.3

REMARKS:

1. Emission Level(dBuV/m) = Raw Value(dBuV) + Correction Factor(dB/m)
2. Correction Factor(dB/m) = Antenna Factor(dB/m) + Cable Factor(dB) – Pre-Amplifier Factor(dB)
3. The other emission levels were very low against the limit.
4. Margin value = Emission Level – Limit value
5. " * ": Fundamental frequency.
6. " # ": The radiated frequency is out of the restricted band.

CHANNEL	TX Channel 157	DETECTOR FUNCTION	Peak (PK)
FREQUENCY RANGE	1GHz ~ 40GHz		Average (AV)

ANTENNA POLARITY & TEST DISTANCE: HORIZONTAL AT 3 M

NO.	FREQ. (MHz)	EMISSION LEVEL (dBuV/m)	LIMIT (dBuV/m)	MARGIN (dB)	ANTENNA HEIGHT (m)	TABLE ANGLE (Degree)	RAW VALUE (dBuV)	CORRECTION FACTOR (dB/m)
1	#5600.81	59.5 PK	68.2	-8.7	1.89 H	261	56.7	2.8
2	*5785.00	120.9 PK			1.89 H	261	117.8	3.1
3	*5785.00	112.5 AV			1.89 H	261	109.4	3.1
4	#5978.89	58.7 PK	68.2	-9.5	1.89 H	261	55.5	3.2
5	11570.00	51.8 PK	74.0	-22.2	2.45 H	214	39.4	12.4
6	11570.00	44.6 AV	54.0	-9.4	2.45 H	214	32.2	12.4
7	#17355.00	52.7 PK	68.2	-15.5	1.57 H	328	36.7	16.0

ANTENNA POLARITY & TEST DISTANCE: VERTICAL AT 3 M

NO.	FREQ. (MHz)	EMISSION LEVEL (dBuV/m)	LIMIT (dBuV/m)	MARGIN (dB)	ANTENNA HEIGHT (m)	TABLE ANGLE (Degree)	RAW VALUE (dBuV)	CORRECTION FACTOR (dB/m)
1	#5590.58	57.9 PK	68.2	-10.3	1.88 V	289	55.1	2.8
2	*5785.00	119.6 PK			1.88 V	289	116.5	3.1
3	*5785.00	111.0 AV			1.88 V	289	107.9	3.1
4	#5977.94	56.9 PK	68.2	-11.3	1.88 V	289	53.7	3.2
5	11570.00	52.1 PK	74.0	-21.9	1.50 V	259	39.7	12.4
6	11570.00	45.1 AV	54.0	-8.9	1.50 V	259	32.7	12.4
7	#17355.00	52.9 PK	68.2	-15.3	1.51 V	10	36.9	16.0

REMARKS:

1. Emission Level(dBuV/m) = Raw Value(dBuV) + Correction Factor(dB/m)
2. Correction Factor(dB/m) = Antenna Factor(dB/m) + Cable Factor(dB) – Pre-Amplifier Factor(dB)
3. The other emission levels were very low against the limit.
4. Margin value = Emission Level – Limit value
5. " * ": Fundamental frequency.
6. " # ": The radiated frequency is out of the restricted band.

CHANNEL	TX Channel 165	DETECTOR FUNCTION	Peak (PK)
FREQUENCY RANGE	1GHz ~ 40GHz		Average (AV)

ANTENNA POLARITY & TEST DISTANCE: HORIZONTAL AT 3 M

NO.	FREQ. (MHz)	EMISSION LEVEL (dBuV/m)	LIMIT (dBuV/m)	MARGIN (dB)	ANTENNA HEIGHT (m)	TABLE ANGLE (Degree)	RAW VALUE (dBuV)	CORRECTION FACTOR (dB/m)
1	#5607.82	58.8 PK	68.2	-9.4	1.45 H	287	56.0	2.8
2	*5825.00	120.2 PK			1.45 H	287	117.0	3.2
3	*5825.00	111.2 AV			1.45 H	287	108.0	3.2
4	#5928.55	57.9 PK	68.2	-10.3	1.45 H	287	54.5	3.4
5	11650.00	52.1 PK	74.0	-21.9	2.38 H	213	39.7	12.4
6	11650.00	45.0 AV	54.0	-9.0	2.38 H	213	32.6	12.4
7	#17475.00	51.9 PK	68.2	-16.3	1.54 H	311	34.5	17.4

ANTENNA POLARITY & TEST DISTANCE: VERTICAL AT 3 M

NO.	FREQ. (MHz)	EMISSION LEVEL (dBuV/m)	LIMIT (dBuV/m)	MARGIN (dB)	ANTENNA HEIGHT (m)	TABLE ANGLE (Degree)	RAW VALUE (dBuV)	CORRECTION FACTOR (dB/m)
1	#5646.38	57.6 PK	68.2	-10.6	1.37 V	263	54.9	2.7
2	*5825.00	119.0 PK			1.37 V	263	115.8	3.2
3	*5825.00	110.2 AV			1.37 V	263	107.0	3.2
4	#5962.00	57.3 PK	68.2	-10.9	1.37 V	263	54.0	3.3
5	11650.00	52.4 PK	74.0	-21.6	1.52 V	263	40.0	12.4
6	11650.00	45.5 AV	54.0	-8.5	1.52 V	263	33.1	12.4
7	#17475.00	52.1 PK	68.2	-16.1	1.60 V	16	34.7	17.4

REMARKS:

- Emission Level(dBuV/m) = Raw Value(dBuV) + Correction Factor(dB/m)
- Correction Factor(dB/m) = Antenna Factor(dB/m) + Cable Factor(dB) – Pre-Amplifier Factor(dB)
- The other emission levels were very low against the limit.
- Margin value = Emission Level – Limit value
- " * ": Fundamental frequency.
- " # ": The radiated frequency is out of the restricted band.

802.11ax (HE20)

CHANNEL	TX Channel 36	DETECTOR FUNCTION	Peak (PK)
FREQUENCY RANGE	1GHz ~ 40GHz		Average (AV)

ANTENNA POLARITY & TEST DISTANCE: HORIZONTAL AT 3 M

NO.	FREQ. (MHz)	EMISSION LEVEL (dBuV/m)	LIMIT (dBuV/m)	MARGIN (dB)	ANTENNA HEIGHT (m)	TABLE ANGLE (Degree)	RAW VALUE (dBuV)	CORRECTION FACTOR (dB/m)
1	5150.00	62.0 PK	74.0	-12.0	1.74 H	239	59.4	2.6
2	5150.00	50.2 AV	54.0	-3.8	1.74 H	239	47.6	2.6
3	*5180.00	122.3 PK			1.74 H	239	119.8	2.5
4	*5180.00	110.2 AV			1.74 H	239	107.7	2.5
5	#10360.00	51.6 PK	68.2	-16.6	2.39 H	218	39.7	11.9
6	15540.00	52.7 PK	74.0	-21.3	1.58 H	331	40.3	12.4
7	15540.00	40.1 AV	54.0	-13.9	1.58 H	331	27.7	12.4

ANTENNA POLARITY & TEST DISTANCE: VERTICAL AT 3 M

NO.	FREQ. (MHz)	EMISSION LEVEL (dBuV/m)	LIMIT (dBuV/m)	MARGIN (dB)	ANTENNA HEIGHT (m)	TABLE ANGLE (Degree)	RAW VALUE (dBuV)	CORRECTION FACTOR (dB/m)
1	5150.00	60.4 PK	74.0	-13.6	1.33 V	272	57.8	2.6
2	5150.00	48.4 AV	54.0	-5.6	1.33 V	272	45.8	2.6
3	*5180.00	121.7 PK			1.33 V	272	119.2	2.5
4	*5180.00	109.5 AV			1.33 V	272	107.0	2.5
5	#10360.00	51.9 PK	68.2	-16.3	1.54 V	269	40.0	11.9
6	15540.00	52.9 PK	74.0	-21.1	1.54 V	12	40.5	12.4
7	15540.00	40.0 AV	54.0	-14.0	1.54 V	12	27.6	12.4

REMARKS:

1. Emission Level(dBuV/m) = Raw Value(dBuV) + Correction Factor(dB/m)
2. Correction Factor(dB/m) = Antenna Factor(dB/m) + Cable Factor(dB) – Pre-Amplifier Factor(dB)
3. The other emission levels were very low against the limit.
4. Margin value = Emission Level – Limit value
5. " * ": Fundamental frequency.
6. " # ": The radiated frequency is out of the restricted band.

CHANNEL	TX Channel 40	DETECTOR FUNCTION	Peak (PK)
FREQUENCY RANGE	1GHz ~ 40GHz		Average (AV)

ANTENNA POLARITY & TEST DISTANCE: HORIZONTAL AT 3 M

NO.	FREQ. (MHz)	EMISSION LEVEL (dBuV/m)	LIMIT (dBuV/m)	MARGIN (dB)	ANTENNA HEIGHT (m)	TABLE ANGLE (Degree)	RAW VALUE (dBuV)	CORRECTION FACTOR (dB/m)
1	5150.00	54.9 PK	74.0	-19.1	1.61 H	260	52.3	2.6
2	5150.00	44.6 AV	54.0	-9.4	1.61 H	260	42.0	2.6
3	*5200.00	121.2 PK			1.61 H	260	118.8	2.4
4	*5200.00	109.8 AV			1.61 H	260	107.4	2.4
5	5376.00	53.8 PK	74.0	-20.2	1.61 H	260	51.4	2.4
6	5376.00	42.1 AV	54.0	-11.9	1.61 H	260	39.7	2.4
7	#10400.00	52.2 PK	68.2	-16.0	2.42 H	208	40.0	12.2
8	15600.00	52.6 PK	74.0	-21.4	1.53 H	319	39.7	12.9
9	15600.00	40.2 AV	54.0	-13.8	1.53 H	319	27.3	12.9

ANTENNA POLARITY & TEST DISTANCE: VERTICAL AT 3 M

NO.	FREQ. (MHz)	EMISSION LEVEL (dBuV/m)	LIMIT (dBuV/m)	MARGIN (dB)	ANTENNA HEIGHT (m)	TABLE ANGLE (Degree)	RAW VALUE (dBuV)	CORRECTION FACTOR (dB/m)
1	5150.00	53.3 PK	74.0	-20.7	1.37 V	282	50.7	2.6
2	5150.00	42.8 AV	54.0	-11.2	1.37 V	282	40.2	2.6
3	*5200.00	120.6 PK			1.37 V	282	118.2	2.4
4	*5200.00	109.1 AV			1.37 V	282	106.7	2.4
5	5376.00	52.2 PK	74.0	-21.8	1.37 V	282	49.8	2.4
6	5376.00	40.3 AV	54.0	-13.7	1.37 V	282	37.9	2.4
7	#10400.00	52.5 PK	68.2	-15.7	1.55 V	262	40.3	12.2
8	15600.00	52.8 PK	74.0	-21.2	1.59 V	27	39.9	12.9
9	15600.00	40.1 AV	54.0	-13.9	1.59 V	27	27.2	12.9

REMARKS:

1. Emission Level(dBuV/m) = Raw Value(dBuV) + Correction Factor(dB/m)
2. Correction Factor(dB/m) = Antenna Factor(dB/m) + Cable Factor(dB) – Pre-Amplifier Factor(dB)
3. The other emission levels were very low against the limit.
4. Margin value = Emission Level – Limit value
5. " * ": Fundamental frequency.
6. " # ": The radiated frequency is out of the restricted band.

CHANNEL	TX Channel 48	DETECTOR FUNCTION	Peak (PK)
FREQUENCY RANGE	1GHz ~ 40GHz		Average (AV)

ANTENNA POLARITY & TEST DISTANCE: HORIZONTAL AT 3 M

NO.	FREQ. (MHz)	EMISSION LEVEL (dBuV/m)	LIMIT (dBuV/m)	MARGIN (dB)	ANTENNA HEIGHT (m)	TABLE ANGLE (Degree)	RAW VALUE (dBuV)	CORRECTION FACTOR (dB/m)
1	*5240.00	122.6 PK			1.91 H	280	120.4	2.2
2	*5240.00	109.6 AV			1.91 H	280	107.4	2.2
3	5375.00	54.9 PK	74.0	-19.1	1.91 H	280	52.5	2.4
4	5375.00	46.0 AV	54.0	-8.0	1.91 H	280	43.6	2.4
5	#10480.00	50.5 PK	68.2	-17.7	1.49 H	64	38.1	12.4
6	15720.00	53.1 PK	74.0	-20.9	1.55 H	320	41.1	12.0
7	15720.00	40.7 AV	54.0	-13.3	1.55 H	320	28.7	12.0

ANTENNA POLARITY & TEST DISTANCE: VERTICAL AT 3 M

NO.	FREQ. (MHz)	EMISSION LEVEL (dBuV/m)	LIMIT (dBuV/m)	MARGIN (dB)	ANTENNA HEIGHT (m)	TABLE ANGLE (Degree)	RAW VALUE (dBuV)	CORRECTION FACTOR (dB/m)
1	*5240.00	122.0 PK			1.29 V	281	119.8	2.2
2	*5240.00	108.9 AV			1.29 V	281	106.7	2.2
3	5350.00	53.3 PK	74.0	-20.7	1.29 V	281	51.0	2.3
4	5350.00	44.2 AV	54.0	-9.8	1.29 V	281	41.9	2.3
5	#10480.00	50.9 PK	68.2	-17.3	1.53 V	264	38.5	12.4
6	15720.00	53.1 PK	74.0	-20.9	1.55 V	12	41.1	12.0
7	15720.00	40.4 AV	54.0	-13.6	1.55 V	12	28.4	12.0

REMARKS:

1. Emission Level(dBuV/m) = Raw Value(dBuV) + Correction Factor(dB/m)
2. Correction Factor(dB/m) = Antenna Factor(dB/m) + Cable Factor(dB) – Pre-Amplifier Factor(dB)
3. The other emission levels were very low against the limit.
4. Margin value = Emission Level – Limit value
5. " * ": Fundamental frequency.
6. " # ": The radiated frequency is out of the restricted band.

CHANNEL	TX Channel 149	DETECTOR FUNCTION	Peak (PK)
FREQUENCY RANGE	1GHz ~ 40GHz		Average (AV)

ANTENNA POLARITY & TEST DISTANCE: HORIZONTAL AT 3 M

NO.	FREQ. (MHz)	EMISSION LEVEL (dBuV/m)	LIMIT (dBuV/m)	MARGIN (dB)	ANTENNA HEIGHT (m)	TABLE ANGLE (Degree)	RAW VALUE (dBuV)	CORRECTION FACTOR (dB/m)
1	#5641.06	58.5 PK	68.2	-9.7	2.20 H	237	59.3	-0.8
2	*5745.00	119.0 PK			2.20 H	237	116.1	2.9
3	*5745.00	107.7 AV			2.20 H	237	104.8	2.9
4	#5984.33	57.8 PK	68.2	-10.4	2.20 H	237	58.0	-0.2
5	11490.00	51.3 PK	74.0	-22.7	2.36 H	218	39.0	12.3
6	11490.00	44.4 AV	54.0	-9.6	2.36 H	218	32.1	12.3
7	#17235.00	52.1 PK	68.2	-16.1	1.57 H	316	36.8	15.3

ANTENNA POLARITY & TEST DISTANCE: VERTICAL AT 3 M

NO.	FREQ. (MHz)	EMISSION LEVEL (dBuV/m)	LIMIT (dBuV/m)	MARGIN (dB)	ANTENNA HEIGHT (m)	TABLE ANGLE (Degree)	RAW VALUE (dBuV)	CORRECTION FACTOR (dB/m)
1	#5647.76	59.3 PK	68.2	-8.9	1.53 V	253	56.6	2.7
2	*5745.00	120.3 PK			1.53 V	253	117.4	2.9
3	*5745.00	107.5 AV			1.53 V	253	104.6	2.9
4	#5929.42	57.4 PK	68.2	-10.8	1.53 V	253	54.0	3.4
5	11490.00	51.6 PK	74.0	-22.4	1.58 V	265	39.3	12.3
6	11490.00	44.9 AV	54.0	-9.1	1.58 V	265	32.6	12.3
7	#17235.00	52.3 PK	68.2	-15.9	1.56 V	17	37.0	15.3

REMARKS:

1. Emission Level(dBuV/m) = Raw Value(dBuV) + Correction Factor(dB/m)
2. Correction Factor(dB/m) = Antenna Factor(dB/m) + Cable Factor(dB) – Pre-Amplifier Factor(dB)
3. The other emission levels were very low against the limit.
4. Margin value = Emission Level – Limit value
5. " * ": Fundamental frequency.
6. " # ": The radiated frequency is out of the restricted band.

CHANNEL	TX Channel 157	DETECTOR FUNCTION	Peak (PK)
FREQUENCY RANGE	1GHz ~ 40GHz		Average (AV)

ANTENNA POLARITY & TEST DISTANCE: HORIZONTAL AT 3 M

NO.	FREQ. (MHz)	EMISSION LEVEL (dBuV/m)	LIMIT (dBuV/m)	MARGIN (dB)	ANTENNA HEIGHT (m)	TABLE ANGLE (Degree)	RAW VALUE (dBuV)	CORRECTION FACTOR (dB/m)
1	#5642.06	58.0 PK	68.2	-10.2	1.75 H	268	55.3	2.7
2	*5785.00	120.8 PK			1.75 H	268	117.7	3.1
3	*5785.00	108.4 AV			1.75 H	268	105.3	3.1
4	#5976.68	58.2 PK	68.2	-10.0	1.75 H	268	55.0	3.2
5	11570.00	51.2 PK	74.0	-22.8	2.40 H	207	38.8	12.4
6	11570.00	44.3 AV	54.0	-9.7	2.40 H	207	31.9	12.4
7	#17355.00	52.3 PK	68.2	-15.9	1.55 H	315	36.3	16.0

ANTENNA POLARITY & TEST DISTANCE: VERTICAL AT 3 M

NO.	FREQ. (MHz)	EMISSION LEVEL (dBuV/m)	LIMIT (dBuV/m)	MARGIN (dB)	ANTENNA HEIGHT (m)	TABLE ANGLE (Degree)	RAW VALUE (dBuV)	CORRECTION FACTOR (dB/m)
1	#5641.96	57.6 PK	68.2	-10.6	1.59 V	350	58.4	-0.8
2	*5785.00	119.7 PK			1.59 V	350	116.6	3.1
3	*5785.00	107.4 AV			1.59 V	350	104.3	3.1
4	#5970.22	57.7 PK	68.2	-10.5	1.59 V	350	57.9	-0.2
5	11570.00	51.5 PK	74.0	-22.5	1.48 V	264	39.1	12.4
6	11570.00	44.8 AV	54.0	-9.2	1.48 V	264	32.4	12.4
7	#17355.00	55.2 PK	68.2	-13.0	1.56 V	21	39.2	16.0

REMARKS:

- Emission Level(dBuV/m) = Raw Value(dBuV) + Correction Factor(dB/m)
- Correction Factor(dB/m) = Antenna Factor(dB/m) + Cable Factor(dB) – Pre-Amplifier Factor(dB)
- The other emission levels were very low against the limit.
- Margin value = Emission Level – Limit value
- " * ": Fundamental frequency.
- " # ": The radiated frequency is out of the restricted band.

CHANNEL	TX Channel 165	DETECTOR FUNCTION	Peak (PK)
FREQUENCY RANGE	1GHz ~ 40GHz		Average (AV)

ANTENNA POLARITY & TEST DISTANCE: HORIZONTAL AT 3 M

NO.	FREQ. (MHz)	EMISSION LEVEL (dBuV/m)	LIMIT (dBuV/m)	MARGIN (dB)	ANTENNA HEIGHT (m)	TABLE ANGLE (Degree)	RAW VALUE (dBuV)	CORRECTION FACTOR (dB/m)
1	#5610.10	59.5 PK	68.2	-8.7	1.98 H	311	60.3	-0.8
2	*5825.00	121.4 PK			1.98 H	311	118.2	3.2
3	*5825.00	108.6 AV			1.98 H	311	105.4	3.2
4	#5929.58	58.9 PK	68.2	-9.3	1.98 H	311	59.1	-0.2
5	11650.00	51.9 PK	74.0	-22.1	2.39 H	214	39.5	12.4
6	11650.00	44.8 AV	54.0	-9.2	2.39 H	214	32.4	12.4
7	#17475.00	64.9 PK	68.2	-3.3	1.57 H	316	47.5	17.4

ANTENNA POLARITY & TEST DISTANCE: VERTICAL AT 3 M

NO.	FREQ. (MHz)	EMISSION LEVEL (dBuV/m)	LIMIT (dBuV/m)	MARGIN (dB)	ANTENNA HEIGHT (m)	TABLE ANGLE (Degree)	RAW VALUE (dBuV)	CORRECTION FACTOR (dB/m)
1	#5633.59	58.0 PK	68.2	-10.2	1.68 V	350	55.2	2.8
2	*5825.00	119.5 PK			1.68 V	350	116.3	3.2
3	*5825.00	107.1 AV			1.68 V	350	103.9	3.2
4	#5972.43	57.8 PK	68.2	-10.4	1.68 V	350	54.6	3.2
5	11650.00	52.2 PK	74.0	-21.8	1.62 V	269	39.8	12.4
6	11650.00	45.3 AV	54.0	-8.7	1.62 V	269	32.9	12.4
7	#17475.00	56.2 PK	68.2	-12.0	1.75 V	308	38.8	17.4

REMARKS:

- Emission Level(dBuV/m) = Raw Value(dBuV) + Correction Factor(dB/m)
- Correction Factor(dB/m) = Antenna Factor(dB/m) + Cable Factor(dB) – Pre-Amplifier Factor(dB)
- The other emission levels were very low against the limit.
- Margin value = Emission Level – Limit value
- " * ": Fundamental frequency.
- " # ": The radiated frequency is out of the restricted band.

802.11ax (HE40)

CHANNEL	TX Channel 38	DETECTOR FUNCTION	Peak (PK)
FREQUENCY RANGE	1GHz ~ 40GHz		Average (AV)

ANTENNA POLARITY & TEST DISTANCE: HORIZONTAL AT 3 M

NO.	FREQ. (MHz)	EMISSION LEVEL (dBuV/m)	LIMIT (dBuV/m)	MARGIN (dB)	ANTENNA HEIGHT (m)	TABLE ANGLE (Degree)	RAW VALUE (dBuV)	CORRECTION FACTOR (dB/m)
1	5150.00	65.4 PK	74.0	-8.6	1.82 H	252	62.8	2.6
2	5150.00	53.9 AV	54.0	-0.1	1.82 H	252	51.3	2.6
3	*5190.00	114.6 PK			1.82 H	252	112.1	2.5
4	*5190.00	101.9 AV			1.82 H	252	99.4	2.5
5	5350.00	52.9 PK	74.0	-21.1	1.82 H	252	50.6	2.3
6	5350.00	40.9 AV	54.0	-13.1	1.82 H	252	38.6	2.3
7	#10380.00	52.0 PK	68.2	-16.2	2.38 H	207	40.0	12.0
8	15570.00	52.8 PK	74.0	-21.2	1.55 H	320	40.2	12.6
9	15570.00	40.5 AV	54.0	-13.5	1.55 H	320	27.9	12.6

ANTENNA POLARITY & TEST DISTANCE: VERTICAL AT 3 M

NO.	FREQ. (MHz)	EMISSION LEVEL (dBuV/m)	LIMIT (dBuV/m)	MARGIN (dB)	ANTENNA HEIGHT (m)	TABLE ANGLE (Degree)	RAW VALUE (dBuV)	CORRECTION FACTOR (dB/m)
1	5150.00	63.8 PK	74.0	-10.2	1.28 V	286	61.2	2.6
2	5150.00	52.1 AV	54.0	-1.9	1.28 V	286	49.5	2.6
3	*5190.00	114.0 PK			1.28 V	286	111.5	2.5
4	*5190.00	101.2 AV			1.28 V	286	98.7	2.5
5	5350.00	51.3 PK	74.0	-22.7	1.28 V	286	49.0	2.3
6	5350.00	39.1 AV	54.0	-14.9	1.28 V	286	36.8	2.3
7	#10380.00	52.3 PK	68.2	-15.9	1.57 V	256	40.3	12.0
8	15570.00	53.0 PK	74.0	-21.0	1.60 V	15	40.4	12.6
9	15570.00	40.4 AV	54.0	-13.6	1.60 V	15	27.8	12.6

REMARKS:

- Emission Level(dBuV/m) = Raw Value(dBuV) + Correction Factor(dB/m)
- Correction Factor(dB/m) = Antenna Factor(dB/m) + Cable Factor(dB) – Pre-Amplifier Factor(dB)
- The other emission levels were very low against the limit.
- Margin value = Emission Level – Limit value
- " * ": Fundamental frequency.
- " # ": The radiated frequency is out of the restricted band.

CHANNEL	TX Channel 46	DETECTOR FUNCTION	Peak (PK)
FREQUENCY RANGE	1GHz ~ 40GHz		Average (AV)

ANTENNA POLARITY & TEST DISTANCE: HORIZONTAL AT 3 M

NO.	FREQ. (MHz)	EMISSION LEVEL (dBuV/m)	LIMIT (dBuV/m)	MARGIN (dB)	ANTENNA HEIGHT (m)	TABLE ANGLE (Degree)	RAW VALUE (dBuV)	CORRECTION FACTOR (dB/m)
1	*5230.00	118.6 PK			1.45 H	323	116.4	2.2
2	*5230.00	107.2 AV			1.45 H	323	105.0	2.2
3	5375.00	55.4 PK	74.0	-18.6	1.45 H	323	53.0	2.4
4	5375.00	43.3 AV	54.0	-10.7	1.45 H	323	40.9	2.4
5	#10460.00	52.3 PK	68.2	-15.9	2.41 H	208	39.9	12.4
6	15690.00	52.2 PK	74.0	-21.8	1.57 H	302	40.0	12.2
7	15690.00	40.0 AV	54.0	-14.0	1.57 H	302	27.8	12.2

ANTENNA POLARITY & TEST DISTANCE: VERTICAL AT 3 M

NO.	FREQ. (MHz)	EMISSION LEVEL (dBuV/m)	LIMIT (dBuV/m)	MARGIN (dB)	ANTENNA HEIGHT (m)	TABLE ANGLE (Degree)	RAW VALUE (dBuV)	CORRECTION FACTOR (dB/m)
1	*5230.00	118.0 PK			1.27 V	280	115.8	2.2
2	*5230.00	106.5 AV			1.27 V	280	104.3	2.2
3	5350.00	53.8 PK	74.0	-20.2	1.27 V	280	51.5	2.3
4	5350.00	41.5 AV	54.0	-12.5	1.27 V	280	39.2	2.3
5	#10460.00	52.6 PK	68.2	-15.6	1.53 V	269	40.2	12.4
6	15690.00	52.4 PK	74.0	-21.6	1.51 V	11	40.2	12.2
7	15690.00	39.9 AV	54.0	-14.1	1.51 V	11	27.7	12.2

REMARKS:

- Emission Level(dBuV/m) = Raw Value(dBuV) + Correction Factor(dB/m)
- Correction Factor(dB/m) = Antenna Factor(dB/m) + Cable Factor(dB) – Pre-Amplifier Factor(dB)
- The other emission levels were very low against the limit.
- Margin value = Emission Level – Limit value
- " * ": Fundamental frequency.
- " # ": The radiated frequency is out of the restricted band.

CHANNEL	TX Channel 151	DETECTOR FUNCTION	Peak (PK)
FREQUENCY RANGE	1GHz ~ 40GHz		Average (AV)

ANTENNA POLARITY & TEST DISTANCE: HORIZONTAL AT 3 M

NO.	FREQ. (MHz)	EMISSION LEVEL (dBuV/m)	LIMIT (dBuV/m)	MARGIN (dB)	ANTENNA HEIGHT (m)	TABLE ANGLE (Degree)	RAW VALUE (dBuV)	CORRECTION FACTOR (dB/m)
1	#5611.95	58.6 PK	68.2	-9.6	1.00 H	201	55.8	2.8
2	*5755.00	118.9 PK			1.71 H	201	115.9	3.0
3	*5755.00	106.9 AV			1.71 H	201	103.9	3.0
4	#5985.87	58.0 PK	68.2	-10.2	1.71 H	201	54.8	3.2
5	11510.00	52.5 PK	74.0	-21.5	2.38 H	205	40.2	12.3
6	11510.00	45.7 AV	54.0	-8.3	2.38 H	205	33.4	12.3
7	#17265.00	51.8 PK	68.2	-16.4	1.63 H	322	36.4	15.4

ANTENNA POLARITY & TEST DISTANCE: VERTICAL AT 3 M

NO.	FREQ. (MHz)	EMISSION LEVEL (dBuV/m)	LIMIT (dBuV/m)	MARGIN (dB)	ANTENNA HEIGHT (m)	TABLE ANGLE (Degree)	RAW VALUE (dBuV)	CORRECTION FACTOR (dB/m)
1	#5637.98	62.6 PK	68.2	-5.6	1.35 V	295	63.4	-0.8
2	*5755.00	116.2 PK			1.35 V	295	113.2	3.0
3	*5755.00	104.5 AV			1.35 V	295	101.5	3.0
4	#5972.77	57.5 PK	68.2	-10.7	1.35 V	295	57.7	-0.2
5	11510.00	52.8 PK	74.0	-21.2	1.56 V	275	40.5	12.3
6	11510.00	46.2 AV	54.0	-7.8	1.56 V	275	33.9	12.3
7	#17265.00	52.0 PK	68.2	-16.2	1.55 V	5	36.6	15.4

REMARKS:

1. Emission Level(dBuV/m) = Raw Value(dBuV) + Correction Factor(dB/m)
2. Correction Factor(dB/m) = Antenna Factor(dB/m) + Cable Factor(dB) – Pre-Amplifier Factor(dB)
3. The other emission levels were very low against the limit.
4. Margin value = Emission Level – Limit value
5. " * ": Fundamental frequency.
6. " # ": The radiated frequency is out of the restricted band.

CHANNEL	TX Channel 159	DETECTOR FUNCTION	Peak (PK)
FREQUENCY RANGE	1GHz ~ 40GHz		Average (AV)

ANTENNA POLARITY & TEST DISTANCE: HORIZONTAL AT 3 M

NO.	FREQ. (MHz)	EMISSION LEVEL (dBuV/m)	LIMIT (dBuV/m)	MARGIN (dB)	ANTENNA HEIGHT (m)	TABLE ANGLE (Degree)	RAW VALUE (dBuV)	CORRECTION FACTOR (dB/m)
1	#5642.73	58.8 PK	68.2	-9.4	1.49 H	313	59.6	-0.8
2	*5795.00	119.6 PK			1.49 H	313	116.6	3.0
3	*5795.00	107.4 AV			1.49 H	313	104.4	3.0
4	#5964.45	58.1 PK	68.2	-10.1	1.49 H	313	58.3	-0.2
5	11590.00	52.9 PK	74.0	-21.1	2.33 H	223	40.5	12.4
6	11590.00	45.7 AV	54.0	-8.3	2.33 H	223	33.3	12.4
7	#17385.00	52.4 PK	68.2	-15.8	1.59 H	301	36.2	16.2

ANTENNA POLARITY & TEST DISTANCE: VERTICAL AT 3 M

NO.	FREQ. (MHz)	EMISSION LEVEL (dBuV/m)	LIMIT (dBuV/m)	MARGIN (dB)	ANTENNA HEIGHT (m)	TABLE ANGLE (Degree)	RAW VALUE (dBuV)	CORRECTION FACTOR (dB/m)
1	#5605.72	58.9 PK	68.2	-9.3	1.59 V	305	59.8	-0.9
2	*5795.00	117.2 PK			1.59 V	305	114.2	3.0
3	*5795.00	104.8 AV			1.59 V	305	101.8	3.0
4	#5931.54	57.1 PK	68.2	-11.1	1.59 V	305	57.3	-0.2
5	11590.00	53.2 PK	74.0	-20.8	1.52 V	268	40.8	12.4
6	11590.00	46.2 AV	54.0	-7.8	1.52 V	268	33.8	12.4
7	#17385.00	52.6 PK	68.2	-15.6	1.60 V	6	36.4	16.2

REMARKS:

1. Emission Level(dBuV/m) = Raw Value(dBuV) + Correction Factor(dB/m)
2. Correction Factor(dB/m) = Antenna Factor(dB/m) + Cable Factor(dB) – Pre-Amplifier Factor(dB)
3. The other emission levels were very low against the limit.
4. Margin value = Emission Level – Limit value
5. " * ": Fundamental frequency.
6. " # ": The radiated frequency is out of the restricted band.

802.11ax (HE80)

CHANNEL	TX Channel 42	DETECTOR FUNCTION	Peak (PK)
FREQUENCY RANGE	1GHz ~ 40GHz		Average (AV)

ANTENNA POLARITY & TEST DISTANCE: HORIZONTAL AT 3 M

NO.	FREQ. (MHz)	EMISSION LEVEL (dBuV/m)	LIMIT (dBuV/m)	MARGIN (dB)	ANTENNA HEIGHT (m)	TABLE ANGLE (Degree)	RAW VALUE (dBuV)	CORRECTION FACTOR (dB/m)
1	5150.00	64.3 PK	74.0	-9.7	1.70 H	304	61.7	2.6
2	5150.00	53.9 AV	54.0	-0.1	1.70 H	304	51.3	2.6
3	*5210.00	110.9 PK			1.70 H	304	108.5	2.4
4	*5210.00	97.8 AV			1.70 H	304	95.4	2.4
5	5350.00	53.9 PK	74.0	-20.1	1.70 H	304	51.6	2.3
6	5350.00	42.7 AV	54.0	-11.3	1.70 H	304	40.4	2.3
7	#10420.00	52.1 PK	68.2	-16.1	2.39 H	212	39.9	12.2
8	15630.00	52.2 PK	74.0	-21.8	1.53 H	304	39.5	12.7
9	15630.00	40.1 AV	54.0	-13.9	1.53 H	304	27.4	12.7

ANTENNA POLARITY & TEST DISTANCE: VERTICAL AT 3 M

NO.	FREQ. (MHz)	EMISSION LEVEL (dBuV/m)	LIMIT (dBuV/m)	MARGIN (dB)	ANTENNA HEIGHT (m)	TABLE ANGLE (Degree)	RAW VALUE (dBuV)	CORRECTION FACTOR (dB/m)
1	5150.00	62.7 PK	74.0	-11.3	1.43 V	236	60.1	2.6
2	5150.00	52.1 AV	54.0	-1.9	1.43 V	236	49.5	2.6
3	*5210.00	107.9 PK			1.43 V	236	105.5	2.4
4	*5210.00	95.6 AV			1.43 V	236	93.2	2.4
5	5350.00	54.1 PK	74.0	-19.9	1.43 V	236	51.8	2.3
6	5350.00	42.6 AV	54.0	-11.4	1.43 V	236	40.3	2.3
7	#10420.00	52.4 PK	68.2	-15.8	1.56 V	275	40.2	12.2
8	15630.00	52.4 PK	74.0	-21.6	1.51 V	8	39.7	12.7
9	15630.00	40.0 AV	54.0	-14.0	1.51 V	8	27.3	12.7

REMARKS:

- Emission Level(dBuV/m) = Raw Value(dBuV) + Correction Factor(dB/m)
- Correction Factor(dB/m) = Antenna Factor(dB/m) + Cable Factor(dB) – Pre-Amplifier Factor(dB)
- The other emission levels were very low against the limit.
- Margin value = Emission Level – Limit value
- " * ": Fundamental frequency.
- " # ": The radiated frequency is out of the restricted band.

CHANNEL	TX Channel 155	DETECTOR FUNCTION	Peak (PK)
FREQUENCY RANGE	1GHz ~ 40GHz		Average (AV)

ANTENNA POLARITY & TEST DISTANCE: HORIZONTAL AT 3 M

NO.	FREQ. (MHz)	EMISSION LEVEL (dBuV/m)	LIMIT (dBuV/m)	MARGIN (dB)	ANTENNA HEIGHT (m)	TABLE ANGLE (Degree)	RAW VALUE (dBuV)	CORRECTION FACTOR (dB/m)
1	#5640.56	61.2 PK	68.2	-7.0	1.91 H	243	62.0	-0.8
2	*5775.00	115.2 PK			1.91 H	243	112.2	3.0
3	*5775.00	103.6 AV			1.91 H	243	100.6	3.0
4	#5938.40	59.8 PK	68.2	-8.4	1.91 H	243	60.0	-0.2
5	11550.00	52.3 PK	74.0	-21.7	2.35 H	207	39.9	12.4
6	11550.00	45.2 AV	54.0	-8.8	2.35 H	207	32.8	12.4
7	#17325.00	52.3 PK	68.2	-15.9	1.57 H	328	36.6	15.7

ANTENNA POLARITY & TEST DISTANCE: VERTICAL AT 3 M

NO.	FREQ. (MHz)	EMISSION LEVEL (dBuV/m)	LIMIT (dBuV/m)	MARGIN (dB)	ANTENNA HEIGHT (m)	TABLE ANGLE (Degree)	RAW VALUE (dBuV)	CORRECTION FACTOR (dB/m)
1	#5643.69	64.1 PK	68.2	-4.1	2.26 V	280	64.9	-0.8
2	*5775.00	112.2 PK			2.26 V	280	109.2	3.0
3	*5775.00	99.8 AV			2.26 V	280	96.8	3.0
4	#5937.80	58.5 PK	68.2	-9.7	2.26 V	280	58.7	-0.2
5	11550.00	52.6 PK	74.0	-21.4	1.57 V	277	40.2	12.4
6	11550.00	45.7 AV	54.0	-8.3	1.57 V	277	33.3	12.4
7	#17325.00	52.5 PK	68.2	-15.7	1.56 V	13	36.8	15.7

REMARKS:

1. Emission Level(dBuV/m) = Raw Value(dBuV) + Correction Factor(dB/m)
2. Correction Factor(dB/m) = Antenna Factor(dB/m) + Cable Factor(dB) – Pre-Amplifier Factor(dB)
3. The other emission levels were very low against the limit.
4. Margin value = Emission Level – Limit value
5. " * ": Fundamental frequency.
6. " # ": The radiated frequency is out of the restricted band.

802.11ax (HE80+80)

CHANNEL	TX Channel 42+155	DETECTOR FUNCTION	Peak (PK)
FREQUENCY RANGE	1GHz ~ 40GHz		Average (AV)

ANTENNA POLARITY & TEST DISTANCE: HORIZONTAL AT 3 M

NO.	FREQ. (MHz)	EMISSION LEVEL (dBuV/m)	LIMIT (dBuV/m)	MARGIN (dB)	ANTENNA HEIGHT (m)	TABLE ANGLE (Degree)	RAW VALUE (dBuV)	CORRECTION FACTOR (dB/m)
1	5150.00	65.9 PK	74.0	-8.1	1.46 H	236	63.3	2.6
2	5150.00	53.9 AV	54.0	-0.1	1.46 H	236	51.3	2.6
3	*5210.00	106.3 PK			1.46 H	236	103.9	2.4
4	*5210.00	94.5 AV			1.46 H	236	92.1	2.4
5	5350.00	53.7 PK	74.0	-20.3	1.46 H	236	51.4	2.3
6	5350.00	42.7 AV	54.0	-11.3	1.46 H	236	40.4	2.3
7	#5620.63	58.4 PK	68.2	-9.8	1.38 H	256	55.6	2.8
8	*5775.00	113.9 PK			1.38 H	256	110.9	3.0
9	*5775.00	100.9 AV			1.38 H	256	97.9	3.0
10	#5954.58	57.6 PK	68.2	-10.6	1.38 H	256	54.4	3.2
11	#10420.00	51.5 PK	68.2	-16.7	2.42 H	210	39.3	12.2
12	11550.00	51.9 PK	74.0	-22.1	2.37 H	209	39.5	12.4
13	11550.00	45.5 AV	54.0	-8.5	2.37 H	209	33.1	12.4
14	15630.00	53.3 PK	74.0	-20.7	1.57 H	309	40.6	12.7
15	15630.00	40.9 AV	54.0	-13.1	1.57 H	309	28.2	12.7
16	#17325.00	52.8 PK	68.2	-15.4	1.51 H	308	37.1	15.7

ANTENNA POLARITY & TEST DISTANCE: VERTICAL AT 3 M

NO.	FREQ. (MHz)	EMISSION LEVEL (dBuV/m)	LIMIT (dBuV/m)	MARGIN (dB)	ANTENNA HEIGHT (m)	TABLE ANGLE (Degree)	RAW VALUE (dBuV)	CORRECTION FACTOR (dB/m)
1	5150.00	64.3 PK	74.0	-9.7	1.28 V	289	61.7	2.6
2	5150.00	52.1 AV	54.0	-1.9	1.28 V	289	49.5	2.6
3	*5210.00	112.2 PK			1.28 V	289	109.8	2.4
4	*5210.00	99.8 AV			1.28 V	289	97.4	2.4
5	5350.00	52.1 PK	74.0	-21.9	1.28 V	289	49.8	2.3
6	5350.00	40.9 AV	54.0	-13.1	1.28 V	289	38.6	2.3
7	#5618.36	58.5 PK	68.2	-9.7	2.25 V	283	59.3	-0.8
8	*5775.00	110.7 PK			2.25 V	283	107.7	3.0
9	*5775.00	98.5 AV			2.25 V	283	95.5	3.0
10	#5933.06	57.7 PK	68.2	-10.5	2.25 V	283	57.8	-0.1
11	#10420.00	51.8 PK	68.2	-16.4	1.48 V	254	39.6	12.2
12	11550.00	52.1 PK	74.0	-21.9	1.56 V	270	39.7	12.4
13	11550.00	45.4 AV	54.0	-8.6	1.56 V	270	33.0	12.4
14	15630.00	53.5 PK	74.0	-20.5	1.55 V	15	40.8	12.7
15	15630.00	40.8 AV	54.0	-13.2	1.55 V	15	28.1	12.7
16	#17325.00	53.0 PK	68.2	-15.2	1.60 V	17	37.3	15.7

REMARKS:

1. Emission Level(dBuV/m) = Raw Value(dBuV) + Correction Factor(dB/m)
2. Correction Factor(dB/m) = Antenna Factor(dB/m) + Cable Factor(dB) – Pre-Amplifier Factor(dB)
3. The other emission levels were very low against the limit.
4. Margin value = Emission Level – Limit value
5. " * ": Fundamental frequency.
6. " # ": The radiated frequency is out of the restricted band.

Below 1GHz Data:

802.11a

CHANNEL	TX Channel 165	DETECTOR FUNCTION	Quasi-Peak (QP)
FREQUENCY RANGE	9kHz ~ 1GHz		

ANTENNA POLARITY & TEST DISTANCE: HORIZONTAL AT 3 M

NO.	FREQ. (MHz)	EMISSION LEVEL (dBuV/m)	LIMIT (dBuV/m)	MARGIN (dB)	ANTENNA HEIGHT (m)	TABLE ANGLE (Degree)	RAW VALUE (dBuV)	CORRECTION FACTOR (dB/m)
1	162.53	33.4 QP	43.5	-10.1	2.00 H	93	41.4	-8.0
2	219.49	31.7 QP	46.0	-14.3	1.50 H	296	42.5	-10.8
3	323.81	31.3 QP	46.0	-14.7	1.00 H	80	37.3	-6.0
4	425.15	29.6 QP	46.0	-16.4	1.00 H	241	33.1	-3.5
5	546.65	32.7 QP	46.0	-13.3	1.50 H	338	34.0	-1.3
6	633.12	30.1 QP	46.0	-15.9	2.00 H	222	28.9	1.2

REMARKS:

1. Emission Level(dBuV/m) = Raw Value(dBuV) + Correction Factor(dB/m)
2. Correction Factor(dB/m) = Antenna Factor(dB/m) + Cable Factor(dB) – Pre-Amplifier Factor(dB)
3. Margin value = Emission Level – Limit value
4. The emission levels were very low against the limit of frequency range 9kHz~30MHz: the amplitude of spurious emissions attenuated more than 20 dB below the permissible value to be report.

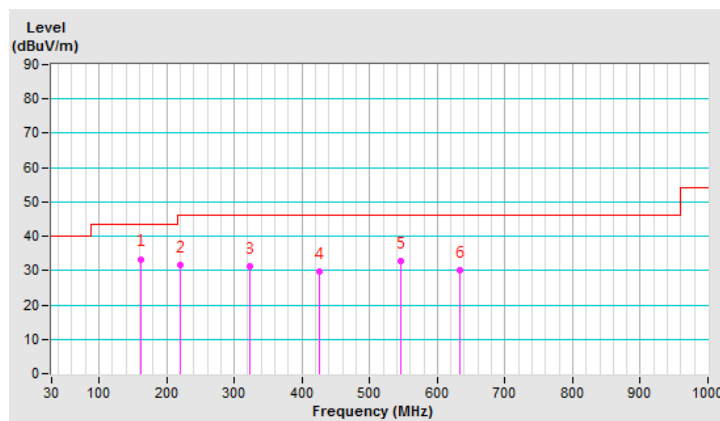

CHANNEL	TX Channel 165	DETECTOR FUNCTION	Quasi-Peak (QP)
FREQUENCY RANGE	9kHz ~ 1GHz		

ANTENNA POLARITY & TEST DISTANCE: VERTICAL AT 3 M								
NO.	FREQ. (MHz)	EMISSION LEVEL (dBuV/m)	LIMIT (dBuV/m)	MARGIN (dB)	ANTENNA HEIGHT (m)	TABLE ANGLE (Degree)	RAW VALUE (dBuV)	CORRECTION FACTOR (dB/m)
1	111.50	31.5 QP	43.5	-12.0	1.50 V	0	41.9	-10.4
2	162.55	31.4 QP	43.5	-12.1	1.50 V	0	39.4	-8.0
3	249.97	27.7 QP	46.0	-18.3	1.50 V	1	36.6	-8.9
4	312.39	27.2 QP	46.0	-18.8	1.00 V	39	33.6	-6.4
5	464.90	29.2 QP	46.0	-16.8	1.00 V	360	31.9	-2.7
6	644.37	31.5 QP	46.0	-14.5	1.00 V	15	30.3	1.2

REMARKS:

1. Emission Level(dBuV/m) = Raw Value(dBuV) + Correction Factor(dB/m)
2. Correction Factor(dB/m) = Antenna Factor(dB/m) + Cable Factor(dB) – Pre-Amplifier Factor(dB)
3. Margin value = Emission Level – Limit value
4. The emission levels were very low against the limit of frequency range 9kHz~30MHz: the amplitude of spurious emissions attenuated more than 20 dB below the permissible value to be report.

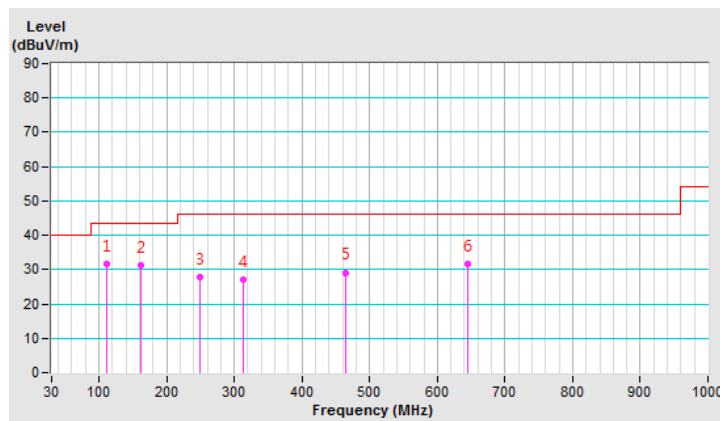

4.1.8 Test Results (Mode 2)

Above 1GHz Data:

802.11a

CHANNEL	TX Channel 36	DETECTOR FUNCTION	Peak (PK)
FREQUENCY RANGE	1GHz ~ 40GHz		Average (AV)

ANTENNA POLARITY & TEST DISTANCE: HORIZONTAL AT 3 M

NO.	FREQ. (MHz)	EMISSION LEVEL (dBuV/m)	LIMIT (dBuV/m)	MARGIN (dB)	ANTENNA HEIGHT (m)	TABLE ANGLE (Degree)	RAW VALUE (dBuV)	CORRECTION FACTOR (dB/m)
1	5143.00	65.7 PK	74.0	-8.3	1.90 H	232	63.1	2.6
2	5143.00	50.1 AV	54.0	-3.9	1.90 H	232	47.5	2.6
3	5150.00	60.2 PK	74.0	-13.8	1.90 H	232	57.6	2.6
4	5150.00	48.0 AV	54.0	-6.0	1.90 H	232	45.4	2.6
5	*5180.00	117.1 PK			1.90 H	232	114.6	2.5
6	*5180.00	108.9 AV			1.90 H	232	106.4	2.5
7	#10360.00	51.4 PK	68.2	-16.8	2.17 H	155	39.5	11.9
8	15540.00	52.6 PK	74.0	-21.4	1.43 H	201	40.2	12.4
9	15540.00	39.9 AV	54.0	-14.1	1.43 H	201	27.5	12.4

ANTENNA POLARITY & TEST DISTANCE: VERTICAL AT 3 M

NO.	FREQ. (MHz)	EMISSION LEVEL (dBuV/m)	LIMIT (dBuV/m)	MARGIN (dB)	ANTENNA HEIGHT (m)	TABLE ANGLE (Degree)	RAW VALUE (dBuV)	CORRECTION FACTOR (dB/m)
1	5146.00	69.2 PK	74.0	-4.8	1.90 V	238	66.6	2.6
2	5146.00	53.5 AV	54.0	-0.5	1.90 V	238	50.9	2.6
3	5150.00	62.5 PK	74.0	-11.5	1.90 V	238	59.9	2.6
4	5150.00	50.8 AV	54.0	-3.2	1.90 V	238	48.2	2.6
5	*5180.00	117.5 PK			1.90 V	238	115.0	2.5
6	*5180.00	109.2 AV			1.90 V	238	106.7	2.5
7	#10360.00	53.3 PK	68.2	-14.9	1.78 V	306	41.4	11.9
8	15540.00	53.5 PK	74.0	-20.5	1.43 V	175	41.1	12.4
9	15540.00	40.7 AV	54.0	-13.3	1.43 V	175	28.3	12.4

REMARKS:

- Emission Level(dBuV/m) = Raw Value(dBuV) + Correction Factor(dB/m)
- Correction Factor(dB/m) = Antenna Factor(dB/m) + Cable Factor(dB) – Pre-Amplifier Factor(dB)
- The other emission levels were very low against the limit.
- Margin value = Emission Level – Limit value
- " * ": Fundamental frequency.
- " # ": The radiated frequency is out of the restricted band.

CHANNEL	TX Channel 40	DETECTOR FUNCTION	Peak (PK)
FREQUENCY RANGE	1GHz ~ 40GHz		Average (AV)

ANTENNA POLARITY & TEST DISTANCE: HORIZONTAL AT 3 M

NO.	FREQ. (MHz)	EMISSION LEVEL (dBuV/m)	LIMIT (dBuV/m)	MARGIN (dB)	ANTENNA HEIGHT (m)	TABLE ANGLE (Degree)	RAW VALUE (dBuV)	CORRECTION FACTOR (dB/m)
1	5150.00	62.2 PK	74.0	-11.8	1.85 H	217	59.6	2.6
2	5150.00	47.3 AV	54.0	-6.7	1.85 H	217	44.7	2.6
3	*5200.00	118.3 PK			1.85 H	217	115.9	2.4
4	*5200.00	109.6 AV			1.85 H	217	107.2	2.4
5	5350.00	43.8 PK	74.0	-30.2	1.85 H	217	41.5	2.3
6	5350.00	34.4 AV	54.0	-19.6	1.85 H	217	32.1	2.3
7	5391.00	47.1 PK	74.0	-26.9	1.85 H	217	44.6	2.5
8	5391.00	36.9 AV	54.0	-17.1	1.85 H	217	34.4	2.5
9	#10400.00	51.3 PK	68.2	-16.9	2.13 H	153	39.1	12.2
10	15600.00	52.3 PK	74.0	-21.7	1.41 H	209	39.4	12.9
11	15600.00	39.8 AV	54.0	-14.2	1.41 H	209	26.9	12.9

ANTENNA POLARITY & TEST DISTANCE: VERTICAL AT 3 M

NO.	FREQ. (MHz)	EMISSION LEVEL (dBuV/m)	LIMIT (dBuV/m)	MARGIN (dB)	ANTENNA HEIGHT (m)	TABLE ANGLE (Degree)	RAW VALUE (dBuV)	CORRECTION FACTOR (dB/m)
1	5150.00	64.5 PK	74.0	-9.5	1.87 V	253	61.9	2.6
2	5150.00	50.1 AV	54.0	-3.9	1.87 V	253	47.5	2.6
3	*5200.00	118.7 PK			1.87 V	253	116.3	2.4
4	*5200.00	109.9 AV			1.87 V	253	107.5	2.4
5	5350.00	46.1 PK	74.0	-27.9	1.87 V	253	43.8	2.3
6	5350.00	37.2 AV	54.0	-16.8	1.87 V	253	34.9	2.3
7	5391.00	49.4 PK	74.0	-24.6	1.87 V	253	46.9	2.5
8	5391.00	39.7 AV	54.0	-14.3	1.87 V	253	37.2	2.5
9	#10400.00	52.7 PK	68.2	-15.5	1.72 V	312	40.5	12.2
10	15600.00	53.2 PK	74.0	-20.8	1.39 V	182	40.3	12.9
11	15600.00	40.6 AV	54.0	-13.4	1.39 V	182	27.7	12.9

REMARKS:

1. Emission Level(dBuV/m) = Raw Value(dBuV) + Correction Factor(dB/m)
2. Correction Factor(dB/m) = Antenna Factor(dB/m) + Cable Factor(dB) – Pre-Amplifier Factor(dB)
3. The other emission levels were very low against the limit.
4. Margin value = Emission Level – Limit value
5. " * ": Fundamental frequency.
6. " # ": The radiated frequency is out of the restricted band.

CHANNEL	TX Channel 48	DETECTOR FUNCTION	Peak (PK)
FREQUENCY RANGE	1GHz ~ 40GHz		Average (AV)

ANTENNA POLARITY & TEST DISTANCE: HORIZONTAL AT 3 M

NO.	FREQ. (MHz)	EMISSION LEVEL (dBuV/m)	LIMIT (dBuV/m)	MARGIN (dB)	ANTENNA HEIGHT (m)	TABLE ANGLE (Degree)	RAW VALUE (dBuV)	CORRECTION FACTOR (dB/m)
1	*5240.00	118.1 PK			1.95 H	239	115.9	2.2
2	*5240.00	109.6 AV			1.95 H	239	107.4	2.2
3	5350.00	40.4 PK	74.0	-33.6	1.95 H	239	38.1	2.3
4	5350.00	34.9 AV	54.0	-19.1	1.95 H	239	32.6	2.3
5	5427.00	48.5 PK	74.0	-25.5	1.95 H	239	46.0	2.5
6	5427.00	36.8 AV	54.0	-17.2	1.95 H	239	34.3	2.5
7	#10480.00	50.5 PK	68.2	-17.7	2.11 H	146	38.1	12.4
8	15720.00	52.5 PK	74.0	-21.5	1.41 H	197	40.5	12.0
9	15720.00	39.8 AV	54.0	-14.2	1.41 H	197	27.8	12.0

ANTENNA POLARITY & TEST DISTANCE: VERTICAL AT 3 M

NO.	FREQ. (MHz)	EMISSION LEVEL (dBuV/m)	LIMIT (dBuV/m)	MARGIN (dB)	ANTENNA HEIGHT (m)	TABLE ANGLE (Degree)	RAW VALUE (dBuV)	CORRECTION FACTOR (dB/m)
1	*5240.00	118.5 PK			1.36 V	271	116.3	2.2
2	*5240.00	109.9 AV			1.36 V	271	107.7	2.2
3	5350.00	42.7 PK	74.0	-31.3	1.36 V	271	40.4	2.3
4	5350.00	37.7 AV	54.0	-16.3	1.36 V	271	35.4	2.3
5	5427.00	50.8 PK	74.0	-23.2	1.36 V	271	48.3	2.5
6	5427.00	39.6 AV	54.0	-14.4	1.36 V	271	37.1	2.5
7	#10480.00	51.8 PK	68.2	-16.4	1.79 V	311	39.4	12.4
8	15720.00	53.4 PK	74.0	-20.6	1.45 V	162	41.4	12.0
9	15720.00	40.6 AV	54.0	-13.4	1.45 V	162	28.6	12.0

REMARKS:

1. Emission Level(dBuV/m) = Raw Value(dBuV) + Correction Factor(dB/m)
2. Correction Factor(dB/m) = Antenna Factor(dB/m) + Cable Factor(dB) – Pre-Amplifier Factor(dB)
3. The other emission levels were very low against the limit.
4. Margin value = Emission Level – Limit value
5. " * ": Fundamental frequency.
6. " # ": The radiated frequency is out of the restricted band.

CHANNEL	TX Channel 149	DETECTOR FUNCTION	Peak (PK)
FREQUENCY RANGE	1GHz ~ 40GHz		Average (AV)

ANTENNA POLARITY & TEST DISTANCE: HORIZONTAL AT 3 M

NO.	FREQ. (MHz)	EMISSION LEVEL (dBuV/m)	LIMIT (dBuV/m)	MARGIN (dB)	ANTENNA HEIGHT (m)	TABLE ANGLE (Degree)	RAW VALUE (dBuV)	CORRECTION FACTOR (dB/m)
1	#5643.99	62.2 PK	68.2	-6.0	1.76 H	241	59.5	2.7
2	*5745.00	123.6 PK			1.76 H	241	120.7	2.9
3	*5745.00	113.5 AV			1.76 H	241	110.6	2.9
4	#6003.97	57.2 PK	68.2	-11.0	1.76 H	241	54.0	3.2
5	11490.00	51.0 PK	74.0	-23.0	2.12 H	170	38.7	12.3
6	11490.00	44.2 AV	54.0	-9.8	2.12 H	170	31.9	12.3
7	#17235.00	52.7 PK	68.2	-15.5	1.42 H	198	37.4	15.3

ANTENNA POLARITY & TEST DISTANCE: VERTICAL AT 3 M

NO.	FREQ. (MHz)	EMISSION LEVEL (dBuV/m)	LIMIT (dBuV/m)	MARGIN (dB)	ANTENNA HEIGHT (m)	TABLE ANGLE (Degree)	RAW VALUE (dBuV)	CORRECTION FACTOR (dB/m)
1	#5638.64	61.0 PK	68.2	-7.2	1.68 V	221	58.3	2.7
2	*5745.00	122.2 PK			1.68 V	221	119.3	2.9
3	*5745.00	112.9 AV			1.68 V	221	110.0	2.9
4	#5943.09	57.8 PK	68.2	-10.4	1.68 V	221	54.5	3.3
5	11490.00	52.2 PK	74.0	-21.8	1.73 V	320	39.9	12.3
6	11490.00	45.5 AV	54.0	-8.5	1.73 V	320	33.2	12.3
7	#17235.00	53.6 PK	68.2	-14.6	1.42 V	172	38.3	15.3

REMARKS:

1. Emission Level(dBuV/m) = Raw Value(dBuV) + Correction Factor(dB/m)
2. Correction Factor(dB/m) = Antenna Factor(dB/m) + Cable Factor(dB) – Pre-Amplifier Factor(dB)
3. The other emission levels were very low against the limit.
4. Margin value = Emission Level – Limit value
5. " * ": Fundamental frequency.
6. " # ": The radiated frequency is out of the restricted band.

CHANNEL	TX Channel 157	DETECTOR FUNCTION	Peak (PK)
FREQUENCY RANGE	1GHz ~ 40GHz		Average (AV)

ANTENNA POLARITY & TEST DISTANCE: HORIZONTAL AT 3 M

NO.	FREQ. (MHz)	EMISSION LEVEL (dBuV/m)	LIMIT (dBuV/m)	MARGIN (dB)	ANTENNA HEIGHT (m)	TABLE ANGLE (Degree)	RAW VALUE (dBuV)	CORRECTION FACTOR (dB/m)
1	#5596.62	59.1 PK	68.2	-9.1	1.37 H	260	56.3	2.8
2	*5785.00	123.3 PK			1.37 H	260	120.2	3.1
3	*5785.00	113.4 AV			1.37 H	260	110.3	3.1
4	#5978.47	57.6 PK	68.2	-10.6	1.37 H	260	54.4	3.2
5	11570.00	51.3 PK	74.0	-22.7	2.19 H	163	38.9	12.4
6	11570.00	44.6 AV	54.0	-9.4	2.19 H	163	32.2	12.4
7	#17355.00	52.9 PK	68.2	-15.3	1.48 H	216	36.9	16.0

ANTENNA POLARITY & TEST DISTANCE: VERTICAL AT 3 M

NO.	FREQ. (MHz)	EMISSION LEVEL (dBuV/m)	LIMIT (dBuV/m)	MARGIN (dB)	ANTENNA HEIGHT (m)	TABLE ANGLE (Degree)	RAW VALUE (dBuV)	CORRECTION FACTOR (dB/m)
1	#5591.11	59.0 PK	68.2	-9.2	1.72 V	230	56.2	2.8
2	*5785.00	121.9 PK			1.72 V	230	118.8	3.1
3	*5785.00	112.2 AV			1.72 V	230	109.1	3.1
4	#5995.06	57.9 PK	68.2	-10.3	1.72 V	230	54.7	3.2
5	11570.00	51.9 PK	74.0	-22.1	1.72 V	300	39.5	12.4
6	11570.00	45.3 AV	54.0	-8.7	1.72 V	300	32.9	12.4
7	#17355.00	53.8 PK	68.2	-14.4	1.46 V	166	37.8	16.0

REMARKS:

1. Emission Level(dBuV/m) = Raw Value(dBuV) + Correction Factor(dB/m)
2. Correction Factor(dB/m) = Antenna Factor(dB/m) + Cable Factor(dB) – Pre-Amplifier Factor(dB)
3. The other emission levels were very low against the limit.
4. Margin value = Emission Level – Limit value
5. " * ": Fundamental frequency.
6. " # ": The radiated frequency is out of the restricted band.

CHANNEL	TX Channel 165	DETECTOR FUNCTION	Peak (PK)
FREQUENCY RANGE	1GHz ~ 40GHz		Average (AV)

ANTENNA POLARITY & TEST DISTANCE: HORIZONTAL AT 3 M

NO.	FREQ. (MHz)	EMISSION LEVEL (dBuV/m)	LIMIT (dBuV/m)	MARGIN (dB)	ANTENNA HEIGHT (m)	TABLE ANGLE (Degree)	RAW VALUE (dBuV)	CORRECTION FACTOR (dB/m)
1	#5632.09	58.7 PK	68.2	-9.5	1.47 H	255	55.9	2.8
2	*5825.00	124.1 PK			1.47 H	255	120.9	3.2
3	*5825.00	114.2 AV			1.47 H	255	111.0	3.2
4	#6015.45	59.2 PK	68.2	-9.0	1.47 H	255	56.0	3.2
5	11650.00	51.1 PK	74.0	-22.9	2.14 H	163	38.7	12.4
6	11650.00	45.2 AV	54.0	-8.8	2.14 H	163	32.8	12.4
7	#17475.00	53.3 PK	68.2	-14.9	1.40 H	215	35.9	17.4

ANTENNA POLARITY & TEST DISTANCE: VERTICAL AT 3 M

NO.	FREQ. (MHz)	EMISSION LEVEL (dBuV/m)	LIMIT (dBuV/m)	MARGIN (dB)	ANTENNA HEIGHT (m)	TABLE ANGLE (Degree)	RAW VALUE (dBuV)	CORRECTION FACTOR (dB/m)
1	#5640.08	58.4 PK	68.2	-9.8	1.61 V	276	59.2	-0.8
2	*5825.00	122.7 PK			1.61 V	276	119.5	3.2
3	*5825.00	113.2 AV			1.61 V	276	110.0	3.2
4	#5928.67	58.8 PK	68.2	-9.4	1.61 V	276	59.0	-0.2
5	11650.00	52.2 PK	74.0	-21.8	1.78 V	318	39.8	12.4
6	11650.00	45.3 AV	54.0	-8.7	1.78 V	318	32.9	12.4
7	#17475.00	54.2 PK	68.2	-14.0	1.48 V	163	36.8	17.4

REMARKS:

1. Emission Level(dBuV/m) = Raw Value(dBuV) + Correction Factor(dB/m)
2. Correction Factor(dB/m) = Antenna Factor(dB/m) + Cable Factor(dB) – Pre-Amplifier Factor(dB)
3. The other emission levels were very low against the limit.
4. Margin value = Emission Level – Limit value
5. " * ": Fundamental frequency.
6. " # ": The radiated frequency is out of the restricted band.

802.11ax (HE20)

CHANNEL	TX Channel 36	DETECTOR FUNCTION	Peak (PK)
FREQUENCY RANGE	1GHz ~ 40GHz		Average (AV)

ANTENNA POLARITY & TEST DISTANCE: HORIZONTAL AT 3 M								
NO.	FREQ. (MHz)	EMISSION LEVEL (dBuV/m)	LIMIT (dBuV/m)	MARGIN (dB)	ANTENNA HEIGHT (m)	TABLE ANGLE (Degree)	RAW VALUE (dBuV)	CORRECTION FACTOR (dB/m)
1	5150.00	65.2 PK	74.0	-8.8	1.72 H	239	62.6	2.6
2	5150.00	52.1 AV	54.0	-1.9	1.72 H	239	49.5	2.6
3	*5180.00	119.2 PK			1.72 H	239	116.7	2.5
4	*5180.00	106.5 AV			1.72 H	239	104.0	2.5
5	#10360.00	50.6 PK	68.2	-17.6	2.18 H	141	38.7	11.9
6	15540.00	52.7 PK	74.0	-21.3	1.42 H	198	40.3	12.4
7	15540.00	40.1 AV	54.0	-13.9	1.42 H	198	27.7	12.4
ANTENNA POLARITY & TEST DISTANCE: VERTICAL AT 3 M								
NO.	FREQ. (MHz)	EMISSION LEVEL (dBuV/m)	LIMIT (dBuV/m)	MARGIN (dB)	ANTENNA HEIGHT (m)	TABLE ANGLE (Degree)	RAW VALUE (dBuV)	CORRECTION FACTOR (dB/m)
1	5150.00	66.4 PK	74.0	-7.6	1.83 V	248	63.8	2.6
2	5150.00	53.9 AV	54.0	-0.1	1.83 V	248	51.3	2.6
3	*5180.00	117.8 PK			1.83 V	248	115.3	2.5
4	*5180.00	105.2 AV			1.83 V	248	102.7	2.5
5	#10360.00	52.9 PK	68.2	-15.3	1.80 V	312	41.0	11.9
6	15540.00	53.6 PK	74.0	-20.4	1.44 V	171	41.2	12.4
7	15540.00	40.9 AV	54.0	-13.1	1.44 V	171	28.5	12.4

REMARKS:

- Emission Level(dBuV/m) = Raw Value(dBuV) + Correction Factor(dB/m)
- Correction Factor(dB/m) = Antenna Factor(dB/m) + Cable Factor(dB) – Pre-Amplifier Factor(dB)
- The other emission levels were very low against the limit.
- Margin value = Emission Level – Limit value
- " * ": Fundamental frequency.
- " # ": The radiated frequency is out of the restricted band.

CHANNEL	TX Channel 40	DETECTOR FUNCTION	Peak (PK)
FREQUENCY RANGE	1GHz ~ 40GHz		Average (AV)

ANTENNA POLARITY & TEST DISTANCE: HORIZONTAL AT 3 M

NO.	FREQ. (MHz)	EMISSION LEVEL (dBuV/m)	LIMIT (dBuV/m)	MARGIN (dB)	ANTENNA HEIGHT (m)	TABLE ANGLE (Degree)	RAW VALUE (dBuV)	CORRECTION FACTOR (dB/m)
1	5150.00	62.2 PK	74.0	-11.8	1.77 H	230	59.6	2.6
2	5150.00	48.8 AV	54.0	-5.2	1.77 H	230	46.2	2.6
3	*5200.00	121.1 PK			1.77 H	230	118.7	2.4
4	*5200.00	108.7 AV			1.77 H	230	106.3	2.4
5	5350.00	43.0 PK	74.0	-31.0	1.77 H	230	40.7	2.3
6	5350.00	35.5 AV	54.0	-18.5	1.77 H	230	33.2	2.3
7	5393.00	49.7 PK	74.0	-24.3	1.77 H	230	47.2	2.5
8	5393.00	38.4 AV	54.0	-15.6	1.77 H	230	35.9	2.5
9	#10400.00	51.2 PK	68.2	-17.0	2.15 H	140	39.0	12.2
10	15600.00	52.9 PK	74.0	-21.1	1.39 H	185	40.0	12.9
11	15600.00	40.0 AV	54.0	-14.0	1.39 H	185	27.1	12.9

ANTENNA POLARITY & TEST DISTANCE: VERTICAL AT 3 M

NO.	FREQ. (MHz)	EMISSION LEVEL (dBuV/m)	LIMIT (dBuV/m)	MARGIN (dB)	ANTENNA HEIGHT (m)	TABLE ANGLE (Degree)	RAW VALUE (dBuV)	CORRECTION FACTOR (dB/m)
1	5150.00	63.4 PK	74.0	-10.6	2.21 V	251	60.8	2.6
2	5150.00	50.6 AV	54.0	-3.4	2.21 V	251	48.0	2.6
3	*5200.00	119.7 PK			2.21 V	251	117.3	2.4
4	*5200.00	107.4 AV			2.21 V	251	105.0	2.4
5	5350.00	44.2 PK	74.0	-29.8	2.21 V	251	41.9	2.3
6	5350.00	37.3 AV	54.0	-16.7	2.21 V	251	35.0	2.3
7	5393.00	50.9 PK	74.0	-23.1	2.21 V	251	48.4	2.5
8	5393.00	40.2 AV	54.0	-13.8	2.21 V	251	37.7	2.5
9	#10400.00	51.7 PK	68.2	-16.5	1.76 V	307	39.5	12.2
10	15600.00	53.8 PK	74.0	-20.2	1.49 V	189	40.9	12.9
11	15600.00	40.8 AV	54.0	-13.2	1.49 V	189	27.9	12.9

REMARKS:

1. Emission Level(dBuV/m) = Raw Value(dBuV) + Correction Factor(dB/m)
2. Correction Factor(dB/m) = Antenna Factor(dB/m) + Cable Factor(dB) – Pre-Amplifier Factor(dB)
3. The other emission levels were very low against the limit.
4. Margin value = Emission Level – Limit value
5. " * ": Fundamental frequency.
6. " # ": The radiated frequency is out of the restricted band.

CHANNEL	TX Channel 48	DETECTOR FUNCTION	Peak (PK)
FREQUENCY RANGE	1GHz ~ 40GHz		Average (AV)

ANTENNA POLARITY & TEST DISTANCE: HORIZONTAL AT 3 M

NO.	FREQ. (MHz)	EMISSION LEVEL (dBuV/m)	LIMIT (dBuV/m)	MARGIN (dB)	ANTENNA HEIGHT (m)	TABLE ANGLE (Degree)	RAW VALUE (dBuV)	CORRECTION FACTOR (dB/m)
1	*5240.00	120.3 PK			1.74 H	230	118.1	2.2
2	*5240.00	107.7 AV			1.74 H	230	105.5	2.2
3	5350.00	45.2 PK	74.0	-28.8	1.74 H	230	42.9	2.3
4	5350.00	35.2 AV	54.0	-18.8	1.74 H	230	32.9	2.3
5	5433.00	49.4 PK	74.0	-24.6	1.74 H	230	46.9	2.5
6	5433.00	36.8 AV	54.0	-17.2	1.74 H	230	34.3	2.5
7	#10480.00	51.0 PK	68.2	-17.2	2.19 H	159	38.6	12.4
8	15720.00	52.8 PK	74.0	-21.2	1.42 H	214	40.8	12.0
9	15720.00	40.5 AV	54.0	-13.5	1.42 H	214	28.5	12.0

ANTENNA POLARITY & TEST DISTANCE: VERTICAL AT 3 M

NO.	FREQ. (MHz)	EMISSION LEVEL (dBuV/m)	LIMIT (dBuV/m)	MARGIN (dB)	ANTENNA HEIGHT (m)	TABLE ANGLE (Degree)	RAW VALUE (dBuV)	CORRECTION FACTOR (dB/m)
1	*5240.00	118.9 PK			1.26 V	228	116.7	2.2
2	*5240.00	106.4 AV			1.26 V	228	104.2	2.2
3	5350.00	46.4 PK	74.0	-27.6	1.26 V	228	44.1	2.3
4	5350.00	37.0 AV	54.0	-17.0	1.26 V	228	34.7	2.3
5	5433.00	50.6 PK	74.0	-23.4	1.26 V	228	48.1	2.5
6	5433.00	38.6 AV	54.0	-15.4	1.26 V	228	36.1	2.5
7	#10480.00	52.3 PK	68.2	-15.9	1.75 V	299	39.9	12.4
8	15720.00	53.7 PK	74.0	-20.3	1.39 V	163	41.7	12.0
9	15720.00	41.3 AV	54.0	-12.7	1.39 V	163	29.3	12.0

REMARKS:

1. Emission Level(dBuV/m) = Raw Value(dBuV) + Correction Factor(dB/m)
2. Correction Factor(dB/m) = Antenna Factor(dB/m) + Cable Factor(dB) – Pre-Amplifier Factor(dB)
3. The other emission levels were very low against the limit.
4. Margin value = Emission Level – Limit value
5. " * ": Fundamental frequency.
6. " # ": The radiated frequency is out of the restricted band.

CHANNEL	TX Channel 149	DETECTOR FUNCTION	Peak (PK)
FREQUENCY RANGE	1GHz ~ 40GHz		Average (AV)

ANTENNA POLARITY & TEST DISTANCE: HORIZONTAL AT 3 M

NO.	FREQ. (MHz)	EMISSION LEVEL (dBuV/m)	LIMIT (dBuV/m)	MARGIN (dB)	ANTENNA HEIGHT (m)	TABLE ANGLE (Degree)	RAW VALUE (dBuV)	CORRECTION FACTOR (dB/m)
1	#5651.04	65.9 PK	69.0	-3.1	1.61 H	259	66.7	-0.8
2	*5745.00	124.6 PK			1.61 H	259	121.7	2.9
3	*5745.00	112.7 AV			1.61 H	259	109.8	2.9
4	#5937.68	59.8 PK	68.2	-8.4	1.61 H	259	60.0	-0.2
5	11490.00	51.6 PK	74.0	-22.4	2.18 H	158	39.3	12.3
6	11490.00	44.7 AV	54.0	-9.3	2.18 H	158	32.4	12.3
7	#17235.00	52.6 PK	68.2	-15.6	1.38 H	189	37.3	15.3

ANTENNA POLARITY & TEST DISTANCE: VERTICAL AT 3 M

NO.	FREQ. (MHz)	EMISSION LEVEL (dBuV/m)	LIMIT (dBuV/m)	MARGIN (dB)	ANTENNA HEIGHT (m)	TABLE ANGLE (Degree)	RAW VALUE (dBuV)	CORRECTION FACTOR (dB/m)
1	#5644.34	63.9 PK	68.2	-4.3	2.72 V	283	61.2	2.7
2	*5745.00	123.6 PK			2.72 V	283	120.7	2.9
3	*5745.00	111.1 AV			2.72 V	283	108.2	2.9
4	#5939.88	58.8 PK	68.2	-9.4	2.72 V	283	55.4	3.4
5	11490.00	52.0 PK	74.0	-22.0	1.83 V	306	39.7	12.3
6	11490.00	45.0 AV	54.0	-9.0	1.83 V	306	32.7	12.3
7	#17235.00	53.5 PK	68.2	-14.7	1.44 V	175	38.2	15.3

REMARKS:

- Emission Level(dBuV/m) = Raw Value(dBuV) + Correction Factor(dB/m)
- Correction Factor(dB/m) = Antenna Factor(dB/m) + Cable Factor(dB) – Pre-Amplifier Factor(dB)
- The other emission levels were very low against the limit.
- Margin value = Emission Level – Limit value
- " * ": Fundamental frequency.
- " # ": The radiated frequency is out of the restricted band.

CHANNEL	TX Channel 157	DETECTOR FUNCTION	Peak (PK)
FREQUENCY RANGE	1GHz ~ 40GHz		Average (AV)

ANTENNA POLARITY & TEST DISTANCE: HORIZONTAL AT 3 M

NO.	FREQ. (MHz)	EMISSION LEVEL (dBuV/m)	LIMIT (dBuV/m)	MARGIN (dB)	ANTENNA HEIGHT (m)	TABLE ANGLE (Degree)	RAW VALUE (dBuV)	CORRECTION FACTOR (dB/m)
1	#5639.54	57.6 PK	68.2	-10.6	1.46 H	292	54.9	2.7
2	*5785.00	121.2 PK			1.46 H	292	118.1	3.1
3	*5785.00	109.8 AV			1.46 H	292	106.7	3.1
4	#5980.87	57.6 PK	68.2	-10.6	1.46 H	292	54.4	3.2
5	11570.00	50.7 PK	74.0	-23.3	2.23 H	165	38.3	12.4
6	11570.00	44.3 AV	54.0	-9.7	2.23 H	165	31.9	12.4
7	#17355.00	52.2 PK	68.2	-16.0	1.41 H	185	36.2	16.0

ANTENNA POLARITY & TEST DISTANCE: VERTICAL AT 3 M

NO.	FREQ. (MHz)	EMISSION LEVEL (dBuV/m)	LIMIT (dBuV/m)	MARGIN (dB)	ANTENNA HEIGHT (m)	TABLE ANGLE (Degree)	RAW VALUE (dBuV)	CORRECTION FACTOR (dB/m)
1	#5600.93	59.6 PK	68.2	-8.6	1.61 V	234	56.8	2.8
2	*5785.00	124.4 PK			1.61 V	234	121.3	3.1
3	*5785.00	112.2 AV			1.61 V	234	109.1	3.1
4	#5979.64	59.3 PK	68.2	-8.9	1.61 V	234	56.1	3.2
5	11570.00	52.1 PK	74.0	-21.9	1.74 V	307	39.7	12.4
6	11570.00	45.2 AV	54.0	-8.8	1.74 V	307	32.8	12.4
7	#17355.00	53.1 PK	68.2	-15.1	1.47 V	163	37.1	16.0

REMARKS:

1. Emission Level(dBuV/m) = Raw Value(dBuV) + Correction Factor(dB/m)
2. Correction Factor(dB/m) = Antenna Factor(dB/m) + Cable Factor(dB) – Pre-Amplifier Factor(dB)
3. The other emission levels were very low against the limit.
4. Margin value = Emission Level – Limit value
5. " * ": Fundamental frequency.
6. " # ": The radiated frequency is out of the restricted band.

CHANNEL	TX Channel 165	DETECTOR FUNCTION	Peak (PK)
FREQUENCY RANGE	1GHz ~ 40GHz		Average (AV)

ANTENNA POLARITY & TEST DISTANCE: HORIZONTAL AT 3 M

NO.	FREQ. (MHz)	EMISSION LEVEL (dBuV/m)	LIMIT (dBuV/m)	MARGIN (dB)	ANTENNA HEIGHT (m)	TABLE ANGLE (Degree)	RAW VALUE (dBuV)	CORRECTION FACTOR (dB/m)
1	#5631.77	57.9 PK	68.2	-10.3	3.06 H	277	55.1	2.8
2	*5825.00	121.1 PK			3.06 H	277	117.9	3.2
3	*5825.00	108.7 AV			3.06 H	277	105.5	3.2
4	#6002.12	57.9 PK	68.2	-10.3	3.06 H	277	54.7	3.2
5	11650.00	51.0 PK	74.0	-23.0	2.14 H	145	38.6	12.4
6	11650.00	44.3 AV	54.0	-9.7	2.14 H	145	31.9	12.4
7	#17475.00	52.5 PK	68.2	-15.7	1.40 H	213	35.1	17.4

ANTENNA POLARITY & TEST DISTANCE: VERTICAL AT 3 M

NO.	FREQ. (MHz)	EMISSION LEVEL (dBuV/m)	LIMIT (dBuV/m)	MARGIN (dB)	ANTENNA HEIGHT (m)	TABLE ANGLE (Degree)	RAW VALUE (dBuV)	CORRECTION FACTOR (dB/m)
1	#5638.44	58.4 PK	68.2	-9.8	2.44 V	320	55.7	2.7
2	*5825.00	124.2 PK			2.44 V	320	121.0	3.2
3	*5825.00	111.7 AV			2.44 V	320	108.5	3.2
4	#5926.78	58.8 PK	68.2	-9.4	2.44 V	320	55.4	3.4
5	11650.00	51.7 PK	74.0	-22.3	1.76 V	310	39.3	12.4
6	11650.00	44.9 AV	54.0	-9.1	1.76 V	310	32.5	12.4
7	#17475.00	53.4 PK	68.2	-14.8	1.48 V	180	36.0	17.4

REMARKS:

- Emission Level(dBuV/m) = Raw Value(dBuV) + Correction Factor(dB/m)
- Correction Factor(dB/m) = Antenna Factor(dB/m) + Cable Factor(dB) – Pre-Amplifier Factor(dB)
- The other emission levels were very low against the limit.
- Margin value = Emission Level – Limit value
- " * ": Fundamental frequency.
- " # ": The radiated frequency is out of the restricted band.

802.11ax (HE40)

CHANNEL	TX Channel 38	DETECTOR FUNCTION	Peak (PK)
FREQUENCY RANGE	1GHz ~ 40GHz		Average (AV)

ANTENNA POLARITY & TEST DISTANCE: HORIZONTAL AT 3 M

NO.	FREQ. (MHz)	EMISSION LEVEL (dBuV/m)	LIMIT (dBuV/m)	MARGIN (dB)	ANTENNA HEIGHT (m)	TABLE ANGLE (Degree)	RAW VALUE (dBuV)	CORRECTION FACTOR (dB/m)
1	5150.00	64.6 PK	74.0	-9.4	1.22 H	278	62.0	2.6
2	5150.00	53.9 AV	54.0	-0.1	1.22 H	278	51.3	2.6
3	*5190.00	114.5 PK			1.22 H	278	112.0	2.5
4	*5190.00	102.9 AV			1.22 H	278	100.4	2.5
5	5350.00	51.5 PK	74.0	-22.5	1.22 H	278	49.2	2.3
6	5350.00	40.3 AV	54.0	-13.7	1.22 H	278	38.0	2.3
7	5375.00	53.6 PK	74.0	-20.4	1.22 H	278	51.2	2.4
8	5375.00	42.1 AV	54.0	-11.9	1.22 H	278	39.7	2.4
9	#10380.00	50.7 PK	68.2	-17.5	2.21 H	156	38.7	12.0
10	15570.00	52.5 PK	74.0	-21.5	1.39 H	201	39.9	12.6
11	15570.00	40.1 AV	54.0	-13.9	1.39 H	201	27.5	12.6

ANTENNA POLARITY & TEST DISTANCE: VERTICAL AT 3 M

NO.	FREQ. (MHz)	EMISSION LEVEL (dBuV/m)	LIMIT (dBuV/m)	MARGIN (dB)	ANTENNA HEIGHT (m)	TABLE ANGLE (Degree)	RAW VALUE (dBuV)	CORRECTION FACTOR (dB/m)
1	5150.00	64.6 PK	74.0	-9.4	2.14 V	253	62.0	2.6
2	5150.00	53.6 AV	54.0	-0.4	2.14 V	253	51.0	2.6
3	*5190.00	114.9 PK			2.14 V	253	112.4	2.5
4	*5190.00	103.1 AV			2.14 V	253	100.6	2.5
5	5350.00	52.1 PK	74.0	-21.9	2.14 V	253	49.8	2.3
6	5350.00	40.1 AV	54.0	-13.9	2.14 V	253	37.8	2.3
7	5375.00	52.4 PK	74.0	-21.6	2.14 V	253	50.0	2.4
8	5375.00	41.6 AV	54.0	-12.4	2.14 V	253	39.2	2.4
9	#10380.00	51.9 PK	68.2	-16.3	1.72 V	311	39.9	12.0
10	15570.00	53.4 PK	74.0	-20.6	1.48 V	181	40.8	12.6
11	15570.00	40.9 AV	54.0	-13.1	1.48 V	181	28.3	12.6

REMARKS:

- Emission Level(dBuV/m) = Raw Value(dBuV) + Correction Factor(dB/m)
- Correction Factor(dB/m) = Antenna Factor(dB/m) + Cable Factor(dB) – Pre-Amplifier Factor(dB)
- The other emission levels were very low against the limit.
- Margin value = Emission Level – Limit value
- " * ": Fundamental frequency.
- " # ": The radiated frequency is out of the restricted band.

CHANNEL	TX Channel 46	DETECTOR FUNCTION	Peak (PK)
FREQUENCY RANGE	1GHz ~ 40GHz		Average (AV)

ANTENNA POLARITY & TEST DISTANCE: HORIZONTAL AT 3 M

NO.	FREQ. (MHz)	EMISSION LEVEL (dBuV/m)	LIMIT (dBuV/m)	MARGIN (dB)	ANTENNA HEIGHT (m)	TABLE ANGLE (Degree)	RAW VALUE (dBuV)	CORRECTION FACTOR (dB/m)
1	5150.00	65.2 PK	74.0	-8.8	2.10 H	252	62.6	2.6
2	5150.00	53.6 AV	54.0	-0.4	2.10 H	252	51.0	2.6
3	*5230.00	121.1 PK			2.10 H	252	118.9	2.2
4	*5230.00	108.2 AV			2.10 H	252	106.0	2.2
5	5350.00	58.8 PK	74.0	-15.2	2.10 H	252	56.5	2.3
6	5350.00	46.6 AV	54.0	-7.4	2.10 H	252	44.3	2.3
7	#10460.00	50.6 PK	68.2	-17.6	2.22 H	167	38.2	12.4
8	15690.00	53.0 PK	74.0	-21.0	1.41 H	192	40.8	12.2
9	15690.00	39.1 AV	54.0	-14.9	1.41 H	192	26.9	12.2

ANTENNA POLARITY & TEST DISTANCE: VERTICAL AT 3 M

NO.	FREQ. (MHz)	EMISSION LEVEL (dBuV/m)	LIMIT (dBuV/m)	MARGIN (dB)	ANTENNA HEIGHT (m)	TABLE ANGLE (Degree)	RAW VALUE (dBuV)	CORRECTION FACTOR (dB/m)
1	5150.00	65.0 PK	74.0	-9.0	2.09 V	267	62.4	2.6
2	5150.00	53.3 AV	54.0	-0.7	2.09 V	267	50.7	2.6
3	*5230.00	121.5 PK			2.09 V	267	119.3	2.2
4	*5230.00	108.4 AV			2.09 V	267	106.2	2.2
5	5350.00	58.6 PK	74.0	-15.4	2.09 V	267	56.3	2.3
6	5350.00	46.3 AV	54.0	-7.7	2.09 V	267	44.0	2.3
7	#10460.00	52.4 PK	68.2	-15.8	1.83 V	294	40.0	12.4
8	15690.00	53.9 PK	74.0	-20.1	1.37 V	170	41.7	12.2
9	15690.00	41.2 AV	54.0	-12.8	1.37 V	170	29.0	12.2

REMARKS:

1. Emission Level(dBuV/m) = Raw Value(dBuV) + Correction Factor(dB/m)
2. Correction Factor(dB/m) = Antenna Factor(dB/m) + Cable Factor(dB) – Pre-Amplifier Factor(dB)
3. The other emission levels were very low against the limit.
4. Margin value = Emission Level – Limit value
5. " * ": Fundamental frequency.
6. " # ": The radiated frequency is out of the restricted band.

CHANNEL	TX Channel 151	DETECTOR FUNCTION	Peak (PK)
FREQUENCY RANGE	1GHz ~ 40GHz		Average (AV)

ANTENNA POLARITY & TEST DISTANCE: HORIZONTAL AT 3 M

NO.	FREQ. (MHz)	EMISSION LEVEL (dBuV/m)	LIMIT (dBuV/m)	MARGIN (dB)	ANTENNA HEIGHT (m)	TABLE ANGLE (Degree)	RAW VALUE (dBuV)	CORRECTION FACTOR (dB/m)
1	#5649.39	67.7 PK	68.2	-0.5	2.61 H	287	65.0	2.7
2	*5755.00	119.6 PK			2.61 H	287	116.6	3.0
3	*5755.00	108.1 AV			2.61 H	287	105.1	3.0
4	#5955.22	59.6 PK	68.2	-8.6	2.61 H	287	56.4	3.2
5	11510.00	51.1 PK	74.0	-22.9	2.12 H	149	38.8	12.3
6	11510.00	44.3 AV	54.0	-9.7	2.12 H	149	32.0	12.3
7	#17265.00	52.1 PK	68.2	-16.1	1.38 H	216	36.7	15.4

ANTENNA POLARITY & TEST DISTANCE: VERTICAL AT 3 M

NO.	FREQ. (MHz)	EMISSION LEVEL (dBuV/m)	LIMIT (dBuV/m)	MARGIN (dB)	ANTENNA HEIGHT (m)	TABLE ANGLE (Degree)	RAW VALUE (dBuV)	CORRECTION FACTOR (dB/m)
1	#5647.87	63.8 PK	68.2	-4.4	1.62 V	238	61.1	2.7
2	*5755.00	118.6 PK			1.62 V	238	115.6	3.0
3	*5755.00	108.5 AV			1.62 V	238	105.5	3.0
4	#5963.68	57.9 PK	68.2	-10.3	1.62 V	238	54.6	3.3
5	11510.00	52.4 PK	74.0	-21.6	1.79 V	307	40.1	12.3
6	11510.00	45.6 AV	54.0	-8.4	1.79 V	307	33.3	12.3
7	#17265.00	53.0 PK	68.2	-15.2	1.47 V	159	37.6	15.4

REMARKS:

- Emission Level(dBuV/m) = Raw Value(dBuV) + Correction Factor(dB/m)
- Correction Factor(dB/m) = Antenna Factor(dB/m) + Cable Factor(dB) – Pre-Amplifier Factor(dB)
- The other emission levels were very low against the limit.
- Margin value = Emission Level – Limit value
- " * ": Fundamental frequency.
- " # ": The radiated frequency is out of the restricted band.

CHANNEL	TX Channel 159	DETECTOR FUNCTION	Peak (PK)
FREQUENCY RANGE	1GHz ~ 40GHz		Average (AV)

ANTENNA POLARITY & TEST DISTANCE: HORIZONTAL AT 3 M

NO.	FREQ. (MHz)	EMISSION LEVEL (dBuV/m)	LIMIT (dBuV/m)	MARGIN (dB)	ANTENNA HEIGHT (m)	TABLE ANGLE (Degree)	RAW VALUE (dBuV)	CORRECTION FACTOR (dB/m)
1	#5644.94	63.6 PK	68.2	-4.6	1.57 H	260	60.9	2.7
2	*5795.00	122.9 PK			1.57 H	260	119.9	3.0
3	*5795.00	110.3 AV			1.57 H	260	107.3	3.0
4	#5930.76	68.0 PK	68.2	-0.2	1.57 H	260	64.6	3.4
5	11590.00	51.3 PK	74.0	-22.7	2.18 H	166	38.9	12.4
6	11590.00	44.7 AV	54.0	-9.3	2.18 H	166	32.3	12.4
7	#17385.00	53.1 PK	68.2	-15.1	1.46 H	191	36.9	16.2

ANTENNA POLARITY & TEST DISTANCE: VERTICAL AT 3 M

NO.	FREQ. (MHz)	EMISSION LEVEL (dBuV/m)	LIMIT (dBuV/m)	MARGIN (dB)	ANTENNA HEIGHT (m)	TABLE ANGLE (Degree)	RAW VALUE (dBuV)	CORRECTION FACTOR (dB/m)
1	#5648.92	67.0 PK	68.2	-1.2	1.65 V	288	64.3	2.7
2	*5795.00	119.6 PK			1.65 V	288	116.6	3.0
3	*5795.00	109.1 AV			1.65 V	288	106.1	3.0
4	#5933.34	67.9 PK	68.2	-0.3	1.65 V	288	64.5	3.4
5	11590.00	51.9 PK	74.0	-22.1	1.81 V	306	39.5	12.4
6	11590.00	45.3 AV	54.0	-8.7	1.81 V	306	32.9	12.4
7	#17385.00	54.0 PK	68.2	-14.2	1.46 V	183	37.8	16.2

REMARKS:

- Emission Level(dBuV/m) = Raw Value(dBuV) + Correction Factor(dB/m)
- Correction Factor(dB/m) = Antenna Factor(dB/m) + Cable Factor(dB) – Pre-Amplifier Factor(dB)
- The other emission levels were very low against the limit.
- Margin value = Emission Level – Limit value
- " * ": Fundamental frequency.
- " # ": The radiated frequency is out of the restricted band.

802.11ax (HE80)

CHANNEL	TX Channel 42	DETECTOR FUNCTION	Peak (PK)
FREQUENCY RANGE	1GHz ~ 40GHz		Average (AV)

ANTENNA POLARITY & TEST DISTANCE: HORIZONTAL AT 3 M

NO.	FREQ. (MHz)	EMISSION LEVEL (dBuV/m)	LIMIT (dBuV/m)	MARGIN (dB)	ANTENNA HEIGHT (m)	TABLE ANGLE (Degree)	RAW VALUE (dBuV)	CORRECTION FACTOR (dB/m)
1	5150.00	65.9 PK	74.0	-8.1	1.68 H	292	63.3	2.6
2	5150.00	52.7 AV	54.0	-1.3	1.68 H	292	50.1	2.6
3	*5210.00	105.9 PK			1.68 H	292	103.5	2.4
4	*5210.00	93.5 AV			1.68 H	292	91.1	2.4
5	5350.00	49.4 PK	74.0	-24.6	1.68 H	292	47.1	2.3
6	5350.00	41.8 AV	54.0	-12.2	1.68 H	292	39.5	2.3
7	5375.00	53.3 PK	74.0	-20.7	1.68 H	292	50.9	2.4
8	5375.00	44.3 AV	54.0	-9.7	1.68 H	292	41.9	2.4
9	#10420.00	50.6 PK	68.2	-17.6	2.13 H	148	38.4	12.2
10	15630.00	52.2 PK	74.0	-21.8	1.44 H	187	39.5	12.7
11	15630.00	39.5 AV	54.0	-14.5	1.44 H	187	26.8	12.7

ANTENNA POLARITY & TEST DISTANCE: VERTICAL AT 3 M

NO.	FREQ. (MHz)	EMISSION LEVEL (dBuV/m)	LIMIT (dBuV/m)	MARGIN (dB)	ANTENNA HEIGHT (m)	TABLE ANGLE (Degree)	RAW VALUE (dBuV)	CORRECTION FACTOR (dB/m)
1	5150.00	64.2 PK	74.0	-9.8	1.49 V	297	61.6	2.6
2	5150.00	53.9 AV	54.0	-0.1	1.49 V	297	51.3	2.6
3	*5210.00	108.6 PK			1.49 V	297	106.2	2.4
4	*5210.00	96.5 AV			1.49 V	297	94.1	2.4
5	5350.00	48.6 PK	74.0	-25.4	1.49 V	297	46.3	2.3
6	5350.00	40.6 AV	54.0	-13.4	1.49 V	297	38.3	2.3
7	5375.00	51.6 PK	74.0	-22.4	1.49 V	297	49.2	2.4
8	5375.00	41.8 AV	54.0	-12.2	1.49 V	297	39.4	2.4
9	#10420.00	52.8 PK	68.2	-15.4	1.80 V	298	40.6	12.2
10	15630.00	53.1 PK	74.0	-20.9	1.48 V	191	40.4	12.7
11	15630.00	40.3 AV	54.0	-13.7	1.48 V	191	27.6	12.7

REMARKS:

- Emission Level(dBuV/m) = Raw Value(dBuV) + Correction Factor(dB/m)
- Correction Factor(dB/m) = Antenna Factor(dB/m) + Cable Factor(dB) – Pre-Amplifier Factor(dB)
- The other emission levels were very low against the limit.
- Margin value = Emission Level – Limit value
- " * ": Fundamental frequency.
- " # ": The radiated frequency is out of the restricted band.

CHANNEL	TX Channel 155	DETECTOR FUNCTION	Peak (PK)
FREQUENCY RANGE	1GHz ~ 40GHz		Average (AV)

ANTENNA POLARITY & TEST DISTANCE: HORIZONTAL AT 3 M

NO.	FREQ. (MHz)	EMISSION LEVEL (dBuV/m)	LIMIT (dBuV/m)	MARGIN (dB)	ANTENNA HEIGHT (m)	TABLE ANGLE (Degree)	RAW VALUE (dBuV)	CORRECTION FACTOR (dB/m)
1	#5640.49	68.1 PK	68.2	-0.1	1.60 H	251	65.4	2.7
2	*5775.00	114.5 PK			1.60 H	251	111.5	3.0
3	*5775.00	101.8 AV			1.60 H	251	98.8	3.0
4	#5935.71	62.5 PK	68.2	-5.7	1.60 H	251	59.1	3.4
5	11550.00	50.9 PK	74.0	-23.1	2.14 H	145	38.5	12.4
6	11550.00	44.4 AV	54.0	-9.6	2.14 H	145	32.0	12.4
7	#17325.00	52.8 PK	68.2	-15.4	1.46 H	192	37.1	15.7

ANTENNA POLARITY & TEST DISTANCE: VERTICAL AT 3 M

NO.	FREQ. (MHz)	EMISSION LEVEL (dBuV/m)	LIMIT (dBuV/m)	MARGIN (dB)	ANTENNA HEIGHT (m)	TABLE ANGLE (Degree)	RAW VALUE (dBuV)	CORRECTION FACTOR (dB/m)
1	#5644.22	67.9 PK	68.2	-0.3	2.56 V	314	65.2	2.7
2	*5775.00	112.8 PK			2.56 V	314	109.8	3.0
3	*5775.00	103.1 AV			2.56 V	314	100.1	3.0
4	#5936.95	65.0 PK	68.2	-3.2	2.56 V	314	61.6	3.4
5	11550.00	52.3 PK	74.0	-21.7	1.83 V	300	39.9	12.4
6	11550.00	45.2 AV	54.0	-8.8	1.83 V	300	32.8	12.4
7	#17325.00	53.7 PK	68.2	-14.5	1.39 V	167	38.0	15.7

REMARKS:

1. Emission Level(dBuV/m) = Raw Value(dBuV) + Correction Factor(dB/m)
2. Correction Factor(dB/m) = Antenna Factor(dB/m) + Cable Factor(dB) – Pre-Amplifier Factor(dB)
3. The other emission levels were very low against the limit.
4. Margin value = Emission Level – Limit value
5. " * ": Fundamental frequency.
6. " # ": The radiated frequency is out of the restricted band.

802.11ax (HE80+80)

CHANNEL	TX Channel 42+155	DETECTOR FUNCTION	Peak (PK)
FREQUENCY RANGE	1GHz ~ 40GHz		Average (AV)

ANTENNA POLARITY & TEST DISTANCE: HORIZONTAL AT 3 M

NO.	FREQ. (MHz)	EMISSION LEVEL (dBuV/m)	LIMIT (dBuV/m)	MARGIN (dB)	ANTENNA HEIGHT (m)	TABLE ANGLE (Degree)	RAW VALUE (dBuV)	CORRECTION FACTOR (dB/m)
1	5150.00	62.5 PK	74.0	-11.5	1.63 H	241	59.9	2.6
2	5150.00	51.8 AV	54.0	-2.2	1.63 H	241	49.2	2.6
3	*5210.00	104.6 PK			1.63 H	241	102.2	2.4
4	*5210.00	94.1 AV			1.63 H	241	91.7	2.4
5	5350.00	51.6 PK	74.0	-22.4	1.63 H	241	49.3	2.3
6	5350.00	39.9 AV	54.0	-14.1	1.63 H	241	37.6	2.3
7	#5628.52	57.0 PK	68.2	-11.2	2.21 H	244	57.8	-0.8
8	*5775.00	105.9 PK			2.21 H	244	102.9	3.0
9	*5775.00	93.7 AV			2.21 H	244	90.7	3.0
10	#5985.34	58.5 PK	68.2	-9.7	2.21 H	244	58.7	-0.2
11	#10420.00	51.4 PK	68.2	-16.8	2.15 H	156	39.2	12.2
12	11550.00	51.1 PK	74.0	-22.9	2.09 H	153	38.7	12.4
13	11550.00	44.3 AV	54.0	-9.7	2.09 H	153	31.9	12.4
14	15630.00	52.8 PK	74.0	-21.2	1.44 H	205	40.1	12.7
15	15630.00	40.5 AV	54.0	-13.5	1.44 H	205	27.8	12.7
16	#17325.00	52.2 PK	68.2	-16.0	1.45 H	208	36.5	15.7

ANTENNA POLARITY & TEST DISTANCE: VERTICAL AT 3 M

NO.	FREQ. (MHz)	EMISSION LEVEL (dBuV/m)	LIMIT (dBuV/m)	MARGIN (dB)	ANTENNA HEIGHT (m)	TABLE ANGLE (Degree)	RAW VALUE (dBuV)	CORRECTION FACTOR (dB/m)
1	5150.00	63.7 PK	74.0	-10.3	1.09 V	260	61.1	2.6
2	5150.00	53.6 AV	54.0	-0.4	1.09 V	260	51.0	2.6
3	*5210.00	105.8 PK			1.09 V	260	103.4	2.4
4	*5210.00	94.5 AV			1.09 V	260	92.1	2.4
5	5350.00	52.8 PK	74.0	-21.2	1.09 V	260	50.5	2.3
6	5350.00	41.7 AV	54.0	-12.3	1.09 V	260	39.4	2.3
7	#5632.04	57.5 PK	68.2	-10.7	1.52 V	280	54.7	2.8
8	*5775.00	107.1 PK			1.52 V	280	104.1	3.0
9	*5775.00	94.2 AV			1.52 V	280	91.2	3.0
10	#5947.66	57.1 PK	68.2	-11.1	1.52 V	280	53.9	3.2
11	#10420.00	51.8 PK	68.2	-16.4	1.82 V	299	39.6	12.2
12	11550.00	52.0 PK	74.0	-22.0	1.77 V	321	39.6	12.4
13	11550.00	45.2 AV	54.0	-8.8	1.77 V	321	32.8	12.4
14	15630.00	53.8 PK	74.0	-20.2	1.40 V	177	41.1	12.7
15	15630.00	41.1 AV	54.0	-12.9	1.40 V	177	28.4	12.7
16	#17325.00	53.1 PK	68.2	-15.1	1.38 V	182	37.4	15.7

REMARKS:

- Emission Level(dBuV/m) = Raw Value(dBuV) + Correction Factor(dB/m)
- Correction Factor(dB/m) = Antenna Factor(dB/m) + Cable Factor(dB) – Pre-Amplifier Factor(dB)
- The other emission levels were very low against the limit.
- Margin value = Emission Level – Limit value
- " * ": Fundamental frequency.
- " # ": The radiated frequency is out of the restricted band.

4.1.9 Test Results (Mode 3)

Above 1GHz Data:

802.11a

CHANNEL	TX Channel 36	DETECTOR FUNCTION	Peak (PK)
FREQUENCY RANGE	1GHz ~ 40GHz		Average (AV)

ANTENNA POLARITY & TEST DISTANCE: HORIZONTAL AT 3 M								
NO.	FREQ. (MHz)	EMISSION LEVEL (dBuV/m)	LIMIT (dBuV/m)	MARGIN (dB)	ANTENNA HEIGHT (m)	TABLE ANGLE (Degree)	RAW VALUE (dBuV)	CORRECTION FACTOR (dB/m)
1	5150.00	67.9 PK	74.0	-6.1	1.58 H	205	65.3	2.6
2	5150.00	53.8 AV	54.0	-0.2	1.58 H	205	51.2	2.6
3	*5180.00	111.7 PK			1.58 H	205	109.2	2.5
4	*5180.00	102.1 AV			1.58 H	205	99.6	2.5
5	#10360.00	49.2 PK	68.2	-19.0	2.75 H	284	37.3	11.9
6	15540.00	54.5 PK	74.0	-19.5	2.04 H	25	42.1	12.4
7	15540.00	41.5 AV	54.0	-12.5	2.04 H	25	29.1	12.4
ANTENNA POLARITY & TEST DISTANCE: VERTICAL AT 3 M								
NO.	FREQ. (MHz)	EMISSION LEVEL (dBuV/m)	LIMIT (dBuV/m)	MARGIN (dB)	ANTENNA HEIGHT (m)	TABLE ANGLE (Degree)	RAW VALUE (dBuV)	CORRECTION FACTOR (dB/m)
1	5150.00	57.1 PK	74.0	-16.9	1.44 V	170	54.5	2.6
2	5150.00	43.6 AV	54.0	-10.4	1.44 V	170	41.0	2.6
3	*5180.00	104.4 PK			1.44 V	170	101.9	2.5
4	*5180.00	93.5 AV			1.44 V	170	91.0	2.5
5	#10360.00	52.4 PK	68.2	-15.8	1.93 V	296	40.5	11.9
6	15540.00	59.8 PK	74.0	-14.2	2.98 V	253	47.4	12.4
7	15540.00	49.1 AV	54.0	-4.9	2.98 V	253	36.7	12.4

REMARKS:

1. Emission Level(dBuV/m) = Raw Value(dBuV) + Correction Factor(dB/m)
2. Correction Factor(dB/m) = Antenna Factor(dB/m) + Cable Factor(dB) – Pre-Amplifier Factor(dB)
3. The other emission levels were very low against the limit.
4. Margin value = Emission Level – Limit value
5. " * ": Fundamental frequency.
6. " # ": The radiated frequency is out of the restricted band.

CHANNEL	TX Channel 40	DETECTOR FUNCTION	Peak (PK)
FREQUENCY RANGE	1GHz ~ 40GHz		Average (AV)

ANTENNA POLARITY & TEST DISTANCE: HORIZONTAL AT 3 M

NO.	FREQ. (MHz)	EMISSION LEVEL (dBuV/m)	LIMIT (dBuV/m)	MARGIN (dB)	ANTENNA HEIGHT (m)	TABLE ANGLE (Degree)	RAW VALUE (dBuV)	CORRECTION FACTOR (dB/m)
1	5150.00	70.2 PK	74.0	-3.8	1.85 H	272	67.6	2.6
2	5150.00	53.9 AV	54.0	-0.1	1.85 H	272	51.3	2.6
3	*5200.00	116.6 PK			1.85 H	272	114.2	2.4
4	*5200.00	108.0 AV			1.85 H	272	105.6	2.4
5	5350.00	52.4 PK	74.0	-21.6	1.85 H	272	50.1	2.3
6	5350.00	41.2 AV	54.0	-12.8	1.85 H	272	38.9	2.3
7	#10400.00	50.3 PK	68.2	-17.9	2.70 H	288	38.1	12.2
8	15600.00	55.0 PK	74.0	-19.0	2.05 H	50	42.1	12.9
9	15600.00	42.1 AV	54.0	-11.9	2.05 H	50	29.2	12.9

ANTENNA POLARITY & TEST DISTANCE: VERTICAL AT 3 M

NO.	FREQ. (MHz)	EMISSION LEVEL (dBuV/m)	LIMIT (dBuV/m)	MARGIN (dB)	ANTENNA HEIGHT (m)	TABLE ANGLE (Degree)	RAW VALUE (dBuV)	CORRECTION FACTOR (dB/m)
1	5150.00	59.9 PK	74.0	-14.1	1.49 V	164	57.3	2.6
2	5150.00	44.2 AV	54.0	-9.8	1.49 V	164	41.6	2.6
3	*5200.00	109.0 PK			1.49 V	164	106.6	2.4
4	*5200.00	99.1 AV			1.49 V	164	96.7	2.4
5	5350.00	50.1 PK	74.0	-23.9	1.49 V	164	47.8	2.3
6	5350.00	36.6 AV	54.0	-17.4	1.49 V	164	34.3	2.3
7	#10400.00	53.1 PK	68.2	-15.1	1.79 V	279	40.9	12.2
8	15600.00	60.0 PK	74.0	-14.0	3.07 V	209	47.1	12.9
9	15600.00	49.8 AV	54.0	-4.2	3.07 V	209	36.9	12.9

REMARKS:

1. Emission Level(dBuV/m) = Raw Value(dBuV) + Correction Factor(dB/m)
2. Correction Factor(dB/m) = Antenna Factor(dB/m) + Cable Factor(dB) – Pre-Amplifier Factor(dB)
3. The other emission levels were very low against the limit.
4. Margin value = Emission Level – Limit value
5. " * ": Fundamental frequency.
6. " # ": The radiated frequency is out of the restricted band.

CHANNEL	TX Channel 48	DETECTOR FUNCTION	Peak (PK)
FREQUENCY RANGE	1GHz ~ 40GHz		Average (AV)

ANTENNA POLARITY & TEST DISTANCE: HORIZONTAL AT 3 M

NO.	FREQ. (MHz)	EMISSION LEVEL (dBuV/m)	LIMIT (dBuV/m)	MARGIN (dB)	ANTENNA HEIGHT (m)	TABLE ANGLE (Degree)	RAW VALUE (dBuV)	CORRECTION FACTOR (dB/m)
1	*5240.00	117.1 PK			1.71 H	296	114.9	2.2
2	*5240.00	106.9 AV			1.71 H	296	104.7	2.2
3	5350.00	53.6 PK	74.0	-20.4	1.71 H	296	51.3	2.3
4	5350.00	40.9 AV	54.0	-13.1	1.71 H	296	38.6	2.3
5	#10480.00	50.0 PK	68.2	-18.2	2.76 H	314	37.6	12.4
6	15720.00	53.8 PK	74.0	-20.2	2.11 H	32	41.8	12.0
7	15720.00	41.2 AV	54.0	-12.8	2.11 H	32	29.2	12.0

ANTENNA POLARITY & TEST DISTANCE: VERTICAL AT 3 M

NO.	FREQ. (MHz)	EMISSION LEVEL (dBuV/m)	LIMIT (dBuV/m)	MARGIN (dB)	ANTENNA HEIGHT (m)	TABLE ANGLE (Degree)	RAW VALUE (dBuV)	CORRECTION FACTOR (dB/m)
1	*5240.00	109.5 PK			1.46 V	177	107.3	2.2
2	*5240.00	97.8 AV			1.46 V	177	95.6	2.2
3	5350.00	49.7 PK	74.0	-24.3	1.46 V	177	47.4	2.3
4	5350.00	37.1 AV	54.0	-16.9	1.46 V	177	34.8	2.3
5	#10480.00	52.3 PK	68.2	-15.9	1.91 V	290	39.9	12.4
6	15720.00	60.7 PK	74.0	-13.3	3.00 V	243	48.7	12.0
7	15720.00	49.6 AV	54.0	-4.4	3.00 V	243	37.6	12.0

REMARKS:

1. Emission Level(dBuV/m) = Raw Value(dBuV) + Correction Factor(dB/m)
2. Correction Factor(dB/m) = Antenna Factor(dB/m) + Cable Factor(dB) – Pre-Amplifier Factor(dB)
3. The other emission levels were very low against the limit.
4. Margin value = Emission Level – Limit value
5. " * ": Fundamental frequency.
6. " # ": The radiated frequency is out of the restricted band.

CHANNEL	TX Channel 149	DETECTOR FUNCTION	Peak (PK)
FREQUENCY RANGE	1GHz ~ 40GHz		Average (AV)

ANTENNA POLARITY & TEST DISTANCE: HORIZONTAL AT 3 M

NO.	FREQ. (MHz)	EMISSION LEVEL (dBuV/m)	LIMIT (dBuV/m)	MARGIN (dB)	ANTENNA HEIGHT (m)	TABLE ANGLE (Degree)	RAW VALUE (dBuV)	CORRECTION FACTOR (dB/m)
1	#5638.92	61.9 PK	68.2	-6.3	1.72 H	267	59.2	2.7
2	*5745.00	118.7 PK			1.72 H	267	115.8	2.9
3	*5745.00	108.9 AV			1.72 H	267	106.0	2.9
4	#6013.47	57.4 PK	68.2	-10.8	1.72 H	267	54.2	3.2
5	11490.00	47.1 PK	74.0	-26.9	1.62 H	197	34.8	12.3
6	11490.00	40.6 AV	54.0	-13.4	1.62 H	197	28.3	12.3
7	#17235.00	50.6 PK	68.2	-17.6	2.28 H	123	35.3	15.3

ANTENNA POLARITY & TEST DISTANCE: VERTICAL AT 3 M

NO.	FREQ. (MHz)	EMISSION LEVEL (dBuV/m)	LIMIT (dBuV/m)	MARGIN (dB)	ANTENNA HEIGHT (m)	TABLE ANGLE (Degree)	RAW VALUE (dBuV)	CORRECTION FACTOR (dB/m)
1	#5644.58	56.7 PK	68.2	-11.5	1.70 V	268	54.0	2.7
2	*5745.00	112.0 PK			1.49 V	166	109.1	2.9
3	*5745.00	102.5 AV			1.49 V	166	99.6	2.9
4	#5983.08	56.6 PK	68.2	-11.6	1.70 V	268	53.4	3.2
5	11490.00	48.9 PK	74.0	-25.1	1.32 V	235	36.6	12.3
6	11490.00	43.6 AV	54.0	-10.4	1.32 V	235	31.3	12.3
7	#17235.00	53.5 PK	68.2	-14.7	1.81 V	291	38.2	15.3

REMARKS:

1. Emission Level(dBuV/m) = Raw Value(dBuV) + Correction Factor(dB/m)
2. Correction Factor(dB/m) = Antenna Factor(dB/m) + Cable Factor(dB) – Pre-Amplifier Factor(dB)
3. The other emission levels were very low against the limit.
4. Margin value = Emission Level – Limit value
5. " * ": Fundamental frequency.
6. " # ": The radiated frequency is out of the restricted band.

CHANNEL	TX Channel 157	DETECTOR FUNCTION	Peak (PK)
FREQUENCY RANGE	1GHz ~ 40GHz		Average (AV)

ANTENNA POLARITY & TEST DISTANCE: HORIZONTAL AT 3 M

NO.	FREQ. (MHz)	EMISSION LEVEL (dBuV/m)	LIMIT (dBuV/m)	MARGIN (dB)	ANTENNA HEIGHT (m)	TABLE ANGLE (Degree)	RAW VALUE (dBuV)	CORRECTION FACTOR (dB/m)
1	#5623.21	56.9 PK	68.2	-11.3	1.72 H	281	54.1	2.8
2	*5785.00	119.8 PK			1.72 H	281	116.7	3.1
3	*5785.00	109.6 AV			1.72 H	281	106.5	3.1
4	#5971.91	57.1 PK	68.2	-11.1	1.72 H	281	53.9	3.2
5	11570.00	47.1 PK	74.0	-26.9	1.76 H	203	34.7	12.4
6	11570.00	40.9 AV	54.0	-13.1	1.76 H	203	28.5	12.4
7	#17355.00	50.1 PK	68.2	-18.1	2.39 H	104	34.1	16.0

ANTENNA POLARITY & TEST DISTANCE: VERTICAL AT 3 M

NO.	FREQ. (MHz)	EMISSION LEVEL (dBuV/m)	LIMIT (dBuV/m)	MARGIN (dB)	ANTENNA HEIGHT (m)	TABLE ANGLE (Degree)	RAW VALUE (dBuV)	CORRECTION FACTOR (dB/m)
1	#5621.70	56.5 PK	68.2	-11.7	2.57 V	194	53.7	2.8
2	*5785.00	112.1 PK			2.57 V	194	109.0	3.1
3	*5785.00	102.6 AV			2.57 V	194	99.5	3.1
4	#5958.11	56.9 PK	68.2	-11.3	2.57 V	194	53.7	3.2
5	11570.00	49.8 PK	74.0	-24.2	1.31 V	229	37.4	12.4
6	11570.00	44.0 AV	54.0	-10.0	1.31 V	229	31.6	12.4
7	#17355.00	53.3 PK	68.2	-14.9	1.73 V	294	37.3	16.0

REMARKS:

- Emission Level(dBuV/m) = Raw Value(dBuV) + Correction Factor(dB/m)
- Correction Factor(dB/m) = Antenna Factor(dB/m) + Cable Factor(dB) – Pre-Amplifier Factor(dB)
- The other emission levels were very low against the limit.
- Margin value = Emission Level – Limit value
- " * ": Fundamental frequency.
- " # ": The radiated frequency is out of the restricted band.

CHANNEL	TX Channel 165	DETECTOR FUNCTION	Peak (PK)
FREQUENCY RANGE	1GHz ~ 40GHz		Average (AV)

ANTENNA POLARITY & TEST DISTANCE: HORIZONTAL AT 3 M

NO.	FREQ. (MHz)	EMISSION LEVEL (dBuV/m)	LIMIT (dBuV/m)	MARGIN (dB)	ANTENNA HEIGHT (m)	TABLE ANGLE (Degree)	RAW VALUE (dBuV)	CORRECTION FACTOR (dB/m)
1	#5625.74	61.6 PK	68.2	-6.6	1.50 H	357	58.8	2.8
2	*5825.00	119.0 PK			1.62 H	332	115.8	3.2
3	*5825.00	108.9 AV			1.62 H	332	105.7	3.2
4	#5943.00	62.3 PK	68.2	-5.9	1.50 H	357	59.0	3.3
5	11650.00	48.2 PK	74.0	-25.8	1.76 H	227	35.8	12.4
6	11650.00	41.5 AV	54.0	-12.5	1.76 H	227	29.1	12.4
7	#17475.00	49.7 PK	68.2	-18.5	2.41 H	136	32.3	17.4

ANTENNA POLARITY & TEST DISTANCE: VERTICAL AT 3 M

NO.	FREQ. (MHz)	EMISSION LEVEL (dBuV/m)	LIMIT (dBuV/m)	MARGIN (dB)	ANTENNA HEIGHT (m)	TABLE ANGLE (Degree)	RAW VALUE (dBuV)	CORRECTION FACTOR (dB/m)
1	#5594.28	57.8 PK	68.2	-10.4	1.11 V	252	55.0	2.8
2	*5825.00	113.9 PK			1.11 V	252	110.7	3.2
3	*5825.00	103.8 AV			1.11 V	252	100.6	3.2
4	#5931.44	56.9 PK	68.2	-11.3	1.11 V	252	53.5	3.4
5	11650.00	49.1 PK	74.0	-24.9	1.32 V	211	36.7	12.4
6	11650.00	43.2 AV	54.0	-10.8	1.32 V	211	30.8	12.4
7	#17475.00	53.4 PK	68.2	-14.8	1.86 V	322	36.0	17.4

REMARKS:

1. Emission Level(dBuV/m) = Raw Value(dBuV) + Correction Factor(dB/m)
2. Correction Factor(dB/m) = Antenna Factor(dB/m) + Cable Factor(dB) – Pre-Amplifier Factor(dB)
3. The other emission levels were very low against the limit.
4. Margin value = Emission Level – Limit value
5. " * ": Fundamental frequency.
6. " # ": The radiated frequency is out of the restricted band.

802.11ax (HE20)

CHANNEL	TX Channel 36	DETECTOR FUNCTION	Peak (PK)
FREQUENCY RANGE	1GHz ~ 40GHz		Average (AV)

ANTENNA POLARITY & TEST DISTANCE: HORIZONTAL AT 3 M								
NO.	FREQ. (MHz)	EMISSION LEVEL (dBuV/m)	LIMIT (dBuV/m)	MARGIN (dB)	ANTENNA HEIGHT (m)	TABLE ANGLE (Degree)	RAW VALUE (dBuV)	CORRECTION FACTOR (dB/m)
1	5150.00	65.3 PK	74.0	-8.7	1.83 H	264	62.7	2.6
2	5150.00	53.6 AV	54.0	-0.4	1.83 H	264	51.0	2.6
3	*5180.00	116.5 PK			1.83 H	264	114.0	2.5
4	*5180.00	104.1 AV			1.83 H	264	101.6	2.5
5	#10360.00	50.7 PK	68.2	-17.5	2.76 H	298	38.8	11.9
6	15540.00	54.5 PK	74.0	-19.5	2.01 H	12	42.1	12.4
7	15540.00	41.6 AV	54.0	-12.4	2.01 H	12	29.2	12.4
ANTENNA POLARITY & TEST DISTANCE: VERTICAL AT 3 M								
NO.	FREQ. (MHz)	EMISSION LEVEL (dBuV/m)	LIMIT (dBuV/m)	MARGIN (dB)	ANTENNA HEIGHT (m)	TABLE ANGLE (Degree)	RAW VALUE (dBuV)	CORRECTION FACTOR (dB/m)
1	5150.00	54.8 PK	74.0	-19.2	1.35 V	286	52.2	2.6
2	5150.00	43.9 AV	54.0	-10.1	1.35 V	286	41.3	2.6
3	*5180.00	109.0 PK			1.35 V	286	106.5	2.5
4	*5180.00	95.5 AV			1.35 V	286	93.0	2.5
5	#10360.00	52.7 PK	68.2	-15.5	2.00 V	306	40.8	11.9
6	15540.00	60.6 PK	74.0	-13.4	2.91 V	251	48.2	12.4
7	15540.00	49.7 AV	54.0	-4.3	2.91 V	251	37.3	12.4

REMARKS:

1. Emission Level(dBuV/m) = Raw Value(dBuV) + Correction Factor(dB/m)
2. Correction Factor(dB/m) = Antenna Factor(dB/m) + Cable Factor(dB) – Pre-Amplifier Factor(dB)
3. The other emission levels were very low against the limit.
4. Margin value = Emission Level – Limit value
5. " * ": Fundamental frequency.
6. " # ": The radiated frequency is out of the restricted band.

CHANNEL	TX Channel 40	DETECTOR FUNCTION	Peak (PK)
FREQUENCY RANGE	1GHz ~ 40GHz		Average (AV)

ANTENNA POLARITY & TEST DISTANCE: HORIZONTAL AT 3 M

NO.	FREQ. (MHz)	EMISSION LEVEL (dBuV/m)	LIMIT (dBuV/m)	MARGIN (dB)	ANTENNA HEIGHT (m)	TABLE ANGLE (Degree)	RAW VALUE (dBuV)	CORRECTION FACTOR (dB/m)
1	5150.00	69.0 PK	74.0	-5.0	1.84 H	297	66.4	2.6
2	5150.00	53.9 AV	54.0	-0.1	1.84 H	297	51.3	2.6
3	*5200.00	119.3 PK			1.84 H	297	116.9	2.4
4	*5200.00	106.2 AV			1.84 H	297	103.8	2.4
5	5350.00	48.0 PK	74.0	-26.0	1.84 H	297	45.7	2.3
6	5350.00	38.5 AV	54.0	-15.5	1.84 H	297	36.2	2.3
7	5394.00	52.5 PK	74.0	-21.5	1.84 H	297	50.0	2.5
8	5394.00	39.9 AV	54.0	-14.1	1.84 H	297	37.4	2.5
9	#10400.00	50.6 PK	68.2	-17.6	2.80 H	298	38.4	12.2
10	15600.00	54.1 PK	74.0	-19.9	2.12 H	38	41.2	12.9
11	15600.00	41.1 AV	54.0	-12.9	2.12 H	38	28.2	12.9

ANTENNA POLARITY & TEST DISTANCE: VERTICAL AT 3 M

NO.	FREQ. (MHz)	EMISSION LEVEL (dBuV/m)	LIMIT (dBuV/m)	MARGIN (dB)	ANTENNA HEIGHT (m)	TABLE ANGLE (Degree)	RAW VALUE (dBuV)	CORRECTION FACTOR (dB/m)
1	5150.00	58.6 PK	74.0	-15.4	1.35 V	298	56.0	2.6
2	5150.00	44.2 AV	54.0	-9.8	1.35 V	298	41.6	2.6
3	*5200.00	111.3 PK			1.35 V	298	108.9	2.4
4	*5200.00	96.9 AV			1.35 V	298	94.5	2.4
5	5350.00	45.6 PK	74.0	-28.4	1.35 V	298	43.3	2.3
6	5350.00	36.3 AV	54.0	-17.7	1.35 V	298	34.0	2.3
7	5394.00	50.4 PK	74.0	-23.6	1.35 V	298	47.9	2.5
8	5394.00	37.4 AV	54.0	-16.6	1.35 V	298	34.9	2.5
9	#10400.00	53.1 PK	68.2	-15.1	1.90 V	321	40.9	12.2
10	15600.00	60.4 PK	74.0	-13.6	2.96 V	223	47.5	12.9
11	15600.00	49.7 AV	54.0	-4.3	2.96 V	223	36.8	12.9

REMARKS:

1. Emission Level(dBuV/m) = Raw Value(dBuV) + Correction Factor(dB/m)
2. Correction Factor(dB/m) = Antenna Factor(dB/m) + Cable Factor(dB) – Pre-Amplifier Factor(dB)
3. The other emission levels were very low against the limit.
4. Margin value = Emission Level – Limit value
5. " * ": Fundamental frequency.
6. " # ": The radiated frequency is out of the restricted band.

CHANNEL	TX Channel 48	DETECTOR FUNCTION	Peak (PK)
FREQUENCY RANGE	1GHz ~ 40GHz		Average (AV)

ANTENNA POLARITY & TEST DISTANCE: HORIZONTAL AT 3 M

NO.	FREQ. (MHz)	EMISSION LEVEL (dBuV/m)	LIMIT (dBuV/m)	MARGIN (dB)	ANTENNA HEIGHT (m)	TABLE ANGLE (Degree)	RAW VALUE (dBuV)	CORRECTION FACTOR (dB/m)
1	*5240.00	116.5 PK			1.73 H	298	114.3	2.2
2	*5240.00	104.6 AV			1.73 H	298	102.4	2.2
3	5350.00	52.7 PK	74.0	-21.3	1.73 H	298	50.4	2.3
4	5350.00	39.5 AV	54.0	-14.5	1.73 H	298	37.2	2.3
5	#10480.00	50.6 PK	68.2	-17.6	2.79 H	322	38.2	12.4
6	15720.00	54.5 PK	74.0	-19.5	2.15 H	38	42.5	12.0
7	15720.00	42.0 AV	54.0	-12.0	2.15 H	38	30.0	12.0

ANTENNA POLARITY & TEST DISTANCE: VERTICAL AT 3 M

NO.	FREQ. (MHz)	EMISSION LEVEL (dBuV/m)	LIMIT (dBuV/m)	MARGIN (dB)	ANTENNA HEIGHT (m)	TABLE ANGLE (Degree)	RAW VALUE (dBuV)	CORRECTION FACTOR (dB/m)
1	*5240.00	108.8 PK			1.36 V	283	106.6	2.2
2	*5240.00	95.3 AV			1.36 V	283	93.1	2.2
3	5350.00	50.0 PK	74.0	-24.0	1.36 V	283	47.7	2.3
4	5350.00	36.4 AV	54.0	-17.6	1.36 V	283	34.1	2.3
5	#10480.00	52.6 PK	68.2	-15.6	1.87 V	302	40.2	12.4
6	15720.00	60.5 PK	74.0	-13.5	2.98 V	203	48.5	12.0
7	15720.00	49.6 AV	54.0	-4.4	2.98 V	203	37.6	12.0

REMARKS:

- Emission Level(dBuV/m) = Raw Value(dBuV) + Correction Factor(dB/m)
- Correction Factor(dB/m) = Antenna Factor(dB/m) + Cable Factor(dB) – Pre-Amplifier Factor(dB)
- The other emission levels were very low against the limit.
- Margin value = Emission Level – Limit value
- " * ": Fundamental frequency.
- " # ": The radiated frequency is out of the restricted band.

CHANNEL	TX Channel 149	DETECTOR FUNCTION	Peak (PK)
FREQUENCY RANGE	1GHz ~ 40GHz		Average (AV)

ANTENNA POLARITY & TEST DISTANCE: HORIZONTAL AT 3 M

NO.	FREQ. (MHz)	EMISSION LEVEL (dBuV/m)	LIMIT (dBuV/m)	MARGIN (dB)	ANTENNA HEIGHT (m)	TABLE ANGLE (Degree)	RAW VALUE (dBuV)	CORRECTION FACTOR (dB/m)
1	#5644.52	58.8 PK	68.2	-9.4	1.73 H	283	56.1	2.7
2	*5745.00	120.2 PK			1.73 H	283	117.3	2.9
3	*5745.00	108.3 AV			1.73 H	283	105.4	2.9
4	#5944.25	56.9 PK	68.2	-11.3	1.73 H	283	53.6	3.3
5	11490.00	46.8 PK	74.0	-27.2	1.73 H	212	34.5	12.3
6	11490.00	40.4 AV	54.0	-13.6	1.73 H	212	28.1	12.3
7	#17235.00	50.0 PK	68.2	-18.2	2.38 H	131	34.7	15.3

ANTENNA POLARITY & TEST DISTANCE: VERTICAL AT 3 M

NO.	FREQ. (MHz)	EMISSION LEVEL (dBuV/m)	LIMIT (dBuV/m)	MARGIN (dB)	ANTENNA HEIGHT (m)	TABLE ANGLE (Degree)	RAW VALUE (dBuV)	CORRECTION FACTOR (dB/m)
1	#5646.43	56.8 PK	68.2	-11.4	1.59 V	270	54.1	2.7
2	*5745.00	111.6 PK			1.59 V	270	108.7	2.9
3	*5745.00	98.8 AV			1.59 V	270	95.9	2.9
4	#5959.28	57.3 PK	68.2	-10.9	1.59 V	270	54.1	3.2
5	11490.00	49.2 PK	74.0	-24.8	1.36 V	197	36.9	12.3
6	11490.00	43.8 AV	54.0	-10.2	1.36 V	197	31.5	12.3
7	#17235.00	55.2 PK	68.2	-13.0	1.85 V	289	39.9	15.3

REMARKS:

1. Emission Level(dBuV/m) = Raw Value(dBuV) + Correction Factor(dB/m)
2. Correction Factor(dB/m) = Antenna Factor(dB/m) + Cable Factor(dB) – Pre-Amplifier Factor(dB)
3. The other emission levels were very low against the limit.
4. Margin value = Emission Level – Limit value
5. " * ": Fundamental frequency.
6. " # ": The radiated frequency is out of the restricted band.

CHANNEL	TX Channel 157	DETECTOR FUNCTION	Peak (PK)
FREQUENCY RANGE	1GHz ~ 40GHz		Average (AV)

ANTENNA POLARITY & TEST DISTANCE: HORIZONTAL AT 3 M

NO.	FREQ. (MHz)	EMISSION LEVEL (dBuV/m)	LIMIT (dBuV/m)	MARGIN (dB)	ANTENNA HEIGHT (m)	TABLE ANGLE (Degree)	RAW VALUE (dBuV)	CORRECTION FACTOR (dB/m)
1	#5596.07	57.2 PK	68.2	-11.0	1.60 H	297	54.4	2.8
2	*5785.00	121.2 PK			1.65 H	277	118.1	3.1
3	*5785.00	109.6 AV			1.65 H	277	106.5	3.1
4	#6012.18	56.5 PK	68.2	-11.7	1.60 H	297	53.3	3.2
5	11570.00	47.1 PK	74.0	-26.9	1.66 H	216	34.7	12.4
6	11570.00	40.6 AV	54.0	-13.4	1.66 H	216	28.2	12.4
7	#17355.00	49.8 PK	68.2	-18.4	2.38 H	141	33.8	16.0

ANTENNA POLARITY & TEST DISTANCE: VERTICAL AT 3 M

NO.	FREQ. (MHz)	EMISSION LEVEL (dBuV/m)	LIMIT (dBuV/m)	MARGIN (dB)	ANTENNA HEIGHT (m)	TABLE ANGLE (Degree)	RAW VALUE (dBuV)	CORRECTION FACTOR (dB/m)
1	#5644.55	56.3 PK	68.2	-11.9	1.63 V	265	53.6	2.7
2	*5785.00	111.8 PK			1.63 V	265	108.7	3.1
3	*5785.00	99.2 AV			1.63 V	265	96.1	3.1
4	#5991.99	57.3 PK	68.2	-10.9	1.63 V	265	54.1	3.2
5	11570.00	49.1 PK	74.0	-24.9	1.36 V	216	36.7	12.4
6	11570.00	43.3 AV	54.0	-10.7	1.36 V	216	30.9	12.4
7	#17355.00	53.9 PK	68.2	-14.3	1.84 V	295	37.9	16.0

REMARKS:

- Emission Level(dBuV/m) = Raw Value(dBuV) + Correction Factor(dB/m)
- Correction Factor(dB/m) = Antenna Factor(dB/m) + Cable Factor(dB) – Pre-Amplifier Factor(dB)
- The other emission levels were very low against the limit.
- Margin value = Emission Level – Limit value
- " * ": Fundamental frequency.
- " # ": The radiated frequency is out of the restricted band.

CHANNEL	TX Channel 165	DETECTOR FUNCTION	Peak (PK)
FREQUENCY RANGE	1GHz ~ 40GHz		Average (AV)

ANTENNA POLARITY & TEST DISTANCE: HORIZONTAL AT 3 M

NO.	FREQ. (MHz)	EMISSION LEVEL (dBuV/m)	LIMIT (dBuV/m)	MARGIN (dB)	ANTENNA HEIGHT (m)	TABLE ANGLE (Degree)	RAW VALUE (dBuV)	CORRECTION FACTOR (dB/m)
1	#5642.15	57.5 PK	68.2	-10.7	1.63 H	299	54.8	2.7
2	*5825.00	120.9 PK			1.63 H	299	117.7	3.2
3	*5825.00	109.1 AV			1.63 H	299	105.9	3.2
4	#5922.40	58.7 PK	70.1	-11.4	1.63 H	299	55.3	3.4
5	11650.00	47.8 PK	74.0	-26.2	1.76 H	199	35.4	12.4
6	11650.00	41.0 AV	54.0	-13.0	1.76 H	199	28.6	12.4
7	#17475.00	50.4 PK	68.2	-17.8	2.36 H	146	33.0	17.4

ANTENNA POLARITY & TEST DISTANCE: VERTICAL AT 3 M

NO.	FREQ. (MHz)	EMISSION LEVEL (dBuV/m)	LIMIT (dBuV/m)	MARGIN (dB)	ANTENNA HEIGHT (m)	TABLE ANGLE (Degree)	RAW VALUE (dBuV)	CORRECTION FACTOR (dB/m)
1	#5624.16	57.6 PK	68.2	-10.6	1.14 V	241	54.8	2.8
2	*5825.00	115.1 PK			1.14 V	241	111.9	3.2
3	*5825.00	103.1 AV			1.14 V	241	99.9	3.2
4	#5974.13	57.7 PK	68.2	-10.5	1.14 V	241	54.5	3.2
5	11650.00	48.6 PK	74.0	-25.4	1.41 V	214	36.2	12.4
6	11650.00	43.2 AV	54.0	-10.8	1.41 V	214	30.8	12.4
7	#17475.00	53.7 PK	68.2	-14.5	1.78 V	290	36.3	17.4

REMARKS:

- Emission Level(dBuV/m) = Raw Value(dBuV) + Correction Factor(dB/m)
- Correction Factor(dB/m) = Antenna Factor(dB/m) + Cable Factor(dB) – Pre-Amplifier Factor(dB)
- The other emission levels were very low against the limit.
- Margin value = Emission Level – Limit value
- " * ": Fundamental frequency.
- " # ": The radiated frequency is out of the restricted band.

802.11ax (HE40)

CHANNEL	TX Channel 38	DETECTOR FUNCTION	Peak (PK)
FREQUENCY RANGE	1GHz ~ 40GHz		Average (AV)

ANTENNA POLARITY & TEST DISTANCE: HORIZONTAL AT 3 M

NO.	FREQ. (MHz)	EMISSION LEVEL (dBuV/m)	LIMIT (dBuV/m)	MARGIN (dB)	ANTENNA HEIGHT (m)	TABLE ANGLE (Degree)	RAW VALUE (dBuV)	CORRECTION FACTOR (dB/m)
1	5150.00	66.4 PK	74.0	-7.6	1.56 H	208	63.8	2.6
2	5150.00	53.7 AV	54.0	-0.3	1.56 H	208	51.1	2.6
3	*5190.00	109.2 PK			1.56 H	208	106.7	2.5
4	*5190.00	96.8 AV			1.56 H	208	94.3	2.5
5	5350.00	52.5 PK	74.0	-21.5	1.56 H	208	50.2	2.3
6	5350.00	40.3 AV	54.0	-13.7	1.56 H	208	38.0	2.3
7	#10380.00	48.2 PK	68.2	-20.0	2.85 H	272	36.2	12.0
8	15570.00	52.6 PK	74.0	-21.4	1.98 H	28	40.0	12.6
9	15570.00	40.4 AV	54.0	-13.6	1.98 H	28	27.8	12.6

ANTENNA POLARITY & TEST DISTANCE: VERTICAL AT 3 M

NO.	FREQ. (MHz)	EMISSION LEVEL (dBuV/m)	LIMIT (dBuV/m)	MARGIN (dB)	ANTENNA HEIGHT (m)	TABLE ANGLE (Degree)	RAW VALUE (dBuV)	CORRECTION FACTOR (dB/m)
1	5150.00	55.2 PK	74.0	-18.8	1.60 V	263	52.6	2.6
2	5150.00	43.2 AV	54.0	-10.8	1.60 V	263	40.6	2.6
3	*5190.00	101.7 PK			1.60 V	263	99.2	2.5
4	*5190.00	88.2 AV			1.60 V	263	85.7	2.5
5	5350.00	49.6 PK	74.0	-24.4	1.60 V	263	47.3	2.3
6	5350.00	38.4 AV	54.0	-15.6	1.60 V	263	36.1	2.3
7	#10380.00	51.8 PK	68.2	-16.4	2.06 V	280	39.8	12.0
8	15570.00	59.0 PK	74.0	-15.0	2.88 V	245	46.4	12.6
9	15570.00	48.4 AV	54.0	-5.6	2.88 V	245	35.8	12.6

REMARKS:

- Emission Level(dBuV/m) = Raw Value(dBuV) + Correction Factor(dB/m)
- Correction Factor(dB/m) = Antenna Factor(dB/m) + Cable Factor(dB) – Pre-Amplifier Factor(dB)
- The other emission levels were very low against the limit.
- Margin value = Emission Level – Limit value
- " * ": Fundamental frequency.
- " # ": The radiated frequency is out of the restricted band.

CHANNEL	TX Channel 46	DETECTOR FUNCTION	Peak (PK)
FREQUENCY RANGE	1GHz ~ 40GHz		Average (AV)

ANTENNA POLARITY & TEST DISTANCE: HORIZONTAL AT 3 M

NO.	FREQ. (MHz)	EMISSION LEVEL (dBuV/m)	LIMIT (dBuV/m)	MARGIN (dB)	ANTENNA HEIGHT (m)	TABLE ANGLE (Degree)	RAW VALUE (dBuV)	CORRECTION FACTOR (dB/m)
1	5150.00	66.8 PK	74.0	-7.2	1.72 H	294	64.2	2.6
2	5150.00	53.7 AV	54.0	-0.3	1.72 H	294	51.1	2.6
3	*5230.00	116.5 PK			1.72 H	294	114.3	2.2
4	*5230.00	103.6 AV			1.72 H	294	101.4	2.2
5	5350.00	55.9 PK	74.0	-18.1	1.72 H	294	53.6	2.3
6	5350.00	43.2 AV	54.0	-10.8	1.72 H	294	40.9	2.3
7	#10460.00	50.3 PK	68.2	-17.9	2.83 H	293	37.9	12.4
8	15690.00	53.8 PK	74.0	-20.2	2.01 H	58	41.6	12.2
9	15690.00	41.3 AV	54.0	-12.7	2.01 H	58	29.1	12.2

ANTENNA POLARITY & TEST DISTANCE: VERTICAL AT 3 M

NO.	FREQ. (MHz)	EMISSION LEVEL (dBuV/m)	LIMIT (dBuV/m)	MARGIN (dB)	ANTENNA HEIGHT (m)	TABLE ANGLE (Degree)	RAW VALUE (dBuV)	CORRECTION FACTOR (dB/m)
1	5150.00	56.2 PK	74.0	-17.8	1.62 V	273	53.6	2.6
2	5150.00	43.7 AV	54.0	-10.3	1.62 V	273	41.1	2.6
3	*5230.00	108.8 PK			1.62 V	273	106.6	2.2
4	*5230.00	94.6 AV			1.62 V	273	92.4	2.2
5	5350.00	52.2 PK	74.0	-21.8	1.62 V	273	49.9	2.3
6	5350.00	39.1 AV	54.0	-14.9	1.62 V	273	36.8	2.3
7	#10460.00	52.5 PK	68.2	-15.7	1.94 V	280	40.1	12.4
8	15690.00	59.1 PK	74.0	-14.9	2.93 V	233	46.9	12.2
9	15690.00	48.6 AV	54.0	-5.4	2.93 V	233	36.4	12.2

REMARKS:

1. Emission Level(dBuV/m) = Raw Value(dBuV) + Correction Factor(dB/m)
2. Correction Factor(dB/m) = Antenna Factor(dB/m) + Cable Factor(dB) – Pre-Amplifier Factor(dB)
3. The other emission levels were very low against the limit.
4. Margin value = Emission Level – Limit value
5. " * ": Fundamental frequency.
6. " # ": The radiated frequency is out of the restricted band.

CHANNEL	TX Channel 151	DETECTOR FUNCTION	Peak (PK)
FREQUENCY RANGE	1GHz ~ 40GHz		Average (AV)

ANTENNA POLARITY & TEST DISTANCE: HORIZONTAL AT 3 M

NO.	FREQ. (MHz)	EMISSION LEVEL (dBuV/m)	LIMIT (dBuV/m)	MARGIN (dB)	ANTENNA HEIGHT (m)	TABLE ANGLE (Degree)	RAW VALUE (dBuV)	CORRECTION FACTOR (dB/m)
1	#5611.75	57.2 PK	68.2	-11.0	1.41 H	210	54.4	2.8
2	*5755.00	110.5 PK			1.41 H	210	107.5	3.0
3	*5755.00	97.8 AV			1.41 H	210	94.8	3.0
4	#5961.35	57.1 PK	68.2	-11.1	1.41 H	210	53.8	3.3
5	11510.00	46.6 PK	74.0	-27.4	1.63 H	205	34.3	12.3
6	11510.00	40.3 AV	54.0	-13.7	1.63 H	205	28.0	12.3
7	#17265.00	50.0 PK	68.2	-18.2	2.30 H	122	34.6	15.4

ANTENNA POLARITY & TEST DISTANCE: VERTICAL AT 3 M

NO.	FREQ. (MHz)	EMISSION LEVEL (dBuV/m)	LIMIT (dBuV/m)	MARGIN (dB)	ANTENNA HEIGHT (m)	TABLE ANGLE (Degree)	RAW VALUE (dBuV)	CORRECTION FACTOR (dB/m)
1	#5643.90	59.4 PK	68.2	-8.8	1.66 V	279	60.2	-0.8
2	*5755.00	107.7 PK			1.66 V	279	104.7	3.0
3	*5755.00	95.8 AV			1.66 V	279	92.8	3.0
4	#6015.45	57.9 PK	68.2	-10.3	1.66 V	279	58.1	-0.2
5	11510.00	48.0 PK	74.0	-26.0	1.20 V	218	35.7	12.3
6	11510.00	42.9 AV	54.0	-11.1	1.20 V	218	30.6	12.3
7	#17265.00	54.0 PK	68.2	-14.2	1.88 V	276	38.6	15.4

REMARKS:

1. Emission Level(dBuV/m) = Raw Value(dBuV) + Correction Factor(dB/m)
2. Correction Factor(dB/m) = Antenna Factor(dB/m) + Cable Factor(dB) – Pre-Amplifier Factor(dB)
3. The other emission levels were very low against the limit.
4. Margin value = Emission Level – Limit value
5. " * ": Fundamental frequency.
6. " # ": The radiated frequency is out of the restricted band.

CHANNEL	TX Channel 159	DETECTOR FUNCTION	Peak (PK)
FREQUENCY RANGE	1GHz ~ 40GHz		Average (AV)

ANTENNA POLARITY & TEST DISTANCE: HORIZONTAL AT 3 M

NO.	FREQ. (MHz)	EMISSION LEVEL (dBuV/m)	LIMIT (dBuV/m)	MARGIN (dB)	ANTENNA HEIGHT (m)	TABLE ANGLE (Degree)	RAW VALUE (dBuV)	CORRECTION FACTOR (dB/m)
1	#5645.95	64.2 PK	68.2	-4.0	1.60 H	265	61.5	2.7
2	*5795.00	118.2 PK			1.66 H	297	115.2	3.0
3	*5795.00	105.5 AV			1.66 H	297	102.5	3.0
4	#5928.10	68.1 PK	68.2	-0.1	1.60 H	265	64.7	3.4
5	11590.00	46.5 PK	74.0	-27.5	1.72 H	206	34.1	12.4
6	11590.00	40.0 AV	54.0	-14.0	1.72 H	206	27.6	12.4
7	#17385.00	51.3 PK	68.2	-16.9	2.29 H	126	35.1	16.2

ANTENNA POLARITY & TEST DISTANCE: VERTICAL AT 3 M

NO.	FREQ. (MHz)	EMISSION LEVEL (dBuV/m)	LIMIT (dBuV/m)	MARGIN (dB)	ANTENNA HEIGHT (m)	TABLE ANGLE (Degree)	RAW VALUE (dBuV)	CORRECTION FACTOR (dB/m)
1	#5595.15	57.3 PK	68.2	-10.9	1.60 V	265	54.5	2.8
2	*5795.00	108.1 PK			1.60 V	265	105.1	3.0
3	*5795.00	96.6 AV			1.60 V	265	93.6	3.0
4	#5927.91	61.2 PK	68.2	-7.0	1.60 V	265	57.8	3.4
5	11590.00	49.5 PK	74.0	-24.5	1.27 V	207	37.1	12.4
6	11590.00	43.6 AV	54.0	-10.4	1.27 V	207	31.2	12.4
7	#17385.00	54.6 PK	68.2	-13.6	1.88 V	298	38.4	16.2

REMARKS:

- Emission Level(dBuV/m) = Raw Value(dBuV) + Correction Factor(dB/m)
- Correction Factor(dB/m) = Antenna Factor(dB/m) + Cable Factor(dB) – Pre-Amplifier Factor(dB)
- The other emission levels were very low against the limit.
- Margin value = Emission Level – Limit value
- " * ": Fundamental frequency.
- " # ": The radiated frequency is out of the restricted band.

802.11ax (HE80)

CHANNEL	TX Channel 42	DETECTOR FUNCTION	Peak (PK)
FREQUENCY RANGE	1GHz ~ 40GHz		Average (AV)

ANTENNA POLARITY & TEST DISTANCE: HORIZONTAL AT 3 M

NO.	FREQ. (MHz)	EMISSION LEVEL (dBuV/m)	LIMIT (dBuV/m)	MARGIN (dB)	ANTENNA HEIGHT (m)	TABLE ANGLE (Degree)	RAW VALUE (dBuV)	CORRECTION FACTOR (dB/m)
1	#350.00	52.7 PK	74.0	-21.3	1.48 H	206	52.7	0.0
2	#350.00	39.8 AV	54.0	-14.2	1.48 H	206	39.8	0.0
3	5150.00	67.8 PK	74.0	-6.2	1.48 H	206	65.2	2.6
4	5150.00	53.7 AV	54.0	-0.3	1.48 H	206	51.1	2.6
5	*5210.00	107.2 PK			1.48 H	206	104.8	2.4
6	*5210.00	94.2 AV			1.48 H	206	91.8	2.4
7	#10420.00	47.7 PK	68.2	-20.5	2.85 H	280	35.5	12.2
8	15630.00	52.7 PK	74.0	-21.3	1.96 H	43	40.0	12.7
9	15630.00	40.1 AV	54.0	-13.9	1.96 H	43	27.4	12.7

ANTENNA POLARITY & TEST DISTANCE: VERTICAL AT 3 M

NO.	FREQ. (MHz)	EMISSION LEVEL (dBuV/m)	LIMIT (dBuV/m)	MARGIN (dB)	ANTENNA HEIGHT (m)	TABLE ANGLE (Degree)	RAW VALUE (dBuV)	CORRECTION FACTOR (dB/m)
1	5150.00	57.2 PK	74.0	-16.8	1.67 V	269	54.6	2.6
2	5150.00	43.6 AV	54.0	-10.4	1.67 V	269	41.0	2.6
3	*5210.00	99.9 PK			1.67 V	269	97.5	2.4
4	*5210.00	85.7 AV			1.67 V	269	83.3	2.4
5	5350.00	48.1 PK	74.0	-25.9	1.67 V	269	45.8	2.3
6	5350.00	36.1 AV	54.0	-17.9	1.67 V	269	33.8	2.3
7	#10420.00	51.7 PK	68.2	-16.5	2.00 V	314	39.5	12.2
8	15630.00	57.3 PK	74.0	-16.7	2.96 V	243	44.6	12.7
9	15630.00	46.9 AV	54.0	-7.1	2.96 V	243	34.2	12.7

REMARKS:

- Emission Level(dBuV/m) = Raw Value(dBuV) + Correction Factor(dB/m)
- Correction Factor(dB/m) = Antenna Factor(dB/m) + Cable Factor(dB) – Pre-Amplifier Factor(dB)
- The other emission levels were very low against the limit.
- Margin value = Emission Level – Limit value
- " * ": Fundamental frequency.
- " # ": The radiated frequency is out of the restricted band.

CHANNEL	TX Channel 155	DETECTOR FUNCTION	Peak (PK)
FREQUENCY RANGE	1GHz ~ 40GHz		Average (AV)

ANTENNA POLARITY & TEST DISTANCE: HORIZONTAL AT 3 M

NO.	FREQ. (MHz)	EMISSION LEVEL (dBuV/m)	LIMIT (dBuV/m)	MARGIN (dB)	ANTENNA HEIGHT (m)	TABLE ANGLE (Degree)	RAW VALUE (dBuV)	CORRECTION FACTOR (dB/m)
1	#5636.45	68.0 PK	68.2	-0.2	1.56 H	298	65.3	2.7
2	*5775.00	113.3 PK			1.56 H	298	110.3	3.0
3	*5775.00	100.6 AV			1.56 H	298	97.6	3.0
4	#5928.10	66.5 PK	68.2	-1.7	1.56 H	298	63.1	3.4
5	11550.00	46.4 PK	74.0	-27.6	1.72 H	190	34.0	12.4
6	11550.00	40.2 AV	54.0	-13.8	1.72 H	190	27.8	12.4
7	#17325.00	50.5 PK	68.2	-17.7	2.31 H	153	34.8	15.7

ANTENNA POLARITY & TEST DISTANCE: VERTICAL AT 3 M

NO.	FREQ. (MHz)	EMISSION LEVEL (dBuV/m)	LIMIT (dBuV/m)	MARGIN (dB)	ANTENNA HEIGHT (m)	TABLE ANGLE (Degree)	RAW VALUE (dBuV)	CORRECTION FACTOR (dB/m)
1	#5634.69	59.5 PK	68.2	-8.7	1.57 V	268	56.7	2.8
2	*5775.00	104.8 PK			1.57 V	268	101.8	3.0
3	*5775.00	91.8 AV			1.57 V	268	88.8	3.0
4	#5927.33	59.0 PK	68.2	-9.2	1.57 V	268	55.6	3.4
5	11550.00	40.4 PK	74.0	-33.6	1.31 V	224	28.0	12.4
6	11550.00	30.7 AV	54.0	-23.3	1.31 V	224	18.3	12.4
7	#17325.00	42.3 PK	68.2	-25.9	1.77 V	332	26.6	15.7

REMARKS:

- Emission Level(dBuV/m) = Raw Value(dBuV) + Correction Factor(dB/m)
- Correction Factor(dB/m) = Antenna Factor(dB/m) + Cable Factor(dB) – Pre-Amplifier Factor(dB)
- The other emission levels were very low against the limit.
- Margin value = Emission Level – Limit value
- " * ": Fundamental frequency.
- " # ": The radiated frequency is out of the restricted band.

4.1.10 Test Results (Mode 4)

Above 1GHz Data:

802.11a

CHANNEL	TX Channel 36	DETECTOR FUNCTION	Peak (PK)
FREQUENCY RANGE	1GHz ~ 40GHz		Average (AV)

ANTENNA POLARITY & TEST DISTANCE: HORIZONTAL AT 3 M

NO.	FREQ. (MHz)	EMISSION LEVEL (dBuV/m)	LIMIT (dBuV/m)	MARGIN (dB)	ANTENNA HEIGHT (m)	TABLE ANGLE (Degree)	RAW VALUE (dBuV)	CORRECTION FACTOR (dB/m)
1	5150.00	65.4 PK	74.0	-8.6	1.81 H	288	62.8	2.6
2	5150.00	53.8 AV	54.0	-0.2	1.81 H	288	51.2	2.6
3	*5180.00	109.2 PK			1.81 H	288	106.7	2.5
4	*5180.00	100.6 AV			1.81 H	288	98.1	2.5
5	#10360.00	49.9 PK	68.2	-18.3	2.76 H	300	38.0	11.9
6	15540.00	53.7 PK	74.0	-20.3	2.05 H	21	41.3	12.4
7	15540.00	41.1 AV	54.0	-12.9	2.05 H	21	28.7	12.4

ANTENNA POLARITY & TEST DISTANCE: VERTICAL AT 3 M

NO.	FREQ. (MHz)	EMISSION LEVEL (dBuV/m)	LIMIT (dBuV/m)	MARGIN (dB)	ANTENNA HEIGHT (m)	TABLE ANGLE (Degree)	RAW VALUE (dBuV)	CORRECTION FACTOR (dB/m)
1	5150.00	58.9 PK	74.0	-15.1	2.80 V	259	56.3	2.6
2	5150.00	49.3 AV	54.0	-4.7	2.80 V	259	46.7	2.6
3	*5180.00	105.2 PK			2.80 V	259	102.7	2.5
4	*5180.00	95.9 AV			2.80 V	259	93.4	2.5
5	#10360.00	52.2 PK	68.2	-16.0	1.93 V	322	40.3	11.9
6	15540.00	59.7 PK	74.0	-14.3	2.99 V	250	47.3	12.4
7	15540.00	49.0 AV	54.0	-5.0	2.99 V	250	36.6	12.4

REMARKS:

1. Emission Level(dBuV/m) = Raw Value(dBuV) + Correction Factor(dB/m)
2. Correction Factor(dB/m) = Antenna Factor(dB/m) + Cable Factor(dB) – Pre-Amplifier Factor(dB)
3. The other emission levels were very low against the limit.
4. Margin value = Emission Level – Limit value
5. " * ": Fundamental frequency.
6. " # ": The radiated frequency is out of the restricted band.

CHANNEL	TX Channel 40	DETECTOR FUNCTION	Peak (PK)
FREQUENCY RANGE	1GHz ~ 40GHz		Average (AV)

ANTENNA POLARITY & TEST DISTANCE: HORIZONTAL AT 3 M

NO.	FREQ. (MHz)	EMISSION LEVEL (dBuV/m)	LIMIT (dBuV/m)	MARGIN (dB)	ANTENNA HEIGHT (m)	TABLE ANGLE (Degree)	RAW VALUE (dBuV)	CORRECTION FACTOR (dB/m)
1	5150.00	70.4 PK	74.0	-3.6	1.77 H	291	67.8	2.6
2	5150.00	53.9 AV	54.0	-0.1	1.77 H	291	51.3	2.6
3	*5200.00	112.9 PK			1.77 H	291	110.5	2.4
4	*5200.00	104.2 AV			1.77 H	291	101.8	2.4
5	5350.00	51.3 PK	74.0	-22.7	1.77 H	291	49.0	2.3
6	5350.00	39.6 AV	54.0	-14.4	1.77 H	291	37.3	2.3
7	#10400.00	49.7 PK	68.2	-18.5	2.72 H	300	37.5	12.2
8	15600.00	54.0 PK	74.0	-20.0	2.03 H	12	41.1	12.9
9	15600.00	41.7 AV	54.0	-12.3	2.03 H	12	28.8	12.9

ANTENNA POLARITY & TEST DISTANCE: VERTICAL AT 3 M

NO.	FREQ. (MHz)	EMISSION LEVEL (dBuV/m)	LIMIT (dBuV/m)	MARGIN (dB)	ANTENNA HEIGHT (m)	TABLE ANGLE (Degree)	RAW VALUE (dBuV)	CORRECTION FACTOR (dB/m)
1	5150.00	64.0 PK	74.0	-10.0	2.80 V	268	61.4	2.6
2	5150.00	49.2 AV	54.0	-4.8	2.80 V	268	46.6	2.6
3	*5200.00	109.1 PK			2.80 V	268	106.7	2.4
4	*5200.00	99.9 AV			2.80 V	268	97.5	2.4
5	5350.00	48.1 PK	74.0	-25.9	2.80 V	268	45.8	2.3
6	5350.00	35.2 AV	54.0	-18.8	2.80 V	268	32.9	2.3
7	#10400.00	51.8 PK	68.2	-16.4	2.00 V	323	39.6	12.2
8	15600.00	60.3 PK	74.0	-13.7	3.06 V	246	47.4	12.9
9	15600.00	48.7 AV	54.0	-5.3	3.06 V	246	35.8	12.9

REMARKS:

1. Emission Level(dBuV/m) = Raw Value(dBuV) + Correction Factor(dB/m)
2. Correction Factor(dB/m) = Antenna Factor(dB/m) + Cable Factor(dB) – Pre-Amplifier Factor(dB)
3. The other emission levels were very low against the limit.
4. Margin value = Emission Level – Limit value
5. " * ": Fundamental frequency.
6. " # ": The radiated frequency is out of the restricted band.

CHANNEL	TX Channel 48	DETECTOR FUNCTION	Peak (PK)
FREQUENCY RANGE	1GHz ~ 40GHz		Average (AV)

ANTENNA POLARITY & TEST DISTANCE: HORIZONTAL AT 3 M

NO.	FREQ. (MHz)	EMISSION LEVEL (dBuV/m)	LIMIT (dBuV/m)	MARGIN (dB)	ANTENNA HEIGHT (m)	TABLE ANGLE (Degree)	RAW VALUE (dBuV)	CORRECTION FACTOR (dB/m)
1	*5240.00	110.9 PK			1.68 H	291	108.7	2.2
2	*5240.00	101.9 AV			1.68 H	291	99.7	2.2
3	5350.00	51.7 PK	74.0	-22.3	1.68 H	291	49.4	2.3
4	5350.00	40.7 AV	54.0	-13.3	1.68 H	291	38.4	2.3
5	#10480.00	49.6 PK	68.2	-18.6	2.76 H	304	37.2	12.4
6	15720.00	53.1 PK	74.0	-20.9	1.98 H	10	41.1	12.0
7	15720.00	40.5 AV	54.0	-13.5	1.98 H	10	28.5	12.0

ANTENNA POLARITY & TEST DISTANCE: VERTICAL AT 3 M

NO.	FREQ. (MHz)	EMISSION LEVEL (dBuV/m)	LIMIT (dBuV/m)	MARGIN (dB)	ANTENNA HEIGHT (m)	TABLE ANGLE (Degree)	RAW VALUE (dBuV)	CORRECTION FACTOR (dB/m)
1	*5240.00	106.8 PK			2.81 V	268	104.6	2.2
2	*5240.00	97.4 AV			2.81 V	268	95.2	2.2
3	5350.00	44.8 PK	74.0	-29.2	2.81 V	268	42.5	2.3
4	5350.00	35.7 AV	54.0	-18.3	2.81 V	268	33.4	2.3
5	#10480.00	52.8 PK	68.2	-15.4	1.89 V	301	40.4	12.4
6	15720.00	58.8 PK	74.0	-15.2	3.03 V	220	46.8	12.0
7	15720.00	48.8 AV	54.0	-5.2	3.03 V	220	36.8	12.0

REMARKS:

- Emission Level(dBuV/m) = Raw Value(dBuV) + Correction Factor(dB/m)
- Correction Factor(dB/m) = Antenna Factor(dB/m) + Cable Factor(dB) – Pre-Amplifier Factor(dB)
- The other emission levels were very low against the limit.
- Margin value = Emission Level – Limit value
- " * ": Fundamental frequency.
- " # ": The radiated frequency is out of the restricted band.

CHANNEL	TX Channel 149	DETECTOR FUNCTION	Peak (PK)
FREQUENCY RANGE	1GHz ~ 40GHz		Average (AV)

ANTENNA POLARITY & TEST DISTANCE: HORIZONTAL AT 3 M

NO.	FREQ. (MHz)	EMISSION LEVEL (dBuV/m)	LIMIT (dBuV/m)	MARGIN (dB)	ANTENNA HEIGHT (m)	TABLE ANGLE (Degree)	RAW VALUE (dBuV)	CORRECTION FACTOR (dB/m)
1	#5626.33	57.7 PK	68.2	-10.5	2.52 H	273	54.9	2.8
2	*5745.00	115.8 PK			2.52 H	273	112.9	2.9
3	*5745.00	105.7 AV			2.52 H	273	102.8	2.9
4	#5987.90	56.6 PK	68.2	-11.6	2.52 H	273	53.4	3.2
5	11490.00	46.9 PK	74.0	-27.1	1.73 H	180	34.6	12.3
6	11490.00	40.4 AV	54.0	-13.6	1.73 H	180	28.1	12.3
7	#17235.00	49.8 PK	68.2	-18.4	2.27 H	130	34.5	15.3

ANTENNA POLARITY & TEST DISTANCE: VERTICAL AT 3 M

NO.	FREQ. (MHz)	EMISSION LEVEL (dBuV/m)	LIMIT (dBuV/m)	MARGIN (dB)	ANTENNA HEIGHT (m)	TABLE ANGLE (Degree)	RAW VALUE (dBuV)	CORRECTION FACTOR (dB/m)
1	#5626.85	56.0 PK	68.2	-12.2	2.39 V	279	53.2	2.8
2	*5745.00	107.4 PK			2.39 V	279	104.5	2.9
3	*5745.00	98.2 AV			2.39 V	279	95.3	2.9
4	#5998.29	56.2 PK	68.2	-12.0	2.39 V	279	53.0	3.2
5	11490.00	48.9 PK	74.0	-25.1	1.40 V	202	36.6	12.3
6	11490.00	43.2 AV	54.0	-10.8	1.40 V	202	30.9	12.3
7	#17235.00	54.4 PK	68.2	-13.8	1.80 V	295	39.1	15.3

REMARKS:

1. Emission Level(dBuV/m) = Raw Value(dBuV) + Correction Factor(dB/m)
2. Correction Factor(dB/m) = Antenna Factor(dB/m) + Cable Factor(dB) – Pre-Amplifier Factor(dB)
3. The other emission levels were very low against the limit.
4. Margin value = Emission Level – Limit value
5. " * ": Fundamental frequency.
6. " # ": The radiated frequency is out of the restricted band.

CHANNEL	TX Channel 157	DETECTOR FUNCTION	Peak (PK)
FREQUENCY RANGE	1GHz ~ 40GHz		Average (AV)

ANTENNA POLARITY & TEST DISTANCE: HORIZONTAL AT 3 M

NO.	FREQ. (MHz)	EMISSION LEVEL (dBuV/m)	LIMIT (dBuV/m)	MARGIN (dB)	ANTENNA HEIGHT (m)	TABLE ANGLE (Degree)	RAW VALUE (dBuV)	CORRECTION FACTOR (dB/m)
1	#5626.05	56.6 PK	68.2	-11.6	2.52 H	301	53.8	2.8
2	*5785.00	115.9 PK			2.52 H	301	112.8	3.1
3	*5785.00	105.8 AV			2.52 H	301	102.7	3.1
4	#5964.48	56.7 PK	68.2	-11.5	2.52 H	301	53.4	3.3
5	11570.00	45.9 PK	74.0	-28.1	1.74 H	195	33.5	12.4
6	11570.00	40.2 AV	54.0	-13.8	1.74 H	195	27.8	12.4
7	#17355.00	50.5 PK	68.2	-17.7	2.26 H	128	34.5	16.0

ANTENNA POLARITY & TEST DISTANCE: VERTICAL AT 3 M

NO.	FREQ. (MHz)	EMISSION LEVEL (dBuV/m)	LIMIT (dBuV/m)	MARGIN (dB)	ANTENNA HEIGHT (m)	TABLE ANGLE (Degree)	RAW VALUE (dBuV)	CORRECTION FACTOR (dB/m)
1	#5633.59	57.2 PK	68.2	-11.0	2.58 V	279	54.4	2.8
2	*5785.00	107.3 PK			2.58 V	279	104.2	3.1
3	*5785.00	97.2 AV			2.58 V	279	94.1	3.1
4	#6022.62	58.8 PK	68.2	-9.4	2.58 V	279	55.5	3.3
5	11570.00	48.4 PK	74.0	-25.6	1.31 V	186	36.0	12.4
6	11570.00	43.2 AV	54.0	-10.8	1.31 V	186	30.8	12.4
7	#17355.00	52.7 PK	68.2	-15.5	1.78 V	286	36.7	16.0

REMARKS:

1. Emission Level(dBuV/m) = Raw Value(dBuV) + Correction Factor(dB/m)
2. Correction Factor(dB/m) = Antenna Factor(dB/m) + Cable Factor(dB) – Pre-Amplifier Factor(dB)
3. The other emission levels were very low against the limit.
4. Margin value = Emission Level – Limit value
5. " * ": Fundamental frequency.
6. " # ": The radiated frequency is out of the restricted band.

CHANNEL	TX Channel 165	DETECTOR FUNCTION	Peak (PK)
FREQUENCY RANGE	1GHz ~ 40GHz		Average (AV)

ANTENNA POLARITY & TEST DISTANCE: HORIZONTAL AT 3 M

NO.	FREQ. (MHz)	EMISSION LEVEL (dBuV/m)	LIMIT (dBuV/m)	MARGIN (dB)	ANTENNA HEIGHT (m)	TABLE ANGLE (Degree)	RAW VALUE (dBuV)	CORRECTION FACTOR (dB/m)
1	#5571.19	57.0 PK	68.2	-11.2	2.46 H	273	54.2	2.8
2	*5825.00	116.0 PK			2.46 H	273	112.8	3.2
3	*5825.00	105.9 AV			2.46 H	273	102.7	3.2
4	#5931.51	58.0 PK	68.2	-10.2	2.46 H	273	54.6	3.4
5	11650.00	46.2 PK	74.0	-27.8	1.64 H	213	33.8	12.4
6	11650.00	40.1 AV	54.0	-13.9	1.64 H	213	27.7	12.4
7	#17475.00	49.3 PK	68.2	-18.9	2.31 H	112	31.9	17.4

ANTENNA POLARITY & TEST DISTANCE: VERTICAL AT 3 M

NO.	FREQ. (MHz)	EMISSION LEVEL (dBuV/m)	LIMIT (dBuV/m)	MARGIN (dB)	ANTENNA HEIGHT (m)	TABLE ANGLE (Degree)	RAW VALUE (dBuV)	CORRECTION FACTOR (dB/m)
1	#5610.28	56.9 PK	68.2	-11.3	3.11 V	302	54.1	2.8
2	*5825.00	108.6 PK			3.11 V	302	105.4	3.2
3	*5825.00	98.5 AV			3.11 V	302	95.3	3.2
4	#5932.32	56.6 PK	68.2	-11.6	3.11 V	302	53.2	3.4
5	11650.00	48.6 PK	74.0	-25.4	1.36 V	207	36.2	12.4
6	11650.00	42.9 AV	54.0	-11.1	1.36 V	207	30.5	12.4
7	#17475.00	53.6 PK	68.2	-14.6	1.81 V	278	36.2	17.4

REMARKS:

1. Emission Level(dBuV/m) = Raw Value(dBuV) + Correction Factor(dB/m)
2. Correction Factor(dB/m) = Antenna Factor(dB/m) + Cable Factor(dB) – Pre-Amplifier Factor(dB)
3. The other emission levels were very low against the limit.
4. Margin value = Emission Level – Limit value
5. " * ": Fundamental frequency.
6. " # ": The radiated frequency is out of the restricted band.

802.11ax (HE20)

CHANNEL	TX Channel 36	DETECTOR FUNCTION	Peak (PK)
FREQUENCY RANGE	1GHz ~ 40GHz		Average (AV)

ANTENNA POLARITY & TEST DISTANCE: HORIZONTAL AT 3 M

NO.	FREQ. (MHz)	EMISSION LEVEL (dBuV/m)	LIMIT (dBuV/m)	MARGIN (dB)	ANTENNA HEIGHT (m)	TABLE ANGLE (Degree)	RAW VALUE (dBuV)	CORRECTION FACTOR (dB/m)
1	5150.00	67.5 PK	74.0	-6.5	1.72 H	290	64.9	2.6
2	5150.00	53.8 AV	54.0	-0.2	1.72 H	290	51.2	2.6
3	*5180.00	112.5 PK			1.72 H	290	110.0	2.5
4	*5180.00	100.0 AV			1.72 H	290	97.5	2.5
5	#10360.00	50.3 PK	68.2	-17.9	2.78 H	286	38.4	11.9
6	15540.00	54.0 PK	74.0	-20.0	2.03 H	0	41.6	12.4
7	15540.00	41.3 AV	54.0	-12.7	2.03 H	0	28.9	12.4

ANTENNA POLARITY & TEST DISTANCE: VERTICAL AT 3 M

NO.	FREQ. (MHz)	EMISSION LEVEL (dBuV/m)	LIMIT (dBuV/m)	MARGIN (dB)	ANTENNA HEIGHT (m)	TABLE ANGLE (Degree)	RAW VALUE (dBuV)	CORRECTION FACTOR (dB/m)
1	5150.00	61.3 PK	74.0	-12.7	2.76 V	256	58.7	2.6
2	5150.00	49.3 AV	54.0	-4.7	2.76 V	256	46.7	2.6
3	*5180.00	108.2 PK			2.76 V	256	105.7	2.5
4	*5180.00	95.7 AV			2.76 V	256	93.2	2.5
5	#10360.00	52.7 PK	68.2	-15.5	2.00 V	310	40.8	11.9
6	15540.00	60.3 PK	74.0	-13.7	3.02 V	229	47.9	12.4
7	15540.00	49.5 AV	54.0	-4.5	3.02 V	229	37.1	12.4

REMARKS:

1. Emission Level(dBuV/m) = Raw Value(dBuV) + Correction Factor(dB/m)
2. Correction Factor(dB/m) = Antenna Factor(dB/m) + Cable Factor(dB) – Pre-Amplifier Factor(dB)
3. The other emission levels were very low against the limit.
4. Margin value = Emission Level – Limit value
5. " * ": Fundamental frequency.
6. " # ": The radiated frequency is out of the restricted band.

CHANNEL	TX Channel 40	DETECTOR FUNCTION	Peak (PK)
FREQUENCY RANGE	1GHz ~ 40GHz		Average (AV)

ANTENNA POLARITY & TEST DISTANCE: HORIZONTAL AT 3 M

NO.	FREQ. (MHz)	EMISSION LEVEL (dBuV/m)	LIMIT (dBuV/m)	MARGIN (dB)	ANTENNA HEIGHT (m)	TABLE ANGLE (Degree)	RAW VALUE (dBuV)	CORRECTION FACTOR (dB/m)
1	5150.00	65.7 PK	74.0	-8.3	2.25 H	283	63.1	2.6
2	5150.00	53.6 AV	54.0	-0.4	2.25 H	283	51.0	2.6
3	*5200.00	114.2 PK			2.25 H	283	111.8	2.4
4	*5200.00	101.9 AV			2.25 H	283	99.5	2.4
5	5350.00	51.4 PK	74.0	-22.6	2.25 H	283	49.1	2.3
6	5350.00	39.2 AV	54.0	-14.8	2.25 H	283	36.9	2.3
7	#10400.00	50.0 PK	68.2	-18.2	2.77 H	285	37.8	12.2
8	15600.00	53.2 PK	74.0	-20.8	2.03 H	20	40.3	12.9
9	15600.00	40.5 AV	54.0	-13.5	2.03 H	20	27.6	12.9

ANTENNA POLARITY & TEST DISTANCE: VERTICAL AT 3 M

NO.	FREQ. (MHz)	EMISSION LEVEL (dBuV/m)	LIMIT (dBuV/m)	MARGIN (dB)	ANTENNA HEIGHT (m)	TABLE ANGLE (Degree)	RAW VALUE (dBuV)	CORRECTION FACTOR (dB/m)
1	5150.00	62.6 PK	74.0	-11.4	2.71 V	250	60.0	2.6
2	5150.00	49.0 AV	54.0	-5.0	2.71 V	250	46.4	2.6
3	*5200.00	110.3 PK			2.71 V	250	107.9	2.4
4	*5200.00	97.2 AV			2.71 V	250	94.8	2.4
5	5350.00	46.8 PK	74.0	-27.2	2.71 V	250	44.5	2.3
6	5350.00	35.8 AV	54.0	-18.2	2.71 V	250	33.5	2.3
7	#10400.00	52.6 PK	68.2	-15.6	2.01 V	326	40.4	12.2
8	15600.00	59.4 PK	74.0	-14.6	3.05 V	240	46.5	12.9
9	15600.00	48.4 AV	54.0	-5.6	3.05 V	240	35.5	12.9

REMARKS:

1. Emission Level(dBuV/m) = Raw Value(dBuV) + Correction Factor(dB/m)
2. Correction Factor(dB/m) = Antenna Factor(dB/m) + Cable Factor(dB) – Pre-Amplifier Factor(dB)
3. The other emission levels were very low against the limit.
4. Margin value = Emission Level – Limit value
5. " * ": Fundamental frequency.
6. " # ": The radiated frequency is out of the restricted band.

CHANNEL	TX Channel 48	DETECTOR FUNCTION	Peak (PK)
FREQUENCY RANGE	1GHz ~ 40GHz		Average (AV)

ANTENNA POLARITY & TEST DISTANCE: HORIZONTAL AT 3 M

NO.	FREQ. (MHz)	EMISSION LEVEL (dBuV/m)	LIMIT (dBuV/m)	MARGIN (dB)	ANTENNA HEIGHT (m)	TABLE ANGLE (Degree)	RAW VALUE (dBuV)	CORRECTION FACTOR (dB/m)
1	*5240.00	113.9 PK			1.70 H	292	111.7	2.2
2	*5240.00	101.2 AV			1.70 H	292	99.0	2.2
3	5350.00	51.9 PK	74.0	-22.1	1.70 H	292	49.6	2.3
4	5350.00	40.2 AV	54.0	-13.8	1.70 H	292	37.9	2.3
5	#10480.00	49.3 PK	68.2	-18.9	2.66 H	277	36.9	12.4
6	15720.00	53.8 PK	74.0	-20.2	1.96 H	13	41.8	12.0
7	15720.00	41.0 AV	54.0	-13.0	1.96 H	13	29.0	12.0

ANTENNA POLARITY & TEST DISTANCE: VERTICAL AT 3 M

NO.	FREQ. (MHz)	EMISSION LEVEL (dBuV/m)	LIMIT (dBuV/m)	MARGIN (dB)	ANTENNA HEIGHT (m)	TABLE ANGLE (Degree)	RAW VALUE (dBuV)	CORRECTION FACTOR (dB/m)
1	*5240.00	110.0 PK			2.80 V	263	107.8	2.2
2	*5240.00	96.8 AV			2.80 V	263	94.6	2.2
3	5350.00	46.6 PK	74.0	-27.4	2.80 V	263	44.3	2.3
4	5350.00	35.6 AV	54.0	-18.4	2.80 V	263	33.3	2.3
5	#10480.00	51.8 PK	68.2	-16.4	1.93 V	302	39.4	12.4
6	15720.00	59.1 PK	74.0	-14.9	3.01 V	240	47.1	12.0
7	15720.00	49.2 AV	54.0	-4.8	3.01 V	240	37.2	12.0

REMARKS:

- Emission Level(dBuV/m) = Raw Value(dBuV) + Correction Factor(dB/m)
- Correction Factor(dB/m) = Antenna Factor(dB/m) + Cable Factor(dB) – Pre-Amplifier Factor(dB)
- The other emission levels were very low against the limit.
- Margin value = Emission Level – Limit value
- " * ": Fundamental frequency.
- " # ": The radiated frequency is out of the restricted band.

CHANNEL	TX Channel 149	DETECTOR FUNCTION	Peak (PK)
FREQUENCY RANGE	1GHz ~ 40GHz		Average (AV)

ANTENNA POLARITY & TEST DISTANCE: HORIZONTAL AT 3 M

NO.	FREQ. (MHz)	EMISSION LEVEL (dBuV/m)	LIMIT (dBuV/m)	MARGIN (dB)	ANTENNA HEIGHT (m)	TABLE ANGLE (Degree)	RAW VALUE (dBuV)	CORRECTION FACTOR (dB/m)
1	#5645.53	57.1 PK	68.2	-11.1	2.35 H	295	54.4	2.7
2	*5745.00	116.8 PK			2.35 H	295	113.9	2.9
3	*5745.00	104.5 AV			2.35 H	295	101.6	2.9
4	#6009.55	57.5 PK	68.2	-10.7	2.35 H	295	54.3	3.2
5	11490.00	46.9 PK	74.0	-27.1	1.76 H	206	34.6	12.3
6	11490.00	40.5 AV	54.0	-13.5	1.76 H	206	28.2	12.3
7	#17235.00	50.9 PK	68.2	-17.3	2.29 H	142	35.6	15.3

ANTENNA POLARITY & TEST DISTANCE: VERTICAL AT 3 M

NO.	FREQ. (MHz)	EMISSION LEVEL (dBuV/m)	LIMIT (dBuV/m)	MARGIN (dB)	ANTENNA HEIGHT (m)	TABLE ANGLE (Degree)	RAW VALUE (dBuV)	CORRECTION FACTOR (dB/m)
1	#5556.83	57.1 PK	68.2	-11.1	2.29 V	320	58.1	-1.0
2	*5745.00	111.4 PK			2.29 V	320	108.5	2.9
3	*5745.00	99.4 AV			2.29 V	320	96.5	2.9
4	#5929.60	56.7 PK	68.2	-11.5	2.29 V	320	56.9	-0.2
5	11490.00	48.5 PK	74.0	-25.5	1.29 V	196	36.2	12.3
6	11490.00	42.7 AV	54.0	-11.3	1.29 V	196	30.4	12.3
7	#17235.00	54.0 PK	68.2	-14.2	1.72 V	283	38.7	15.3

REMARKS:

- Emission Level(dBuV/m) = Raw Value(dBuV) + Correction Factor(dB/m)
- Correction Factor(dB/m) = Antenna Factor(dB/m) + Cable Factor(dB) – Pre-Amplifier Factor(dB)
- The other emission levels were very low against the limit.
- Margin value = Emission Level – Limit value
- " * ": Fundamental frequency.
- " # ": The radiated frequency is out of the restricted band.

CHANNEL	TX Channel 157	DETECTOR FUNCTION	Peak (PK)
FREQUENCY RANGE	1GHz ~ 40GHz		Average (AV)

ANTENNA POLARITY & TEST DISTANCE: HORIZONTAL AT 3 M

NO.	FREQ. (MHz)	EMISSION LEVEL (dBuV/m)	LIMIT (dBuV/m)	MARGIN (dB)	ANTENNA HEIGHT (m)	TABLE ANGLE (Degree)	RAW VALUE (dBuV)	CORRECTION FACTOR (dB/m)
1	#5610.76	56.6 PK	68.2	-11.6	2.32 H	298	53.8	2.8
2	*5785.00	116.7 PK			2.32 H	298	113.6	3.1
3	*5785.00	104.9 AV			2.32 H	298	101.8	3.1
4	#5939.90	56.6 PK	68.2	-11.6	2.32 H	298	53.2	3.4
5	11570.00	47.0 PK	74.0	-27.0	1.71 H	202	34.6	12.4
6	11570.00	40.4 AV	54.0	-13.6	1.71 H	202	28.0	12.4
7	#17355.00	51.3 PK	68.2	-16.9	2.28 H	117	35.3	16.0

ANTENNA POLARITY & TEST DISTANCE: VERTICAL AT 3 M

NO.	FREQ. (MHz)	EMISSION LEVEL (dBuV/m)	LIMIT (dBuV/m)	MARGIN (dB)	ANTENNA HEIGHT (m)	TABLE ANGLE (Degree)	RAW VALUE (dBuV)	CORRECTION FACTOR (dB/m)
1	#5565.02	56.3 PK	68.2	-11.9	2.48 V	305	53.5	2.8
2	*5785.00	109.9 PK			1.00 V	305	106.8	3.1
3	*5785.00	97.6 AV			1.00 V	305	94.5	3.1
4	#5941.31	56.2 PK	68.2	-12.0	2.48 V	305	52.9	3.3
5	11570.00	49.0 PK	74.0	-25.0	1.32 V	190	36.6	12.4
6	11570.00	43.8 AV	54.0	-10.2	1.32 V	190	31.4	12.4
7	#17355.00	53.6 PK	68.2	-14.6	1.72 V	296	37.6	16.0

REMARKS:

- Emission Level(dBuV/m) = Raw Value(dBuV) + Correction Factor(dB/m)
- Correction Factor(dB/m) = Antenna Factor(dB/m) + Cable Factor(dB) – Pre-Amplifier Factor(dB)
- The other emission levels were very low against the limit.
- Margin value = Emission Level – Limit value
- " * ": Fundamental frequency.
- " # ": The radiated frequency is out of the restricted band.

CHANNEL	TX Channel 165	DETECTOR FUNCTION	Peak (PK)
FREQUENCY RANGE	1GHz ~ 40GHz		Average (AV)

ANTENNA POLARITY & TEST DISTANCE: HORIZONTAL AT 3 M

NO.	FREQ. (MHz)	EMISSION LEVEL (dBuV/m)	LIMIT (dBuV/m)	MARGIN (dB)	ANTENNA HEIGHT (m)	TABLE ANGLE (Degree)	RAW VALUE (dBuV)	CORRECTION FACTOR (dB/m)
1	#5593.53	56.6 PK	68.2	-11.6	2.28 H	298	53.8	2.8
2	*5825.00	117.4 PK			2.28 H	298	114.2	3.2
3	*5825.00	105.2 AV			2.28 H	298	102.0	3.2
4	#5926.94	59.4 PK	68.2	-8.8	2.28 H	298	56.0	3.4
5	11650.00	46.9 PK	74.0	-27.1	1.71 H	207	34.5	12.4
6	11650.00	40.9 AV	54.0	-13.1	1.71 H	207	28.5	12.4
7	#17475.00	49.9 PK	68.2	-18.3	2.23 H	123	32.5	17.4

ANTENNA POLARITY & TEST DISTANCE: VERTICAL AT 3 M

NO.	FREQ. (MHz)	EMISSION LEVEL (dBuV/m)	LIMIT (dBuV/m)	MARGIN (dB)	ANTENNA HEIGHT (m)	TABLE ANGLE (Degree)	RAW VALUE (dBuV)	CORRECTION FACTOR (dB/m)
1	#5649.69	56.9 PK	68.2	-11.3	1.00 V	247	54.2	2.7
2	*5825.00	110.6 PK			1.00 V	247	107.4	3.2
3	*5825.00	98.6 AV			1.00 V	247	95.4	3.2
4	#5998.34	58.0 PK	68.2	-10.2	1.00 V	247	54.8	3.2
5	11650.00	48.3 PK	74.0	-25.7	1.38 V	220	35.9	12.4
6	11650.00	43.2 AV	54.0	-10.8	1.38 V	220	30.8	12.4
7	#17475.00	53.4 PK	68.2	-14.8	1.82 V	278	36.0	17.4

REMARKS:

1. Emission Level(dBuV/m) = Raw Value(dBuV) + Correction Factor(dB/m)
2. Correction Factor(dB/m) = Antenna Factor(dB/m) + Cable Factor(dB) – Pre-Amplifier Factor(dB)
3. The other emission levels were very low against the limit.
4. Margin value = Emission Level – Limit value
5. " * ": Fundamental frequency.
6. " # ": The radiated frequency is out of the restricted band.

802.11ax (HE40)

CHANNEL	TX Channel 38	DETECTOR FUNCTION	Peak (PK)
FREQUENCY RANGE	1GHz ~ 40GHz		Average (AV)

ANTENNA POLARITY & TEST DISTANCE: HORIZONTAL AT 3 M

NO.	FREQ. (MHz)	EMISSION LEVEL (dBuV/m)	LIMIT (dBuV/m)	MARGIN (dB)	ANTENNA HEIGHT (m)	TABLE ANGLE (Degree)	RAW VALUE (dBuV)	CORRECTION FACTOR (dB/m)
1	5150.00	67.2 PK	74.0	-6.8	1.70 H	291	64.6	2.6
2	5150.00	53.9 AV	54.0	-0.1	1.70 H	291	51.3	2.6
3	*5190.00	108.0 PK			1.70 H	291	105.5	2.5
4	*5190.00	95.3 AV			1.70 H	291	92.8	2.5
5	5350.00	51.8 PK	74.0	-22.2	1.70 H	291	49.5	2.3
6	5350.00	39.5 AV	54.0	-14.5	1.70 H	291	37.2	2.3
7	#10380.00	49.0 PK	68.2	-19.2	2.86 H	311	37.0	12.0
8	15570.00	53.0 PK	74.0	-21.0	2.08 H	6	40.4	12.6
9	15570.00	40.3 AV	54.0	-13.7	2.08 H	6	27.7	12.6

ANTENNA POLARITY & TEST DISTANCE: VERTICAL AT 3 M

NO.	FREQ. (MHz)	EMISSION LEVEL (dBuV/m)	LIMIT (dBuV/m)	MARGIN (dB)	ANTENNA HEIGHT (m)	TABLE ANGLE (Degree)	RAW VALUE (dBuV)	CORRECTION FACTOR (dB/m)
1	5150.00	61.1 PK	74.0	-12.9	2.81 V	248	58.5	2.6
2	5150.00	49.3 AV	54.0	-4.7	2.81 V	248	46.7	2.6
3	*5190.00	104.0 PK			2.81 V	248	101.5	2.5
4	*5190.00	90.8 AV			2.81 V	248	88.3	2.5
5	5350.00	47.2 PK	74.0	-26.8	2.81 V	248	44.9	2.3
6	5350.00	36.3 AV	54.0	-17.7	2.81 V	248	34.0	2.3
7	#10380.00	50.6 PK	68.2	-17.6	2.05 V	319	38.6	12.0
8	15570.00	59.4 PK	74.0	-14.6	2.92 V	231	46.8	12.6
9	15570.00	48.2 AV	54.0	-5.8	2.92 V	231	35.6	12.6

REMARKS:

- Emission Level(dBuV/m) = Raw Value(dBuV) + Correction Factor(dB/m)
- Correction Factor(dB/m) = Antenna Factor(dB/m) + Cable Factor(dB) – Pre-Amplifier Factor(dB)
- The other emission levels were very low against the limit.
- Margin value = Emission Level – Limit value
- " * ": Fundamental frequency.
- " # ": The radiated frequency is out of the restricted band.

CHANNEL	TX Channel 46	DETECTOR FUNCTION	Peak (PK)
FREQUENCY RANGE	1GHz ~ 40GHz		Average (AV)

ANTENNA POLARITY & TEST DISTANCE: HORIZONTAL AT 3 M

NO.	FREQ. (MHz)	EMISSION LEVEL (dBuV/m)	LIMIT (dBuV/m)	MARGIN (dB)	ANTENNA HEIGHT (m)	TABLE ANGLE (Degree)	RAW VALUE (dBuV)	CORRECTION FACTOR (dB/m)
1	5150.00	61.7 PK	74.0	-12.3	1.67 H	290	59.1	2.6
2	5150.00	50.1 AV	54.0	-3.9	1.67 H	290	47.5	2.6
3	*5230.00	111.3 PK			1.67 H	290	109.1	2.2
4	*5230.00	98.5 AV			1.67 H	290	96.3	2.2
5	5350.00	51.5 PK	74.0	-22.5	1.67 H	290	49.2	2.3
6	5350.00	41.2 AV	54.0	-12.8	1.67 H	290	38.9	2.3
7	#10460.00	50.4 PK	68.2	-17.8	2.83 H	311	38.0	12.4
8	15690.00	54.4 PK	74.0	-19.6	2.11 H	23	42.2	12.2
9	15690.00	41.4 AV	54.0	-12.6	2.11 H	23	29.2	12.2

ANTENNA POLARITY & TEST DISTANCE: VERTICAL AT 3 M

NO.	FREQ. (MHz)	EMISSION LEVEL (dBuV/m)	LIMIT (dBuV/m)	MARGIN (dB)	ANTENNA HEIGHT (m)	TABLE ANGLE (Degree)	RAW VALUE (dBuV)	CORRECTION FACTOR (dB/m)
1	5150.00	56.0 PK	74.0	-18.0	2.85 V	276	53.4	2.6
2	5150.00	46.1 AV	54.0	-7.9	2.85 V	276	43.5	2.6
3	*5230.00	107.2 PK			2.85 V	276	105.0	2.2
4	*5230.00	93.7 AV			2.85 V	276	91.5	2.2
5	5350.00	44.7 PK	74.0	-29.3	2.85 V	276	42.4	2.3
6	5350.00	36.3 AV	54.0	-17.7	2.85 V	276	34.0	2.3
7	#10460.00	51.7 PK	68.2	-16.5	2.04 V	325	39.3	12.4
8	15690.00	60.0 PK	74.0	-14.0	2.91 V	223	47.8	12.2
9	15690.00	49.1 AV	54.0	-4.9	2.91 V	223	36.9	12.2

REMARKS:

1. Emission Level(dBuV/m) = Raw Value(dBuV) + Correction Factor(dB/m)
2. Correction Factor(dB/m) = Antenna Factor(dB/m) + Cable Factor(dB) – Pre-Amplifier Factor(dB)
3. The other emission levels were very low against the limit.
4. Margin value = Emission Level – Limit value
5. " * ": Fundamental frequency.
6. " # ": The radiated frequency is out of the restricted band.

CHANNEL	TX Channel 151	DETECTOR FUNCTION	Peak (PK)
FREQUENCY RANGE	1GHz ~ 40GHz		Average (AV)

ANTENNA POLARITY & TEST DISTANCE: HORIZONTAL AT 3 M

NO.	FREQ. (MHz)	EMISSION LEVEL (dBuV/m)	LIMIT (dBuV/m)	MARGIN (dB)	ANTENNA HEIGHT (m)	TABLE ANGLE (Degree)	RAW VALUE (dBuV)	CORRECTION FACTOR (dB/m)
1	#5644.94	62.6 PK	68.2	-5.6	1.73 H	256	59.9	2.7
2	*5755.00	112.5 PK			1.73 H	256	109.5	3.0
3	*5755.00	99.2 AV			1.73 H	256	96.2	3.0
4	#5995.36	57.6 PK	68.2	-10.6	1.73 H	256	54.4	3.2
5	11510.00	47.2 PK	74.0	-26.8	1.70 H	205	34.9	12.3
6	11510.00	40.8 AV	54.0	-13.2	1.70 H	205	28.5	12.3
7	#17265.00	50.8 PK	68.2	-17.4	2.35 H	126	35.4	15.4

ANTENNA POLARITY & TEST DISTANCE: VERTICAL AT 3 M

NO.	FREQ. (MHz)	EMISSION LEVEL (dBuV/m)	LIMIT (dBuV/m)	MARGIN (dB)	ANTENNA HEIGHT (m)	TABLE ANGLE (Degree)	RAW VALUE (dBuV)	CORRECTION FACTOR (dB/m)
1	#5644.01	58.2 PK	68.2	-10.0	2.59 V	351	55.5	2.7
2	*5755.00	104.3 PK			2.59 V	351	101.3	3.0
3	*5755.00	92.4 AV			2.59 V	351	89.4	3.0
4	#5950.47	57.7 PK	68.2	-10.5	2.59 V	351	54.5	3.2
5	11510.00	48.9 PK	74.0	-25.1	1.37 V	203	36.6	12.3
6	11510.00	43.7 AV	54.0	-10.3	1.37 V	203	31.4	12.3
7	#17265.00	54.1 PK	68.2	-14.1	1.88 V	287	38.7	15.4

REMARKS:

1. Emission Level(dBuV/m) = Raw Value(dBuV) + Correction Factor(dB/m)
2. Correction Factor(dB/m) = Antenna Factor(dB/m) + Cable Factor(dB) – Pre-Amplifier Factor(dB)
3. The other emission levels were very low against the limit.
4. Margin value = Emission Level – Limit value
5. " * ": Fundamental frequency.
6. " # ": The radiated frequency is out of the restricted band.

CHANNEL	TX Channel 159	DETECTOR FUNCTION	Peak (PK)
FREQUENCY RANGE	1GHz ~ 40GHz		Average (AV)

ANTENNA POLARITY & TEST DISTANCE: HORIZONTAL AT 3 M

NO.	FREQ. (MHz)	EMISSION LEVEL (dBuV/m)	LIMIT (dBuV/m)	MARGIN (dB)	ANTENNA HEIGHT (m)	TABLE ANGLE (Degree)	RAW VALUE (dBuV)	CORRECTION FACTOR (dB/m)
1	#5649.67	62.4 PK	68.2	-5.8	1.66 H	252	59.7	2.7
2	*5795.00	111.4 PK			1.66 H	252	108.4	3.0
3	*5795.00	100.0 AV			1.66 H	252	97.0	3.0
4	#5934.09	63.4 PK	68.2	-4.8	1.66 H	252	60.0	3.4
5	11590.00	46.5 PK	74.0	-27.5	1.66 H	221	34.1	12.4
6	11590.00	40.4 AV	54.0	-13.6	1.66 H	221	28.0	12.4
7	#17385.00	50.9 PK	68.2	-17.3	2.35 H	128	34.7	16.2

ANTENNA POLARITY & TEST DISTANCE: VERTICAL AT 3 M

NO.	FREQ. (MHz)	EMISSION LEVEL (dBuV/m)	LIMIT (dBuV/m)	MARGIN (dB)	ANTENNA HEIGHT (m)	TABLE ANGLE (Degree)	RAW VALUE (dBuV)	CORRECTION FACTOR (dB/m)
1	#5618.59	58.0 PK	68.2	-10.2	2.58 V	287	55.2	2.8
2	*5795.00	105.8 PK			2.58 V	287	102.8	3.0
3	*5795.00	93.0 AV			2.58 V	287	90.0	3.0
4	#5934.44	59.6 PK	68.2	-8.6	2.58 V	287	56.2	3.4
5	11590.00	48.7 PK	74.0	-25.3	1.46 V	210	36.3	12.4
6	11590.00	43.1 AV	54.0	-10.9	1.46 V	210	30.7	12.4
7	#17385.00	52.7 PK	68.2	-15.5	1.83 V	292	36.5	16.2

REMARKS:

1. Emission Level(dBuV/m) = Raw Value(dBuV) + Correction Factor(dB/m)
2. Correction Factor(dB/m) = Antenna Factor(dB/m) + Cable Factor(dB) – Pre-Amplifier Factor(dB)
3. The other emission levels were very low against the limit.
4. Margin value = Emission Level – Limit value
5. " * ": Fundamental frequency.
6. " # ": The radiated frequency is out of the restricted band.

802.11ax (HE80)

CHANNEL	TX Channel 42	DETECTOR FUNCTION	Peak (PK)
FREQUENCY RANGE	1GHz ~ 40GHz		Average (AV)

ANTENNA POLARITY & TEST DISTANCE: HORIZONTAL AT 3 M

NO.	FREQ. (MHz)	EMISSION LEVEL (dBuV/m)	LIMIT (dBuV/m)	MARGIN (dB)	ANTENNA HEIGHT (m)	TABLE ANGLE (Degree)	RAW VALUE (dBuV)	CORRECTION FACTOR (dB/m)
1	5150.00	67.8 PK	74.0	-6.2	1.72 H	294	65.2	2.6
2	5150.00	53.9 AV	54.0	-0.1	1.72 H	294	51.3	2.6
3	*5210.00	104.2 PK			1.72 H	294	101.8	2.4
4	*5210.00	91.3 AV			1.72 H	294	88.9	2.4
5	5350.00	51.8 PK	74.0	-22.2	1.72 H	294	49.5	2.3
6	5350.00	39.5 AV	54.0	-14.5	1.72 H	294	37.2	2.3
7	#10420.00	48.9 PK	68.2	-19.3	2.89 H	323	36.7	12.2
8	15630.00	52.5 PK	74.0	-21.5	2.08 H	28	39.8	12.7
9	15630.00	39.6 AV	54.0	-14.4	2.08 H	28	26.9	12.7

ANTENNA POLARITY & TEST DISTANCE: VERTICAL AT 3 M

NO.	FREQ. (MHz)	EMISSION LEVEL (dBuV/m)	LIMIT (dBuV/m)	MARGIN (dB)	ANTENNA HEIGHT (m)	TABLE ANGLE (Degree)	RAW VALUE (dBuV)	CORRECTION FACTOR (dB/m)
1	5150.00	61.6 PK	74.0	-12.4	2.88 V	270	59.0	2.6
2	5150.00	49.6 AV	54.0	-4.4	2.88 V	270	47.0	2.6
3	*5210.00	100.1 PK			2.88 V	270	97.7	2.4
4	*5210.00	86.7 AV			2.88 V	270	84.3	2.4
5	5350.00	46.9 PK	74.0	-27.1	2.88 V	270	44.6	2.3
6	5350.00	35.4 AV	54.0	-18.6	2.88 V	270	33.1	2.3
7	#10420.00	49.7 PK	68.2	-18.5	2.09 V	317	37.5	12.2
8	15630.00	59.8 PK	74.0	-14.2	2.86 V	226	47.1	12.7
9	15630.00	48.2 AV	54.0	-5.8	2.86 V	226	35.5	12.7

REMARKS:

- Emission Level(dBuV/m) = Raw Value(dBuV) + Correction Factor(dB/m)
- Correction Factor(dB/m) = Antenna Factor(dB/m) + Cable Factor(dB) – Pre-Amplifier Factor(dB)
- The other emission levels were very low against the limit.
- Margin value = Emission Level – Limit value
- " * ": Fundamental frequency.
- " # ": The radiated frequency is out of the restricted band.

CHANNEL	TX Channel 155	DETECTOR FUNCTION	Peak (PK)
FREQUENCY RANGE	1GHz ~ 40GHz		Average (AV)

ANTENNA POLARITY & TEST DISTANCE: HORIZONTAL AT 3 M

NO.	FREQ. (MHz)	EMISSION LEVEL (dBuV/m)	LIMIT (dBuV/m)	MARGIN (dB)	ANTENNA HEIGHT (m)	TABLE ANGLE (Degree)	RAW VALUE (dBuV)	CORRECTION FACTOR (dB/m)
1	#5645.80	67.8 PK	68.2	-0.4	3.30 H	290	65.1	2.7
2	*5775.00	109.1 PK			3.30 H	290	106.1	3.0
3	*5775.00	96.3 AV			3.30 H	290	93.3	3.0
4	#5928.77	62.5 PK	68.2	-5.7	3.30 H	290	59.1	3.4
5	11550.00	47.9 PK	74.0	-26.1	1.70 H	216	35.5	12.4
6	11550.00	41.4 AV	54.0	-12.6	1.70 H	216	29.0	12.4
7	#17325.00	50.2 PK	68.2	-18.0	2.38 H	116	34.5	15.7

ANTENNA POLARITY & TEST DISTANCE: VERTICAL AT 3 M

NO.	FREQ. (MHz)	EMISSION LEVEL (dBuV/m)	LIMIT (dBuV/m)	MARGIN (dB)	ANTENNA HEIGHT (m)	TABLE ANGLE (Degree)	RAW VALUE (dBuV)	CORRECTION FACTOR (dB/m)
1	#5643.39	60.0 PK	68.2	-8.2	2.35 V	257	57.3	2.7
2	*5775.00	100.0 PK			2.35 V	257	97.0	3.0
3	*5775.00	88.7 AV			2.35 V	257	85.7	3.0
4	#5932.61	57.4 PK	68.2	-10.8	2.35 V	257	54.0	3.4
5	11550.00	49.5 PK	74.0	-24.5	1.30 V	208	37.1	12.4
6	11550.00	43.8 AV	54.0	-10.2	1.30 V	208	31.4	12.4
7	#17325.00	53.1 PK	68.2	-15.1	1.75 V	297	37.4	15.7

REMARKS:

1. Emission Level(dBuV/m) = Raw Value(dBuV) + Correction Factor(dB/m)
2. Correction Factor(dB/m) = Antenna Factor(dB/m) + Cable Factor(dB) – Pre-Amplifier Factor(dB)
3. The other emission levels were very low against the limit.
4. Margin value = Emission Level – Limit value
5. " * ": Fundamental frequency.
6. " # ": The radiated frequency is out of the restricted band.

4.2 Conducted Emission Measurement

4.2.1 Limits of Conducted Emission Measurement

Frequency (MHz)	Conducted Limit (dBuV)	
	Quasi-peak	Average
0.15 - 0.5	66 - 56	56 - 46
0.50 - 5.0	56	46
5.0 - 30.0	60	50

Note: 1. The lower limit shall apply at the transition frequencies.

2. The limit decreases in line with the logarithm of the frequency in the range of 0.15 to 0.50MHz.

4.2.2 Test Instruments

DESCRIPTION & MANUFACTURER	MODEL NO.	SERIAL NO.	CALIBRATED DATE	CALIBRATED UNTIL
Test Receiver R&S	ESCS 30	847124/029	Nov. 01, 2017	Oct. 31, 2018
Line-Impedance Stabilization Network (for EUT) R&S	ESH3-Z5	848773/004	Nov. 15, 2017	Nov. 14, 2018
Line-Impedance Stabilization Network (for Peripheral) R&S	ENV216	100072	June 04, 2018	June 03, 2019
50 ohms Terminator	N/A	EMC-02	Sep. 22, 2017	Sep. 21, 2018
RF Cable	5D-FB	COCCAB-001	Sep. 29, 2017	Sep. 28, 2018
Fixed attenuator EMCI	STI02-2200-10	003	Mar. 16, 2018	Mar. 15, 2019
Software BVADT	BVADT_Cond_ V7.3.7.4	NA	NA	NA

Note:

1. The calibration interval of the above test instruments are 12 months and the calibrations are traceable to NML/ROC and NIST/USA.
2. The test was performed in Conduction 1.
- 3 Tested Date: Aug. 29, 2018

4.2.3 Test Procedure

- a. The EUT was placed 0.4 meters from the conducting wall of the shielded room with EUT being connected to the power mains through a line impedance stabilization network (LISN). Other support units were connected to the power mains through another LISN. The two LISNs provide 50 ohm/ 50uH of coupling impedance for the measuring instrument.
- b. Both lines of the power mains connected to the EUT were checked for maximum conducted interference.
- c. The frequency range from 150kHz to 30MHz was searched. Emission levels under (Limit - 20dB) was not recorded.

Note: All modes of operation were investigated and the worst-case emissions are reported.

4.2.4 Deviation from Test Standard

No deviation.

4.2.5 Test Setup

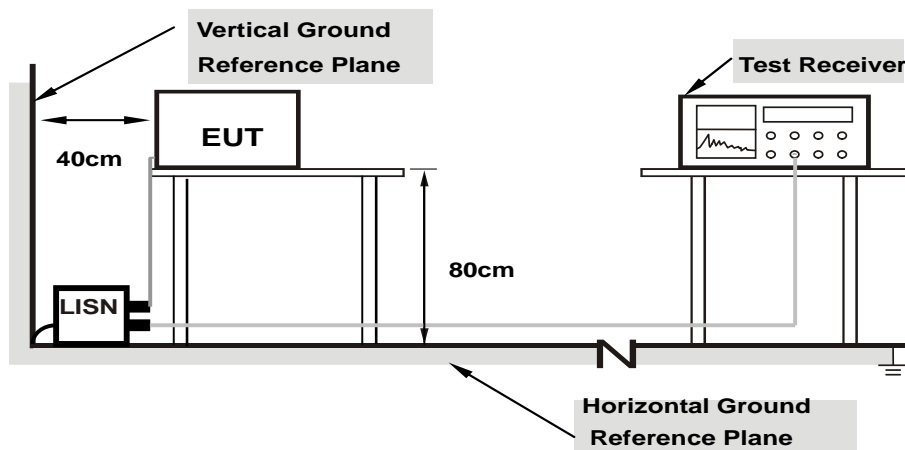

Note: 1.Support units were connected to second LISN.

For the actual test configuration, please refer to the attached file (Test Setup Photo).

4.2.6 EUT Operating Condition

Same as 4.1.6.

4.2.7 Test Results

Phase	Line (L)	Detector Function	Quasi-Peak (QP) / Average (AV)
-------	----------	-------------------	--------------------------------

No	Freq. [MHz]	Corr.	Reading Value		Emission Level		Limit		Margin	
		Factor (dB)	[dB (uV)]		[dB (uV)]		[dB (uV)]		(dB)	
			Q.P.	AV.	Q.P.	AV.	Q.P.	AV.	Q.P.	AV.
1	0.16172	10.04	25.12	7.55	35.16	17.59	65.38	55.38	-30.22	-37.79
2	0.22031	10.07	31.61	22.22	41.68	32.29	62.81	52.81	-21.13	-20.52
3	0.40391	10.11	28.84	18.14	38.95	28.25	57.77	47.77	-18.82	-19.52
4	0.95078	10.15	14.26	4.62	24.41	14.77	56.00	46.00	-31.59	-31.23
5	24.45313	11.14	31.59	29.82	42.73	40.96	60.00	50.00	-17.27	-9.04
6	28.68750	11.22	36.16	33.49	47.38	44.71	60.00	50.00	-12.62	-5.29

Remarks:

1. Q.P. and AV. are abbreviations of quasi-peak and average individually.
2. The emission levels of other frequencies were very low against the limit.
3. Margin value = Emission level – Limit value
4. Correction factor = Insertion loss + Cable loss
5. Emission Level = Correction Factor + Reading Value

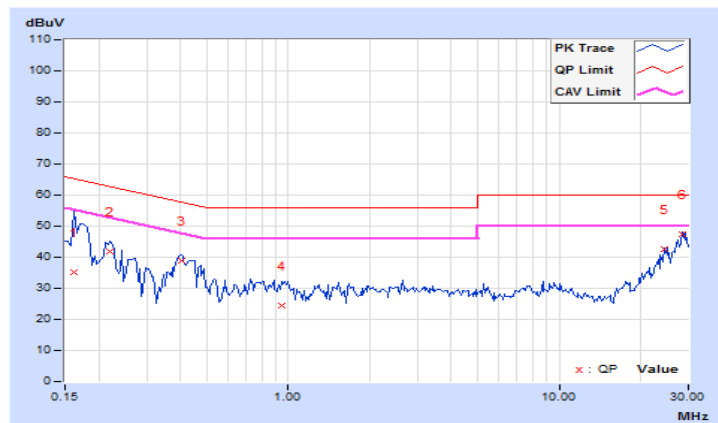

Phase	Neutral (N)	Detector Function	Quasi-Peak (QP) / Average (AV)
-------	-------------	-------------------	--------------------------------

No	Freq. [MHz]	Corr.	Reading Value		Emission Level		Limit		Margin	
		Factor	[dB (uV)]		[dB (uV)]		[dB (uV)]		(dB)	
	(dB)	Q.P.	AV.	Q.P.	AV.	Q.P.	AV.	Q.P.	AV.	
1	0.15000	9.94	36.64	10.10	46.58	20.04	66.00	56.00	-19.42	-35.96
2	0.17734	9.95	37.22	26.87	47.17	36.82	64.61	54.61	-17.44	-17.79
3	0.39609	10.00	26.85	20.17	36.85	30.17	57.93	47.93	-21.08	-17.76
4	0.81797	10.02	15.08	5.38	25.10	15.40	56.00	46.00	-30.90	-30.60
5	7.65234	10.29	15.22	8.89	25.51	19.18	60.00	50.00	-34.49	-30.82
6	28.68750	10.97	35.83	33.15	46.80	44.12	60.00	50.00	-13.20	-5.88

Remarks:

1. Q.P. and AV. are abbreviations of quasi-peak and average individually.
2. The emission levels of other frequencies were very low against the limit.
3. Margin value = Emission level – Limit value
4. Correction factor = Insertion loss + Cable loss
5. Emission Level = Correction Factor + Reading Value

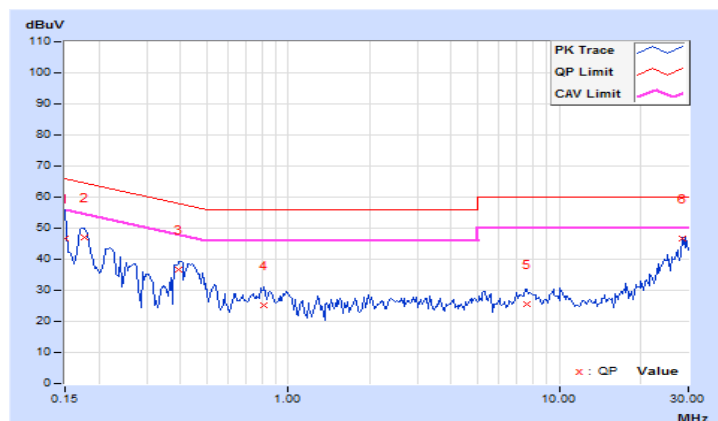

4.3 Transmit Power Measurement

4.3.1 Limits of Transmit Power Measurement

Operation Band	EUT Category		Limit
U-NII-1		Outdoor Access Point	1 Watt (30 dBm) (Max. e.i.r.p \leq 125mW(21 dBm) at any elevation angle above 30 degrees as measured from the horizon)
		Fixed point-to-point Access Point	1 Watt (30 dBm)
	√	Indoor Access Point	1 Watt (30 dBm)
		Client device	250mW (24 dBm)
U-NII-2A			250mW (24 dBm) or 11 dBm+10 log B*
U-NII-2C			250mW (24 dBm) or 11 dBm+10 log B*
U-NII-3		√	1 Watt (30 dBm)

*B is the 26 dB emission bandwidth in megahertz

Per KDB 662911 Method of conducted output power measurement on IEEE 802.11 devices,

Array Gain = 0 dB (i.e., no array gain) for $N_{ANT} \leq 4$;

Array Gain = 0 dB (i.e., no array gain) for channel widths ≥ 40 MHz for any N_{ANT} ;

Array Gain = $5 \log(N_{ANT}/N_{SS})$ dB or 3 dB, whichever is less for 20-MHz channel widths with $N_{ANT} \geq 5$.

For power measurements on all other devices: Array Gain = $10 \log(N_{ANT}/N_{SS})$ dB.

4.3.2 Test Setup

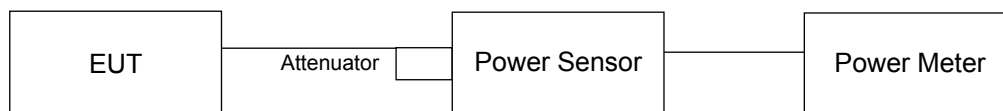

4.3.3 Test Instruments

Refer to section 4.1.2 to get information of above instrument.

4.3.4 Test Procedure

Method PM is used to perform output power measurement, trigger and gating function of wide band power meter is enabled to measure max output power of TX on burst. Duty factor is not added to measured value.

4.3.5 Deviation from Test Standard

No deviation.

4.3.6 EUT Operating Condition

The software provided by client to enable the EUT under transmission condition continuously at lowest, middle and highest channel frequencies individually.

4.3.7 Test Results (Mode 1)

Non-Beamforming Mode

802.11a

Chan.	Freq. (MHz)	Maximum Conducted Power (dBm)								Total Power (mW)	Total Power (dBm)	Limit (dBm)	Pass / Fail
		Chain 0	Chain 1	Chain 2	Chain 3	Chain 4	Chain 5	Chain 6	Chain 7				
36	5180	16.96	17.39	17.39	17.31	16.60	17.52	16.89	17.31	418.036	26.21	26.71	Pass
40	5200	16.55	17.26	17.56	17.17	16.82	17.57	16.82	16.92	410.052	26.13	26.71	Pass
48	5240	16.51	17.24	17.65	16.91	16.77	17.21	17.19	17.02	407.884	26.11	26.71	Pass
149	5745	16.56	16.86	17.37	17.08	16.97	17.66	16.76	17.27	408.321	26.11	26.80	Pass
157	5785	16.63	17.19	17.38	16.88	16.51	17.42	16.92	16.85	399.44	26.01	26.80	Pass
165	5825	16.84	17.13	17.64	17.19	16.50	17.44	16.79	17.32	412.219	26.15	26.80	Pass

Note: 1. For U-NII-1: The directional gain is 9.29dBi > 6dBi, so the power limit shall be reduced to $30-(9.29-6) = 26.71\text{dBm}$.

2. For U-NII-3: The directional gain is 9.2dBi > 6dBi, so the power limit shall be reduced to $30-(9.2-6) = 26.8\text{dBm}$.

802.11ac (VHT20)

Chan.	Freq. (MHz)	Maximum Conducted Power (dBm)								Total Power (mW)	Total Power (dBm)	Limit (dBm)	Pass / Fail
		Chain 0	Chain 1	Chain 2	Chain 3	Chain 4	Chain 5	Chain 6	Chain 7				
36	5180	16.63	16.89	17.34	16.93	16.47	17.37	16.96	16.97	396.778	25.99	26.71	Pass
40	5200	16.31	16.47	16.85	17.01	16.34	16.90	16.72	16.77	372.322	25.71	26.71	Pass
48	5240	16.44	16.38	17.25	16.80	16.25	17.13	16.54	16.50	372.019	25.71	26.71	Pass
149	5745	16.51	16.39	17.11	16.61	16.36	16.77	16.53	16.97	371.078	25.69	26.80	Pass
157	5785	16.44	16.43	17.32	16.60	16.17	16.93	16.42	16.69	368.906	25.67	26.80	Pass
165	5825	16.18	16.47	17.03	16.87	16.39	17.06	16.39	16.77	370.415	25.69	26.80	Pass

Note: 1. For U-NII-1: The directional gain is 9.29dBi > 6dBi, so the power limit shall be reduced to $30-(9.29-6) = 26.71\text{dBm}$.

2. For U-NII-3: The directional gain is 9.2dBi > 6dBi, so the power limit shall be reduced to $30-(9.2-6) = 26.8\text{dBm}$.

802.11ac (VHT40)

Chan.	Freq. (MHz)	Maximum Conducted Power (dBm)								Total Power (mW)	Total Power (dBm)	Limit (dBm)	Pass / Fail
		Chain 0	Chain 1	Chain 2	Chain 3	Chain 4	Chain 5	Chain 6	Chain 7				
38	5190	14.81	15.31	15.26	14.20	15.43	14.88	14.74	15.33	253.688	24.04	26.71	Pass
46	5230	16.52	16.66	16.98	16.48	16.51	17.25	16.59	16.41	372.786	25.71	26.71	Pass
151	5755	16.36	16.58	17.29	16.68	16.38	16.68	16.53	16.50	368.544	25.66	26.80	Pass
159	5795	16.34	16.47	17.09	16.71	16.47	17.15	16.71	16.47	372.946	25.72	26.80	Pass

Note: 1. For U-NII-1: The directional gain is 9.29dBi > 6dBi, so the power limit shall be reduced to $30-(9.29-6) = 26.71\text{dBm}$.

2. For U-NII-3: The directional gain is 9.2dBi > 6dBi, so the power limit shall be reduced to $30-(9.2-6) = 26.8\text{dBm}$.

802.11ac (VHT80)

Chan.	Freq. (MHz)	Maximum Conducted Power (dBm)								Total Power (mW)	Total Power (dBm)	Limit (dBm)	Pass / Fail
		Chain 0	Chain 1	Chain 2	Chain 3	Chain 4	Chain 5	Chain 6	Chain 7				
42	5210	14.42	15.15	15.10	15.20	14.52	15.20	14.11	14.18	239.248	23.79	26.71	Pass
155	5775	16.40	16.54	17.16	16.48	16.34	16.99	16.38	16.60	367.412	25.65	26.80	Pass

Note: 1. For U-NII-1: The directional gain is 9.29dBi > 6dBi, so the power limit shall be reduced to $30-(9.29-6) = 26.71\text{dBm}$.

2. For U-NII-3: The directional gain is 9.2dBi > 6dBi, so the power limit shall be reduced to $30-(9.2-6) = 26.8\text{dBm}$.

802.11ac (VHT80+80)

Chan.	Freq. (MHz)	Maximum Conducted Power (dBm)								Total Power (mW)	Total Power (dBm)	Limit (dBm)	Pass / Fail
		Chain 0	Chain 1	Chain 2	Chain 3	Chain 4	Chain 5	Chain 6	Chain 7				
42+155	5210	15.81	16.04	16.17	15.41	-	-	-	-	154.439	21.89	26.71	Pass
	5775	-	-	-	-	15.57	16.22	16.39	15.93	160.663	22.06	26.80	Pass

Note: 1. For U-NII-1: The directional gain is 9.29dBi > 6dBi, so the power limit shall be reduced to $30-(9.29-6) = 26.71\text{dBm}$.

2. For U-NII-3: The directional gain is 9.2dBi > 6dBi, so the power limit shall be reduced to $30-(9.2-6) = 26.8\text{dBm}$.

802.11ax (HE20)

Chan.	Freq. (MHz)	Maximum Conducted Power (dBm)								Total Power (mW)	Total Power (dBm)	Limit (dBm)	Pass / Fail
		Chain 0	Chain 1	Chain 2	Chain 3	Chain 4	Chain 5	Chain 6	Chain 7				
36	5180	16.99	17.33	17.70	17.35	16.98	17.69	17.22	17.33	432.724	26.36	26.71	Pass
40	5200	16.66	16.98	17.20	17.27	16.72	17.31	17.08	17.29	407.494	26.10	26.71	Pass
48	5240	16.90	16.91	17.51	17.06	16.63	17.64	16.93	16.96	408.327	26.11	26.71	Pass
149	5745	16.93	16.89	17.49	16.97	16.81	17.28	16.92	17.33	408.77	26.11	26.80	Pass
157	5785	16.93	16.94	17.68	16.98	16.59	17.42	16.75	17.01	405.612	26.08	26.80	Pass
165	5825	16.69	16.93	17.41	17.33	16.78	17.42	16.78	17.28	409.09	26.12	26.80	Pass

Note: 1. For U-NII-1: The directional gain is 9.29dBi > 6dBi, so the power limit shall be reduced to $30-(9.29-6) = 26.71\text{dBm}$.

2. For U-NII-3: The directional gain is 9.2dBi > 6dBi, so the power limit shall be reduced to $30-(9.2-6) = 26.8\text{dBm}$.

802.11ax (HE40)

Chan.	Freq. (MHz)	Maximum Conducted Power (dBm)								Total Power (mW)	Total Power (dBm)	Limit (dBm)	Pass / Fail
		Chain 0	Chain 1	Chain 2	Chain 3	Chain 4	Chain 5	Chain 6	Chain 7				
38	5190	15.15	15.73	15.77	14.80	15.81	15.29	15.06	15.69	279.146	24.46	26.71	Pass
46	5230	16.88	17.08	17.51	16.87	16.95	17.63	17.01	16.93	411.847	26.15	26.71	Pass
151	5755	16.75	16.94	17.67	17.09	16.85	17.26	17.02	16.89	407.237	26.10	26.80	Pass
159	5795	16.75	16.96	17.47	17.07	16.89	17.53	17.10	16.93	409.847	26.13	26.80	Pass

Note: 1. For U-NII-1: The directional gain is 9.29dBi > 6dBi, so the power limit shall be reduced to $30-(9.29-6) = 26.71\text{dBm}$.

2. For U-NII-3: The directional gain is 9.2dBi > 6dBi, so the power limit shall be reduced to $30-(9.2-6) = 26.8\text{dBm}$.

802.11ax (HE80)

Chan.	Freq. (MHz)	Maximum Conducted Power (dBm)								Total Power (mW)	Total Power (dBm)	Limit (dBm)	Pass / Fail
		Chain 0	Chain 1	Chain 2	Chain 3	Chain 4	Chain 5	Chain 6	Chain 7				
42	5210	14.52	15.25	15.17	15.22	14.55	15.22	14.13	14.21	241.983	23.84	26.71	Pass
155	5775	16.73	16.88	17.41	16.97	16.70	17.50	16.77	16.98	401.135	26.03	26.80	Pass

Note: 1. For U-NII-1: The directional gain is 9.29dBi > 6dBi, so the power limit shall be reduced to $30-(9.29-6) = 26.71\text{dBm}$.

2. For U-NII-3: The directional gain is 9.2dBi > 6dBi, so the power limit shall be reduced to $30-(9.2-6) = 26.8\text{dBm}$.

802.11ax (HE80+80)

Chan.	Freq. (MHz)	Maximum Conducted Power (dBm)								Total Power (mW)	Total Power (dBm)	Limit (dBm)	Pass / Fail
		Chain 0	Chain 1	Chain 2	Chain 3	Chain 4	Chain 5	Chain 6	Chain 7				
42+155	5210	16.22	16.42	16.53	15.80	-	-	-	-	168.729	22.27	26.71	Pass
	5775	-	-	-	-	15.98	16.58	16.79	16.44	176.935	22.48	26.80	Pass

Note: 1. For U-NII-1: The directional gain is 9.29dBi > 6dBi, so the power limit shall be reduced to $30-(9.29-6) = 26.71\text{dBm}$.

2. For U-NII-3: The directional gain is 9.2dBi > 6dBi, so the power limit shall be reduced to $30-(9.2-6) = 26.8\text{dBm}$.

Beamforming Mode

802.11ac (VHT20)

Chan.	Freq. (MHz)	Maximum Conducted Power (dBm)								Total Power (mW)	Total Power (dBm)	Limit (dBm)	Pass / Fail
		Chain 0	Chain 1	Chain 2	Chain 3	Chain 4	Chain 5	Chain 6	Chain 7				
36	5180	16.63	16.89	17.34	16.93	16.47	17.37	16.96	16.97	396.778	25.99	26.71	Pass
40	5200	16.31	16.47	16.85	17.01	16.34	16.90	16.72	16.77	372.322	25.71	26.71	Pass
48	5240	16.44	16.38	17.25	16.80	16.25	17.13	16.54	16.50	372.019	25.71	26.71	Pass
149	5745	16.51	16.39	17.11	16.61	16.36	16.77	16.53	16.97	371.078	25.69	26.80	Pass
157	5785	16.44	16.43	17.32	16.60	16.17	16.93	16.42	16.69	368.906	25.67	26.80	Pass
165	5825	16.18	16.47	17.03	16.87	16.39	17.06	16.39	16.77	370.415	25.69	26.80	Pass

Note: 1. For U-NII-1: The directional gain is 9.29dBi > 6dBi, so the power limit shall be reduced to $30-(9.29-6) = 26.71\text{dBm}$.

2. For U-NII-3: The directional gain is 9.2dBi > 6dBi, so the power limit shall be reduced to $30-(9.2-6) = 26.8\text{dBm}$.

802.11ac (VHT40)

Chan.	Freq. (MHz)	Maximum Conducted Power (dBm)								Total Power (mW)	Total Power (dBm)	Limit (dBm)	Pass / Fail
		Chain 0	Chain 1	Chain 2	Chain 3	Chain 4	Chain 5	Chain 6	Chain 7				
38	5190	14.81	15.31	15.26	14.20	15.43	14.88	14.74	15.33	253.688	24.04	26.71	Pass
46	5230	16.52	16.66	16.98	16.48	16.51	17.25	16.59	16.41	372.786	25.71	26.71	Pass
151	5755	16.36	16.58	17.29	16.68	16.38	16.68	16.53	16.50	368.544	25.66	26.80	Pass
159	5795	16.34	16.47	17.09	16.71	16.47	17.15	16.71	16.47	372.946	25.72	26.80	Pass

Note: 1. For U-NII-1: The directional gain is 9.29dBi > 6dBi, so the power limit shall be reduced to $30-(9.29-6) = 26.71\text{dBm}$.

2. For U-NII-3: The directional gain is 9.2dBi > 6dBi, so the power limit shall be reduced to $30-(9.2-6) = 26.8\text{dBm}$.

802.11ac (VHT80)

Chan.	Freq. (MHz)	Maximum Conducted Power (dBm)								Total Power (mW)	Total Power (dBm)	Limit (dBm)	Pass / Fail
		Chain 0	Chain 1	Chain 2	Chain 3	Chain 4	Chain 5	Chain 6	Chain 7				
42	5210	14.42	15.15	15.10	15.20	14.52	15.20	14.11	14.18	239.248	23.79	26.71	Pass
155	5775	16.40	16.54	17.16	16.48	16.34	16.99	16.38	16.60	367.412	25.65	26.80	Pass

Note: 1. For U-NII-1: The directional gain is 9.29dBi > 6dBi, so the power limit shall be reduced to $30-(9.29-6) = 26.71\text{dBm}$.

2. For U-NII-3: The directional gain is 9.2dBi > 6dBi, so the power limit shall be reduced to $30-(9.2-6) = 26.8\text{dBm}$.

802.11ac (VHT80+80)

Chan.	Freq. (MHz)	Maximum Conducted Power (dBm)								Total Power (mW)	Total Power (dBm)	Limit (dBm)	Pass / Fail
		Chain 0	Chain 1	Chain 2	Chain 3	Chain 4	Chain 5	Chain 6	Chain 7				
42+155	5210	15.81	16.04	16.17	15.41	-	-	-	-	154.439	21.89	26.71	Pass
	5775	-	-	-	-	15.57	16.22	16.39	15.93	160.663	22.06	26.80	Pass

Note: 1. For U-NII-1: The directional gain is 9.29dBi > 6dBi, so the power limit shall be reduced to $30-(9.29-6) = 26.71$ dBm.

2. For U-NII-3: The directional gain is 9.2dBi > 6dBi, so the power limit shall be reduced to $30-(9.2-6) = 26.8$ dBm.

802.11ax (HE20)

Chan.	Freq. (MHz)	Maximum Conducted Power (dBm)								Total Power (mW)	Total Power (dBm)	Limit (dBm)	Pass / Fail
		Chain 0	Chain 1	Chain 2	Chain 3	Chain 4	Chain 5	Chain 6	Chain 7				
36	5180	16.99	17.33	17.70	17.35	16.98	17.69	17.22	17.33	432.724	26.36	26.71	Pass
40	5200	16.66	16.98	17.20	17.27	16.72	17.31	17.08	17.29	407.494	26.10	26.71	Pass
48	5240	16.90	16.91	17.51	17.06	16.63	17.64	16.93	16.96	408.327	26.11	26.71	Pass
149	5745	16.93	16.89	17.49	16.97	16.81	17.28	16.92	17.33	408.77	26.11	26.80	Pass
157	5785	16.93	16.94	17.68	16.98	16.59	17.42	16.75	17.01	405.612	26.08	26.80	Pass
165	5825	16.69	16.93	17.41	17.33	16.78	17.42	16.78	17.28	409.09	26.12	26.80	Pass

Note: 1. For U-NII-1: The directional gain is 9.29dBi > 6dBi, so the power limit shall be reduced to $30-(9.29-6) = 26.71$ dBm.

2. For U-NII-3: The directional gain is 9.2dBi > 6dBi, so the power limit shall be reduced to $30-(9.2-6) = 26.8$ dBm.

802.11ax (HE40)

Chan.	Freq. (MHz)	Maximum Conducted Power (dBm)								Total Power (mW)	Total Power (dBm)	Limit (dBm)	Pass / Fail
		Chain 0	Chain 1	Chain 2	Chain 3	Chain 4	Chain 5	Chain 6	Chain 7				
38	5190	15.15	15.73	15.77	14.80	15.81	15.29	15.06	15.69	279.146	24.46	26.71	Pass
46	5230	16.88	17.08	17.51	16.87	16.95	17.63	17.01	16.93	411.847	26.15	26.71	Pass
151	5755	16.75	16.94	17.67	17.09	16.85	17.26	17.02	16.89	407.237	26.10	26.80	Pass
159	5795	16.75	16.96	17.47	17.07	16.89	17.53	17.10	16.93	409.847	26.13	26.80	Pass

Note: 1. For U-NII-1: The directional gain is 9.29dBi > 6dBi, so the power limit shall be reduced to $30-(9.29-6) = 26.71$ dBm.

2. For U-NII-3: The directional gain is 9.2dBi > 6dBi, so the power limit shall be reduced to $30-(9.2-6) = 26.8$ dBm.

802.11ax (HE80)

Chan.	Freq. (MHz)	Maximum Conducted Power (dBm)								Total Power (mW)	Total Power (dBm)	Limit (dBm)	Pass / Fail
		Chain 0	Chain 1	Chain 2	Chain 3	Chain 4	Chain 5	Chain 6	Chain 7				
42	5210	14.52	15.25	15.17	15.22	14.55	15.22	14.13	14.21	241.983	23.84	26.71	Pass
155	5775	16.73	16.88	17.41	16.97	16.70	17.50	16.77	16.98	401.135	26.03	26.80	Pass

Note: 1. For U-NII-1: The directional gain is 9.29dBi > 6dBi, so the power limit shall be reduced to $30-(9.29-6) = 26.71\text{dBm}$.

2. For U-NII-3: The directional gain is 9.2dBi > 6dBi, so the power limit shall be reduced to $30-(9.2-6) = 26.8\text{dBm}$.

802.11ax (HE80+80)

Chan.	Freq. (MHz)	Maximum Conducted Power (dBm)								Total Power (mW)	Total Power (dBm)	Limit (dBm)	Pass / Fail
		Chain 0	Chain 1	Chain 2	Chain 3	Chain 4	Chain 5	Chain 6	Chain 7				
42+155	5210	16.22	16.42	16.53	15.80	-	-	-	-	168.729	22.27	26.71	Pass
	5775	-	-	-	-	15.98	16.58	16.79	16.44	176.935	22.48	26.80	Pass

Note: 1. For U-NII-1: The directional gain is 9.29dBi > 6dBi, so the power limit shall be reduced to $30-(9.29-6) = 26.71\text{dBm}$.

2. For U-NII-3: The directional gain is 9.2dBi > 6dBi, so the power limit shall be reduced to $30-(9.2-6) = 26.8\text{dBm}$.

4.3.8 Test Results (Mode 2)

Non-Beamforming Mode

802.11a

Chan.	Chan. Freq. (MHz)	Maximum Conducted Power (dBm)				Total Power (mW)	Total Power (dBm)	Limit (dBm)	Pass / Fail
		Chain 4	Chain 5	Chain 6	Chain 7				
36	5180	18.99	18.47	19.18	19.20	315.527	24.99	30	Pass
40	5200	18.63	18.25	19.08	18.98	299.758	24.77	30	Pass
48	5240	18.81	18.17	18.88	19.02	298.715	24.75	30	Pass
149	5745	23.20	23.14	22.88	24.12	867.308	29.38	30	Pass
157	5785	23.58	22.89	23.02	24.20	886.044	29.47	30	Pass
165	5825	23.27	22.98	23.60	24.19	902.442	29.55	30	Pass

Note: 1. For U-NII-1: The max. gain is 5.95dBi < 6dBi, so the power limit shall not be reduced.

2. For U-NII-3: The max. gain is 5.7dBi < 6dBi, so the power limit shall not be reduced.

802.11ac (VHT20)

Chan.	Chan. Freq. (MHz)	Maximum Conducted Power (dBm)				Total Power (mW)	Total Power (dBm)	Limit (dBm)	Pass / Fail
		Chain 4	Chain 5	Chain 6	Chain 7				
36	5180	17.35	17.61	17.77	17.94	234.073	23.69	30	Pass
40	5200	17.95	18.83	18.98	18.46	287.971	24.59	30	Pass
48	5240	18.29	17.90	18.81	18.70	279.277	24.46	30	Pass
149	5745	22.59	22.26	22.27	23.18	726.444	28.61	30	Pass
157	5785	22.57	22.13	22.78	23.10	737.867	28.68	30	Pass
165	5825	22.87	22.33	22.92	23.16	767.542	28.85	30	Pass

Note: 1. For U-NII-1: The max. gain is 5.95dBi < 6dBi, so the power limit shall not be reduced.

2. For U-NII-3: The max. gain is 5.7dBi < 6dBi, so the power limit shall not be reduced.

802.11ac (VHT40)

Chan.	Chan. Freq. (MHz)	Maximum Conducted Power (dBm)				Total Power (mW)	Total Power (dBm)	Limit (dBm)	Pass / Fail
		Chain 4	Chain 5	Chain 6	Chain 7				
38	5190	14.54	14.26	15.36	14.75	119.324	20.77	30	Pass
46	5230	19.61	19.64	20.62	19.81	394.52	25.96	30	Pass
151	5755	21.70	21.37	21.49	22.73	613.427	27.88	30	Pass
159	5795	22.18	21.33	21.64	22.66	631.41	28.00	30	Pass

Note: 1. For U-NII-1: The max. gain is 5.95dBi < 6dBi, so the power limit shall not be reduced.

2. For U-NII-3: The max. gain is 5.7dBi < 6dBi, so the power limit shall not be reduced.

802.11ac (VHT80)

Chan.	Chan. Freq. (MHz)	Maximum Conducted Power (dBm)				Total Power (mW)	Total Power (dBm)	Limit (dBm)	Pass / Fail
		Chain 4	Chain 5	Chain 6	Chain 7				
42	5210	14.48	13.64	13.83	13.78	99.208	19.97	30	Pass
155	5775	18.65	18.90	19.03	20.52	343.61	25.36	30	Pass

Note: 1. For U-NII-1: The max. gain is 5.95dBi < 6dBi, so the power limit shall not be reduced.
 2. For U-NII-3: The max. gain is 5.7dBi < 6dBi, so the power limit shall not be reduced.

802.11ac (VHT80+80)

Chan.	Chan. Freq. (MHz)	Maximum Conducted Power (dBm)				Total Power (mW)	Total Power (dBm)	Limit (dBm)	Pass / Fail
		Chain 4	Chain 5	Chain 6	Chain 7				
42+155	5210	13.89	14.56	-	-	53.067	17.25	30	Pass
	5775	-	-	14.20	14.60	55.143	17.41	30	Pass

Note: 1. For U-NII-1: The max. gain is 5.95dBi < 6dBi, so the power limit shall not be reduced.
 2. For U-NII-3: The max. gain is 5.7dBi < 6dBi, so the power limit shall not be reduced.

802.11ax (HE20)

Chan.	Chan. Freq. (MHz)	Maximum Conducted Power (dBm)				Total Power (mW)	Total Power (dBm)	Limit (dBm)	Pass / Fail
		Chain 4	Chain 5	Chain 6	Chain 7				
36	5180	17.83	18.10	18.14	18.23	256.929	24.10	30	Pass
40	5200	18.18	19.21	19.40	18.87	313.32	24.96	30	Pass
48	5240	18.68	18.35	19.22	19.08	306.651	24.87	30	Pass
149	5745	23.15	22.65	22.78	23.59	808.846	29.08	30	Pass
157	5785	22.96	22.54	23.17	23.46	806.481	29.07	30	Pass
165	5825	23.11	22.56	23.40	23.48	826.566	29.17	30	Pass

Note: 1. For U-NII-1: The max. gain is 5.95dBi < 6dBi, so the power limit shall not be reduced.
 2. For U-NII-3: The max. gain is 5.7dBi < 6dBi, so the power limit shall not be reduced.

802.11ax (HE40)

Chan.	Chan. Freq. (MHz)	Maximum Conducted Power (dBm)				Total Power (mW)	Total Power (dBm)	Limit (dBm)	Pass / Fail
		Chain 4	Chain 5	Chain 6	Chain 7				
38	5190	14.83	14.62	15.69	15.11	128.884	21.10	30	Pass
46	5230	20.07	20.02	20.98	20.14	430.677	26.34	30	Pass
151	5755	22.08	21.66	21.78	22.98	657.261	28.18	30	Pass
159	5795	22.54	21.78	21.98	22.92	683.779	28.35	30	Pass

Note: 1. For U-NII-1: The max. gain is 5.95dBi < 6dBi, so the power limit shall not be reduced.

2. For U-NII-3: The max. gain is 5.7dBi < 6dBi, so the power limit shall not be reduced.

802.11ax (HE80)

Chan.	Chan. Freq. (MHz)	Maximum Conducted Power (dBm)				Total Power (mW)	Total Power (dBm)	Limit (dBm)	Pass / Fail
		Chain 4	Chain 5	Chain 6	Chain 7				
42	5210	14.99	14.02	14.28	14.02	108.812	20.37	30	Pass
155	5775	19.14	19.32	19.41	20.95	379.29	25.79	30	Pass

Note: 1. For U-NII-1: The max. gain is 5.95dBi < 6dBi, so the power limit shall not be reduced.

2. For U-NII-3: The max. gain is 5.7dBi < 6dBi, so the power limit shall not be reduced.

802.11ax (HE80+80)

Chan.	Chan. Freq. (MHz)	Maximum Conducted Power (dBm)				Total Power (mW)	Total Power (dBm)	Limit (dBm)	Pass / Fail
		Chain 4	Chain 5	Chain 6	Chain 7				
42+155	5210	14.12	14.94	-	-	57.012	17.56	30	Pass
	5775	-	-	14.61	14.96	60.24	17.80	30	Pass

Note: 1. For U-NII-1: The max. gain is 5.95dBi < 6dBi, so the power limit shall not be reduced.

2. For U-NII-3: The max. gain is 5.7dBi < 6dBi, so the power limit shall not be reduced.

Beamforming Mode

802.11ac (VHT20)

Chan.	Chan. Freq. (MHz)	Maximum Conducted Power (dBm)				Total Power (mW)	Total Power (dBm)	Limit (dBm)	Pass / Fail
		Chain 4	Chain 5	Chain 6	Chain 7				
36	5180	17.35	17.61	17.77	17.94	234.073	23.69	25.27	Pass
40	5200	17.95	18.83	18.98	18.46	287.971	24.59	25.27	Pass
48	5240	18.29	17.90	18.81	18.70	279.277	24.46	25.27	Pass
149	5745	18.81	18.26	18.28	19.05	290.672	24.63	25.32	Pass
157	5785	18.66	18.21	18.72	19.01	293.762	24.68	25.32	Pass
165	5825	18.79	18.02	18.78	18.97	293.465	24.68	25.32	Pass

Note: 1. For U-NII-1: The directional gain is 10.73dBi > 6dBi, so the power limit shall be reduced to $30-(10.73-6) = 25.27\text{dBm}$.
 2. For U-NII-3: The directional gain is 10.68dBi > 6dBi, so the power limit shall be reduced to $30-(10.68-6) = 25.32\text{dBm}$.

802.11ac (VHT40)

Chan.	Chan. Freq. (MHz)	Maximum Conducted Power (dBm)				Total Power (mW)	Total Power (dBm)	Limit (dBm)	Pass / Fail
		Chain 4	Chain 5	Chain 6	Chain 7				
38	5190	14.54	14.26	15.36	14.75	119.324	20.77	25.27	Pass
46	5230	18.96	18.97	19.87	19.02	334.441	25.24	25.27	Pass
151	5755	18.84	18.35	18.40	19.63	305.967	24.86	25.32	Pass
159	5795	18.80	17.91	18.19	19.16	285.991	24.56	25.32	Pass

Note: 1. For U-NII-1: The directional gain is 10.73dBi > 6dBi, so the power limit shall be reduced to $30-(10.73-6) = 25.27\text{dBm}$.
 2. For U-NII-3: The directional gain is 10.68dBi > 6dBi, so the power limit shall be reduced to $30-(10.68-6) = 25.32\text{dBm}$.

802.11ac (VHT80)

Chan.	Chan. Freq. (MHz)	Maximum Conducted Power (dBm)				Total Power (mW)	Total Power (dBm)	Limit (dBm)	Pass / Fail
		Chain 4	Chain 5	Chain 6	Chain 7				
42	5210	14.48	13.64	13.83	13.78	99.208	19.97	25.27	Pass
155	5775	18.19	18.41	18.33	20.02	303.799	24.83	25.32	Pass

Note: 1. For U-NII-1: The directional gain is 10.73dBi > 6dBi, so the power limit shall be reduced to $30-(10.73-6) = 25.27\text{dBm}$.
 2. For U-NII-3: The directional gain is 10.68dBi > 6dBi, so the power limit shall be reduced to $30-(10.68-6) = 25.32\text{dBm}$.

802.11ac (VHT80+80)

Chan.	Chan. Freq. (MHz)	Maximum Conducted Power (dBm)				Total Power (mW)	Total Power (dBm)	Limit (dBm)	Pass / Fail
		Chain 4	Chain 5	Chain 6	Chain 7				
42+155	5210	13.89	14.56	-	-	53.067	17.25	25.27	Pass
	5775	-	-	14.20	14.60	55.143	17.41	25.32	Pass

- Note: 1. For U-NII-1: The directional gain is 10.73dBi > 6dBi, so the power limit shall be reduced to $30-(10.73-6) = 25.27\text{dBm}$.
2. For U-NII-3: The directional gain is 10.68dBi > 6dBi, so the power limit shall be reduced to $30-(10.68-6) = 25.32\text{dBm}$.

802.11ax (HE20)

Chan.	Chan. Freq. (MHz)	Maximum Conducted Power (dBm)				Total Power (mW)	Total Power (dBm)	Limit (dBm)	Pass / Fail
		Chain 4	Chain 5	Chain 6	Chain 7				
36	5180	17.83	18.10	18.14	18.23	256.929	24.10	25.27	Pass
40	5200	18.18	19.21	19.40	18.87	313.32	24.96	25.27	Pass
48	5240	18.68	18.35	19.22	19.08	306.651	24.87	25.27	Pass
149	5745	19.12	18.58	18.69	19.43	315.43	24.99	25.32	Pass
157	5785	18.95	18.56	19.13	19.38	318.845	25.04	25.32	Pass
165	5825	19.08	18.23	19.26	19.36	318.068	25.03	25.32	Pass

- Note: 1. For U-NII-1: The directional gain is 10.73dBi > 6dBi, so the power limit shall be reduced to $30-(10.73-6) = 25.27\text{dBm}$.
2. For U-NII-3: The directional gain is 10.68dBi > 6dBi, so the power limit shall be reduced to $30-(10.68-6) = 25.32\text{dBm}$.

802.11ax (HE40)

Chan.	Chan. Freq. (MHz)	Maximum Conducted Power (dBm)				Total Power (mW)	Total Power (dBm)	Limit (dBm)	Pass / Fail
		Chain 4	Chain 5	Chain 6	Chain 7				
38	5190	14.83	14.62	15.69	15.11	128.884	21.10	25.27	Pass
46	5230	18.96	18.97	19.87	19.02	334.441	25.24	25.27	Pass
151	5755	19.10	18.69	18.83	19.98	331.169	25.20	25.32	Pass
159	5795	19.12	18.39	18.65	19.54	313.914	24.97	25.32	Pass

- Note: 1. For U-NII-1: The directional gain is 10.73dBi > 6dBi, so the power limit shall be reduced to $30-(10.73-6) = 25.27\text{dBm}$.
2. For U-NII-3: The directional gain is 10.68dBi > 6dBi, so the power limit shall be reduced to $30-(10.68-6) = 25.32\text{dBm}$.

802.11ax (HE80)

Chan.	Chan. Freq. (MHz)	Maximum Conducted Power (dBm)				Total Power (mW)	Total Power (dBm)	Limit (dBm)	Pass / Fail
		Chain 4	Chain 5	Chain 6	Chain 7				
42	5210	14.99	14.02	14.28	14.02	108.812	20.37	25.27	Pass
155	5775	18.65	18.79	18.86	20.51	338.338	25.29	25.32	Pass

- Note: 1. For U-NII-1: The directional gain is 10.73dBi > 6dBi, so the power limit shall be reduced to $30-(10.73-6) = 25.27\text{dBm}$.
2. For U-NII-3: The directional gain is 10.68dBi > 6dBi, so the power limit shall be reduced to $30-(10.68-6) = 25.32\text{dBm}$.

802.11ax (HE80+80)

Chan.	Chan. Freq. (MHz)	Maximum Conducted Power (dBm)				Total Power (mW)	Total Power (dBm)	Limit (dBm)	Pass / Fail
		Chain 4	Chain 5	Chain 6	Chain 7				
42+155	5210	14.12	14.94	-	-	57.012	17.56	25.27	Pass
	5775	-	-	14.61	14.96	60.24	17.80	25.32	Pass

- Note: 1. For U-NII-1: The directional gain is 10.73dBi > 6dBi, so the power limit shall be reduced to $30-(10.73-6) = 25.27\text{dBm}$.
2. For U-NII-3: The directional gain is 10.68dBi > 6dBi, so the power limit shall be reduced to $30-(10.68-6) = 25.32\text{dBm}$.

4.3.9 Test Results (Mode 3)

Non-Beamforming Mode

802.11a

Chan.	Chan. Freq. (MHz)	Maximum Conducted Power (dBm)		Total Power (mW)	Total Power (dBm)	Limit (dBm)	Pass / Fail
		Chain 1	Chain 2				
36	5180	19.46	20.11	190.873	22.81	29.80	Pass
40	5200	22.10	23.15	368.719	25.67	29.80	Pass
48	5240	20.10	21.36	239.102	23.79	29.80	Pass
149	5745	23.20	23.46	430.75	26.34	29.61	Pass
157	5785	23.10	23.35	420.446	26.24	29.61	Pass
165	5825	23.00	23.30	413.322	26.16	29.61	Pass

- Note: 1. For U-NII-1: The max. gain is 6.2dBi > 6dBi, so the power limit shall be reduced to $30-(6.2-6) = 29.8\text{dBm}$.
2. For U-NII-3: The max. gain is 6.39dBi > 6dBi, so the power limit shall be reduced to $30-(6.39-6) = 29.61\text{dBm}$.

802.11ac (VHT20)

Chan.	Chan. Freq. (MHz)	Maximum Conducted Power (dBm)		Total Power (mW)	Total Power (dBm)	Limit (dBm)	Pass / Fail
		Chain 1	Chain 2				
36	5180	19.46	20.33	196.203	22.93	29.80	Pass
40	5200	22.00	23.23	368.867	25.67	29.80	Pass
48	5240	20.01	21.11	229.353	23.61	29.80	Pass
149	5745	23.12	23.42	424.902	26.28	29.61	Pass
157	5785	23.01	23.42	419.772	26.23	29.61	Pass
165	5825	22.98	23.20	407.539	26.10	29.61	Pass

- Note: 1. For U-NII-1: The max. gain is 6.2dBi > 6dBi, so the power limit shall be reduced to $30-(6.2-6) = 29.8\text{dBm}$.
2. For U-NII-3: The max. gain is 6.39dBi > 6dBi, so the power limit shall be reduced to $30-(6.39-6) = 29.61\text{dBm}$.

802.11ac (VHT40)

Chan.	Chan. Freq. (MHz)	Maximum Conducted Power (dBm)		Total Power (mW)	Total Power (dBm)	Limit (dBm)	Pass / Fail
		Chain 1	Chain 2				
38	5190	16.50	16.77	92.202	19.65	29.80	Pass
46	5230	20.10	20.32	209.976	23.22	29.80	Pass
151	5755	22.32	22.41	344.789	25.38	29.61	Pass
159	5795	22.53	22.70	365.27	25.63	29.61	Pass

- Note: 1. For U-NII-1: The max. gain is 6.2dBi > 6dBi, so the power limit shall be reduced to $30-(6.2-6) = 29.8\text{dBm}$.
 2. For U-NII-3: The max. gain is 6.39dBi > 6dBi, so the power limit shall be reduced to $30-(6.39-6) = 29.61\text{dBm}$.

802.11ac (VHT80)

Chan.	Chan. Freq. (MHz)	Maximum Conducted Power (dBm)		Total Power (mW)	Total Power (dBm)	Limit (dBm)	Pass / Fail
		Chain 1	Chain 2				
42	5210	16.10	16.46	84.997	19.29	29.80	Pass
155	5775	20.46	20.69	228.393	23.59	29.61	Pass

- Note: 1. For U-NII-1: The max. gain is 6.2dBi > 6dBi, so the power limit shall be reduced to $30-(6.2-6) = 29.8\text{dBm}$.
 2. For U-NII-3: The max. gain is 6.39dBi > 6dBi, so the power limit shall be reduced to $30-(6.39-6) = 29.61\text{dBm}$.

802.11ax (HE20)

Chan.	Chan. Freq. (MHz)	Maximum Conducted Power (dBm)		Total Power (mW)	Total Power (dBm)	Limit (dBm)	Pass / Fail
		Chain 1	Chain 2				
36	5180	19.56	20.41	200.266	23.02	29.80	Pass
40	5200	22.05	23.34	376.099	25.75	29.80	Pass
48	5240	20.05	21.21	233.288	23.68	29.80	Pass
149	5745	23.27	23.59	440.884	26.44	29.61	Pass
157	5785	23.10	23.47	426.505	26.30	29.61	Pass
165	5825	23.00	23.30	413.322	26.16	29.61	Pass

- Note: 1. For U-NII-1: The max. gain is 6.2dBi > 6dBi, so the power limit shall be reduced to $30-(6.2-6) = 29.8\text{dBm}$.
 2. For U-NII-3: The max. gain is 6.39dBi > 6dBi, so the power limit shall be reduced to $30-(6.39-6) = 29.61\text{dBm}$.

802.11ax (HE40)

Chan.	Chan. Freq. (MHz)	Maximum Conducted Power (dBm)		Total Power (mW)	Total Power (dBm)	Limit (dBm)	Pass / Fail
		Chain 1	Chain 2				
38	5190	16.59	16.88	94.357	19.75	29.80	Pass
46	5230	20.17	20.35	212.385	23.27	29.80	Pass
151	5755	22.39	22.51	351.618	25.46	29.61	Pass
159	5795	22.65	22.79	374.185	25.73	29.61	Pass

- Note: 1. For U-NII-1: The max. gain is 6.2dBi > 6dBi, so the power limit shall be reduced to $30-(6.2-6) = 29.8\text{dBm}$.
2. For U-NII-3: The max. gain is 6.39dBi > 6dBi, so the power limit shall be reduced to $30-(6.39-6) = 29.61\text{dBm}$.

802.11ax (HE80)

Chan.	Chan. Freq. (MHz)	Maximum Conducted Power (dBm)		Total Power (mW)	Total Power (dBm)	Limit (dBm)	Pass / Fail
		Chain 1	Chain 2				
42	5210	16.13	16.56	86.31	19.36	29.80	Pass
155	5775	20.56	20.77	233.162	23.68	29.61	Pass

- Note: 1. For U-NII-1: The max. gain is 6.2dBi > 6dBi, so the power limit shall be reduced to $30-(6.2-6) = 29.8\text{dBm}$.
2. For U-NII-3: The max. gain is 6.39dBi > 6dBi, so the power limit shall be reduced to $30-(6.39-6) = 29.61\text{dBm}$.

Beamforming Mode

802.11ac (VHT20)

Chan.	Chan. Freq. (MHz)	Maximum Conducted Power (dBm)		Total Power (mW)	Total Power (dBm)	Limit (dBm)	Pass / Fail
		Chain 1	Chain 2				
36	5180	19.46	20.33	196.203	22.93	27.53	Pass
40	5200	22.00	23.23	368.867	25.67	27.53	Pass
48	5240	20.01	21.11	229.353	23.61	27.53	Pass
149	5745	23.12	23.42	424.902	26.28	27.41	Pass
157	5785	23.01	23.42	419.772	26.23	27.41	Pass
165	5825	22.98	23.20	407.539	26.10	27.41	Pass

- Note: 1. For U-NII-1: The directional gain is 8.47dBi > 6dBi, so the power limit shall be reduced to 30-(8.47-6) = 27.53dBm.
 2. For U-NII-3: The directional gain is 8.59dBi > 6dBi, so the power limit shall be reduced to 30-(8.59-6) = 27.41dBm.

802.11ac (VHT40)

Chan.	Chan. Freq. (MHz)	Maximum Conducted Power (dBm)		Total Power (mW)	Total Power (dBm)	Limit (dBm)	Pass / Fail
		Chain 1	Chain 2				
38	5190	16.50	16.77	92.202	19.65	27.53	Pass
46	5230	20.10	20.32	209.976	23.22	27.53	Pass
151	5755	22.32	22.41	344.789	25.38	27.41	Pass
159	5795	22.53	22.70	365.27	25.63	27.41	Pass

- Note: 1. For U-NII-1: The directional gain is 8.47dBi > 6dBi, so the power limit shall be reduced to 30-(8.47-6) = 27.53dBm.
 2. For U-NII-3: The directional gain is 8.59dBi > 6dBi, so the power limit shall be reduced to 30-(8.59-6) = 27.41dBm.

802.11ac (VHT80)

Chan.	Chan. Freq. (MHz)	Maximum Conducted Power (dBm)		Total Power (mW)	Total Power (dBm)	Limit (dBm)	Pass / Fail
		Chain 1	Chain 2				
42	5210	16.10	16.46	84.997	19.29	27.53	Pass
155	5775	20.46	20.69	228.393	23.59	27.41	Pass

- Note: 1. For U-NII-1: The directional gain is 8.47dBi > 6dBi, so the power limit shall be reduced to 30-(8.47-6) = 27.53dBm.
 2. For U-NII-3: The directional gain is 8.59dBi > 6dBi, so the power limit shall be reduced to 30-(8.59-6) = 27.41dBm.

802.11ax (HE20)

Chan.	Chan. Freq. (MHz)	Maximum Conducted Power (dBm)		Total Power (mW)	Total Power (dBm)	Limit (dBm)	Pass / Fail
		Chain 1	Chain 2				
36	5180	19.56	20.41	200.266	23.02	27.53	Pass
40	5200	22.05	23.34	376.099	25.75	27.53	Pass
48	5240	20.05	21.21	233.288	23.68	27.53	Pass
149	5745	23.27	23.59	440.884	26.44	27.41	Pass
157	5785	23.10	23.47	426.505	26.30	27.41	Pass
165	5825	23.00	23.30	413.322	26.16	27.41	Pass

Note: 1. For U-NII-1: The directional gain is 8.47dBi > 6dBi, so the power limit shall be reduced to $30-(8.47-6) = 27.53\text{dBm}$.
 2. For U-NII-3: The directional gain is 8.59dBi > 6dBi, so the power limit shall be reduced to $30-(8.59-6) = 27.41\text{dBm}$.

802.11ax (HE40)

Chan.	Chan. Freq. (MHz)	Maximum Conducted Power (dBm)		Total Power (mW)	Total Power (dBm)	Limit (dBm)	Pass / Fail
		Chain 1	Chain 2				
38	5190	16.59	16.88	94.357	19.75	27.53	Pass
46	5230	20.17	20.35	212.385	23.27	27.53	Pass
151	5755	22.39	22.51	351.618	25.46	27.41	Pass
159	5795	22.65	22.79	374.185	25.73	27.41	Pass

Note: 1. For U-NII-1: The directional gain is 8.47dBi > 6dBi, so the power limit shall be reduced to $30-(8.47-6) = 27.53\text{dBm}$.
 2. For U-NII-3: The directional gain is 8.59dBi > 6dBi, so the power limit shall be reduced to $30-(8.59-6) = 27.41\text{dBm}$.

802.11ax (HE80)

Chan.	Chan. Freq. (MHz)	Maximum Conducted Power (dBm)		Total Power (mW)	Total Power (dBm)	Limit (dBm)	Pass / Fail
		Chain 1	Chain 2				
42	5210	16.13	16.56	86.31	19.36	27.53	Pass
155	5775	20.56	20.77	233.162	23.68	27.41	Pass

Note: 1. For U-NII-1: The directional gain is 8.47dBi > 6dBi, so the power limit shall be reduced to $30-(8.47-6) = 27.53\text{dBm}$.
 2. For U-NII-3: The directional gain is 8.59dBi > 6dBi, so the power limit shall be reduced to $30-(8.59-6) = 27.41\text{dBm}$.

4.3.10 Test Results (Mode 4)

Non-Beamforming Mode

802.11a

Channel	Channel Frequency (MHz)	Maximum Conducted Power (mW)	Maximum Conducted Power (dBm)	Power Limit (dBm)	Pass/Fail
36	5180	108.643	20.36	29.80	Pass
40	5200	222.331	23.47	29.80	Pass
48	5240	107.895	20.33	29.80	Pass
149	5745	230.675	23.63	29.61	Pass
157	5785	223.357	23.49	29.61	Pass
165	5825	221.82	23.46	29.61	Pass

- Note: 1. For U-NII-1: The max. gain is 6.2dBi > 6dBi, so the power limit shall be reduced to $30-(6.2-6) = 29.8\text{dBm}$.
 2. For U-NII-3: The max. gain is 6.39dBi > 6dBi, so the power limit shall be reduced to $30-(6.39-6) = 29.61\text{dBm}$.

802.11ac (VHT20)

Channel	Channel Frequency (MHz)	Maximum Conducted Power (mW)	Maximum Conducted Power (dBm)	Power Limit (dBm)	Pass/Fail
36	5180	107.895	20.33	29.80	Pass
40	5200	215.774	23.34	29.80	Pass
48	5240	109.648	20.40	29.80	Pass
149	5745	225.424	23.53	29.61	Pass
157	5785	223.872	23.50	29.61	Pass
165	5825	220.293	23.43	29.61	Pass

- Note: 1. For U-NII-1: The max. gain is 6.2dBi > 6dBi, so the power limit shall be reduced to $30-(6.2-6) = 29.8\text{dBm}$.
 2. For U-NII-3: The max. gain is 6.39dBi > 6dBi, so the power limit shall be reduced to $30-(6.39-6) = 29.61\text{dBm}$.

802.11ac (VHT40)

Channel	Channel Frequency (MHz)	Maximum Conducted Power (mW)	Maximum Conducted Power (dBm)	Power Limit (dBm)	Pass/Fail
38	5190	59.156	17.72	29.80	Pass
46	5230	115.611	20.63	29.80	Pass
151	5755	183.231	22.63	29.61	Pass
159	5795	218.776	23.40	29.61	Pass

- Note: 1. For U-NII-1: The max. gain is 6.2dBi > 6dBi, so the power limit shall be reduced to $30-(6.2-6) = 29.8\text{dBm}$.
 2. For U-NII-3: The max. gain is 6.39dBi > 6dBi, so the power limit shall be reduced to $30-(6.39-6) = 29.61\text{dBm}$.

802.11ac (VHT80)

Channel	Channel Frequency (MHz)	Maximum Conducted Power (mW)	Maximum Conducted Power (dBm)	Power Limit (dBm)	Pass/Fail
42	5210	57.81	17.62	29.80	Pass
155	5775	125.603	20.99	29.61	Pass

- Note: 1. For U-NII-1: The max. gain is 6.2dBi > 6dBi, so the power limit shall be reduced to $30-(6.2-6) = 29.8\text{dBm}$.
 2. For U-NII-3: The max. gain is 6.39dBi > 6dBi, so the power limit shall be reduced to $30-(6.39-6) = 29.61\text{dBm}$.

802.11ax (HE20)

Channel	Channel Frequency (MHz)	Maximum Conducted Power (mW)	Maximum Conducted Power (dBm)	Power Limit (dBm)	Pass/Fail
36	5180	111.173	20.46	29.80	Pass
40	5200	224.905	23.52	29.80	Pass
48	5240	110.917	20.45	29.80	Pass
149	5745	238.781	23.78	29.61	Pass
157	5785	232.274	23.66	29.61	Pass
165	5825	226.986	23.56	29.61	Pass

- Note: 1. For U-NII-1: The max. gain is 6.2dBi > 6dBi, so the power limit shall be reduced to $30-(6.2-6) = 29.8\text{dBm}$.
 2. For U-NII-3: The max. gain is 6.39dBi > 6dBi, so the power limit shall be reduced to $30-(6.39-6) = 29.61\text{dBm}$.

802.11ax (HE40)

Channel	Channel Frequency (MHz)	Maximum Conducted Power (mW)	Maximum Conducted Power (dBm)	Power Limit (dBm)	Pass/Fail
38	5190	60.534	17.82	29.80	Pass
46	5230	118.304	20.73	29.80	Pass
151	5755	188.799	22.76	29.61	Pass
159	5795	224.905	23.52	29.61	Pass

- Note: 1. For U-NII-1: The max. gain is 6.2dBi > 6dBi, so the power limit shall be reduced to $30-(6.2-6) = 29.8\text{dBm}$.
 2. For U-NII-3: The max. gain is 6.39dBi > 6dBi, so the power limit shall be reduced to $30-(6.39-6) = 29.61\text{dBm}$.

802.11ax (HE80)

Channel	Channel Frequency (MHz)	Maximum Conducted Power (mW)	Maximum Conducted Power (dBm)	Power Limit (dBm)	Pass/Fail
42	5210	60.256	17.80	29.80	Pass
155	5775	128.825	21.10	29.61	Pass

Note: 1. For U-NII-1: The max. gain is 6.2dBi > 6dBi, so the power limit shall be reduced to $30-(6.2-6) = 29.8\text{dBm}$.

2. For U-NII-3: The max. gain is 6.39dBi > 6dBi, so the power limit shall be reduced to $30-(6.39-6) = 29.61\text{dBm}$.

4.4 Occupied Bandwidth Measurement

4.4.1 Test Setup

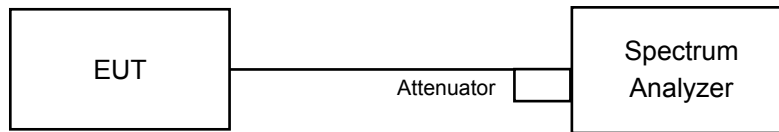

4.4.2 Test Instruments

Refer to section 4.1.2 to get information of above instrument.

4.4.3 Test Procedure

The transmitter output was connected to the spectrum analyzer through an attenuator. The bandwidth of the fundamental frequency was measured by spectrum analyzer with resolution bandwidth in the range of 1% to 5% of the anticipated emission bandwidth, and a video bandwidth at least 3x the resolution bandwidth and set the detector to SAMPLE. The width of a frequency band such that, below the lower and above the upper frequency limits, the mean powers emitted are each equal to a specified percentage 0.5 %of the total mean power of a given emission.

4.4.4 Test Results (Mode 1)

Non-Beamforming Mode

802.11a

Channel	Channel Frequency (MHz)	Occupied Bandwidth (MHz)							
		Chain 0	Chain 1	Chain 2	Chain 3	Chain 4	Chain 5	Chain 6	Chain 7
36	5180	16.80	16.80	16.92	16.92	16.68	16.80	16.92	16.68
40	5200	16.92	16.56	16.80	16.68	16.92	16.68	16.92	16.68
48	5240	16.80	16.80	16.80	16.80	16.80	16.80	16.80	16.80
149	5745	16.68	16.68	16.68	16.56	16.68	16.92	16.68	16.68
157	5785	16.80	16.92	16.80	17.04	16.92	16.68	17.04	16.68
165	5825	16.68	16.80	16.68	16.92	16.80	16.80	16.68	16.68

802.11ax (HE20)

Channel	Channel Frequency (MHz)	Occupied Bandwidth (MHz)							
		Chain 0	Chain 1	Chain 2	Chain 3	Chain 4	Chain 5	Chain 6	Chain 7
36	5180	19.08	18.96	19.08	19.08	19.08	19.08	19.08	18.96
40	5200	18.96	18.96	18.96	18.84	19.08	18.84	19.08	19.08
48	5240	19.08	18.96	18.96	19.08	19.08	18.96	18.96	19.08
149	5745	18.84	19.08	18.96	18.96	18.96	18.84	18.96	18.96
157	5785	19.08	18.84	18.84	18.96	19.08	18.96	19.08	18.96
165	5825	18.96	19.08	18.96	19.08	19.08	19.08	18.96	18.96

802.11ax (HE40)

Channel	Channel Frequency (MHz)	Occupied Bandwidth (MHz)							
		Chain 0	Chain 1	Chain 2	Chain 3	Chain 4	Chain 5	Chain 6	Chain 7
38	5190	38.16	38.16	37.92	36.24	38.16	37.92	38.16	37.92
46	5230	38.16	38.16	38.16	36.48	38.16	38.16	38.16	38.16
151	5755	38.16	37.92	38.16	36.48	37.92	38.16	38.16	38.16
159	5795	38.16	38.16	38.16	36.72	38.16	37.92	38.16	37.92

802.11ax (HE80)

Channel	Channel Frequency (MHz)	Occupied Bandwidth (MHz)							
		Chain 0	Chain 1	Chain 2	Chain 3	Chain 4	Chain 5	Chain 6	Chain 7
42	5210	77.28	77.28	77.28	77.28	77.28	77.28	77.28	77.28
155	5775	77.28	77.28	77.28	77.28	77.28	77.28	77.28	77.76

802.11ax (HE80+80)

Channel	Channel Frequency (MHz)	Occupied Bandwidth (MHz)							
		Chain 0	Chain 1	Chain 2	Chain 3	Chain 4	Chain 5	Chain 6	Chain 7
42+155	5210	77.28	77.28	77.28	77.28	-	-	-	-
	5775	-	-	-	-	76.80	77.76	77.28	77.28

Spectrum Plot of Max. Value

802.11a_Chain 6 / CH157

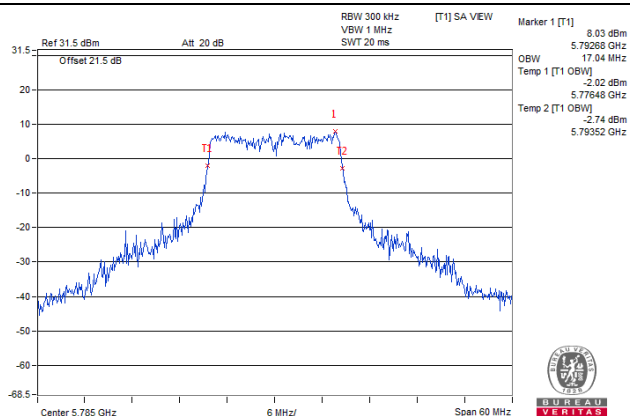

802.11ax (HE20)_Chain 0 / CH36

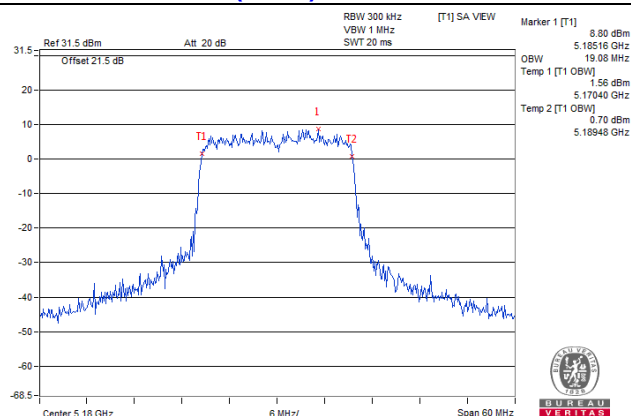

802.11ax (HE40)_Chain 0 / CH38

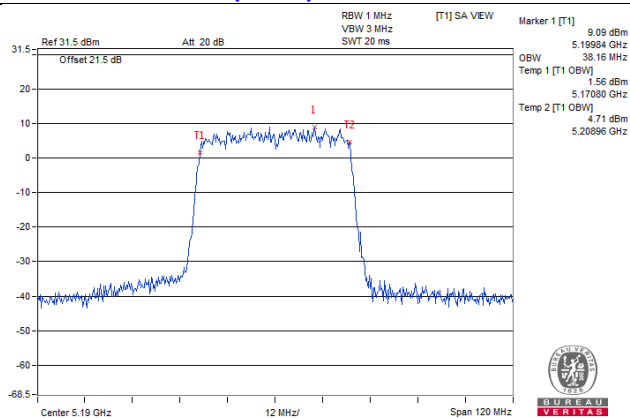

802.11ax (HE80)_Chain 7 / CH155

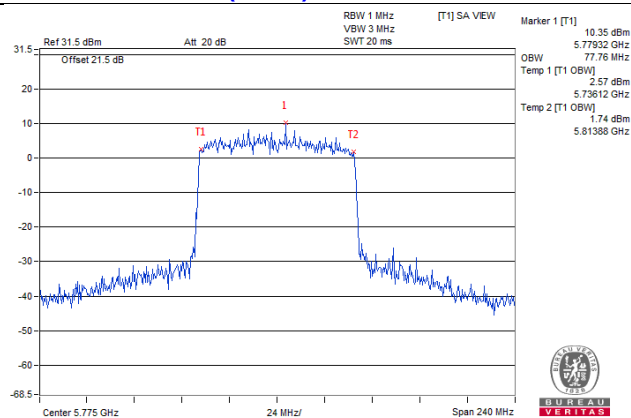

802.11ax (HE80+80)_Chain 5 / CH155

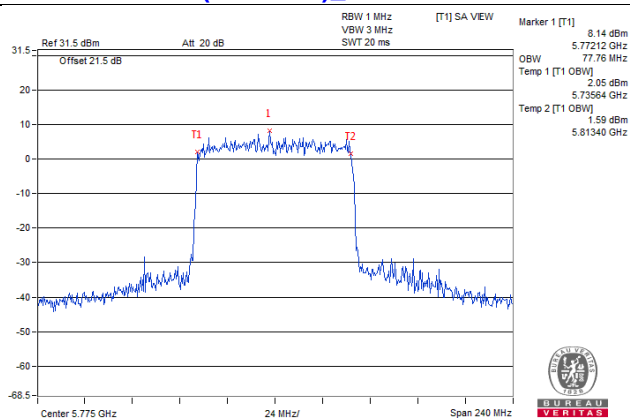

Spectrum Plot for near by DFS band
(DFS is required, if 99% OCP straddle into U-NII-2A band)

802.11a_Chain 0 / CH48

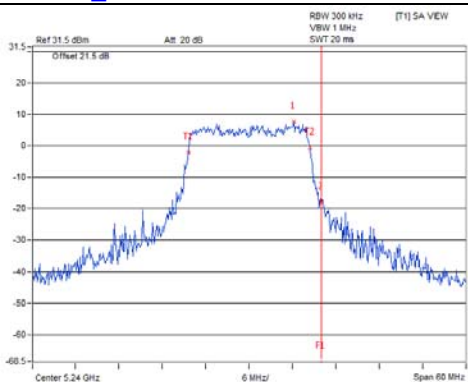

802.11a_Chain 1 / CH48

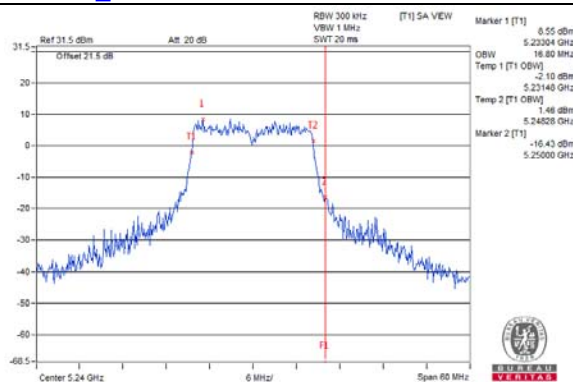

802.11a_Chain 2 / CH48

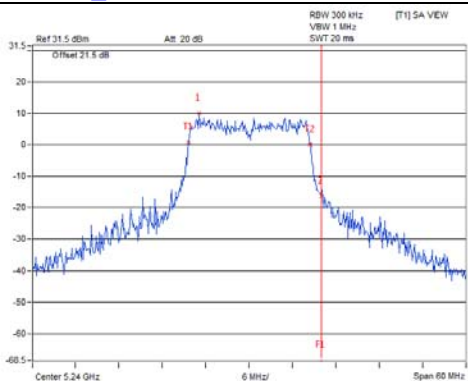

802.11a_Chain 3 / CH48

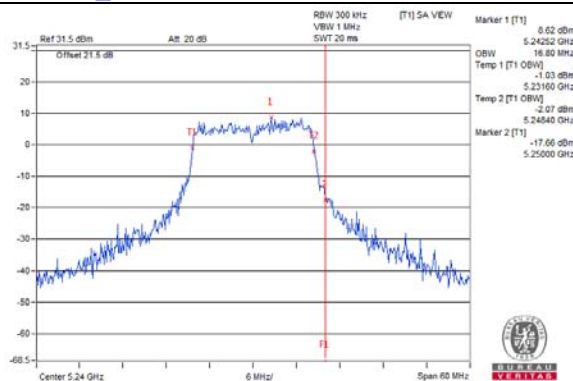

802.11a_Chain 4 / CH48

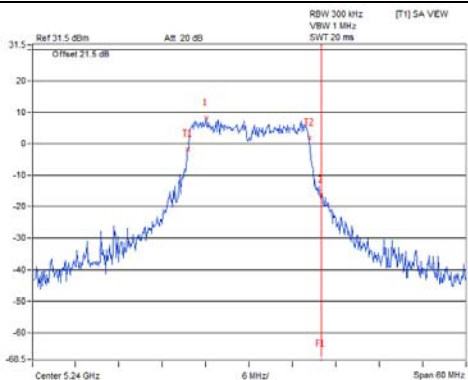

802.11a_Chain 5 / CH48

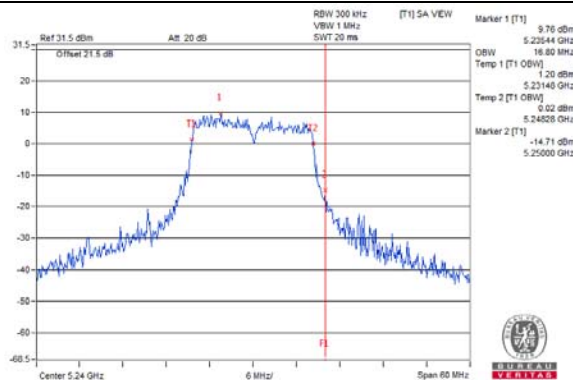

802.11a_Chain 6 / CH48

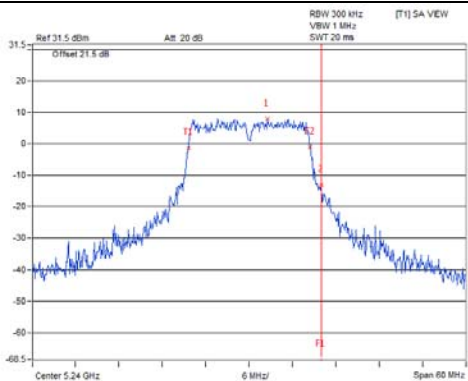

802.11a_Chain 7 / CH48

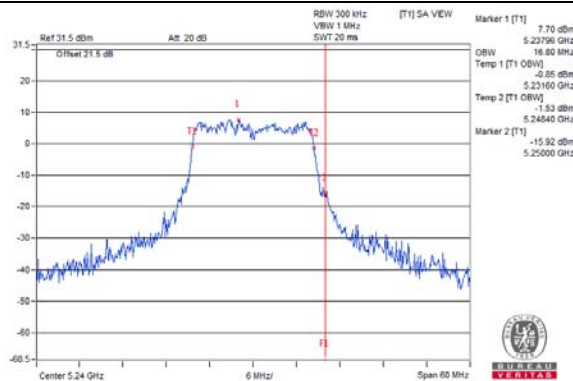

Spectrum Plot for near by DFS band
(DFS is required, if 99% OCP straddle into U-NII-2A band)

802.11ax (HE20) Chain 0 / CH48

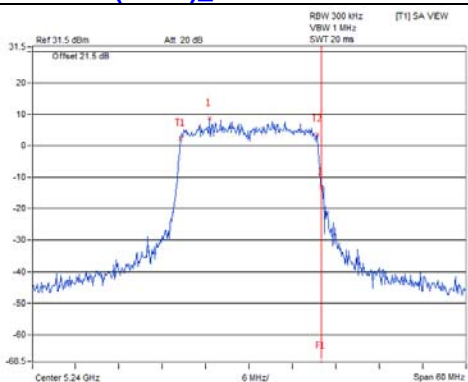

802.11ax (HE20) Chain 1 / CH48

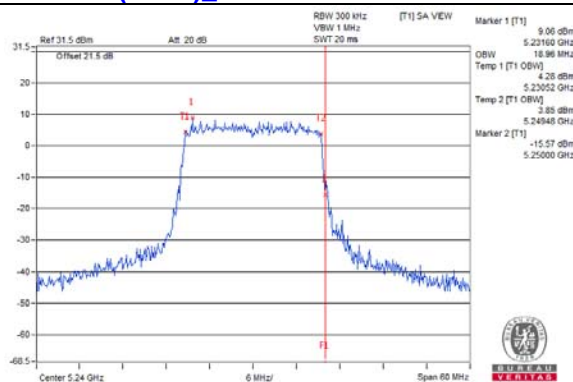

802.11ax (HE20) Chain 2 / CH48

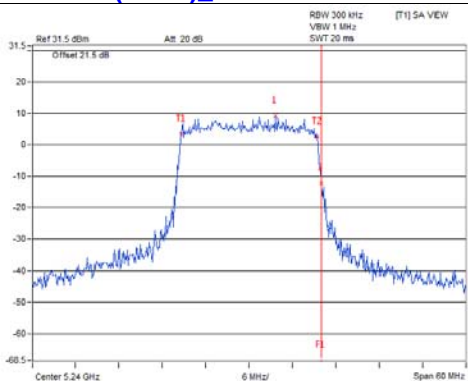

802.11ax (HE20) Chain 3 / CH48

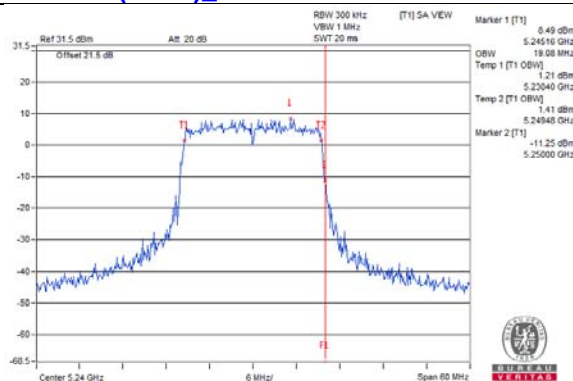

802.11ax (HE20) Chain 4 / CH48

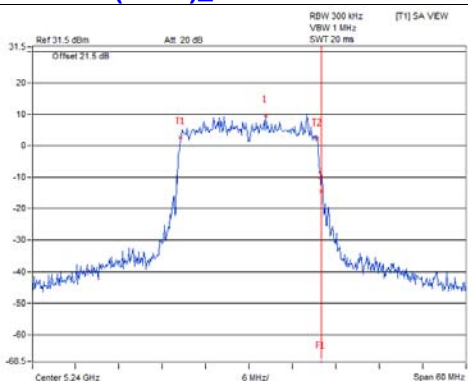

802.11ax (HE20) Chain 5 / CH48

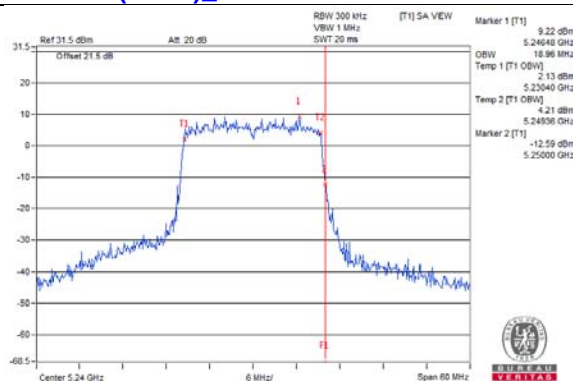

802.11ax (HE20) Chain 6 / CH48

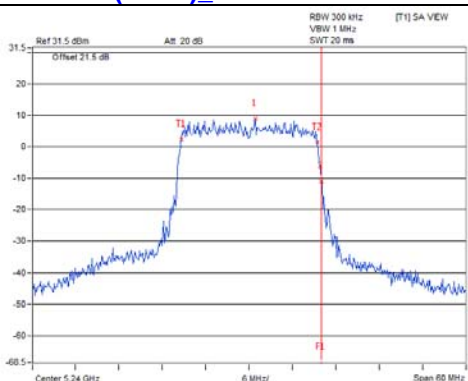

802.11ax (HE20) Chain 7 / CH48

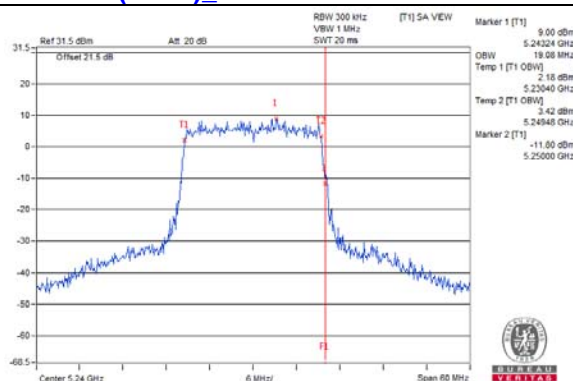

**Spectrum Plot for near by DFS band
(DFS is required, if 99% OCP straddle into U-NII-2A band)**

802.11ax (HE40) Chain 0 / CH46

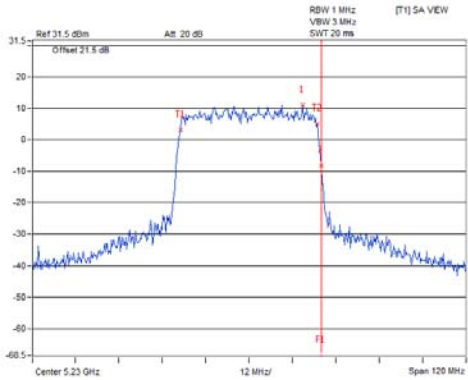

802.11ax (HE40) Chain 1 / CH46

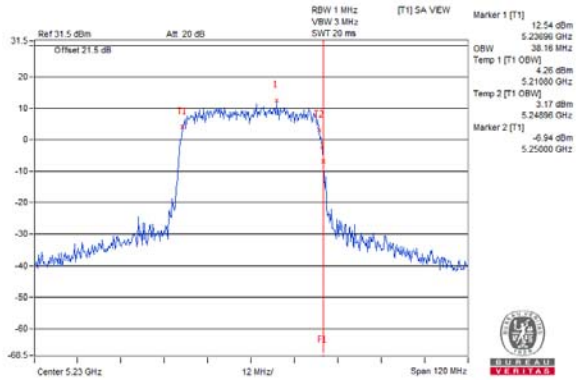

802.11ax (HE40) Chain 2 / CH46

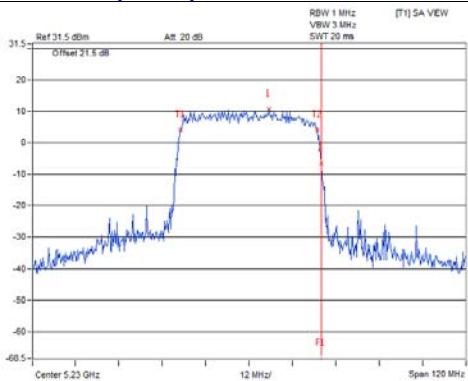

802.11ax (HE40) Chain 3 / CH46

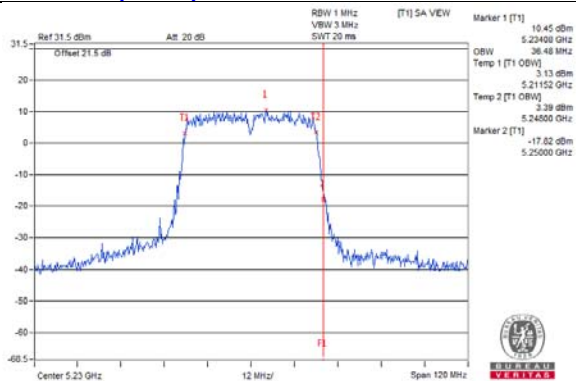

802.11ax (HE40) Chain 4 / CH46

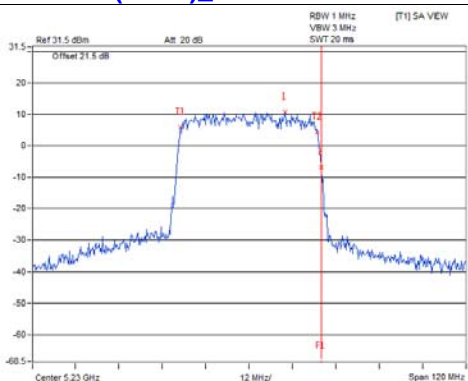

802.11ax (HE40) Chain 5 / CH46

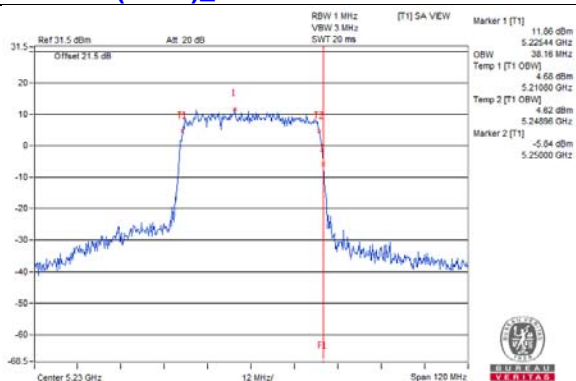

802.11ax (HE40) Chain 6 / CH46

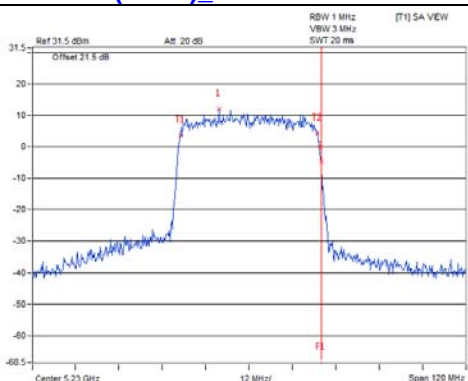

802.11ax (HE40) Chain 7 / CH46

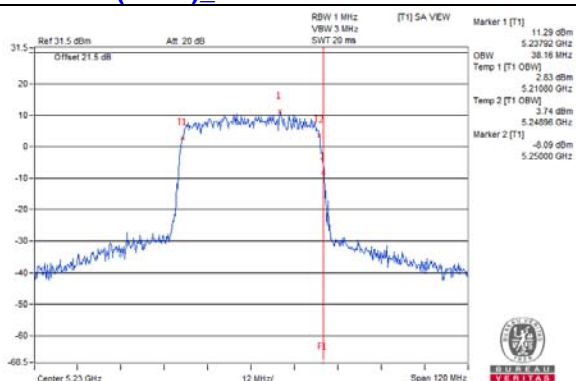

**Spectrum Plot for near by DFS band
(DFS is required, if 99% OCP straddle into U-NII-2A band)**

802.11ax (HE80) Chain 0 / CH42

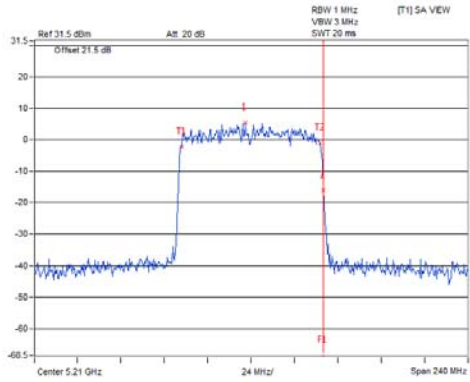

802.11ax (HE80) Chain 1 / CH42

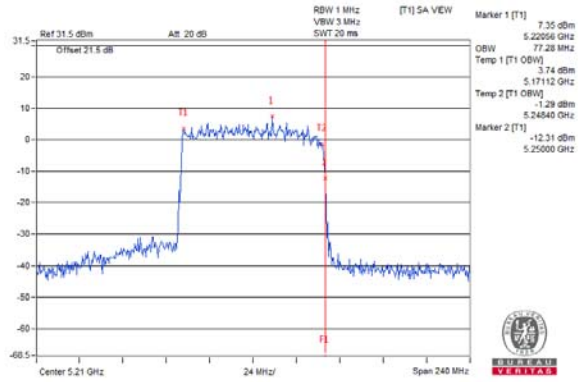

802.11ax (HE80) Chain 2 / CH42

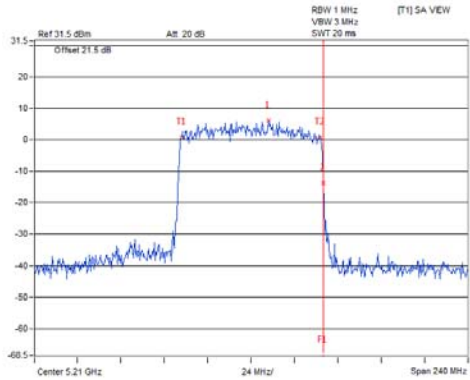

802.11ax (HE80) Chain 3 / CH42

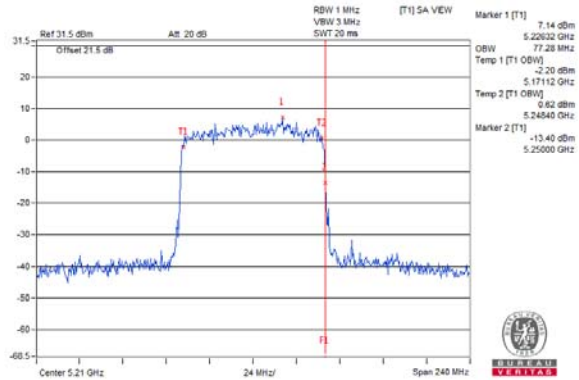

802.11ax (HE80) Chain 4 / CH42

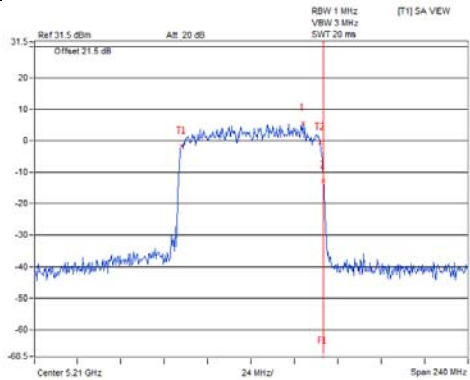

802.11ax (HE80) Chain 5 / CH42

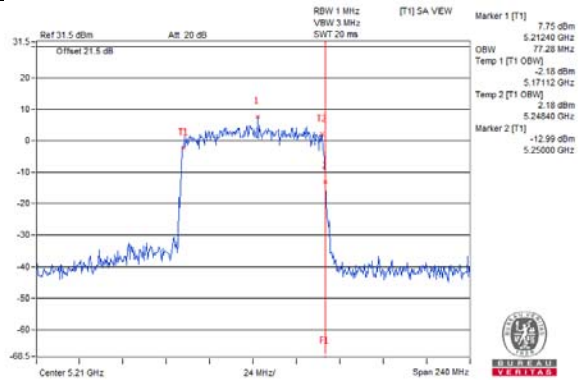

802.11ax (HE80) Chain 6 / CH42

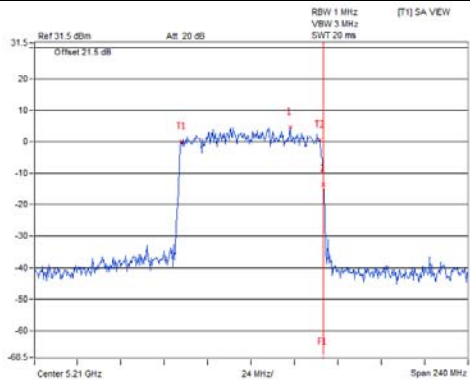

802.11ax (HE80) Chain 7 / CH42

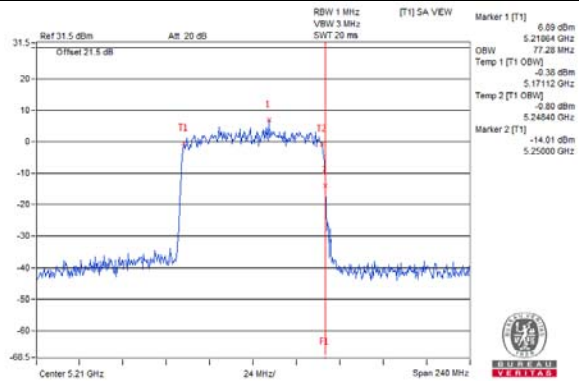

**Spectrum Plot for near by DFS band
(DFS is required, if 99% OCP straddle into U-NII-2A band)**

802.11ax (HE80+80) / Chain 0 : CH42

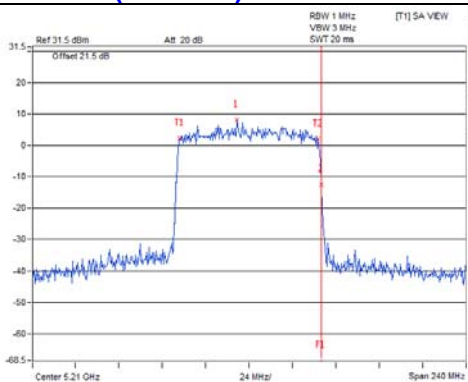

802.11ax (HE80+80) / Chain 1 : CH42

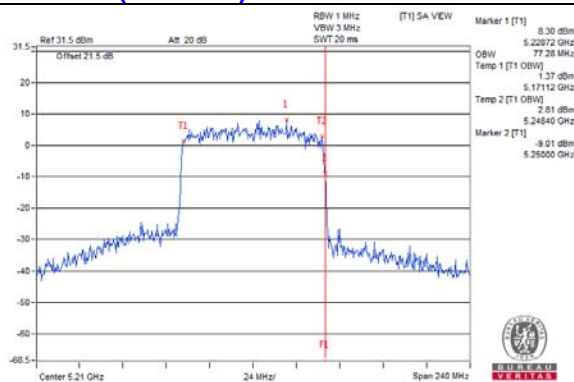

802.11ax (HE80+80) / Chain 2 : CH42

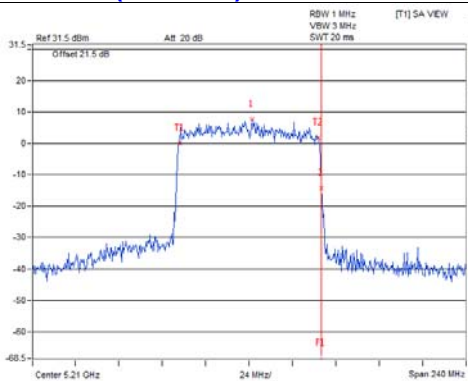

802.11ax (HE80+80) / Chain 3 : CH42

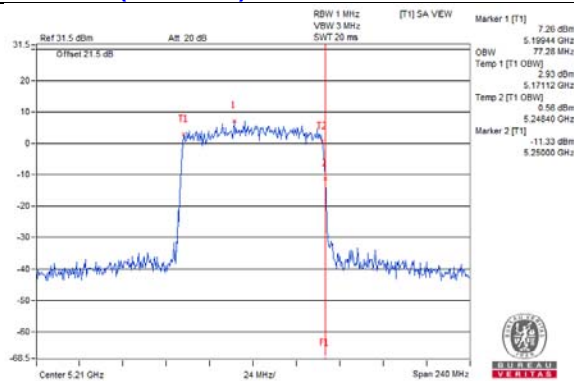

Spectrum Plot for near by DFS band
(DFS is required, if 99% OCP straddle into U-NII-2C band)

802.11a_Chain 0 / CH149

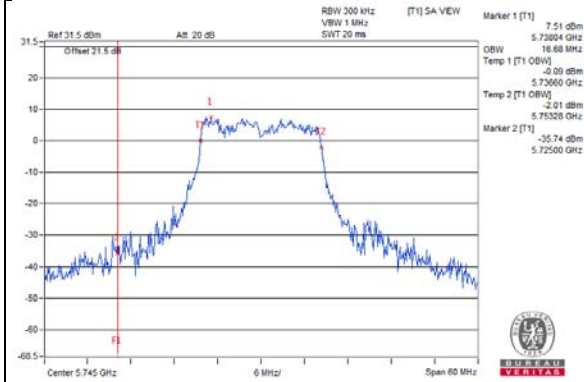

802.11a_Chain 1 / CH149

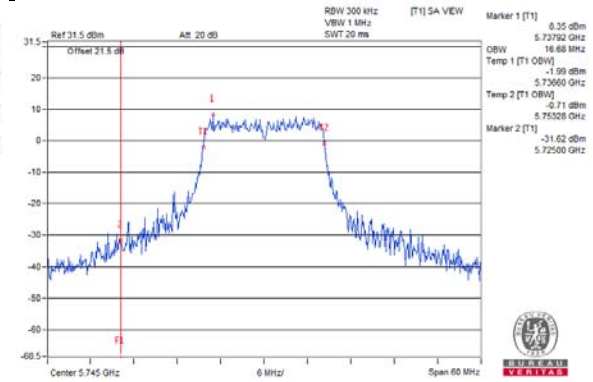

802.11a_Chain 2 / CH149

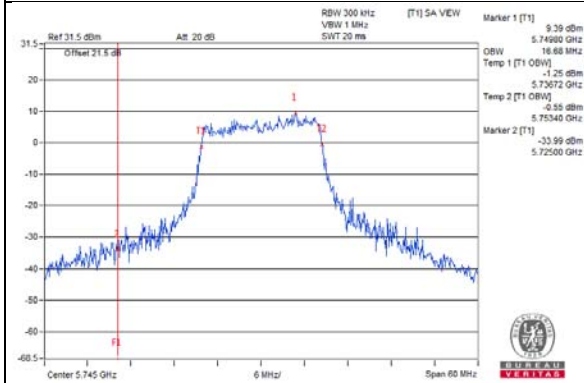

802.11a_Chain 3 / CH149

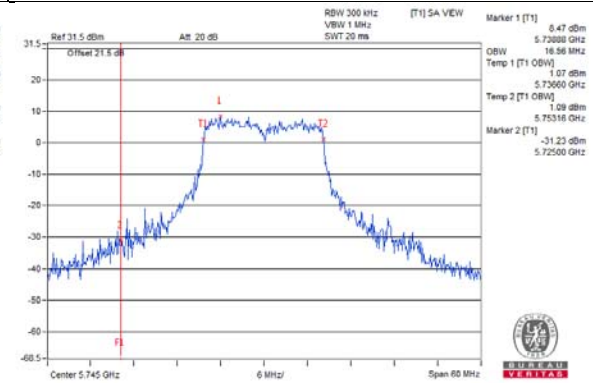

802.11a_Chain 4 / CH149

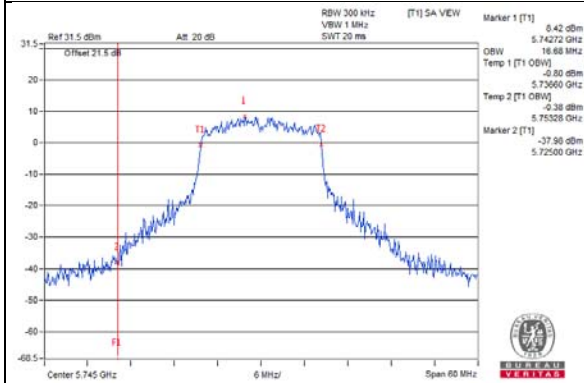

802.11a_Chain 5 / CH149

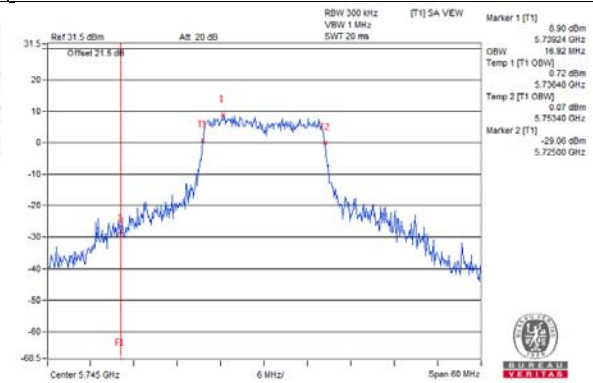

802.11a_Chain 6 / CH149

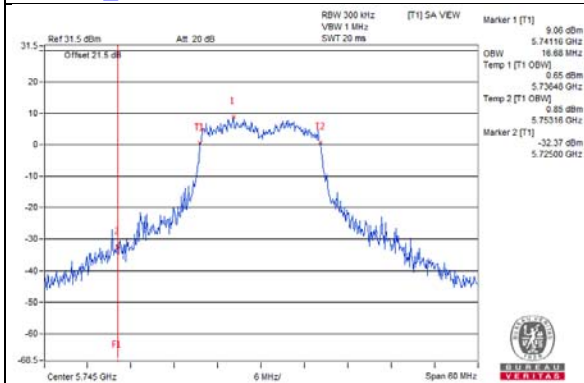

802.11a_Chain 7 / CH149

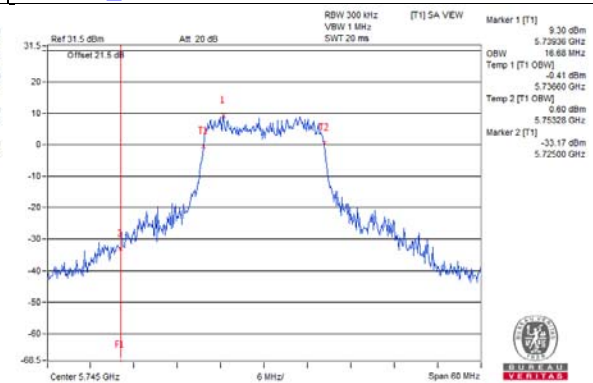

Spectrum Plot for near by DFS band
(DFS is required, if 99% OCP straddle into U-NII-2C band)

802.11ax (HE20) Chain 0 / CH149

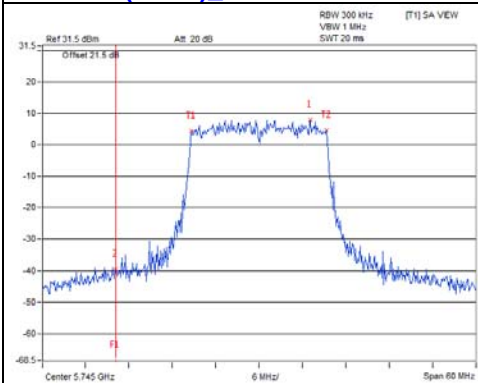

RBW 300 kHz
VBW 1 MHz
SWT 20 ms
[F1] SA VIEW
Marker 1 [F1] 7.82 dBm
5.75200 GHz
OBW 18.84 MHz
Temp 1 [F1] OBW] 4.20 dBm
5.73552 GHz
Temp 2 [F1] OBW] 4.72 dBm
5.75436 GHz
Marker 2 [F1] -39.63 dBm
5.72500 GHz

802.11ax (HE20) Chain 1 / CH149

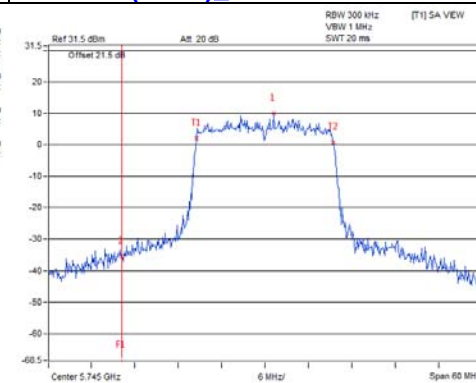

RBW 300 kHz
VBW 1 MHz
SWT 20 ms
[F1] SA VIEW
Marker 1 [F1] 10.10 dBm
5.74620 GHz
OBW 19.08 MHz
Temp 1 [F1] OBW] 2.21 dBm
5.73540 GHz
Temp 2 [F1] OBW] 0.68 dBm
5.75448 GHz
Marker 2 [F1] -35.59 dBm
5.72500 GHz

802.11ax (HE20) Chain 2 / CH149

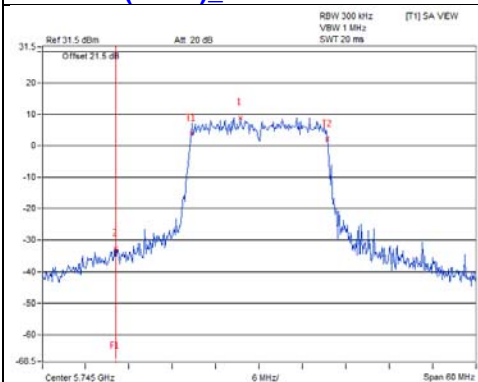

RBW 300 kHz
VBW 1 MHz
SWT 20 ms
[F1] SA VIEW
Marker 1 [F1] 9.00 dBm
5.74220 GHz
OBW 16.96 MHz
Temp 1 [F1] OBW] 3.25 dBm
5.73552 GHz
Temp 2 [F1] OBW] 2.17 dBm
5.75448 GHz
Marker 2 [F1] -32.60 dBm
5.72500 GHz

802.11ax (HE20) Chain 3 / CH149

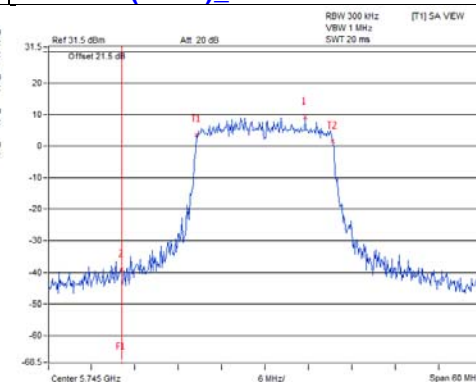

RBW 300 kHz
VBW 1 MHz
SWT 20 ms
[F1] SA VIEW
Marker 1 [F1] 9.30 dBm
5.75052 GHz
OBW 16.96 MHz
Temp 1 [F1] OBW] 3.74 dBm
5.73540 GHz
Temp 2 [F1] OBW] 1.64 dBm
5.75436 GHz
Marker 2 [F1] -39.12 dBm
5.72500 GHz

802.11ax (HE20) Chain 4 / CH149

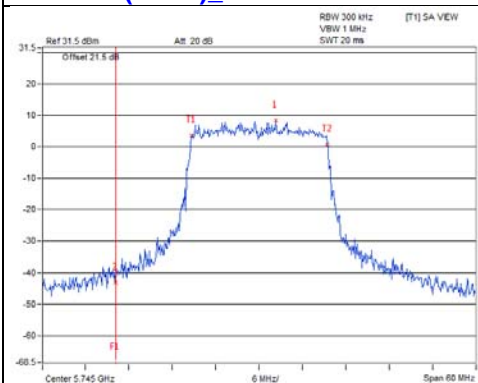

RBW 300 kHz
VBW 1 MHz
SWT 20 ms
[F1] SA VIEW
Marker 1 [F1] 6.49 dBm
5.74720 GHz
OBW 16.96 MHz
Temp 1 [F1] OBW] 3.70 dBm
5.73552 GHz
Temp 2 [F1] OBW] 0.86 dBm
5.75448 GHz
Marker 2 [F1] -43.06 dBm
5.72500 GHz

802.11ax (HE20) Chain 5 / CH149

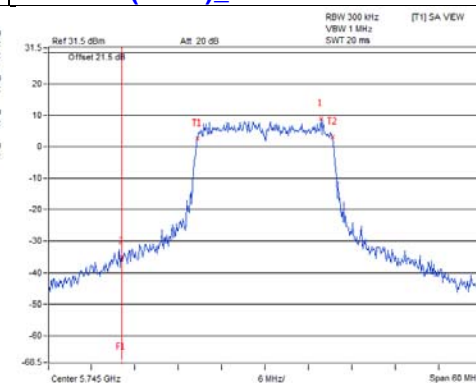

RBW 300 kHz
VBW 1 MHz
SWT 20 ms
[F1] SA VIEW
Marker 1 [F1] 6.90 dBm
5.75280 GHz
OBW 16.84 MHz
Temp 1 [F1] OBW] 2.64 dBm
5.73552 GHz
Temp 2 [F1] OBW] 2.03 dBm
5.75436 GHz
Marker 2 [F1] -34.91 dBm
5.72500 GHz

802.11ax (HE20) Chain 6 / CH149

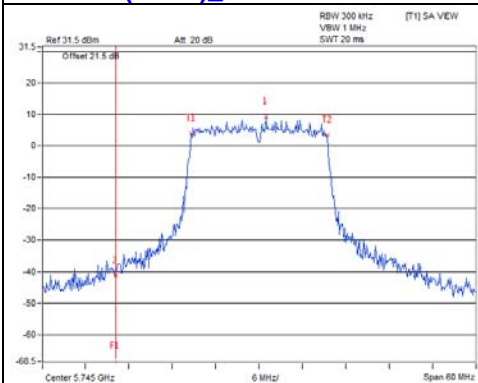

RBW 300 kHz
VBW 1 MHz
SWT 20 ms
[F1] SA VIEW
Marker 1 [F1] 9.14 dBm
5.74560 GHz
OBW 18.96 MHz
Temp 1 [F1] OBW] 3.94 dBm
5.73552 GHz
Temp 2 [F1] OBW] 3.27 dBm
5.75448 GHz
Marker 2 [F1] -41.27 dBm
5.72500 GHz

802.11ax (HE20) Chain 7 / CH149

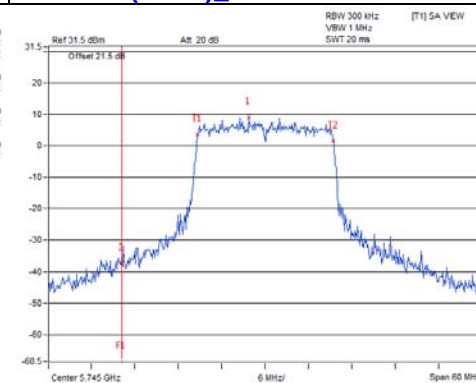

RBW 300 kHz
VBW 1 MHz
SWT 20 ms
[F1] SA VIEW
Marker 1 [F1] 9.33 dBm
5.74272 GHz
OBW 18.96 MHz
Temp 1 [F1] OBW] 3.91 dBm
5.73552 GHz
Temp 2 [F1] OBW] 1.84 dBm
5.75448 GHz
Marker 2 [F1] -37.31 dBm
5.72500 GHz

**Spectrum Plot for near by DFS band
(DFS is required, if 99% OCP straddle into U-NII-2C band)**

802.11ax (HE40) Chain 0 / CH151

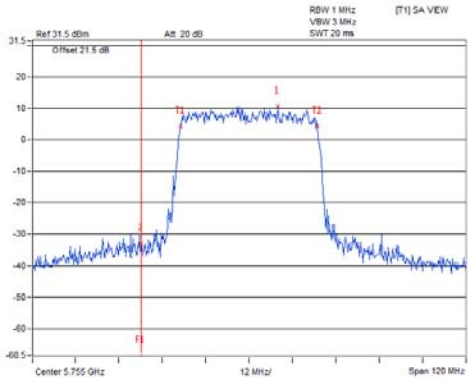

802.11ax (HE40) Chain 1 / CH151

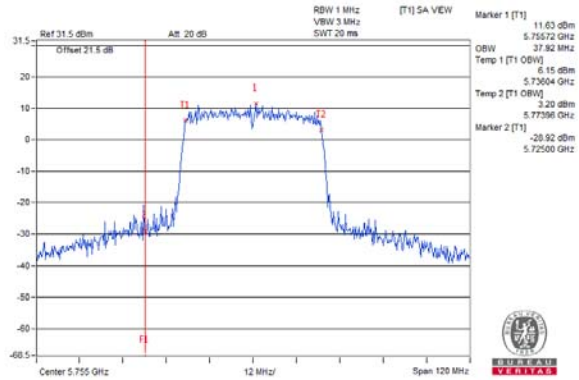

802.11ax (HE40) Chain 2 / CH151

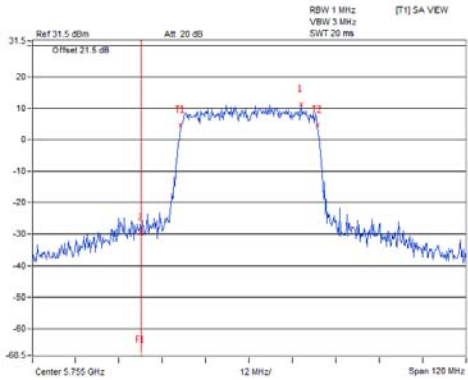

802.11ax (HE40) Chain 3 / CH151

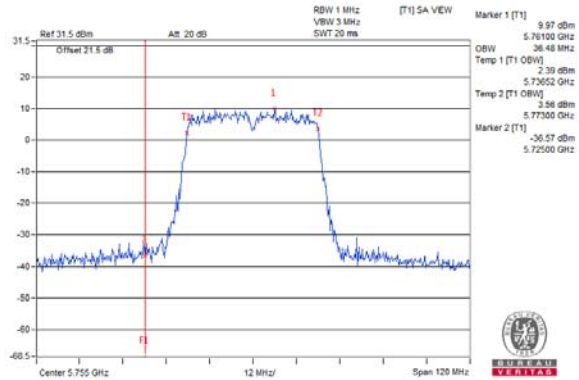

802.11ax (HE40) Chain 4 / CH151

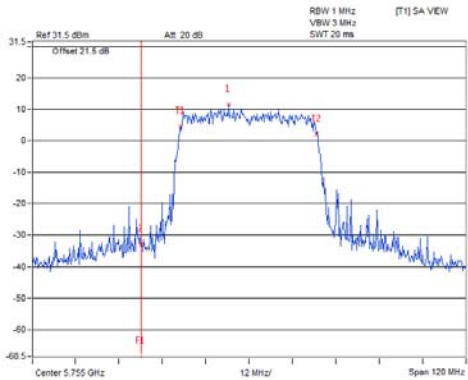

802.11ax (HE40) Chain 5 / CH151

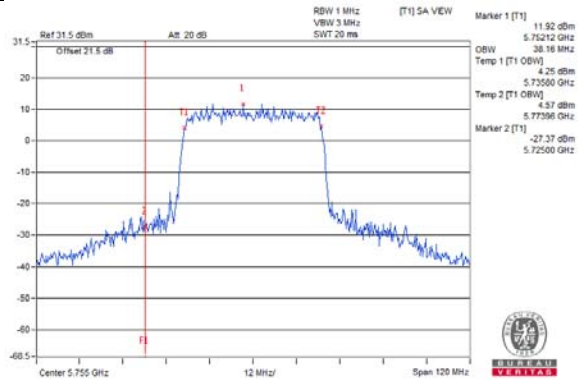

802.11ax (HE40) Chain 6 / CH151

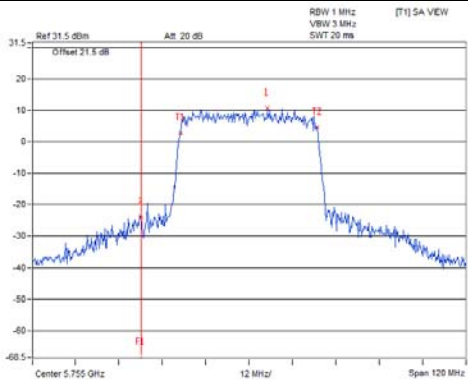

802.11ax (HE40) Chain 7 / CH151

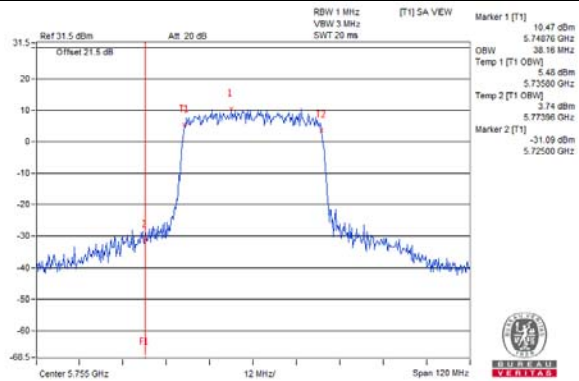

**Spectrum Plot for near by DFS band
(DFS is required, if 99% OCP straddle into U-NII-2C band)**

802.11ax (HE80)_Chain 0 / CH155

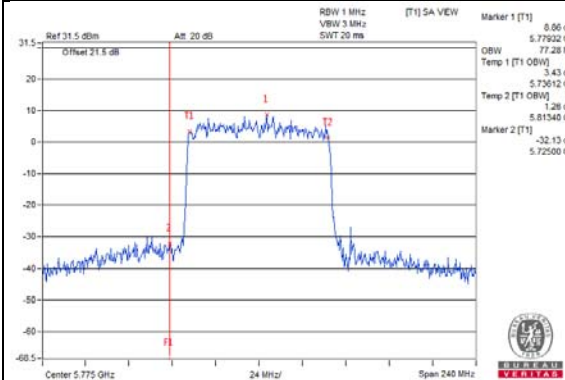

802.11ax (HE80)_Chain 1 / CH155

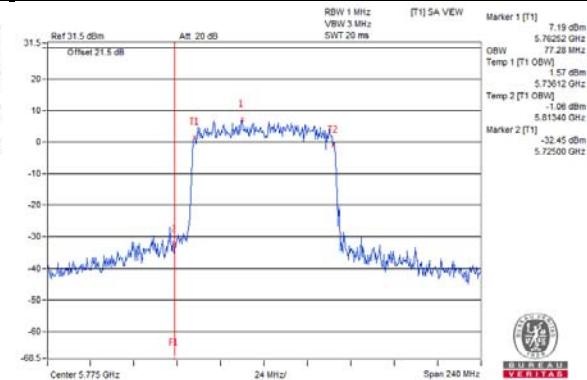

802.11ax (HE80)_Chain 2 / CH155

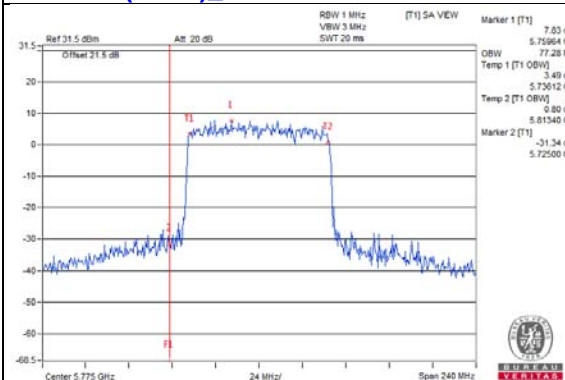

802.11ax (HE80)_Chain 3 / CH155

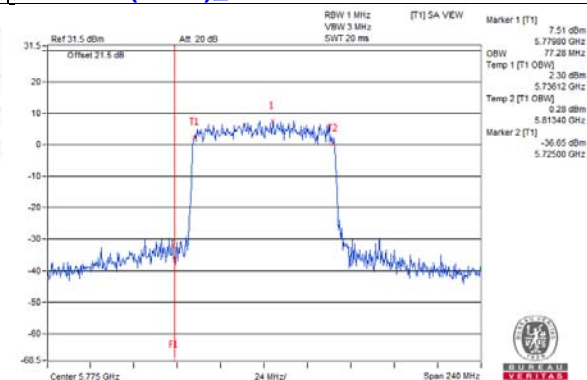

802.11ax (HE80)_Chain 4 / CH155

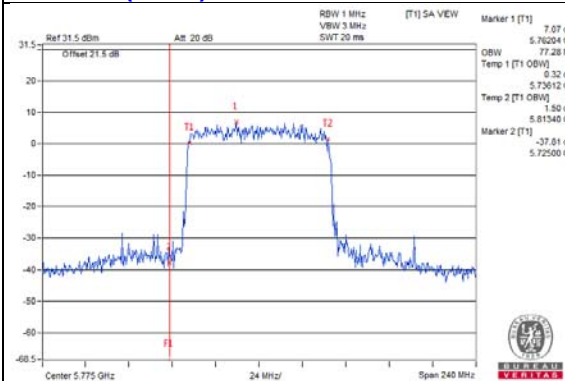

802.11ax (HE80)_Chain 5 / CH155

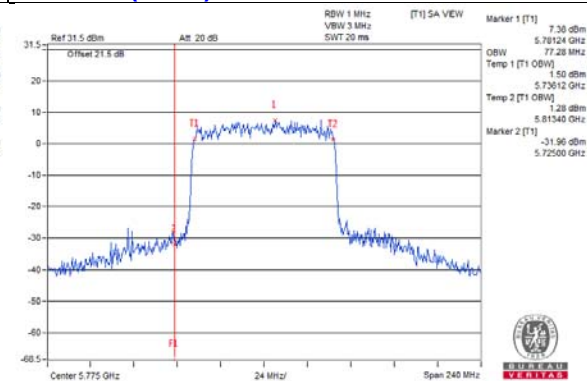

802.11ax (HE80)_Chain 6 / CH155

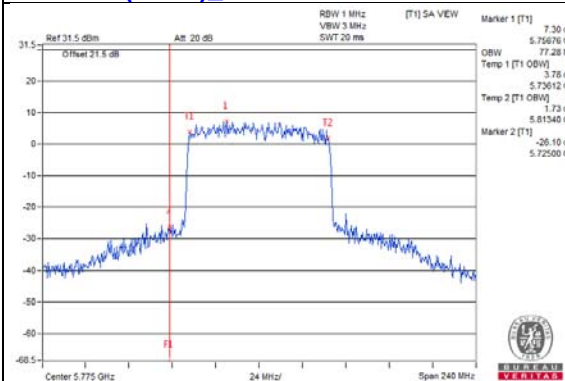

802.11ax (HE80)_Chain 7 / CH155

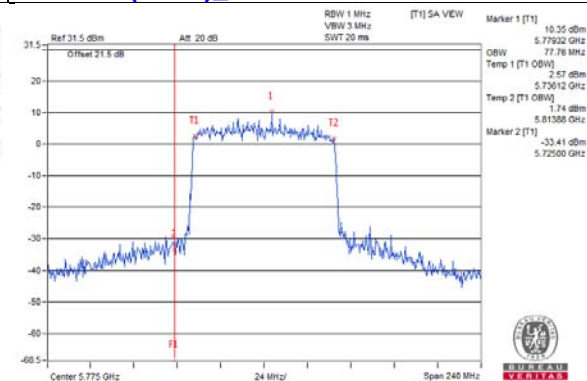

**Spectrum Plot for near by DFS band
(DFS is required, if 99% OCP straddle into U-NII-2C band)**

802.11ax (HE80+80) / Chain 4 : CH155

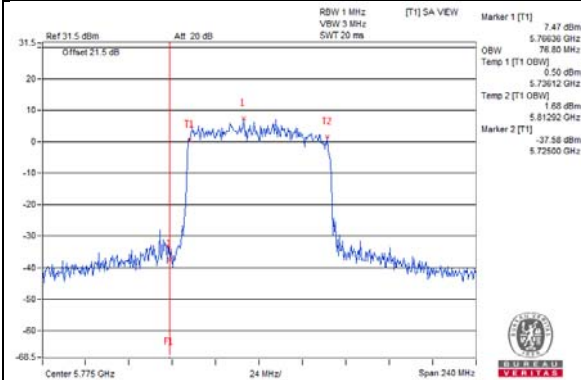

802.11ax (HE80+80) / Chain 5 : CH155

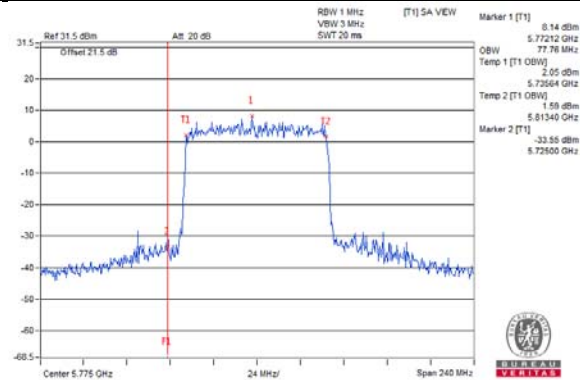

802.11ax (HE80+80) / Chain 6 : CH155

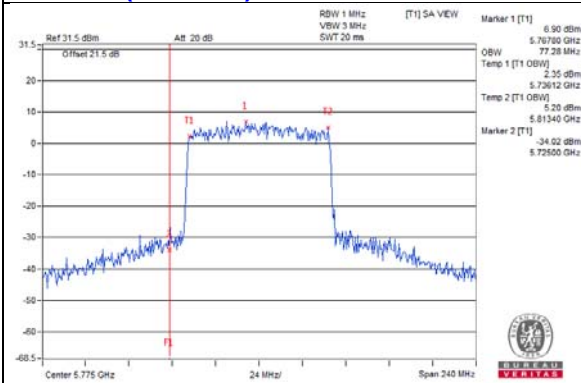

802.11ax (HE80+80) / Chain 7 : CH155

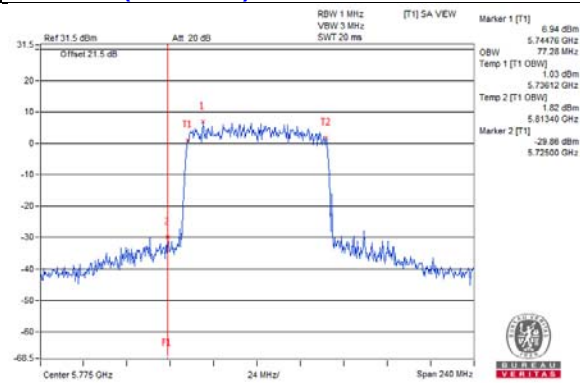

4.4.5 Test Results (Mode 2)

Non-Beamforming Mode

802.11a

Channel	Channel Frequency (MHz)	Occupied Bandwidth (MHz)			
		Chain 4	Chain 5	Chain 6	Chain 7
36	5180	16.92	16.80	17.28	16.92
40	5200	16.92	16.80	17.04	16.80
48	5240	16.68	16.92	16.92	16.92
149	5745	31.68	33.28	35.68	34.40
157	5785	32.16	32.32	34.08	35.04
165	5825	30.72	30.56	34.40	32.64

802.11ax (HE20)

Channel	Channel Frequency (MHz)	Occupied Bandwidth (MHz)			
		Chain 4	Chain 5	Chain 6	Chain 7
36	5180	19.08	18.96	19.08	18.96
40	5200	19.08	19.08	19.08	19.08
48	5240	18.96	19.08	19.08	18.96
149	5745	30.24	33.76	37.12	36.48
157	5785	31.04	30.24	36.00	33.44
165	5825	30.24	23.88	33.60	31.52

802.11ax (HE40)

Channel	Channel Frequency (MHz)	Occupied Bandwidth (MHz)			
		Chain 4	Chain 5	Chain 6	Chain 7
38	5190	37.92	38.16	38.16	38.16
46	5230	38.16	38.16	38.64	38.16
151	5755	40.32	43.92	47.04	48.48
159	5795	45.12	40.56	42.72	53.28

802.11ax (HE80)

Channel	Channel Frequency (MHz)	Occupied Bandwidth (MHz)			
		Chain 4	Chain 5	Chain 6	Chain 7
42	5210	77.28	77.28	77.28	77.28
155	5775	77.76	77.76	78.24	78.24

802.11ax (HE80+80)

Channel	Channel Frequency (MHz)	Occupied Bandwidth (MHz)			
		Chain 4	Chain 5	Chain 6	Chain 7
42+155	5210	77.28	77.28	-	-
	5775	-	-	76.80	77.28

Spectrum Plot of Max. Value

802.11a_Chain 6 / CH149

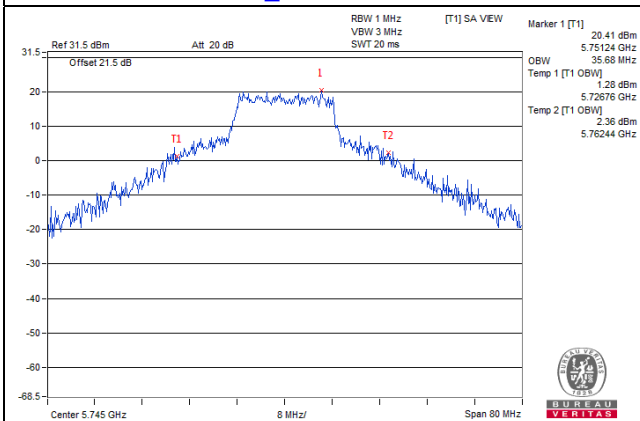

802.11ax (HE20)_Chain 6 / CH149

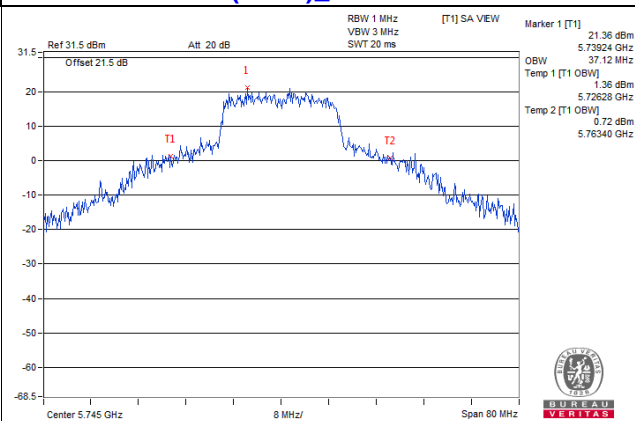

802.11ax (HE40)_Chain 7 / CH159

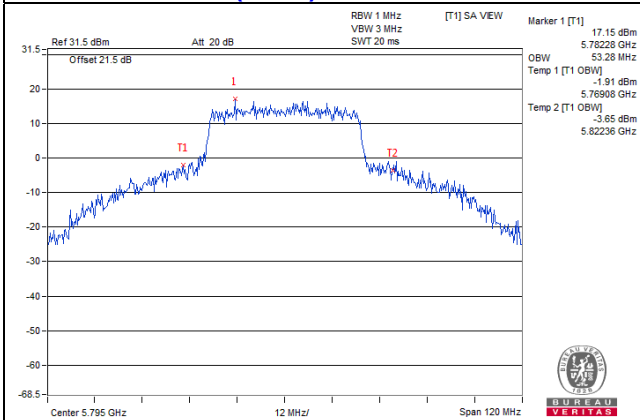

802.11ax (HE80)_Chain 7 / CH155

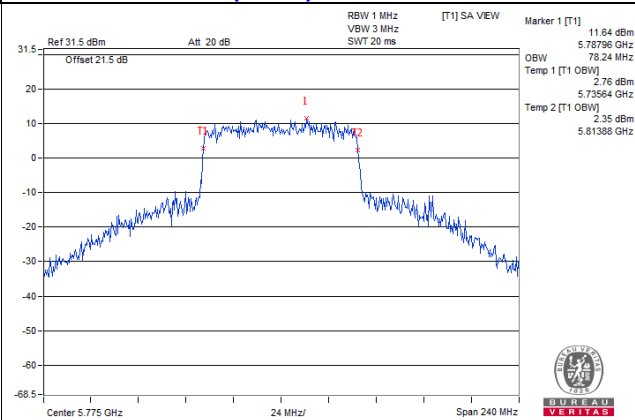

802.11ax (HE80+80)_Chain 4 / CH42

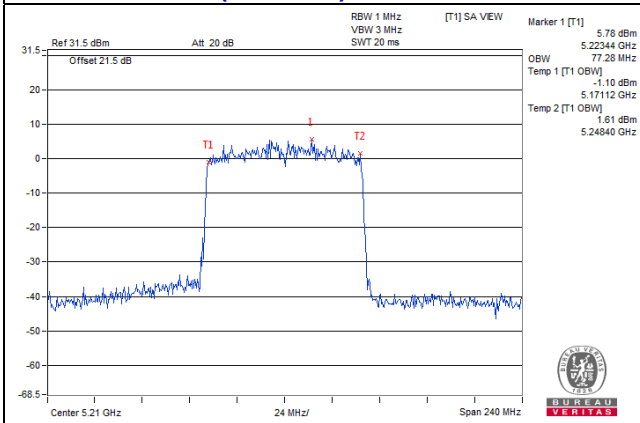

**Spectrum Plot for near by DFS band
(DFS is required, if 99% OCP straddle into U-NII-2A band)**

802.11a_Chain 4 / CH48

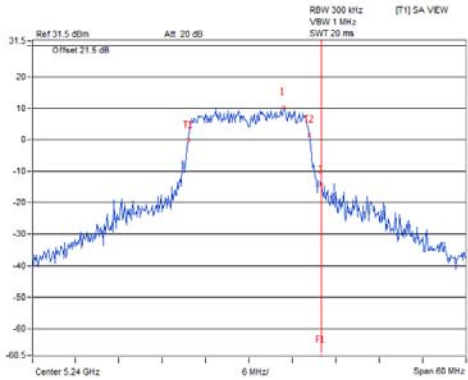

802.11a_Chain 5 / CH48

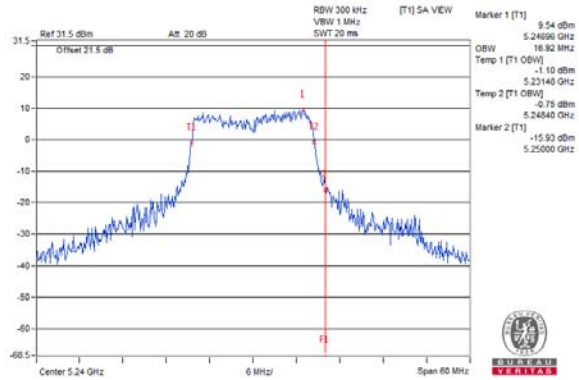

802.11a_Chain 6 / CH48

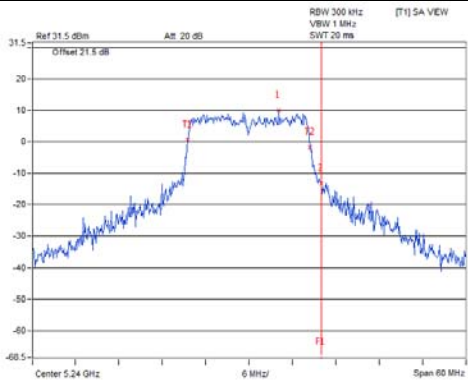

802.11a_Chain 7 / CH48

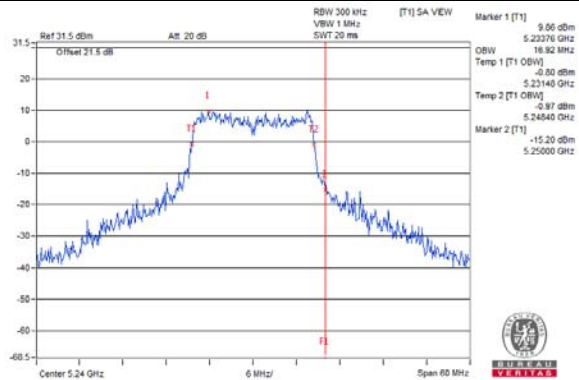

802.11ax (VHT20)_Chain 4 / CH48

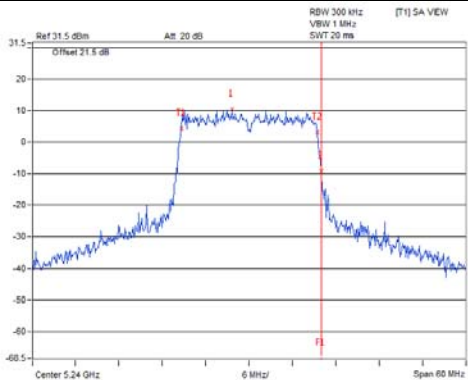

802.11ax (VHT20)_Chain 5 / CH48

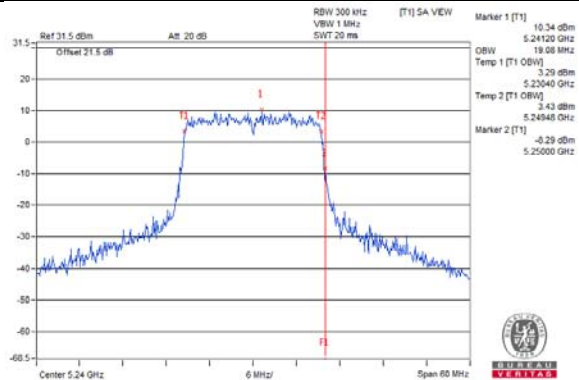

802.11ax (VHT20)_Chain 6 / CH48

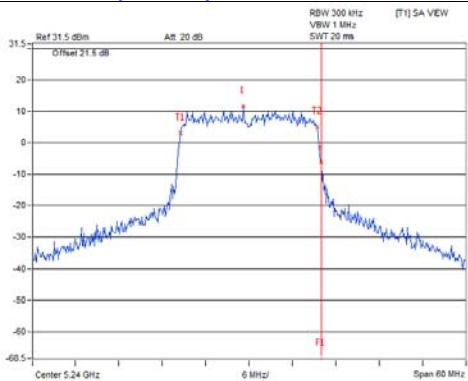

802.11ax (VHT20)_Chain 7 / CH48

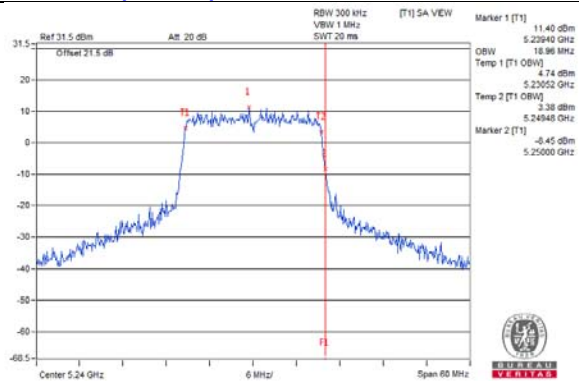

**Spectrum Plot for near by DFS band
(DFS is required, if 99% OCP straddle into U-NII-2A band)**

802.11ax (VHT40) Chain 4 / CH46

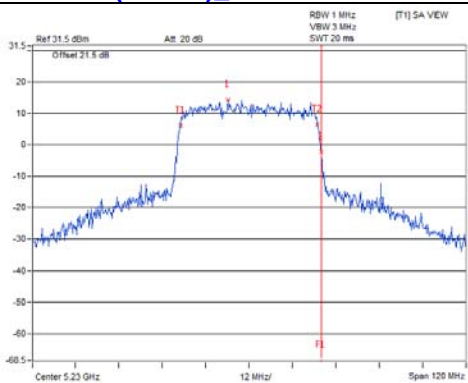

802.11ax (VHT40) Chain 5 / CH46

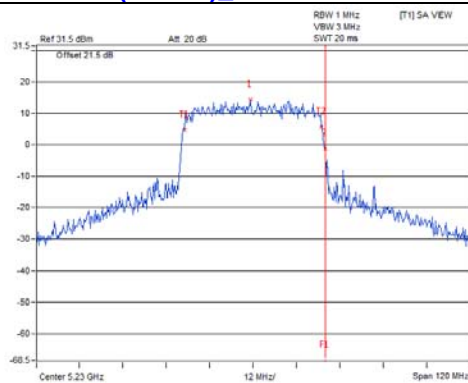

802.11ax (VHT40) Chain 6 / CH46

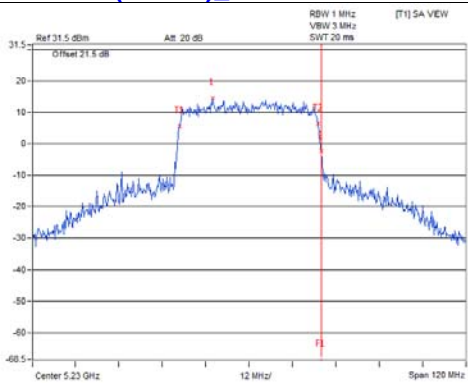

802.11ax (VHT40) Chain 7 / CH46

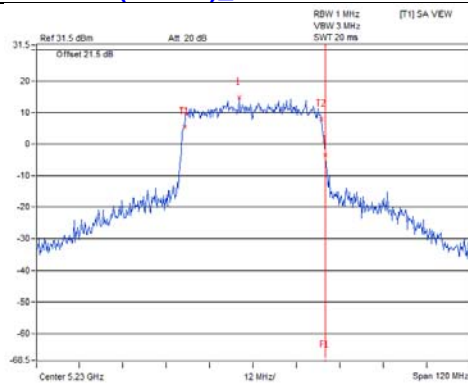

802.11ax (VHT80) Chain 4 / CH42

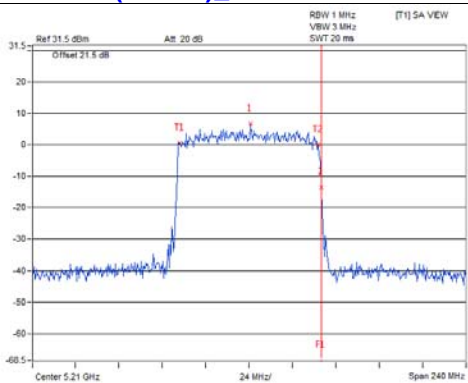

802.11ax (VHT80) Chain 5 / CH42

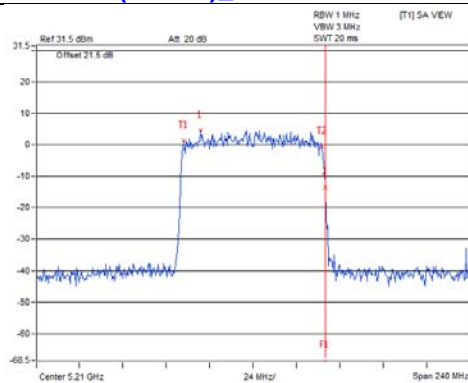

802.11ax (VHT80) Chain 6 / CH42

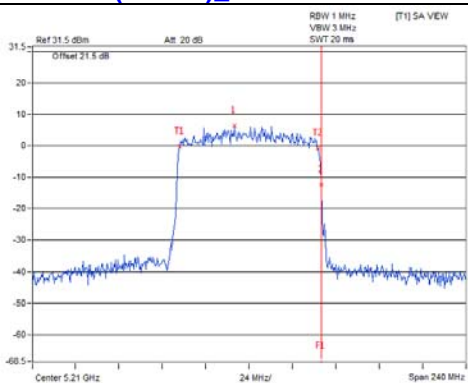

802.11ax (VHT80) Chain 7 / CH42

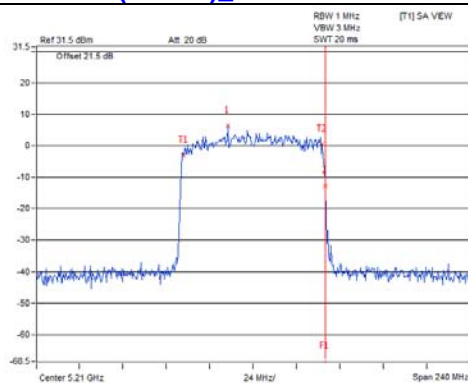

Spectrum Plot for near by DFS band
(DFS is required, if 99% OCP straddle into U-NII-2A band)

802.11ax (HE80+80) / Chain 4 : CH42

802.11ax (HE80+80) / Chain 5 : CH42

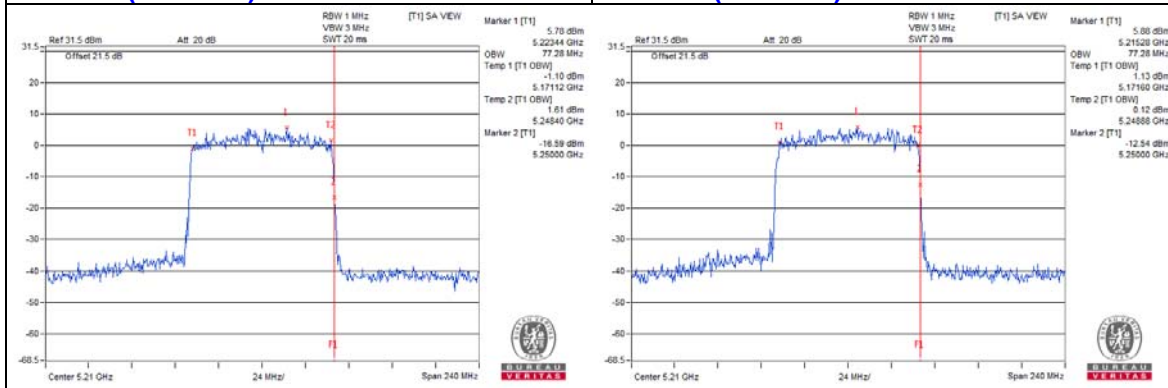

Spectrum Plot for near by DFS band
(DFS is required, if 99% OCP straddle into U-NII-2C band)

802.11a_Chain 4 / CH149

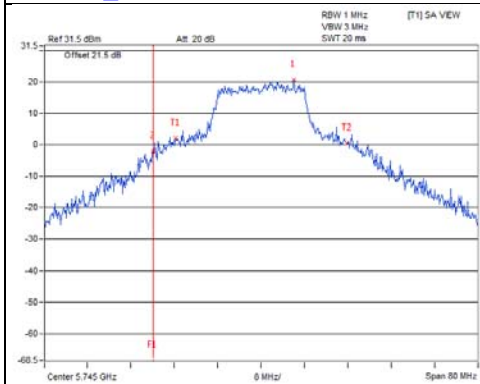

802.11a_Chain 5 / CH149

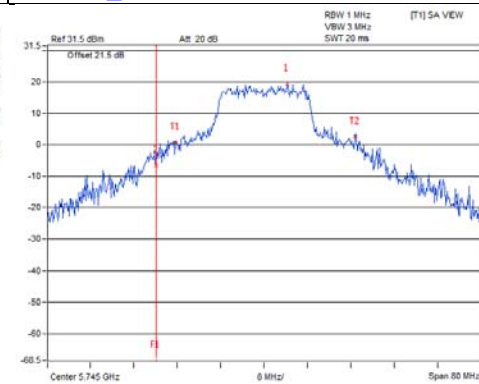

802.11a_Chain 6 / CH149

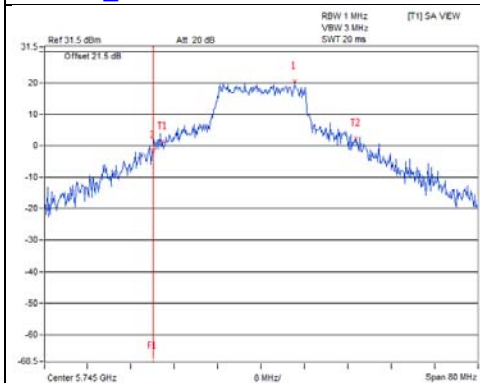

802.11a_Chain 7 / CH149

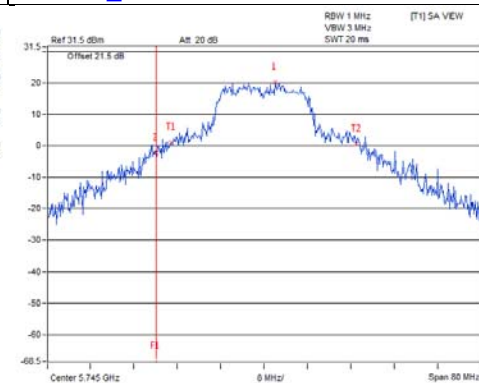

802.11ax (VHT20)_Chain 4 / CH149

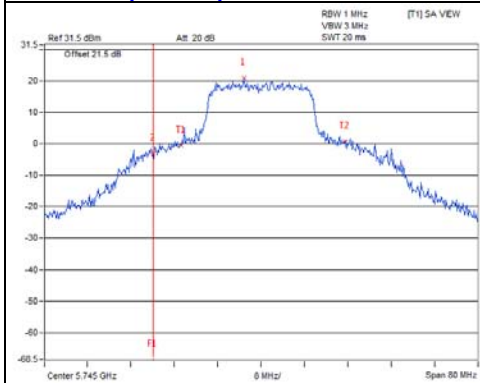

802.11ax (VHT20)_Chain 5 / CH149

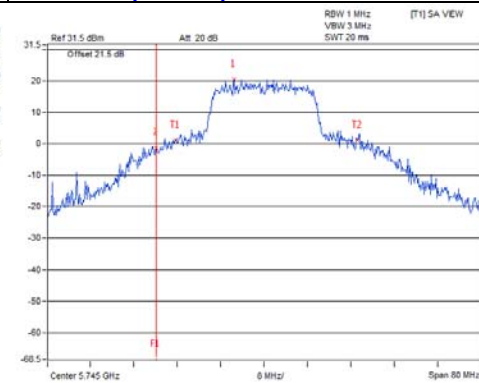

802.11ax (VHT20)_Chain 6 / CH149

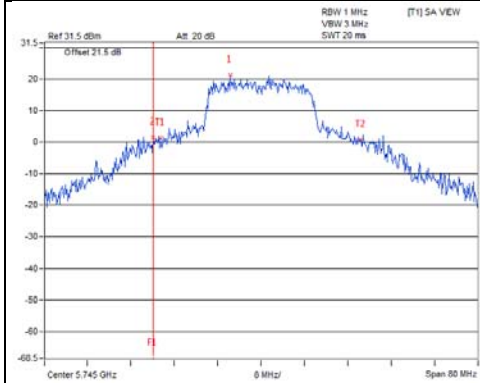

802.11ax (VHT20)_Chain 7 / CH149

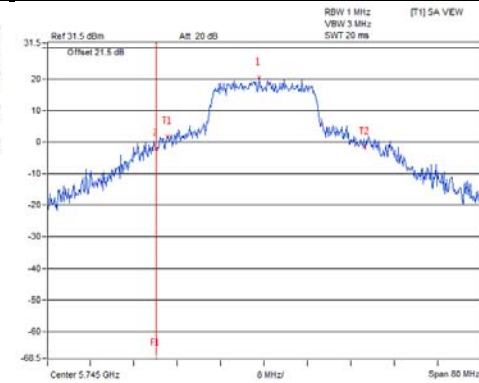

**Spectrum Plot for near by DFS band
(DFS is required, if 99% OCP straddle into U-NII-2C band)**

802.11ax (VHT40) Chain 4 / CH151

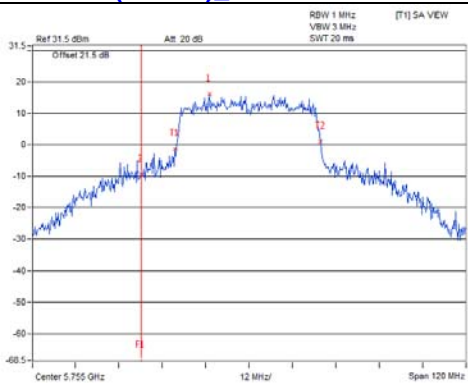

802.11ax (VHT40) Chain 5 / CH151

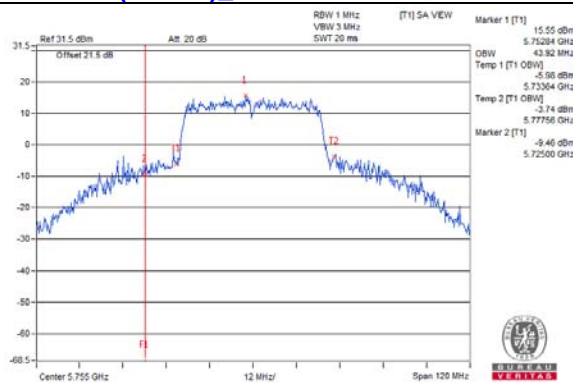

802.11ax (VHT40) Chain 6 / CH151

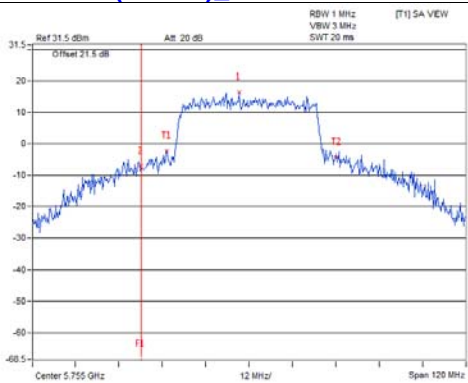

802.11ax (VHT40) Chain 7 / CH151

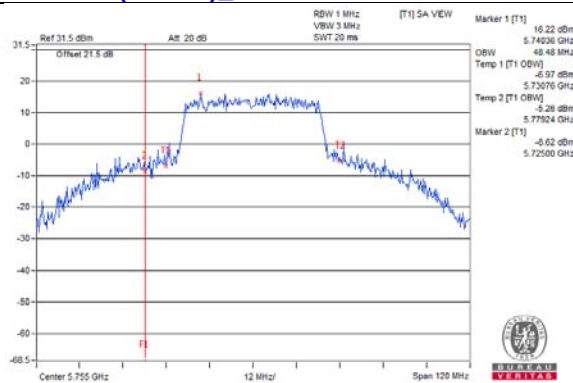

802.11ax (VHT80) Chain 4 / CH155

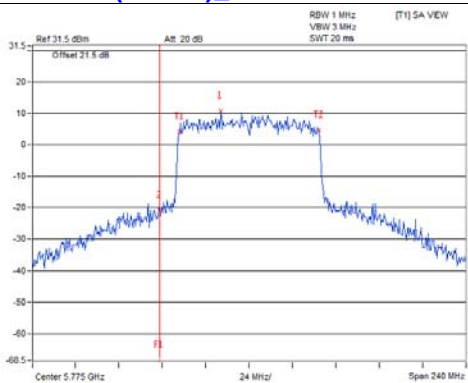

802.11ax (VHT80) Chain 5 / CH155

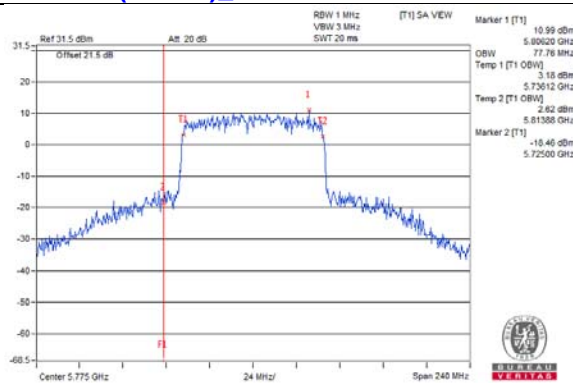

802.11ax (VHT80) Chain 6 / CH155

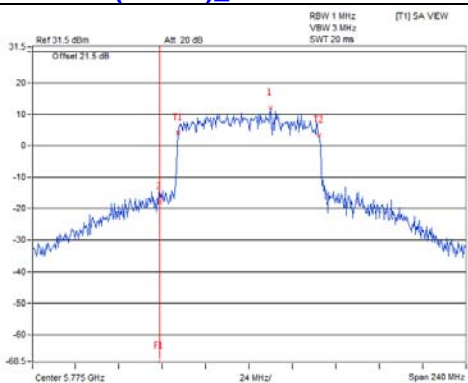

802.11ax (VHT80) Chain 7 / CH155

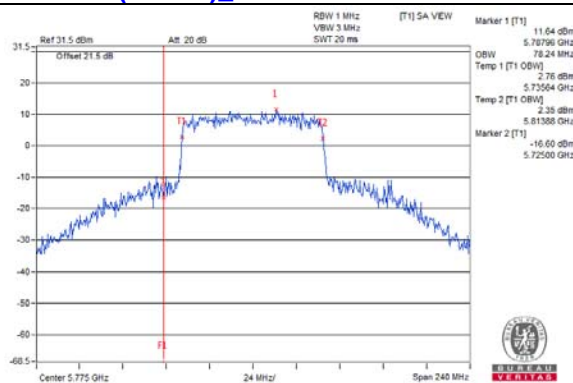

**Spectrum Plot for near by DFS band
(DFS is required, if 99% OCP straddle into U-NII-2C band)**

802.11ax (HE80+80) / Chain 6 : CH155

802.11ax (HE80+80) / Chain 7 : CH155

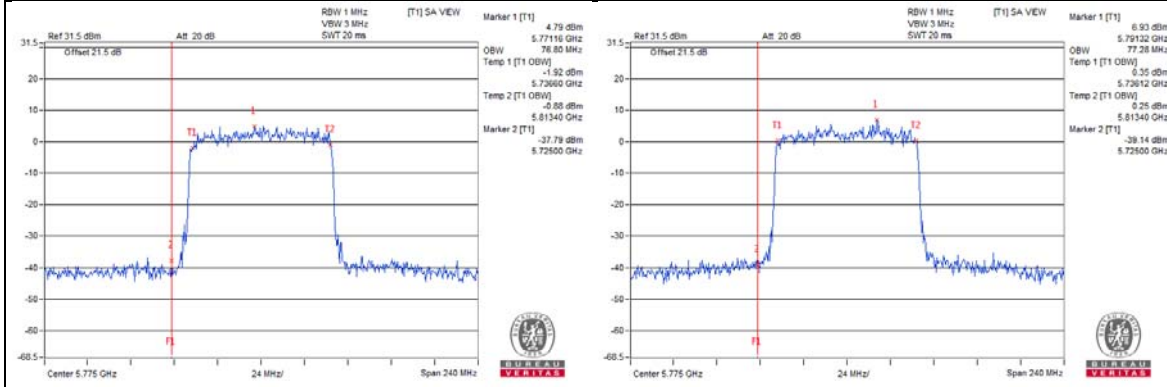

4.4.6 Test Results (Mode 3)

Non-Beamforming Mode

802.11a

Channel	Channel Frequency (MHz)	Occupied Bandwidth (MHz)	
		Chain 1	Chain 2
36	5180	17.04	17.64
40	5200	23.04	29.40
48	5240	17.16	18.24
149	5745	33.28	35.68
157	5785	32.32	34.08
165	5825	30.56	34.40

802.11ax (HE20)

Channel	Channel Frequency (MHz)	Occupied Bandwidth (MHz)	
		Chain 1	Chain 2
36	5180	19.08	19.20
40	5200	19.68	28.32
48	5240	19.08	19.08
149	5745	33.76	37.12
157	5785	30.24	36.00
165	5825	23.88	33.60

802.11ax (HE40)

Channel	Channel Frequency (MHz)	Occupied Bandwidth (MHz)	
		Chain 1	Chain 2
38	5190	38.16	38.16
46	5230	38.16	38.40
151	5755	43.92	47.04
159	5795	40.56	42.72

802.11ax (HE80)

Channel	Channel Frequency (MHz)	Occupied Bandwidth (MHz)	
		Chain 1	Chain 2
42	5210	77.28	77.28
155	5775	77.76	78.24

Spectrum Plot of Max. Value

802.11a_Chain 2 / CH149

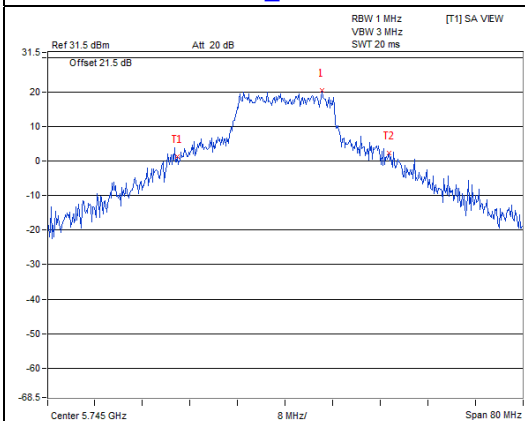

802.11ax (HE20)_Chain 2 / CH149

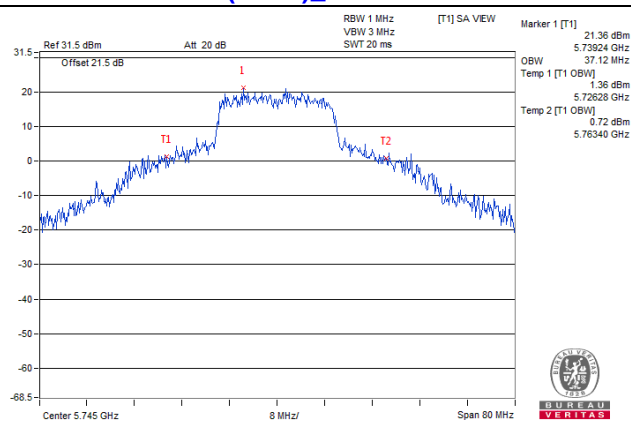

802.11ax (HE40)_Chain 2 / CH151

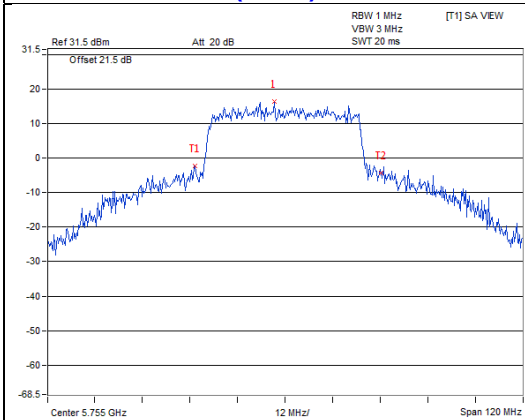

802.11ax (HE80)_Chain 2 / CH155

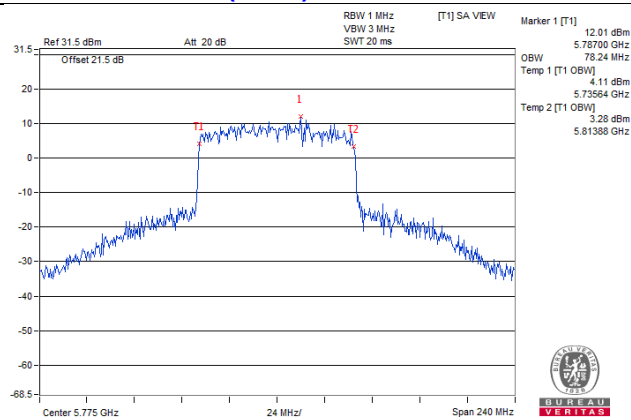

**Spectrum Plot for near by DFS band
(DFS is required, if 99% OCP straddle into U-NII-2A band)**

802.11a_Chain0 / CH48

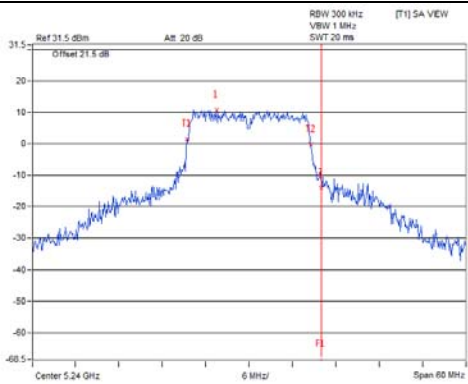

802.11a_Chain1 / CH48

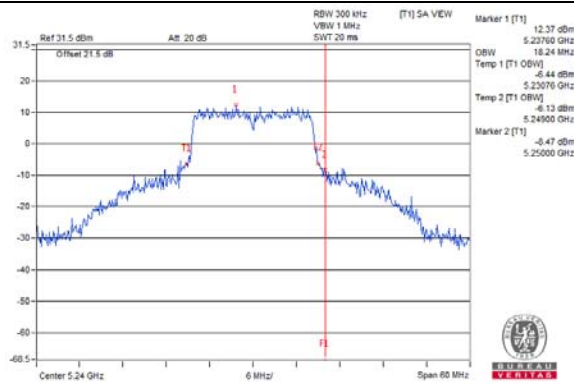

802.11ax (VHT20)_Chain0 / CH48

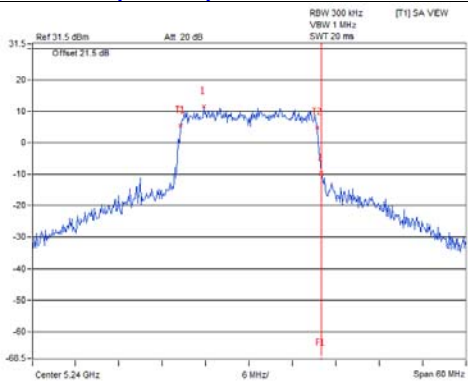

802.11ax (VHT20)_Chain1 / CH48

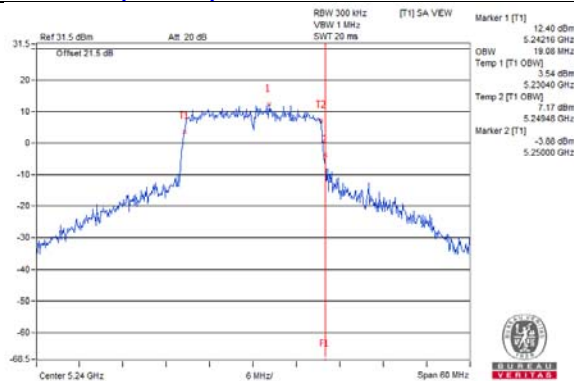

802.11ax (VHT40)_Chain0 / CH46

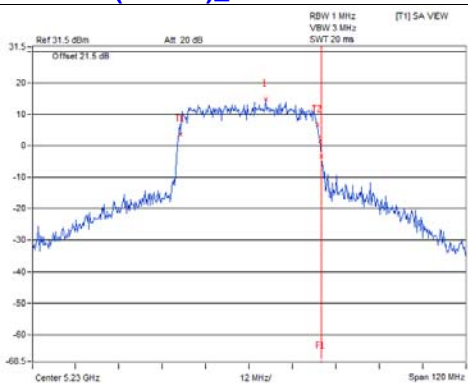

802.11ax (VHT40)_Chain1 / CH46

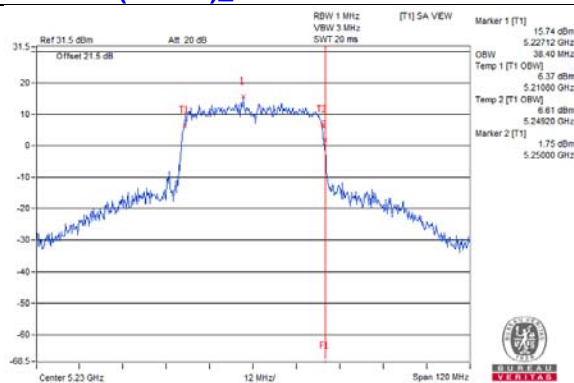

802.11ax (VHT80)_Chain0 / CH42

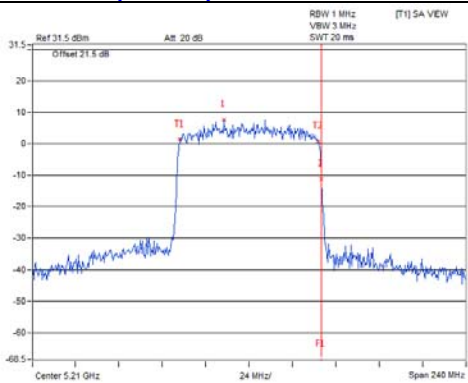

802.11ax (VHT80)_Chain1 / CH42

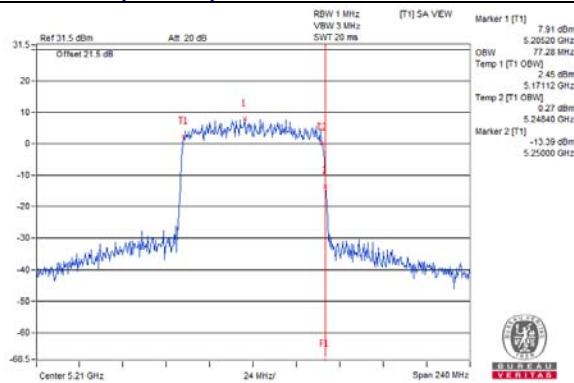

**Spectrum Plot for near by DFS band
(DFS is required, if 99% OCP straddle into U-NII-2C band)**

802.11a_Chain0 / CH149

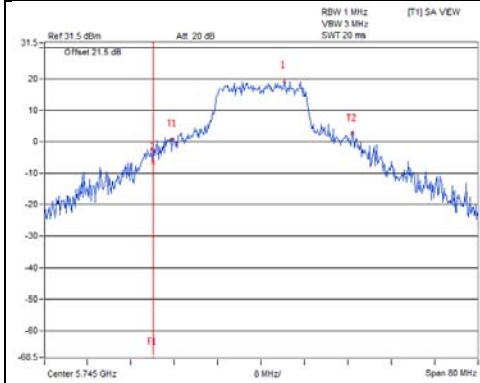

802.11a_Chain1 / CH149

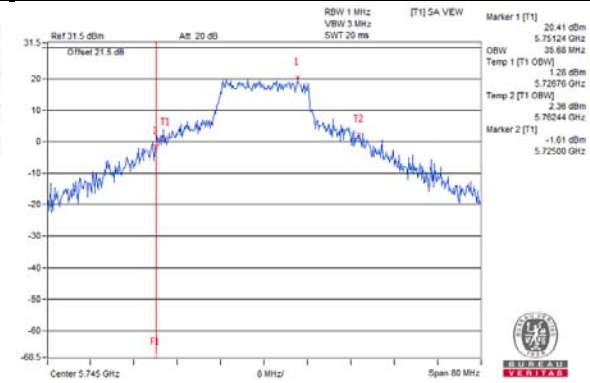

802.11ax (VHT20)_Chain0 / CH149

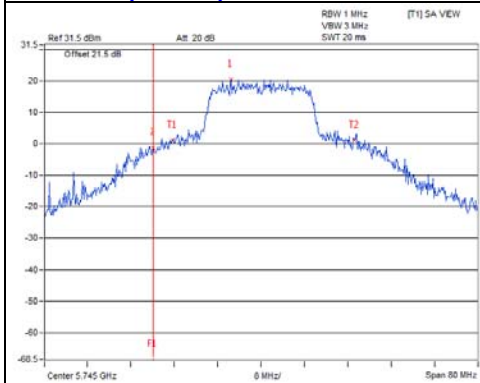

802.11ax (VHT20)_Chain1 / CH149

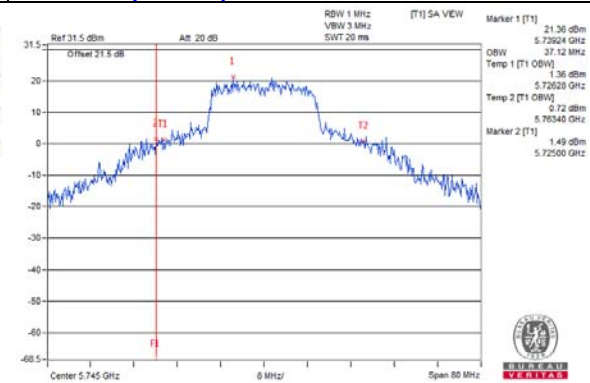

802.11ax (VHT40)_Chain0 / CH151

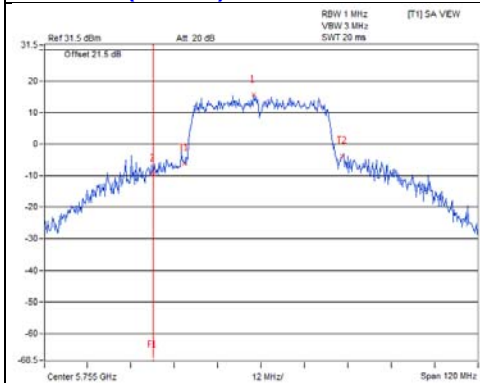

802.11ax (VHT40)_Chain1 / CH151

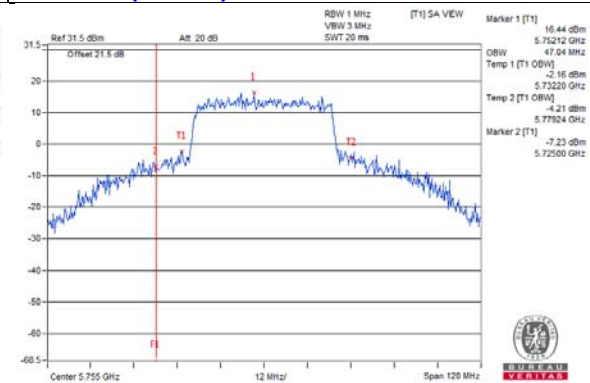

802.11ax (VHT80)_Chain0 / CH155

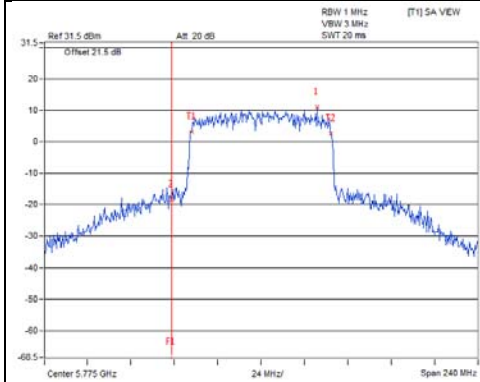

802.11ax (VHT80)_Chain1 / CH155

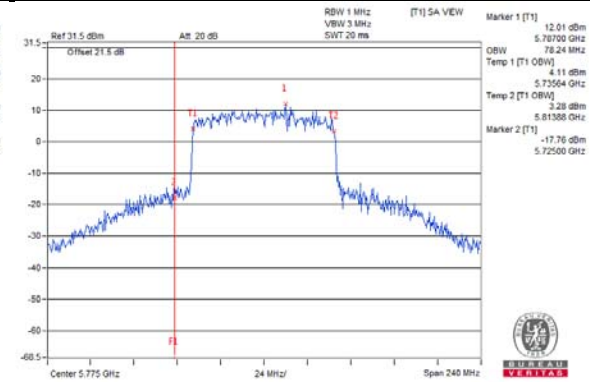

4.4.7 Test Results (Mode 4)

Non-Beamforming Mode

802.11a

Channel	Channel Frequency (MHz)	Occupied Bandwidth (MHz)
36	5180	18.96
40	5200	28.80
48	5240	17.64
149	5745	35.68
157	5785	34.08
165	5825	34.40

802.11ax (HE20)

Channel	Channel Frequency (MHz)	Occupied Bandwidth (MHz)
36	5180	19.32
40	5200	25.92
48	5240	19.08
149	5745	37.12
157	5785	36.00
165	5825	33.60

802.11ax (HE40)

Channel	Channel Frequency (MHz)	Occupied Bandwidth (MHz)
38	5190	38.16
46	5230	38.16
151	5755	52.80
159	5795	59.76

802.11ax (HE80)

Channel	Channel Frequency (MHz)	Occupied Bandwidth (MHz)
42	5210	76.80
155	5775	78.24

Spectrum Plot of Max. Value

802.11a / CH149

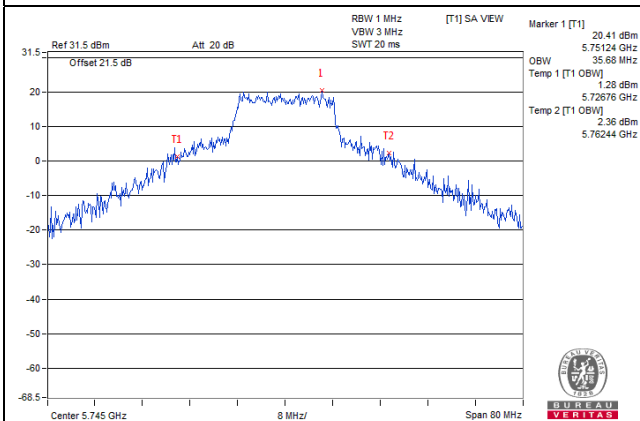

802.11ax (HE20) / CH149

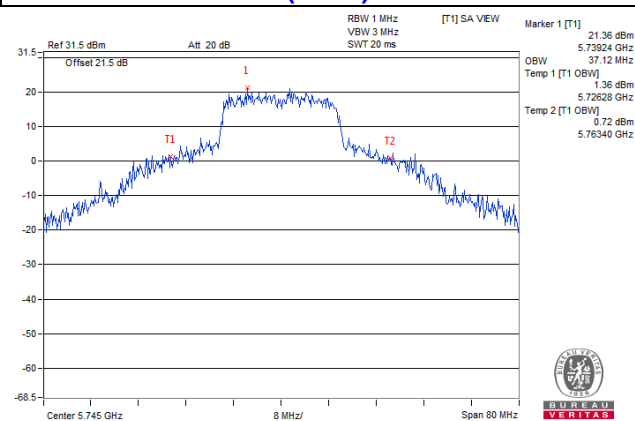

802.11ax (HE40) / CH159

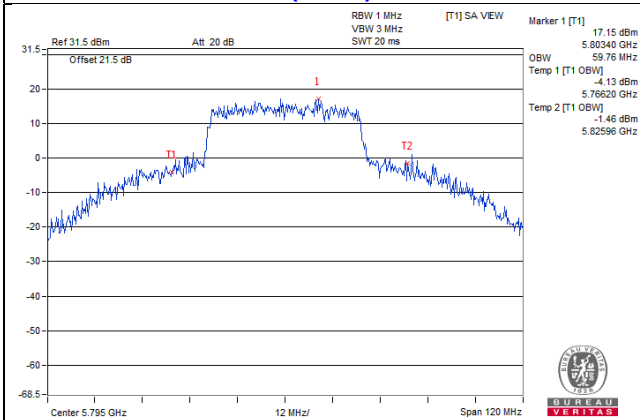

802.11ax (HE80) / CH155

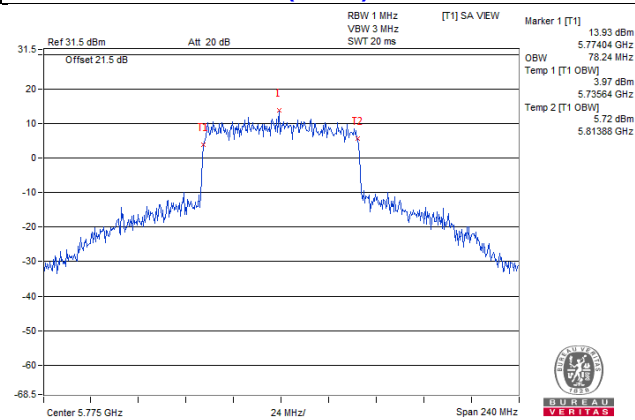

**Spectrum Plot for near by DFS band
(DFS is required, if 99% OCP straddle into U-NII-2A band)**

802.11a / CH48

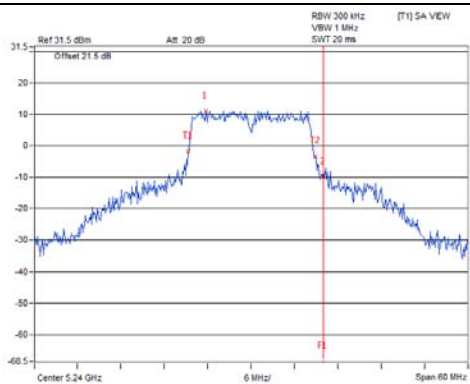

802.11ax (VHT20) / CH48

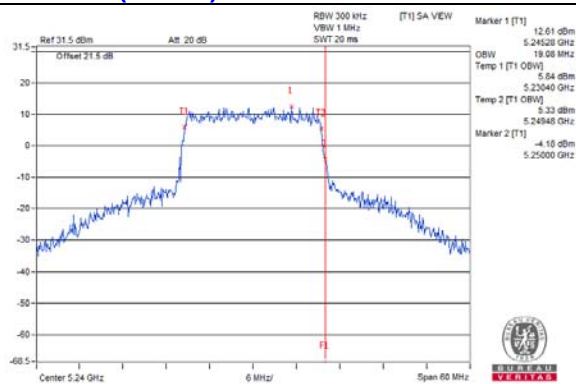

802.11ax (VHT40) / CH46

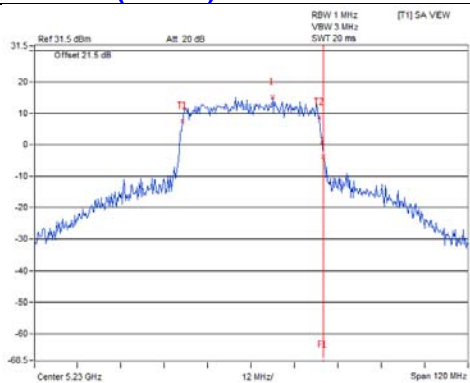

802.11ax (VHT80) / CH42

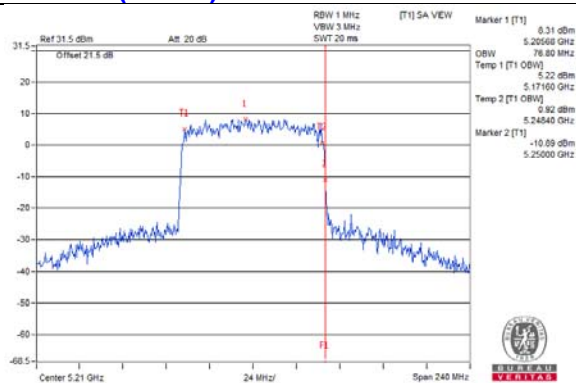

**Spectrum Plot for near by DFS band
(DFS is required, if 99% OCP straddle into U-NII-2C band)**

802.11a / CH149

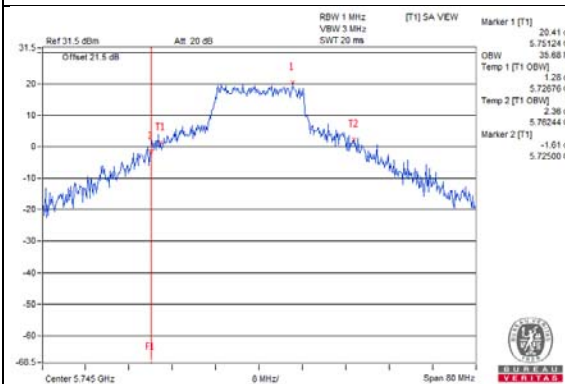

802.11ax (VHT20) / CH149

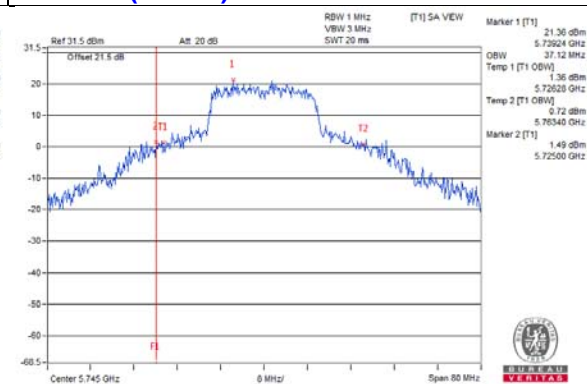

802.11ax (VHT40) / CH151

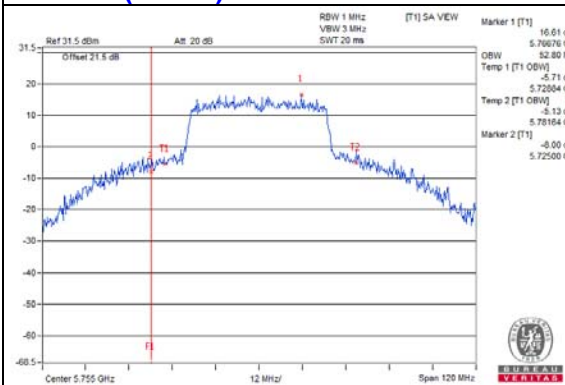

802.11ax (VHT80) / CH155

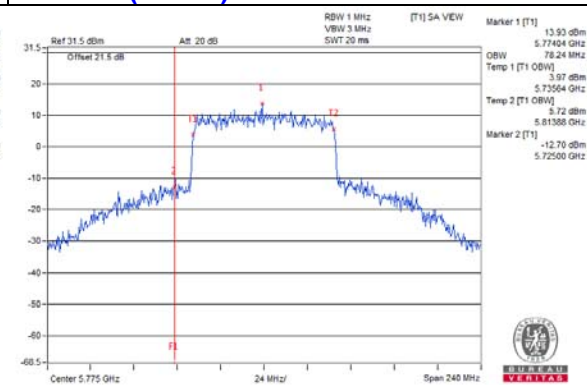

4.5 Peak Power Spectral Density Measurement

4.5.1 Limits of Peak Power Spectral Density Measurement

Operation Band	EUT Category		Limit
U-NII-1		Outdoor Access Point	17dBm/ MHz
		Fixed point-to-point Access Point	
	√	Indoor Access Point	
		Client device	11dBm/ MHz
U-NII-2A			11dBm/ MHz
U-NII-2C			11dBm/ MHz
U-NII-3		√	30dBm/ 500kHz

4.5.2 Test Setup

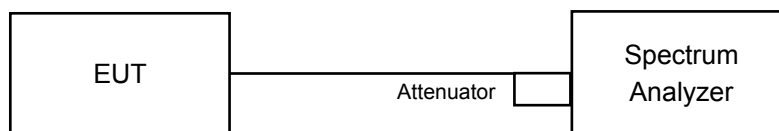

4.5.3 Test Instruments

Refer to section 4.1.2 to get information of above instrument.

4.5.4 Test Procedure

For U-NII-1 band:

Using method SA-2

1. Set span to encompass the entire emission bandwidth (EBW) of the signal.
2. Set RBW = 1 MHz, Set VBW ≥ 3 MHz, Detector = RMS
3. Sweep time = auto, trigger set to “free run”.
4. Trace average at least 100 traces in power averaging mode.
5. Record the max value and add 10 log (1/duty cycle)

For U-NII-3:

1. Set span to encompass the entire emission bandwidth (EBW) of the signal.
2. Set RBW = 300 kHz, Set VBW ≥ 1 MHz, Detector = RMS
3. Use the peak marker function to determine the maximum power level in any 300 kHz band segment within the fundamental EBW.
4. Scale the observed power level to an equivalent value in 500 kHz by adjusting (reducing) the measured power by a bandwidth correction factor (BWCF) where $BWCF = 10\log(500\text{kHz}/300\text{kHz})$
5. Sweep time = auto, trigger set to “free run”.
6. Trace average at least 100 traces in power averaging mode.
7. Record the max value and add 10 log (1/duty cycle)

4.5.5 Deviation from Test Standard

No deviation.

4.5.6 EUT Operating Condition

Same as Item 4.3.6.

4.5.7 Test Results (Mode 1)

Non-Beamforming Mode

For U-NII-1:

802.11a

Chan.	Freq. (MHz)	PSD W/O Duty Factor (dBm)								Duty Factor (dB)	Total PSD With Duty Factor (dBm)	Max. Limit (dBm/MHz)	Pass / Fail
		Chain 0	Chain 1	Chain 2	Chain 3	Chain 4	Chain 5	Chain 6	Chain 7				
36	5180	2.80	3.52	2.21	2.73	2.61	3.89	2.90	3.11	0.36	12.03	13.71	Pass
40	5200	1.68	2.77	3.49	1.71	0.42	0.04	3.20	1.92	0.36	11.08	13.71	Pass
48	5240	2.81	2.37	3.44	2.18	3.10	4.34	3.22	2.36	0.36	12.06	13.71	Pass

- Note: 1. Method a) of power density measurement of KDB 662911 is using for calculating total power density. Total power density is summing entire spectra across corresponding frequency bins on the various outputs by computer.
 2. The directional gain = 9.29dBi > 6dBi, so the power density limit shall be reduced to $17-(9.29-6) = 13.71$ dBm.
 3. Refer to section 3.3 for duty cycle spectrum plot.

802.11ac (VHT20)

Chan.	Freq. (MHz)	PSD W/O Duty Factor (dBm)								Duty Factor (dB)	Total PSD With Duty Factor (dBm)	Max. Limit (dBm/MHz)	Pass / Fail
		Chain 0	Chain 1	Chain 2	Chain 3	Chain 4	Chain 5	Chain 6	Chain 7				
36	5180	1.91	2.32	2.76	2.21	1.64	2.70	2.23	1.81	0.20	11.24	13.71	Pass
40	5200	1.20	1.66	2.63	2.89	1.67	1.68	1.49	0.20	0.20	10.78	13.71	Pass
48	5240	2.11	2.21	2.95	2.81	1.88	2.74	2.53	1.86	0.20	11.44	13.71	Pass

- Note: 1. Method a) of power density measurement of KDB 662911 is using for calculating total power density. Total power density is summing entire spectra across corresponding frequency bins on the various outputs by computer.
 2. The directional gain = 9.29dBi > 6dBi, so the power density limit shall be reduced to $17-(9.29-6) = 13.71$ dBm.
 3. Refer to section 3.3 for duty cycle spectrum plot.

802.11ac (VHT40)

Chan.	Freq. (MHz)	PSD W/O Duty Factor (dBm)								Duty Factor (dB)	Total PSD With Duty Factor (dBm)	Max. Limit (dBm/MHz)	Pass / Fail
		Chain 0	Chain 1	Chain 2	Chain 3	Chain 4	Chain 5	Chain 6	Chain 7				
38	5190	-5.27	-1.45	-1.39	-2.57	-2.08	-3.60	-2.64	-3.97	0.22	6.33	13.71	Pass
46	5230	-0.80	-0.09	-0.30	-0.23	-0.41	0.24	-0.37	-0.43	0.22	8.74	13.71	Pass

- Note: 1. Method a) of power density measurement of KDB 662911 is using for calculating total power density. Total power density is summing entire spectra across corresponding frequency bins on the various outputs by computer.
 2. The directional gain = 9.29dBi > 6dBi, so the power density limit shall be reduced to $17-(9.29-6) = 13.71$ dBm.
 3. Refer to section 3.3 for duty cycle spectrum plot.

802.11ac (VHT80)

Chan.	Freq. (MHz)	PSD W/O Duty Factor (dBm)								Duty Factor (dB)	Total PSD With Duty Factor (dBm)	Max. Limit (dBm/MHz)	Pass / Fail
		Chain 0	Chain 1	Chain 2	Chain 3	Chain 4	Chain 5	Chain 6	Chain 7				
42	5210	-5.87	-5.67	-5.88	-5.00	-6.02	-5.98	-6.62	-6.61	0.19	3.10	13.71	Pass

- Note: 1. Method a) of power density measurement of KDB 662911 is using for calculating total power density. Total power density is summing entire spectra across corresponding frequency bins on the various outputs by computer.
2. The directional gain = 9.29dBi > 6dBi, so the power density limit shall be reduced to $17-(9.29-6) = 13.71$ dBm.
3. Refer to section 3.3 for duty cycle spectrum plot.

802.11ac (VHT80+80)

Chan.	Freq. (MHz)	PSD W/O Duty Factor (dBm)								Duty Factor (dB)	Total PSD With Duty Factor (dBm)	Max. Limit (dBm/MHz)	Pass / Fail
		Chain 0	Chain 1	Chain 2	Chain 3	Chain 4	Chain 5	Chain 6	Chain 7				
42+155	5210	-4.46	-5.49	-4.81	-4.58	-	-	-	-	0.36	1.20	13.71	Pass
	5775	Test results refer to U-NII-3 data											

- Note: 1. Method a) of power density measurement of KDB 662911 is using for calculating total power density. Total power density is summing entire spectra across corresponding frequency bins on the various outputs by computer.
2. The directional gain = 9.29dBi > 6dBi, so the power density limit shall be reduced to $17-(9.29-6) = 13.71$ dBm.
3. Refer to section 3.3 for duty cycle spectrum plot.

802.11ax (HE20)

Chan.	Freq. (MHz)	PSD W/O Duty Factor (dBm)								Duty Factor (dB)	Total PSD With Duty Factor (dBm)	Max. Limit (dBm/MHz)	Pass / Fail
		Chain 0	Chain 1	Chain 2	Chain 3	Chain 4	Chain 5	Chain 6	Chain 7				
36	5180	1.94	2.14	2.60	2.12	2.18	2.72	1.83	1.94	0.20	11.23	13.71	Pass
40	5200	2.11	2.07	2.32	3.11	1.81	2.97	2.92	0.87	0.20	11.36	13.71	Pass
48	5240	1.82	2.73	2.94	2.87	2.44	3.21	2.51	2.84	0.20	11.72	13.71	Pass

- Note: 1. Method a) of power density measurement of KDB 662911 is using for calculating total power density. Total power density is summing entire spectra across corresponding frequency bins on the various outputs by computer.
2. The directional gain = 9.29dBi > 6dBi, so the power density limit shall be reduced to $17-(9.29-6) = 13.71$ dBm.
3. Refer to section 3.3 for duty cycle spectrum plot.

802.11ax (HE40)

Chan.	Freq. (MHz)	PSD W/O Duty Factor (dBm)								Duty Factor (dB)	Total PSD With Duty Factor (dBm)	Max. Limit (dBm/MHz)	Pass / Fail
		Chain 0	Chain 1	Chain 2	Chain 3	Chain 4	Chain 5	Chain 6	Chain 7				
38	5190	-2.71	-2.21	-2.49	-3.33	-2.00	-1.58	-3.04	-1.99	0.16	6.65	13.71	Pass
46	5230	-0.17	-0.37	-0.19	0.10	-0.18	0.17	-0.01	-0.43	0.16	8.90	13.71	Pass

- Note: 1. Method a) of power density measurement of KDB 662911 is using for calculating total power density. Total power density is summing entire spectra across corresponding frequency bins on the various outputs by computer.
2. The directional gain = 9.29dBi > 6dBi, so the power density limit shall be reduced to $17-(9.29-6) = 13.71$ dBm.
3. Refer to section 3.3 for duty cycle spectrum plot.

802.11ax (HE80)

Chan.	Freq. (MHz)	PSD W/O Duty Factor (dBm)								Duty Factor (dB)	Total PSD With Duty Factor (dBm)	Max. Limit (dBm/MHz)	Pass / Fail
		Chain 0	Chain 1	Chain 2	Chain 3	Chain 4	Chain 5	Chain 6	Chain 7				
42	5210	-7.15	-4.79	-5.80	-5.22	-5.84	-4.76	-6.89	-6.23	0.18	3.28	13.71	Pass

- Note: 1. Method a) of power density measurement of KDB 662911 is using for calculating total power density. Total power density is summing entire spectra across corresponding frequency bins on the various outputs by computer.
2. The directional gain = 9.29dBi > 6dBi, so the power density limit shall be reduced to $17-(9.29-6) = 13.71$ dBm.
3. Refer to section 3.3 for duty cycle spectrum plot.

802.11ax (HE80+80)

Chan.	Freq. (MHz)	PSD W/O Duty Factor (dBm)								Duty Factor (dB)	Total PSD With Duty Factor (dBm)	Max. Limit (dBm/MHz)	Pass / Fail
		Chain 0	Chain 1	Chain 2	Chain 3	Chain 4	Chain 5	Chain 6	Chain 7				
42+155	5210	-3.89	-4.09	-4.97	-3.53	-	-	-	-	0.19	1.93	13.71	Pass
	5775	Test results refer to U-NII-3 data											

- Note: 1. Method a) of power density measurement of KDB 662911 is using for calculating total power density. Total power density is summing entire spectra across corresponding frequency bins on the various outputs by computer.
2. The directional gain = 9.29dBi > 6dBi, so the power density limit shall be reduced to $17-(9.29-6) = 13.71$ dBm.
3. Refer to section 3.3 for duty cycle spectrum plot.

Spectrum Plot of Worst Value

802.11a_Chain 5 / CH48

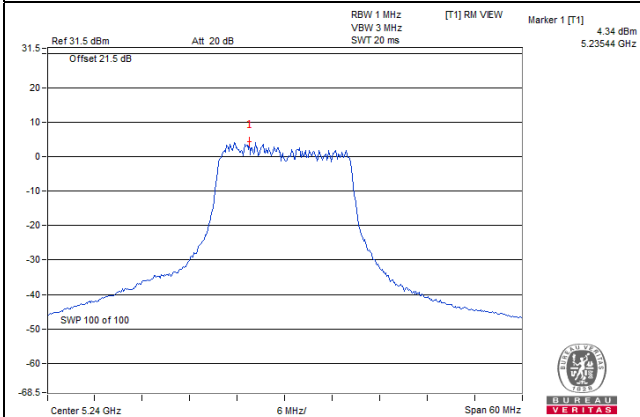

802.11ac (VHT20)_Chain 2 / CH48

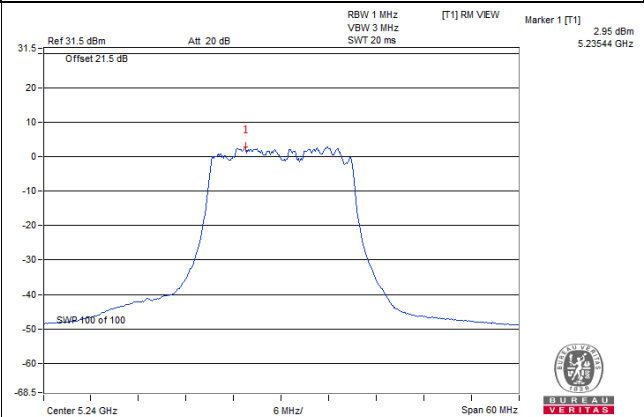

802.11ac (VHT40)_Chain 5 / CH46

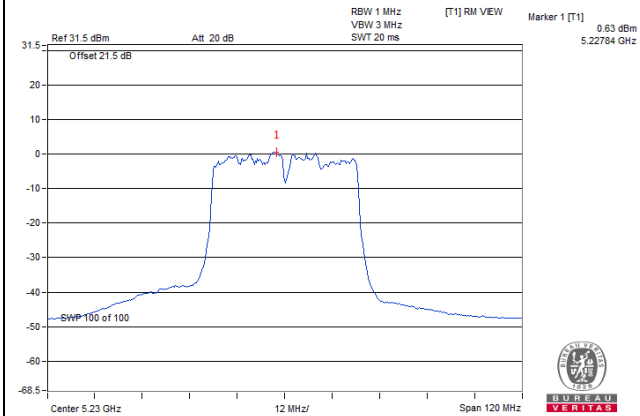

802.11ac (VHT80)_Chain 3 / CH42

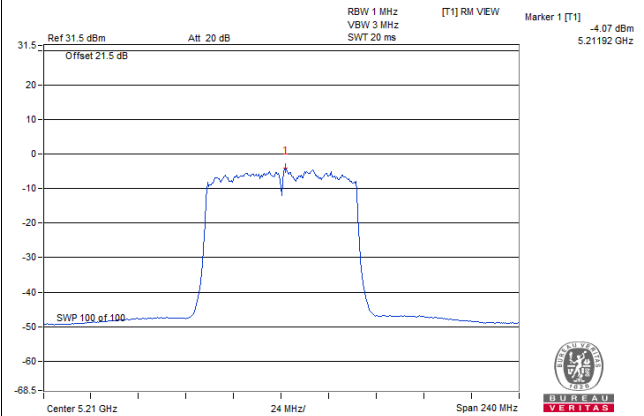

802.11ac (VHT80+80)_Chain 0 / CH42

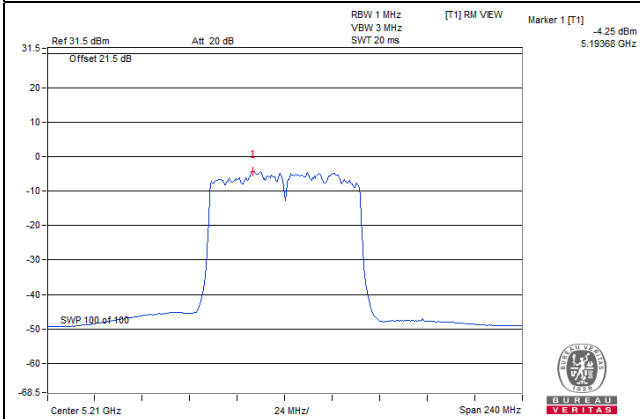

802.11ax (HE20)_Chain 5 / CH48

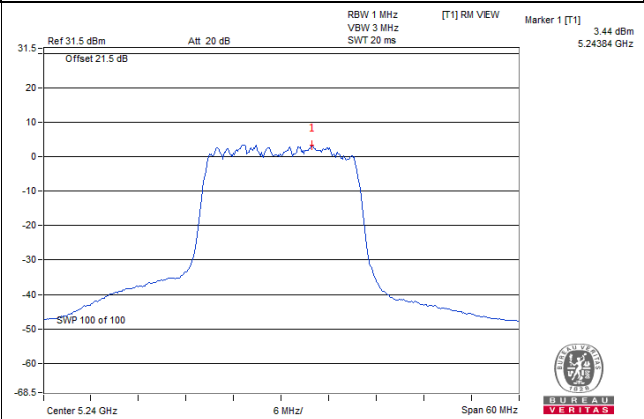

Spectrum Plot of Worst Value

802.11ax (HE40)_Chain 5 / CH46

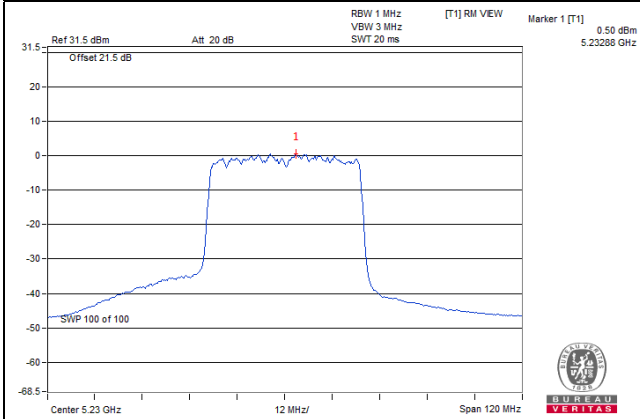

802.11ax (HE80)_Chain 5 / CH42

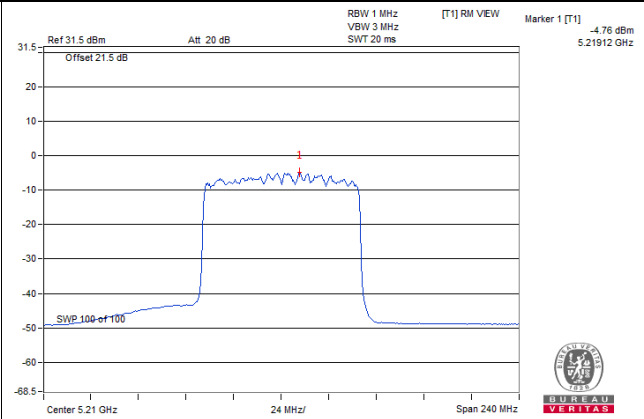

802.11ax (HE80+80)_Chain 3 / CH42

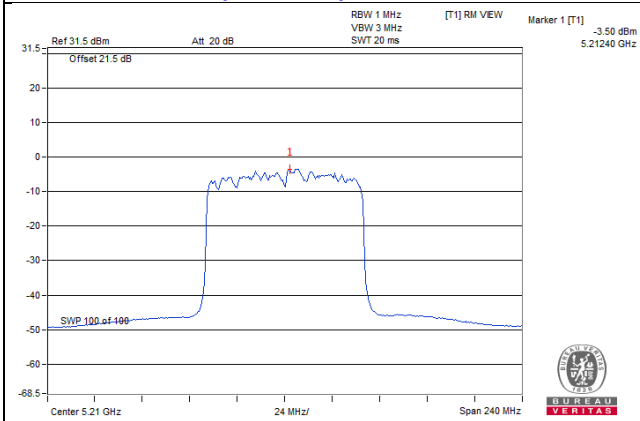

For U-NII-3:

802.11a

Chan.	Freq. (MHz)	PSD W/O Duty Factor (dBm/300kHz)								Duty Factor (dB)	Total PSD With Duty Factor		Total PSD With Duty Factor (dBm/500kHz)	Limit (dBm/500kHz)	Pass /Fail
		Chain 0	Chain 1	Chain 2	Chain 3	Chain 4	Chain 5	Chain 6	Chain 7		mW/300 kHz	dBm/300kHz			
149	5745	-5.52	-5.16	-4.04	-4.89	-4.81	-4.20	-3.13	-4.43	0.36	2.8617	4.57	6.79	26.80	Pass
157	5785	-4.79	-4.87	-3.84	-5.50	-4.60	-4.29	-4.30	-5.76	0.36	2.7087	4.33	6.55	26.80	Pass
165	5825	-5.26	-5.61	-3.26	-4.74	-4.26	-4.80	-5.01	-5.46	0.36	2.6865	4.29	6.51	26.80	Pass

Note: 1. Method b) Measure and sum spectral maxima across the outputs of KDB 662911 is using for calculating total power density.

2. The directional gain = 9.2dBi > 6dBi, so the power density limit shall be reduced to $30-(9.2-6) = 26.8$ dBm.

3. Refer to section 3.3 for duty cycle spectrum plot.

802.11ac (VHT20)

Chan.	Freq. (MHz)	PSD W/O Duty Factor (dBm/300kHz)								Duty Factor (dB)	Total PSD With Duty Factor		Total PSD With Duty Factor (dBm/500kHz)	Limit (dBm/500kHz)	Pass /Fail
		Chain 0	Chain 1	Chain 2	Chain 3	Chain 4	Chain 5	Chain 6	Chain 7		mW/300 kHz	dBm/300kHz			
149	5745	-5.86	-5.95	-4.27	-5.29	-5.15	-5.91	-5.75	-4.58	0.20	2.3598	3.73	5.95	26.80	Pass
157	5785	-5.63	-6.06	-5.09	-5.46	-6.03	-5.17	-5.27	-5.44	0.20	2.2519	3.53	5.75	26.80	Pass
165	5825	-6.67	-5.36	-5.86	-5.68	-6.05	-5.28	-6.46	-5.45	0.20	2.092	3.21	5.43	26.80	Pass

Note: 1. Method b) Measure and sum spectral maxima across the outputs of KDB 662911 is using for calculating total power density.

2. The directional gain = 9.2dBi > 6dBi, so the power density limit shall be reduced to $30-(9.2-6) = 26.8$ dBm.

3. Refer to section 3.3 for duty cycle spectrum plot.

802.11ac (VHT40)

Chan.	Freq. (MHz)	PSD W/O Duty Factor (dBm/300kHz)								Duty Factor (dB)	Total PSD With Duty Factor		Total PSD With Duty Factor (dBm/500kHz)	Limit (dBm/500kHz)	Pass /Fail
		Chain 0	Chain 1	Chain 2	Chain 3	Chain 4	Chain 5	Chain 6	Chain 7		mW/300 kHz	dBm/300kHz			
151	5755	-9.26	-8.51	-8.27	-8.79	-9.47	-8.62	-9.27	-9.05	0.22	1.0337	0.14	2.36	26.80	Pass
159	5795	-9.35	-8.46	-8.41	-8.93	-8.58	-8.49	-9.44	-8.97	0.22	1.0516	0.22	2.44	26.80	Pass

Note: 1. Method b) Measure and sum spectral maxima across the outputs of KDB 662911 is using for calculating total power density.

2. The directional gain = 9.2dBi > 6dBi, so the power density limit shall be reduced to $30-(9.2-6) = 26.8$ dBm.

3. Refer to section 3.3 for duty cycle spectrum plot.

802.11ac (VHT80)

Chan.	Freq. (MHz)	PSD W/O Duty Factor (dBm/300kHz)								Duty Factor (dB)	Total PSD With Duty Factor		Total PSD With Duty Factor (dBm/500kHz)	Limit (dBm/500kHz)	Pass /Fail
		Chain 0	Chain 1	Chain 2	Chain 3	Chain 4	Chain 5	Chain 6	Chain 7		mW/300 kHz	dBm/300kHz			
155	5775	-12.17	-12.04	-11.72	-12.16	-12.34	-11.30	-12.84	-12.26	0.19	0.49521	-3.05	-0.83	26.80	Pass

- Note: 1. Method b) Measure and sum spectral maxima across the outputs of KDB 662911 is using for calculating total power density.
2. The directional gain = 9.2dBi > 6dBi, so the power density limit shall be reduced to 30-(9.2-6) = 26.8dBm.
3. Refer to section 3.3 for duty cycle spectrum plot.

802.11ac (VHT80+80)

Chan.	Freq. (MHz)	PSD W/O Duty Factor (dBm/300kHz)								Duty Factor (dB)	Total PSD With Duty Factor		Total PSD With Duty Factor (dBm/500kHz)	Limit (dBm/500kHz)	Pass /Fail
		Chain 0	Chain 1	Chain 2	Chain 3	Chain 4	Chain 5	Chain 6	Chain 7		mW/300 kHz	dBm/300kHz			
42	5210	Test results refer to U_NII-1 data													
155	5775	-	-	-	-	-13.22	-12.83	-12.50	-12.75	0.36	0.20909	-6.80	-4.58	26.80	Pass

- Note: 1. Method b) Measure and sum spectral maxima across the outputs of KDB 662911 is using for calculating total power density.
2. The directional gain = 9.2dBi > 6dBi, so the power density limit shall be reduced to 30-(9.2-6) = 26.8dBm.
3. Refer to section 3.3 for duty cycle spectrum plot.

802.11ax (HE20)

Chan.	Freq. (MHz)	PSD W/O Duty Factor (dBm/300kHz)								Duty Factor (dB)	Total PSD With Duty Factor		Total PSD With Duty Factor (dBm/500kHz)	Limit (dBm/500kHz)	Pass /Fail
		Chain 0	Chain 1	Chain 2	Chain 3	Chain 4	Chain 5	Chain 6	Chain 7		mW/300 kHz	dBm/300kHz			
149	5745	-6.29	-5.86	-5.59	-5.82	-6.31	-6.15	-5.86	-5.77	0.20	2.0331	3.08	5.30	26.80	Pass
157	5785	-6.42	-5.59	-5.53	-6.04	-6.68	-5.68	-6.54	-5.94	0.20	1.9946	3.00	5.22	26.80	Pass
165	5825	-6.53	-6.29	-5.72	-5.99	-6.68	-5.82	-6.11	-5.82	0.20	1.9603	2.92	5.14	26.80	Pass

- Note: 1. Method b) Measure and sum spectral maxima across the outputs of KDB 662911 is using for calculating total power density.
2. The directional gain = 9.2dBi > 6dBi, so the power density limit shall be reduced to 30-(9.2-6) = 26.8dBm.
3. Refer to section 3.3 for duty cycle spectrum plot.

802.11ax (HE40)

Chan.	Freq. (MHz)	PSD W/O Duty Factor (dBm/300kHz)								Duty Factor (dB)	Total PSD With Duty Factor		Total PSD With Duty Factor (dBm/500kHz)	Limit (dBm/500kHz)	Pass /Fail
		Chain 0	Chain 1	Chain 2	Chain 3	Chain 4	Chain 5	Chain 6	Chain 7		mW/300 kHz	dBm/300kHz			
151	5755	-8.96	-9.19	-8.14	-8.89	-9.12	-8.14	-8.89	-8.55	0.16	1.0748	0.31	2.53	26.80	Pass
159	5795	-9.21	-9.03	-8.22	-8.50	-8.66	-8.65	-9.00	-8.71	0.16	1.07	0.29	2.51	26.80	Pass

- Note: 1. Method b) Measure and sum spectral maxima across the outputs of KDB 662911 is using for calculating total power density.
 2. The directional gain = 9.2dBi > 6dBi, so the power density limit shall be reduced to 30-(9.2-6) = 26.8dBm.
 3. Refer to section 3.3 for duty cycle spectrum plot.

802.11ax (HE80)

Chan.	Freq. (MHz)	PSD W/O Duty Factor (dBm/300kHz)								Duty Factor (dB)	Total PSD With Duty Factor		Total PSD With Duty Factor (dBm/500kHz)	Limit (dBm/500kHz)	Pass /Fail
		Chain 0	Chain 1	Chain 2	Chain 3	Chain 4	Chain 5	Chain 6	Chain 7		mW/300 kHz	dBm/300kHz			
155	5775	-11.71	-12.25	-11.27	-11.63	-12.52	-11.31	-11.65	-11.92	0.18	0.53297	-2.73	-0.51	26.80	Pass

- Note: 1. Method b) Measure and sum spectral maxima across the outputs of KDB 662911 is using for calculating total power density.
 2. The directional gain = 9.2dBi > 6dBi, so the power density limit shall be reduced to 30-(9.2-6) = 26.8dBm.
 3. Refer to section 3.3 for duty cycle spectrum plot.

802.11ax (HE80+80)

Chan.	Freq. (MHz)	PSD W/O Duty Factor (dBm/300kHz)								Duty Factor (dB)	Total PSD With Duty Factor		Total PSD With Duty Factor (dBm/500kHz)	Limit (dBm/500kHz)	Pass /Fail
		Chain 0	Chain 1	Chain 2	Chain 3	Chain 4	Chain 5	Chain 6	Chain 7		mW/300 kHz	dBm/300kHz			
42	5210	Test results refer to U_NII-1 data													
155	5775	-	-	-	-	-12.66	-12.23	-12.29	-12.60	0.19	0.22802	-6.42	-4.20	26.80	Pass

- Note: 1. Method b) Measure and sum spectral maxima across the outputs of KDB 662911 is using for calculating total power density.
 2. The directional gain = 9.2dBi > 6dBi, so the power density limit shall be reduced to 30-(9.2-6) = 26.8dBm.
 3. Refer to section 3.3 for duty cycle spectrum plot.

Spectrum Plot of Worst Value

802.11a_Chain 6 / CH149

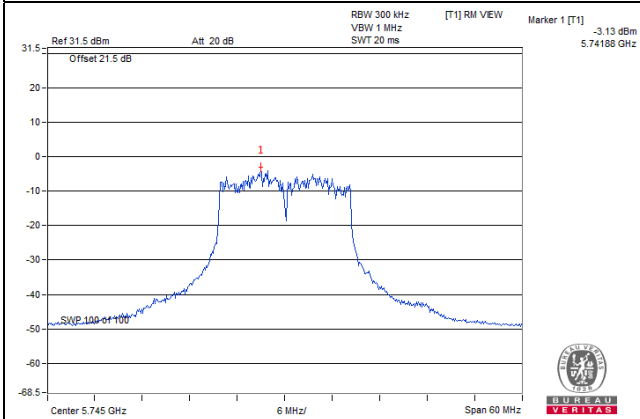

802.11ac (VHT20)_Chain 2 / CH149

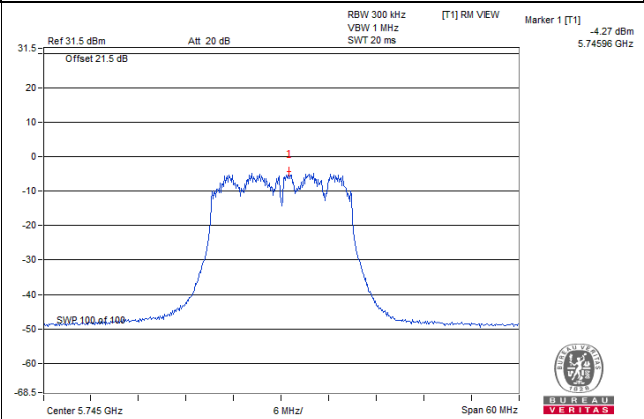

802.11ac (VHT40)_Chain 2 / CH151

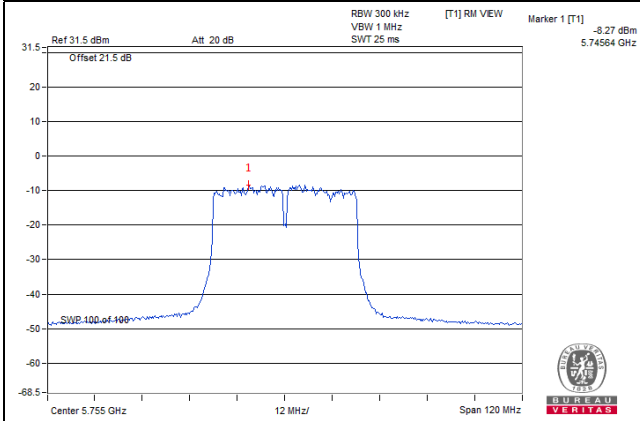

802.11ac (VHT80)_Chain 5 / CH155

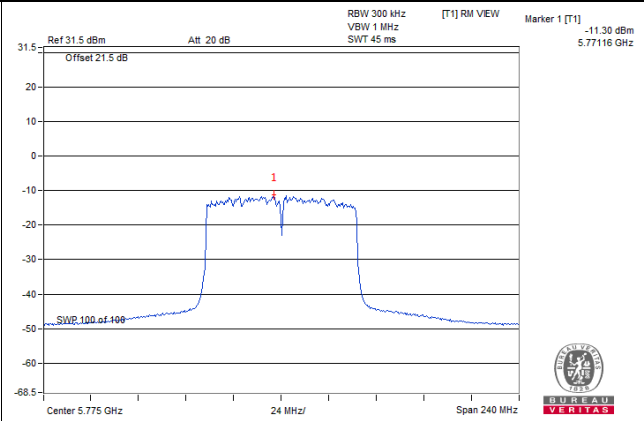

802.11ac (VHT80+80)_Chain 6 / CH155

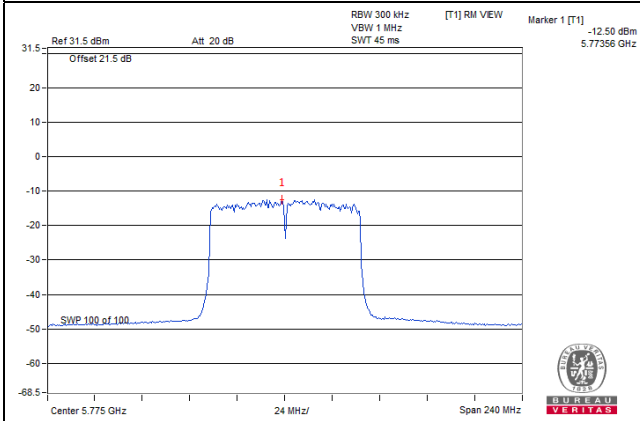

802.11ax (HE20)_Chain 2 / CH157

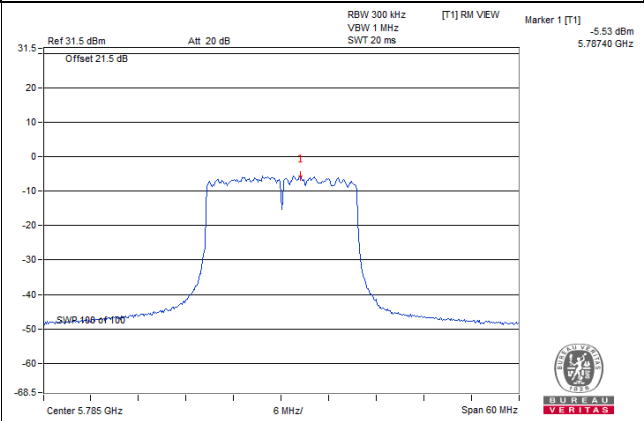

Spectrum Plot of Worst Value

802.11ax (HE40)_Chain 2 / CH151

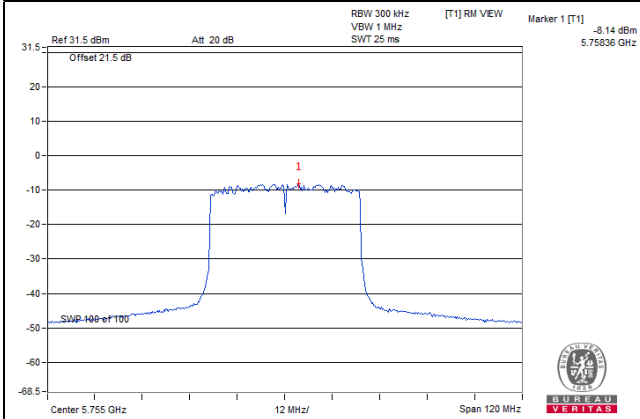

802.11ax (HE80)_Chain 2 / CH155

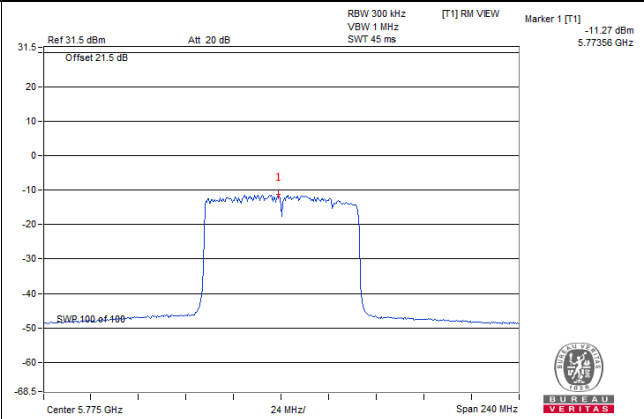

802.11ax (HE80+80)_Chain 5 / CH155

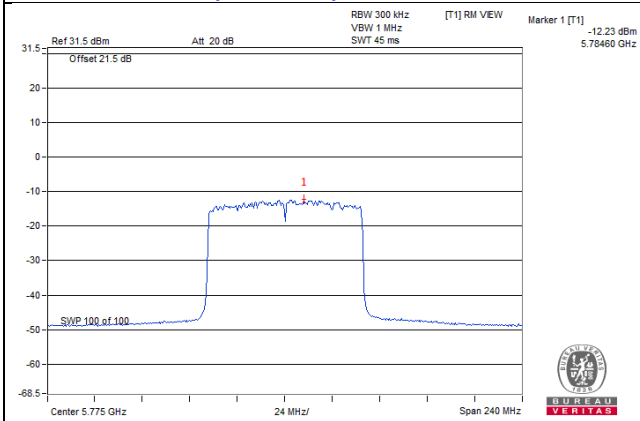

4.5.8 Test Results (Mode 2)

Non-Beamforming Mode

For U-NII-1:

802.11a

Chan.	Chan. Freq. (MHz)	PSD W/O Duty Factor (dBm/MHz)				Duty Factor (dB)	Total PSD With Duty Factor (dBm/MHz)	Max. Limit (dBm/MHz)	Pass / Fail
		Chain 4	Chain 5	Chain 6	Chain 7				
36	5180	4.04	4.28	4.76	4.11	0.36	10.69	12.27	Pass
40	5200	4.43	2.41	4.86	4.11	0.36	10.43	12.27	Pass
48	5240	4.69	1.90	4.08	4.89	0.36	10.42	12.27	Pass

- Note: 1. Method a) of power density measurement of KDB 662911 is using for calculating total power density. Total power density is summing entire spectra across corresponding frequency bins on the various outputs by computer.
2. The directional gain = 10.73dBi > 6dBi, so the power density limit shall be reduced to $17-(10.73-6) = 12.27$ dBm.
3. Refer to section 3.3 for duty cycle spectrum plot.

802.11ac (VHT20)

Chan.	Chan. Freq. (MHz)	PSD W/O Duty Factor (dBm/MHz)				Duty Factor (dB)	Total PSD With Duty Factor (dBm/MHz)	Max. Limit (dBm/MHz)	Pass / Fail
		Chain 4	Chain 5	Chain 6	Chain 7				
36	5180	2.63	3.33	2.57	4.01	0.20	9.40	12.27	Pass
40	5200	3.29	4.26	3.70	3.09	0.20	9.83	12.27	Pass
48	5240	3.97	3.30	4.96	4.41	0.20	10.42	12.27	Pass

- Note: 1. Method a) of power density measurement of KDB 662911 is using for calculating total power density. Total power density is summing entire spectra across corresponding frequency bins on the various outputs by computer.
2. The directional gain = 10.73dBi > 6dBi, so the power density limit shall be reduced to $17-(10.73-6) = 12.27$ dBm.
3. Refer to section 3.3 for duty cycle spectrum plot.

802.11ac (VHT40)

Chan.	Chan. Freq. (MHz)	PSD W/O Duty Factor (dBm/MHz)				Duty Factor (dB)	Total PSD With Duty Factor (dBm/MHz)	Max. Limit (dBm/MHz)	Pass / Fail
		Chain 4	Chain 5	Chain 6	Chain 7				
38	5190	-2.11	-4.91	-2.02	-2.52	0.22	3.50	12.27	Pass
46	5230	2.72	2.69	3.49	2.66	0.22	9.14	12.27	Pass

- Note: 1. Method a) of power density measurement of KDB 662911 is using for calculating total power density. Total power density is summing entire spectra across corresponding frequency bins on the various outputs by computer.
2. The directional gain = 10.73dBi > 6dBi, so the power density limit shall be reduced to $17-(10.73-6) = 12.27$ dBm.
3. Refer to section 3.3 for duty cycle spectrum plot.

802.11ac (VHT80)

Chan.	Chan. Freq. (MHz)	PSD W/O Duty Factor (dBm/MHz)				Duty Factor (dB)	Total PSD With Duty Factor (dBm/MHz)	Max. Limit (dBm/MHz)	Pass / Fail
		Chain 4	Chain 5	Chain 6	Chain 7				
42	5210	-6.18	-7.26	-7.72	-6.30	0.19	-0.61	12.27	Pass

- Note: 1. Method a) of power density measurement of KDB 662911 is using for calculating total power density. Total power density is summing entire spectra across corresponding frequency bins on the various outputs by computer.
2. The directional gain = 10.73dBi > 6dBi, so the power density limit shall be reduced to $17-(10.73-6) = 12.27$ dBm.
3. Refer to section 3.3 for duty cycle spectrum plot.

802.11ac (VHT80+80)

Chan.	Chan. Freq. (MHz)	PSD W/O Duty Factor (dBm/MHz)				Duty Factor (dB)	Total PSD With Duty Factor (dBm/MHz)	Max. Limit (dBm/MHz)	Pass / Fail
		Chain 4	Chain 5	Chain 6	Chain 7				
42+155	5210	-7.12	-5.21	-	-	0.36	-2.69	12.27	Pass
	5775	Test results refer to U_NII-3 data							

- Note: 1. Method a) of power density measurement of KDB 662911 is using for calculating total power density. Total power density is summing entire spectra across corresponding frequency bins on the various outputs by computer.
2. The directional gain = 10.73dBi > 6dBi, so the power density limit shall be reduced to $17-(10.73-6) = 12.27$ dBm.
3. Refer to section 3.3 for duty cycle spectrum plot.

802.11ax (HE20)

Chan.	Chan. Freq. (MHz)	PSD W/O Duty Factor (dBm/MHz)				Duty Factor (dB)	Total PSD With Duty Factor (dBm/MHz)	Max. Limit (dBm/MHz)	Pass / Fail
		Chain 4	Chain 5	Chain 6	Chain 7				
36	5180	3.43	2.74	4.24	3.65	0.20	9.77	12.27	Pass
40	5200	1.96	3.41	5.04	4.45	0.20	10.09	12.27	Pass
48	5240	4.29	4.59	5.26	3.89	0.20	10.76	12.27	Pass

- Note: 1. Method a) of power density measurement of KDB 662911 is using for calculating total power density. Total power density is summing entire spectra across corresponding frequency bins on the various outputs by computer.
2. The directional gain = 10.73dBi > 6dBi, so the power density limit shall be reduced to $17-(10.73-6) = 12.27\text{dBm}$.
3. Refer to section 3.3 for duty cycle spectrum plot.

802.11ax (HE40)

Chan.	Chan. Freq. (MHz)	PSD W/O Duty Factor (dBm/MHz)				Duty Factor (dB)	Total PSD With Duty Factor (dBm/MHz)	Max. Limit (dBm/MHz)	Pass / Fail
		Chain 4	Chain 5	Chain 6	Chain 7				
38	5190	-2.82	-4.20	-2.02	-1.79	0.16	3.57	12.27	Pass
46	5230	3.24	2.72	2.64	2.11	0.16	8.88	12.27	Pass

- Note: 1. Method a) of power density measurement of KDB 662911 is using for calculating total power density. Total power density is summing entire spectra across corresponding frequency bins on the various outputs by computer.
2. The directional gain = 10.73dBi > 6dBi, so the power density limit shall be reduced to $17-(10.73-6) = 12.27\text{dBm}$.
3. Refer to section 3.3 for duty cycle spectrum plot.

802.11ax (HE80)

Chan.	Chan. Freq. (MHz)	PSD W/O Duty Factor (dBm/MHz)				Duty Factor (dB)	Total PSD With Duty Factor (dBm/MHz)	Max. Limit (dBm/MHz)	Pass / Fail
		Chain 4	Chain 5	Chain 6	Chain 7				
42	5210	-4.78	-6.48	-5.27	-6.46	0.18	0.52	12.27	Pass

- Note: 1. Method a) of power density measurement of KDB 662911 is using for calculating total power density. Total power density is summing entire spectra across corresponding frequency bins on the various outputs by computer.
2. The directional gain = 10.73dBi > 6dBi, so the power density limit shall be reduced to $17-(10.73-6) = 12.27\text{dBm}$.
3. Refer to section 3.3 for duty cycle spectrum plot.

802.11ax (HE80+80)

Chan.	Chan. Freq. (MHz)	PSD W/O Duty Factor (dBm/MHz)				Duty Factor (dB)	Total PSD With Duty Factor (dBm/MHz)	Max. Limit (dBm/MHz)	Pass / Fail
		Chain 4	Chain 5	Chain 6	Chain 7				
42+155	5210	-5.99	-4.66	-	-	0.19	-2.08	12.27	Pass
	5775	Test results refer to U_NII-3 data							

- Note: 1. Method a) of power density measurement of KDB 662911 is using for calculating total power density. Total power density is summing entire spectra across corresponding frequency bins on the various outputs by computer.
2. The directional gain = 10.73dBi > 6dBi, so the power density limit shall be reduced to $17 - (10.73 - 6) = 12.27\text{dBm}$.
3. Refer to section 3.3 for duty cycle spectrum plot.

Spectrum Plot of Worst Value

802.11a_Chain 7 / CH48

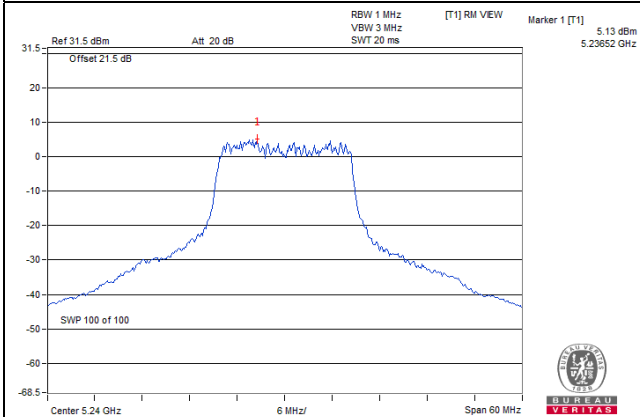

802.11ac (VHT20)_Chain 6 / CH48

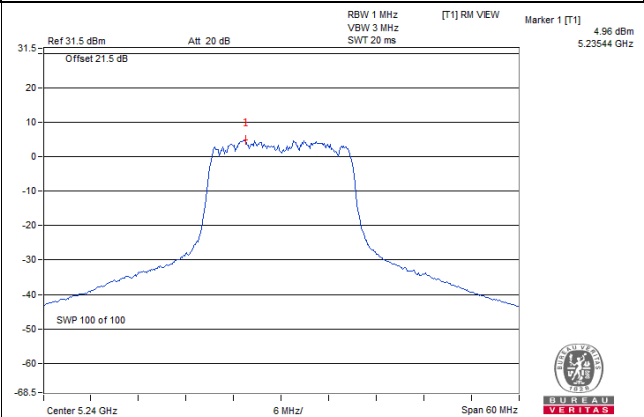

802.11ac (VHT40)_Chain 6 / CH46

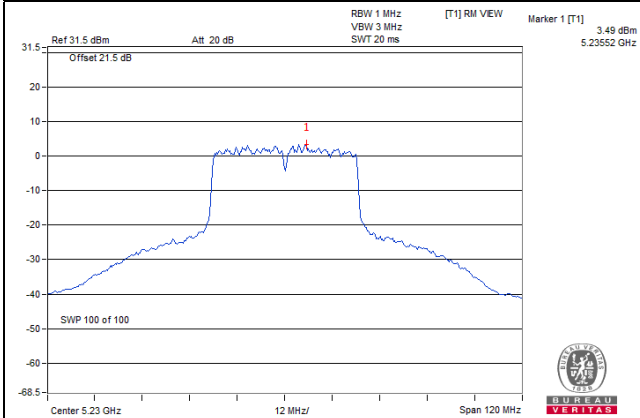

802.11ac (VHT80)_Chain 4 / CH42

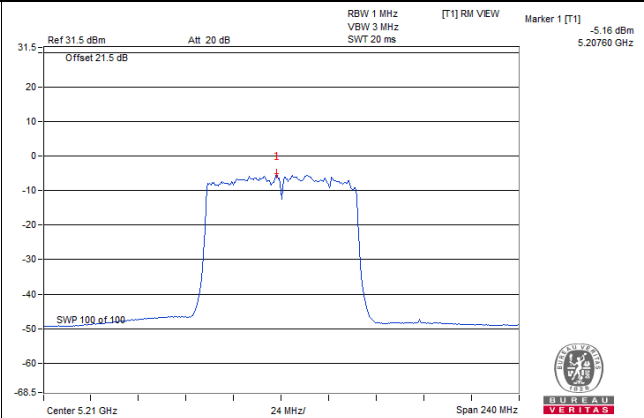

802.11ac (VHT80+80)_Chain 5 / CH42

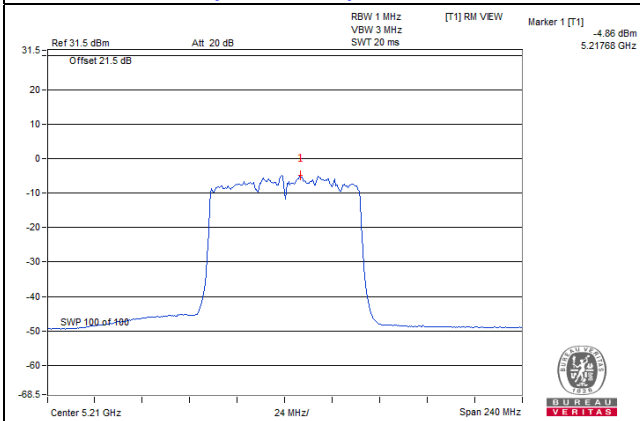

802.11ax (HE20)_Chain 6 / CH48

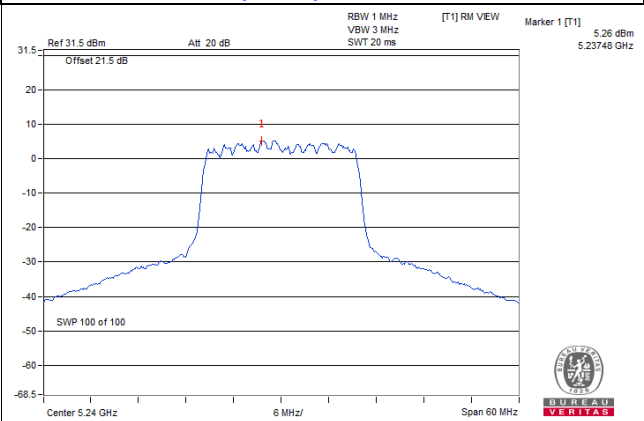

Spectrum Plot of Worst Value

802.11ax (HE40)_Chain 4 / CH46

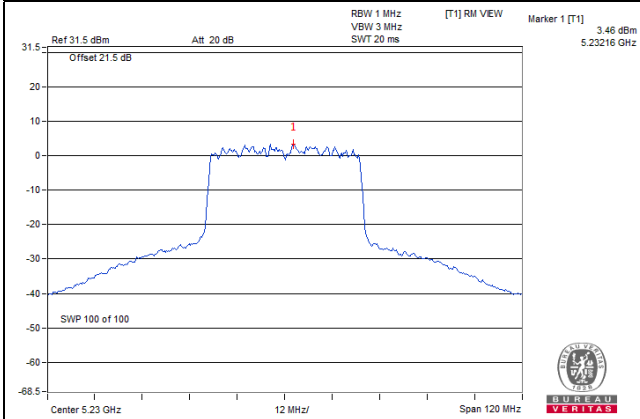

802.11ax (HE80)_Chain 4 / CH42

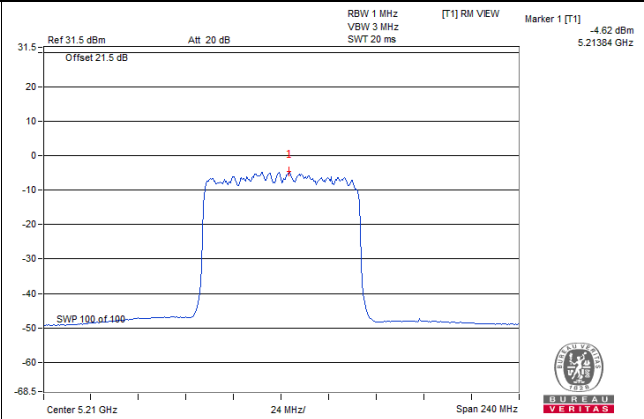

802.11ax (HE80+80)_Chain 5 / CH42

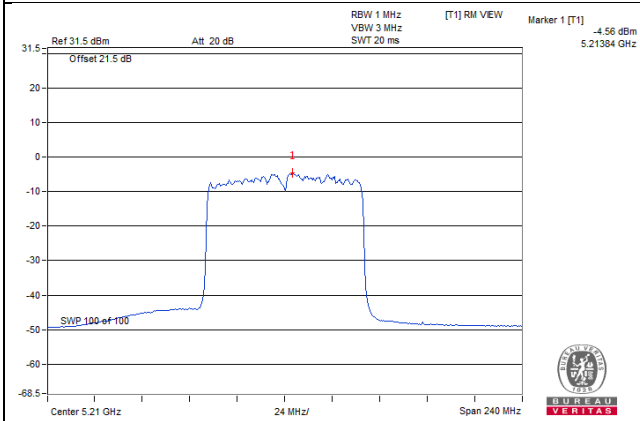

For U-NII-3:

802.11a

Chan.	Freq. (MHz)	PSD W/O Duty Factor (dBm/300kHz)				Duty Factor (dB)	Total PSD With Duty Factor		Total PSD With Duty Factor (dBm/500kHz)	Limit (dBm/500kHz)	Pass /Fail
		Chain 4	Chain 5	Chain 6	Chain 7		mW/300 kHz	dBm/300kHz			
149	5745	0.76	1.48	1.33	1.22	0.36	5.7408	7.59	9.81	25.32	Pass
157	5785	1.21	0.80	1.28	2.17	0.36	5.9958	7.78	10.00	25.32	Pass
165	5825	1.88	0.04	1.67	1.16	0.36	5.791	7.63	9.85	25.32	Pass

- Note: 1. Method b) Measure and sum spectral maxima across the outputs of KDB 662911 is using for calculating total power density.
 2. The directional gain = 10.68dBi > 6dBi, so the power density limit shall be reduced to $30-(10.68-6) = 25.32\text{dBm}$.
 3. Refer to section 3.3 for duty cycle spectrum plot.

802.11ac (VHT20)

Chan.	Freq. (MHz)	PSD W/O Duty Factor (dBm/300kHz)				Duty Factor (dB)	Total PSD With Duty Factor		Total PSD With Duty Factor (dBm/500kHz)	Limit (dBm/500kHz)	Pass /Fail
		Chain 4	Chain 5	Chain 6	Chain 7		mW/300 kHz	dBm/300kHz			
149	5745	0.18	0.92	1.94	0.94	0.20	5.327	7.26	9.48	25.32	Pass
157	5785	-0.51	1.21	1.80	0.27	0.20	5.018	7.01	9.23	25.32	Pass
165	5825	0.45	1.33	2.08	0.44	0.20	5.4375	7.35	9.57	25.32	Pass

- Note: 1. Method b) Measure and sum spectral maxima across the outputs of KDB 662911 is using for calculating total power density.
 2. The directional gain = 10.68dBi > 6dBi, so the power density limit shall be reduced to $30-(10.68-6) = 25.32\text{dBm}$.
 3. Refer to section 3.3 for duty cycle spectrum plot.

802.11ac (VHT40)

Chan.	Freq. (MHz)	PSD W/O Duty Factor (dBm/300kHz)				Duty Factor (dB)	Total PSD With Duty Factor		Total PSD With Duty Factor (dBm/500kHz)	Limit (dBm/500kHz)	Pass /Fail
		Chain 4	Chain 5	Chain 6	Chain 7		mW/300 kHz	dBm/300kHz			
151	5755	-3.63	-3.66	-3.53	-3.07	0.22	1.8928	2.77	4.99	25.32	Pass
159	5795	-3.93	-2.06	-2.68	-3.31	0.22	2.1369	3.30	5.52	25.32	Pass

- Note: 1. Method b) Measure and sum spectral maxima across the outputs of KDB 662911 is using for calculating total power density.
 2. The directional gain = 10.68dBi > 6dBi, so the power density limit shall be reduced to $30-(10.68-6) = 25.32\text{dBm}$.
 3. Refer to section 3.3 for duty cycle spectrum plot.

802.11ac (VHT80)

Chan.	Freq. (MHz)	PSD W/O Duty Factor (dBm/300kHz)				Duty Factor (dB)	Total PSD With Duty Factor		Total PSD With Duty Factor (dBm/500kHz)	Limit (dBm/500kHz)	Pass /Fail
		Chain 4	Chain 5	Chain 6	Chain 7		mW/300 kHz	dBm/300kHz			
155	5775	-9.73	-8.38	-8.26	-8.64	0.19	0.5613	-2.51	-0.29	25.32	Pass

- Note: 1. Method b) Measure and sum spectral maxima across the outputs of KDB 662911 is using for calculating total power density.
2. The directional gain = 10.68dBi > 6dBi, so the power density limit shall be reduced to 30-(10.68-6) = 25.32dBm.
3. Refer to section 3.3 for duty cycle spectrum plot.

802.11ac (VHT80+80)

Chan.	Freq. (MHz)	PSD W/O Duty Factor (dBm/300kHz)				Duty Factor (dB)	Total PSD With Duty Factor		Total PSD With Duty Factor (dBm/500kHz)	Limit (dBm/500kHz)	Pass /Fail
		Chain 4	Chain 5	Chain 6	Chain 7		mW/300 kHz	dBm/300kHz			
42+155	5210	Test results refer to U-NII-1 data									
	5775	-	-	-14.47	-13.54	0.36	0.08688	-10.61	-8.39	25.32	0.12454

- Note: 1. Method b) Measure and sum spectral maxima across the outputs of KDB 662911 is using for calculating total power density.
2. The directional gain = 10.68dBi > 6dBi, so the power density limit shall be reduced to 30-(10.68-6) = 25.32dBm.
3. Refer to section 3.3 for duty cycle spectrum plot.

802.11ax (HE20)

Chan.	Freq. (MHz)	PSD W/O Duty Factor (dBm/300kHz)				Duty Factor (dB)	Total PSD With Duty Factor		Total PSD With Duty Factor (dBm/500kHz)	Limit (dBm/500kHz)	Pass /Fail
		Chain 4	Chain 5	Chain 6	Chain 7		mW/300 kHz	dBm/300kHz			
149	5745	0.08	0.42	0.96	0.52	0.20	4.7076	6.73	8.95	25.32	Pass
157	5785	0.12	0.40	0.97	0.81	0.20	4.7967	6.81	9.03	25.32	Pass
165	5825	0.72	-0.33	1.00	0.61	0.20	4.7308	6.75	8.97	25.32	Pass

- Note: 1. Method b) Measure and sum spectral maxima across the outputs of KDB 662911 is using for calculating total power density.
2. The directional gain = 10.68dBi > 6dBi, so the power density limit shall be reduced to 30-(10.68-6) = 25.32dBm.
3. Refer to section 3.3 for duty cycle spectrum plot.

802.11ax (HE40)

Chan.	Freq. (MHz)	PSD W/O Duty Factor (dBm/300kHz)				Duty Factor (dB)	Total PSD With Duty Factor		Total PSD With Duty Factor (dBm/500kHz)	Limit (dBm/500kHz)	Pass /Fail
		Chain 4	Chain 5	Chain 6	Chain 7		mW/300 kHz	dBm/300kHz			
151	5755	-3.96	-3.85	-3.82	-3.60	0.16	1.728	2.38	4.60	25.32	Pass
159	5795	-3.28	-3.47	-3.68	-2.81	0.16	1.9422	2.88	5.10	25.32	Pass

- Note: 1. Method b) Measure and sum spectral maxima across the outputs of KDB 662911 is using for calculating total power density.
2. The directional gain = 10.68dBi > 6dBi, so the power density limit shall be reduced to $30-(10.68-6) = 25.32\text{dBm}$.
3. Refer to section 3.3 for duty cycle spectrum plot.

802.11ax (HE80)

Chan.	Freq. (MHz)	PSD W/O Duty Factor (dBm/300kHz)				Duty Factor (dB)	Total PSD With Duty Factor		Total PSD With Duty Factor (dBm/500kHz)	Limit (dBm/500kHz)	Pass /Fail
		Chain 4	Chain 5	Chain 6	Chain 7		mW/300 kHz	dBm/300kHz			
155	5775	-9.40	-8.30	-8.22	-7.51	0.18	0.6163	-2.10	0.12	25.32	Pass

- Note: 1. Method b) Measure and sum spectral maxima across the outputs of KDB 662911 is using for calculating total power density.
2. The directional gain = 10.68dBi > 6dBi, so the power density limit shall be reduced to $30-(10.68-6) = 25.32\text{dBm}$.
3. Refer to section 3.3 for duty cycle spectrum plot.

802.11ax (HE80+80)

Chan.	Freq. (MHz)	PSD W/O Duty Factor (dBm/300kHz)				Duty Factor (dB)	Total PSD With Duty Factor		Total PSD With Duty Factor (dBm/500kHz)	Limit (dBm/500kHz)	Pass /Fail
		Chain 4	Chain 5	Chain 6	Chain 7		mW/300 kHz	dBm/300kHz			
42+155	5210	Test results refer to U-NII-1 data									
	5775	-	-	-14.05	-13.87	0.19	0.08392	-10.76	-8.54	25.32	Pass

- Note: 1. Method b) Measure and sum spectral maxima across the outputs of KDB 662911 is using for calculating total power density.
2. The directional gain = 10.68dBi > 6dBi, so the power density limit shall be reduced to $30-(10.68-6) = 25.32\text{dBm}$.
3. Refer to section 3.3 for duty cycle spectrum plot.

Spectrum Plot of Worst Value

802.11a_Chain 7 / CH157

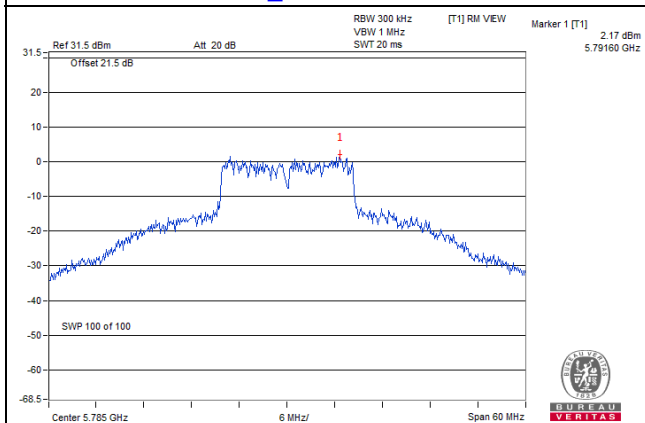

802.11ac (VHT20)_Chain 6 / CH165

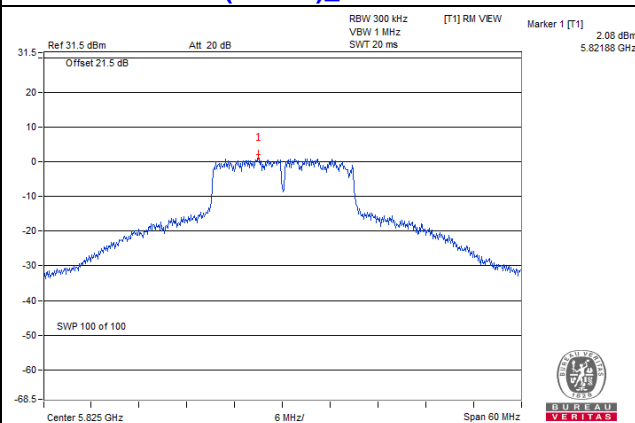

802.11ac (VHT40)_Chain 5 / CH159

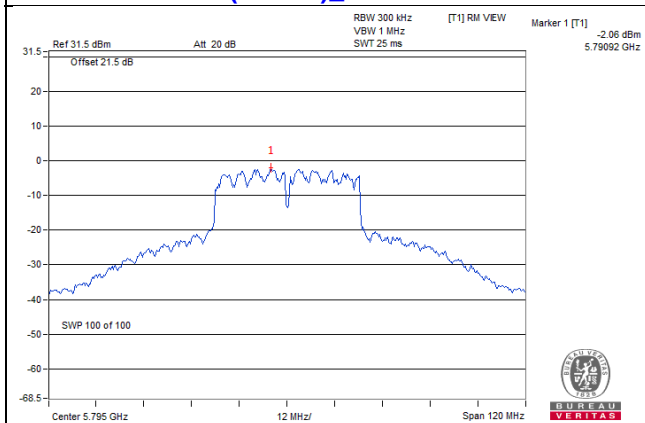

802.11ac (VHT80)_Chain 6 / CH155

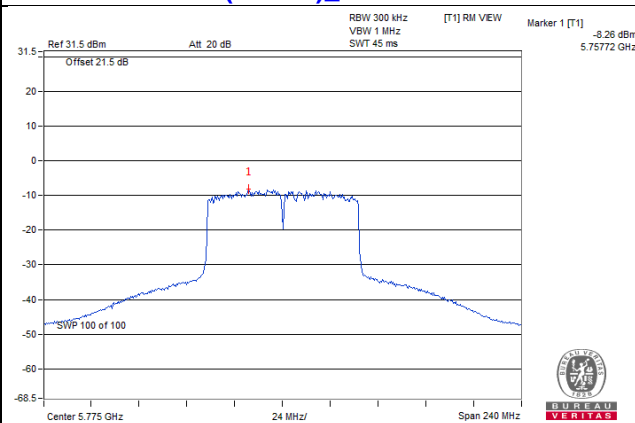

802.11ac (VHT80+80)_Chain 7 / CH155

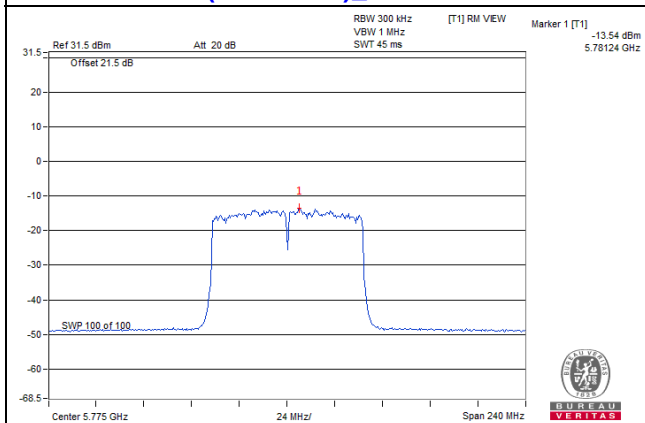

802.11ax (HE20)_Chain 6 / CH165

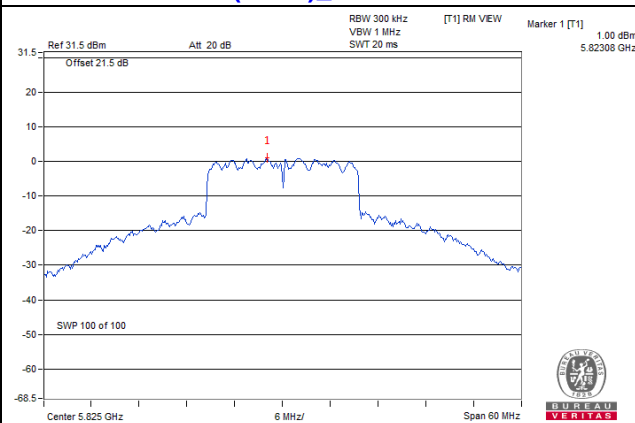

Spectrum Plot of Worst Value

802.11ax (HE40)_Chain 7 / CH159

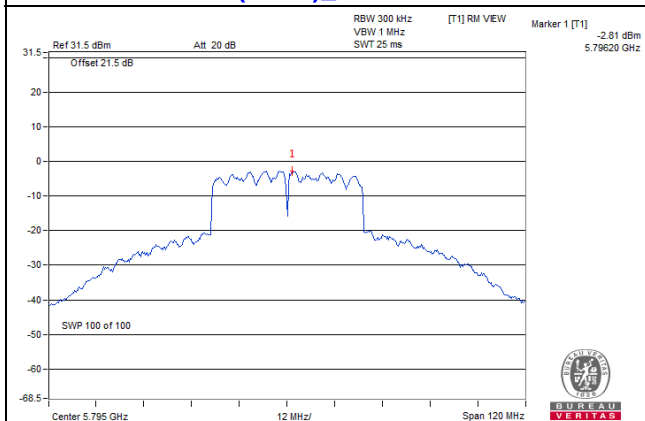

802.11ax (HE80)_Chain 7 / CH155

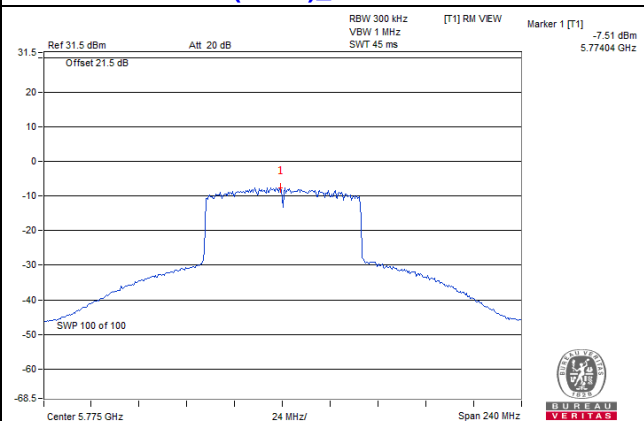

802.11ax (HE80+80)_Chain 7 / CH155

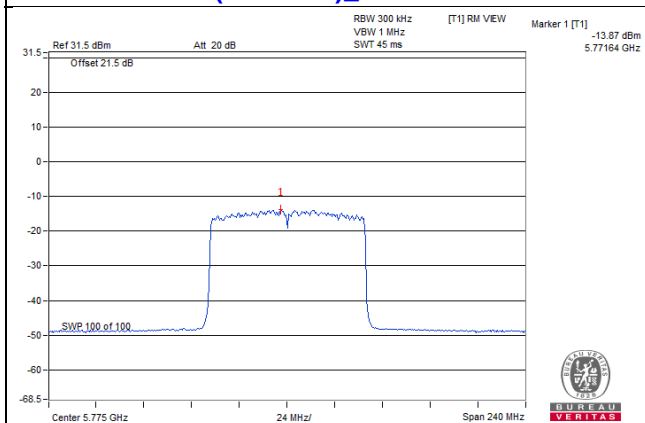

4.5.9 Test Results (Mode 3)

Non-Beamforming Mode

For U-NII-1:

802.11a

Chan.	Chan. Freq. (MHz)	PSD W/O Duty Factor (dBm/MHz)		Duty Factor (dB)	Total PSD With Duty Factor (dBm/MHz)	Max. Limit (dBm/MHz)	Pass / Fail
		Chain 1	Chain 2				
36	5180	5.76	6.41	0.36	9.47	14.53	Pass
40	5200	7.97	8.13	0.36	11.42	14.53	Pass
48	5240	6.06	6.89	0.36	9.87	14.53	Pass

- Note:
- Method a) of power density measurement of KDB 662911 is using for calculating total power density. Total power density is summing entire spectra across corresponding frequency bins on the various outputs by computer.
 - The directional gain = 8.47dBi > 6dBi, so the power density limit shall be reduced to $17-(8.47-6) = 14.53\text{dBm}$.
 - Refer to section 3.3 for duty cycle spectrum plot.

802.11ac (VHT20)

Chan.	Chan. Freq. (MHz)	PSD W/O Duty Factor (dBm/MHz)		Duty Factor (dB)	Total PSD With Duty Factor (dBm/MHz)	Max. Limit (dBm/MHz)	Pass / Fail
		Chain 1	Chain 2				
36	5180	4.78	5.32	0.20	8.27	14.53	Pass
40	5200	8.54	8.20	0.20	11.58	14.53	Pass
48	5240	5.57	6.90	0.20	9.50	14.53	Pass

- Note:
- Method a) of power density measurement of KDB 662911 is using for calculating total power density. Total power density is summing entire spectra across corresponding frequency bins on the various outputs by computer.
 - The directional gain = 8.47dBi > 6dBi, so the power density limit shall be reduced to $17-(8.47-6) = 14.53\text{dBm}$.
 - Refer to section 3.3 for duty cycle spectrum plot.

802.11ac (VHT40)

Chan.	Chan. Freq. (MHz)	PSD W/O Duty Factor (dBm/MHz)		Duty Factor (dB)	Total PSD With Duty Factor (dBm/MHz)	Max. Limit (dBm/MHz)	Pass / Fail
		Chain 1	Chain 2				
38	5190	-0.66	0.22	0.22	3.03	14.53	Pass
46	5230	2.67	3.60	0.22	6.39	14.53	Pass

- Note:
- Method a) of power density measurement of KDB 662911 is using for calculating total power density. Total power density is summing entire spectra across corresponding frequency bins on the various outputs by computer.
 - The directional gain = 8.47dBi > 6dBi, so the power density limit shall be reduced to $17-(8.47-6) = 14.53\text{dBm}$.
 - Refer to section 3.3 for duty cycle spectrum plot.

802.11ac (VHT80)

Chan.	Chan. Freq. (MHz)	PSD W/O Duty Factor (dBm/MHz)		Duty Factor (dB)	Total PSD With Duty Factor (dBm/MHz)	Max. Limit (dBm/MHz)	Pass / Fail
		Chain 1	Chain 2				
42	5210	-3.10	-4.27	0.19	-0.45	14.53	Pass

- Note:
- Method a) of power density measurement of KDB 662911 is using for calculating total power density. Total power density is summing entire spectra across corresponding frequency bins on the various outputs by computer.
 - The directional gain = 8.47dBi > 6dBi, so the power density limit shall be reduced to $17-(8.47-6) = 14.53\text{dBm}$.
 - Refer to section 3.3 for duty cycle spectrum plot.

802.11ax (HE20)

Chan.	Chan. Freq. (MHz)	PSD W/O Duty Factor (dBm/MHz)		Duty Factor (dB)	Total PSD With Duty Factor (dBm/MHz)	Max. Limit (dBm/MHz)	Pass / Fail
		Chain 1	Chain 2				
36	5180	4.19	5.12	0.20	7.89	14.53	Pass
40	5200	6.89	8.23	0.20	10.82	14.53	Pass
48	5240	5.54	6.45	0.20	9.23	14.53	Pass

- Note:
- Method a) of power density measurement of KDB 662911 is using for calculating total power density. Total power density is summing entire spectra across corresponding frequency bins on the various outputs by computer.
 - The directional gain = 8.47dBi > 6dBi, so the power density limit shall be reduced to $17-(8.47-6) = 14.53\text{dBm}$.
 - Refer to section 3.3 for duty cycle spectrum plot.

802.11ax (HE40)

Chan.	Chan. Freq. (MHz)	PSD W/O Duty Factor (dBm/MHz)		Duty Factor (dB)	Total PSD With Duty Factor (dBm/MHz)	Max. Limit (dBm/MHz)	Pass / Fail
		Chain 1	Chain 2				
38	5190	-0.23	-0.15	0.16	2.98	14.53	Pass
46	5230	3.05	2.80	0.16	6.10	14.53	Pass

- Note:
- Method a) of power density measurement of KDB 662911 is using for calculating total power density. Total power density is summing entire spectra across corresponding frequency bins on the various outputs by computer.
 - The directional gain = 8.47dBi > 6dBi, so the power density limit shall be reduced to $17-(8.47-6) = 14.53\text{dBm}$.
 - Refer to section 3.3 for duty cycle spectrum plot.

802.11ax (HE80)

Chan.	Chan. Freq. (MHz)	PSD W/O Duty Factor (dBm/MHz)		Duty Factor (dB)	Total PSD With Duty Factor (dBm/MHz)	Max. Limit (dBm/MHz)	Pass / Fail
		Chain 1	Chain 2				
42	5210	-3.58	-3.23	0.18	-0.21	14.53	Pass

- Note:
- Method a) of power density measurement of KDB 662911 is using for calculating total power density. Total power density is summing entire spectra across corresponding frequency bins on the various outputs by computer.
 - The directional gain = 8.47dBi > 6dBi, so the power density limit shall be reduced to $17-(8.47-6) = 14.53\text{dBm}$.
 - Refer to section 3.3 for duty cycle spectrum plot.

Spectrum Plot of Worst Value

802.11a_Chain 2 / CH40

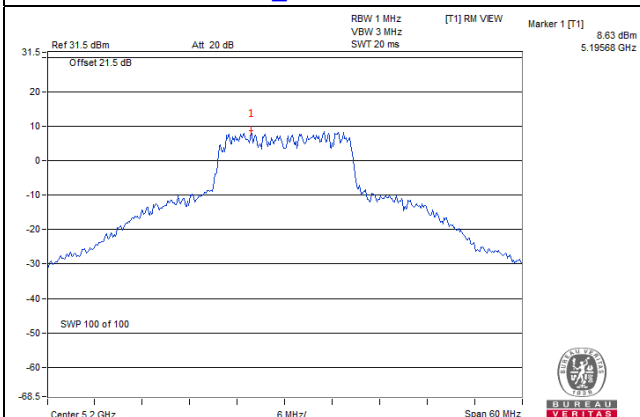

802.11ac (VHT20)_Chain 1 / CH40

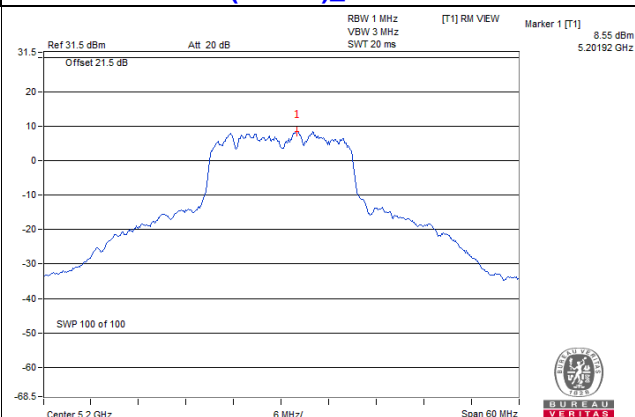

802.11ac (VHT40)_Chain 2 / CH46

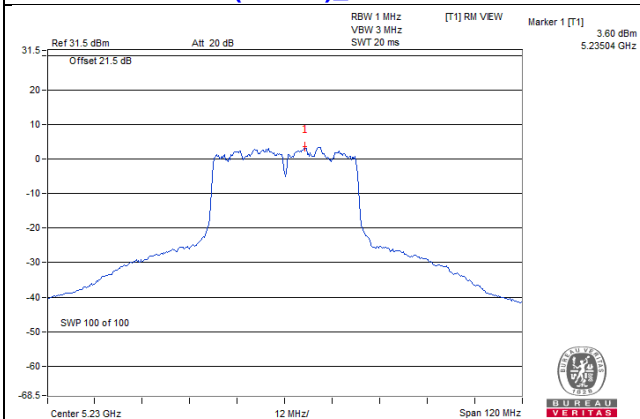

802.11ac (VHT80)_Chain 1 / CH42

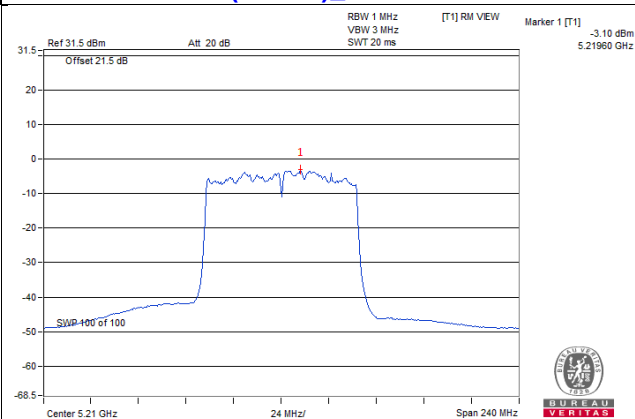

802.11ax (HE20)_Chain 2 / CH40

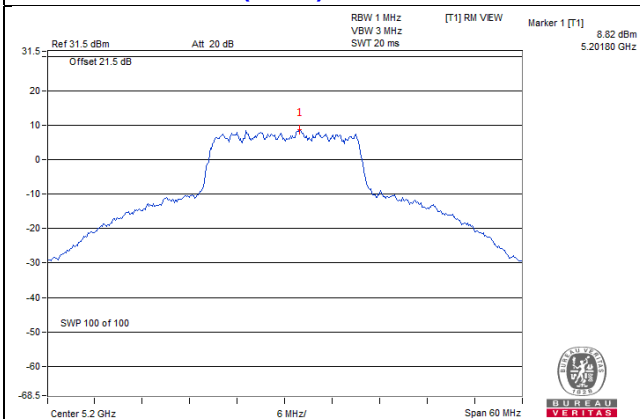

802.11ax (HE40)_Chain 1 / CH46

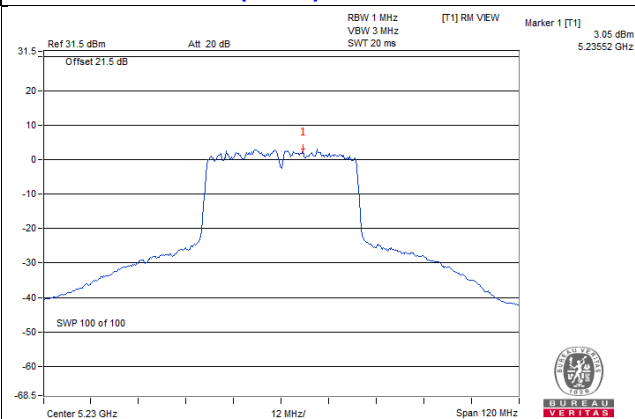

802.11ax (HE80)_Chain 2 / CH42

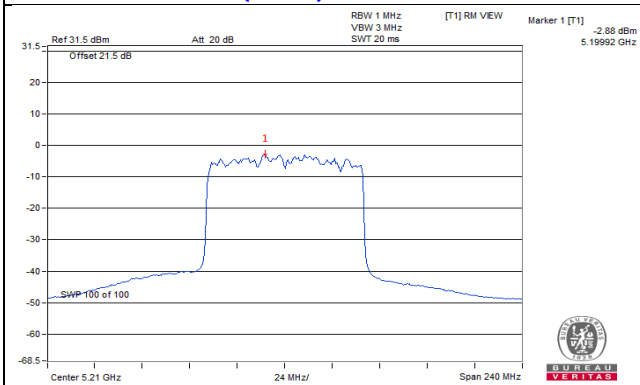

For U-NII-3:

802.11a

Chan.	Freq. (MHz)	PSD W/O Duty Factor (dBm/300kHz)		Duty Factor (dB)	Total PSD With Duty Factor		Total PSD With Duty Factor (dBm/500kHz)	Limit (dBm/500kHz)	Pass /Fail
		Chain 1	Chain 2		mW/300kHz	dBm/300kHz			
149	5745	1.48	1.33	0.36	3.0057	4.78	7.00	27.41	Pass
157	5785	0.80	1.28	0.36	2.7672	4.42	6.64	27.41	Pass
165	5825	0.04	1.67	0.36	2.6945	4.30	6.52	27.41	Pass

- Note: 1. Method b) Measure and sum spectral maxima across the outputs of KDB 662911 is using for calculating total power density.
 2. The directional gain = 8.59dBi > 6dBi, so the power density limit shall be reduced to 30-(8.59-6) = 27.41dBm.
 3. Refer to section 3.3 for duty cycle spectrum plot.

802.11ac (VHT20)

Chan.	Freq. (MHz)	PSD W/O Duty Factor (dBm/300kHz)		Duty Factor (dB)	Total PSD With Duty Factor		Total PSD With Duty Factor (dBm/500kHz)	Limit (dBm/500kHz)	Pass /Fail
		Chain 1	Chain 2		mW/300kHz	dBm/300kHz			
149	5745	0.92	1.94	0.20	2.9334	4.67	6.89	27.41	Pass
157	5785	1.21	1.80	0.20	2.9709	4.73	6.95	27.41	Pass
165	5825	1.33	2.08	0.20	3.1153	4.93	7.15	27.41	Pass

- Note: 1. Method b) Measure and sum spectral maxima across the outputs of KDB 662911 is using for calculating total power density.
 2. The directional gain = 8.59dBi > 6dBi, so the power density limit shall be reduced to 30-(8.59-6) = 27.41dBm.
 3. Refer to section 3.3 for duty cycle spectrum plot.

802.11ac (VHT40)

Chan.	Freq. (MHz)	PSD W/O Duty Factor (dBm/300kHz)		Duty Factor (dB)	Total PSD With Duty Factor		Total PSD With Duty Factor (dBm/500kHz)	Limit (dBm/500kHz)	Pass /Fail
		Chain 1	Chain 2		mW/300kHz	dBm/300kHz			
151	5755	-3.66	-3.53	0.22	0.9188	-0.37	1.85	27.41	Pass
159	5795	-2.06	-2.68	0.22	1.2212	0.87	3.09	27.41	Pass

- Note: 1. Method b) Measure and sum spectral maxima across the outputs of KDB 662911 is using for calculating total power density.
 2. The directional gain = 8.59dBi > 6dBi, so the power density limit shall be reduced to 30-(8.59-6) = 27.41dBm.
 3. Refer to section 3.3 for duty cycle spectrum plot.

802.11ac (VHT80)

Chan.	Freq. (MHz)	PSD W/O Duty Factor (dBm/300kHz)		Duty Factor (dB)	Total PSD With Duty Factor		Total PSD With Duty Factor (dBm/500kHz)	Limit (dBm/500kHz)	Pass /Fail
		Chain 1	Chain 2		mW/300kHz	dBm/300kHz			
155	5775	-8.38	-8.26	0.19	0.3074	-5.12	-2.90	27.41	Pass

- Note: 1. Method b) Measure and sum spectral maxima across the outputs of KDB 662911 is using for calculating total power density.
2. The directional gain = 8.59dBi > 6dBi, so the power density limit shall be reduced to $30-(8.59-6) = 27.41\text{dBm}$.
3. Refer to section 3.3 for duty cycle spectrum plot.

802.11ax (HE20)

Chan.	Freq. (MHz)	PSD W/O Duty Factor (dBm/300kHz)		Duty Factor (dB)	Total PSD With Duty Factor		Total PSD With Duty Factor (dBm/500kHz)	Limit (dBm/500kHz)	Pass /Fail
		Chain 1	Chain 2		mW/300kHz	dBm/300kHz			
149	5745	0.42	0.96	0.20	2.4602	3.91	6.13	27.41	Pass
157	5785	0.40	0.97	0.20	2.4579	3.91	6.13	27.41	Pass
165	5825	-0.33	1.00	0.20	2.2893	3.60	5.82	27.41	Pass

- Note: 1. Method b) Measure and sum spectral maxima across the outputs of KDB 662911 is using for calculating total power density.
2. The directional gain = 8.59dBi > 6dBi, so the power density limit shall be reduced to $30-(8.59-6) = 27.41\text{dBm}$.
3. Refer to section 3.3 for duty cycle spectrum plot.

802.11ax (HE40)

Chan.	Freq. (MHz)	PSD W/O Duty Factor (dBm/300kHz)		Duty Factor (dB)	Total PSD With Duty Factor		Total PSD With Duty Factor (dBm/500kHz)	Limit (dBm/500kHz)	Pass /Fail
		Chain 1	Chain 2		mW/300kHz	dBm/300kHz			
151	5755	-3.85	-3.82	0.16	0.8582	-0.66	1.56	27.41	Pass
159	5795	-3.47	-3.68	0.16	0.9114	-0.40	1.82	27.41	Pass

- Note: 1. Method b) Measure and sum spectral maxima across the outputs of KDB 662911 is using for calculating total power density.
2. The directional gain = 8.59dBi > 6dBi, so the power density limit shall be reduced to $30-(8.59-6) = 27.41\text{dBm}$.
3. Refer to section 3.3 for duty cycle spectrum plot.

802.11ax (HE80)

Chan.	Freq. (MHz)	PSD W/O Duty Factor (dBm/300kHz)		Duty Factor (dB)	Total PSD With Duty Factor		Total PSD With Duty Factor (dBm/500kHz)	Limit (dBm/500kHz)	Pass /Fail
		Chain 1	Chain 2		mW/300kHz	dBm/300kHz			
155	5775	-8.30	-8.22	0.18	0.3115	-5.07	-2.85	27.41	Pass

- Note: 1. Method b) Measure and sum spectral maxima across the outputs of KDB 662911 is using for calculating total power density.
2. The directional gain = 8.59dBi > 6dBi, so the power density limit shall be reduced to $30 - (8.59 - 6) = 27.41\text{dBm}$.
3. Refer to section 3.3 for duty cycle spectrum plot.

Spectrum Plot of Worst Value

802.11a_Chain 2 / CH165

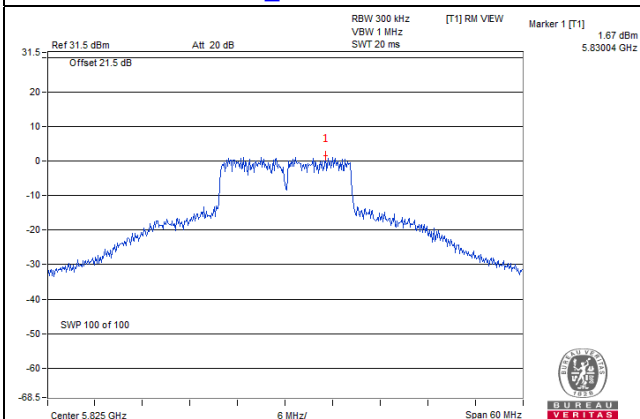

802.11ac (VHT20)_Chain 2 / CH165

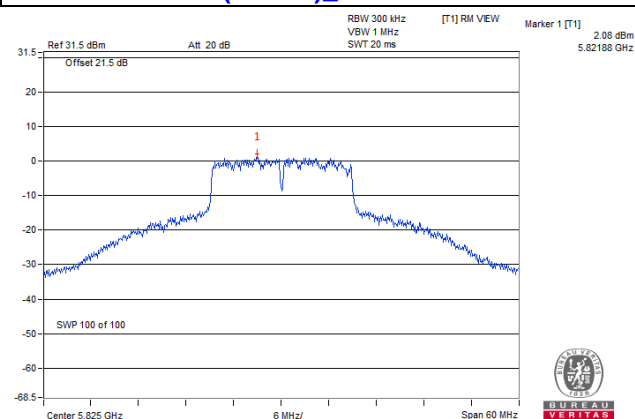

802.11ac (VHT40)_Chain 1 / CH159

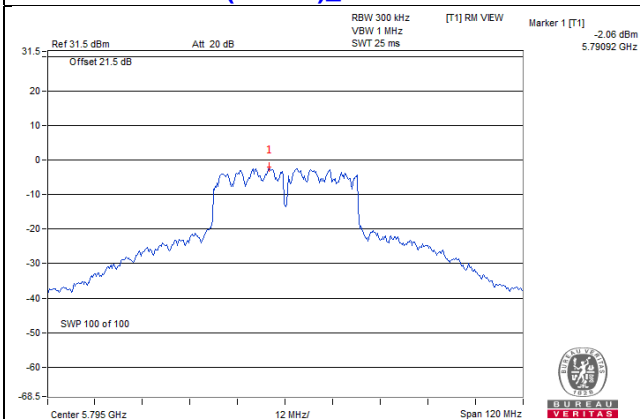

802.11ac (VHT80)_Chain 2 / CH155

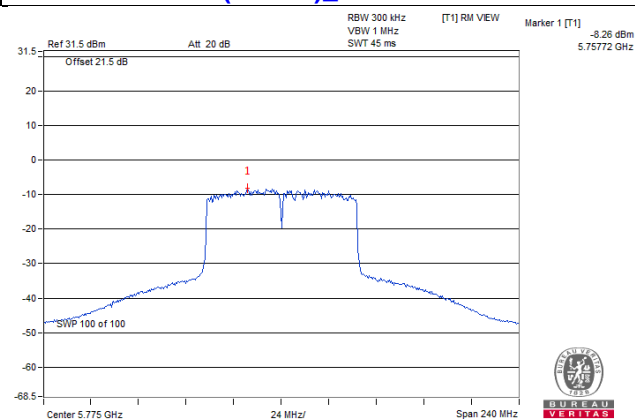

802.11ax (HE20)_Chain 2 / CH165

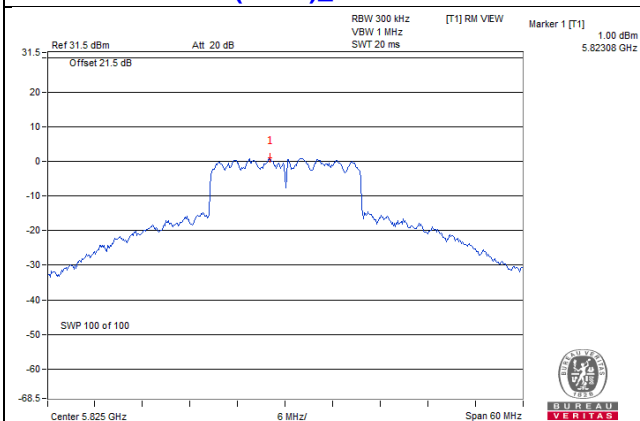

802.11ax (HE40)_Chain 1 / CH159

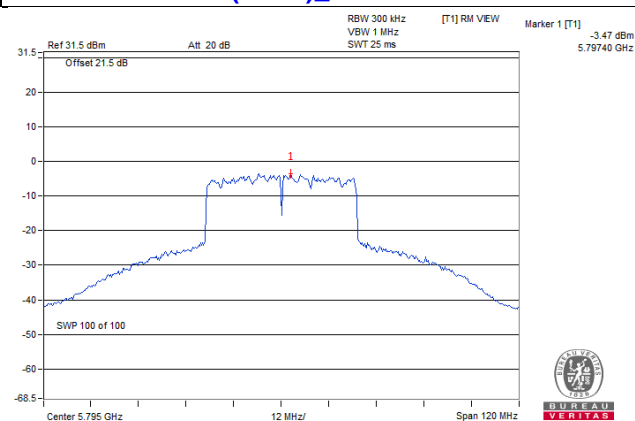

802.11ax (HE80)_Chain 2 / CH155

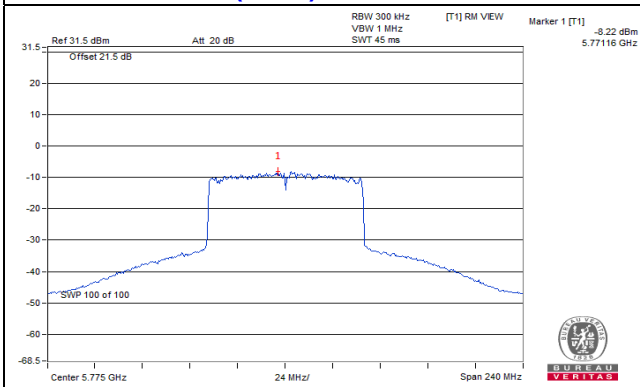

4.5.10 Test Results (Mode 4)

Non-Beamforming Mode

802.11a

Chan.	Chan. Freq. (MHz)	PSD W/O Duty Factor (dBm/MHz)	Duty Factor (dB)	PSD With Duty Factor (dBm/MHz)	Max. Limit (dBm/MHz)	Pass / Fail
36	5180	6.75	0.36	7.11	16.80	Pass
40	5200	8.68	0.36	9.04	16.80	Pass
48	5240	6.63	0.36	6.99	16.80	Pass

Note: 1. The max gain = 6.2dBi > 6dBi, so the power density limit shall be reduced to $17-(6.2-6) = 16.8$ dBm.
 2. Refer to section 3.3 for duty cycle spectrum plot.

802.11ac (VHT20)

Chan.	Chan. Freq. (MHz)	PSD W/O Duty Factor (dBm/MHz)	Duty Factor (dB)	PSD With Duty Factor (dBm/MHz)	Max. Limit (dBm/MHz)	Pass / Fail
36	5180	5.89	0.20	6.09	16.80	Pass
40	5200	8.67	0.20	8.87	16.80	Pass
48	5240	7.25	0.20	7.45	16.80	Pass

Note: 1. The max gain = 6.2dBi > 6dBi, so the power density limit shall be reduced to $17-(6.2-6) = 16.8$ dBm.
 2. Refer to section 3.3 for duty cycle spectrum plot.

802.11ac (VHT40)

Chan.	Chan. Freq. (MHz)	PSD W/O Duty Factor (dBm/MHz)	Duty Factor (dB)	PSD With Duty Factor (dBm/MHz)	Max. Limit (dBm/MHz)	Pass / Fail
38	5190	1.08	0.22	1.30	16.80	Pass
46	5230	4.05	0.22	4.27	16.80	Pass

Note: 1. The max gain = 6.2dBi > 6dBi, so the power density limit shall be reduced to $17-(6.2-6) = 16.8$ dBm.
 2. Refer to section 3.3 for duty cycle spectrum plot.

802.11ac (VHT80)

Chan.	Chan. Freq. (MHz)	PSD W/O Duty Factor (dBm/MHz)	Duty Factor (dB)	PSD With Duty Factor (dBm/MHz)	Max. Limit (dBm/MHz)	Pass / Fail
42	5210	-1.72	0.19	-1.53	16.80	Pass

Note: 1. The max gain = 6.2dBi > 6dBi, so the power density limit shall be reduced to $17-(6.2-6) = 16.8$ dBm.
 2. Refer to section 3.3 for duty cycle spectrum plot.

802.11ax (HE20)

Chan.	Chan. Freq. (MHz)	PSD W/O Duty Factor (dBm/MHz)	Duty Factor (dB)	PSD With Duty Factor (dBm/MHz)	Max. Limit (dBm/MHz)	Pass / Fail
36	5180	6.05	0.20	6.25	16.80	Pass
40	5200	8.61	0.20	8.81	16.80	Pass
48	5240	6.84	0.20	7.04	16.80	Pass

Note: 1. The max gain = 6.2dBi > 6dBi, so the power density limit shall be reduced to $17-(6.2-6) = 16.8$ dBm.
 2. Refer to section 3.3 for duty cycle spectrum plot.

802.11ax (HE40)

Chan.	Chan. Freq. (MHz)	PSD W/O Duty Factor (dBm/MHz)	Duty Factor (dB)	PSD With Duty Factor (dBm/MHz)	Max. Limit (dBm/MHz)	Pass / Fail
38	5190	1.35	0.16	1.51	16.80	Pass
46	5230	4.00	0.16	4.16	16.80	Pass

Note: 1. The max gain = 6.2dBi > 6dBi, so the power density limit shall be reduced to $17-(6.2-6) = 16.8$ dBm.
 2. Refer to section 3.3 for duty cycle spectrum plot.

802.11ax (HE80)

Chan.	Chan. Freq. (MHz)	PSD W/O Duty Factor (dBm/MHz)	Duty Factor (dB)	PSD With Duty Factor (dBm/MHz)	Max. Limit (dBm/MHz)	Pass / Fail
42	5210	-1.55	0.18	-1.37	16.80	Pass

Note: 1. The max gain = 6.2dBi > 6dBi, so the power density limit shall be reduced to $17-(6.2-6) = 16.8$ dBm.
 2. Refer to section 3.3 for duty cycle spectrum plot.

Spectrum Plot of Worst Value

802.11a / CH40

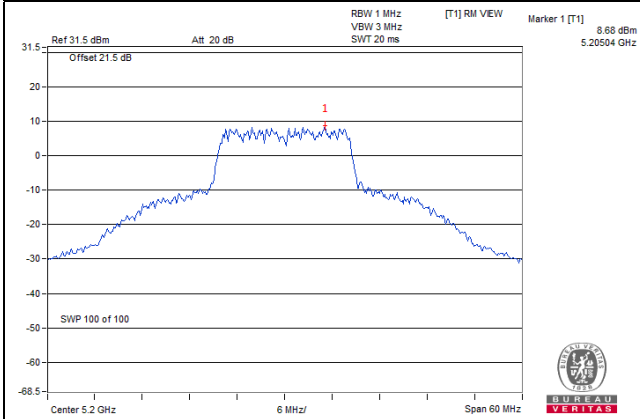

802.11ac (VHT20) / CH40

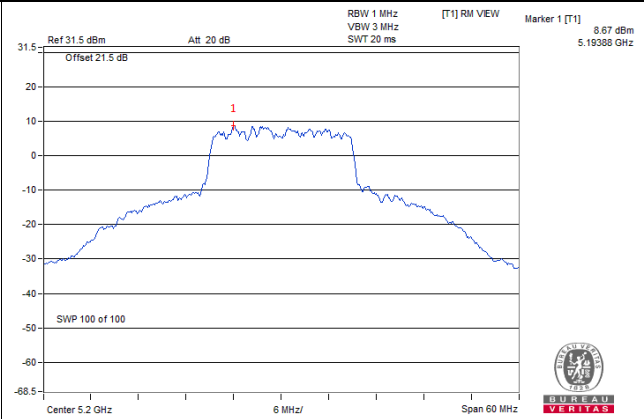

802.11ac (VHT40) / CH46

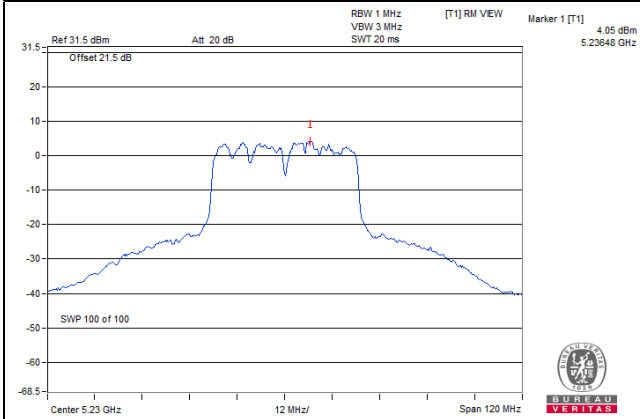

802.11ac (VHT80) / CH42

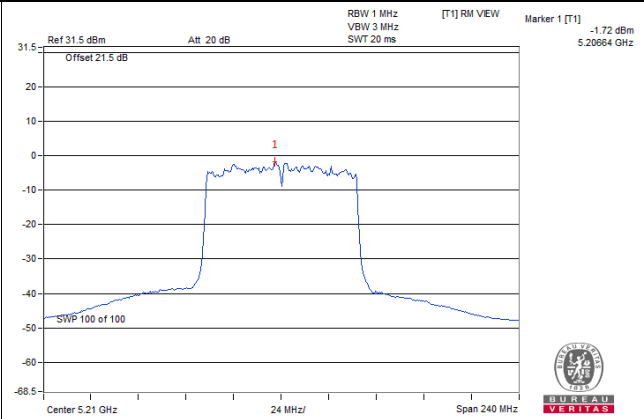

802.11ax (HE20) / CH40

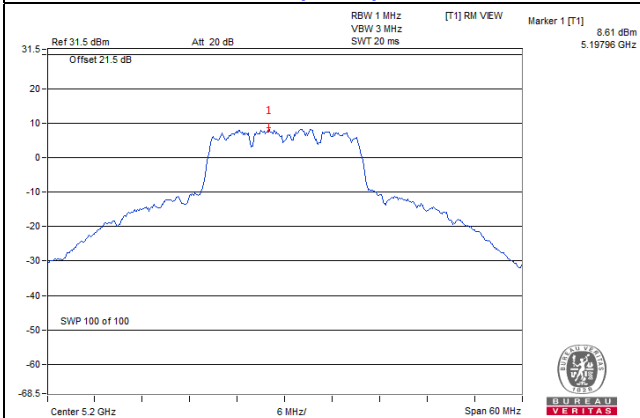

802.11ax (HE40) / CH46

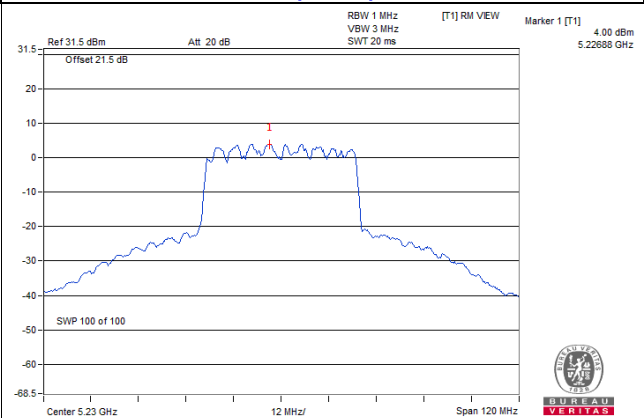

802.11ax (HE80) / CH42

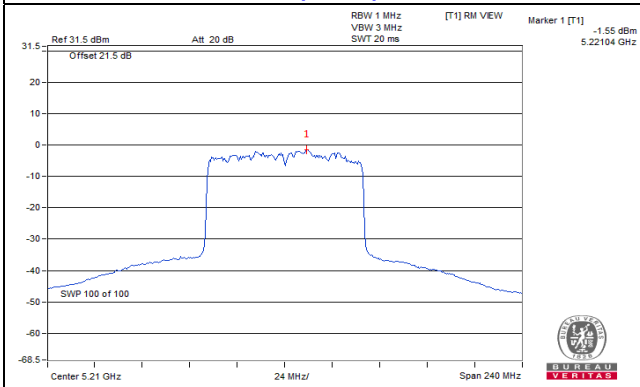

For U-NII-3:

802.11a

Chan.	Chan. Freq. (MHz)	PSD W/O Duty Factor (dBm/300kHz)	Duty Factor (dB)	Total PSD With Duty Factor		Total PSD With Duty Factor (dBm/500kHz)	Limit (dBm/500kHz)	Pass /Fail
				mW/300kHz	dBm/300kHz			
149	5745	1.33	0.36	1.4769	1.69	3.91	29.61	Pass
157	5785	1.28	0.36	1.46	1.64	3.86	29.61	Pass
165	5825	1.67	0.36	1.5971	2.03	4.25	29.61	Pass

Note: 1. The max gain = 6.39dBi > 6dBi, so the power density limit shall be reduced to $30-(6.39-6) = 29.61\text{dBm}$.

2. Refer to section 3.3 for duty cycle spectrum plot.

802.11ac (VHT20)

Chan.	Chan. Freq. (MHz)	PSD W/O Duty Factor (dBm/300kHz)	Duty Factor (dB)	Total PSD With Duty Factor		Total PSD With Duty Factor (dBm/500kHz)	Limit (dBm/500kHz)	Pass /Fail
				mW/300kHz	dBm/300kHz			
149	5745	1.94	0.20	1.6382	2.14	4.36	29.61	Pass
157	5785	1.80	0.20	1.5862	2.00	4.22	29.61	Pass
165	5825	2.08	0.20	1.6918	2.28	4.50	29.61	Pass

Note: 1. The max gain = 6.39dBi > 6dBi, so the power density limit shall be reduced to $30-(6.39-6) = 29.61\text{dBm}$.

2. Refer to section 3.3 for duty cycle spectrum plot.

802.11ac (VHT40)

Chan.	Chan. Freq. (MHz)	PSD W/O Duty Factor (dBm/300kHz)	Duty Factor (dB)	Total PSD With Duty Factor		Total PSD With Duty Factor (dBm/500kHz)	Limit (dBm/500kHz)	Pass /Fail
				mW/300kHz	dBm/300kHz			
151	5755	-3.35	0.22	0.486	-3.13	-0.91	29.61	Pass
159	5795	-2.81	0.22	0.5503	-2.59	-0.37	29.61	Pass

Note: 1. The max gain = 6.39dBi > 6dBi, so the power density limit shall be reduced to $30-(6.39-6) = 29.61\text{dBm}$.

2. Refer to section 3.3 for duty cycle spectrum plot.

802.11ac (VHT80)

Chan.	Chan. Freq. (MHz)	PSD W/O Duty Factor (dBm/300kHz)	Duty Factor (dB)	Total PSD With Duty Factor		Total PSD With Duty Factor (dBm/500kHz)	Limit (dBm/500kHz)	Pass /Fail
				mW/300kHz	dBm/300kHz			
155	5775	-7.51	0.19	0.1852	-7.32	-5.10	29.61	Pass

Note: 1. The max gain = 6.39dBi > 6dBi, so the power density limit shall be reduced to $30-(6.39-6) = 29.61\text{dBm}$.

2. Refer to section 3.3 for duty cycle spectrum plot.

802.11ax (HE20)

Chan.	Chan. Freq. (MHz)	PSD W/O Duty Factor (dBm/300kHz)	Duty Factor (dB)	Total PSD With Duty Factor		Total PSD With Duty Factor (dBm/500kHz)	Limit (dBm/500kHz)	Pass /Fail
				mW/300kHz	dBm/300kHz			
149	5745	0.96	0.20	1.3065	1.16	3.38	29.61	Pass
157	5785	0.97	0.20	1.3095	1.17	3.39	29.61	Pass
165	5825	1.00	0.20	1.3186	1.20	3.42	29.61	Pass

Note: 1. The max gain = 6.39dBi > 6dBi, so the power density limit shall be reduced to $30-(6.39-6) = 29.61\text{dBm}$.
 2. Refer to section 3.3 for duty cycle spectrum plot.

802.11ax (HE40)

Chan.	Chan. Freq. (MHz)	PSD W/O Duty Factor (dBm/300kHz)	Duty Factor (dB)	Total PSD With Duty Factor		Total PSD With Duty Factor (dBm/500kHz)	Limit (dBm/500kHz)	Pass /Fail
				mW/300kHz	dBm/300kHz			
151	5755	-3.20	0.16	0.4966	-3.04	-0.82	29.61	Pass
159	5795	-2.50	0.16	0.5835	-2.34	-0.12	29.61	Pass

Note: 1. The max gain = 6.39dBi > 6dBi, so the power density limit shall be reduced to $30-(6.39-6) = 29.61\text{dBm}$.
 2. Refer to section 3.3 for duty cycle spectrum plot.

802.11ax (HE80)

Chan.	Chan. Freq. (MHz)	PSD W/O Duty Factor (dBm/300kHz)	Duty Factor (dB)	Total PSD With Duty Factor		Total PSD With Duty Factor (dBm/500kHz)	Limit (dBm/500kHz)	Pass /Fail
				mW/300kHz	dBm/300kHz			
155	5775	-7.42	0.18	0.1889	-7.24	-5.02	29.61	Pass

Note: 1. The max gain = 6.39dBi > 6dBi, so the power density limit shall be reduced to $30-(6.39-6) = 29.61\text{dBm}$.
 2. Refer to section 3.3 for duty cycle spectrum plot.

Spectrum Plot of Worst Value

802.11a / CH165

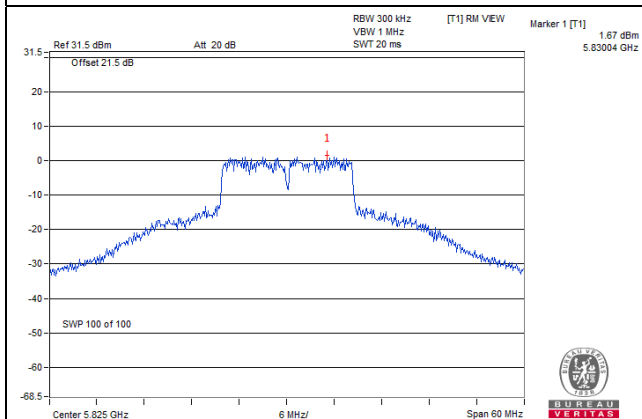

802.11ac (VHT20) / CH165

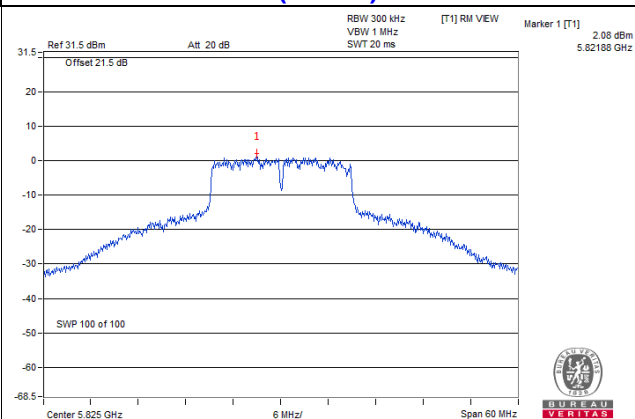

802.11ac (VHT40) / CH159

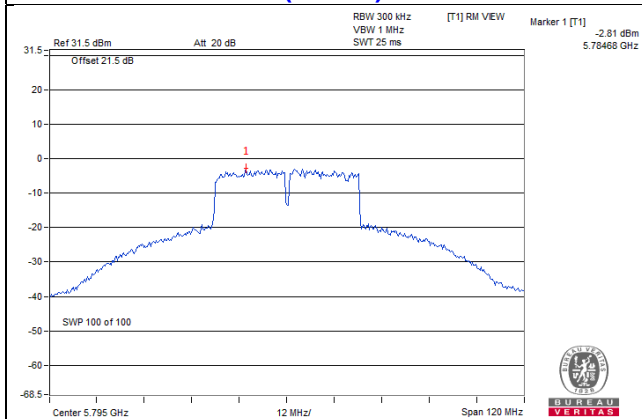

802.11ac (VHT80) / CH155

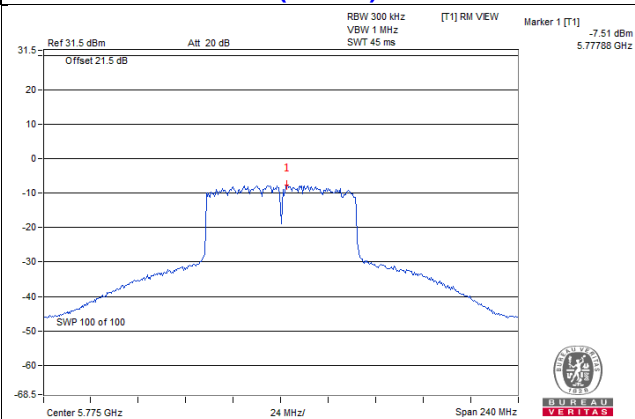

802.11ax (HE20) / CH165

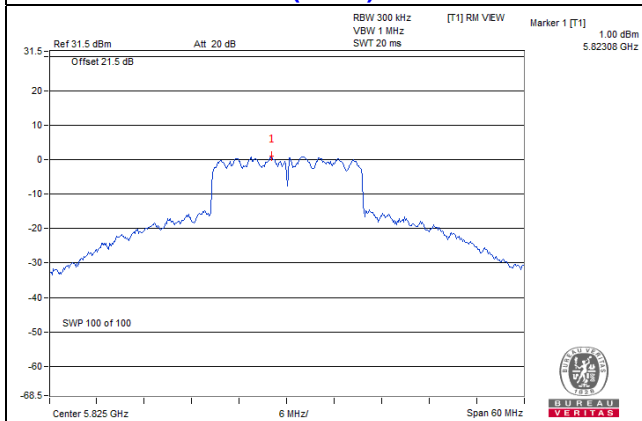

802.11ax (HE40) / CH159

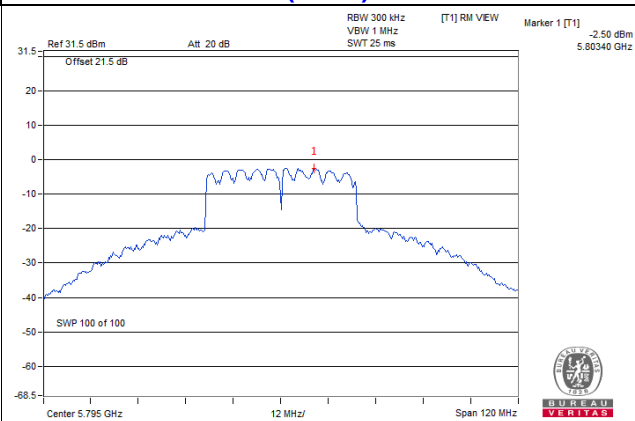

802.11ax (HE80) / CH155

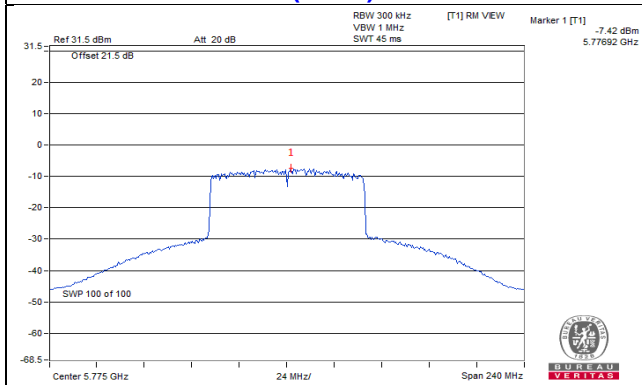

4.6 Frequency Stability Measurement

4.6.1 Limits of Frequency Stability Measurement

The frequency of the carrier signal shall be maintained within band of operation

4.6.2 Test Setup

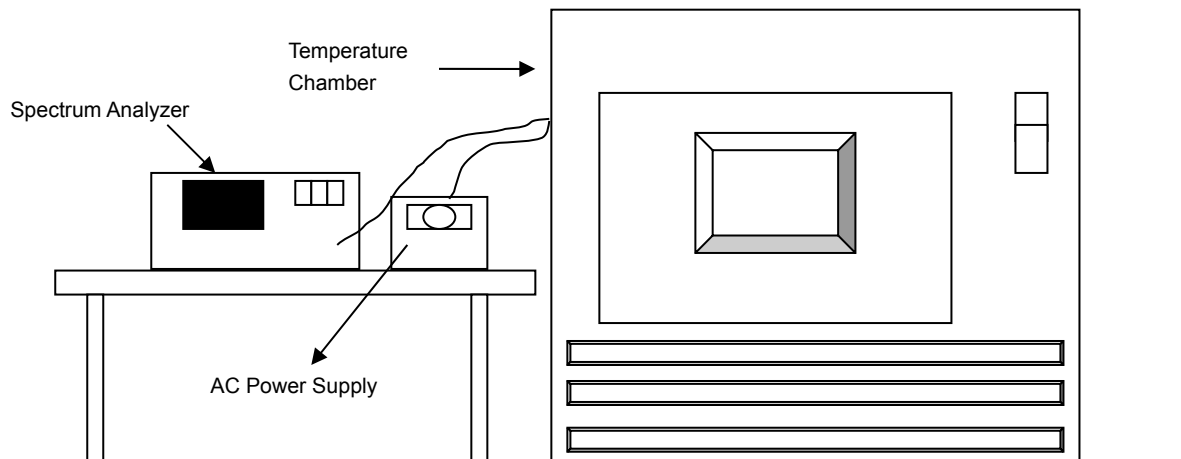

4.6.3 Test Instruments

Refer to section 4.1.2 to get information of above instrument.

4.6.4 Test Procedure

- The EUT was placed inside the environmental test chamber and powered by nominal AC voltage.
- Turn the EUT on and couple its output to a spectrum analyzer.
- Turn the EUT off and set the chamber to the highest temperature specified.
- Allow sufficient time (approximately 30 min) for the temperature of the chamber to stabilize, turn the EUT on and measure the operating frequency after 2, 5, and 10 Minutes.
- Repeat step 2 and 3 with the temperature chamber set to the lowest temperature.
- The test chamber was allowed to stabilize at +20 degree C for a minimum of 30 Minutes. The supply voltage was then adjusted on the EUT from 85% to 115% and the frequency record.

4.6.5 Deviation from Test Standard

No deviation.

4.6.6 EUT Operating Condition

Set the EUT transmit at un-modulation mode to test frequency stability.

4.6.7 Test Results

Frequency Stability Versus Temp.									
Operating Frequency: 5180 MHz									
TEMP. (°C)	Power Supply (Vac)	0 Minute		2 Minutes		5 Minutes		10 Minutes	
		Measured Frequency (MHz)	Pass/Fail	Measured Frequency (MHz)	Pass/Fail	Measured Frequency (MHz)	Pass/Fail	Measured Frequency (MHz)	Pass/Fail
50	120	5179.9761	Pass	5179.9748	Pass	5179.9763	Pass	5179.9723	Pass
40	120	5179.9724	Pass	5179.976	Pass	5179.9717	Pass	5179.9755	Pass
30	120	5179.9734	Pass	5179.9767	Pass	5179.9745	Pass	5179.9748	Pass
20	120	5179.9952	Pass	5179.9946	Pass	5179.9958	Pass	5179.9964	Pass
10	120	5180.0106	Pass	5180.008	Pass	5180.0109	Pass	5180.0097	Pass
0	120	5180.0153	Pass	5180.0151	Pass	5180.019	Pass	5180.0179	Pass
-10	120	5179.9886	Pass	5179.989	Pass	5179.9872	Pass	5179.9904	Pass
-20	120	5180.0117	Pass	5180.0117	Pass	5180.0145	Pass	5180.01	Pass
-30	120	5179.9777	Pass	5179.9743	Pass	5179.9745	Pass	5179.9766	Pass

Frequency Stability Versus Voltage									
Operating Frequency: 5180 MHz									
TEMP. (°C)	Power Supply (Vac)	0 Minute		2 Minutes		5 Minutes		10 Minutes	
		Measured Frequency (MHz)	Pass/Fail	Measured Frequency (MHz)	Pass/Fail	Measured Frequency (MHz)	Pass/Fail	Measured Frequency (MHz)	Pass/Fail
20	138	5179.9958	PASS	5179.9956	PASS	5179.9968	PASS	5179.9961	Pass
	120	5179.9952	PASS	5179.9946	PASS	5179.9958	PASS	5179.9964	Pass
	102	5179.995	PASS	5179.995	PASS	5179.9949	PASS	5179.9965	Pass

4.7 6dB Bandwidth Measurement

4.7.1 Limits of 6dB Bandwidth Measurement

The minimum of 6dB Bandwidth Measurement is 0.5MHz.

4.7.2 Test Setup

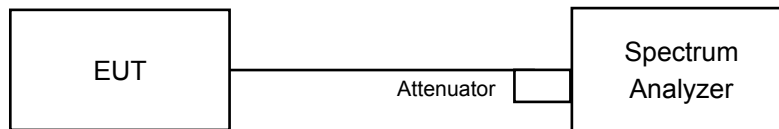

4.7.3 Test Instruments

Refer to section 4.1.2 to get information of above instrument.

4.7.4 Test Procedure

MEASUREMENT PROCEDURE REF

- Set resolution bandwidth (RBW) = 100kHz
- Set the video bandwidth (VBW) $\geq 3 \times$ RBW, Detector = Peak.
- Trace mode = max hold.
- Sweep = auto couple.
- Measure the maximum width of the emission that is constrained by the frequencies associated with the two amplitude points (upper and lower) that are attenuated by 6 dB relative to the maximum level measured in the fundamental emission

4.7.5 Deviation from Test Standard

No deviation.

4.7.6 EUT Operating Condition

The software provided by client to enable the EUT under transmission condition continuously at lowest, middle and highest channel frequencies individually.

4.7.7 Test Results (Mode 1)

Non-Beamforming Mode

802.11a

Channel	Frequency (MHz)	6dB Bandwidth (MHz)								Minimum Limit (MHz)	Pass / Fail
		Chain 0	Chain 1	Chain 2	Chain 3	Chain 4	Chain 5	Chain 6	Chain 7		
149	5745	16.35	16.41	15.78	16.38	15.19	16.40	15.78	15.76	0.5	Pass
157	5785	16.01	16.43	16.39	16.42	16.40	16.00	16.38	16.42	0.5	Pass
165	5825	16.37	16.41	15.80	16.41	16.39	16.00	15.99	16.38	0.5	Pass

802.11ax (HE20)

Channel	Frequency (MHz)	6dB Bandwidth (MHz)								Minimum Limit (MHz)	Pass / Fail
		Chain 0	Chain 1	Chain 2	Chain 3	Chain 4	Chain 5	Chain 6	Chain 7		
149	5745	18.22	18.56	18.75	18.74	19.05	18.86	19.01	18.52	0.5	Pass
157	5785	18.45	18.68	17.72	17.57	18.94	18.93	18.68	18.34	0.5	Pass
165	5825	18.77	18.26	18.92	18.96	18.78	18.78	18.89	18.53	0.5	Pass

802.11ax (HE40)

Channel	Frequency (MHz)	6dB Bandwidth (MHz)								Minimum Limit (MHz)	Pass / Fail
		Chain 0	Chain 1	Chain 2	Chain 3	Chain 4	Chain 5	Chain 6	Chain 7		
151	5755	37.28	34.03	37.34	34.00	35.18	38.05	38.05	37.97	0.5	Pass
159	5795	36.89	38.03	33.44	34.23	34.67	37.44	37.35	37.33	0.5	Pass

802.11ax (HE80)

Channel	Frequency (MHz)	6dB Bandwidth (MHz)								Minimum Limit (MHz)	Pass / Fail
		Chain 0	Chain 1	Chain 2	Chain 3	Chain 4	Chain 5	Chain 6	Chain 7		
155	5775	75.08	77.89	69.92	69.20	72.93	76.42	76.44	78.04	0.5	Pass

802.11ax (HE80+80)

Channel	Frequency (MHz)	6dB Bandwidth (MHz)								Minimum Limit (MHz)	Pass / Fail
		Chain 0	Chain 1	Chain 2	Chain 3	Chain 4	Chain 5	Chain 6	Chain 7		
42+155	5210	-									
	5775	-	-	-	-	70.41	77.60	75.33	77.47	0.5	Pass

Spectrum Plot of Worst Value

802.11a_Chain 4 / CH149

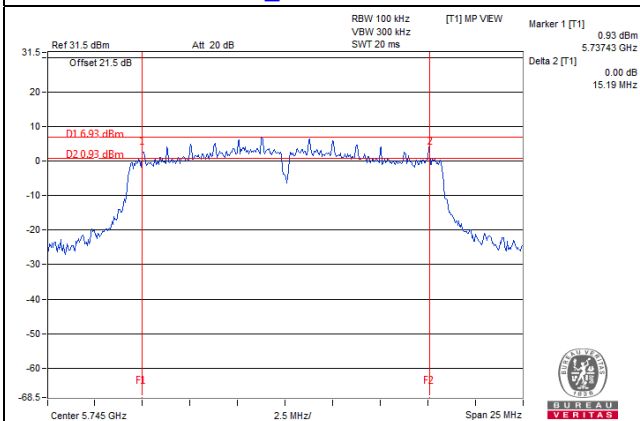

802.11ax (HE20)_Chain 3 / CH157

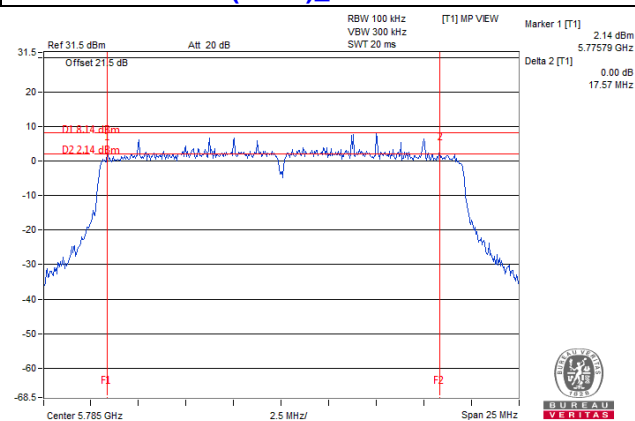

802.11ax (HE40)_Chain 2 / CH159

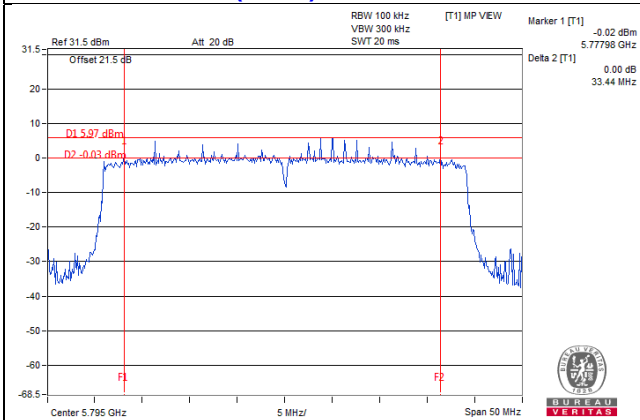

802.11ax (HE80)_Chain 3 / CH155

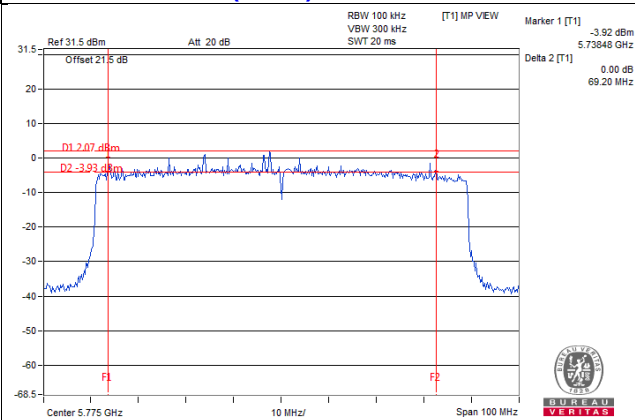

802.11ax (HE80+80)_Chain 4 / CH155

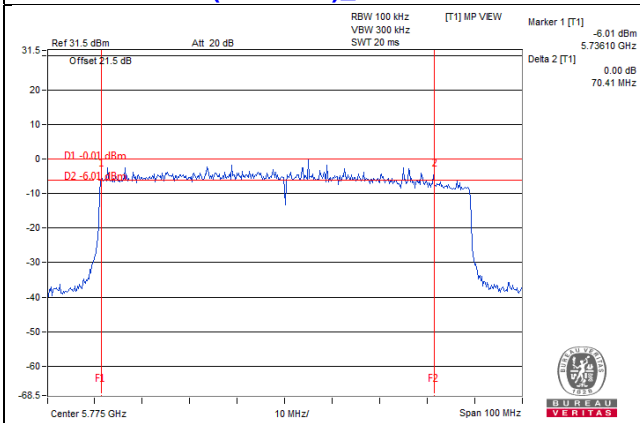

4.7.8 Test Results (Mode 2)

Non-Beamforming Mode
802.11a

Channel	Frequency (MHz)	6dB Bandwidth (MHz)				Minimum Limit (MHz)	Pass / Fail
		Chain 4	Chain 5	Chain 6	Chain 7		
149	5745	15.80	15.83	16.36	16.02	0.5	Pass
157	5785	16.34	15.79	16.34	16.35	0.5	Pass
165	5825	15.72	15.20	16.32	16.36	0.5	Pass

802.11ax (HE20)

Channel	Frequency (MHz)	6dB Bandwidth (MHz)				Minimum Limit (MHz)	Pass / Fail
		Chain 4	Chain 5	Chain 6	Chain 7		
149	5745	17.84	17.97	18.90	18.04	0.5	Pass
157	5785	18.39	17.92	18.31	17.37	0.5	Pass
165	5825	18.37	16.81	17.43	18.37	0.5	Pass

802.11ax (HE40)

Channel	Frequency (MHz)	6dB Bandwidth (MHz)				Minimum Limit (MHz)	Pass / Fail
		Chain 4	Chain 5	Chain 6	Chain 7		
151	5755	37.73	37.54	37.78	37.09	0.5	Pass
159	5795	37.78	37.46	37.59	36.97	0.5	Pass

802.11ax (HE80)

Channel	Frequency (MHz)	6dB Bandwidth (MHz)				Minimum Limit (MHz)	Pass / Fail
		Chain 4	Chain 5	Chain 6	Chain 7		
155	5775	74.66	72.20	74.28	73.23	0.5	Pass

802.11ax (HE80+80)

Channel	Frequency (MHz)	6dB Bandwidth (MHz)				Minimum Limit (MHz)	Pass / Fail
		Chain 4	Chain 5	Chain 6	Chain 7		
42+155	5210	-					
	5775	-	-	74.11	77.26	0.5	Pass

Spectrum Plot of Worst Value

802.11a_Chain 5 / CH165

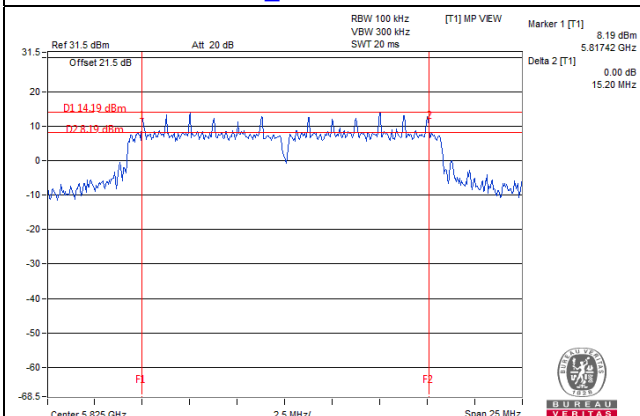

802.11ax (HE20)_Chain 5 / CH165

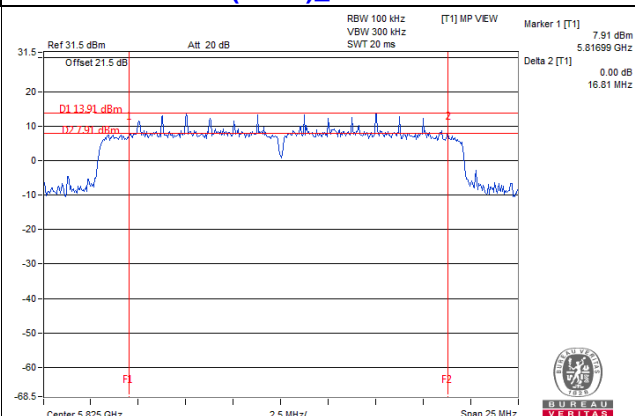

802.11ax (HE40)_Chain 7 / CH159

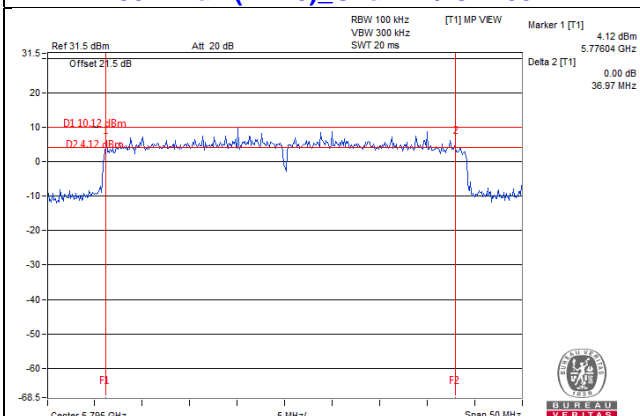

802.11ax (HE80)_Chain 5 / CH155

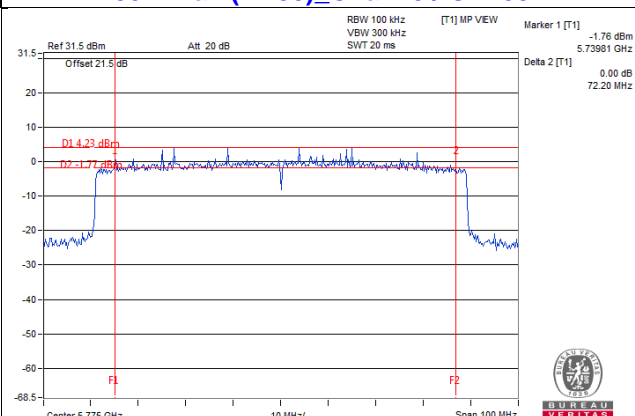

802.11ax (HE80+80)_Chain 6 / CH155

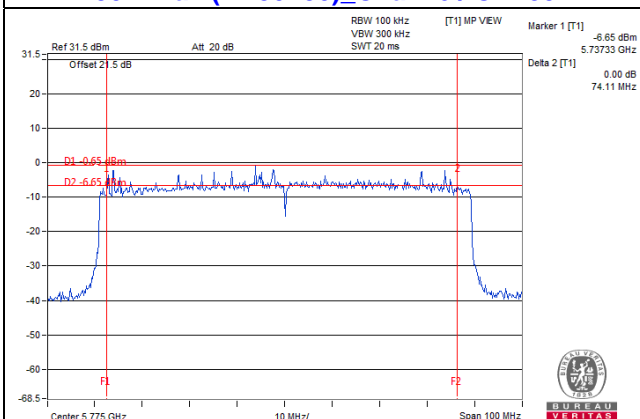

4.7.9 Test Results (Mode 3)

Non-Beamforming Mode
802.11a

Channel	Frequency (MHz)	6dB Bandwidth (MHz)		Minimum Limit (MHz)	Pass / Fail
		Chain 1	Chain 2		
149	5745	15.83	16.36	0.5	Pass
157	5785	15.79	16.34	0.5	Pass
165	5825	15.20	16.32	0.5	Pass

802.11ax (HE20)

Channel	Frequency (MHz)	6dB Bandwidth (MHz)		Minimum Limit (MHz)	Pass / Fail
		Chain 1	Chain 2		
149	5745	17.97	18.90	0.5	Pass
157	5785	17.92	18.31	0.5	Pass
165	5825	16.81	17.43	0.5	Pass

802.11ax (HE40)

Channel	Frequency (MHz)	6dB Bandwidth (MHz)		Minimum Limit (MHz)	Pass / Fail
		Chain 1	Chain 2		
151	5755	37.54	37.78	0.5	Pass
159	5795	37.46	37.59	0.5	Pass

802.11ax (HE80)

Channel	Frequency (MHz)	6dB Bandwidth (MHz)		Minimum Limit (MHz)	Pass / Fail
		Chain 1	Chain 2		
155	5775	72.20	74.28	0.5	Pass

Spectrum Plot of Worst Value

802.11a_Chain 1 / CH165

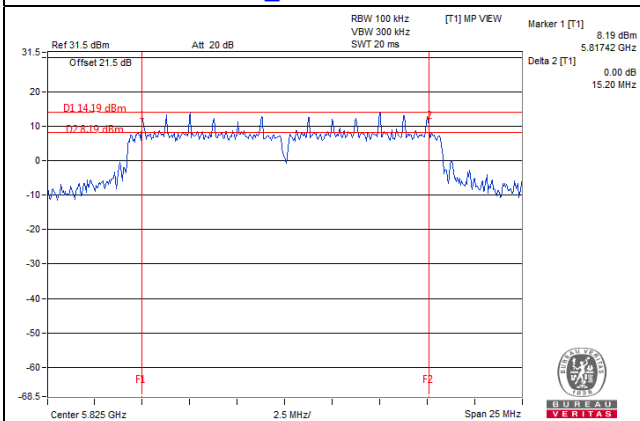

802.11ax (HE20)_Chain 1 / CH165

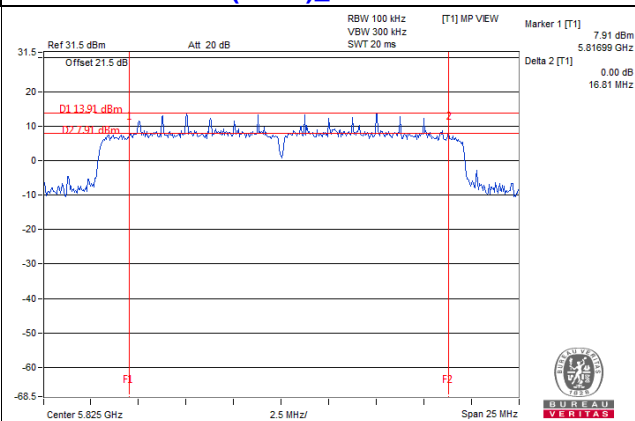

802.11ax (HE40)_Chain 1 / CH159

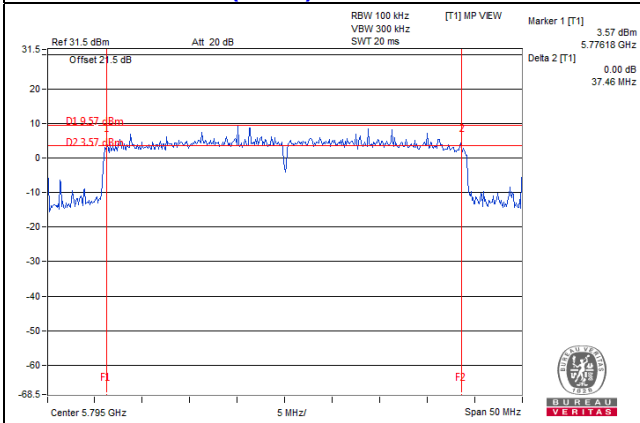

802.11ax (HE80)_Chain 1 / CH155

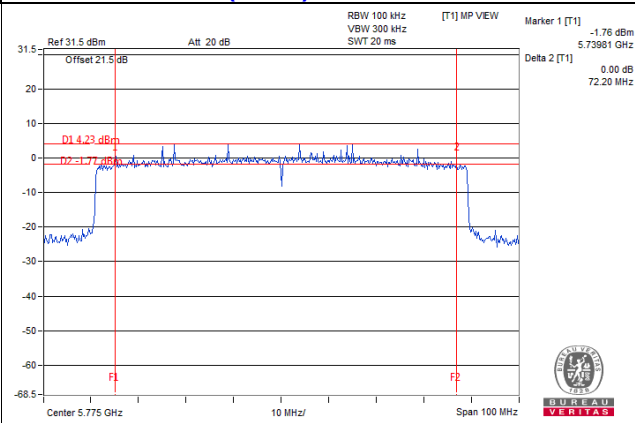

4.7.10 Test Results (Mode 4)

Non-Beamforming Mode

802.11a

Channel	Frequency (MHz)	6dB Bandwidth (MHz)	Minimum Limit (MHz)	Pass / Fail
149	5745	16.36	0.5	Pass
157	5785	16.34	0.5	Pass
165	5825	16.32	0.5	Pass

802.11ax (HE20)

Channel	Frequency (MHz)	6dB Bandwidth (MHz)	Minimum Limit (MHz)	Pass / Fail
149	5745	18.90	0.5	Pass
157	5785	18.31	0.5	Pass
165	5825	17.43	0.5	Pass

802.11ax (HE40)

Channel	Frequency (MHz)	6dB Bandwidth (MHz)	Minimum Limit (MHz)	Pass / Fail
151	5755	37.86	0.5	Pass
159	5795	36.79	0.5	Pass

802.11ax (HE80)

Channel	Frequency (MHz)	6dB Bandwidth (MHz)	Minimum Limit (MHz)	Pass / Fail
155	5775	76.51	0.5	Pass

Spectrum Plot of Worst Value

802.11a / CH165

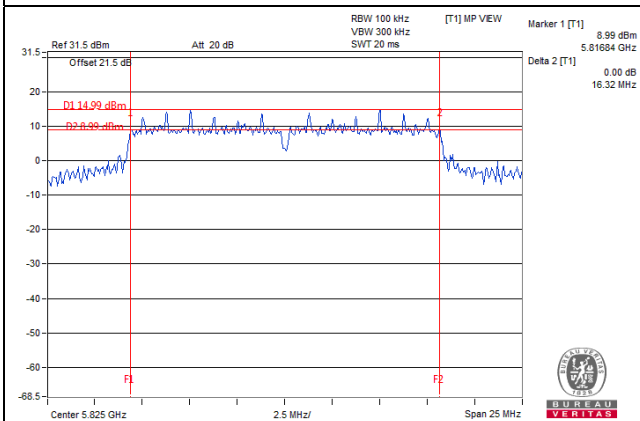

802.11ax (HE20) / CH165

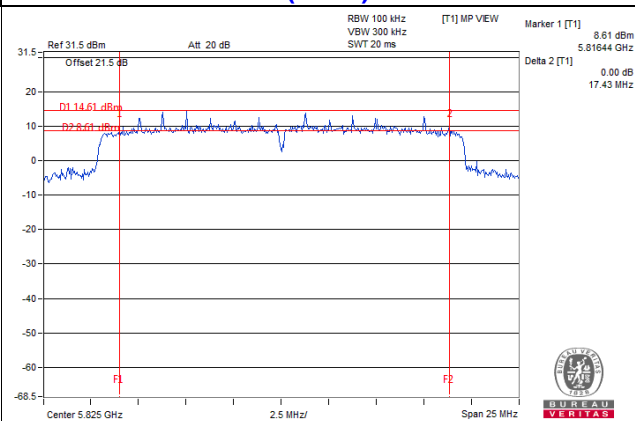

802.11ax (HE40) / CH159

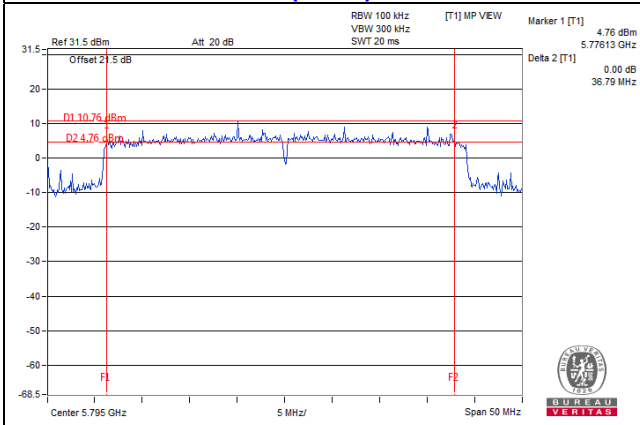

802.11ax (HE80) / CH155

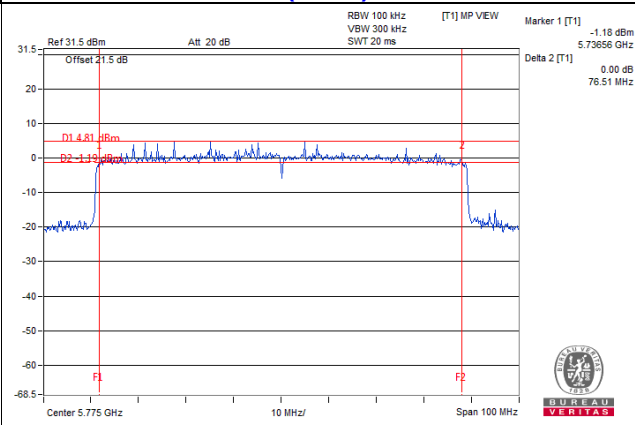

5 Pictures of Test Arrangements

Please refer to the attached file (Test Setup Photo).

Annex A- Radiated Out of Band Emission (OOBE) Measurement (For U-NII-3 band)

8TX:

802.11a

CH 149 5745 MHz

Horizontal

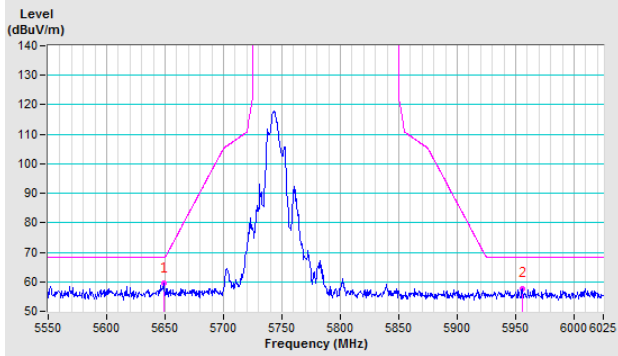

Vertical

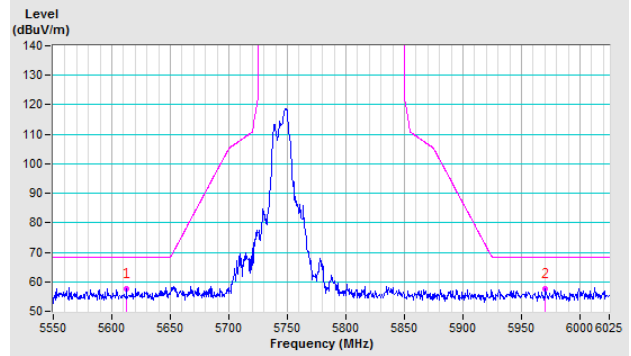

CH 157 5785 MHz

Horizontal

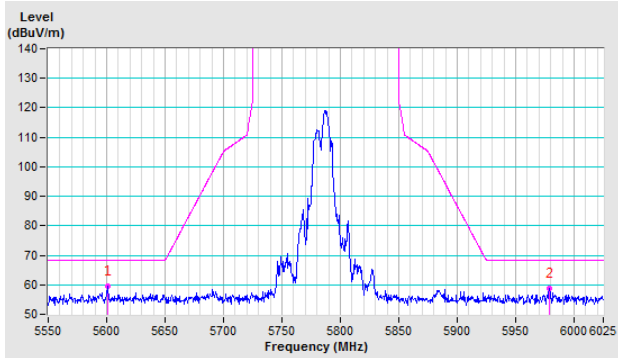

Vertical

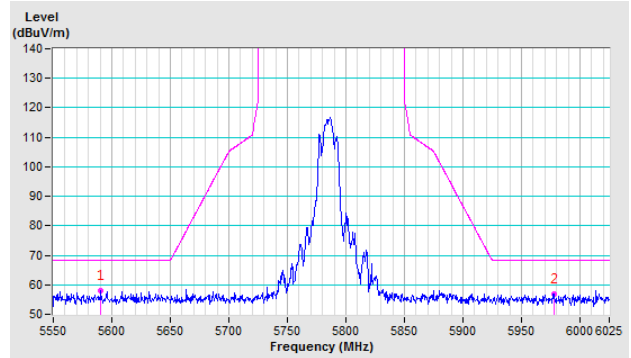

CH 165 5825 MHz

Horizontal

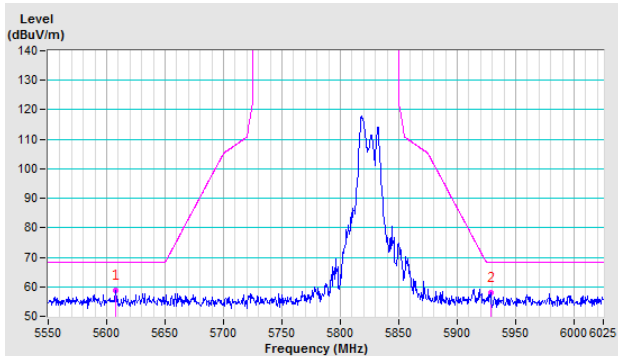

Vertical

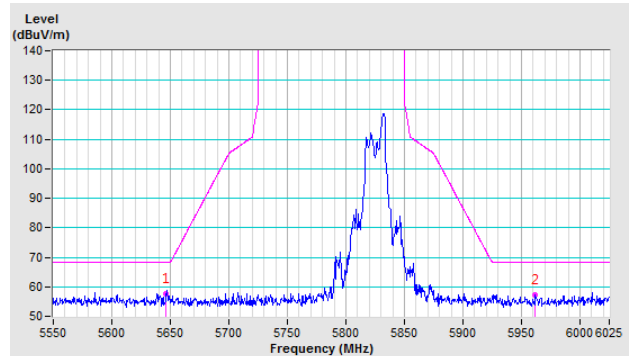

802.11ac (VHT20)

CH 149 5745 MHz

Horizontal

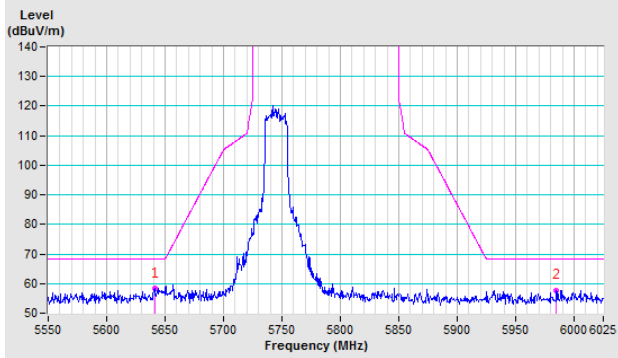

Vertical

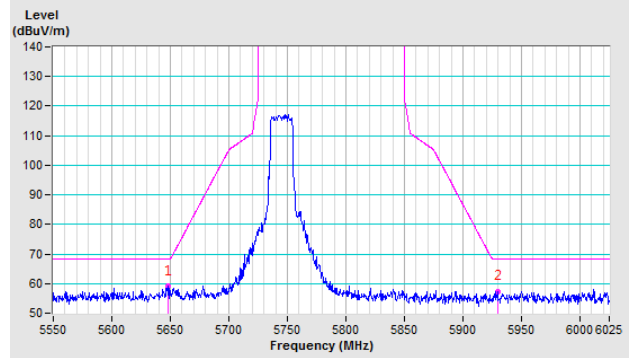

CH 157 5785 MHz

Horizontal

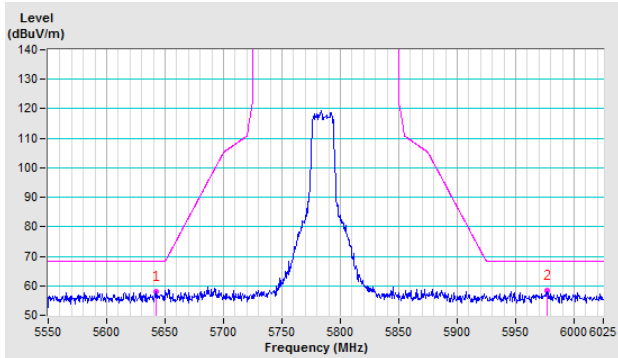

Vertical

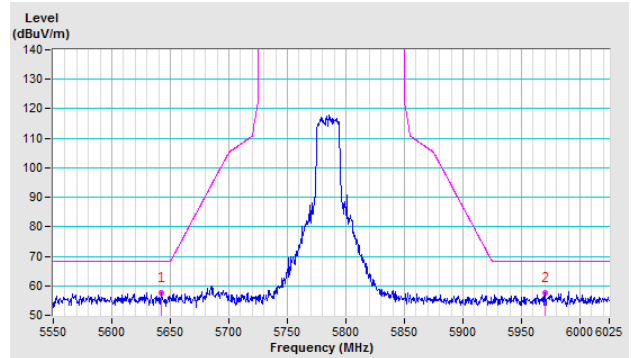

CH 165 5825 MHz

Horizontal

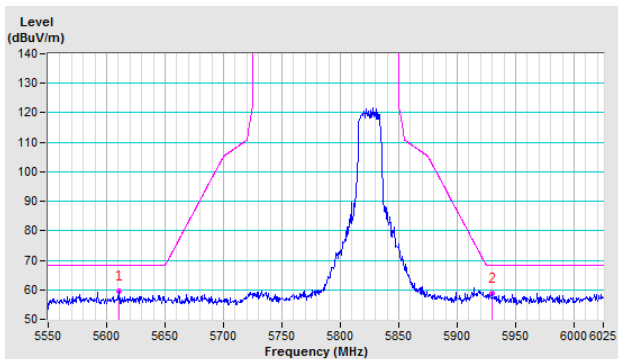

Vertical

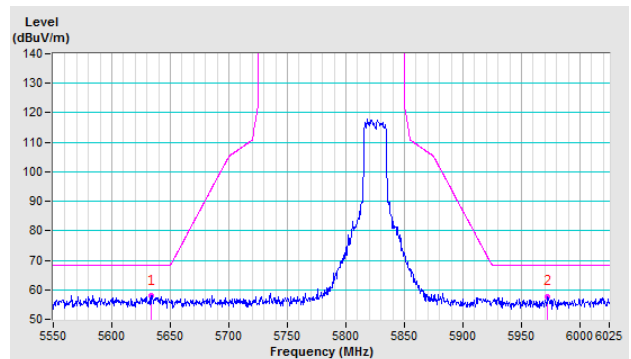

802.11ac (VHT40)

CH 151 5755 MHz

Horizontal

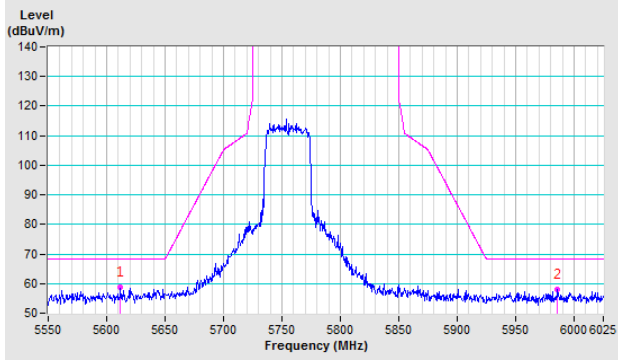

Vertical

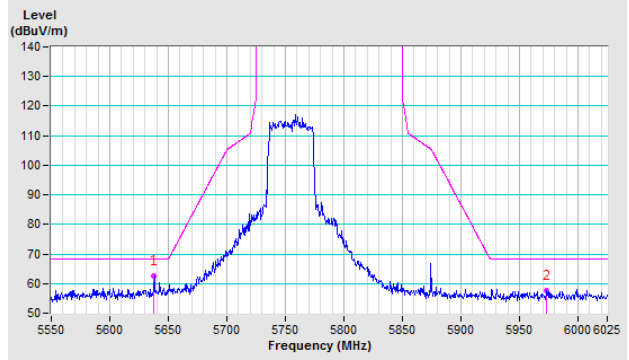

CH 159 5795 MHz

Horizontal

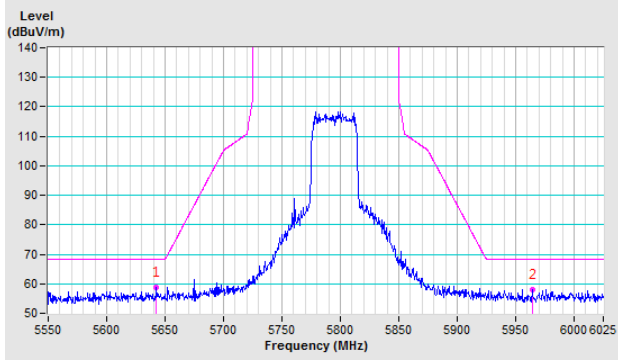

Vertical

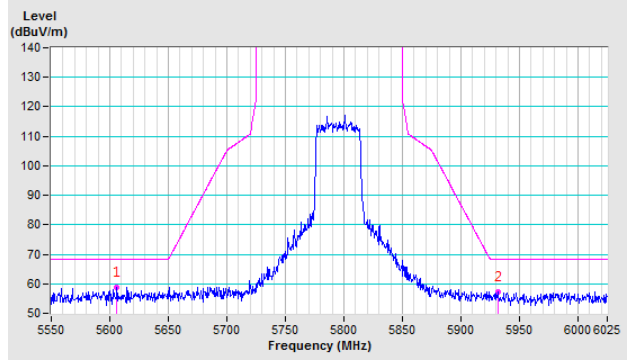

802.11ac (VHT80)

CH 155 5775 MHz

Horizontal

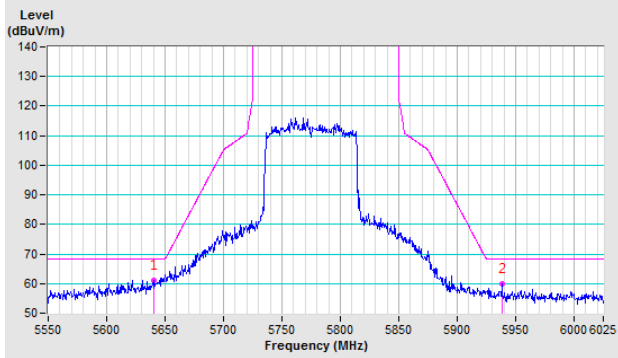

Vertical

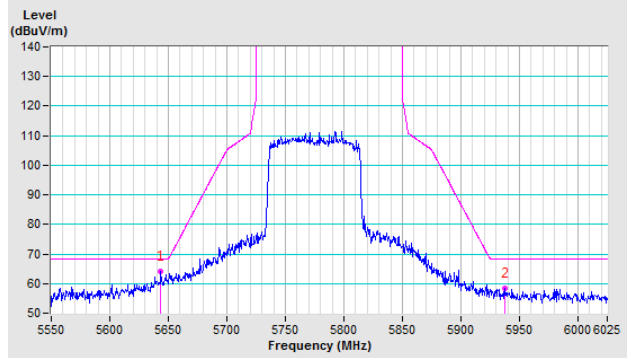

802.11ac (VHT80+80)

CH 42+155 5210+5775 MHz

Horizontal

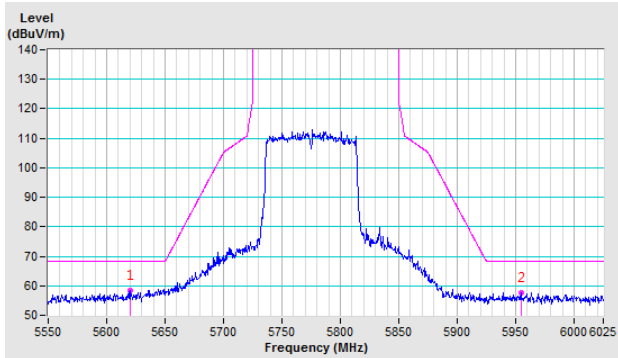

Vertical

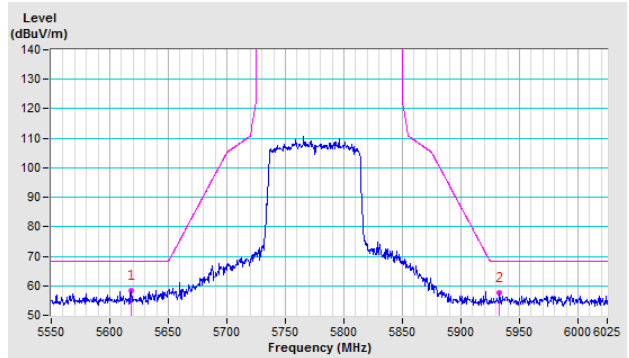

4TX:

802.11a

CH 149 5745 MHz

Horizontal

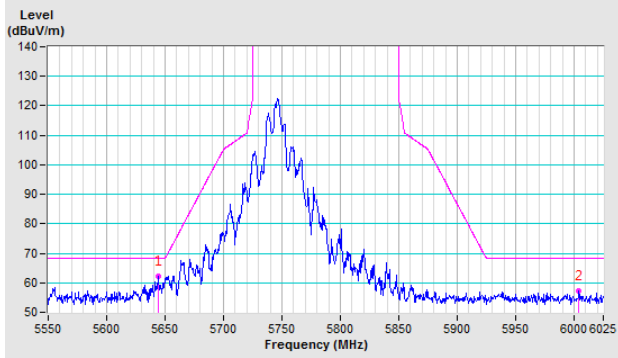

Vertical

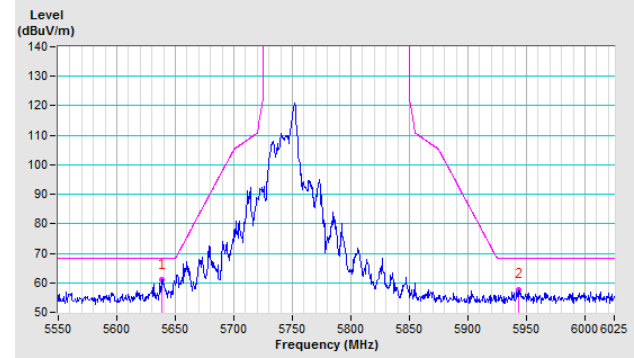

CH 157 5785 MHz

Horizontal

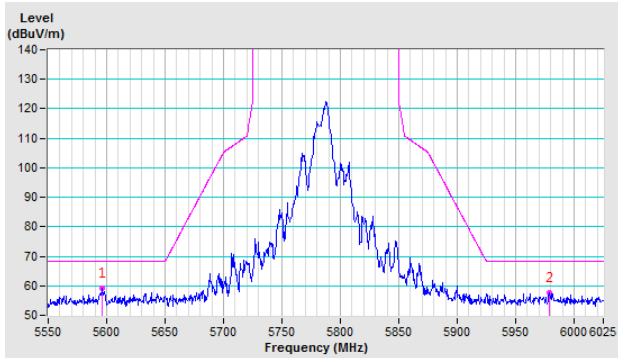

Vertical

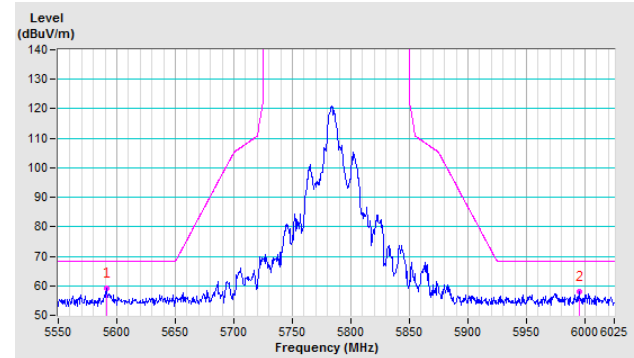

CH 165 5825 MHz

Horizontal

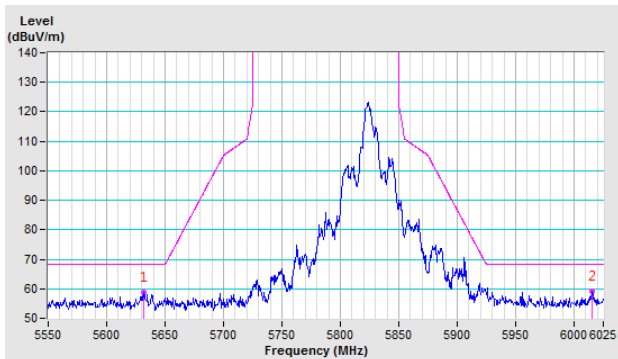

Vertical

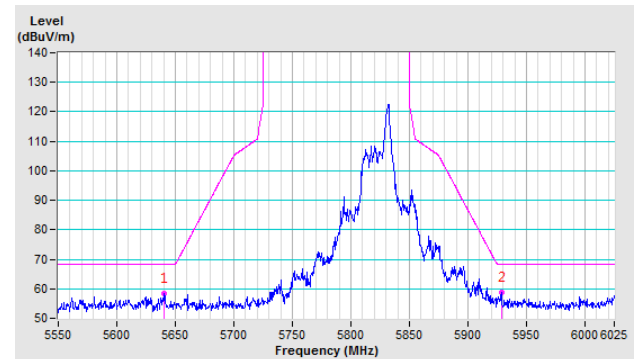

802.11ac (VHT20)

CH 149 5745 MHz

Horizontal

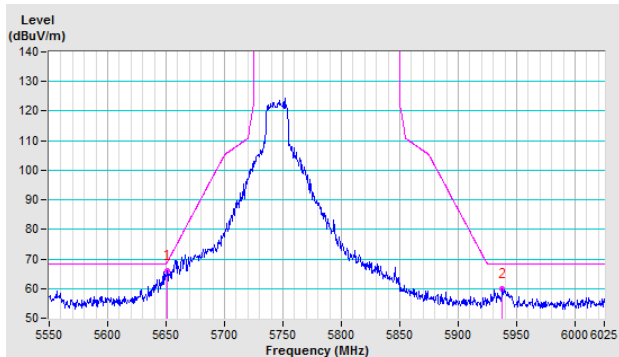

Vertical

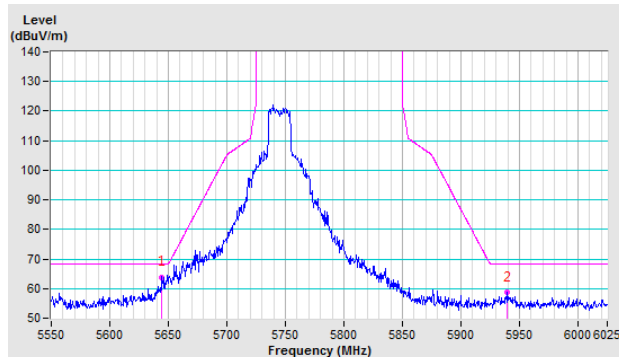

CH 157 5785 MHz

Horizontal

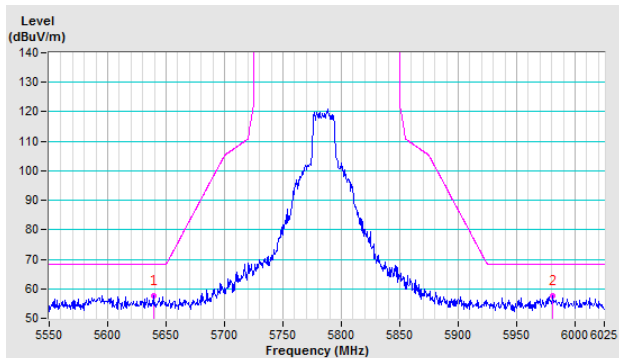

Vertical

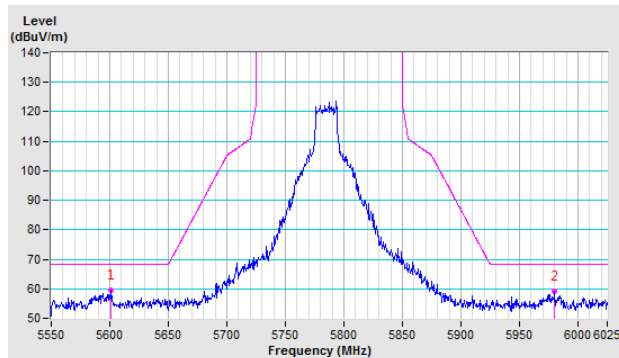

CH 165 5825 MHz

Horizontal

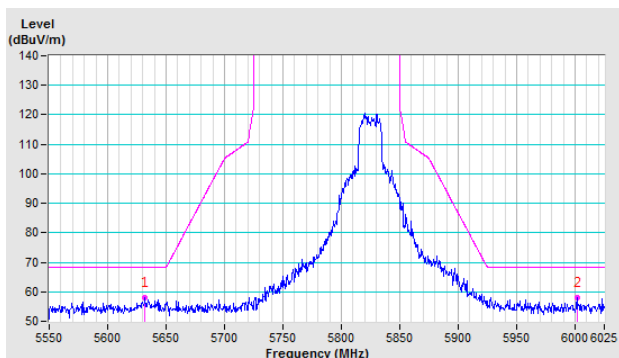

Vertical

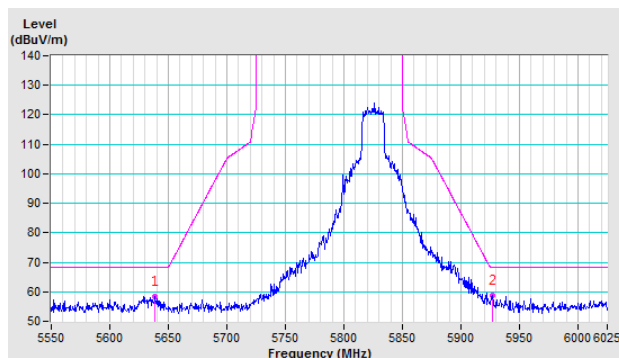

802.11ac (VHT40)

CH 151 5755 MHz

Horizontal

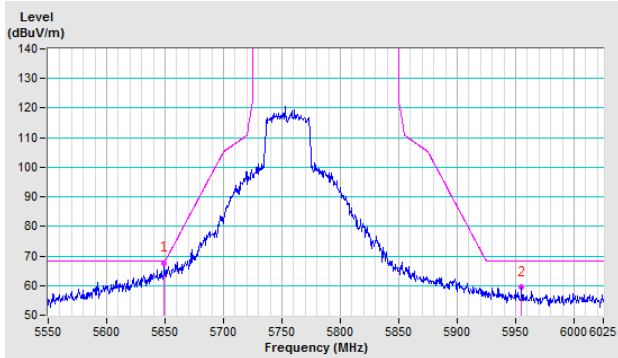

Vertical

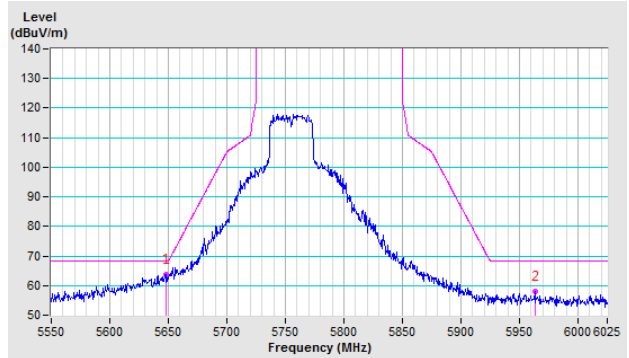

CH 159 5795 MHz

Horizontal

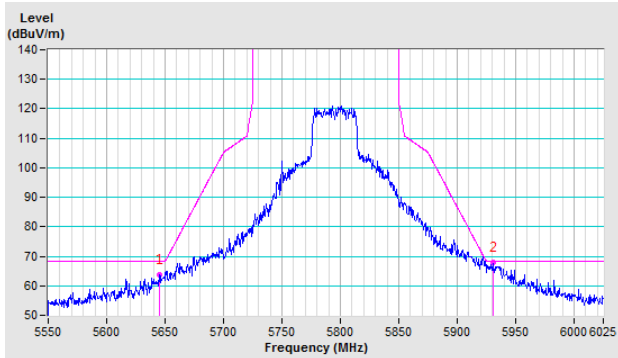

Vertical

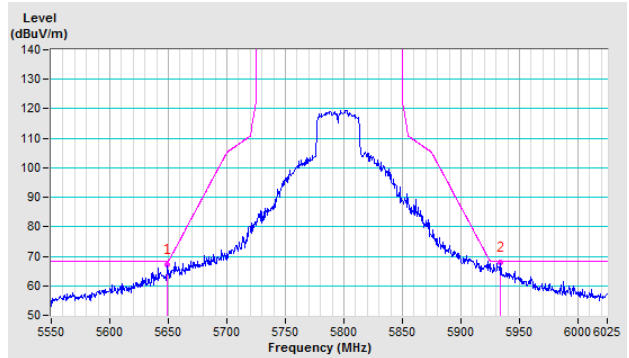

802.11ac (VHT80)

CH 155 5775 MHz

Horizontal

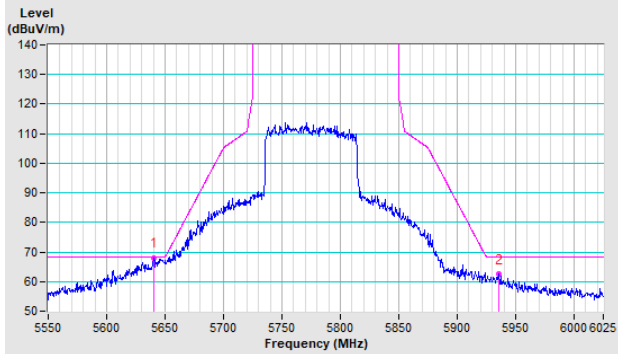

Vertical

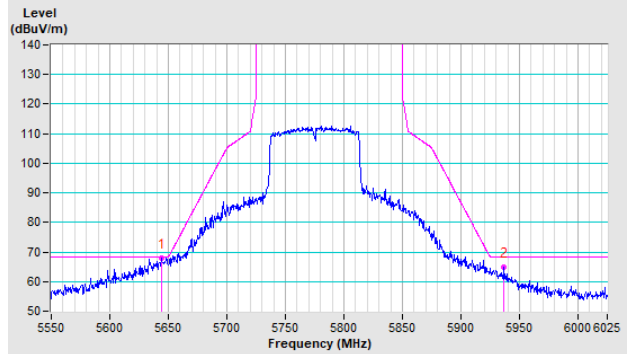

802.11ac (VHT80+80)

CH 42+155 5210+5775 MHz

Horizontal

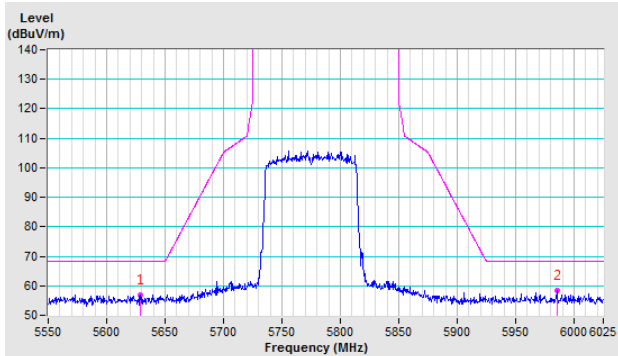

Vertical

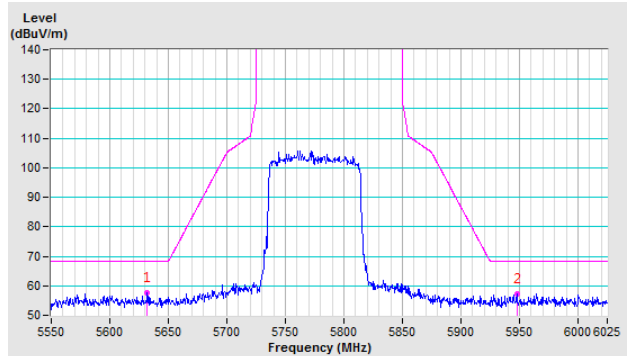

2TX:

802.11a

CH 149 5745 MHz

Horizontal

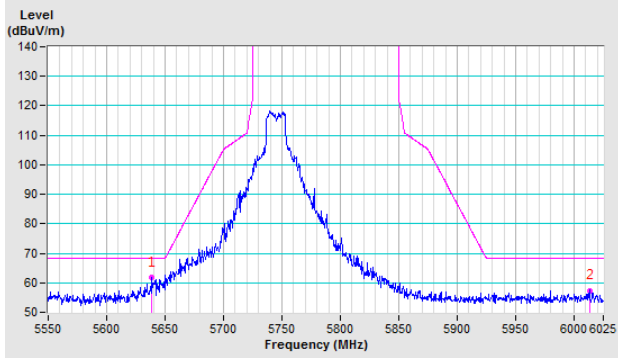

Vertical

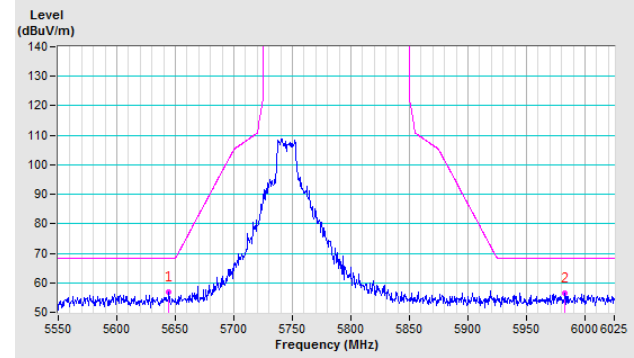

CH 157 5785 MHz

Horizontal

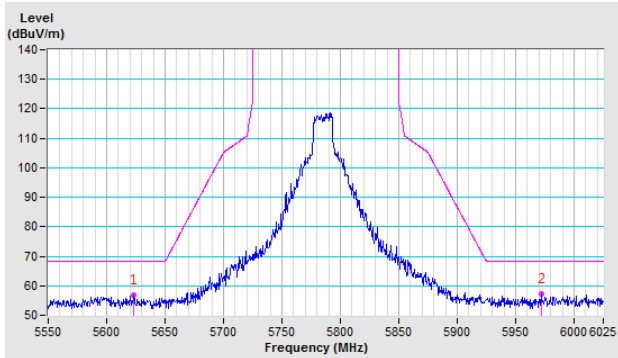

Vertical

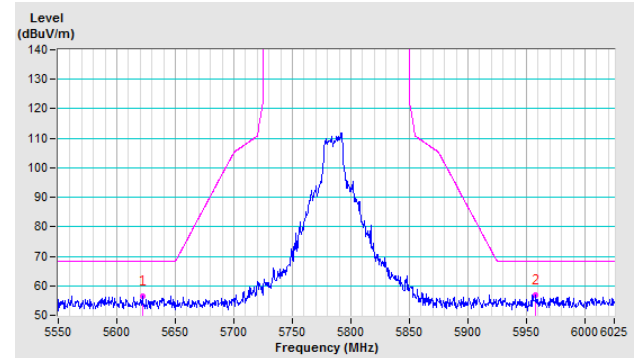

CH 165 5825 MHz

Horizontal

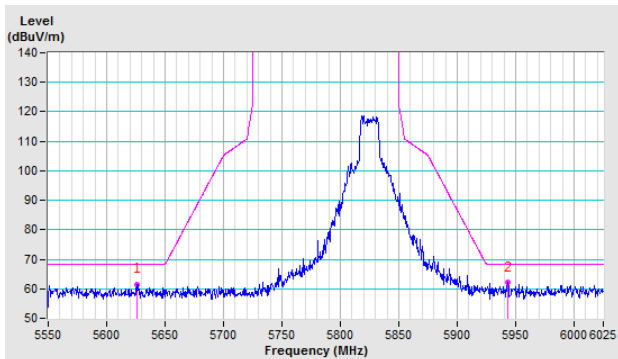

Vertical

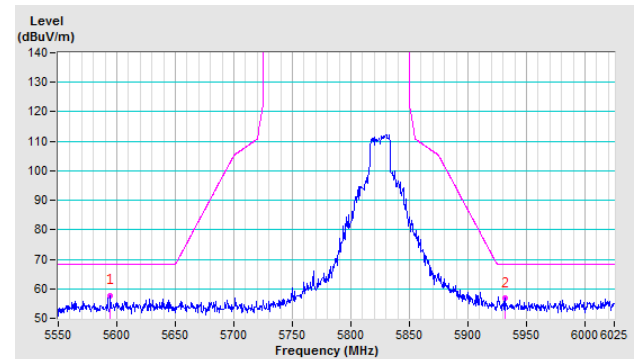

802.11ac (VHT20)

CH 149 5745 MHz

Horizontal

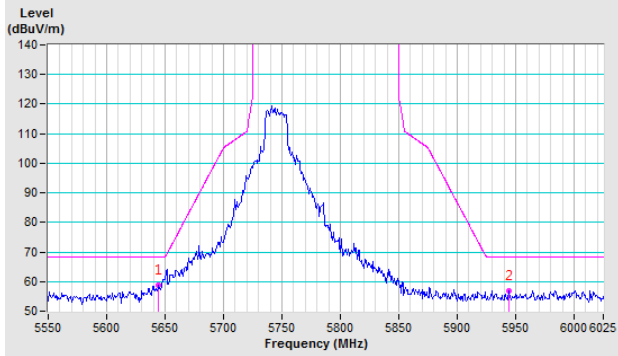

Vertical

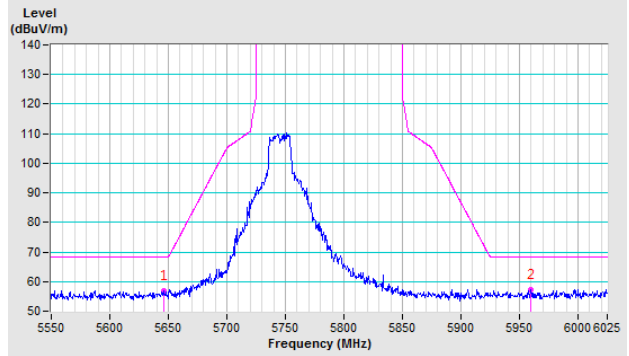

CH 157 5785 MHz

Horizontal

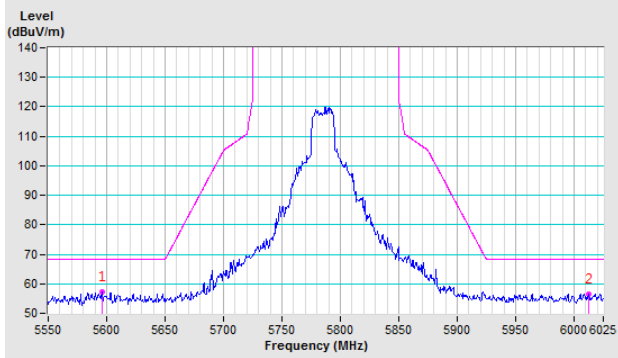

Vertical

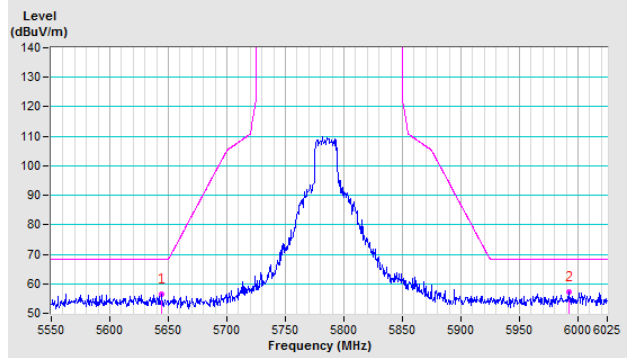

CH 165 5825 MHz

Horizontal

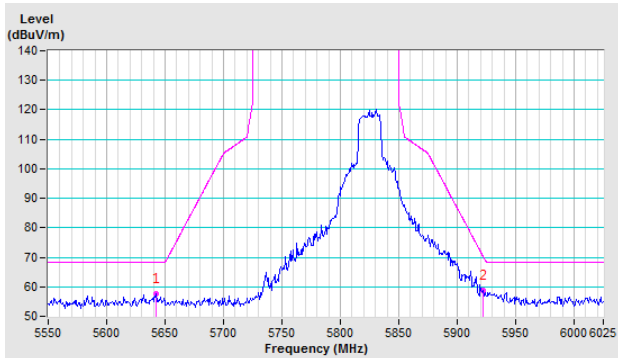

Vertical

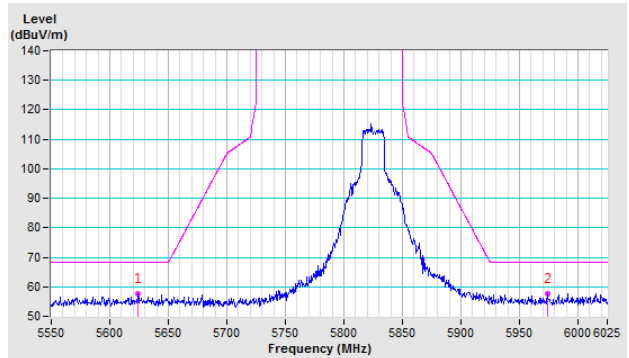

802.11ac (VHT40)

CH 151 5755 MHz

Horizontal

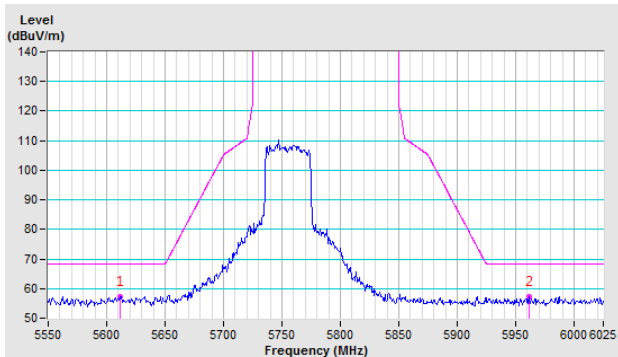

Vertical

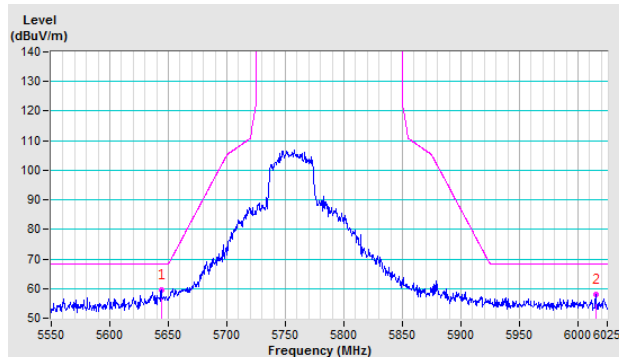

CH 159 5795 MHz

Horizontal

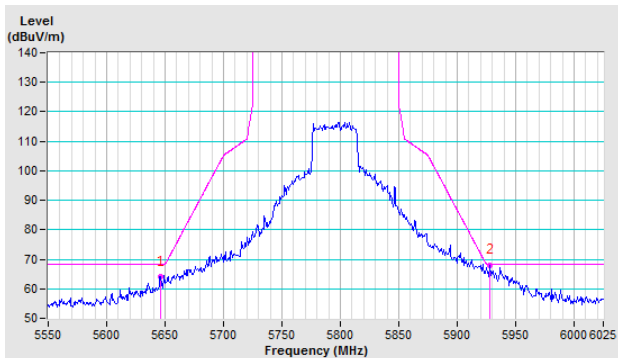

Vertical

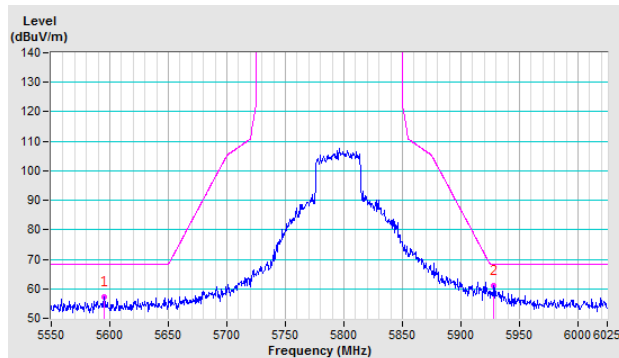

802.11ac (VHT80)

CH 155 5775 MHz

Horizontal

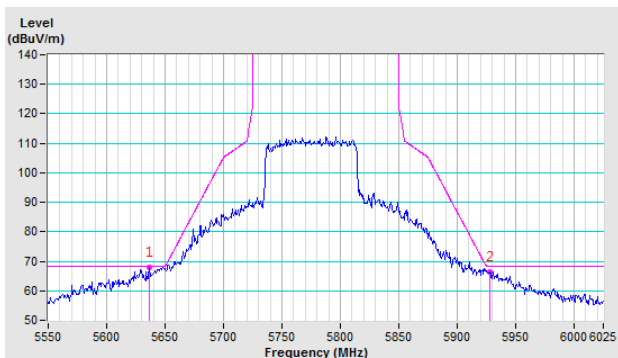

Vertical

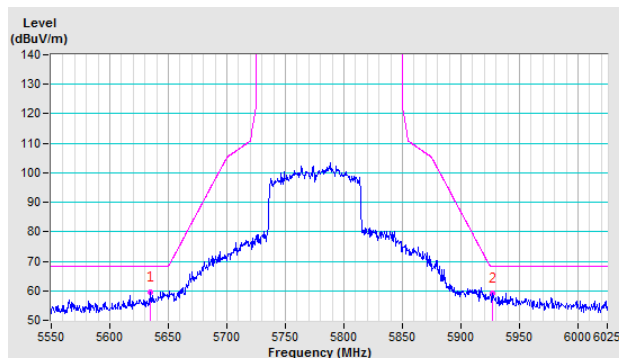

1TX:

802.11a

CH 149 5745 MHz

Horizontal

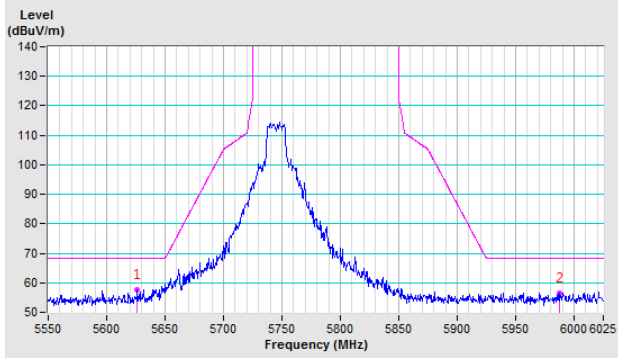

Vertical

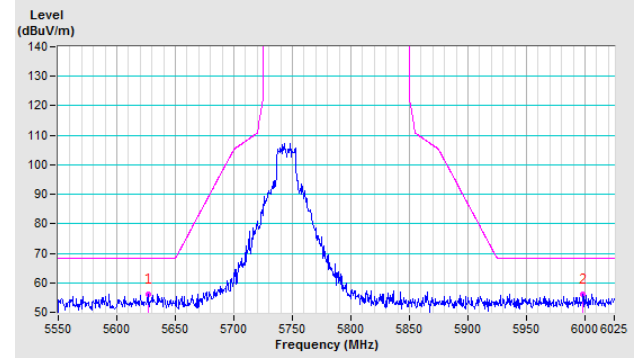

CH 157 5785 MHz

Horizontal

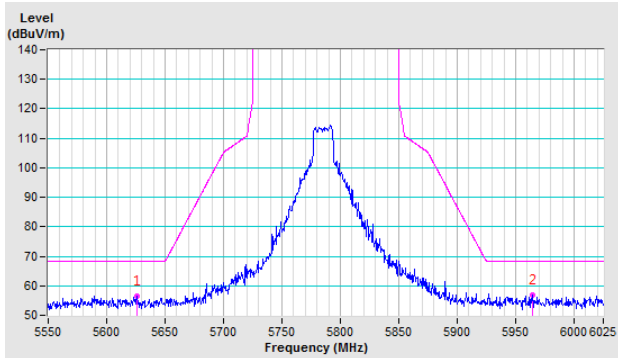

Vertical

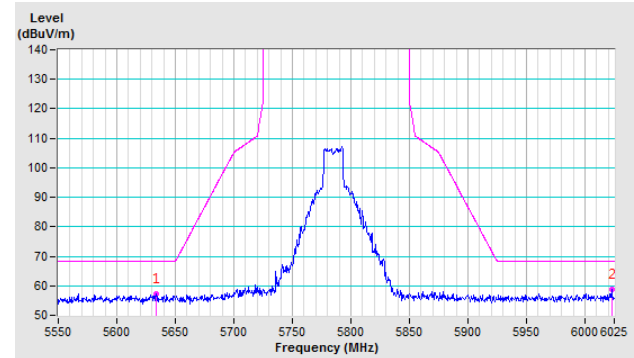

CH 165 5825 MHz

Horizontal

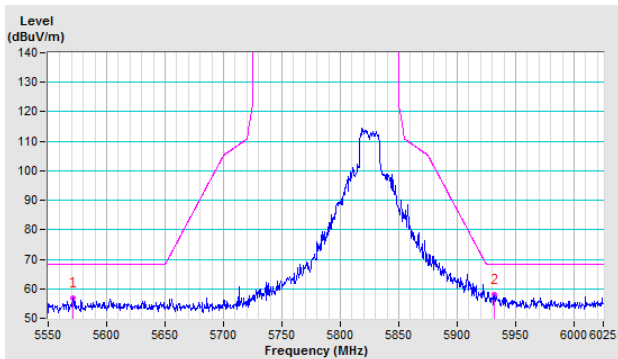

Vertical

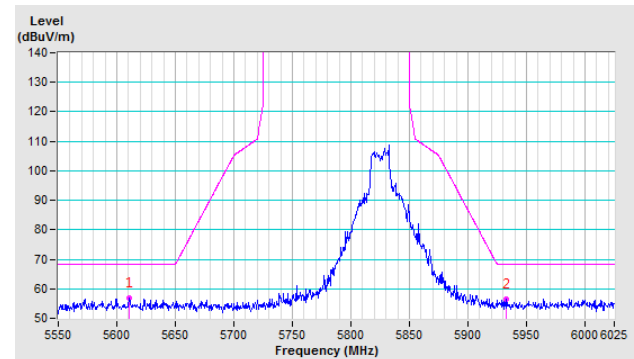

802.11ac (VHT20)

CH 149 5745 MHz

Horizontal

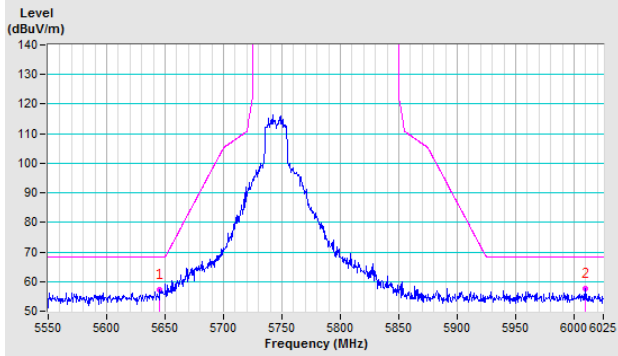

Vertical

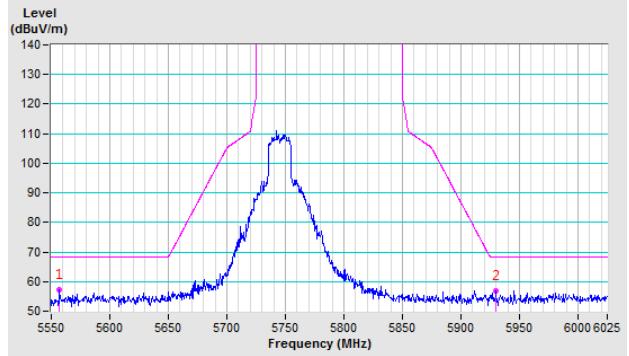

CH 157 5785 MHz

Horizontal

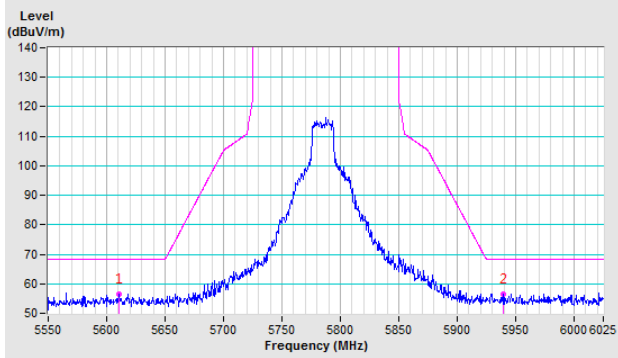

Vertical

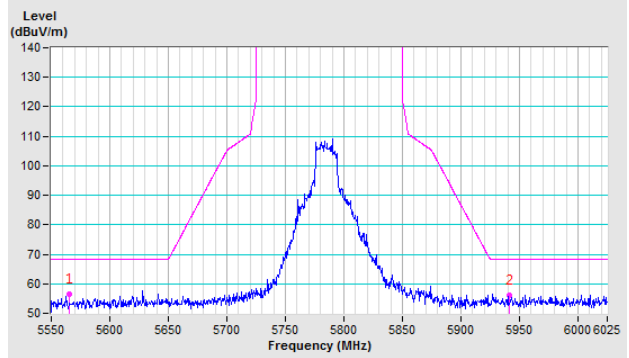

CH 165 5825 MHz

Horizontal

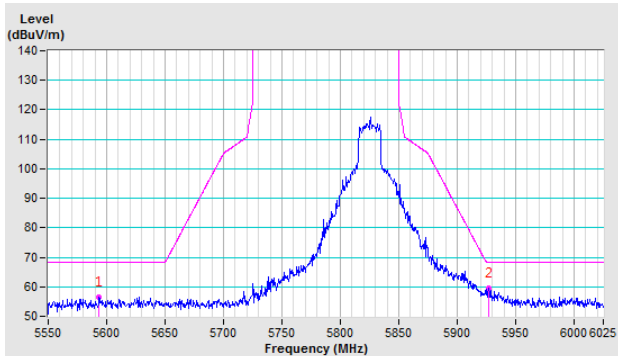

Vertical

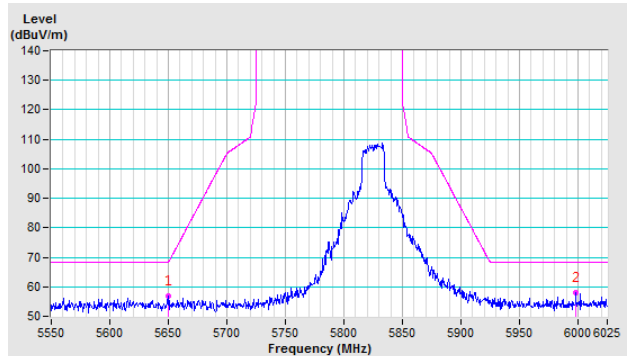

802.11ac (VHT40)

CH 151 5755 MHz

Horizontal

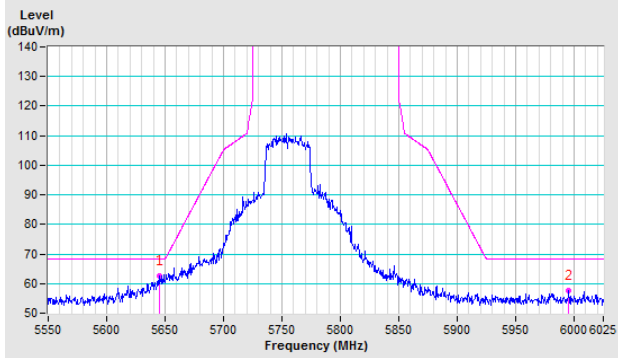

Vertical

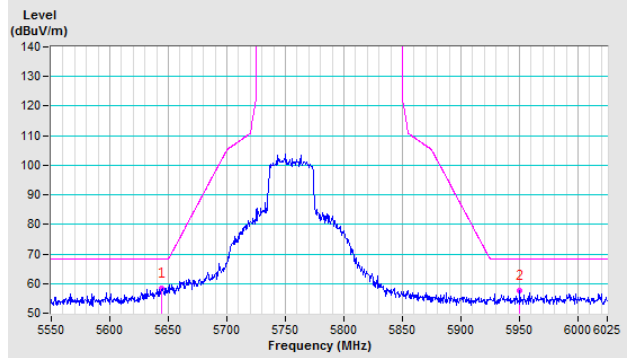

CH 159 5795 MHz

Horizontal

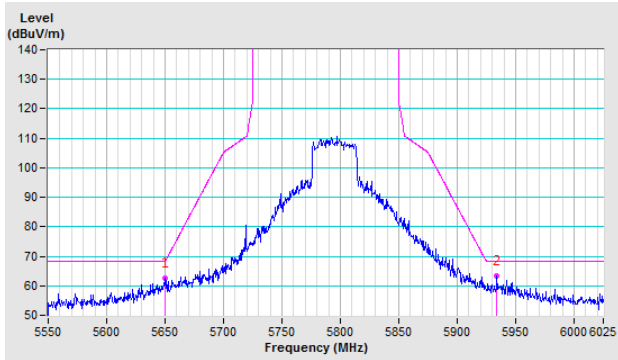

Vertical

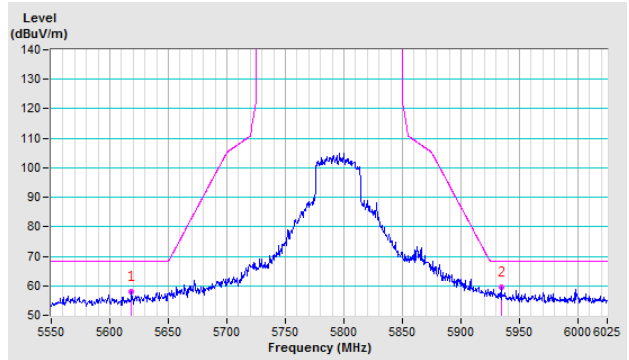

802.11ac (VHT80)

CH 155 5775 MHz

Horizontal

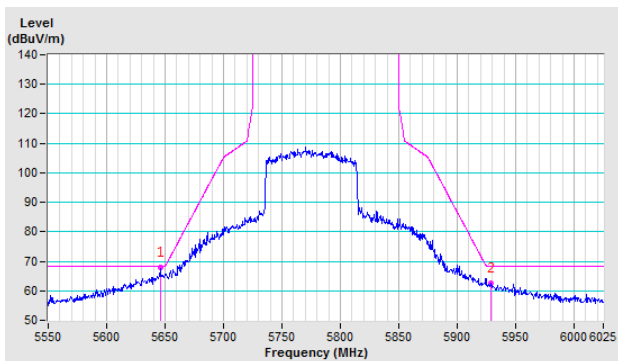

Vertical

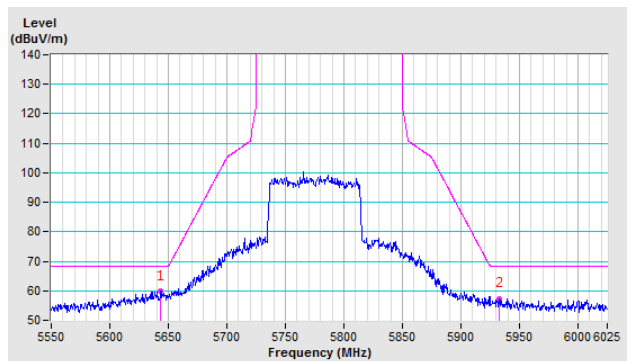

Appendix – Information on the Testing Laboratories

We, Bureau Veritas Consumer Products Services (H.K.) Ltd., Taoyuan Branch, were founded in 1988 to provide our best service in EMC, Radio, Telecom and Safety consultation. Our laboratories are FCC recognized accredited test firms and accredited according to ISO/IEC 17025.

If you have any comments, please feel free to contact us at the following:

Linkou EMC/RF Lab

Tel: 886-2-26052180

Fax: 886-2-26051924

Hsin Chu EMC/RF/Telecom Lab

Tel: 886-3-6668565

Fax: 886-3-6668323

Hwa Ya EMC/RF/Safety Lab

Tel: 886-3-3183232

Fax: 886-3-3270892

Email: service.adt@tw.bureauveritas.com

Web Site: www.bureauveritas-adt.com

The address and road map of all our labs can be found in our web site also.

--- END ---