

TEST REPORT

CERTIFICATE OF CONFORMITY

Standard: 47 CFR FCC Part 15, Subpart C (Section 15.247)
Report No.: RFBBUI-WTW-P22100654-2
FCC ID: TX2-RTL8851B
Product: 11ax RTL8851BE one antenna Combo module
Brand: REALTEK
Model No.: RTL8851B
Received Date: 2022/10/25
Test Date: 2022/12/10 ~ 2023/4/25
Issued Date: 2023/5/15

Applicant: Realtek Semiconductor Corp.
Address: No. 2, Innovation Road II, Hsinchu Science Park, Hsinchu 300, Taiwan
Issued By: Bureau Veritas Consumer Products Services (H.K.) Ltd., Taoyuan Branch
Hsin Chu Laboratory
Lab Address: E-2, No.1, Li Hsin 1st Road, Hsinchu Science Park, Hsinchu City 300, Taiwan
Test Location: E-2, No.1, Li Hsin 1st Road, Hsinchu Science Park, Hsinchu City 300, Taiwan
FCC Registration / 723255 / TW2022

Designation Number:

Approved by: _____



May Chen / Manager

, Date: _____

2023/5/15

This test report consists of 144 pages in total. It may be duplicated completely for legal use with the approval of the applicant. It should not be reproduced except in full, without the written approval of our laboratory. The test results in the report only apply to the tested sample. The test results in this report are traceable to the national or international standards.

Prepared by : Vito Lung / Specialist



This report is governed by, and incorporates by reference, the Conditions of Testing as posted at the date of issuance of this report at <http://www.bureauveritas.com/home/about-us/our-business/cps/about-us/terms-conditions/> and is intended for your exclusive use. Any copying or replication of this report to or for any other person or entity, or use of our name or trademark, is permitted only with our prior written permission. This report sets forth our findings solely with respect to the test samples identified herein. The results set forth in this report are not indicative or representative of the quality or characteristics of the lot from which a test sample was taken or any similar or identical product unless specifically and expressly noted. Our report includes all of the tests requested by you and the results thereof based upon the information that you provided to us. Measurement uncertainty is only provided upon request for accredited tests. Statements of conformity are based on simple acceptance criteria without taking measurement uncertainty into account, unless otherwise requested in writing. You have 60 days from date of issuance of this report to notify us of any material error or omission caused by our negligence or if you require measurement uncertainty; provided, however, that such notice shall be in writing and shall specifically address the issue you wish to raise. A failure to raise such issue within the prescribed time shall constitute your unqualified acceptance of the completeness of this report, the tests conducted and the correctness of the report contents.

Table of Contents

Release Control Record	4
1 Certificate.....	5
2 Summary of Test Results	6
2.1 Measurement Uncertainty	6
2.2 Supplementary Information	6
3 General Information	7
3.1 General Description	7
3.2 Antenna Description of EUT	8
3.3 Channel List.....	9
3.4 Test Mode Applicability and Tested Channel Detail.....	10
3.5 Duty Cycle of Test Signal.....	11
3.6 Test Program Used and Operation Descriptions	12
3.7 Connection Diagram of EUT and Peripheral Devices	12
3.8 Configuration of Peripheral Devices and Cable Connections	14
4 Test Instruments	15
4.1 RF Output Power.....	15
4.2 Number of Hopping Frequency Used.....	15
4.3 Dwell Time on Each Channel	15
4.4 Hopping Channel Separation	15
4.5 20 dB Bandwidth	15
4.6 Conducted Out of Band Emissions	15
4.7 AC Power Conducted Emissions	16
4.8 Unwanted Emissions below 1 GHz	16
4.9 Unwanted Emissions above 1 GHz.....	17
5 Limits of Test Items.....	18
5.1 RF Output Power.....	18
5.2 Number of Hopping Frequency Used.....	18
5.3 Dwell Time on Each Channel	18
5.4 Hopping Channel Separation	18
5.5 20 dB Bandwidth	18
5.6 Conducted Out of Band Emissions	18
5.7 AC Power Conducted Emissions	18
5.8 Unwanted Emissions below 1 GHz	19
5.9 Unwanted Emissions above 1 GHz.....	19
6 Test Arrangements.....	20
6.1 RF Output Power.....	20
6.1.1 Test Setup	20
6.1.2 Test Procedure.....	20
6.2 Number of Hopping Frequency Used.....	20
6.2.1 Test Setup	20
6.2.2 Test Procedure.....	20
6.3 Dwell Time on Each Channel	21
6.3.1 Test Setup	21
6.3.2 Test Procedure.....	21
6.4 Hopping Channel Separation	21
6.4.1 Test Setup	21
6.4.2 Test Procedure.....	21
6.5 20 dB Bandwidth	22
6.5.1 Test Setup	22
6.5.2 Test Procedure.....	22
6.6 Conducted Out of Band Emissions	22
6.6.1 Test Setup	22
6.6.2 Test Procedure.....	22
6.7 AC Power Conducted Emissions	23



6.7.1	Test Setup	23
6.7.2	Test Procedure.....	23
6.8	Unwanted Emissions below 1 GHz	24
6.8.1	Test Setup	24
6.8.2	Test Procedure.....	25
6.9	Unwanted Emissions above 1 GHz.....	26
6.9.1	Test Setup	26
6.9.2	Test Procedure.....	26
7	Test Results of Test Item	27
7.1	RF Output Power.....	27
7.2	Number of Hopping Frequency Used.....	29
7.3	Dwell Time on Each Channel	31
7.4	Hopping Channel Separation	35
7.5	20 dB Bandwidth	37
7.6	Conducted Out of Band Emissions	39
7.7	AC Power Conducted Emissions	43
7.8	Unwanted Emissions below 1 GHz	47
7.9	Unwanted Emissions above 1 GHz.....	59
8	Pictures of Test Arrangements	143
9	Information of the Testing Laboratories	144



Release Control Record

Issue No.	Description	Date Issued
RFBBUI-WTW-P22100654-2	Original release.	2023/5/15

1 Certificate

Product: 11ax RTL8851BE one antenna Combo module

Brand: REALTEK

Test Model: RTL8851B

Sample Status: Engineering sample

Applicant: Realtek Semiconductor Corp.

Test Date: 2022/12/10 ~ 2023/4/25

Standard: 47 CFR FCC Part 15, Subpart C (Section 15.247)

Measurement ANSI C63.10-2013

procedure: KDB 558074 D01 15.247 Meas Guidance v05r02

The above equipment has been tested by **Bureau Veritas Consumer Products Services (H.K.) Ltd., Taoyuan Branch**, and found compliance with the requirement of the above standards. The test record, data evaluation & Equipment Under Test (EUT) configurations represented herein are true and accurate accounts of the measurements of the sample's RF characteristics under the conditions specified in this report.

2 Summary of Test Results

47 CFR FCC Part 15, Subpart C (Section 15.247)			
Standard / Clause	Test Item	Result	Remark
15.247 (a)(1)	RF Output Power	Pass	Meet the requirement of limit.
15.247(a)(1) (iii)	Number of Hopping Frequency Used	Pass	Meet the requirement of limit.
15.247(a)(1) (iii)	Dwell Time on Each Channel	Pass	Meet the requirement of limit.
15.247(a)(1)	Hopping Channel Separation	Pass	Meet the requirement of limit.
15.247(a)(1)	20 dB Bandwidth	-	Refer to Note 1
15.247(d)	Conducted Out of Band Emissions	Pass	Meet the requirement of limit.
15.207	AC Power Conducted Emissions	Pass	Minimum passing margin is -9.38 dB at 0.18516 MHz
15.205 / 15.209 / 15.247(d)	Unwanted Emissions below 1 GHz	Pass	Minimum passing margin is -5.2 dB at 44.80 MHz
15.205 / 15.209 / 15.247(d)	Unwanted Emissions above 1 GHz	Pass	Minimum passing margin is -6.8 dB at 2483.50 MHz
15.203	Antenna Requirement	Pass	Antenna connector is IPEX4 not a standard connector.

Notes:

1. If the Frequency Hopping System operating in 2400-2483.5 MHz band and the output power less than 125 mW. The hopping channel carrier frequencies separated by a minimum of 25 kHz or two-thirds of the 20 dB bandwidth of hopping channel whichever is greater.
2. Determining compliance based on the results of the compliance measurement, not taking into account measurement instrumentation uncertainty.

2.1 Measurement Uncertainty

Where relevant, the following measurement uncertainty levels have been estimated for tests performed on the EUT as specified in CISPR 16-4-2:

Parameter	Specification	Expanded Uncertainty (k=2) (±)
Conducted Out of Band Emissions	9 kHz ~ 40 GHz	2.5 dB
AC Power Conducted Emissions	150 kHz ~ 30 MHz	1.9 dB
Unwanted Emissions below 1 GHz	9 kHz ~ 30 MHz	3.1 dB
	30 MHz ~ 1 GHz	5.1 dB
Unwanted Emissions above 1 GHz	1 GHz ~ 18 GHz	5.1 dB
	18 GHz ~ 40 GHz	5.3 dB

The other instruments specified are routine verified to remain within the calibrated levels, no measurement uncertainty is required to be calculated.

2.2 Supplementary Information

There is not any deviation from the test standards for the test method, and no modifications required for compliance.

3 General Information

3.1 General Description

Product	11ax RTL8851BE one antenna Combo module
Brand	REALTEK
Test Model	RTL8851B
Status of EUT	Engineering sample
Power Supply Rating	3.3 Vdc Hz from host equipment
Modulation Type	GFSK, $\pi/4$ -DQPSK, 8DPSK
Modulation Technology	FHSS
Transfer Rate	Up to 3 Mbps
Operating Frequency	2.402 GHz ~ 2.48 GHz
Number of Channel	79
Output Power	19.364 mW (12.87 dBm)

Note:

1. There are Bluetooth and WLAN (2.4 GHz & 5 GHz) technology used for the EUT.
2. Simultaneously transmission condition.

Condition	Technology	
1	WLAN (5 GHz)	Bluetooth

Note: The emission of the simultaneous operation has been evaluated and no non-compliance was found.

3. The above EUT information is declared by manufacturer and for more detailed features description, please refer to the manufacturer's specifications or User's Manual.

3.2 Antenna Description of EUT

1. The antenna information is listed as below.

Antenna NO.	RF Chain NO.	Brand	Model	Antenna Net Gain(dBi)	Frequency range	Antenna Type	Connector Type	Cable Length (mm)
1	Chain 1	REALTEK	RTK-ANT-0022	3.4	2.4~2.4835GHz	PIFA	IPEX4	300mm
				5	5.15~5.895GHz			
2	Chain 1	Aristotle	RFA-27-C38H1-MHF4300	3	2.4~2.4835GHz	Dipole	IPEX4	300mm
				5	5.15~5.895GHz			
3	Chain 1	LYNwave	ALX22F-120AA0-00	3.2	2.4~2.4835GHz	Monopole	IPEX4	200mm
				4	5.15~5.895GHz			

Note: Max. gain was selected for the final test, except for Unwanted Emissions.

* Detail antenna specification please refer to antenna datasheet and/or antenna measurement report.

3.3 Channel List

79 channels are provided for BT-EDR:

Channel	Frequency (MHz)	Channel	Frequency (MHz)	Channel	Frequency (MHz)	Channel	Frequency (MHz)
0	2402	20	2422	40	2442	60	2462
1	2403	21	2423	41	2443	61	2463
2	2404	22	2424	42	2444	62	2464
3	2405	23	2425	43	2445	63	2465
4	2406	24	2426	44	2446	64	2466
5	2407	25	2427	45	2447	65	2467
6	2408	26	2428	46	2448	66	2468
7	2409	27	2429	47	2449	67	2469
8	2410	28	2430	48	2450	68	2470
9	2411	29	2431	49	2451	69	2471
10	2412	30	2432	50	2452	70	2472
11	2413	31	2433	51	2453	71	2473
12	2414	32	2434	52	2454	72	2474
13	2415	33	2435	53	2455	73	2475
14	2416	34	2436	54	2456	74	2476
15	2417	35	2437	55	2457	75	2477
16	2418	36	2438	56	2458	76	2478
17	2419	37	2439	57	2459	77	2479
18	2420	38	2440	58	2460	78	2480
19	2421	39	2441	59	2461		

3.4 Test Mode Applicability and Tested Channel Detail

Pre-Scan:	<p>1. PIFA/Monopole ANT can be used in the following ways: X / Y / Z axis. Pre-scan in these ways and find the worst case as a representative test condition.</p> <p>2. Pre-Scan has been conducted to determine the worst-case mode from all possible combinations between available modulations, data rates.</p>
Worst Case:	<p>1. PIFA/Monopole ANT the worst case was found when positioned on (X / Y / Z axis): Unwanted Emissions below 1 GHz Y axis worst, and Unwanted Emissions above 1 GHz Y axis worst for PIFA ANT; Unwanted Emissions below 1 GHz X axis worst, and Unwanted Emissions above 1 GHz X axis worst for Monopole ANT.</p> <p>2. Dipole ANT was used typical placement for the test: Y axis.</p>

Following channel(s) was (were) selected for the final test as listed below:

Test Item	EUT Configure Mode	Power Profile	Tested Channel	Modulation	Data Rate Parameter
RF Output Power / Hopping Channel Separation / 20 dB Bandwidth	-	Low Power	0, 39, 78	GFSK	DH5
				8DPSK	3DH5
		High Power		GFSK	DH5
				8DPSK	3DH5
Number of Hopping Frequency Used	-	Low Power	Hopping	GFSK	DH5
				8DPSK	3DH5
		High Power		GFSK	DH5
				8DPSK	3DH5
Dwell Time on Each Channel	-	Low Power	Hopping	GFSK	DH1/DH3/DH5
				8DPSK	3DH1/3DH3/3DH5
		High Power		GFSK	DH1/DH3/DH5
				8DPSK	3DH1/3DH3/3DH5
Conducted Out of Band Emissions	-	Low Power	Hopping 0, 78	GFSK	DH5
				8DPSK	3DH5
		High Power		GFSK	DH5
				8DPSK	3DH5
AC Power Conducted Emissions	B	Low Power	78	8DPSK	3DH5
	E	High Power	0	GFSK	DH5
Unwanted Emissions below 1 GHz	A, B, C	Low Power	78	8DPSK	3DH5
	D, E, F	High Power	0	GFSK	DH5
Unwanted Emissions above 1 GHz	A, B, C	Low Power	0, 39, 78	GFSK	DH5
	D, E, F	High Power	0, 39, 78	8DPSK	3DH5
EUT Configure Mode:	A	with Dipole Antenna Low Power			
	B	with PIFA Antenna Low Power			
	C	with Monopole Antenna Low Power			
	D	with Dipole Antenna High Power			
	E	with PIFA Antenna High Power			
	F	with Monopole Antenna High Power			

Note: Bluetooth output power is divided into Low Power (6dBm) and High Power (12dBm), both need to be tested.

3.5 Duty Cycle of Test Signal

GFSK: Duty cycle = 2.888 ms / 100 ms x 100% = 2.9%

8DPSK: Duty cycle = 2.898 ms / 100 ms x 100% = 2.9%

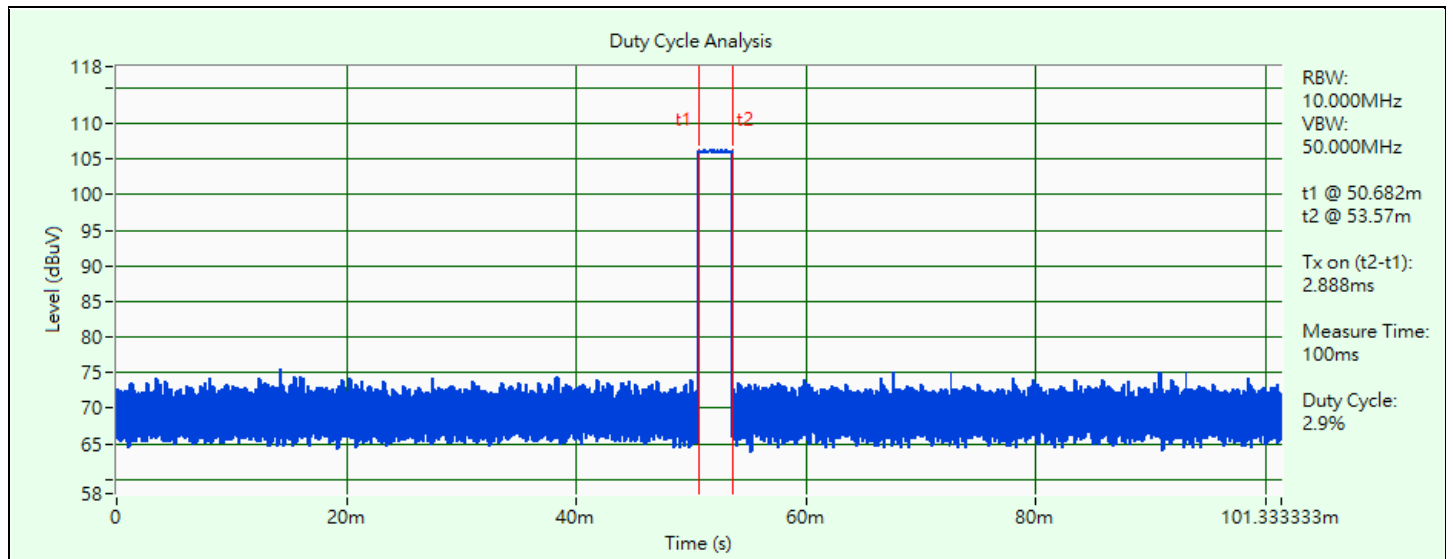

GFSK

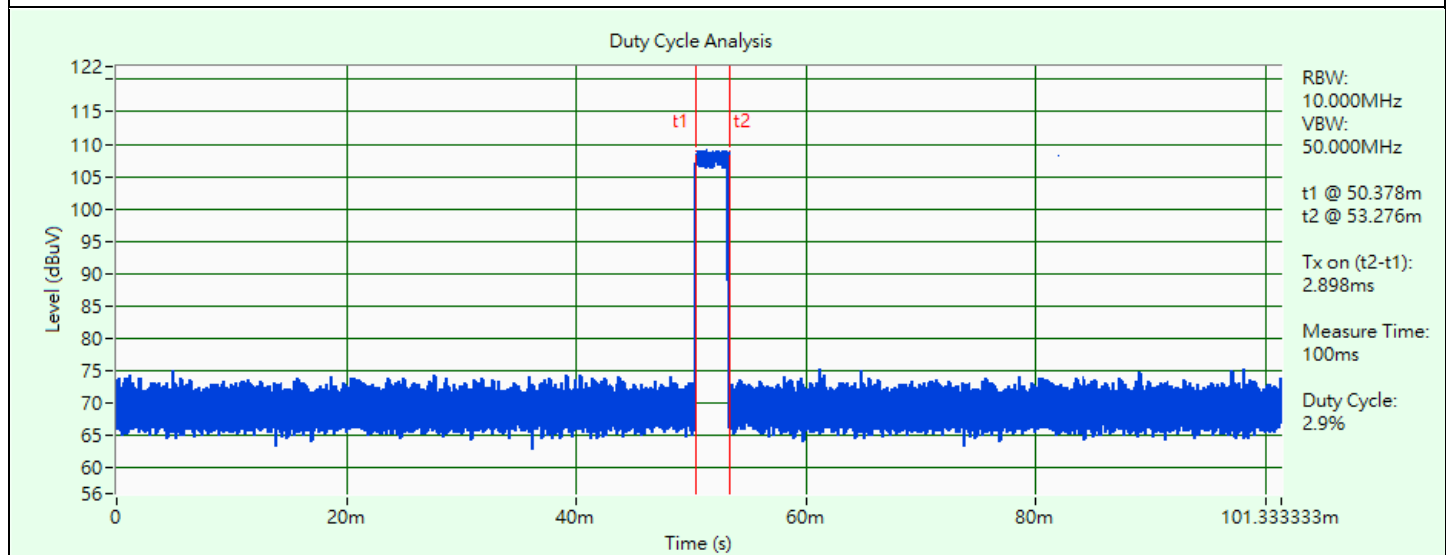

8DPSK

3.6 Test Program Used and Operation Descriptions

Controlling software (Bluetooth RF test tool (5.3.2.49)) has been activated to set the EUT under transmission condition continuously at specific channel frequency.

3.7 Connection Diagram of EUT and Peripheral Devices

For Unwanted Emission Test

Mode A

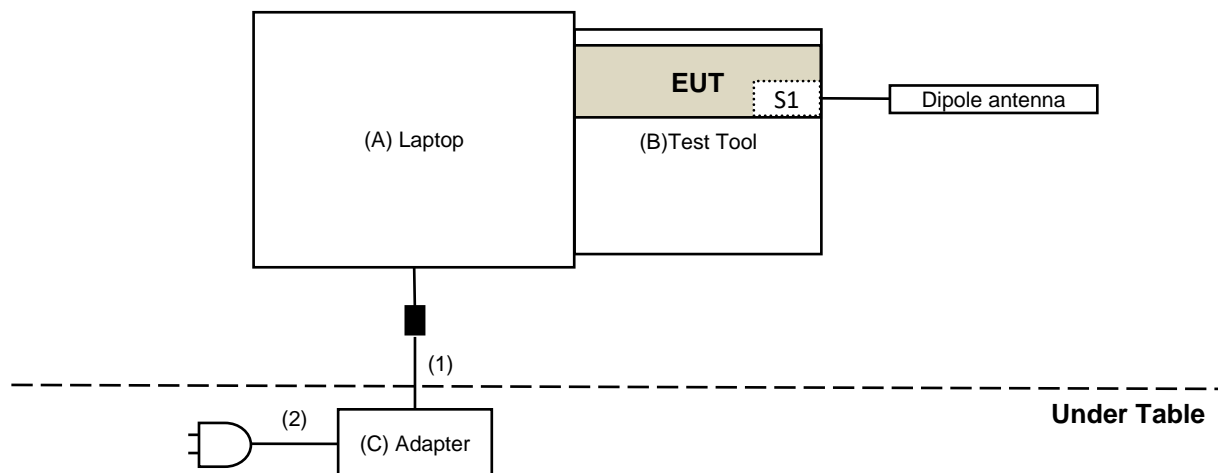

Mode B

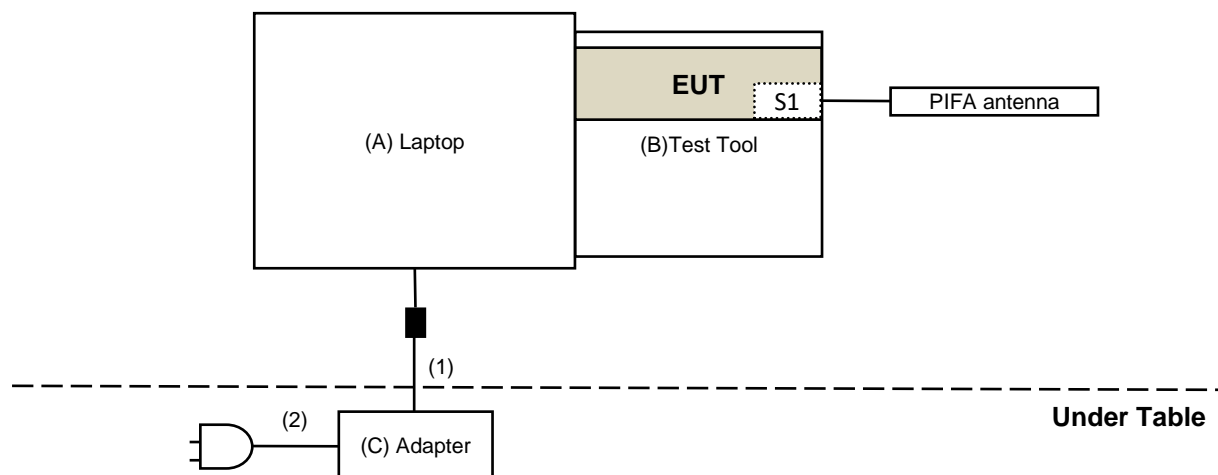

Mode C

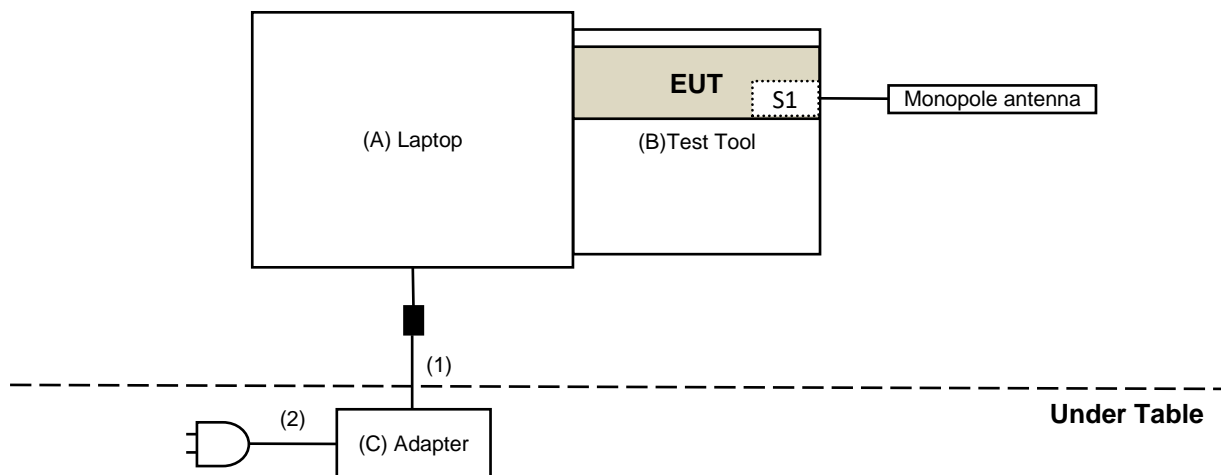

For AC Power Conducted Emission Test
Mode B

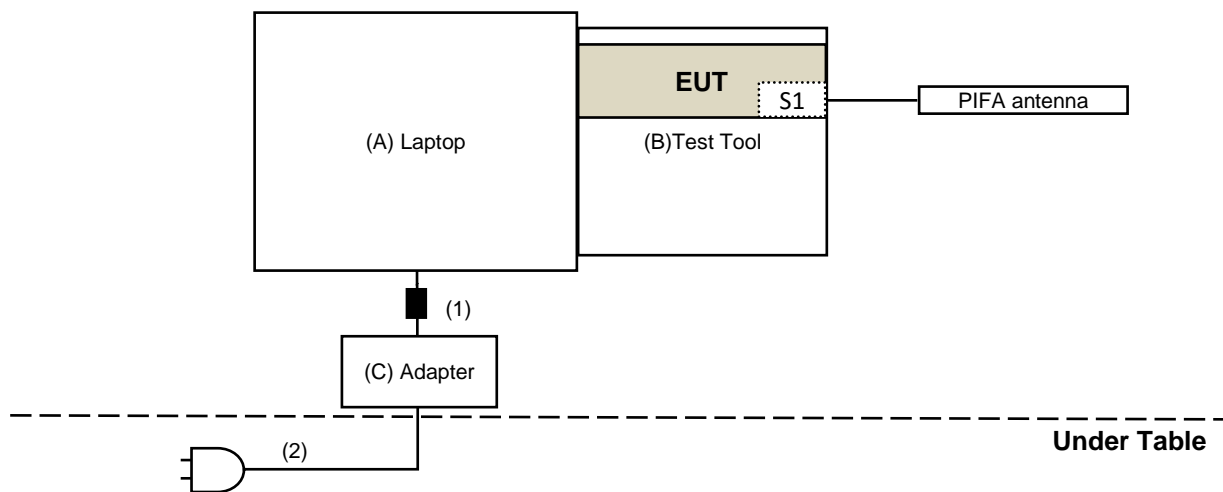

3.8 Configuration of Peripheral Devices and Cable Connections

ID	Product	Brand	Model No.	Serial No.	FCC ID	Remarks
A	Laptop	Dell	E5420	FHNS4S1	N/A	Provided by Lab
B	Test Tool	Realtek	N/A	N/A	N/A	Supplied by applicant
C	Adapter	Dell	LA65NS2-01	N/A	N/A	Supplied by applicant

ID	Cable Descriptions	Qty.	Length (m)	Shielding (Yes/No)	Cores (Qty.)	Remarks
1	DC Cable	1	1.8	No	1	Provided by Lab
2	AC Cable	0	1	No	0	Provided by Lab

4 Test Instruments

The calibration interval of the all test instruments are 12 months and the calibrations are traceable to NML/ROC and NIST/USA.

4.1 RF Output Power

Description Manufacturer	Model No.	Serial No.	Calibrated Date	Calibrated Until
Power Meter Anritsu	ML2495A	1529002	2022/6/22	2023/6/21
Pulse Power Sensor Anritsu	MA2411B	1726434	2022/6/22	2023/6/21
Attenuator WOKEN	MDCS18N-10	MDCS18N-10-01	2023/3/27	2024/3/26

Notes:

1. The test was performed in Oven room 2.
2. Tested Date: 2023/3/29

4.2 Number of Hopping Frequency Used

Description Manufacturer	Model No.	Serial No.	Calibrated Date	Calibrated Until
Attenuator WOKEN	MDCS18N-10	MDCS18N-10-01	2022/4/5	2023/4/4
Software	ADT_RF Test Software V6.6.5.4	N/A	N/A	N/A
Spectrum Analyzer Keysight	N9020B	MY60112409	2023/2/18	2024/2/17

Notes:

1. The test was performed in Oven room 2.
2. Tested Date: 2023/3/29

4.3 Dwell Time on Each Channel

Refer to section 4.2 to get information of the instruments.

4.4 Hopping Channel Separation

Refer to section 4.2 to get information of the instruments.

4.5 20 dB Bandwidth

Refer to section 4.2 to get information of the instruments.

4.6 Conducted Out of Band Emissions

Refer to section 4.2 to get information of the instruments.

4.7 AC Power Conducted Emissions

Description Manufacturer	Model No.	Serial No.	Calibrated Date	Calibrated Until
50 ohm terminal resistance	N/A	EMC-01	2022/9/27	2023/9/26
Fixed attenuator STI	STI02-2200-10	005	2022/8/24	2023/8/23
LISN R&S	ESH3-Z5	848773/004	2022/10/18	2023/10/17
RF Coaxial Cable JYEBO	5D-FB	COCCAB-001	2022/8/24	2023/8/23
Software BVADT	BVADT_Cond_V7.3.7.4	N/A	N/A	N/A
TEST RECEIVER R&S	ESCS 30	847124/029	2022/10/14	2023/10/13

Notes:

1. The test was performed in Conduction 1
2. Tested Date: 2023/3/21

4.8 Unwanted Emissions below 1 GHz

Description Manufacturer	Model No.	Serial No.	Calibrated Date	Calibrated Until
Bilog Antenna Schwarzbeck	VULB 9168	9168-0842	2022/10/24	2023/10/23
Boresight Antenna Tower & Turn Table Max-Full	MF-7802BS	MF780208530	N/A	N/A
Fixed attenuator Mini-Circuits	UNAT-5+	PAD-ATT5-02	2022/12/28	2023/12/27
LOOP ANTENNA Electro-Metrics	EM-6879	264	2023/2/21	2024/2/20
Pre_Amplifier Agilent	8447D	2944A10636	2023/3/12	2024/3/11
Pre_Amplifier EMCI	EMC330N	980538	2022/4/25	2023/4/24
RF Coaxial Cable COMMATE/PEWC	8D	966-5-1	2023/2/18	2024/2/17
		966-5-2	2023/2/18	2024/2/17
		966-5-3	2023/2/18	2024/2/17
RF Coaxial Cable JYEBO	5D-FB	LOOPCAB-001	2022/12/19	2023/12/18
		LOOPCAB-002	2022/12/19	2023/12/18
Software	ADT_Radiated_V8.7.08	N/A	N/A	N/A
Spectrum Analyzer Keysight	N9020B	MY60112410	2023/3/6	2024/3/5
Test Receiver R&S	ESR3	102528	2023/2/10	2024/2/9

Notes:

1. The test was performed in 966 Chamber No. 5.
2. Tested Date: 2023/3/24

4.9 Unwanted Emissions above 1 GHz

Description Manufacturer	Model No.	Serial No.	Calibrated Date	Calibrated Until
Boresight Antenna Tower & Turn Table Max-Full	MF-7802BS	MF780208530	N/A	N/A
Horn Antenna Schwarzbeck	BBHA 9120D	9120D-1819	2022/11/13	2023/11/12
	BBHA 9170	9170-739	2022/11/13	2023/11/12
Pre_Amplifier EMCI	EMC12630SE	980509	2022/4/25 2023/4/7	2023/4/24 2024/4/6
	EMC184045SE	980387	2022/1/10 2022/12/28	2023/1/9 2023/12/27
RF Cable-Frequency range: 1- 40GHz EMCI	EMC102-KM-KM-1200	160924	2022/1/10 2022/12/28	2023/1/9 2023/12/27
RF Coaxial Cable EMCI	EMC-KM-KM-4000	200214	2022/3/8 2023/2/20	2023/3/7 2024/2/19
	EMC104-SM-SM-1500	180503	2022/4/25 2023/4/7	2023/4/24 2024/4/6
	EMC104-SM-SM-2000	180501	2022/4/25 2023/4/7	2023/4/24 2024/4/6
	EMC104-SM-SM-6000	180506	2022/4/25 2023/4/7	2023/4/24 2024/4/6
Software	ADT_Radiated_V8.7.08	N/A	N/A	N/A
Spectrum Analyzer Keysight	N9020B	MY60112410	2022/3/13 2023/3/6	2023/3/12 2024/3/5
Test Receiver R&S	ESR3	102528	2022/2/25 2023/2/10	2023/2/24 2024/2/9

Notes:

1. The test was performed in 966 Chamber No. 5.
2. Tested Date: 2022/12/10 ~ 2023/4/25

5 Limits of Test Items

5.1 RF Output Power

The Maximum Output Power Measurement is 125 mW (21 dBm).

5.2 Number of Hopping Frequency Used

At least 15 channels frequencies, and should be equally spaced.

5.3 Dwell Time on Each Channel

The average time of occupancy on any channel shall not be greater than 0.4 seconds within a period of 0.4 seconds multiplied by the number of hopping channels employed.

5.4 Hopping Channel Separation

At least 25 kHz or two-third of 20 dB hopping channel bandwidth (whichever is greater).

5.5 20 dB Bandwidth

Maximum bandwidth is not specified.

5.6 Conducted Out of Band Emissions

Below 20 dB of the highest emission level of operating band (in 100 kHz Resolution Bandwidth).

5.7 AC Power Conducted Emissions

Frequency (MHz)	Conducted Limit (dBuV)	
	Quasi-peak	Average
0.15 - 0.5	66 - 56	56 - 46
0.50 - 5.0	56	46
5.0 - 30.0	60	50

Notes:

1. The lower limit shall apply at the transition frequencies.
2. The limit decreases in line with the logarithm of the frequency in the range of 0.15 to 0.50 MHz.

5.8 Unwanted Emissions below 1 GHz

Radiated emissions up to 1 GHz which fall in the restricted bands must comply with the radiated emission limits specified as below table. Other emissions shall be at least 20 dB below the highest level of the desired power:

Frequencies (MHz)	Field Strength (microvolts/meter)	Measurement Distance (meters)
0.009 ~ 0.490	2400/F(kHz)	300
0.490 ~ 1.705	24000/F(kHz)	30
1.705 ~ 30.0	30	30
30 ~ 88	100	3
88 ~ 216	150	3
216 ~ 960	200	3
Above 960	500	3

Notes:

3. The lower limit shall apply at the transition frequencies.
4. Emission level (dBuV/m) = 20 log Emission level (uV/m).

5.9 Unwanted Emissions above 1 GHz

Radiated emissions above 1 GHz which fall in the restricted bands must comply with the radiated emission limits specified as below table. Other emissions shall be at least 20 dB below the highest level of the desired power:

Frequencies (MHz)	Field Strength (microvolts/meter)	Measurement Distance (meters)
Above 960	500	3

Notes:

5. The lower limit shall apply at the transition frequencies.
6. Emission level (dBuV/m) = 20 log Emission level (uV/m).
7. For frequencies above 1000 MHz, the field strength limits are based on average detector, however, the peak field strength of any emission shall not exceed the maximum permitted average limits, specified above by more than 20 dB under any condition of modulation.

6 Test Arrangements

6.1 RF Output Power

6.1.1 Test Setup

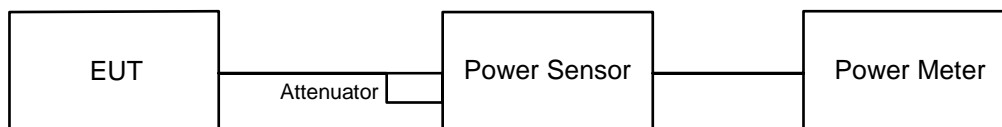

6.1.2 Test Procedure

Peak Power:

A peak power sensor was used on the output port of the EUT. A power meter was used to read the response of the peak power sensor. Record the power level.

Average Power:

Average power sensor was used to perform output power measurement, trigger and gating function of wide band power meter is enabled to measure max output power of TX on burst. Duty factor is not added to measured value.

6.2 Number of Hopping Frequency Used

6.2.1 Test Setup

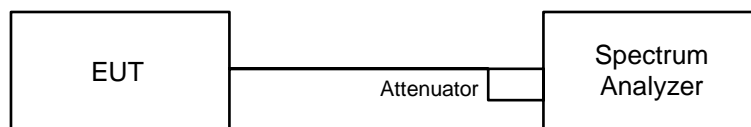

6.2.2 Test Procedure

- a. Check the calibration of the measuring instrument (SA) using either an internal calibrator or a known signal from an external generator.
- b. Turn on the EUT and connect its antenna terminal to measurement via a low loss cable. Then set it to any one measured frequency within its operating range and make sure the instrument is operated in its linear range.
- c. Set the SA on MaxHold Mode, and then keep the EUT in hopping mode. Record all the signals from each channel until each one has been recorded.
- d. Set the SA on View mode and then plot the result on SA screen.
- e. Repeat above procedures until all frequencies measured were complete.

6.3 Dwell Time on Each Channel

6.3.1 Test Setup

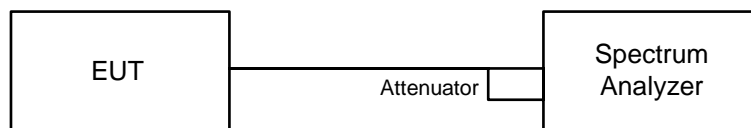

6.3.2 Test Procedure

- f. Check the calibration of the measuring instrument (SA) using either an internal calibrator or a known signal from an external generator.
- g. Turn on the EUT and connect its antenna terminal to measurement via a low loss cable. Then set it to any one measured frequency within its operating range and make sure the instrument is operated in its linear range.
- h. Adjust the center frequency of SA on any frequency be measured and set SA to zero span mode. And then, set RBW and VBW of spectrum analyzer to proper value.
- i. Measure the time duration of one transmission on the measured frequency. And then plot the result with time difference of this time duration.
- j. Repeat above procedures until all different time-slot modes have been completed.

6.4 Hopping Channel Separation

6.4.1 Test Setup

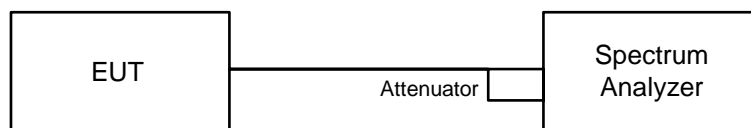

6.4.2 Test Procedure

- k. Check the calibration of the measuring instrument using either an internal calibrator or a known signal from an external generator.
- l. Turn on the EUT and connect it to measurement instrument. Then set it to any one convenient frequency within its operating range.
- m. By using the MaxHold function record the separation of two adjacent channels.
- n. Measure the frequency difference of these two adjacent channels by SA MARK function. And then plot the result on SA screen.
- o. Repeat above procedures until all frequencies measured were complete.

6.5 20 dB Bandwidth

6.5.1 Test Setup

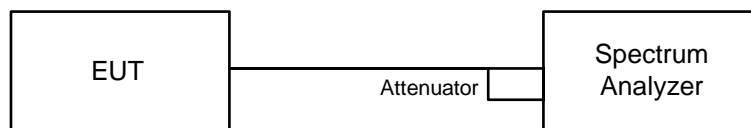

6.5.2 Test Procedure

- p. Check the calibration of the measuring instrument using either an internal calibrator or a known signal from an external generator.
- q. Turn on the EUT and connect it to measurement instrument. Then set it to any one convenient frequency within its operating range. Set a reference level on the measuring instrument equal to the highest peak value.
- r. Measure the frequency difference of two frequencies that were attenuated 20 dB from the reference level. Record the frequency difference as the emission bandwidth.
- s. Repeat above procedures until all frequencies measured were complete.

6.6 Conducted Out of Band Emissions

6.6.1 Test Setup

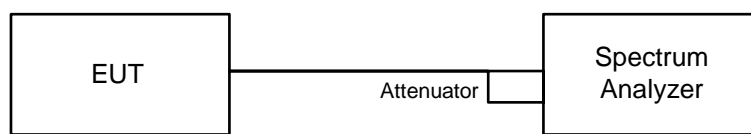

6.6.2 Test Procedure

MEASUREMENT PROCEDURE REF

- t. Set the RBW = 100 kHz.
- u. Set the VBW \geq 300 kHz.
- v. Detector = peak.
- w. Sweep time = auto couple.
- x. Trace mode = max hold.
- y. Allow trace to fully stabilize.
- z. Use the peak marker function to determine the maximum power level in any 100 kHz band segment within the fundamental EBW.

MEASUREMENT PROCEDURE OOB

- a. Set RBW = 100 kHz.
- b. Set VBW \geq 300 kHz.
- c. Detector = peak.
- d. Sweep = auto couple.
- e. Trace Mode = max hold.
- f. Allow trace to fully stabilize.
- g. Use the peak marker function to determine the maximum amplitude level.

6.7 AC Power Conducted Emissions

6.7.1 Test Setup

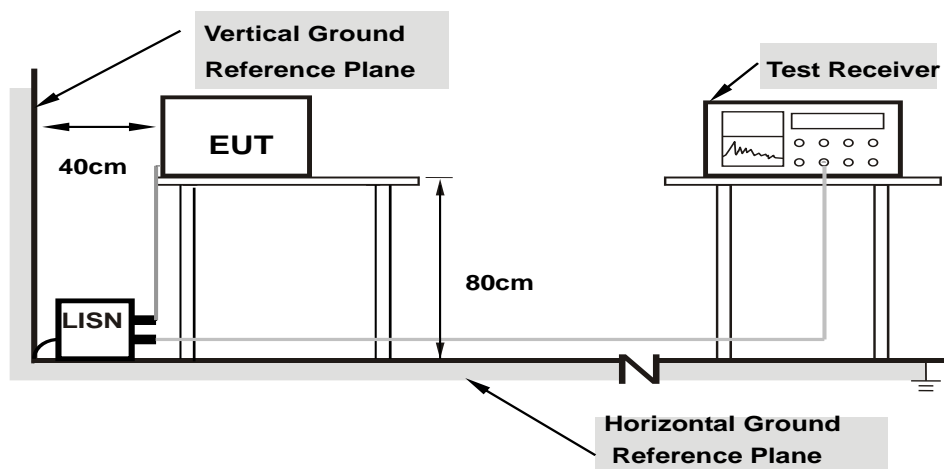

Note: 1.Support units were connected to second LISN.

For the actual test configuration, please refer to the attached file (Test Setup Photo).

6.7.2 Test Procedure

- h. The EUT was placed on a 0.8 meter to the top of table and placed 0.4 meters from the conducting wall of the shielded room with EUT being connected to the power mains through a line impedance stabilization network (LISN). Other support units were connected to the power mains through another LISN. The two LISNs provide 50 ohm/ 50 uH of coupling impedance for the measuring instrument.
- i. Both lines of the power mains connected to the EUT were checked for maximum conducted interference.
- j. The frequency range from 150 kHz to 30 MHz was searched. Emission levels under (Limit – 20 dB) was not recorded.

Note: The resolution bandwidth and video bandwidth of test receiver is 9 kHz for quasi-peak detection (QP) and average detection (AV) at frequency 0.15 MHz-30 MHz.

6.8 Unwanted Emissions below 1 GHz

6.8.1 Test Setup

For Radiated emission below 30 MHz

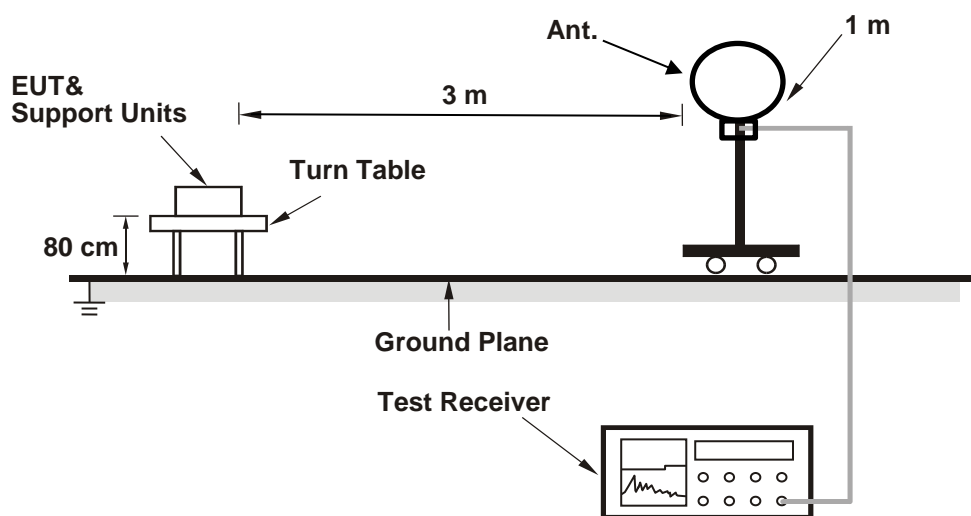

For Radiated emission above 30 MHz

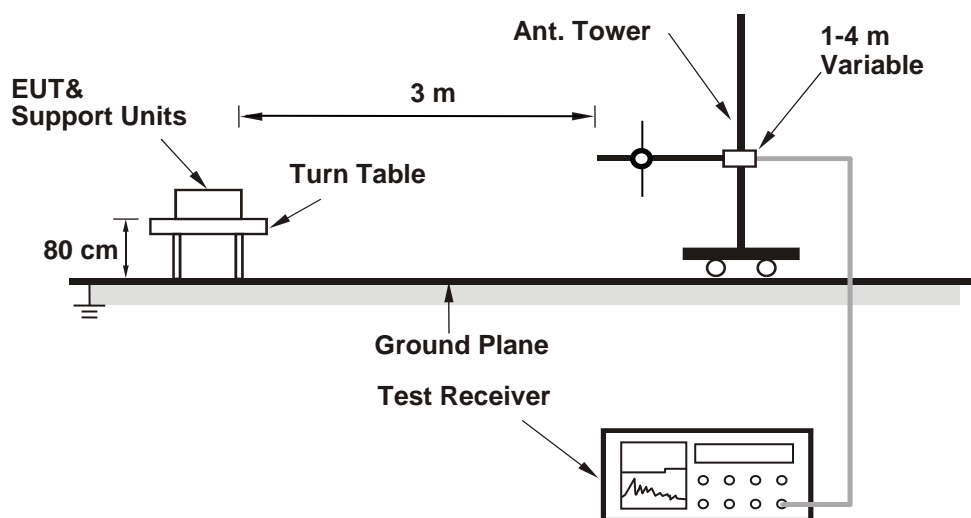

For the actual test configuration, please refer to the attached file (Test Setup Photo).

6.8.2 Test Procedure

For Radiated emission below 30 MHz

- k. The EUT was placed on the top of a rotating table 0.8 meters above the ground at 3 meter chamber room for test. The table was rotated 360 degrees to determine the position of the highest radiation.
- l. The EUT was set 3 meters away from the interference-receiving antenna, which was mounted on the top of a variable-height antenna tower.
- m. Parallel, perpendicular, and ground-parallel orientations of the antenna are set to make the measurement.
- n. For each suspected emission, the EUT was arranged to its worst case and the rotatable table was turned from 0 degrees to 360 degrees to find the maximum reading.
- o. The test-receiver system was set to Quasi-Peak Detect Function and Specified Bandwidth with Maximum Hold Mode, except for the frequency band (9 kHz to 90 kHz and 110 kHz to 490 kHz) set to average detect function and peak detect function.

Notes:

- 8. The resolution bandwidth and video bandwidth of test receiver/spectrum analyzer is 200 Hz at frequency below 150 kHz.
- 9. The resolution bandwidth and video bandwidth of test receiver/spectrum analyzer is 9 kHz or 10 kHz at frequency (150 kHz to 30 MHz).
- 10. All modes of operation were investigated and the worst-case emissions are reported.

For Radiated emission above 30 MHz

- p. The EUT was placed on the top of a rotating table 0.8 meters above the ground at 3 meter chamber room for test. The table was rotated 360 degrees to determine the position of the highest radiation.
- q. The EUT was set 3 meters away from the interference-receiving antenna, which was mounted on the top of a variable-height antenna tower.
- r. The height of antenna is varied from one meter to four meters above the ground to determine the maximum value of the field strength. Both horizontal and vertical polarizations of the antenna are set to make the measurement.
- s. For each suspected emission, the EUT was arranged to its worst case and then the antenna was tuned to heights from 1 meter to 4 meters and the rotatable table was turned from 0 degrees to 360 degrees to find the maximum reading.
- t. The test-receiver system was set to quasi-peak detect function and specified bandwidth with maximum hold mode when the test frequency is below 1 GHz.

Notes:

- 1. The resolution bandwidth and video bandwidth of test receiver/spectrum analyzer is 120 kHz for Quasi-peak detection (QP) at frequency below 1 GHz.
- 2. All modes of operation were investigated and the worst-case emissions are reported.

6.9 Unwanted Emissions above 1 GHz

6.9.1 Test Setup

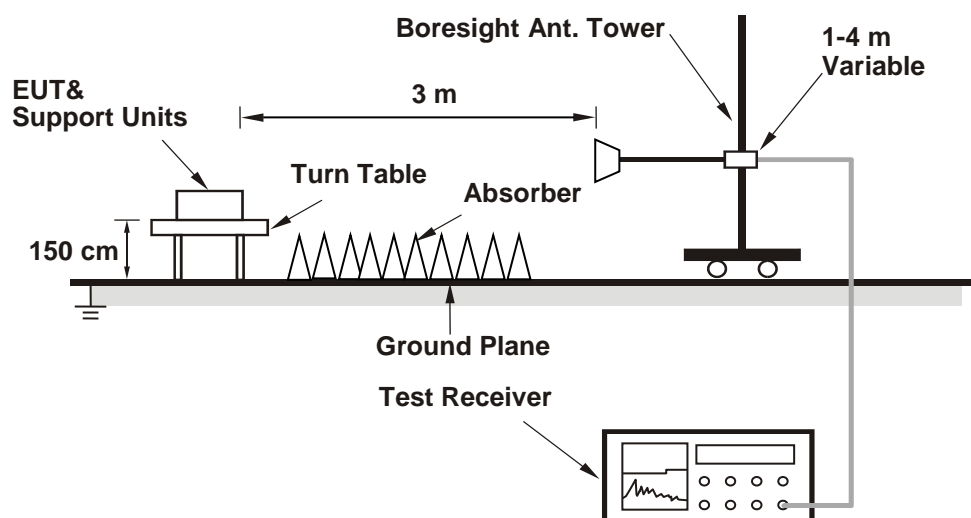

For the actual test configuration, please refer to the attached file (Test Setup Photo).

6.9.2 Test Procedure

- u. The EUT was placed on the top of a rotating table 1.5 meters above the ground at 3 meter chamber room for test. The table was rotated 360 degrees to determine the position of the highest radiation.
- v. The EUT was set 3 meters away from the interference-receiving antenna, which was mounted on the top of a variable-height antenna tower.
- w. The height of antenna is varied from one meter to four meters above the ground to determine the maximum value of the field strength. Both horizontal and vertical polarizations of the antenna are set to make the measurement.
- x. For each suspected emission, the EUT was arranged to its worst case and then the antenna was tuned to heights from 1 meter to 4 meters and the rotatable table was turned from 0 degrees to 360 degrees to find the maximum reading.
- y. The test-receiver system was set to peak and average detects function and specified bandwidth with maximum hold mode when the test frequency is above 1 GHz. If the peak reading value also meets average limit, measurement with the average detector is unnecessary.

Notes:

3. The resolution bandwidth of test receiver/spectrum analyzer is 1 MHz and the video bandwidth is 3 MHz for Peak detection (PK) and Average detection (AV) at frequency above 1 GHz.
4. According to ANSI C63.10 section 6.6.4 and 4.1.4.2.2. For fundamental and harmonic signal measurement, according to ANSI C63.10 section 7.5, the average value = peak value + duty cycle correction factor. For duty cycle correction factor values, see the Test Signal Duty Cycle section in this report.
5. All modes of operation were investigated and the worst-case emissions are reported.

7 Test Results of Test Item

7.1 RF Output Power

Input Power:	3.3 Vdc	Environmental Conditions:	25°C, 60% RH	Tested By:	Katina Lu
--------------	---------	---------------------------	--------------	------------	-----------

For Peak Power

GFSK Low Power

Chan.	Chan. Freq. (MHz)	Peak Power (mW)	Peak Power (dBm)	Power Limit (dBm)	Test Result
0	2402	4.305	6.34	21	Pass
39	2441	4.325	6.36	21	Pass
78	2480	4.083	6.11	21	Pass

Note: The antenna gain is 3.4 dBi < 6 dBi, so the output power limit shall not be reduced.

8DPSK Low Power

Chan.	Chan. Freq. (MHz)	Peak Power (mW)	Peak Power (dBm)	Power Limit (dBm)	Test Result
0	2402	7.379	8.68	21	Pass
39	2441	7.328	8.65	21	Pass
78	2480	7.907	8.98	21	Pass

Note: The antenna gain is 3.4 dBi < 6 dBi, so the output power limit shall not be reduced.

GFSK High Power

Chan.	Chan. Freq. (MHz)	Peak Power (mW)	Peak Power (dBm)	Power Limit (dBm)	Test Result
0	2402	18.621	12.70	21	Pass
39	2441	17.378	12.40	21	Pass
78	2480	15.56	11.92	21	Pass

Note: The antenna gain is 3.4 dBi < 6 dBi, so the output power limit shall not be reduced.

8DPSK High Power

Chan.	Chan. Freq. (MHz)	Peak Power (mW)	Peak Power (dBm)	Power Limit (dBm)	Test Result
0	2402	19.364	12.87	21	Pass
39	2441	15.596	11.93	21	Pass
78	2480	15.346	11.86	21	Pass

Note: The antenna gain is 3.4 dBi < 6 dBi, so the output power limit shall not be reduced.

For Average Power

GFSK Low Power

Chan.	Chan. Freq. (MHz)	Average Power (mW)	Average Power (dBm)
0	2402	3.945	5.96
39	2441	3.936	5.95
78	2480	3.828	5.83

8DPSK Low Power

Chan.	Chan. Freq. (MHz)	Average Power (mW)	Average Power (dBm)
0	2402	3.837	5.84
39	2441	3.855	5.86
78	2480	4.055	6.08

GFSK High Power

Chan.	Chan. Freq. (MHz)	Average Power (mW)	Average Power (dBm)
0	2402	17.298	12.38
39	2441	16.444	12.16
78	2480	16.672	12.22

8DPSK High Power

Chan.	Chan. Freq. (MHz)	Average Power (mW)	Average Power (dBm)
0	2402	11.402	10.57
39	2441	8.61	9.35
78	2480	8.511	9.30



7.2 Number of Hopping Frequency Used

Input Power:	3.3 Vdc	Environmental Conditions:	25°C, 60% RH	Tested By:	Katina Lu
--------------	---------	---------------------------	--------------	------------	-----------

GFSK Low Power

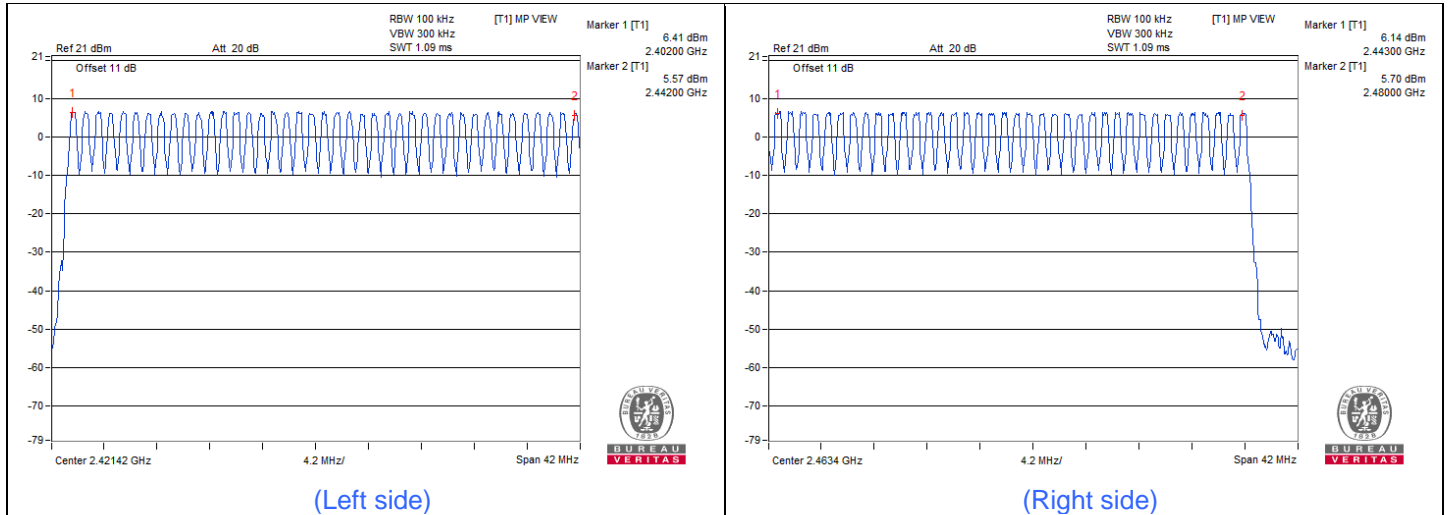

Note: There are 79 hopping frequencies in the hopping mode. On the plots, it shows that the hopping frequencies are equally spaced.

8DPSK Low Power

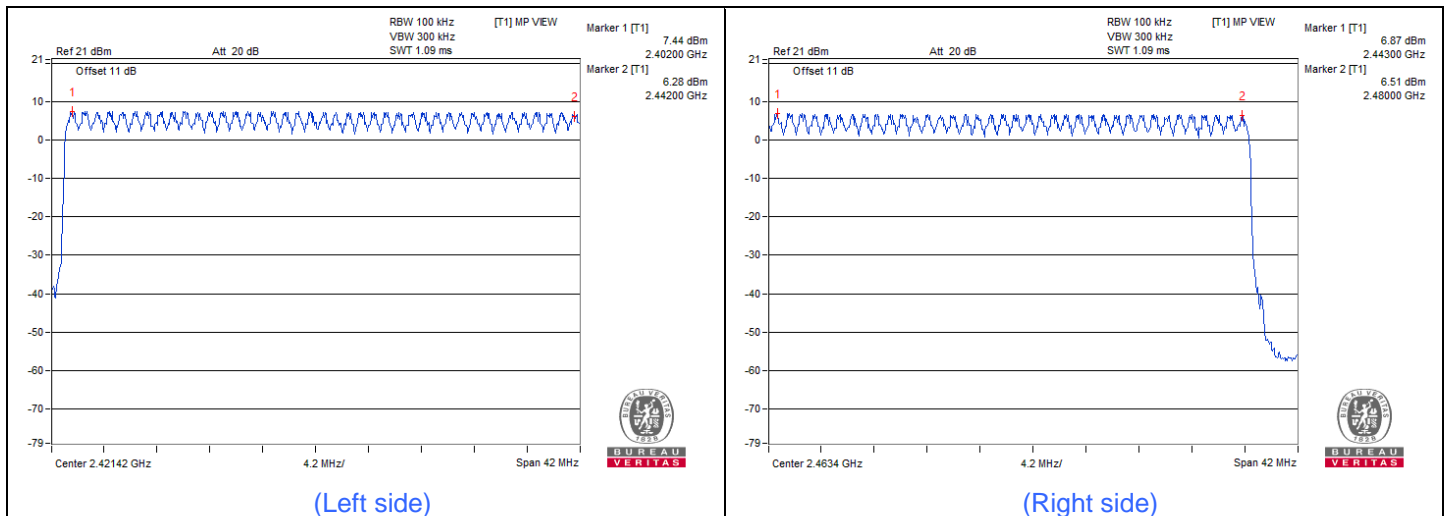

Note: There are 79 hopping frequencies in the hopping mode. On the plots, it shows that the hopping frequencies are equally spaced.

GFSK High Power

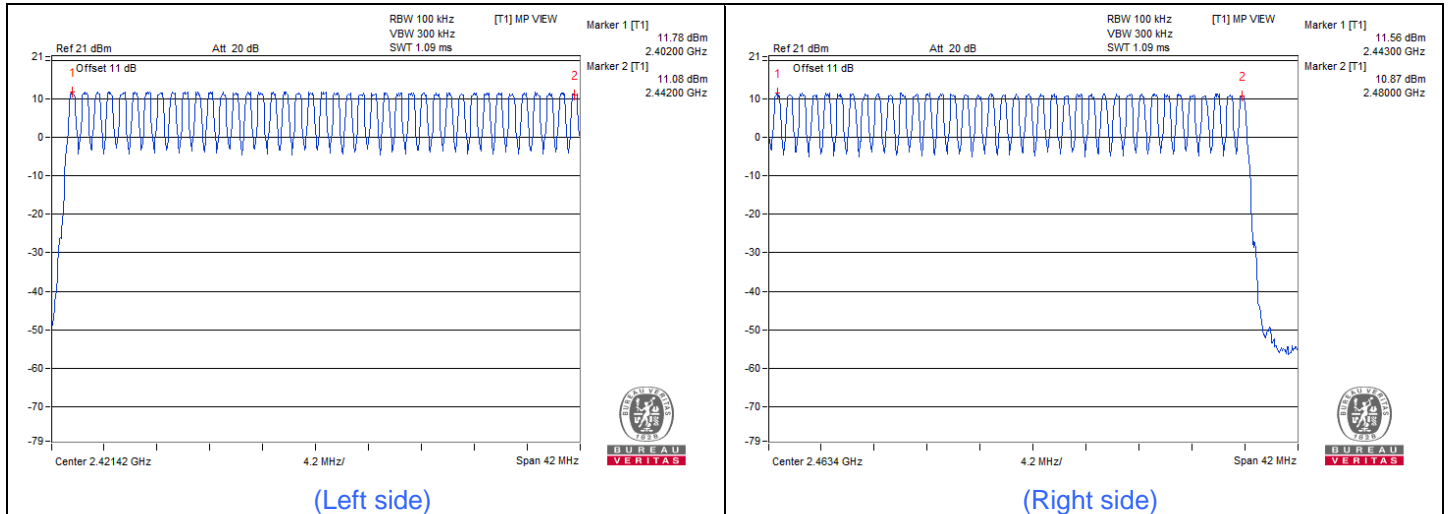

Note: There are 79 hopping frequencies in the hopping mode. On the plots, it shows that the hopping frequencies are equally spaced.

8DPSK High Power

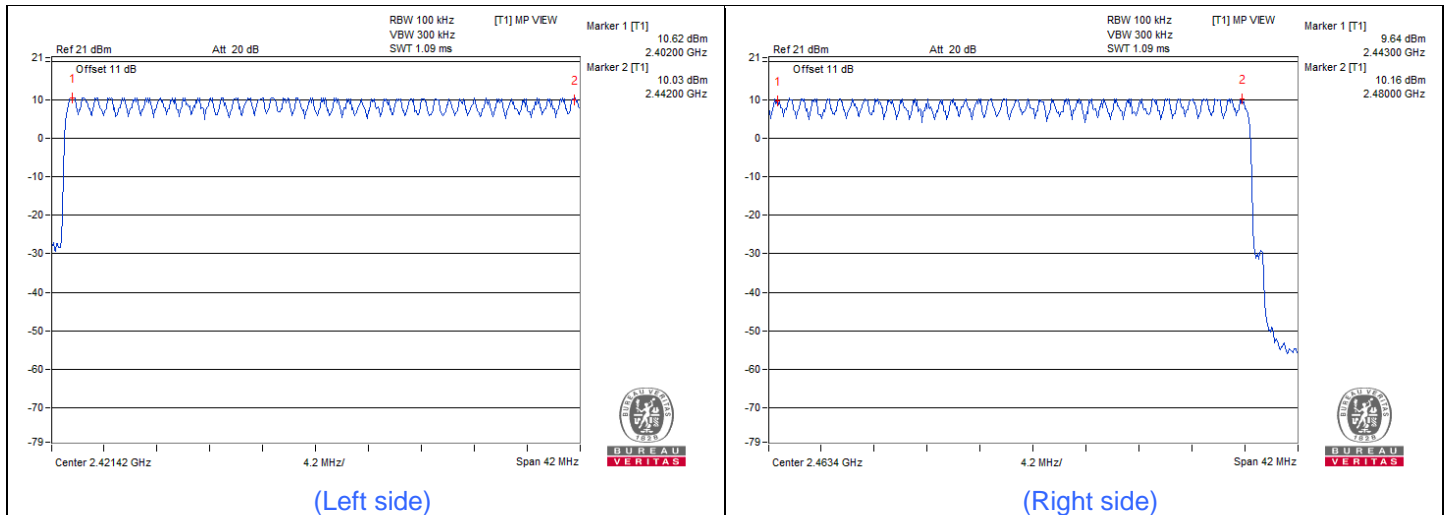

Note: There are 79 hopping frequencies in the hopping mode. On the plots, it shows that the hopping frequencies are equally spaced.

7.3 Dwell Time on Each Channel

Input Power:	3.3 Vdc	Environmental Conditions:	25°C, 60% RH	Tested By:	Katina Lu
--------------	---------	---------------------------	--------------	------------	-----------

GFSK Low Power

Mode	Number of transmission in 31.6 sec	Length of transmission time (msec)	Result (msec)	Limit (msec)	Test Result
DH1	50 (times / 5 sec) * 6.32 = 316 times	0.456	144.1	400	Pass
DH3	23 (times / 5 sec) * 6.32 = 146 times	1.7	248.2	400	Pass
DH5	15 (times / 5 sec) * 6.32 = 95 times	3.056	290.32	400	Pass



8DPSK Low Power

Mode	Number of transmission in 31.6 sec	Length of transmission time (msec)	Result (msec)	Limit (msec)	Test Result
3DH1	51 (times / 5 sec) * 6.32 = 323 times	0.432	139.54	400	Pass
3DH3	27 (times / 5 sec) * 6.32 = 171 times	1.76	300.96	400	Pass
3DH5	17 (times / 5 sec) * 6.32 = 108 times	3.024	326.59	400	Pass

Spectrum plots of Dwell Time

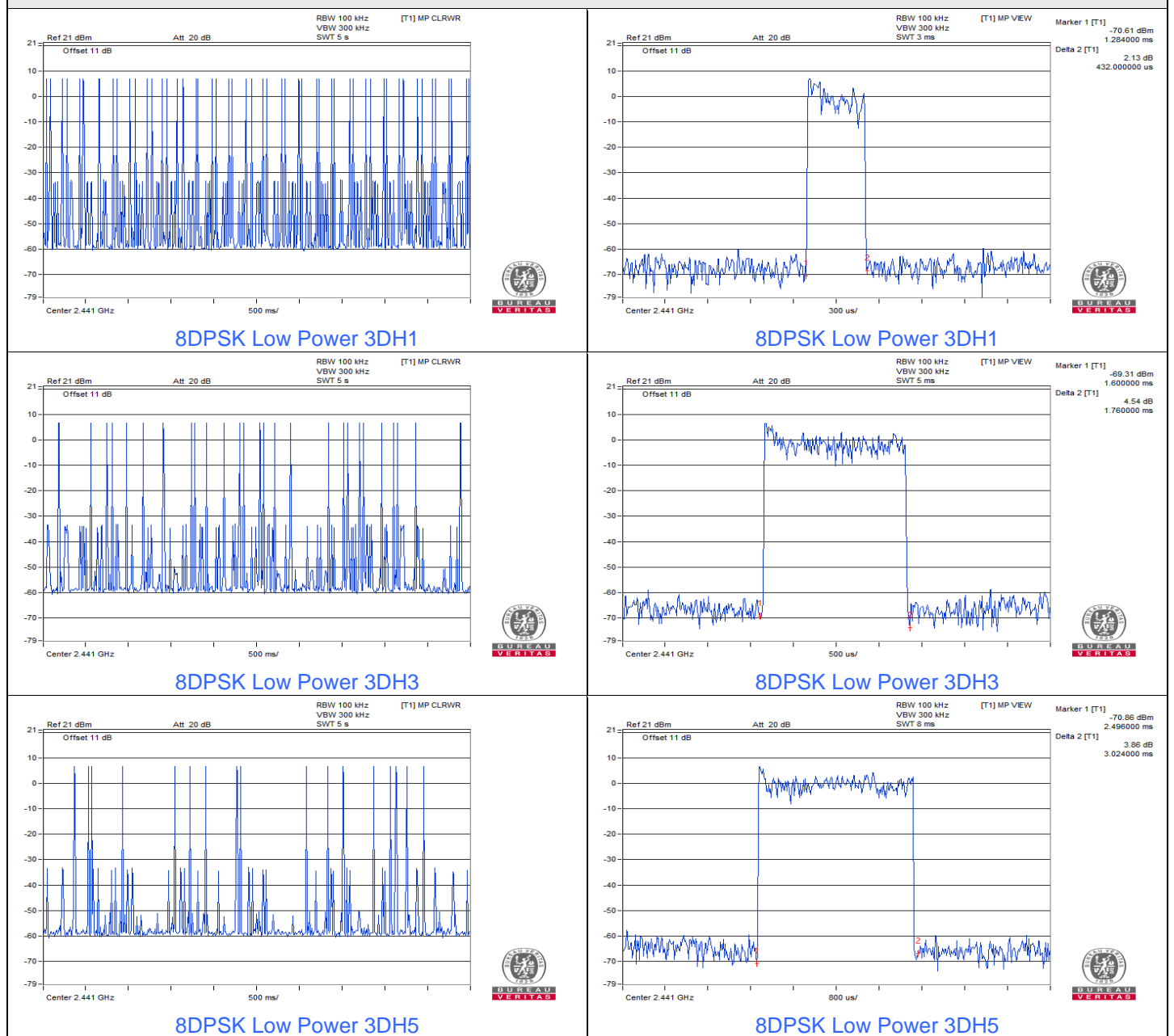

GFSK High Power

Mode	Number of transmission in 31.6 sec	Length of transmission time (msec)	Result (msec)	Limit (msec)	Test Result
DH1	50 (times / 5 sec) * 6.32 = 316 times	0.438	138.41	400	Pass
DH3	25 (times / 5 sec) * 6.32 = 158 times	1.69	267.02	400	Pass
DH5	18 (times / 5 sec) * 6.32 = 114 times	2.944	335.62	400	Pass

Spectrum plots of Dwell Time

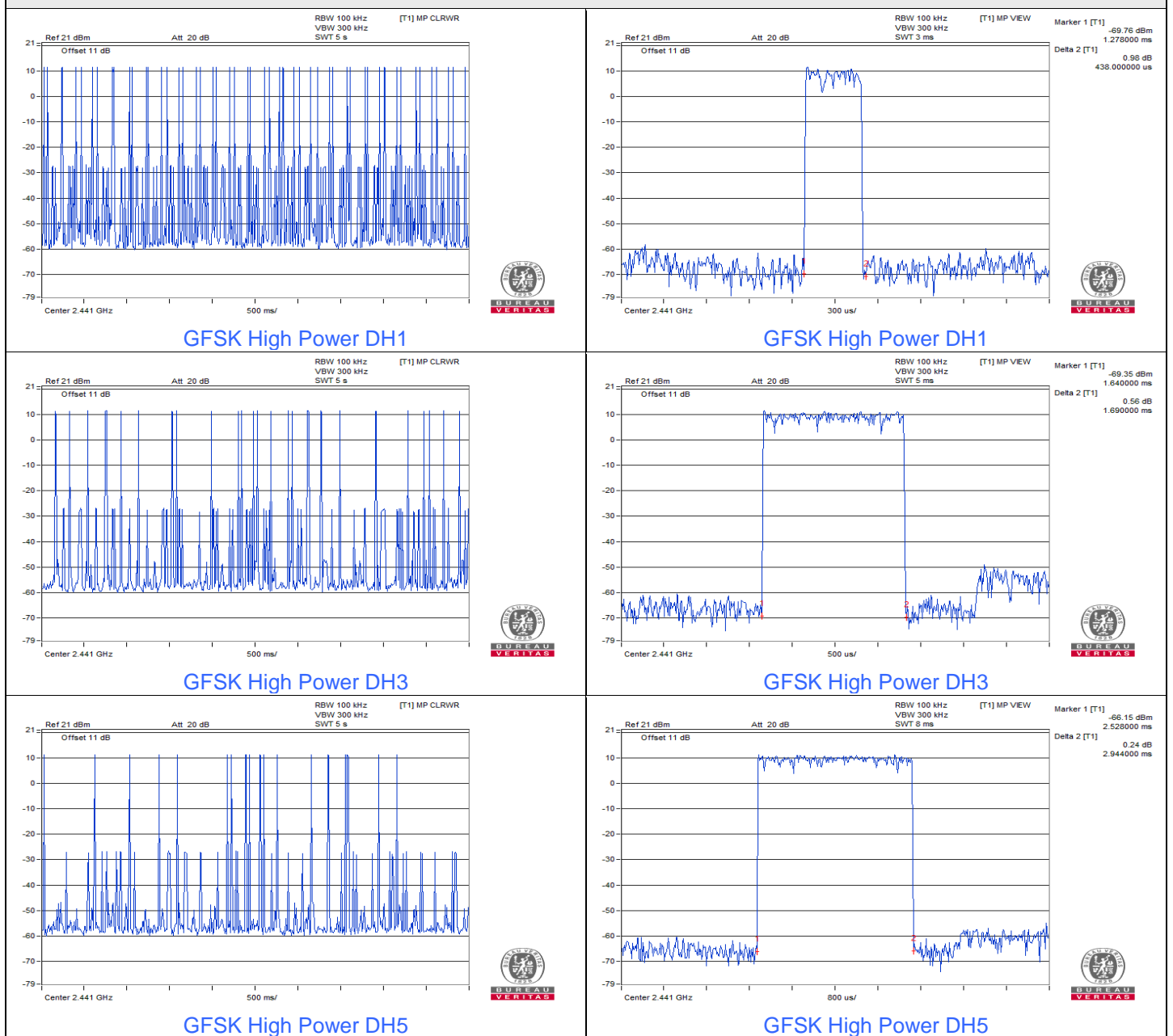

8DPSK High Power

Mode	Number of transmission in 31.6 sec	Length of transmission time (msec)	Result (msec)	Limit (msec)	Test Result
3DH1	50 (times / 5 sec) * 6.32 = 316 times	0.474	149.78	400	Pass
3DH3	27 (times / 5 sec) * 6.32 = 171 times	1.7	290.7	400	Pass
3DH5	17 (times / 5 sec) * 6.32 = 108 times	2.96	319.68	400	Pass

Spectrum plots of Dwell Time



7.4 Hopping Channel Separation

Input Power:	3.3 Vdc	Environmental Conditions:	25°C, 60% RH	Tested By:	Katina Lu
--------------	---------	---------------------------	--------------	------------	-----------

GFSK Low Power

Channel	Frequency (MHz)	Hopping Channel Separation (MHz)	Minimum Limit (MHz)	Test Result
0	2402	1.00	0.64	Pass
39	2441	1.00	0.64	Pass
78	2480	1.00	0.64	Pass

Note: The minimum limit is two-third 20dB bandwidth.

8DPSK Low Power

Channel	Frequency (MHz)	Hopping Channel Separation (MHz)	Minimum Limit (MHz)	Test Result
0	2402	1.00	0.87	Pass
39	2441	1.00	0.86	Pass
78	2480	1.00	0.86	Pass

Note: The minimum limit is two-third 20dB bandwidth.

GFSK High Power

Channel	Frequency (MHz)	Hopping Channel Separation (MHz)	Minimum Limit (MHz)	Test Result
0	2402	1.00	0.64	Pass
39	2441	1.00	0.64	Pass
78	2480	1.00	0.64	Pass

Note: The minimum limit is two-third 20dB bandwidth.

8DPSK High Power

Channel	Frequency (MHz)	Hopping Channel Separation (MHz)	Minimum Limit (MHz)	Test Result
0	2402	1.00	0.87	Pass
39	2441	1.00	0.87	Pass
78	2480	1.00	0.87	Pass

Note: The minimum limit is two-third 20dB bandwidth.

Spectrum Plot of Minimum Value

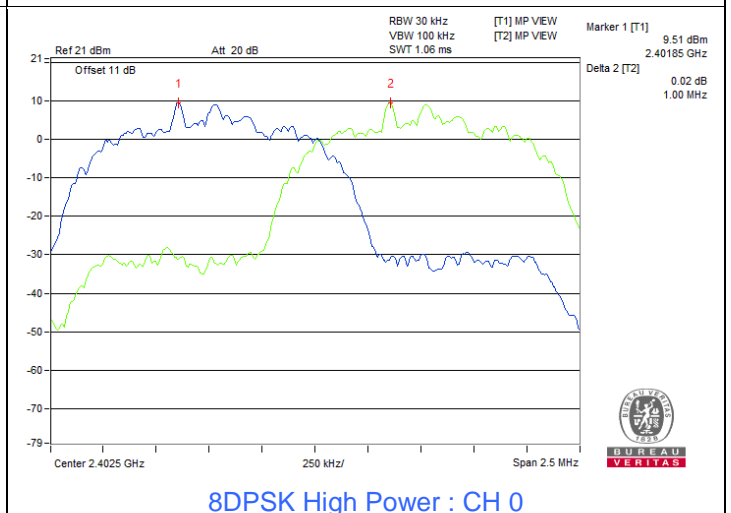
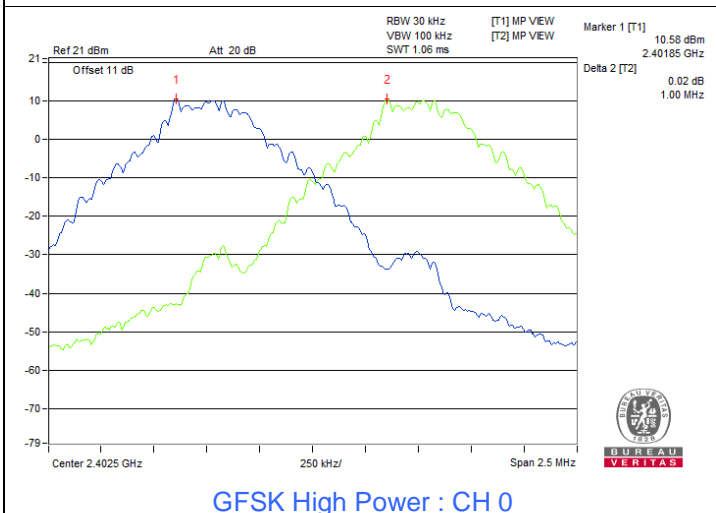
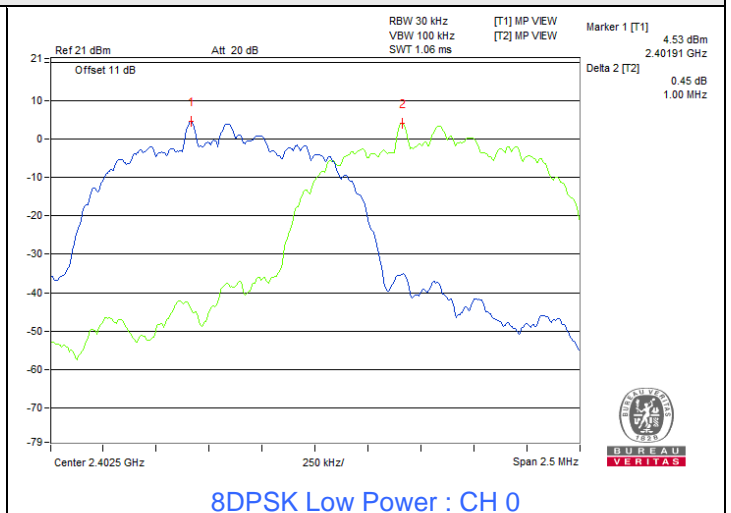
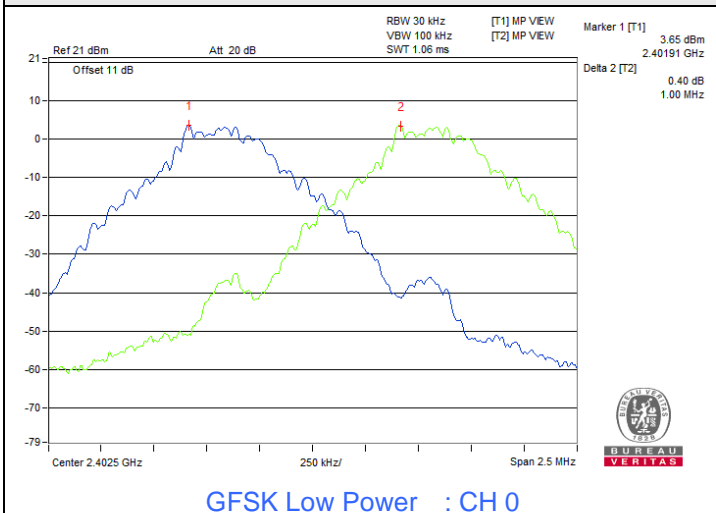

7.5 20 dB Bandwidth

Input Power:	3.3 Vdc	Environmental Conditions:	25°C, 60% RH	Tested By:	Katina Lu
--------------	---------	---------------------------	--------------	------------	-----------

GFSK Low Power

Channel	Frequency (MHz)	20dB Bandwidth (MHz)
0	2402	0.96
39	2441	0.96
78	2480	0.96

8DPSK Low Power

Channel	Frequency (MHz)	20dB Bandwidth (MHz)
0	2402	1.3
39	2441	1.29
78	2480	1.29

GFSK High Power

Channel	Frequency (MHz)	20dB Bandwidth (MHz)
0	2402	0.96
39	2441	0.96
78	2480	0.96

8DPSK High Power

Channel	Frequency (MHz)	20dB Bandwidth (MHz)
0	2402	1.3
39	2441	1.3
78	2480	1.3



Spectrum Plot of Minimum Value

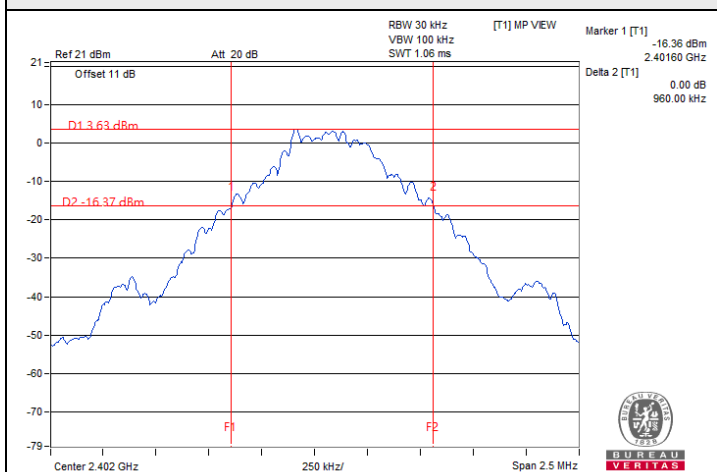

GFSK Low Power : CH 0

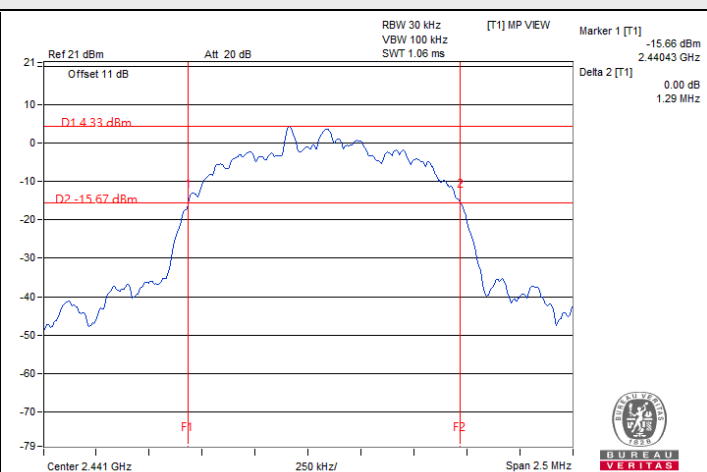

8DPSK Low Power : CH 39

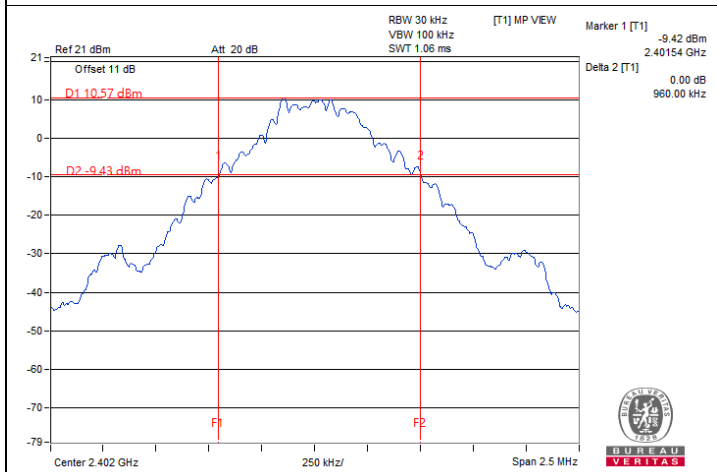

GFSK High Power : CH 0

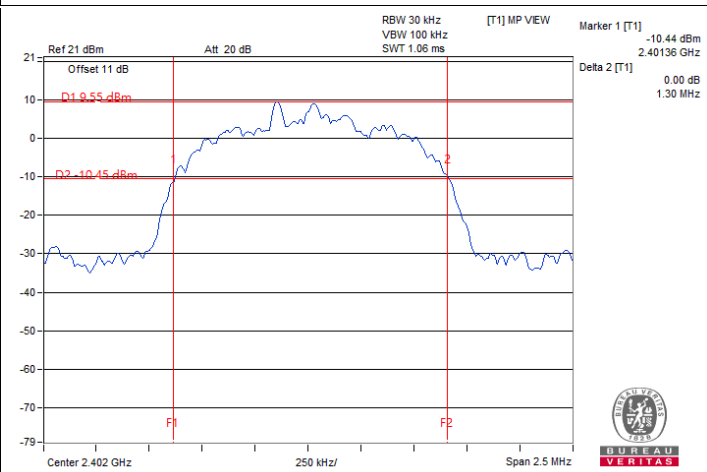

8DPSK High Power : CH 0



7.6 Conducted Out of Band Emissions

Input Power:	3.3 Vdc	Environmental Conditions:	25°C, 60% RH	Tested By:	Katina Lu
--------------	---------	---------------------------	--------------	------------	-----------

GFSK Low Power





8DPSK Low Power





GFSK High Power

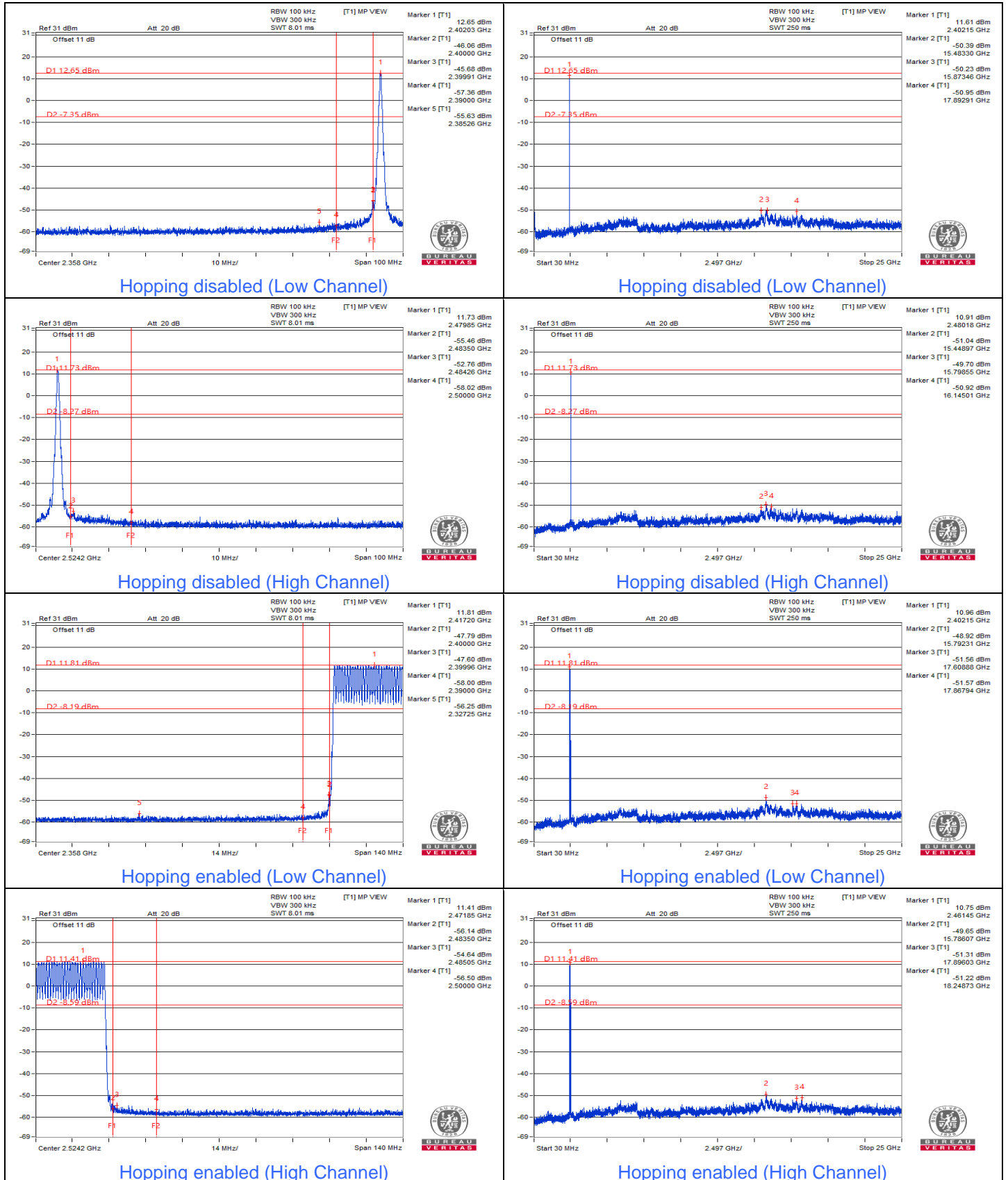



8DPSK High Power

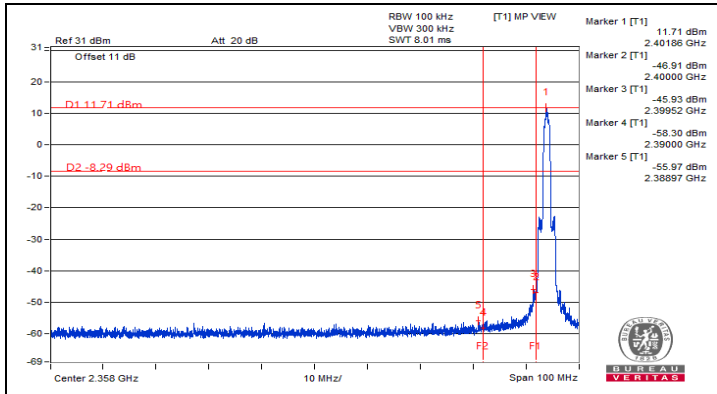

Hopping disabled (Low Channel)

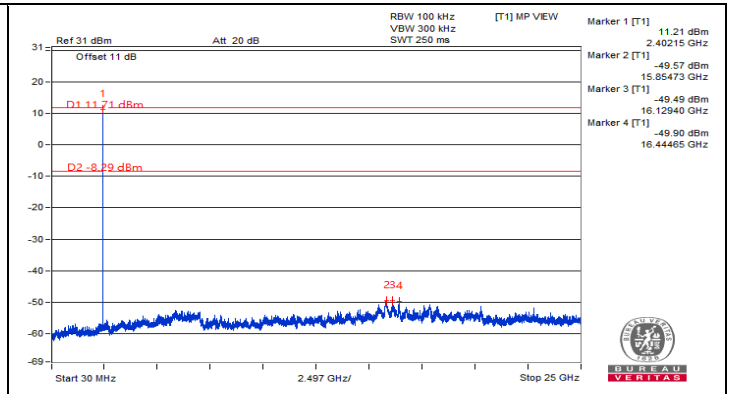

Hopping disabled (Low Channel)

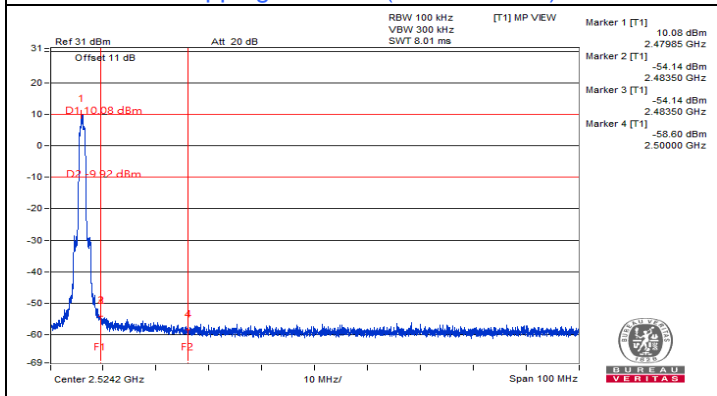

Hopping disabled (High Channel)

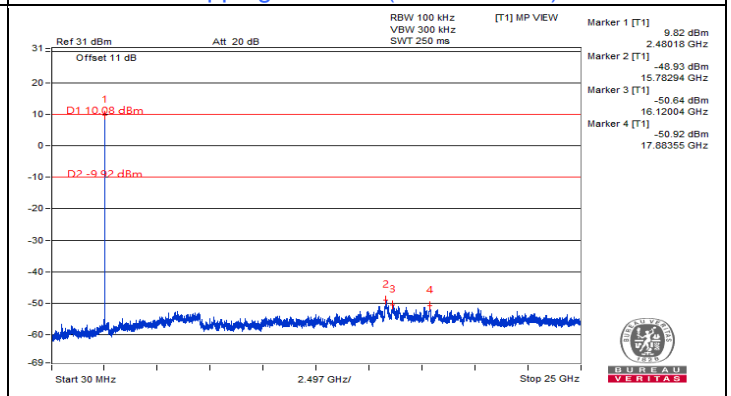

Hopping disabled (High Channel)

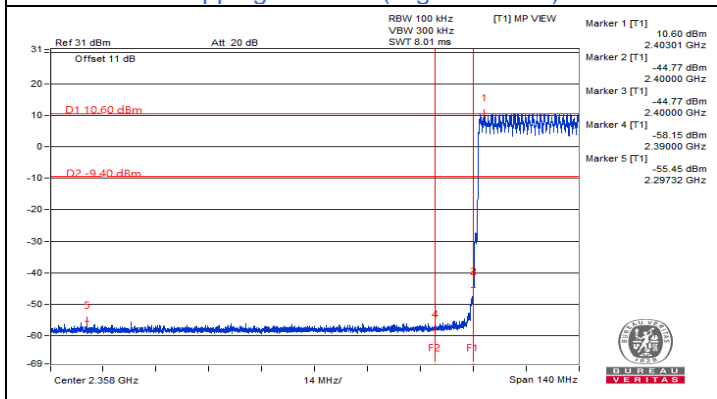

Hopping enabled (Low Channel)

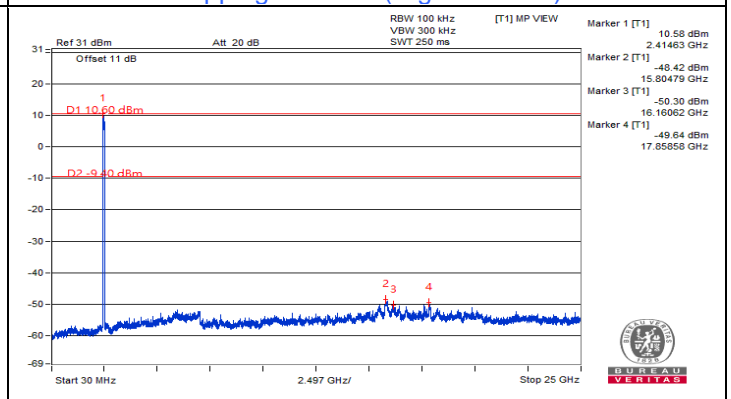

Hopping enabled (Low Channel)

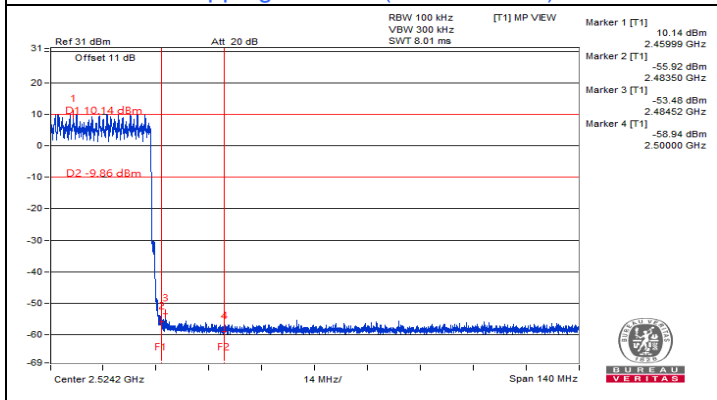

Hopping enabled (High Channel)

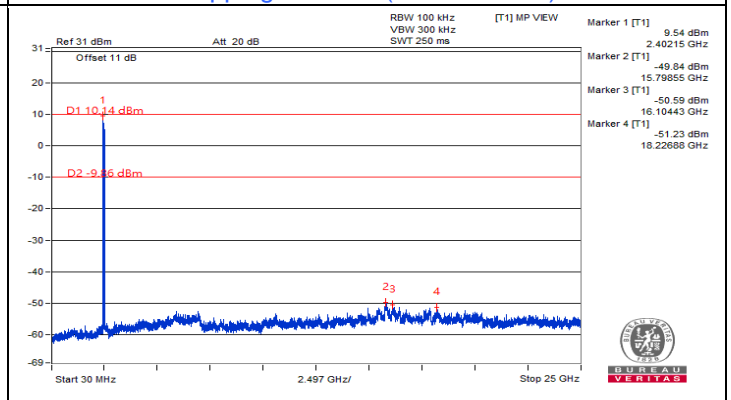

Hopping enabled (High Channel)

7.7 AC Power Conducted Emissions

Mode B

RF Mode	BT 8DPSK	Channel	CH 78 : 2480 MHz
Frequency Range	150kHz ~ 30MHz	Detector Function & Resolution Bandwidth	Quasi-Peak (QP) / Average (AV), 9 kHz
Input Power (System)	120 Vac, 60 Hz	Environmental Conditions	23°C, 71% RH
Tested By	Sampson Chen		

Phase Of Power : Line (L)										
No	Frequency (MHz)	Correction Factor (dB)	Reading Value (dBuV)		Emission Level (dBuV)		Limit (dBuV)		Margin (dB)	
			Q.P.	AV.	Q.P.	AV.	Q.P.	AV.	Q.P.	AV.
1	0.18516	9.96	44.73	29.93	54.69	39.89	64.25	54.25	-9.56	-14.36
2	0.24375	9.96	35.94	20.34	45.90	30.30	61.97	51.97	-16.07	-21.67
3	0.32578	9.97	26.30	6.57	36.27	16.54	59.56	49.56	-23.29	-33.02
4	3.82031	10.14	30.11	21.93	40.25	32.07	56.00	46.00	-15.75	-13.93
5	5.17969	10.22	23.72	16.82	33.94	27.04	60.00	50.00	-26.06	-22.96
6	28.29281	11.23	30.60	23.49	41.83	34.72	60.00	50.00	-18.17	-15.28

Remarks:

1. Q.P. and AV. are abbreviations of quasi-peak and average individually.
2. The emission levels of other frequencies were very low against the limit.
3. Margin value = Emission level – Limit value
4. Correction factor = Insertion loss + Cable loss
5. Emission Level = Correction Factor + Reading Value

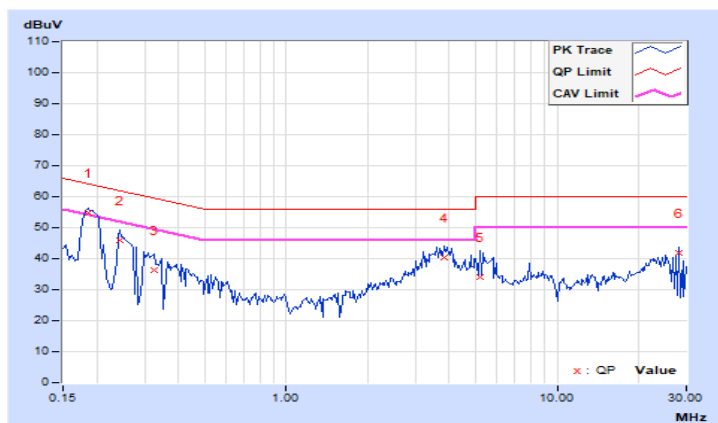

RF Mode	BT 8DPSK	Channel	CH 78 : 2480 MHz
Frequency Range	150kHz ~ 30MHz	Detector Function & Resolution Bandwidth	Quasi-Peak (QP) / Average (AV), 9 kHz
Input Power (System)	120 Vac, 60 Hz	Environmental Conditions	23°C, 71% RH
Tested By	Sampson Chen		

Phase Of Power : Neutral (N)										
No	Frequency (MHz)	Correction Factor (dB)	Reading Value (dBuV)		Emission Level (dBuV)		Limit (dBuV)		Margin (dB)	
			Q.P.	AV.	Q.P.	AV.	Q.P.	AV.	Q.P.	AV.
1	0.18516	9.94	44.89	29.91	54.83	39.85	64.25	54.25	-9.42	-14.40
2	0.25156	9.94	34.83	18.22	44.77	28.16	61.71	51.71	-16.94	-23.55
3	0.31797	9.94	27.60	10.39	37.54	20.33	59.76	49.76	-22.22	-29.43
4	3.80469	10.09	30.09	22.10	40.18	32.19	56.00	46.00	-15.82	-13.81
5	28.26750	10.87	31.50	23.31	42.37	34.18	60.00	50.00	-17.63	-15.82
6	28.31250	10.87	28.03	14.04	38.90	24.91	60.00	50.00	-21.10	-25.09

Remarks:

1. Q.P. and AV. are abbreviations of quasi-peak and average individually.
2. The emission levels of other frequencies were very low against the limit.
3. Margin value = Emission level – Limit value
4. Correction factor = Insertion loss + Cable loss
5. Emission Level = Correction Factor + Reading Value

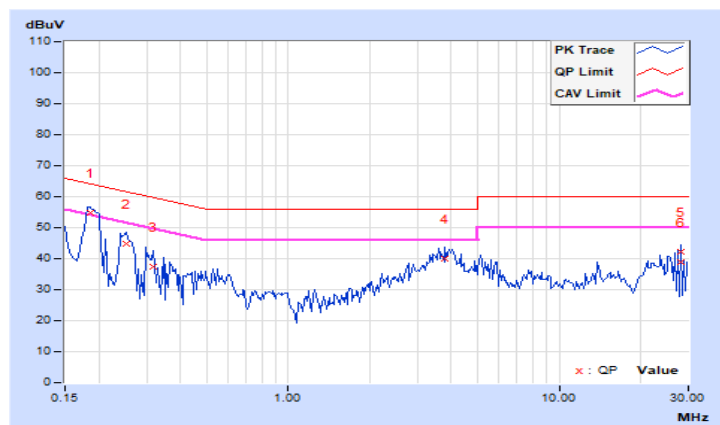

Mode E

RF Mode	BT GFSK	Channel	CH 0 : 2402 MHz
Frequency Range	150kHz ~ 30MHz	Detector Function & Resolution Bandwidth	Quasi-Peak (QP) / Average (AV), 9 kHz
Input Power (System)	120 Vac, 60 Hz	Environmental Conditions	23°C, 71% RH
Tested By	Sampson Chen		

Phase Of Power : Line (L)										
No	Frequency (MHz)	Correction Factor (dB)	Reading Value (dBuV)		Emission Level (dBuV)		Limit (dBuV)		Margin (dB)	
			Q.P.	AV.	Q.P.	AV.	Q.P.	AV.	Q.P.	AV.
1	0.18516	9.96	44.63	29.79	54.59	39.75	64.25	54.25	-9.66	-14.50
2	0.25938	9.96	33.00	13.84	42.96	23.80	61.45	51.45	-18.49	-27.65
3	0.32578	9.97	26.95	5.51	36.92	15.48	59.56	49.56	-22.64	-34.08
4	3.92578	10.15	29.72	21.72	39.87	31.87	56.00	46.00	-16.13	-14.13
5	5.16797	10.22	25.78	17.49	36.00	27.71	60.00	50.00	-24.00	-22.29
6	28.28516	11.23	31.90	29.27	43.13	40.50	60.00	50.00	-16.87	-9.50

Remarks:

1. Q.P. and AV. are abbreviations of quasi-peak and average individually.
2. The emission levels of other frequencies were very low against the limit.
3. Margin value = Emission level – Limit value
4. Correction factor = Insertion loss + Cable loss
5. Emission Level = Correction Factor + Reading Value

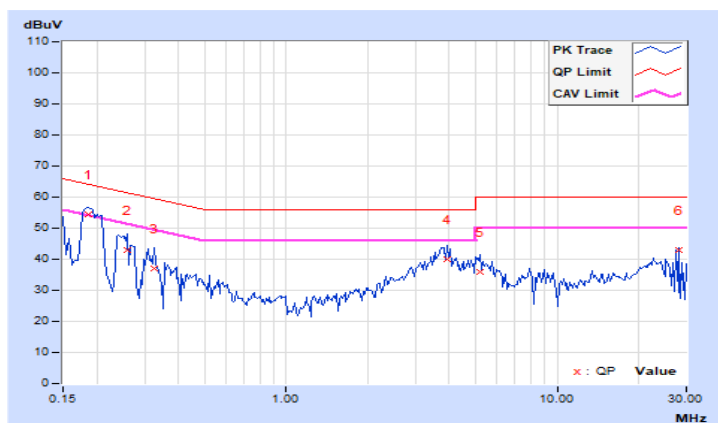

RF Mode	BT GFSK	Channel	CH 0 : 2402 MHz
Frequency Range	150kHz ~ 30MHz	Detector Function & Resolution Bandwidth	Quasi-Peak (QP) / Average (AV), 9 kHz
Input Power (System)	120 Vac, 60 Hz	Environmental Conditions	23°C, 71% RH
Tested By	Sampson Chen		

Phase Of Power : Neutral (N)										
No	Frequency (MHz)	Correction Factor (dB)	Reading Value (dBuV)		Emission Level (dBuV)		Limit (dBuV)		Margin (dB)	
			Q.P.	AV.	Q.P.	AV.	Q.P.	AV.	Q.P.	AV.
1	0.18516	9.94	44.93	30.77	54.87	40.71	64.25	54.25	-9.38	-13.54
2	0.24375	9.94	36.00	20.36	45.94	30.30	61.97	51.97	-16.03	-21.67
3	3.82422	10.09	30.79	22.03	40.88	32.12	56.00	46.00	-15.12	-13.88
4	13.95703	10.56	19.50	10.43	30.06	20.99	60.00	50.00	-29.94	-29.01
5	25.19531	10.86	26.29	18.14	37.15	29.00	60.00	50.00	-22.85	-21.00
6	28.27344	10.87	31.25	21.99	42.12	32.86	60.00	50.00	-17.88	-17.14

Remarks:

1. Q.P. and AV. are abbreviations of quasi-peak and average individually.
2. The emission levels of other frequencies were very low against the limit.
3. Margin value = Emission level – Limit value
4. Correction factor = Insertion loss + Cable loss
5. Emission Level = Correction Factor + Reading Value

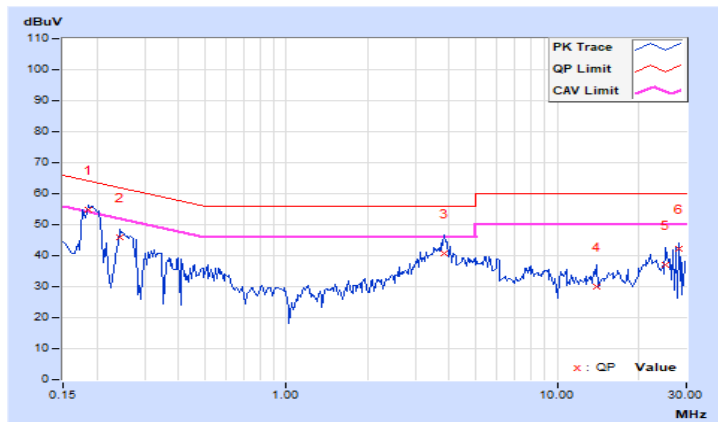

7.8 Unwanted Emissions below 1 GHz

Mode A

RF Mode	BT 8DPSK	Channel	CH 78 : 2480 MHz
Frequency Range	30 MHz ~ 1 GHz	Detector Function & Bandwidth	(QP) RB = 120kHz
Input Power (System)	120 Vac, 60 Hz	Environmental Conditions	28°C, 76% RH
Tested By	Louis Yang		

Antenna Polarity & Test Distance : Horizontal at 3 m								
No	Frequency (MHz)	Emission Level (dBuV/m)	Limit (dBuV/m)	Margin (dB)	Antenna Height (m)	Table Angle (Degree)	Raw Value (dBuV)	Correction Factor (dB/m)
1	43.30	32.0 QP	40.0	-8.0	1.12 H	360	44.9	-12.9
2	78.70	19.8 QP	40.0	-20.2	1.00 H	325	37.1	-17.3
3	235.30	31.4 QP	46.0	-14.6	1.52 H	360	46.2	-14.8
4	284.90	30.9 QP	46.0	-15.1	1.50 H	74	43.5	-12.6
5	384.30	21.3 QP	46.0	-24.7	1.05 H	360	31.6	-10.3
6	453.00	24.7 QP	46.0	-21.3	1.00 H	122	32.9	-8.2

Remarks:

1. Emission Level(dBuV/m) = Raw Value(dBuV) + Correction Factor(dB/m)
2. Correction Factor(dB/m) = Antenna Factor(dB/m) + Cable Factor(dB) – Pre-Amplifier Factor(dB)
3. Margin value = Emission Level – Limit value
4. The other emission levels were very low against the limit of frequency range 30 MHz ~ 1 GHz.
5. The emission levels were very low against the limit of frequency range 9 kHz ~ 30 MHz: the amplitude of spurious emissions attenuated more than 20 dB below the permissible value to be report.

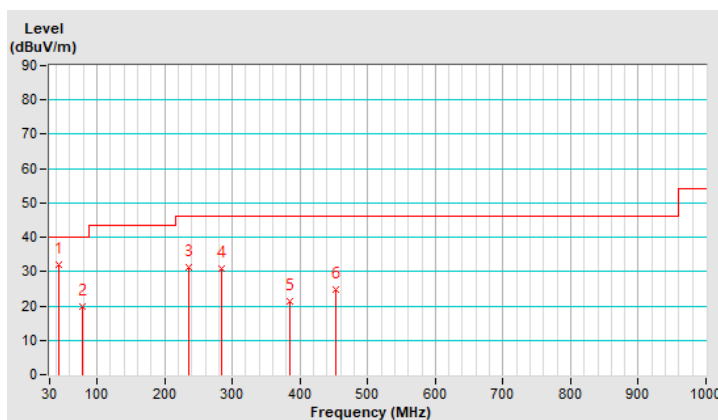

RF Mode	BT 8DPSK	Channel	CH 78 : 2480 MHz
Frequency Range	30 MHz ~ 1 GHz	Detector Function & Bandwidth	(QP) RB = 120kHz
Input Power (System)	120 Vac, 60 Hz	Environmental Conditions	28°C, 76% RH
Tested By	Louis Yang		

Antenna Polarity & Test Distance : Vertical at 3 m								
No	Frequency (MHz)	Emission Level (dBuV/m)	Limit (dBuV/m)	Margin (dB)	Antenna Height (m)	Table Angle (Degree)	Raw Value (dBuV)	Correction Factor (dB/m)
1	36.20	24.7 QP	40.0	-15.3	1.05 V	62	38.3	-13.6
2	137.22	26.4 QP	43.5	-17.1	1.00 V	325	39.8	-13.4
3	176.20	19.6 QP	43.5	-23.9	1.00 V	299	33.5	-13.9
4	231.10	33.3 QP	46.0	-12.7	1.00 V	172	48.6	-15.3
5	364.40	21.1 QP	46.0	-24.9	1.00 V	38	32.0	-10.9
6	637.40	23.6 QP	46.0	-22.4	1.12 V	355	28.2	-4.6

Remarks:

1. Emission Level(dBuV/m) = Raw Value(dBuV) + Correction Factor(dB/m)
2. Correction Factor(dB/m) = Antenna Factor(dB/m) + Cable Factor(dB) – Pre-Amplifier Factor(dB)
3. Margin value = Emission Level – Limit value
4. The other emission levels were very low against the limit of frequency range 30 MHz ~ 1 GHz.
5. The emission levels were very low against the limit of frequency range 9 kHz ~ 30 MHz: the amplitude of spurious emissions attenuated more than 20 dB below the permissible value to be report.

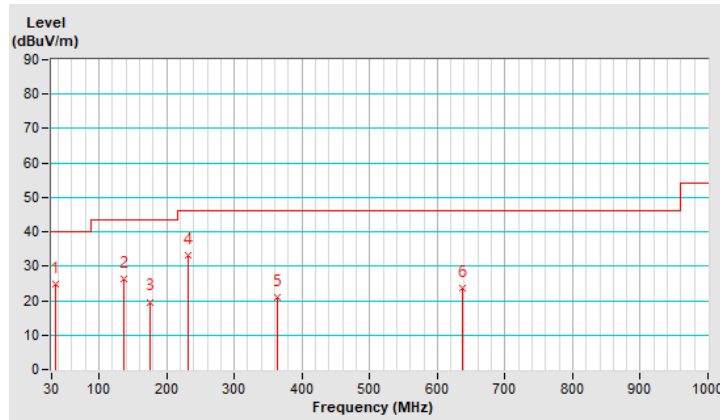

Mode B

RF Mode	BT 8DPSK	Channel	CH 78 : 2480 MHz
Frequency Range	30 MHz ~ 1 GHz	Detector Function & Bandwidth	(QP) RB = 120kHz
Input Power (System)	120 Vac, 60 Hz	Environmental Conditions	28°C, 76% RH
Tested By	Louis Yang		

Antenna Polarity & Test Distance : Horizontal at 3 m

No	Frequency (MHz)	Emission Level (dBuV/m)	Limit (dBuV/m)	Margin (dB)	Antenna Height (m)	Table Angle (Degree)	Raw Value (dBuV)	Correction Factor (dB/m)
1	43.70	29.5 QP	40.0	-10.5	1.12 H	360	42.4	-12.9
2	76.50	18.7 QP	40.0	-21.3	1.00 H	325	35.4	-16.7
3	234.40	31.3 QP	46.0	-14.7	1.52 H	360	46.2	-14.9
4	282.60	30.9 QP	46.0	-15.1	1.50 H	74	43.6	-12.7
5	380.40	22.9 QP	46.0	-23.1	1.05 H	360	33.3	-10.4
6	453.70	22.2 QP	46.0	-23.8	1.00 H	122	30.3	-8.1

Remarks:

1. Emission Level(dBuV/m) = Raw Value(dBuV) + Correction Factor(dB/m)
2. Correction Factor(dB/m) = Antenna Factor(dB/m) + Cable Factor(dB) – Pre-Amplifier Factor(dB)
3. Margin value = Emission Level – Limit value
4. The other emission levels were very low against the limit of frequency range 30 MHz ~ 1 GHz.
5. The emission levels were very low against the limit of frequency range 9 kHz ~ 30 MHz: the amplitude of spurious emissions attenuated more than 20 dB below the permissible value to be report.

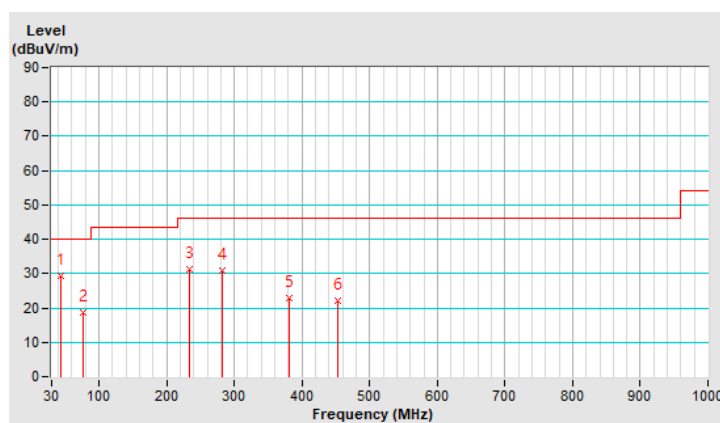

RF Mode	BT 8DPSK	Channel	CH 78 : 2480 MHz
Frequency Range	30 MHz ~ 1 GHz	Detector Function & Bandwidth	(QP) RB = 120kHz
Input Power (System)	120 Vac, 60 Hz	Environmental Conditions	28°C, 76% RH
Tested By	Louis Yang		

Antenna Polarity & Test Distance : Vertical at 3 m								
No	Frequency (MHz)	Emission Level (dBuV/m)	Limit (dBuV/m)	Margin (dB)	Antenna Height (m)	Table Angle (Degree)	Raw Value (dBuV)	Correction Factor (dB/m)
1	33.60	22.1 QP	40.0	-17.9	1.05 V	62	35.9	-13.8
2	139.30	24.7 QP	43.5	-18.8	1.00 V	325	37.9	-13.2
3	177.60	17.7 QP	43.5	-25.8	1.00 V	299	31.8	-14.1
4	232.60	30.0 QP	46.0	-16.0	1.00 V	172	45.1	-15.1
5	373.30	23.9 QP	46.0	-22.1	1.00 V	38	34.5	-10.6
6	645.10	27.2 QP	46.0	-18.8	1.12 V	355	31.6	-4.4

Remarks:

1. Emission Level(dBuV/m) = Raw Value(dBuV) + Correction Factor(dB/m)
2. Correction Factor(dB/m) = Antenna Factor(dB/m) + Cable Factor(dB) – Pre-Amplifier Factor(dB)
3. Margin value = Emission Level – Limit value
4. The other emission levels were very low against the limit of frequency range 30 MHz ~ 1 GHz.
5. The emission levels were very low against the limit of frequency range 9 kHz ~ 30 MHz: the amplitude of spurious emissions attenuated more than 20 dB below the permissible value to be report.

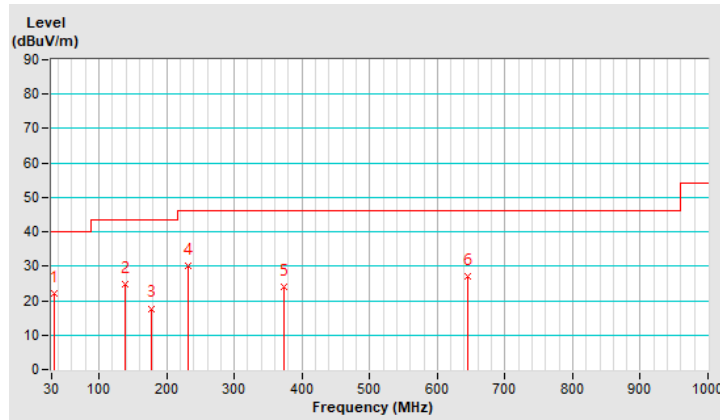

Mode C

RF Mode	BT 8DPSK	Channel	CH 78 : 2480 MHz
Frequency Range	30 MHz ~ 1 GHz	Detector Function & Bandwidth	(QP) RB = 120kHz
Input Power (System)	120 Vac, 60 Hz	Environmental Conditions	28°C, 76% RH
Tested By	Louis Yang		

Antenna Polarity & Test Distance : Horizontal at 3 m								
No	Frequency (MHz)	Emission Level (dBuV/m)	Limit (dBuV/m)	Margin (dB)	Antenna Height (m)	Table Angle (Degree)	Raw Value (dBuV)	Correction Factor (dB/m)
1	40.40	29.5 QP	40.0	-10.5	1.12 H	360	42.6	-13.1
2	75.30	18.0 QP	40.0	-22.0	1.00 H	325	34.2	-16.2
3	231.10	29.4 QP	46.0	-16.6	1.52 H	360	44.7	-15.3
4	281.90	29.3 QP	46.0	-16.7	1.50 H	74	42.0	-12.7
5	381.20	18.7 QP	46.0	-27.3	1.05 H	360	29.1	-10.4
6	450.80	23.0 QP	46.0	-23.0	1.00 H	122	31.2	-8.2

Remarks:

1. Emission Level(dBuV/m) = Raw Value(dBuV) + Correction Factor(dB/m)
2. Correction Factor(dB/m) = Antenna Factor(dB/m) + Cable Factor(dB) – Pre-Amplifier Factor(dB)
3. Margin value = Emission Level – Limit value
4. The other emission levels were very low against the limit of frequency range 30 MHz ~ 1 GHz.
5. The emission levels were very low against the limit of frequency range 9 kHz ~ 30 MHz: the amplitude of spurious emissions attenuated more than 20 dB below the permissible value to be report.

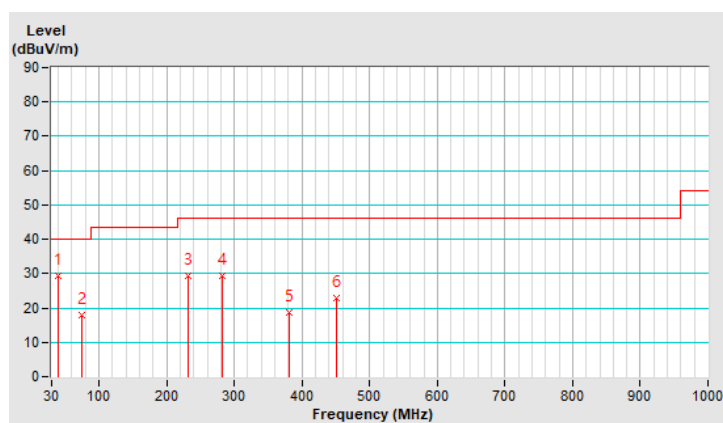

RF Mode	BT GFSK	Channel	CH 78 : 2480 MHz
Frequency Range	30 MHz ~ 1 GHz	Detector Function & Bandwidth	(QP) RB = 120kHz
Input Power (System)	120 Vac, 60 Hz	Environmental Conditions	28°C, 76% RH
Tested By	Louis Yang		

Antenna Polarity & Test Distance : Vertical at 3 m								
No	Frequency (MHz)	Emission Level (dBuV/m)	Limit (dBuV/m)	Margin (dB)	Antenna Height (m)	Table Angle (Degree)	Raw Value (dBuV)	Correction Factor (dB/m)
1	37.90	26.2 QP	40.0	-13.8	1.05 V	62	39.5	-13.3
2	140.00	30.3 QP	43.5	-13.2	1.00 V	325	43.4	-13.1
3	179.60	23.5 QP	43.5	-20.0	1.00 V	299	37.9	-14.4
4	234.80	36.9 QP	46.0	-9.1	1.00 V	172	51.7	-14.8
5	368.20	24.0 QP	46.0	-22.0	1.00 V	38	34.7	-10.7
6	641.70	28.3 QP	46.0	-17.7	1.12 V	355	32.8	-4.5

Remarks:

1. Emission Level(dBuV/m) = Raw Value(dBuV) + Correction Factor(dB/m)
2. Correction Factor(dB/m) = Antenna Factor(dB/m) + Cable Factor(dB) – Pre-Amplifier Factor(dB)
3. Margin value = Emission Level – Limit value
4. The other emission levels were very low against the limit of frequency range 30 MHz ~ 1 GHz.
5. The emission levels were very low against the limit of frequency range 9 kHz ~ 30 MHz: the amplitude of spurious emissions attenuated more than 20 dB below the permissible value to be report.

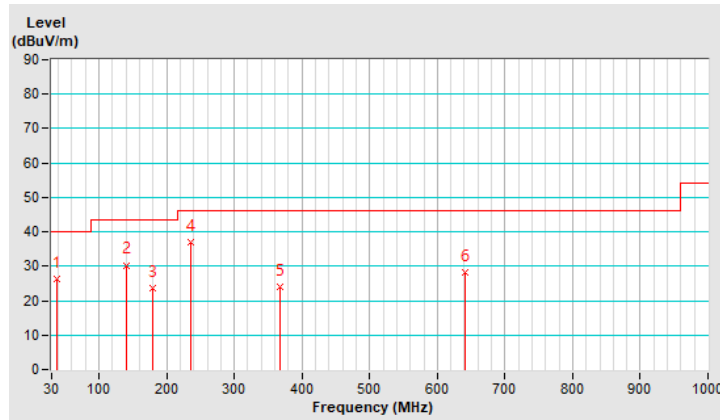

Mode D

RF Mode	BT GFSK	Channel	CH 0 : 2402 MHz
Frequency Range	30 MHz ~ 1 GHz	Detector Function & Bandwidth	(QP) RB = 120kHz
Input Power (System)	120 Vac, 60 Hz	Environmental Conditions	28°C, 76% RH
Tested By	Louis Yang		

Antenna Polarity & Test Distance : Horizontal at 3 m								
No	Frequency (MHz)	Emission Level (dBuV/m)	Limit (dBuV/m)	Margin (dB)	Antenna Height (m)	Table Angle (Degree)	Raw Value (dBuV)	Correction Factor (dB/m)
1	35.50	28.5 QP	40.0	-11.5	1.12 H	360	42.1	-13.6
2	74.50	17.4 QP	40.0	-22.6	1.00 H	325	33.4	-16.0
3	230.40	28.2 QP	46.0	-17.8	1.52 H	360	43.6	-15.4
4	281.50	31.2 QP	46.0	-14.8	1.50 H	74	43.9	-12.7
5	383.38	19.1 QP	46.0	-26.9	1.05 H	360	29.4	-10.3
6	451.29	25.6 QP	46.0	-20.4	1.00 H	122	33.8	-8.2

Remarks:

1. Emission Level(dBuV/m) = Raw Value(dBuV) + Correction Factor(dB/m)
2. Correction Factor(dB/m) = Antenna Factor(dB/m) + Cable Factor(dB) – Pre-Amplifier Factor(dB)
3. Margin value = Emission Level – Limit value
4. The other emission levels were very low against the limit of frequency range 30 MHz ~ 1 GHz.
5. The emission levels were very low against the limit of frequency range 9 kHz ~ 30 MHz: the amplitude of spurious emissions attenuated more than 20 dB below the permissible value to be report.

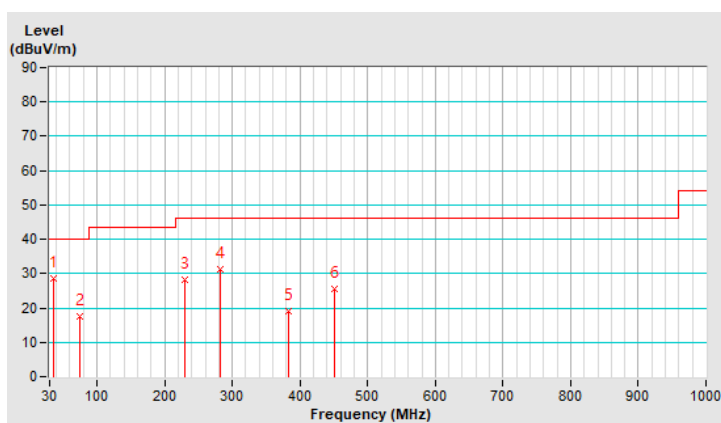

RF Mode	BT GFSK	Channel	CH 0 : 2402 MHz
Frequency Range	30 MHz ~ 1 GHz	Detector Function & Bandwidth	(QP) RB = 120kHz
Input Power (System)	120 Vac, 60 Hz	Environmental Conditions	28°C, 76% RH
Tested By	Louis Yang		

Antenna Polarity & Test Distance : Vertical at 3 m								
No	Frequency (MHz)	Emission Level (dBuV/m)	Limit (dBuV/m)	Margin (dB)	Antenna Height (m)	Table Angle (Degree)	Raw Value (dBuV)	Correction Factor (dB/m)
1	35.04	21.8 QP	40.0	-18.2	1.05 V	62	35.3	-13.5
2	136.14	24.7 QP	43.5	-18.8	1.00 V	325	38.1	-13.4
3	174.50	18.5 QP	43.5	-25.0	1.00 V	299	32.2	-13.7
4	231.70	33.1 QP	46.0	-12.9	1.00 V	172	48.3	-15.2
5	364.40	20.9 QP	46.0	-25.1	1.00 V	38	31.8	-10.9
6	636.10	23.8 QP	46.0	-22.2	1.12 V	355	28.5	-4.7

Remarks:

1. Emission Level(dBuV/m) = Raw Value(dBuV) + Correction Factor(dB/m)
2. Correction Factor(dB/m) = Antenna Factor(dB/m) + Cable Factor(dB) – Pre-Amplifier Factor(dB)
3. Margin value = Emission Level – Limit value
4. The other emission levels were very low against the limit of frequency range 30 MHz ~ 1 GHz.
5. The emission levels were very low against the limit of frequency range 9 kHz ~ 30 MHz: the amplitude of spurious emissions attenuated more than 20 dB below the permissible value to be report.

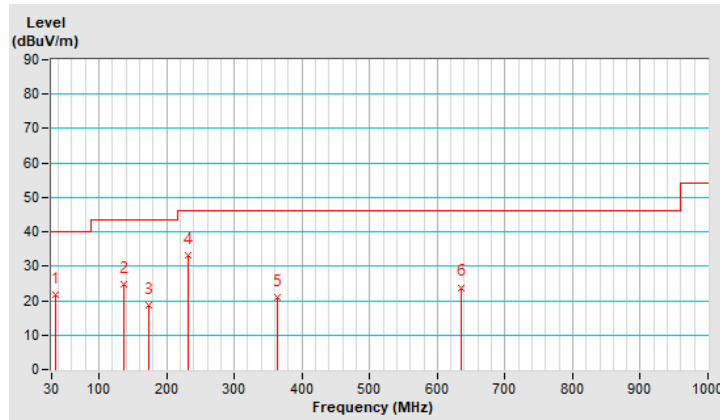

Mode E

RF Mode	BT GFSK	Channel	CH 0 : 2402 MHz
Frequency Range	30 MHz ~ 1 GHz	Detector Function & Bandwidth	(QP) RB = 120kHz
Input Power (System)	120 Vac, 60 Hz	Environmental Conditions	28°C, 76% RH
Tested By	Louis Yang		

Antenna Polarity & Test Distance : Horizontal at 3 m								
No	Frequency (MHz)	Emission Level (dBuV/m)	Limit (dBuV/m)	Margin (dB)	Antenna Height (m)	Table Angle (Degree)	Raw Value (dBuV)	Correction Factor (dB/m)
1	44.80	34.8 QP	40.0	-5.2	1.12 H	360	47.6	-12.8
2	82.90	24.1 QP	40.0	-15.9	1.00 H	325	42.3	-18.2
3	235.30	31.6 QP	46.0	-14.4	1.52 H	360	46.4	-14.8
4	286.70	32.1 QP	46.0	-13.9	1.50 H	74	44.6	-12.5
5	386.20	23.7 QP	46.0	-22.3	1.05 H	360	33.9	-10.2
6	455.30	27.1 QP	46.0	-18.9	1.00 H	122	35.2	-8.1

Remarks:

1. Emission Level(dBuV/m) = Raw Value(dBuV) + Correction Factor(dB/m)
2. Correction Factor(dB/m) = Antenna Factor(dB/m) + Cable Factor(dB) – Pre-Amplifier Factor(dB)
3. Margin value = Emission Level – Limit value
4. The other emission levels were very low against the limit of frequency range 30 MHz ~ 1 GHz.
5. The emission levels were very low against the limit of frequency range 9 kHz ~ 30 MHz: the amplitude of spurious emissions attenuated more than 20 dB below the permissible value to be report.

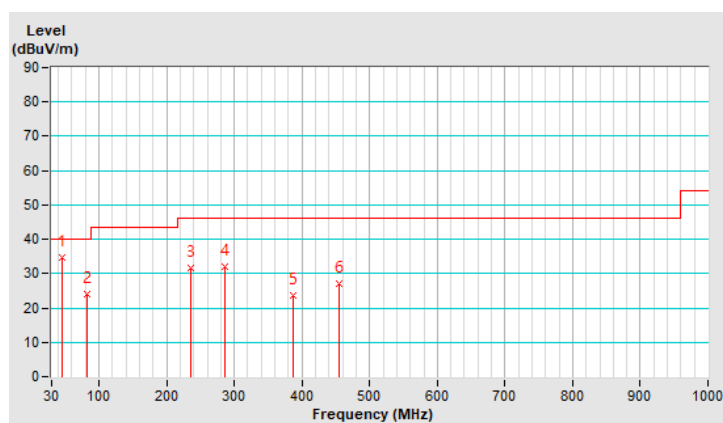

RF Mode	BT GFSK	Channel	CH 0 : 2402 MHz
Frequency Range	30 MHz ~ 1 GHz	Detector Function & Bandwidth	(QP) RB = 120kHz
Input Power (System)	120 Vac, 60 Hz	Environmental Conditions	28°C, 76% RH
Tested By	Louis Yang		

Antenna Polarity & Test Distance : Vertical at 3 m								
No	Frequency (MHz)	Emission Level (dBuV/m)	Limit (dBuV/m)	Margin (dB)	Antenna Height (m)	Table Angle (Degree)	Raw Value (dBuV)	Correction Factor (dB/m)
1	33.90	24.1 QP	40.0	-15.9	1.05 V	62	37.9	-13.8
2	139.00	29.2 QP	43.5	-14.3	1.00 V	325	42.4	-13.2
3	178.70	21.7 QP	43.5	-21.8	1.00 V	299	35.9	-14.2
4	234.10	31.8 QP	46.0	-14.2	1.00 V	172	46.7	-14.9
5	363.00	19.9 QP	46.0	-26.1	1.00 V	38	30.8	-10.9
6	636.10	23.8 QP	46.0	-22.2	1.12 V	355	28.5	-4.7

Remarks:

1. Emission Level(dBuV/m) = Raw Value(dBuV) + Correction Factor(dB/m)
2. Correction Factor(dB/m) = Antenna Factor(dB/m) + Cable Factor(dB) – Pre-Amplifier Factor(dB)
3. Margin value = Emission Level – Limit value
4. The other emission levels were very low against the limit of frequency range 30 MHz ~ 1 GHz.
5. The emission levels were very low against the limit of frequency range 9 kHz ~ 30 MHz: the amplitude of spurious emissions attenuated more than 20 dB below the permissible value to be report.

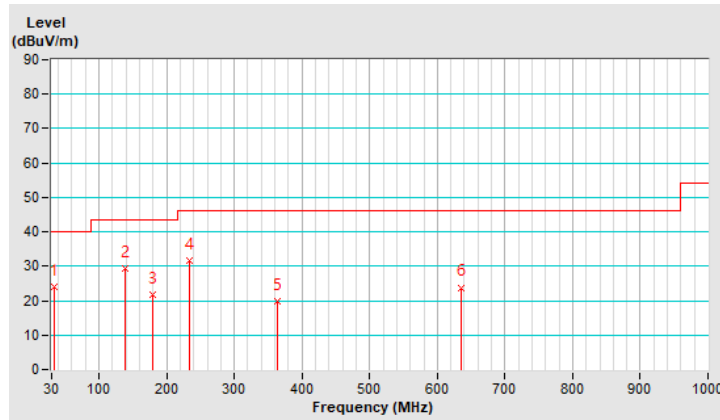

Mode F

RF Mode	BT GFSK	Channel	CH 0 : 2402 MHz
Frequency Range	30 MHz ~ 1 GHz	Detector Function & Bandwidth	(QP) RB = 120kHz
Input Power (System)	120 Vac, 60 Hz	Environmental Conditions	28°C, 76% RH
Tested By	Louis Yang		

Antenna Polarity & Test Distance : Horizontal at 3 m								
No	Frequency (MHz)	Emission Level (dBuV/m)	Limit (dBuV/m)	Margin (dB)	Antenna Height (m)	Table Angle (Degree)	Raw Value (dBuV)	Correction Factor (dB/m)
1	40.40	29.3 QP	40.0	-10.7	1.12 H	360	42.4	-13.1
2	76.00	21.0 QP	40.0	-19.0	1.00 H	325	37.5	-16.5
3	230.90	27.9 QP	46.0	-18.1	1.52 H	360	43.3	-15.4
4	281.60	28.8 QP	46.0	-17.2	1.50 H	74	41.5	-12.7
5	382.40	22.6 QP	46.0	-23.4	1.05 H	360	33.0	-10.4
6	450.60	21.3 QP	46.0	-24.7	1.00 H	122	29.5	-8.2

Remarks:

1. Emission Level(dBuV/m) = Raw Value(dBuV) + Correction Factor(dB/m)
2. Correction Factor(dB/m) = Antenna Factor(dB/m) + Cable Factor(dB) – Pre-Amplifier Factor(dB)
3. Margin value = Emission Level – Limit value
4. The other emission levels were very low against the limit of frequency range 30 MHz ~ 1 GHz.
5. The emission levels were very low against the limit of frequency range 9 kHz ~ 30 MHz: the amplitude of spurious emissions attenuated more than 20 dB below the permissible value to be report.

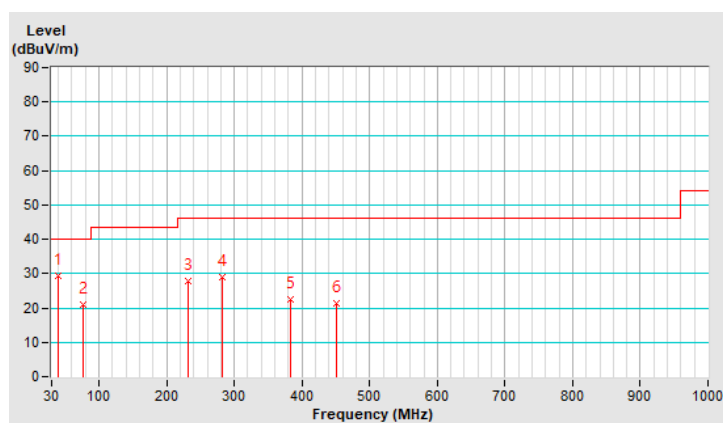

RF Mode	BT GFSK	Channel	CH 0 : 2402 MHz
Frequency Range	30 MHz ~ 1 GHz	Detector Function & Bandwidth	(QP) RB = 120kHz
Input Power (System)	120 Vac, 60 Hz	Environmental Conditions	28°C, 76% RH
Tested By	Louis Yang		

Antenna Polarity & Test Distance : Vertical at 3 m								
No	Frequency (MHz)	Emission Level (dBuV/m)	Limit (dBuV/m)	Margin (dB)	Antenna Height (m)	Table Angle (Degree)	Raw Value (dBuV)	Correction Factor (dB/m)
1	34.30	24.1 QP	40.0	-15.9	1.05 V	62	37.8	-13.7
2	135.60	24.8 QP	43.5	-18.7	1.00 V	325	38.3	-13.5
3	172.90	18.7 QP	43.5	-24.8	1.00 V	299	32.2	-13.5
4	228.20	31.6 QP	46.0	-14.4	1.00 V	172	47.3	-15.7
5	365.50	20.7 QP	46.0	-25.3	1.00 V	38	31.5	-10.8
6	635.41	23.0 QP	46.0	-23.0	1.12 V	355	27.7	-4.7

Remarks:

1. Emission Level(dBuV/m) = Raw Value(dBuV) + Correction Factor(dB/m)
2. Correction Factor(dB/m) = Antenna Factor(dB/m) + Cable Factor(dB) – Pre-Amplifier Factor(dB)
3. Margin value = Emission Level – Limit value
4. The other emission levels were very low against the limit of frequency range 30 MHz ~ 1 GHz.
5. The emission levels were very low against the limit of frequency range 9 kHz ~ 30 MHz: the amplitude of spurious emissions attenuated more than 20 dB below the permissible value to be report.

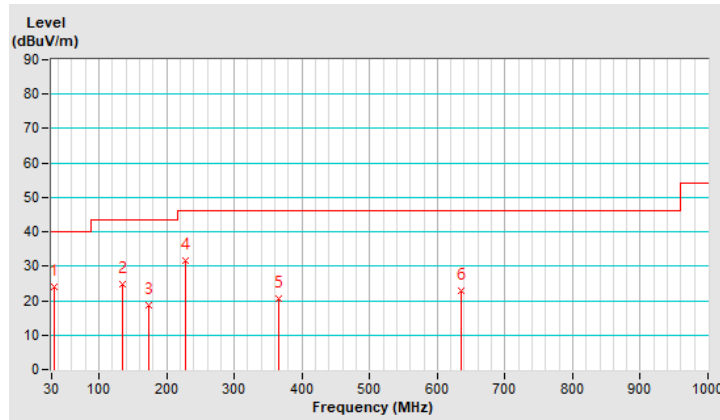

7.9 Unwanted Emissions above 1 GHz

Mode A

RF Mode	BT GFSK	Channel	CH 0 : 2402 MHz
Frequency Range	1 GHz ~ 25 GHz	Detector Function & Bandwidth	(PK) RB = 1 MHz, VB = 3 MHz (AV) RB = 1 MHz, VB = 3 MHz
Input Power (System)	120 Vac, 60 Hz	Environmental Conditions	29°C, 77% RH
Tested By	Louis Yang		

Antenna Polarity & Test Distance : Horizontal at 3 m								
No	Frequency (MHz)	Emission Level (dBuV/m)	Limit (dBuV/m)	Margin (dB)	Antenna Height (m)	Table Angle (Degree)	Raw Value (dBuV)	Correction Factor (dB/m)
1	2390.00	53.1 PK	74.0	-20.9	1.30 H	41	58.8	-5.7
2	2390.00	41.3 AV	54.0	-12.7	1.30 H	41	47.0	-5.7
3	*2402.00	92.0 PK			1.30 H	41	97.7	-5.7
4	*2402.00	61.0 AV			1.30 H	41	66.7	-5.7
5	4804.00	36.8 PK	74.0	-37.2	1.82 H	214	36.5	0.3
6	4804.00	6.6 AV	54.0	-47.4	1.82 H	214	6.3	0.3

Remarks:

- Emission Level(dBuV/m) = Raw Value(dBuV) + Correction Factor(dB/m)
- Correction Factor(dB/m) = Antenna Factor(dB/m) + Cable Factor(dB) – Pre-Amplifier Factor(dB)
- Margin value = Emission Level – Limit value
- The other emission levels were very low against the limit.
- " * ": Fundamental frequency, the limit was restricted at the RF Output Power.
- The average value of fundamental and harmonic frequency is: Average = Peak value + 20 log(Duty cycle) Where the duty cycle correction factor is calculated from following formula:
 $20 \log(\text{Duty cycle}) = 20 \log(2.888 \text{ ms} / 100 \text{ ms}) = -30.8 \text{ dB}$

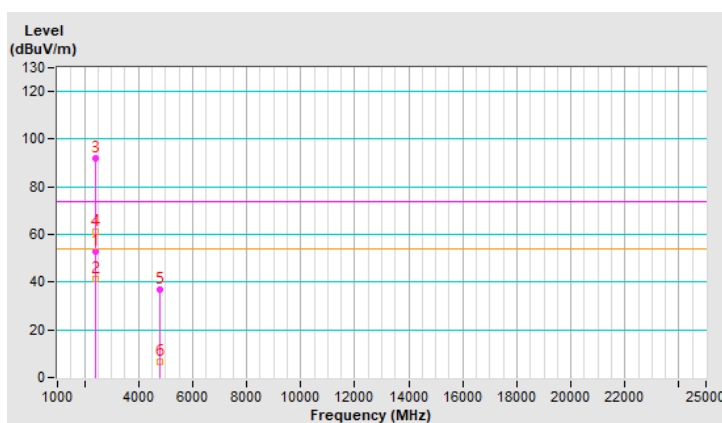

RF Mode	BT GFSK	Channel	CH 0 : 2402 MHz
Frequency Range	1 GHz ~ 25 GHz	Detector Function & Bandwidth	(PK) RB = 1 MHz, VB = 3 MHz (AV) RB = 1 MHz, VB = 3 MHz
Input Power (System)	120 Vac, 60 Hz	Environmental Conditions	29°C, 77% RH
Tested By	Louis Yang		

Antenna Polarity & Test Distance : Vertical at 3 m								
No	Frequency (MHz)	Emission Level (dBuV/m)	Limit (dBuV/m)	Margin (dB)	Antenna Height (m)	Table Angle (Degree)	Raw Value (dBuV)	Correction Factor (dB/m)
1	2390.00	53.7 PK	74.0	-20.3	1.56 V	12	59.4	-5.7
2	2390.00	43.0 AV	54.0	-11.0	1.56 V	12	48.7	-5.7
3	*2402.00	103.9 PK			1.56 V	12	109.6	-5.7
4	*2402.00	72.7 AV			1.56 V	12	78.4	-5.7
5	4804.00	36.3 PK	74.0	-37.7	1.51 V	232	36.0	0.3
6	4804.00	6.0 AV	54.0	-48.0	1.51 V	232	5.7	0.3

Remarks:

1. Emission Level(dBuV/m) = Raw Value(dBuV) + Correction Factor(dB/m)
2. Correction Factor(dB/m) = Antenna Factor(dB/m) + Cable Factor(dB) – Pre-Amplifier Factor(dB)
3. Margin value = Emission Level – Limit value
4. The other emission levels were very low against the limit.
5. " * " : Fundamental frequency, the limit was restricted at the RF Output Power.
6. The average value of fundamental and harmonic frequency is: Average = Peak value + 20 log(Duty cycle) Where the duty cycle correction factor is calculated from following formula:
 $20 \log(\text{Duty cycle}) = 20 \log(2.888 \text{ ms} / 100 \text{ ms}) = -30.8 \text{ dB}$

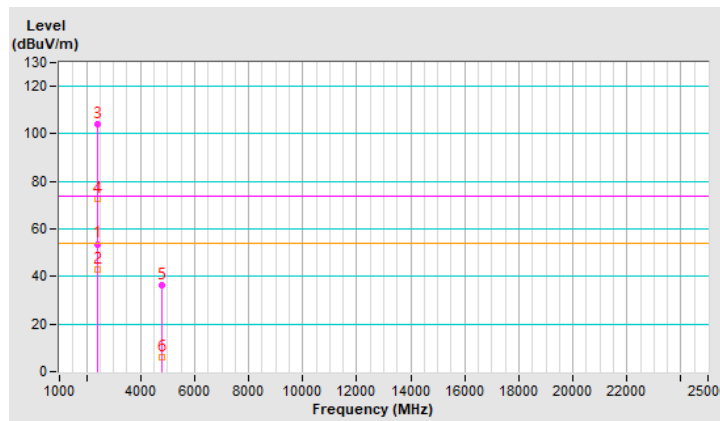

RF Mode	BT GFSK	Channel	CH 39 : 2441 MHz
Frequency Range	1 GHz ~ 25 GHz	Detector Function & Bandwidth	(PK) RB = 1 MHz, VB = 3 MHz (AV) RB = 1 MHz, VB = 3 MHz
Input Power (System)	120 Vac, 60 Hz	Environmental Conditions	29°C, 77% RH
Tested By	Louis Yang		

Antenna Polarity & Test Distance : Horizontal at 3 m								
No	Frequency (MHz)	Emission Level (dBuV/m)	Limit (dBuV/m)	Margin (dB)	Antenna Height (m)	Table Angle (Degree)	Raw Value (dBuV)	Correction Factor (dB/m)
1	*2441.00	92.0 PK			1.42 H	24	97.6	-5.6
2	*2441.00	61.7 AV			1.42 H	24	67.3	-5.6
3	4882.00	37.5 PK	74.0	-36.5	1.77 H	225	37.2	0.3
4	4882.00	6.6 AV	54.0	-47.4	1.77 H	225	6.3	0.3
5	7323.00	41.5 PK	74.0	-32.5	1.02 H	336	34.6	6.9
6	7323.00	11.0 AV	54.0	-43.0	1.02 H	336	4.1	6.9

Remarks:

1. Emission Level(dBuV/m) = Raw Value(dBuV) + Correction Factor(dB/m)
2. Correction Factor(dB/m) = Antenna Factor(dB/m) + Cable Factor(dB) – Pre-Amplifier Factor(dB)
3. Margin value = Emission Level – Limit value
4. The other emission levels were very low against the limit.
5. " * " : Fundamental frequency, the limit was restricted at the RF Output Power.
6. The average value of fundamental and harmonic frequency is: Average = Peak value + 20 log(Duty cycle) Where the duty cycle correction factor is calculated from following formula:
 $20 \log(\text{Duty cycle}) = 20 \log(2.888 \text{ ms} / 100 \text{ ms}) = -30.8 \text{ dB}$

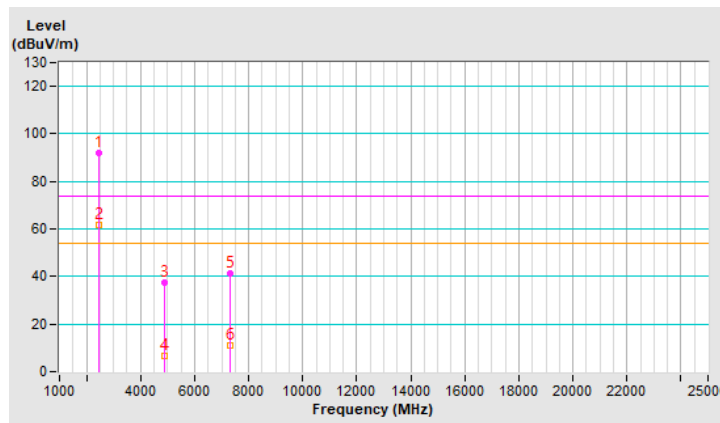

RF Mode	BT GFSK	Channel	CH 39 : 2441 MHz
Frequency Range	1 GHz ~ 25 GHz	Detector Function & Bandwidth	(PK) RB = 1 MHz, VB = 3 MHz (AV) RB = 1 MHz, VB = 3 MHz
Input Power (System)	120 Vac, 60 Hz	Environmental Conditions	29°C, 77% RH
Tested By	Louis Yang		

Antenna Polarity & Test Distance : Vertical at 3 m								
No	Frequency (MHz)	Emission Level (dBuV/m)	Limit (dBuV/m)	Margin (dB)	Antenna Height (m)	Table Angle (Degree)	Raw Value (dBuV)	Correction Factor (dB/m)
1	*2441.00	102.4 PK			1.51 V	12	108.0	-5.6
2	*2441.00	71.8 AV			1.51 V	12	77.4	-5.6
3	4882.00	36.3 PK	74.0	-37.7	1.47 V	245	36.0	0.3
4	4882.00	5.9 AV	54.0	-48.1	1.47 V	245	5.6	0.3
5	7323.00	41.8 PK	74.0	-32.2	1.01 V	315	34.9	6.9
6	7323.00	11.4 AV	54.0	-42.6	1.01 V	315	4.5	6.9

Remarks:

1. Emission Level(dBuV/m) = Raw Value(dBuV) + Correction Factor(dB/m)
2. Correction Factor(dB/m) = Antenna Factor(dB/m) + Cable Factor(dB) – Pre-Amplifier Factor(dB)
3. Margin value = Emission Level – Limit value
4. The other emission levels were very low against the limit.
5. " * " : Fundamental frequency, the limit was restricted at the RF Output Power.
6. The average value of fundamental and harmonic frequency is: Average = Peak value + 20 log(Duty cycle) Where the duty cycle correction factor is calculated from following formula:
 $20 \log(\text{Duty cycle}) = 20 \log(2.888 \text{ ms} / 100 \text{ ms}) = -30.8 \text{ dB}$

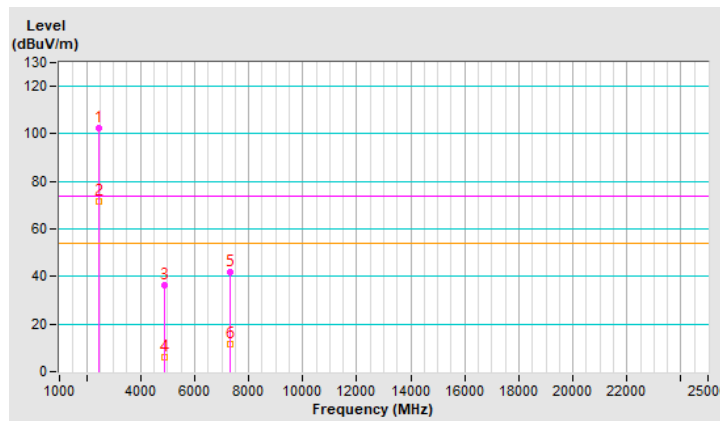

RF Mode	BT GFSK	Channel	CH 78 : 2480 MHz
Frequency Range	1 GHz ~ 25 GHz	Detector Function & Bandwidth	(PK) RB = 1 MHz, VB = 3 MHz (AV) RB = 1 MHz, VB = 3 MHz
Input Power (System)	120 Vac, 60 Hz	Environmental Conditions	29°C, 77% RH
Tested By	Louis Yang		

Antenna Polarity & Test Distance : Horizontal at 3 m								
No	Frequency (MHz)	Emission Level (dBuV/m)	Limit (dBuV/m)	Margin (dB)	Antenna Height (m)	Table Angle (Degree)	Raw Value (dBuV)	Correction Factor (dB/m)
1	*2480.00	89.9 PK			1.48 H	53	95.6	-5.7
2	*2480.00	59.0 AV			1.48 H	53	64.7	-5.7
3	2483.50	54.0 PK	74.0	-20.0	1.48 H	53	59.7	-5.7
4	2483.50	43.0 AV	54.0	-11.0	1.48 H	53	48.7	-5.7
5	4960.00	36.2 PK	74.0	-37.8	1.85 H	220	35.7	0.5
6	4960.00	6.1 AV	54.0	-47.9	1.85 H	220	5.6	0.5
7	7440.00	41.4 PK	74.0	-32.6	1.00 H	342	34.0	7.4
8	7440.00	11.1 AV	54.0	-42.9	1.00 H	342	3.7	7.4

Remarks:

1. Emission Level(dBuV/m) = Raw Value(dBuV) + Correction Factor(dB/m)
2. Correction Factor(dB/m) = Antenna Factor(dB/m) + Cable Factor(dB) – Pre-Amplifier Factor(dB)
3. Margin value = Emission Level – Limit value
4. The other emission levels were very low against the limit.
5. " * ": Fundamental frequency, the limit was restricted at the RF Output Power.
6. The average value of fundamental and harmonic frequency is: Average = Peak value + 20 log(Duty cycle) Where the duty cycle correction factor is calculated from following formula:
 $20 \log(\text{Duty cycle}) = 20 \log(2.888 \text{ ms} / 100 \text{ ms}) = -30.8 \text{ dB}$

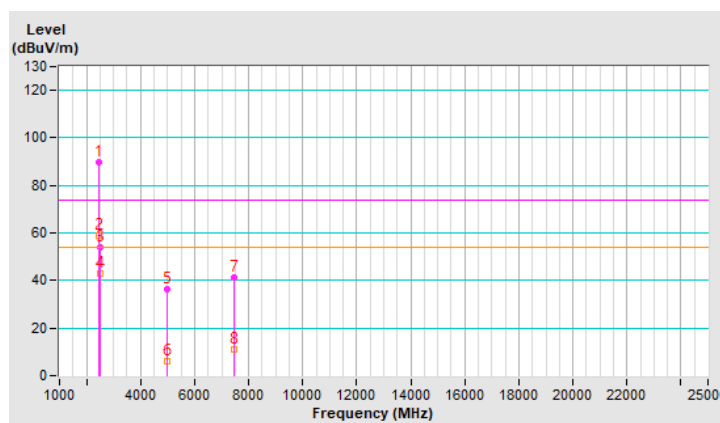

RF Mode	BT GFSK	Channel	CH 78 : 2480 MHz
Frequency Range	1 GHz ~ 25 GHz	Detector Function & Bandwidth	(PK) RB = 1 MHz, VB = 3 MHz (AV) RB = 1 MHz, VB = 3 MHz
Input Power (System)	120 Vac, 60 Hz	Environmental Conditions	29°C, 77% RH
Tested By	Louis Yang		

Antenna Polarity & Test Distance : Vertical at 3 m								
No	Frequency (MHz)	Emission Level (dBuV/m)	Limit (dBuV/m)	Margin (dB)	Antenna Height (m)	Table Angle (Degree)	Raw Value (dBuV)	Correction Factor (dB/m)
1	*2480.00	101.1 PK			1.60 V	6	106.8	-5.7
2	*2480.00	70.6 AV			1.60 V	6	76.3	-5.7
3	2483.50	53.0 PK	74.0	-21.0	1.60 V	6	58.7	-5.7
4	2483.50	42.8 AV	54.0	-11.2	1.60 V	6	48.5	-5.7
5	4960.00	37.1 PK	74.0	-36.9	1.34 V	252	36.6	0.5
6	4960.00	6.5 AV	54.0	-47.5	1.34 V	252	6.0	0.5
7	7440.00	42.4 PK	74.0	-31.6	1.05 V	313	35.0	7.4
8	7440.00	11.3 AV	54.0	-42.7	1.05 V	313	3.9	7.4

Remarks:

1. Emission Level(dBuV/m) = Raw Value(dBuV) + Correction Factor(dB/m)
2. Correction Factor(dB/m) = Antenna Factor(dB/m) + Cable Factor(dB) – Pre-Amplifier Factor(dB)
3. Margin value = Emission Level – Limit value
4. The other emission levels were very low against the limit.
5. " * ": Fundamental frequency, the limit was restricted at the RF Output Power.
6. The average value of fundamental and harmonic frequency is: Average = Peak value + 20 log(Duty cycle) Where the duty cycle correction factor is calculated from following formula:
 $20 \log(\text{Duty cycle}) = 20 \log(2.888 \text{ ms} / 100 \text{ ms}) = -30.8 \text{ dB}$

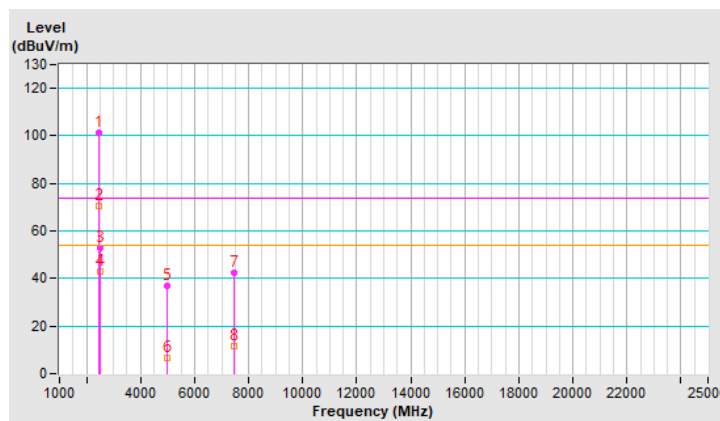

RF Mode	BT 8DPSK	Channel	CH 0 : 2402 MHz
Frequency Range	1 GHz ~ 25 GHz	Detector Function & Bandwidth	(PK) RB = 1 MHz, VB = 3 MHz (AV) RB = 1 MHz, VB = 3 MHz
Input Power (System)	120 Vac, 60 Hz	Environmental Conditions	29°C, 77% RH
Tested By	Louis Yang		

Antenna Polarity & Test Distance : Horizontal at 3 m

No	Frequency (MHz)	Emission Level (dBuV/m)	Limit (dBuV/m)	Margin (dB)	Antenna Height (m)	Table Angle (Degree)	Raw Value (dBuV)	Correction Factor (dB/m)
1	2390.00	54.3 PK	74.0	-19.7	1.25 H	36	60.0	-5.7
2	2390.00	43.2 AV	54.0	-10.8	1.25 H	36	48.9	-5.7
3	*2402.00	92.8 PK			1.25 H	36	98.5	-5.7
4	*2402.00	62.1 AV			1.25 H	36	67.8	-5.7
5	4804.00	38.1 PK	74.0	-35.9	1.64 H	215	37.8	0.3
6	4804.00	6.8 AV	54.0	-47.2	1.64 H	215	6.5	0.3

Remarks:

1. Emission Level(dBuV/m) = Raw Value(dBuV) + Correction Factor(dB/m)
2. Correction Factor(dB/m) = Antenna Factor(dB/m) + Cable Factor(dB) – Pre-Amplifier Factor(dB)
3. Margin value = Emission Level – Limit value
4. The other emission levels were very low against the limit.
5. " * ": Fundamental frequency, the limit was restricted at the RF Output Power.
6. The average value of fundamental and harmonic frequency is: Average = Peak value + 20 log(Duty cycle) Where the duty cycle correction factor is calculated from following formula:
 $20 \log(\text{Duty cycle}) = 20 \log(2.898 \text{ ms} / 100 \text{ ms}) = -30.8 \text{ dB}$

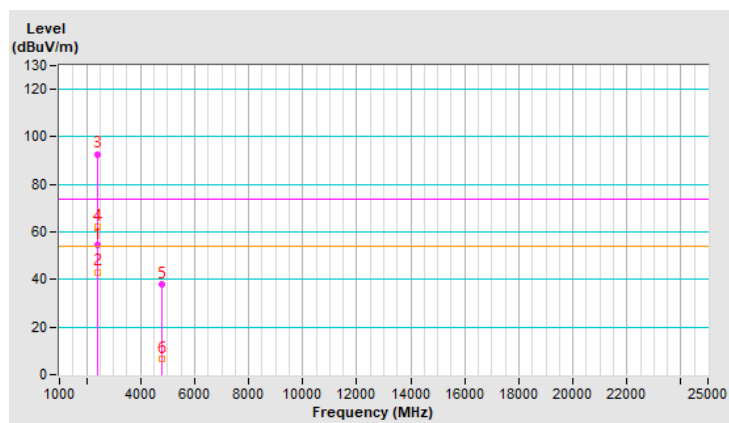

RF Mode	BT 8DPSK	Channel	CH 0 : 2402 MHz
Frequency Range	1 GHz ~ 25 GHz	Detector Function & Bandwidth	(PK) RB = 1 MHz, VB = 3 MHz (AV) RB = 1 MHz, VB = 3 MHz
Input Power (System)	120 Vac, 60 Hz	Environmental Conditions	29°C, 77% RH
Tested By	Louis Yang		

Antenna Polarity & Test Distance : Vertical at 3 m								
No	Frequency (MHz)	Emission Level (dBuV/m)	Limit (dBuV/m)	Margin (dB)	Antenna Height (m)	Table Angle (Degree)	Raw Value (dBuV)	Correction Factor (dB/m)
1	2390.00	53.5 PK	74.0	-20.5	1.55 V	13	59.2	-5.7
2	2390.00	43.1 AV	54.0	-10.9	1.55 V	13	48.8	-5.7
3	*2402.00	104.6 PK			1.55 V	13	110.3	-5.7
4	*2402.00	73.6 AV			1.55 V	13	79.3	-5.7
5	4804.00	36.6 PK	74.0	-37.4	1.45 V	240	36.3	0.3
6	4804.00	5.9 AV	54.0	-48.1	1.45 V	240	5.6	0.3

Remarks:

1. Emission Level(dBuV/m) = Raw Value(dBuV) + Correction Factor(dB/m)
2. Correction Factor(dB/m) = Antenna Factor(dB/m) + Cable Factor(dB) – Pre-Amplifier Factor(dB)
3. Margin value = Emission Level – Limit value
4. The other emission levels were very low against the limit.
5. " * " : Fundamental frequency, the limit was restricted at the RF Output Power.
6. The average value of fundamental and harmonic frequency is: Average = Peak value + 20 log(Duty cycle) Where the duty cycle correction factor is calculated from following formula:
 $20 \log(\text{Duty cycle}) = 20 \log(2.898 \text{ ms} / 100 \text{ ms}) = -30.8 \text{ dB}$

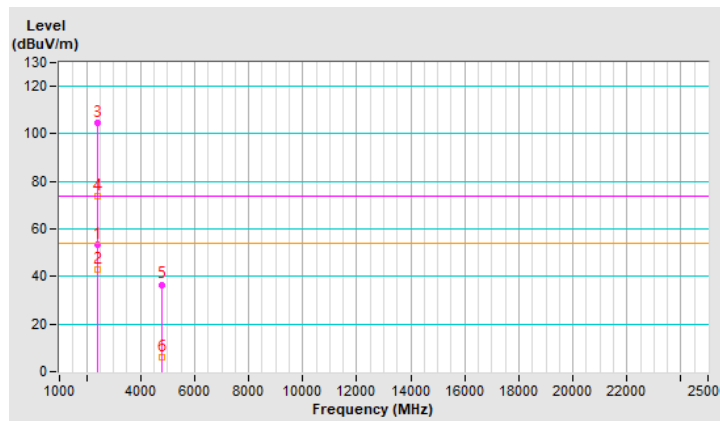

RF Mode	BT 8DPSK	Channel	CH 39 : 2441 MHz
Frequency Range	1 GHz ~ 25 GHz	Detector Function & Bandwidth	(PK) RB = 1 MHz, VB = 3 MHz (AV) RB = 1 MHz, VB = 3 MHz
Input Power (System)	120 Vac, 60 Hz	Environmental Conditions	29°C, 77% RH
Tested By	Louis Yang		

Antenna Polarity & Test Distance : Horizontal at 3 m								
No	Frequency (MHz)	Emission Level (dBuV/m)	Limit (dBuV/m)	Margin (dB)	Antenna Height (m)	Table Angle (Degree)	Raw Value (dBuV)	Correction Factor (dB/m)
1	*2441.00	92.5 PK			1.18 H	22	98.1	-5.6
2	*2441.00	61.6 AV			1.18 H	22	67.2	-5.6
3	4882.00	37.2 PK	74.0	-36.8	1.79 H	231	36.9	0.3
4	4882.00	6.3 AV	54.0	-47.7	1.79 H	231	6.0	0.3
5	7323.00	41.4 PK	74.0	-32.6	1.00 H	331	34.5	6.9
6	7323.00	11.3 AV	54.0	-42.7	1.00 H	331	4.4	6.9

Remarks:

1. Emission Level(dBuV/m) = Raw Value(dBuV) + Correction Factor(dB/m)
2. Correction Factor(dB/m) = Antenna Factor(dB/m) + Cable Factor(dB) – Pre-Amplifier Factor(dB)
3. Margin value = Emission Level – Limit value
4. The other emission levels were very low against the limit.
5. " * " : Fundamental frequency, the limit was restricted at the RF Output Power.
6. The average value of fundamental and harmonic frequency is: Average = Peak value + 20 log(Duty cycle) Where the duty cycle correction factor is calculated from following formula:
 $20 \log(\text{Duty cycle}) = 20 \log(2.898 \text{ ms} / 100 \text{ ms}) = -30.8 \text{ dB}$

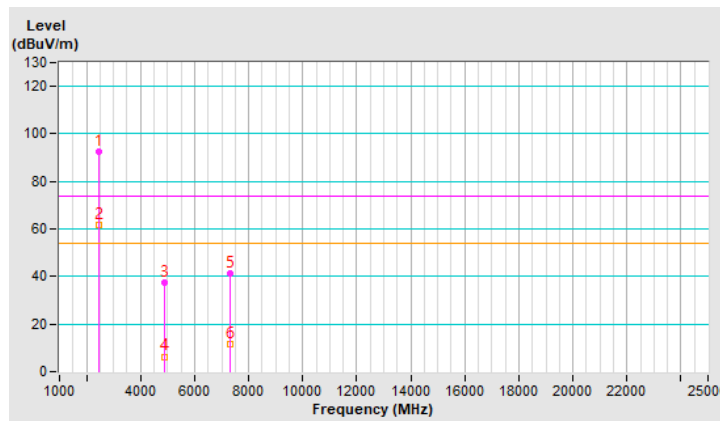

RF Mode	BT 8DPSK	Channel	CH 39 : 2441 MHz
Frequency Range	1 GHz ~ 25 GHz	Detector Function & Bandwidth	(PK) RB = 1 MHz, VB = 3 MHz (AV) RB = 1 MHz, VB = 3 MHz
Input Power (System)	120 Vac, 60 Hz	Environmental Conditions	29°C, 77% RH
Tested By	Louis Yang		

Antenna Polarity & Test Distance : Vertical at 3 m								
No	Frequency (MHz)	Emission Level (dBuV/m)	Limit (dBuV/m)	Margin (dB)	Antenna Height (m)	Table Angle (Degree)	Raw Value (dBuV)	Correction Factor (dB/m)
1	*2441.00	103.5 PK			1.54 V	36	109.1	-5.6
2	*2441.00	73.2 AV			1.54 V	36	78.8	-5.6
3	4882.00	36.3 PK	74.0	-37.7	1.58 V	235	36.0	0.3
4	4882.00	5.6 AV	54.0	-48.4	1.58 V	235	5.3	0.3
5	7323.00	40.7 PK	74.0	-33.3	1.09 V	318	33.8	6.9
6	7323.00	10.9 AV	54.0	-43.1	1.09 V	318	4.0	6.9

Remarks:

1. Emission Level(dBuV/m) = Raw Value(dBuV) + Correction Factor(dB/m)
2. Correction Factor(dB/m) = Antenna Factor(dB/m) + Cable Factor(dB) – Pre-Amplifier Factor(dB)
3. Margin value = Emission Level – Limit value
4. The other emission levels were very low against the limit.
5. " * " : Fundamental frequency, the limit was restricted at the RF Output Power.
6. The average value of fundamental and harmonic frequency is: Average = Peak value + 20 log(Duty cycle) Where the duty cycle correction factor is calculated from following formula:
 $20 \log(\text{Duty cycle}) = 20 \log(2.898 \text{ ms} / 100 \text{ ms}) = -30.8 \text{ dB}$

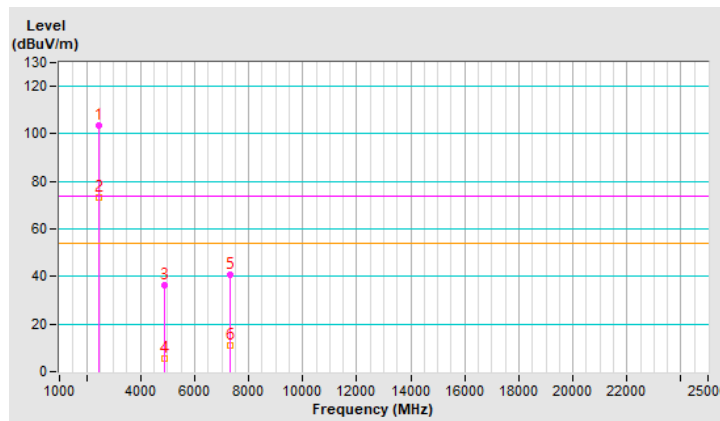

RF Mode	BT 8DPSK	Channel	CH 78 : 2480 MHz
Frequency Range	1 GHz ~ 25 GHz	Detector Function & Bandwidth	(PK) RB = 1 MHz, VB = 3 MHz (AV) RB = 1 MHz, VB = 3 MHz
Input Power (System)	120 Vac, 60 Hz	Environmental Conditions	29°C, 77% RH
Tested By	Louis Yang		

Antenna Polarity & Test Distance : Horizontal at 3 m								
No	Frequency (MHz)	Emission Level (dBuV/m)	Limit (dBuV/m)	Margin (dB)	Antenna Height (m)	Table Angle (Degree)	Raw Value (dBuV)	Correction Factor (dB/m)
1	*2480.00	90.2 PK			1.32 H	32	95.9	-5.7
2	*2480.00	59.7 AV			1.32 H	32	65.4	-5.7
3	2483.50	53.3 PK	74.0	-20.7	1.32 H	32	59.0	-5.7
4	2483.50	42.3 AV	54.0	-11.7	1.32 H	32	48.0	-5.7
5	4960.00	36.3 PK	74.0	-37.7	1.77 H	192	35.8	0.5
6	4960.00	6.0 AV	54.0	-48.0	1.77 H	192	5.5	0.5
7	7440.00	41.3 PK	74.0	-32.7	1.08 H	332	33.9	7.4
8	7440.00	10.8 AV	54.0	-43.2	1.08 H	332	3.4	7.4

Remarks:

1. Emission Level(dBuV/m) = Raw Value(dBuV) + Correction Factor(dB/m)
2. Correction Factor(dB/m) = Antenna Factor(dB/m) + Cable Factor(dB) – Pre-Amplifier Factor(dB)
3. Margin value = Emission Level – Limit value
4. The other emission levels were very low against the limit.
5. " * ": Fundamental frequency, the limit was restricted at the RF Output Power.
6. The average value of fundamental and harmonic frequency is: Average = Peak value + 20 log(Duty cycle) Where the duty cycle correction factor is calculated from following formula:
 $20 \log(\text{Duty cycle}) = 20 \log(2.898 \text{ ms} / 100 \text{ ms}) = -30.8 \text{ dB}$

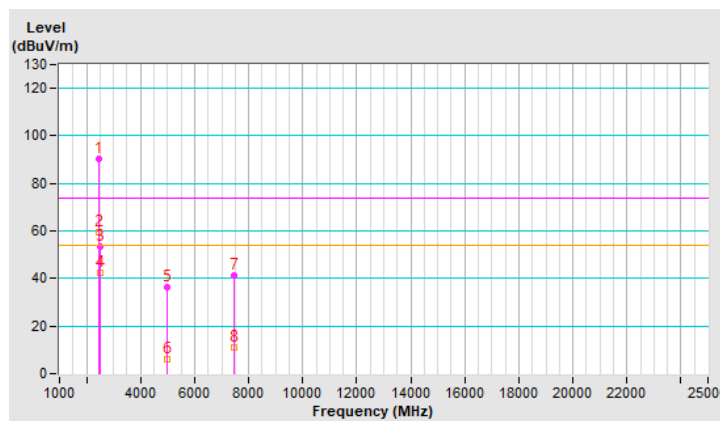

RF Mode	BT 8DPSK	Channel	CH 78 : 2480 MHz
Frequency Range	1 GHz ~ 25 GHz	Detector Function & Bandwidth	(PK) RB = 1 MHz, VB = 3 MHz (AV) RB = 1 MHz, VB = 3 MHz
Input Power (System)	120 Vac, 60 Hz	Environmental Conditions	29°C, 77% RH
Tested By	Louis Yang		

Antenna Polarity & Test Distance : Vertical at 3 m								
No	Frequency (MHz)	Emission Level (dBuV/m)	Limit (dBuV/m)	Margin (dB)	Antenna Height (m)	Table Angle (Degree)	Raw Value (dBuV)	Correction Factor (dB/m)
1	*2480.00	103.7 PK			1.58 V	11	109.4	-5.7
2	*2480.00	72.8 AV			1.58 V	11	78.5	-5.7
3	2483.50	53.6 PK	74.0	-20.4	1.58 V	11	59.3	-5.7
4	2483.50	43.1 AV	54.0	-10.9	1.58 V	11	48.8	-5.7
5	4960.00	36.3 PK	74.0	-37.7	1.36 V	240	35.8	0.5
6	4960.00	6.5 AV	54.0	-47.5	1.36 V	240	6.0	0.5
7	7440.00	41.9 PK	74.0	-32.1	1.06 V	316	34.5	7.4
8	7440.00	11.5 AV	54.0	-42.5	1.06 V	316	4.1	7.4

Remarks:

1. Emission Level(dBuV/m) = Raw Value(dBuV) + Correction Factor(dB/m)
2. Correction Factor(dB/m) = Antenna Factor(dB/m) + Cable Factor(dB) – Pre-Amplifier Factor(dB)
3. Margin value = Emission Level – Limit value
4. The other emission levels were very low against the limit.
5. " * ": Fundamental frequency, the limit was restricted at the RF Output Power.
6. The average value of fundamental and harmonic frequency is: Average = Peak value + 20 log(Duty cycle) Where the duty cycle correction factor is calculated from following formula:
 $20 \log(\text{Duty cycle}) = 20 \log(2.898 \text{ ms} / 100 \text{ ms}) = -30.8 \text{ dB}$

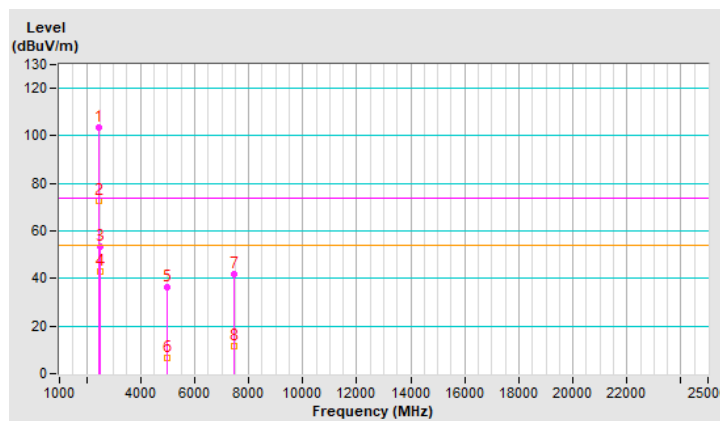

Mode B

RF Mode	BT GFSK	Channel	CH 0 : 2402 MHz
Frequency Range	1 GHz ~ 25 GHz	Detector Function & Bandwidth	(PK) RB = 1 MHz, VB = 3 MHz (AV) RB = 1 MHz, VB = 3 MHz
Input Power (System)	120 Vac, 60 Hz	Environmental Conditions	29°C, 77% RH
Tested By	Louis Yang		

Antenna Polarity & Test Distance : Horizontal at 3 m								
No	Frequency (MHz)	Emission Level (dBuV/m)	Limit (dBuV/m)	Margin (dB)	Antenna Height (m)	Table Angle (Degree)	Raw Value (dBuV)	Correction Factor (dB/m)
1	2390.00	54.0 PK	74.0	-20.0	3.63 H	244	59.7	-5.7
2	2390.00	42.3 AV	54.0	-11.7	3.63 H	244	48.0	-5.7
3	*2402.00	108.7 PK			3.63 H	244	114.4	-5.7
4	*2402.00	77.9 AV			3.63 H	244	83.6	-5.7
5	4804.00	40.0 PK	74.0	-34.0	3.72 H	279	39.7	0.3
6	4804.00	9.2 AV	54.0	-44.8	3.72 H	279	8.9	0.3

Remarks:

1. Emission Level(dBuV/m) = Raw Value(dBuV) + Correction Factor(dB/m)
2. Correction Factor(dB/m) = Antenna Factor(dB/m) + Cable Factor(dB) – Pre-Amplifier Factor(dB)
3. Margin value = Emission Level – Limit value
4. The other emission levels were very low against the limit.
5. " * " : Fundamental frequency, the limit was restricted at the RF Output Power.
6. The average value of fundamental and harmonic frequency is: Average = Peak value + 20 log(Duty cycle) Where the duty cycle correction factor is calculated from following formula:
 $20 \log(\text{Duty cycle}) = 20 \log(2.888 \text{ ms} / 100 \text{ ms}) = -30.8 \text{ dB}$

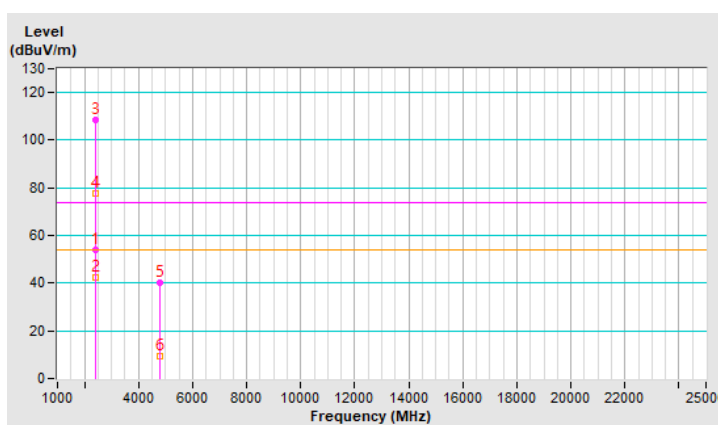

RF Mode	BT GFSK	Channel	CH 0 : 2402 MHz
Frequency Range	1 GHz ~ 25 GHz	Detector Function & Bandwidth	(PK) RB = 1 MHz, VB = 3 MHz (AV) RB = 1 MHz, VB = 3 MHz
Input Power (System)	120 Vac, 60 Hz	Environmental Conditions	29°C, 77% RH
Tested By	Louis Yang		

Antenna Polarity & Test Distance : Vertical at 3 m								
No	Frequency (MHz)	Emission Level (dBuV/m)	Limit (dBuV/m)	Margin (dB)	Antenna Height (m)	Table Angle (Degree)	Raw Value (dBuV)	Correction Factor (dB/m)
1	2390.00	55.3 PK	74.0	-18.7	2.59 V	168	61.0	-5.7
2	2390.00	42.0 AV	54.0	-12.0	2.59 V	168	47.7	-5.7
3	*2402.00	105.9 PK			2.59 V	168	111.6	-5.7
4	*2402.00	75.1 AV			2.59 V	168	80.8	-5.7
5	4804.00	38.9 PK	74.0	-35.1	2.38 V	155	38.6	0.3
6	4804.00	8.1 AV	54.0	-45.9	2.38 V	155	7.8	0.3

Remarks:

1. Emission Level(dBuV/m) = Raw Value(dBuV) + Correction Factor(dB/m)
2. Correction Factor(dB/m) = Antenna Factor(dB/m) + Cable Factor(dB) – Pre-Amplifier Factor(dB)
3. Margin value = Emission Level – Limit value
4. The other emission levels were very low against the limit.
5. " * " : Fundamental frequency, the limit was restricted at the RF Output Power.
6. The average value of fundamental and harmonic frequency is: Average = Peak value + 20 log(Duty cycle) Where the duty cycle correction factor is calculated from following formula:
 $20 \log(\text{Duty cycle}) = 20 \log(2.888 \text{ ms} / 100 \text{ ms}) = -30.8 \text{ dB}$

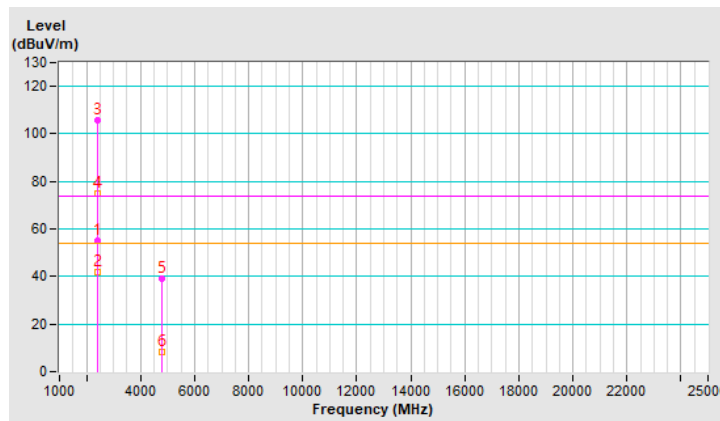

RF Mode	BT GFSK	Channel	CH 39 : 2441 MHz
Frequency Range	1 GHz ~ 25 GHz	Detector Function & Bandwidth	(PK) RB = 1 MHz, VB = 3 MHz (AV) RB = 1 MHz, VB = 3 MHz
Input Power (System)	120 Vac, 60 Hz	Environmental Conditions	29°C, 77% RH
Tested By	Louis Yang		

Antenna Polarity & Test Distance : Horizontal at 3 m								
No	Frequency (MHz)	Emission Level (dBuV/m)	Limit (dBuV/m)	Margin (dB)	Antenna Height (m)	Table Angle (Degree)	Raw Value (dBuV)	Correction Factor (dB/m)
1	*2441.00	105.6 PK			3.73 H	253	111.2	-5.6
2	*2441.00	74.8 AV			3.73 H	253	80.4	-5.6
3	4882.00	41.2 PK	74.0	-32.8	3.69 H	257	40.9	0.3
4	4882.00	10.4 AV	54.0	-43.6	3.69 H	257	10.1	0.3
5	7323.00	49.9 PK	74.0	-24.1	3.53 H	264	43.0	6.9
6	7323.00	19.1 AV	54.0	-34.9	3.53 H	264	12.2	6.9

Remarks:

1. Emission Level(dBuV/m) = Raw Value(dBuV) + Correction Factor(dB/m)
2. Correction Factor(dB/m) = Antenna Factor(dB/m) + Cable Factor(dB) – Pre-Amplifier Factor(dB)
3. Margin value = Emission Level – Limit value
4. The other emission levels were very low against the limit.
5. " * " : Fundamental frequency, the limit was restricted at the RF Output Power.
6. The average value of fundamental and harmonic frequency is: Average = Peak value + 20 log(Duty cycle) Where the duty cycle correction factor is calculated from following formula:
 $20 \log(\text{Duty cycle}) = 20 \log(2.888 \text{ ms} / 100 \text{ ms}) = -30.8 \text{ dB}$

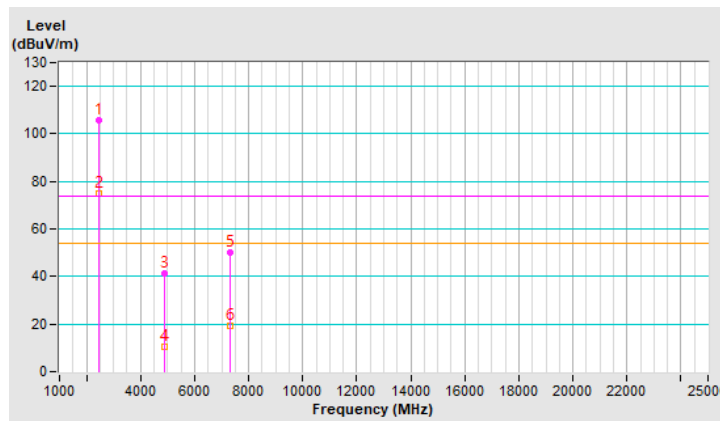

RF Mode	BT GFSK	Channel	CH 39 : 2441 MHz
Frequency Range	1 GHz ~ 25 GHz	Detector Function & Bandwidth	(PK) RB = 1 MHz, VB = 3 MHz (AV) RB = 1 MHz, VB = 3 MHz
Input Power (System)	120 Vac, 60 Hz	Environmental Conditions	29°C, 77% RH
Tested By	Louis Yang		

Antenna Polarity & Test Distance : Vertical at 3 m								
No	Frequency (MHz)	Emission Level (dBuV/m)	Limit (dBuV/m)	Margin (dB)	Antenna Height (m)	Table Angle (Degree)	Raw Value (dBuV)	Correction Factor (dB/m)
1	*2441.00	104.9 PK			2.40 V	179	110.5	-5.6
2	*2441.00	74.1 AV			2.40 V	179	79.7	-5.6
3	4882.00	40.5 PK	74.0	-33.5	2.51 V	153	40.2	0.3
4	4882.00	9.7 AV	54.0	-44.3	2.51 V	153	9.4	0.3
5	7323.00	49.9 PK	74.0	-24.1	2.55 V	171	43.0	6.9
6	7323.00	19.1 AV	54.0	-34.9	2.55 V	171	12.2	6.9

Remarks:

1. Emission Level(dBuV/m) = Raw Value(dBuV) + Correction Factor(dB/m)
2. Correction Factor(dB/m) = Antenna Factor(dB/m) + Cable Factor(dB) – Pre-Amplifier Factor(dB)
3. Margin value = Emission Level – Limit value
4. The other emission levels were very low against the limit.
5. " * " : Fundamental frequency, the limit was restricted at the RF Output Power.
6. The average value of fundamental and harmonic frequency is: Average = Peak value + 20 log(Duty cycle) Where the duty cycle correction factor is calculated from following formula:
 $20 \log(\text{Duty cycle}) = 20 \log(2.888 \text{ ms} / 100 \text{ ms}) = -30.8 \text{ dB}$

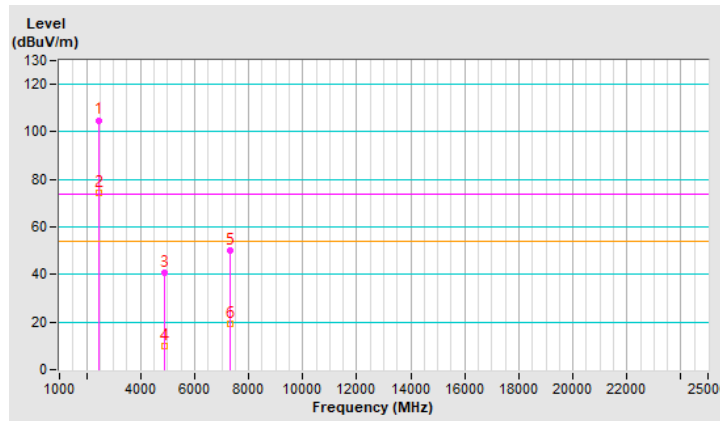

RF Mode	BT GFSK	Channel	CH 78 : 2480 MHz
Frequency Range	1 GHz ~ 25 GHz	Detector Function & Bandwidth	(PK) RB = 1 MHz, VB = 3 MHz (AV) RB = 1 MHz, VB = 3 MHz
Input Power (System)	120 Vac, 60 Hz	Environmental Conditions	29°C, 77% RH
Tested By	Louis Yang		

Antenna Polarity & Test Distance : Horizontal at 3 m								
No	Frequency (MHz)	Emission Level (dBuV/m)	Limit (dBuV/m)	Margin (dB)	Antenna Height (m)	Table Angle (Degree)	Raw Value (dBuV)	Correction Factor (dB/m)
1	*2480.00	104.2 PK			3.37 H	289	109.9	-5.7
2	*2480.00	73.4 AV			3.37 H	289	79.1	-5.7
3	2483.50	51.9 PK	74.0	-22.1	3.37 H	289	57.6	-5.7
4	2483.50	40.4 AV	54.0	-13.6	3.37 H	289	46.1	-5.7
5	4960.00	39.4 PK	74.0	-34.6	3.59 H	203	38.9	0.5
6	4960.00	8.6 AV	54.0	-45.4	3.59 H	203	8.1	0.5
7	7440.00	49.2 PK	74.0	-24.8	3.72 H	224	41.8	7.4
8	7440.00	18.4 AV	54.0	-35.6	3.72 H	224	11.0	7.4

Remarks:

1. Emission Level(dBuV/m) = Raw Value(dBuV) + Correction Factor(dB/m)
2. Correction Factor(dB/m) = Antenna Factor(dB/m) + Cable Factor(dB) – Pre-Amplifier Factor(dB)
3. Margin value = Emission Level – Limit value
4. The other emission levels were very low against the limit.
5. " * ": Fundamental frequency, the limit was restricted at the RF Output Power.
6. The average value of fundamental and harmonic frequency is: Average = Peak value + 20 log(Duty cycle) Where the duty cycle correction factor is calculated from following formula:
 $20 \log(\text{Duty cycle}) = 20 \log(2.888 \text{ ms} / 100 \text{ ms}) = -30.8 \text{ dB}$

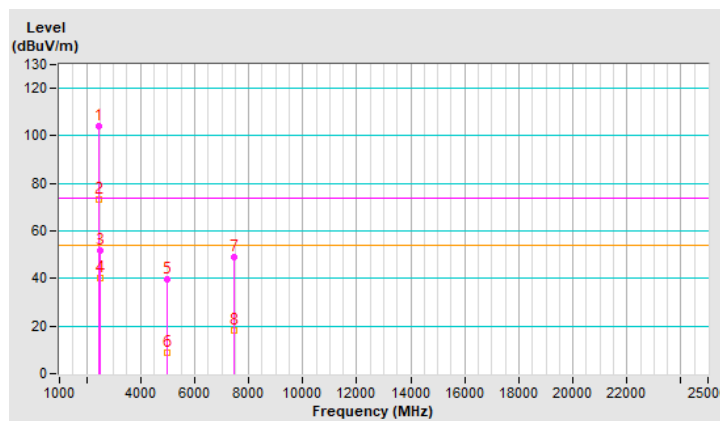

RF Mode	BT GFSK	Channel	CH 78 : 2480 MHz
Frequency Range	1 GHz ~ 25 GHz	Detector Function & Bandwidth	(PK) RB = 1 MHz, VB = 3 MHz (AV) RB = 1 MHz, VB = 3 MHz
Input Power (System)	120 Vac, 60 Hz	Environmental Conditions	29°C, 77% RH
Tested By	Louis Yang		

Antenna Polarity & Test Distance : Vertical at 3 m								
No	Frequency (MHz)	Emission Level (dBuV/m)	Limit (dBuV/m)	Margin (dB)	Antenna Height (m)	Table Angle (Degree)	Raw Value (dBuV)	Correction Factor (dB/m)
1	*2480.00	103.2 PK			2.21 V	150	108.9	-5.7
2	*2480.00	72.4 AV			2.21 V	150	78.1	-5.7
3	2483.50	53.8 PK	74.0	-20.2	2.21 V	150	59.5	-5.7
4	2483.50	41.8 AV	54.0	-12.2	2.21 V	150	47.5	-5.7
5	4960.00	40.8 PK	74.0	-33.2	2.12 V	148	40.3	0.5
6	4960.00	10.0 AV	54.0	-44.0	2.12 V	148	9.5	0.5
7	7440.00	49.2 PK	74.0	-24.8	2.19 V	169	41.8	7.4
8	7440.00	18.4 AV	54.0	-35.6	2.19 V	169	11.0	7.4

Remarks:

1. Emission Level(dBuV/m) = Raw Value(dBuV) + Correction Factor(dB/m)
2. Correction Factor(dB/m) = Antenna Factor(dB/m) + Cable Factor(dB) – Pre-Amplifier Factor(dB)
3. Margin value = Emission Level – Limit value
4. The other emission levels were very low against the limit.
5. " * ": Fundamental frequency, the limit was restricted at the RF Output Power.
6. The average value of fundamental and harmonic frequency is: Average = Peak value + 20 log(Duty cycle) Where the duty cycle correction factor is calculated from following formula:
 $20 \log(\text{Duty cycle}) = 20 \log(2.888 \text{ ms} / 100 \text{ ms}) = -30.8 \text{ dB}$

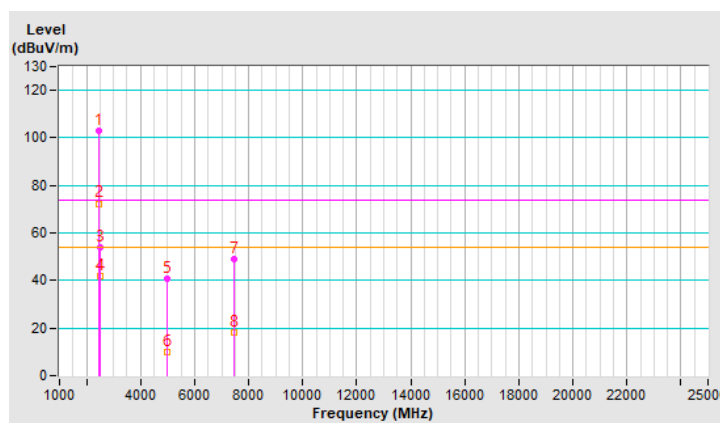

RF Mode	BT 8DPSK	Channel	CH 0 : 2402 MHz
Frequency Range	1 GHz ~ 25 GHz	Detector Function & Bandwidth	(PK) RB = 1 MHz, VB = 3 MHz (AV) RB = 1 MHz, VB = 3 MHz
Input Power (System)	120 Vac, 60 Hz	Environmental Conditions	29°C, 77% RH
Tested By	Louis Yang		

Antenna Polarity & Test Distance : Horizontal at 3 m								
No	Frequency (MHz)	Emission Level (dBuV/m)	Limit (dBuV/m)	Margin (dB)	Antenna Height (m)	Table Angle (Degree)	Raw Value (dBuV)	Correction Factor (dB/m)
1	2390.00	53.7 PK	74.0	-20.3	3.72 H	259	59.4	-5.7
2	2390.00	22.9 AV	54.0	-31.1	3.72 H	259	28.6	-5.7
3	*2402.00	105.3 PK			3.66 H	250	111.0	-5.7
4	*2402.00	74.5 AV			3.66 H	250	80.2	-5.7
5	4804.00	40.5 PK	74.0	-33.5	3.66 H	229	40.2	0.3
6	4804.00	9.7 AV	54.0	-44.3	3.66 H	229	9.4	0.3

Remarks:

1. Emission Level(dBuV/m) = Raw Value(dBuV) + Correction Factor(dB/m)
2. Correction Factor(dB/m) = Antenna Factor(dB/m) + Cable Factor(dB) – Pre-Amplifier Factor(dB)
3. Margin value = Emission Level – Limit value
4. The other emission levels were very low against the limit.
5. " * " : Fundamental frequency, the limit was restricted at the RF Output Power.
6. The average value of fundamental and harmonic frequency is: Average = Peak value + 20 log(Duty cycle) Where the duty cycle correction factor is calculated from following formula:
 $20 \log(\text{Duty cycle}) = 20 \log(2.898 \text{ ms} / 100 \text{ ms}) = -30.8 \text{ dB}$

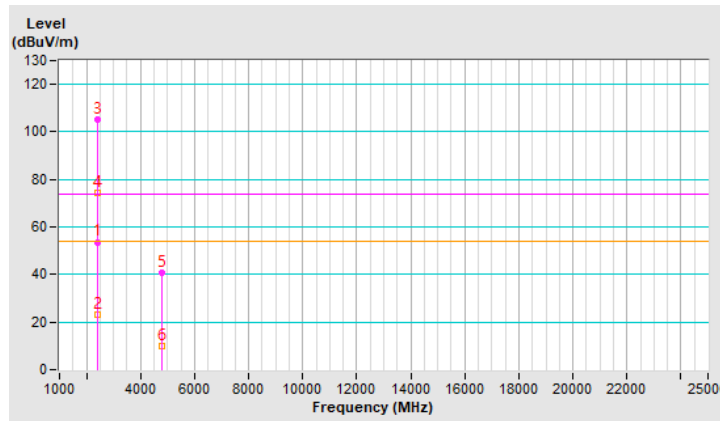

RF Mode	BT 8DPSK	Channel	CH 0 : 2402 MHz
Frequency Range	1 GHz ~ 25 GHz	Detector Function & Bandwidth	(PK) RB = 1 MHz, VB = 3 MHz (AV) RB = 1 MHz, VB = 3 MHz
Input Power (System)	120 Vac, 60 Hz	Environmental Conditions	29°C, 77% RH
Tested By	Louis Yang		

Antenna Polarity & Test Distance : Vertical at 3 m								
No	Frequency (MHz)	Emission Level (dBuV/m)	Limit (dBuV/m)	Margin (dB)	Antenna Height (m)	Table Angle (Degree)	Raw Value (dBuV)	Correction Factor (dB/m)
1	2390.00	53.3 PK	74.0	-20.7	2.73 V	162	59.0	-5.7
2	2390.00	22.5 AV	54.0	-31.5	2.73 V	162	28.2	-5.7
3	*2402.00	104.3 PK			2.66 V	138	110.0	-5.7
4	*2402.00	73.5 AV			2.66 V	138	79.2	-5.7
5	4804.00	40.8 PK	74.0	-33.2	2.51 V	163	40.5	0.3
6	4804.00	10.0 AV	54.0	-44.0	2.51 V	163	9.7	0.3

Remarks:

1. Emission Level(dBuV/m) = Raw Value(dBuV) + Correction Factor(dB/m)
2. Correction Factor(dB/m) = Antenna Factor(dB/m) + Cable Factor(dB) – Pre-Amplifier Factor(dB)
3. Margin value = Emission Level – Limit value
4. The other emission levels were very low against the limit.
5. " * " : Fundamental frequency, the limit was restricted at the RF Output Power.
6. The average value of fundamental and harmonic frequency is: Average = Peak value + 20 log(Duty cycle) Where the duty cycle correction factor is calculated from following formula:
 $20 \log(\text{Duty cycle}) = 20 \log(2.898 \text{ ms} / 100 \text{ ms}) = -30.8 \text{ dB}$

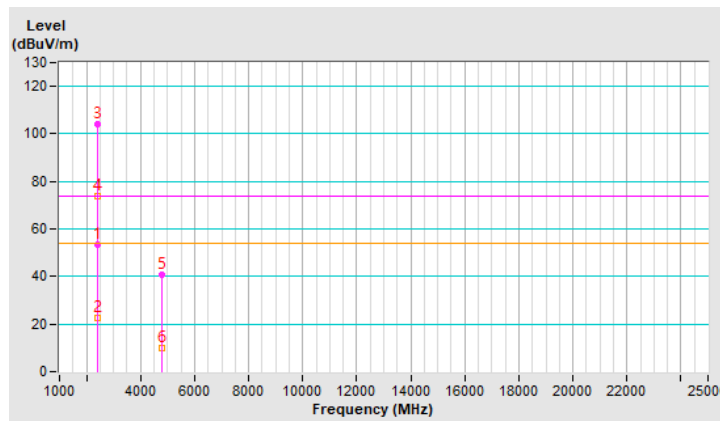

RF Mode	BT 8DPSK	Channel	CH 39 : 2441 MHz
Frequency Range	1 GHz ~ 25 GHz	Detector Function & Bandwidth	(PK) RB = 1 MHz, VB = 3 MHz (AV) RB = 1 MHz, VB = 3 MHz
Input Power (System)	120 Vac, 60 Hz	Environmental Conditions	29°C, 77% RH
Tested By	Louis Yang		

Antenna Polarity & Test Distance : Horizontal at 3 m								
No	Frequency (MHz)	Emission Level (dBuV/m)	Limit (dBuV/m)	Margin (dB)	Antenna Height (m)	Table Angle (Degree)	Raw Value (dBuV)	Correction Factor (dB/m)
1	*2441.00	104.2 PK			3.70 H	247	109.8	-5.6
2	*2441.00	73.4 AV			3.70 H	247	79.0	-5.6
3	4882.00	40.2 PK	74.0	-33.8	3.67 H	284	39.9	0.3
4	4882.00	9.4 AV	54.0	-44.6	3.67 H	284	9.1	0.3
5	7323.00	49.1 PK	74.0	-24.9	3.55 H	234	42.2	6.9
6	7323.00	18.3 AV	54.0	-35.7	3.55 H	234	11.4	6.9

Remarks:

1. Emission Level(dBuV/m) = Raw Value(dBuV) + Correction Factor(dB/m)
2. Correction Factor(dB/m) = Antenna Factor(dB/m) + Cable Factor(dB) – Pre-Amplifier Factor(dB)
3. Margin value = Emission Level – Limit value
4. The other emission levels were very low against the limit.
5. " * " : Fundamental frequency, the limit was restricted at the RF Output Power.
6. The average value of fundamental and harmonic frequency is: Average = Peak value + 20 log(Duty cycle) Where the duty cycle correction factor is calculated from following formula:
 $20 \log(\text{Duty cycle}) = 20 \log(2.898 \text{ ms} / 100 \text{ ms}) = -30.8 \text{ dB}$

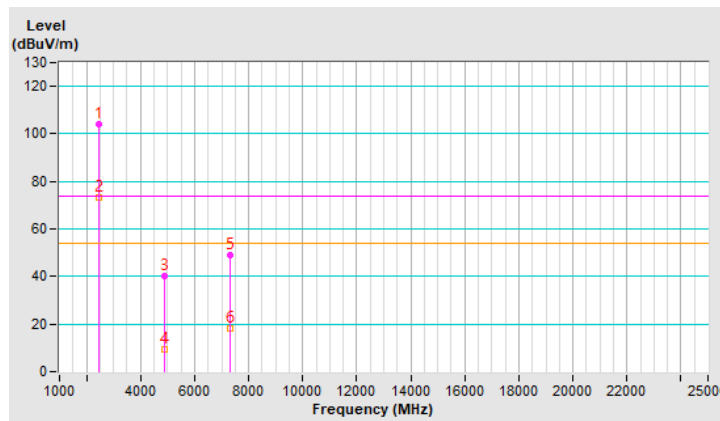

RF Mode	BT 8DPSK	Channel	CH 39 : 2441 MHz
Frequency Range	1 GHz ~ 25 GHz	Detector Function & Bandwidth	(PK) RB = 1 MHz, VB = 3 MHz (AV) RB = 1 MHz, VB = 3 MHz
Input Power (System)	120 Vac, 60 Hz	Environmental Conditions	29°C, 77% RH
Tested By	Louis Yang		

Antenna Polarity & Test Distance : Vertical at 3 m								
No	Frequency (MHz)	Emission Level (dBuV/m)	Limit (dBuV/m)	Margin (dB)	Antenna Height (m)	Table Angle (Degree)	Raw Value (dBuV)	Correction Factor (dB/m)
1	*2441.00	104.5 PK			2.47 V	177	110.1	-5.6
2	*2441.00	73.7 AV			2.47 V	177	79.3	-5.6
3	4882.00	39.8 PK	74.0	-34.2	2.54 V	159	39.5	0.3
4	4882.00	9.0 AV	54.0	-45.0	2.54 V	159	8.7	0.3
5	7323.00	49.8 PK	74.0	-24.2	2.41 V	164	42.9	6.9
6	7323.00	19.0 AV	54.0	-35.0	2.41 V	164	12.1	6.9

Remarks:

1. Emission Level(dBuV/m) = Raw Value(dBuV) + Correction Factor(dB/m)
2. Correction Factor(dB/m) = Antenna Factor(dB/m) + Cable Factor(dB) – Pre-Amplifier Factor(dB)
3. Margin value = Emission Level – Limit value
4. The other emission levels were very low against the limit.
5. " * " : Fundamental frequency, the limit was restricted at the RF Output Power.
6. The average value of fundamental and harmonic frequency is: Average = Peak value + 20 log(Duty cycle) Where the duty cycle correction factor is calculated from following formula:
 $20 \log(\text{Duty cycle}) = 20 \log(2.898 \text{ ms} / 100 \text{ ms}) = -30.8 \text{ dB}$

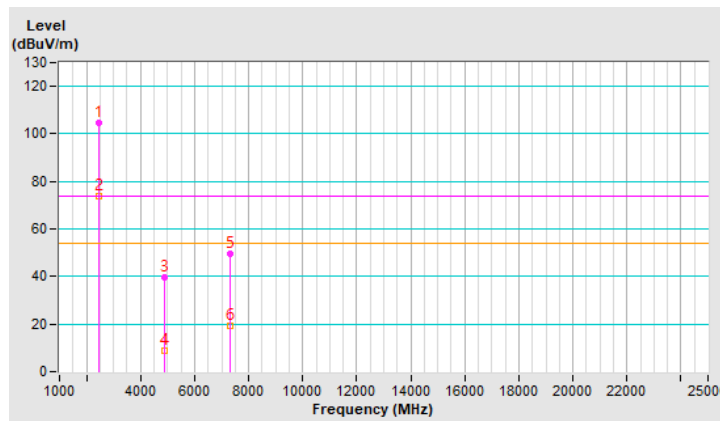

RF Mode	BT 8DPSK	Channel	CH 78 : 2480 MHz
Frequency Range	1 GHz ~ 25 GHz	Detector Function & Bandwidth	(PK) RB = 1 MHz, VB = 3 MHz (AV) RB = 1 MHz, VB = 3 MHz
Input Power (System)	120 Vac, 60 Hz	Environmental Conditions	29°C, 77% RH
Tested By	Louis Yang		

Antenna Polarity & Test Distance : Horizontal at 3 m								
No	Frequency (MHz)	Emission Level (dBuV/m)	Limit (dBuV/m)	Margin (dB)	Antenna Height (m)	Table Angle (Degree)	Raw Value (dBuV)	Correction Factor (dB/m)
1	*2480.00	105.3 PK			3.38 H	278	111.0	-5.7
2	*2480.00	74.5 AV			3.38 H	278	80.2	-5.7
3	2483.50	53.4 PK	74.0	-20.6	3.38 H	278	59.1	-5.7
4	2483.50	42.5 AV	54.0	-11.5	3.38 H	278	48.2	-5.7
5	4960.00	40.0 PK	74.0	-34.0	3.47 H	270	39.5	0.5
6	4960.00	9.2 AV	54.0	-44.8	3.47 H	270	8.7	0.5
7	7440.00	49.8 PK	74.0	-24.2	3.60 H	266	42.4	7.4
8	7440.00	19.0 AV	54.0	-35.0	3.60 H	266	11.6	7.4

Remarks:

1. Emission Level(dBuV/m) = Raw Value(dBuV) + Correction Factor(dB/m)
2. Correction Factor(dB/m) = Antenna Factor(dB/m) + Cable Factor(dB) – Pre-Amplifier Factor(dB)
3. Margin value = Emission Level – Limit value
4. The other emission levels were very low against the limit.
5. " * ": Fundamental frequency, the limit was restricted at the RF Output Power.
6. The average value of fundamental and harmonic frequency is: Average = Peak value + 20 log(Duty cycle) Where the duty cycle correction factor is calculated from following formula:
 $20 \log(\text{Duty cycle}) = 20 \log(2.898 \text{ ms} / 100 \text{ ms}) = -30.8 \text{ dB}$

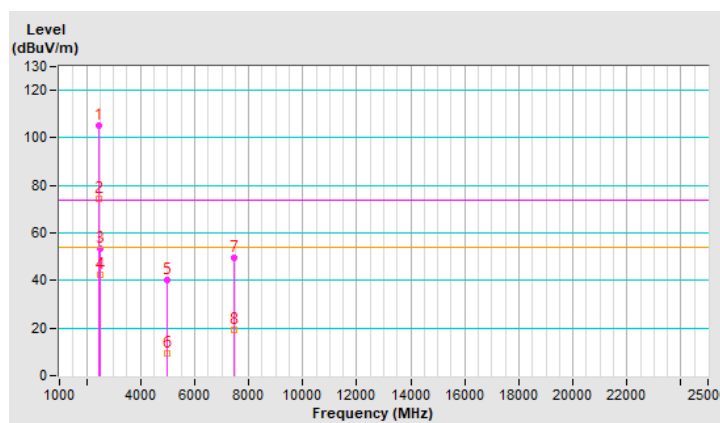

RF Mode	BT 8DPSK	Channel	CH 78 : 2480 MHz
Frequency Range	1 GHz ~ 25 GHz	Detector Function & Bandwidth	(PK) RB = 1 MHz, VB = 3 MHz (AV) RB = 1 MHz, VB = 3 MHz
Input Power (System)	120 Vac, 60 Hz	Environmental Conditions	29°C, 77% RH
Tested By	Louis Yang		

Antenna Polarity & Test Distance : Vertical at 3 m								
No	Frequency (MHz)	Emission Level (dBuV/m)	Limit (dBuV/m)	Margin (dB)	Antenna Height (m)	Table Angle (Degree)	Raw Value (dBuV)	Correction Factor (dB/m)
1	*2480.00	103.8 PK			2.38 V	184	109.5	-5.7
2	*2480.00	73.0 AV			2.38 V	184	78.7	-5.7
3	2483.50	53.6 PK	74.0	-20.4	2.38 V	184	59.3	-5.7
4	2483.50	41.4 AV	54.0	-12.6	2.38 V	184	47.1	-5.7
5	4960.00	40.0 PK	74.0	-34.0	2.66 V	162	39.5	0.5
6	4960.00	9.2 AV	54.0	-44.8	2.66 V	162	8.7	0.5
7	7440.00	49.0 PK	74.0	-25.0	2.46 V	171	41.6	7.4
8	7440.00	18.2 AV	54.0	-35.8	2.46 V	171	10.8	7.4

Remarks:

1. Emission Level(dBuV/m) = Raw Value(dBuV) + Correction Factor(dB/m)
2. Correction Factor(dB/m) = Antenna Factor(dB/m) + Cable Factor(dB) – Pre-Amplifier Factor(dB)
3. Margin value = Emission Level – Limit value
4. The other emission levels were very low against the limit.
5. " * ": Fundamental frequency, the limit was restricted at the RF Output Power.
6. The average value of fundamental and harmonic frequency is: Average = Peak value + 20 log(Duty cycle) Where the duty cycle correction factor is calculated from following formula:
 $20 \log(\text{Duty cycle}) = 20 \log(2.898 \text{ ms} / 100 \text{ ms}) = -30.8 \text{ dB}$

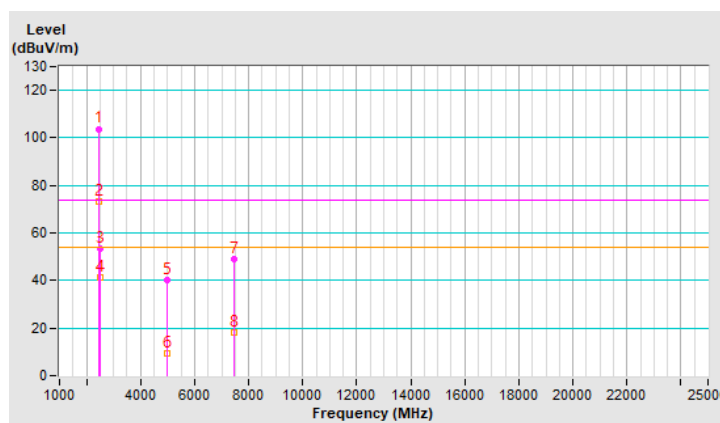

Mode C

RF Mode	BT GFSK	Channel	CH 0 : 2402 MHz
Frequency Range	1 GHz ~ 25 GHz	Detector Function & Bandwidth	(PK) RB = 1 MHz, VB = 3 MHz (AV) RB = 1 MHz, VB = 3 MHz
Input Power (System)	120 Vac, 60 Hz	Environmental Conditions	29°C, 78% RH
Tested By	Louis Yang		

Antenna Polarity & Test Distance : Horizontal at 3 m								
No	Frequency (MHz)	Emission Level (dBuV/m)	Limit (dBuV/m)	Margin (dB)	Antenna Height (m)	Table Angle (Degree)	Raw Value (dBuV)	Correction Factor (dB/m)
1	2390.00	53.9 PK	74.0	-20.1	1.22 H	190	59.6	-5.7
2	2390.00	42.2 AV	54.0	-11.8	1.22 H	190	47.9	-5.7
3	*2402.00	106.0 PK			1.22 H	190	111.7	-5.7
4	*2402.00	75.2 AV			1.22 H	190	80.9	-5.7
5	4804.00	46.5 PK	74.0	-27.5	1.06 H	210	46.2	0.3
6	4804.00	15.7 AV	54.0	-38.3	1.06 H	210	15.4	0.3

Remarks:

1. Emission Level(dBuV/m) = Raw Value(dBuV) + Correction Factor(dB/m)
2. Correction Factor(dB/m) = Antenna Factor(dB/m) + Cable Factor(dB) – Pre-Amplifier Factor(dB)
3. Margin value = Emission Level – Limit value
4. The other emission levels were very low against the limit.
5. " * ": Fundamental frequency, the limit was restricted at the RF Output Power.
6. The average value of fundamental and harmonic frequency is: Average = Peak value + 20 log(Duty cycle) Where the duty cycle correction factor is calculated from following formula:
 $20 \log(\text{Duty cycle}) = 20 \log(2.888 \text{ ms} / 100 \text{ ms}) = -30.8 \text{ dB}$

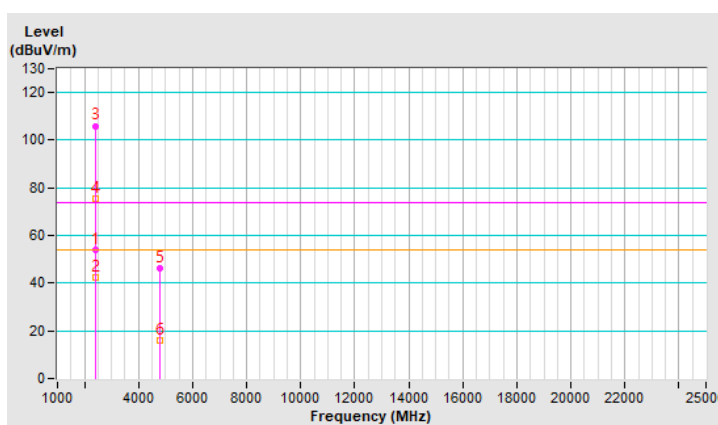

RF Mode	BT GFSK	Channel	CH 0 : 2402 MHz
Frequency Range	1 GHz ~ 25 GHz	Detector Function & Bandwidth	(PK) RB = 1 MHz, VB = 3 MHz (AV) RB = 1 MHz, VB = 3 MHz
Input Power (System)	120 Vac, 60 Hz	Environmental Conditions	29°C, 78% RH
Tested By	Louis Yang		

Antenna Polarity & Test Distance : Vertical at 3 m								
No	Frequency (MHz)	Emission Level (dBuV/m)	Limit (dBuV/m)	Margin (dB)	Antenna Height (m)	Table Angle (Degree)	Raw Value (dBuV)	Correction Factor (dB/m)
1	2390.00	53.8 PK	74.0	-20.2	1.55 V	135	59.5	-5.7
2	2390.00	41.5 AV	54.0	-12.5	1.55 V	135	47.2	-5.7
3	*2402.00	100.2 PK			1.55 V	135	105.9	-5.7
4	*2402.00	69.4 AV			1.55 V	135	75.1	-5.7
5	4804.00	43.1 PK	74.0	-30.9	1.32 V	249	42.8	0.3
6	4804.00	12.3 AV	54.0	-41.7	1.32 V	249	12.0	0.3

Remarks:

1. Emission Level(dBuV/m) = Raw Value(dBuV) + Correction Factor(dB/m)
2. Correction Factor(dB/m) = Antenna Factor(dB/m) + Cable Factor(dB) – Pre-Amplifier Factor(dB)
3. Margin value = Emission Level – Limit value
4. The other emission levels were very low against the limit.
5. " * " : Fundamental frequency, the limit was restricted at the RF Output Power.
6. The average value of fundamental and harmonic frequency is: Average = Peak value + 20 log(Duty cycle) Where the duty cycle correction factor is calculated from following formula:
 $20 \log(\text{Duty cycle}) = 20 \log(2.888 \text{ ms} / 100 \text{ ms}) = -30.8 \text{ dB}$

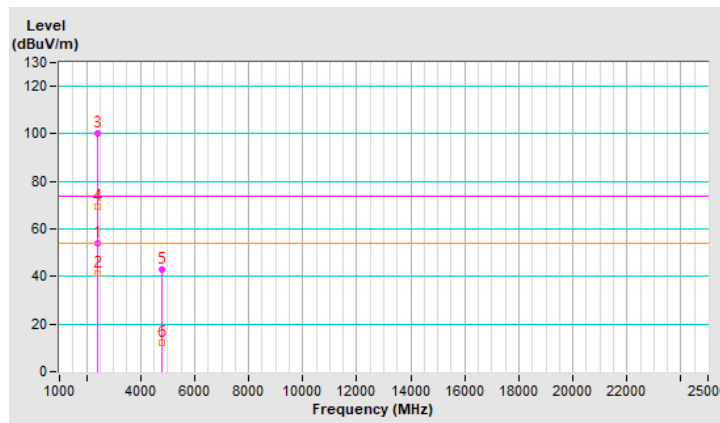

RF Mode	BT GFSK	Channel	CH 39 : 2441 MHz
Frequency Range	1 GHz ~ 25 GHz	Detector Function & Bandwidth	(PK) RB = 1 MHz, VB = 3 MHz (AV) RB = 1 MHz, VB = 3 MHz
Input Power (System)	120 Vac, 60 Hz	Environmental Conditions	29°C, 78% RH
Tested By	Louis Yang		

Antenna Polarity & Test Distance : Horizontal at 3 m								
No	Frequency (MHz)	Emission Level (dBuV/m)	Limit (dBuV/m)	Margin (dB)	Antenna Height (m)	Table Angle (Degree)	Raw Value (dBuV)	Correction Factor (dB/m)
1	*2441.00	108.8 PK			1.31 H	165	114.4	-5.6
2	*2441.00	78.0 AV			1.31 H	165	83.6	-5.6
3	4882.00	47.2 PK	74.0	-26.8	2.31 H	284	46.9	0.3
4	4882.00	16.4 AV	54.0	-37.6	2.31 H	284	16.1	0.3
5	7323.00	43.4 PK	74.0	-30.6	1.79 H	156	36.5	6.9
6	7323.00	12.6 AV	54.0	-41.4	1.79 H	156	5.7	6.9

Remarks:

1. Emission Level(dBuV/m) = Raw Value(dBuV) + Correction Factor(dB/m)
2. Correction Factor(dB/m) = Antenna Factor(dB/m) + Cable Factor(dB) – Pre-Amplifier Factor(dB)
3. Margin value = Emission Level – Limit value
4. The other emission levels were very low against the limit.
5. " * " : Fundamental frequency, the limit was restricted at the RF Output Power.
6. The average value of fundamental and harmonic frequency is: Average = Peak value + 20 log(Duty cycle) Where the duty cycle correction factor is calculated from following formula:
 $20 \log(\text{Duty cycle}) = 20 \log(2.888 \text{ ms} / 100 \text{ ms}) = -30.8 \text{ dB}$

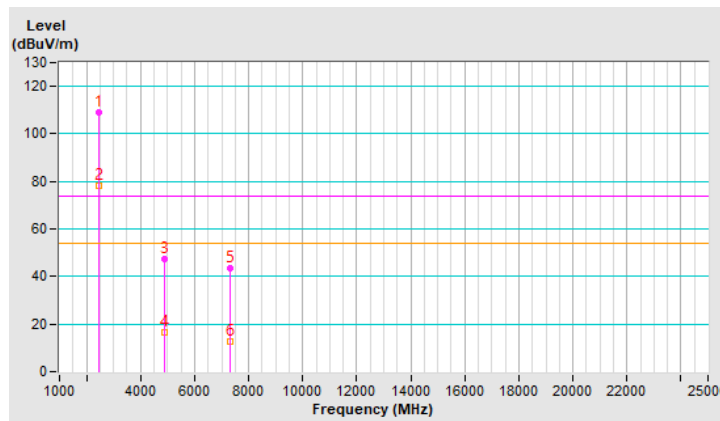

RF Mode	BT GFSK	Channel	CH 39 : 2441 MHz
Frequency Range	1 GHz ~ 25 GHz	Detector Function & Bandwidth	(PK) RB = 1 MHz, VB = 3 MHz (AV) RB = 1 MHz, VB = 3 MHz
Input Power (System)	120 Vac, 60 Hz	Environmental Conditions	29°C, 78% RH
Tested By	Louis Yang		

Antenna Polarity & Test Distance : Vertical at 3 m								
No	Frequency (MHz)	Emission Level (dBuV/m)	Limit (dBuV/m)	Margin (dB)	Antenna Height (m)	Table Angle (Degree)	Raw Value (dBuV)	Correction Factor (dB/m)
1	*2441.00	102.8 PK			2.01 V	192	108.4	-5.6
2	*2441.00	72.0 AV			2.01 V	192	77.6	-5.6
3	4882.00	51.9 PK	74.0	-22.1	2.54 V	246	51.6	0.3
4	4882.00	21.1 AV	54.0	-32.9	2.54 V	246	20.8	0.3
5	7323.00	43.6 PK	74.0	-30.4	1.82 V	145	36.7	6.9
6	7323.00	12.8 AV	54.0	-41.2	1.82 V	145	5.9	6.9

Remarks:

1. Emission Level(dBuV/m) = Raw Value(dBuV) + Correction Factor(dB/m)
2. Correction Factor(dB/m) = Antenna Factor(dB/m) + Cable Factor(dB) – Pre-Amplifier Factor(dB)
3. Margin value = Emission Level – Limit value
4. The other emission levels were very low against the limit.
5. " * " : Fundamental frequency, the limit was restricted at the RF Output Power.
6. The average value of fundamental and harmonic frequency is: Average = Peak value + 20 log(Duty cycle) Where the duty cycle correction factor is calculated from following formula:
 $20 \log(\text{Duty cycle}) = 20 \log(2.888 \text{ ms} / 100 \text{ ms}) = -30.8 \text{ dB}$

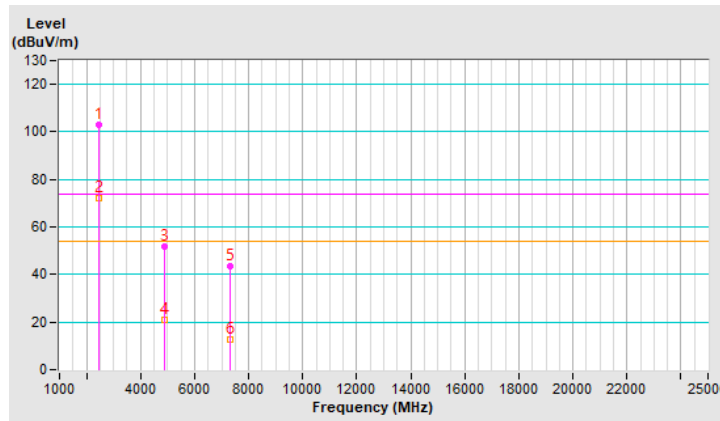

RF Mode	BT GFSK	Channel	CH 78 : 2480 MHz
Frequency Range	1 GHz ~ 25 GHz	Detector Function & Bandwidth	(PK) RB = 1 MHz, VB = 3 MHz (AV) RB = 1 MHz, VB = 3 MHz
Input Power (System)	120 Vac, 60 Hz	Environmental Conditions	29°C, 78% RH
Tested By	Louis Yang		

Antenna Polarity & Test Distance : Horizontal at 3 m								
No	Frequency (MHz)	Emission Level (dBuV/m)	Limit (dBuV/m)	Margin (dB)	Antenna Height (m)	Table Angle (Degree)	Raw Value (dBuV)	Correction Factor (dB/m)
1	*2480.00	107.9 PK			1.17 H	181	113.6	-5.7
2	*2480.00	77.1 AV			1.17 H	181	82.8	-5.7
3	2483.50	60.7 PK	74.0	-13.3	1.17 H	181	66.4	-5.7
4	2483.50	45.5 AV	54.0	-8.5	1.17 H	181	51.2	-5.7
5	4960.00	47.7 PK	74.0	-26.3	2.33 H	288	47.2	0.5
6	4960.00	16.9 AV	54.0	-37.1	2.33 H	288	16.4	0.5
7	7440.00	43.2 PK	74.0	-30.8	1.56 H	178	35.8	7.4
8	7440.00	12.4 AV	54.0	-41.6	1.56 H	178	5.0	7.4

Remarks:

1. Emission Level(dBuV/m) = Raw Value(dBuV) + Correction Factor(dB/m)
2. Correction Factor(dB/m) = Antenna Factor(dB/m) + Cable Factor(dB) – Pre-Amplifier Factor(dB)
3. Margin value = Emission Level – Limit value
4. The other emission levels were very low against the limit.
5. " * ": Fundamental frequency, the limit was restricted at the RF Output Power.
6. The average value of fundamental and harmonic frequency is: Average = Peak value + 20 log(Duty cycle) Where the duty cycle correction factor is calculated from following formula:
 $20 \log(\text{Duty cycle}) = 20 \log(2.888 \text{ ms} / 100 \text{ ms}) = -30.8 \text{ dB}$

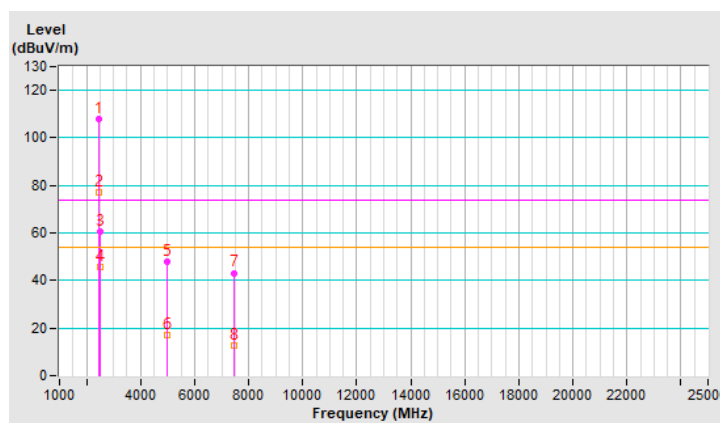

RF Mode	BT GFSK	Channel	CH 78 : 2480 MHz
Frequency Range	1 GHz ~ 25 GHz	Detector Function & Bandwidth	(PK) RB = 1 MHz, VB = 3 MHz (AV) RB = 1 MHz, VB = 3 MHz
Input Power (System)	120 Vac, 60 Hz	Environmental Conditions	29°C, 78% RH
Tested By	Louis Yang		

Antenna Polarity & Test Distance : Vertical at 3 m								
No	Frequency (MHz)	Emission Level (dBuV/m)	Limit (dBuV/m)	Margin (dB)	Antenna Height (m)	Table Angle (Degree)	Raw Value (dBuV)	Correction Factor (dB/m)
1	*2480.00	102.9 PK			1.79 V	155	108.6	-5.7
2	*2480.00	72.1 AV			1.79 V	155	77.8	-5.7
3	2483.50	60.3 PK	74.0	-13.7	1.79 V	155	66.0	-5.7
4	2483.50	46.4 AV	54.0	-7.6	1.79 V	155	52.1	-5.7
5	4960.00	50.1 PK	74.0	-23.9	2.48 V	246	49.6	0.5
6	4960.00	19.3 AV	54.0	-34.7	2.48 V	246	18.8	0.5
7	7440.00	41.2 PK	74.0	-32.8	1.62 V	149	33.8	7.4
8	7440.00	10.4 AV	54.0	-43.6	1.62 V	149	3.0	7.4

Remarks:

1. Emission Level(dBuV/m) = Raw Value(dBuV) + Correction Factor(dB/m)
2. Correction Factor(dB/m) = Antenna Factor(dB/m) + Cable Factor(dB) – Pre-Amplifier Factor(dB)
3. Margin value = Emission Level – Limit value
4. The other emission levels were very low against the limit.
5. " * ": Fundamental frequency, the limit was restricted at the RF Output Power.
6. The average value of fundamental and harmonic frequency is: Average = Peak value + 20 log(Duty cycle) Where the duty cycle correction factor is calculated from following formula:
 $20 \log(\text{Duty cycle}) = 20 \log(2.888 \text{ ms} / 100 \text{ ms}) = -30.8 \text{ dB}$

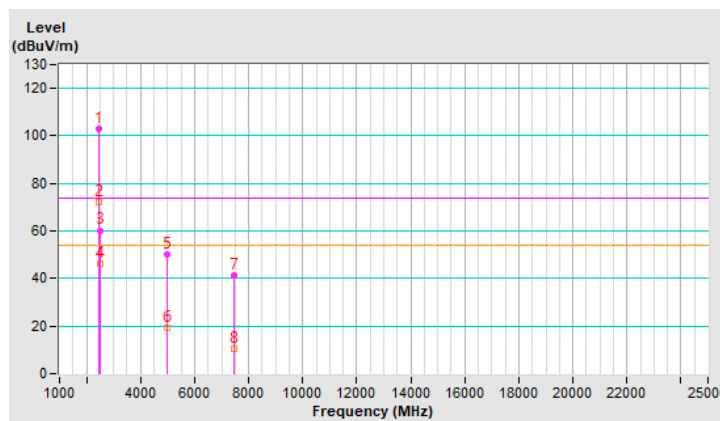

RF Mode	BT 8DPSK	Channel	CH 0 : 2402 MHz
Frequency Range	1 GHz ~ 25 GHz	Detector Function & Bandwidth	(PK) RB = 1 MHz, VB = 3 MHz (AV) RB = 1 MHz, VB = 3 MHz
Input Power (System)	120 Vac, 60 Hz	Environmental Conditions	29°C, 78% RH
Tested By	Louis Yang		

Antenna Polarity & Test Distance : Horizontal at 3 m								
No	Frequency (MHz)	Emission Level (dBuV/m)	Limit (dBuV/m)	Margin (dB)	Antenna Height (m)	Table Angle (Degree)	Raw Value (dBuV)	Correction Factor (dB/m)
1	2390.00	54.2 PK	74.0	-19.8	1.21 H	209	59.9	-5.7
2	2390.00	42.5 AV	54.0	-11.5	1.21 H	209	48.2	-5.7
3	*2402.00	103.9 PK			1.21 H	209	109.6	-5.7
4	*2402.00	73.1 AV			1.21 H	209	78.8	-5.7
5	4804.00	45.5 PK	74.0	-28.5	1.07 H	214	45.2	0.3
6	4804.00	14.7 AV	54.0	-39.3	1.07 H	214	14.4	0.3

Remarks:

1. Emission Level(dBuV/m) = Raw Value(dBuV) + Correction Factor(dB/m)
2. Correction Factor(dB/m) = Antenna Factor(dB/m) + Cable Factor(dB) – Pre-Amplifier Factor(dB)
3. Margin value = Emission Level – Limit value
4. The other emission levels were very low against the limit.
5. " * " : Fundamental frequency, the limit was restricted at the RF Output Power.
6. The average value of fundamental and harmonic frequency is: Average = Peak value + 20 log(Duty cycle) Where the duty cycle correction factor is calculated from following formula:
 $20 \log(\text{Duty cycle}) = 20 \log(2.898 \text{ ms} / 100 \text{ ms}) = -30.8 \text{ dB}$

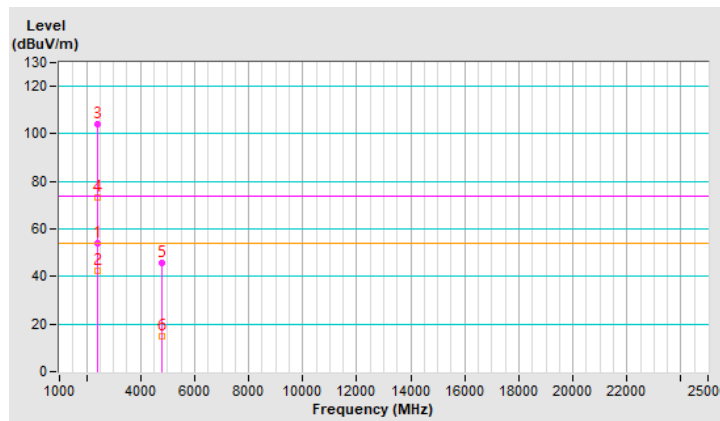

RF Mode	BT 8DPSK	Channel	CH 0 : 2402 MHz
Frequency Range	1 GHz ~ 25 GHz	Detector Function & Bandwidth	(PK) RB = 1 MHz, VB = 3 MHz (AV) RB = 1 MHz, VB = 3 MHz
Input Power (System)	120 Vac, 60 Hz	Environmental Conditions	29°C, 78% RH
Tested By	Louis Yang		

Antenna Polarity & Test Distance : Vertical at 3 m								
No	Frequency (MHz)	Emission Level (dBuV/m)	Limit (dBuV/m)	Margin (dB)	Antenna Height (m)	Table Angle (Degree)	Raw Value (dBuV)	Correction Factor (dB/m)
1	2390.00	52.5 PK	74.0	-21.5	1.89 V	155	58.2	-5.7
2	2390.00	40.6 AV	54.0	-13.4	1.89 V	155	46.3	-5.7
3	*2402.00	98.0 PK			1.89 V	155	103.7	-5.7
4	*2402.00	67.2 AV			1.89 V	155	72.9	-5.7
5	4804.00	45.2 PK	74.0	-28.8	1.71 V	146	44.9	0.3
6	4804.00	14.4 AV	54.0	-39.6	1.71 V	146	14.1	0.3

Remarks:

1. Emission Level(dBuV/m) = Raw Value(dBuV) + Correction Factor(dB/m)
2. Correction Factor(dB/m) = Antenna Factor(dB/m) + Cable Factor(dB) – Pre-Amplifier Factor(dB)
3. Margin value = Emission Level – Limit value
4. The other emission levels were very low against the limit.
5. " * " : Fundamental frequency, the limit was restricted at the RF Output Power.
6. The average value of fundamental and harmonic frequency is: Average = Peak value + 20 log(Duty cycle) Where the duty cycle correction factor is calculated from following formula:
 $20 \log(\text{Duty cycle}) = 20 \log(2.898 \text{ ms} / 100 \text{ ms}) = -30.8 \text{ dB}$

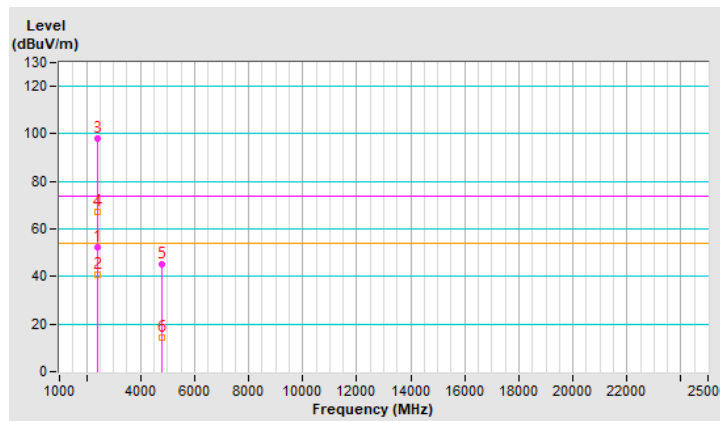

RF Mode	BT 8DPSK	Channel	CH 39 : 2441 MHz
Frequency Range	1 GHz ~ 25 GHz	Detector Function & Bandwidth	(PK) RB = 1 MHz, VB = 3 MHz (AV) RB = 1 MHz, VB = 3 MHz
Input Power (System)	120 Vac, 60 Hz	Environmental Conditions	29°C, 78% RH
Tested By	Louis Yang		

Antenna Polarity & Test Distance : Horizontal at 3 m								
No	Frequency (MHz)	Emission Level (dBuV/m)	Limit (dBuV/m)	Margin (dB)	Antenna Height (m)	Table Angle (Degree)	Raw Value (dBuV)	Correction Factor (dB/m)
1	*2441.00	106.3 PK			1.21 H	163	111.9	-5.6
2	*2441.00	75.5 AV			1.21 H	163	81.1	-5.6
3	4882.00	47.6 PK	74.0	-26.4	2.20 H	269	47.3	0.3
4	4882.00	16.8 AV	54.0	-37.2	2.20 H	269	16.5	0.3
5	7323.00	43.1 PK	74.0	-30.9	1.60 H	142	36.2	6.9
6	7323.00	12.3 AV	54.0	-41.7	1.60 H	142	5.4	6.9

Remarks:

1. Emission Level(dBuV/m) = Raw Value(dBuV) + Correction Factor(dB/m)
2. Correction Factor(dB/m) = Antenna Factor(dB/m) + Cable Factor(dB) – Pre-Amplifier Factor(dB)
3. Margin value = Emission Level – Limit value
4. The other emission levels were very low against the limit.
5. " * " : Fundamental frequency, the limit was restricted at the RF Output Power.
6. The average value of fundamental and harmonic frequency is: Average = Peak value + 20 log(Duty cycle) Where the duty cycle correction factor is calculated from following formula:
 $20 \log(\text{Duty cycle}) = 20 \log(2.898 \text{ ms} / 100 \text{ ms}) = -30.8 \text{ dB}$

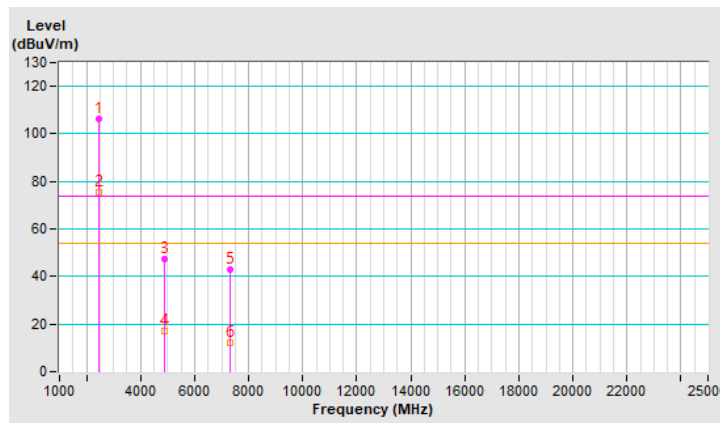

RF Mode	BT 8DPSK	Channel	CH 39 : 2441 MHz
Frequency Range	1 GHz ~ 25 GHz	Detector Function & Bandwidth	(PK) RB = 1 MHz, VB = 3 MHz (AV) RB = 1 MHz, VB = 3 MHz
Input Power (System)	120 Vac, 60 Hz	Environmental Conditions	29°C, 78% RH
Tested By	Louis Yang		

Antenna Polarity & Test Distance : Vertical at 3 m								
No	Frequency (MHz)	Emission Level (dBuV/m)	Limit (dBuV/m)	Margin (dB)	Antenna Height (m)	Table Angle (Degree)	Raw Value (dBuV)	Correction Factor (dB/m)
1	*2441.00	101.4 PK			1.85 V	151	107.0	-5.6
2	*2441.00	70.6 AV			1.85 V	151	76.2	-5.6
3	4882.00	50.1 PK	74.0	-23.9	2.46 V	246	49.8	0.3
4	4882.00	19.3 AV	54.0	-34.7	2.46 V	246	19.0	0.3
5	7323.00	43.3 PK	74.0	-30.7	1.59 V	115	36.4	6.9
6	7323.00	12.5 AV	54.0	-41.5	1.59 V	115	5.6	6.9

Remarks:

1. Emission Level(dBuV/m) = Raw Value(dBuV) + Correction Factor(dB/m)
2. Correction Factor(dB/m) = Antenna Factor(dB/m) + Cable Factor(dB) – Pre-Amplifier Factor(dB)
3. Margin value = Emission Level – Limit value
4. The other emission levels were very low against the limit.
5. " * " : Fundamental frequency, the limit was restricted at the RF Output Power.
6. The average value of fundamental and harmonic frequency is: Average = Peak value + 20 log(Duty cycle) Where the duty cycle correction factor is calculated from following formula:
 $20 \log(\text{Duty cycle}) = 20 \log(2.898 \text{ ms} / 100 \text{ ms}) = -30.8 \text{ dB}$

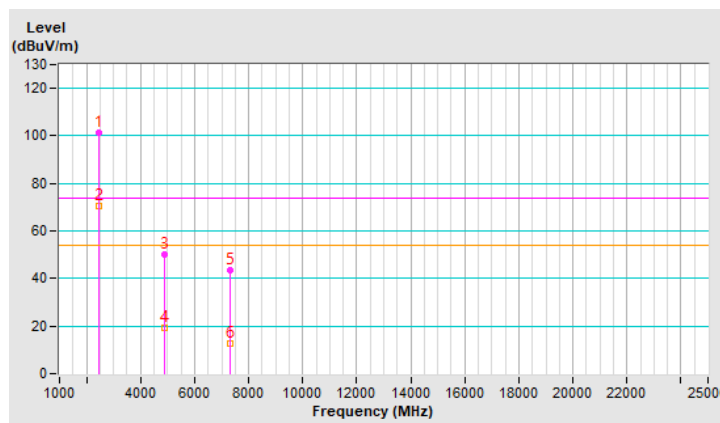

RF Mode	BT 8DPSK	Channel	CH 78 : 2480 MHz
Frequency Range	1 GHz ~ 25 GHz	Detector Function & Bandwidth	(PK) RB = 1 MHz, VB = 3 MHz (AV) RB = 1 MHz, VB = 3 MHz
Input Power (System)	120 Vac, 60 Hz	Environmental Conditions	29°C, 78% RH
Tested By	Louis Yang		

Antenna Polarity & Test Distance : Horizontal at 3 m								
No	Frequency (MHz)	Emission Level (dBuV/m)	Limit (dBuV/m)	Margin (dB)	Antenna Height (m)	Table Angle (Degree)	Raw Value (dBuV)	Correction Factor (dB/m)
1	*2480.00	105.4 PK			1.11 H	211	111.1	-5.7
2	*2480.00	74.6 AV			1.11 H	211	80.3	-5.7
3	2483.50	62.0 PK	74.0	-12.0	1.11 H	211	67.7	-5.7
4	2483.50	47.2 AV	54.0	-6.8	1.11 H	211	52.9	-5.7
5	4960.00	45.9 PK	74.0	-28.1	2.30 H	251	45.4	0.5
6	4960.00	15.1 AV	54.0	-38.9	2.30 H	251	14.6	0.5
7	7440.00	41.4 PK	74.0	-32.6	1.68 H	116	34.0	7.4
8	7440.00	10.6 AV	54.0	-43.4	1.68 H	116	3.2	7.4

Remarks:

1. Emission Level(dBuV/m) = Raw Value(dBuV) + Correction Factor(dB/m)
2. Correction Factor(dB/m) = Antenna Factor(dB/m) + Cable Factor(dB) – Pre-Amplifier Factor(dB)
3. Margin value = Emission Level – Limit value
4. The other emission levels were very low against the limit.
5. " * ": Fundamental frequency, the limit was restricted at the RF Output Power.
6. The average value of fundamental and harmonic frequency is: Average = Peak value + 20 log(Duty cycle) Where the duty cycle correction factor is calculated from following formula:
 $20 \log(\text{Duty cycle}) = 20 \log(2.898 \text{ ms} / 100 \text{ ms}) = -30.8 \text{ dB}$

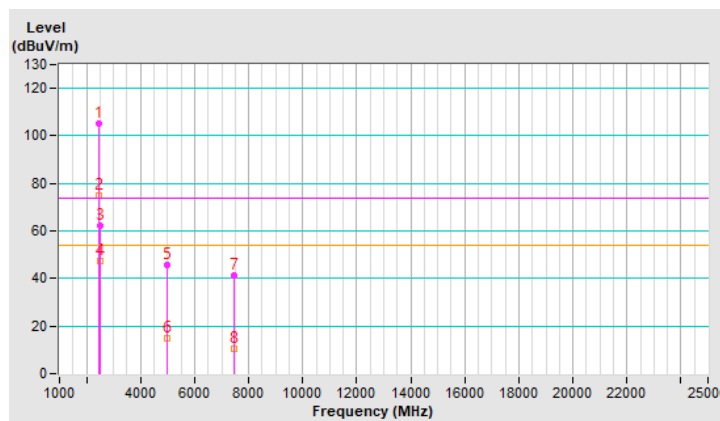

RF Mode	BT 8DPSK	Channel	CH 78 : 2480 MHz
Frequency Range	1 GHz ~ 25 GHz	Detector Function & Bandwidth	(PK) RB = 1 MHz, VB = 3 MHz (AV) RB = 1 MHz, VB = 3 MHz
Input Power (System)	120 Vac, 60 Hz	Environmental Conditions	29°C, 78% RH
Tested By	Louis Yang		

Antenna Polarity & Test Distance : Vertical at 3 m								
No	Frequency (MHz)	Emission Level (dBuV/m)	Limit (dBuV/m)	Margin (dB)	Antenna Height (m)	Table Angle (Degree)	Raw Value (dBuV)	Correction Factor (dB/m)
1	*2480.00	98.9 PK			1.93 V	157	104.6	-5.7
2	*2480.00	68.1 AV			1.93 V	157	73.8	-5.7
3	2483.50	60.8 PK	74.0	-13.2	1.93 V	157	66.5	-5.7
4	2483.50	46.9 AV	54.0	-7.1	1.93 V	157	52.6	-5.7
5	4960.00	50.1 PK	74.0	-23.9	2.45 V	213	49.6	0.5
6	4960.00	19.3 AV	54.0	-34.7	2.45 V	213	18.8	0.5
7	7440.00	42.4 PK	74.0	-31.6	1.63 V	147	35.0	7.4
8	7440.00	11.6 AV	54.0	-42.4	1.63 V	147	4.2	7.4

Remarks:

1. Emission Level(dBuV/m) = Raw Value(dBuV) + Correction Factor(dB/m)
2. Correction Factor(dB/m) = Antenna Factor(dB/m) + Cable Factor(dB) – Pre-Amplifier Factor(dB)
3. Margin value = Emission Level – Limit value
4. The other emission levels were very low against the limit.
5. " * ": Fundamental frequency, the limit was restricted at the RF Output Power.
6. The average value of fundamental and harmonic frequency is: Average = Peak value + 20 log(Duty cycle) Where the duty cycle correction factor is calculated from following formula:
 $20 \log(\text{Duty cycle}) = 20 \log(2.898 \text{ ms} / 100 \text{ ms}) = -30.8 \text{ dB}$

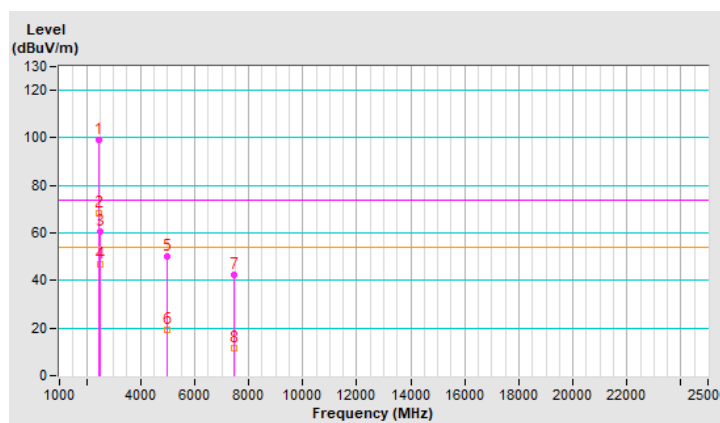

Mode D

RF Mode	BT GFSK	Channel	CH 0 : 2402 MHz
Frequency Range	1 GHz ~ 25 GHz	Detector Function & Bandwidth	(PK) RB = 1 MHz, VB = 3 MHz (AV) RB = 1 MHz, VB = 3 MHz
Input Power (System)	120 Vac, 60 Hz	Environmental Conditions	28°C, 75% RH
Tested By	Louis Yang		

Antenna Polarity & Test Distance : Horizontal at 3 m								
No	Frequency (MHz)	Emission Level (dBuV/m)	Limit (dBuV/m)	Margin (dB)	Antenna Height (m)	Table Angle (Degree)	Raw Value (dBuV)	Correction Factor (dB/m)
1	2390.00	52.8 PK	74.0	-21.2	1.90 H	260	58.5	-5.7
2	2390.00	43.1 AV	54.0	-10.9	1.90 H	260	48.8	-5.7
3	*2402.00	97.5 PK			1.90 H	260	103.2	-5.7
4	*2402.00	66.7 AV			1.90 H	260	72.4	-5.7
5	4804.00	36.6 PK	74.0	-37.4	1.74 H	206	36.3	0.3
6	4804.00	5.8 AV	54.0	-48.2	1.74 H	206	5.5	0.3

Remarks:

1. Emission Level(dBuV/m) = Raw Value(dBuV) + Correction Factor(dB/m)
2. Correction Factor(dB/m) = Antenna Factor(dB/m) + Cable Factor(dB) – Pre-Amplifier Factor(dB)
3. Margin value = Emission Level – Limit value
4. The other emission levels were very low against the limit.
5. " * ": Fundamental frequency, the limit was restricted at the RF Output Power.
6. The average value of fundamental and harmonic frequency is: Average = Peak value + 20 log(Duty cycle) Where the duty cycle correction factor is calculated from following formula:
 $20 \log(\text{Duty cycle}) = 20 \log(2.888 \text{ ms} / 100 \text{ ms}) = -30.8 \text{ dB}$

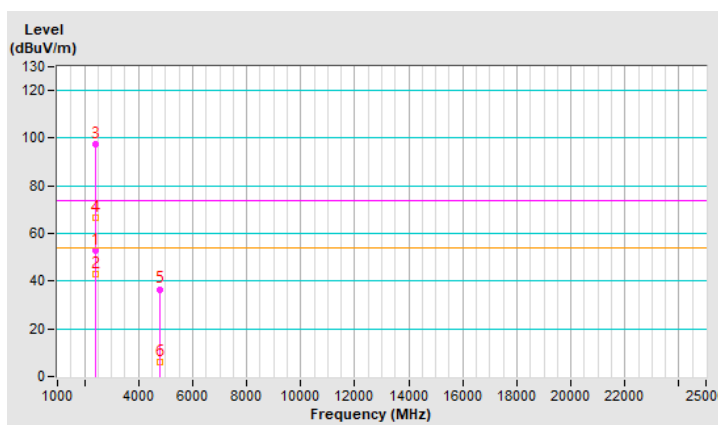

RF Mode	BT GFSK	Channel	CH 0 : 2402 MHz
Frequency Range	1 GHz ~ 25 GHz	Detector Function & Bandwidth	(PK) RB = 1 MHz, VB = 3 MHz (AV) RB = 1 MHz, VB = 3 MHz
Input Power (System)	120 Vac, 60 Hz	Environmental Conditions	28°C, 75% RH
Tested By	Louis Yang		

Antenna Polarity & Test Distance : Vertical at 3 m								
No	Frequency (MHz)	Emission Level (dBuV/m)	Limit (dBuV/m)	Margin (dB)	Antenna Height (m)	Table Angle (Degree)	Raw Value (dBuV)	Correction Factor (dB/m)
1	2390.00	54.4 PK	74.0	-19.6	1.58 V	7	60.1	-5.7
2	2390.00	44.1 AV	54.0	-9.9	1.58 V	7	49.8	-5.7
3	*2402.00	110.1 PK			1.58 V	7	115.8	-5.7
4	*2402.00	79.3 AV			1.58 V	7	85.0	-5.7
5	4804.00	36.6 PK	74.0	-37.4	1.42 V	11	36.3	0.3
6	4804.00	5.8 AV	54.0	-48.2	1.42 V	11	5.5	0.3

Remarks:

1. Emission Level(dBuV/m) = Raw Value(dBuV) + Correction Factor(dB/m)
2. Correction Factor(dB/m) = Antenna Factor(dB/m) + Cable Factor(dB) – Pre-Amplifier Factor(dB)
3. Margin value = Emission Level – Limit value
4. The other emission levels were very low against the limit.
5. " * " : Fundamental frequency, the limit was restricted at the RF Output Power.
6. The average value of fundamental and harmonic frequency is: Average = Peak value + 20 log(Duty cycle) Where the duty cycle correction factor is calculated from following formula:
 $20 \log(\text{Duty cycle}) = 20 \log(2.888 \text{ ms} / 100 \text{ ms}) = -30.8 \text{ dB}$

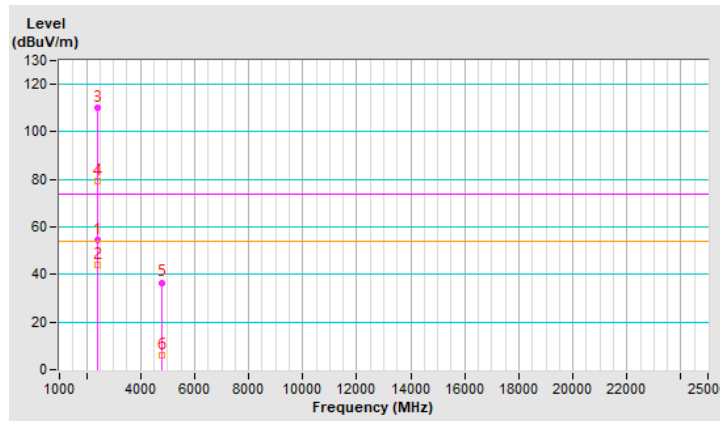

RF Mode	BT GFSK	Channel	CH 39 : 2441 MHz
Frequency Range	1 GHz ~ 25 GHz	Detector Function & Bandwidth	(PK) RB = 1 MHz, VB = 3 MHz (AV) RB = 1 MHz, VB = 3 MHz
Input Power (System)	120 Vac, 60 Hz	Environmental Conditions	28°C, 75% RH
Tested By	Louis Yang		

Antenna Polarity & Test Distance : Horizontal at 3 m								
No	Frequency (MHz)	Emission Level (dBuV/m)	Limit (dBuV/m)	Margin (dB)	Antenna Height (m)	Table Angle (Degree)	Raw Value (dBuV)	Correction Factor (dB/m)
1	*2441.00	97.7 PK			1.87 H	239	103.3	-5.6
2	*2441.00	66.9 AV			1.87 H	239	72.5	-5.6
3	4882.00	37.0 PK	74.0	-37.0	1.77 H	229	36.7	0.3
4	4882.00	6.2 AV	54.0	-47.8	1.77 H	229	5.9	0.3
5	7323.00	41.9 PK	74.0	-32.1	1.00 H	324	35.0	6.9
6	7323.00	11.1 AV	54.0	-42.9	1.00 H	324	4.2	6.9

Remarks:

1. Emission Level(dBuV/m) = Raw Value(dBuV) + Correction Factor(dB/m)
2. Correction Factor(dB/m) = Antenna Factor(dB/m) + Cable Factor(dB) – Pre-Amplifier Factor(dB)
3. Margin value = Emission Level – Limit value
4. The other emission levels were very low against the limit.
5. " * " : Fundamental frequency, the limit was restricted at the RF Output Power.
6. The average value of fundamental and harmonic frequency is: Average = Peak value + 20 log(Duty cycle) Where the duty cycle correction factor is calculated from following formula:
 $20 \log(\text{Duty cycle}) = 20 \log(2.888 \text{ ms} / 100 \text{ ms}) = -30.8 \text{ dB}$

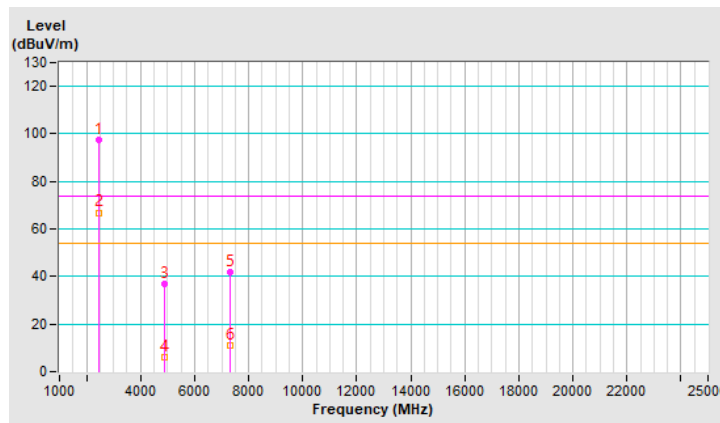

RF Mode	BT GFSK	Channel	CH 39 : 2441 MHz
Frequency Range	1 GHz ~ 25 GHz	Detector Function & Bandwidth	(PK) RB = 1 MHz, VB = 3 MHz (AV) RB = 1 MHz, VB = 3 MHz
Input Power (System)	120 Vac, 60 Hz	Environmental Conditions	28°C, 75% RH
Tested By	Louis Yang		

Antenna Polarity & Test Distance : Vertical at 3 m								
No	Frequency (MHz)	Emission Level (dBuV/m)	Limit (dBuV/m)	Margin (dB)	Antenna Height (m)	Table Angle (Degree)	Raw Value (dBuV)	Correction Factor (dB/m)
1	*2441.00	109.0 PK			1.63 V	26	114.6	-5.6
2	*2441.00	78.2 AV			1.63 V	26	83.8	-5.6
3	4882.00	37.5 PK	74.0	-36.5	1.50 V	22	37.2	0.3
4	4882.00	6.7 AV	54.0	-47.3	1.50 V	22	6.4	0.3
5	7323.00	42.4 PK	74.0	-31.6	1.05 V	4	35.5	6.9
6	7323.00	11.6 AV	54.0	-42.4	1.05 V	4	4.7	6.9

Remarks:

1. Emission Level(dBuV/m) = Raw Value(dBuV) + Correction Factor(dB/m)
2. Correction Factor(dB/m) = Antenna Factor(dB/m) + Cable Factor(dB) – Pre-Amplifier Factor(dB)
3. Margin value = Emission Level – Limit value
4. The other emission levels were very low against the limit.
5. " * " : Fundamental frequency, the limit was restricted at the RF Output Power.
6. The average value of fundamental and harmonic frequency is: Average = Peak value + 20 log(Duty cycle) Where the duty cycle correction factor is calculated from following formula:
 $20 \log(\text{Duty cycle}) = 20 \log(2.888 \text{ ms} / 100 \text{ ms}) = -30.8 \text{ dB}$

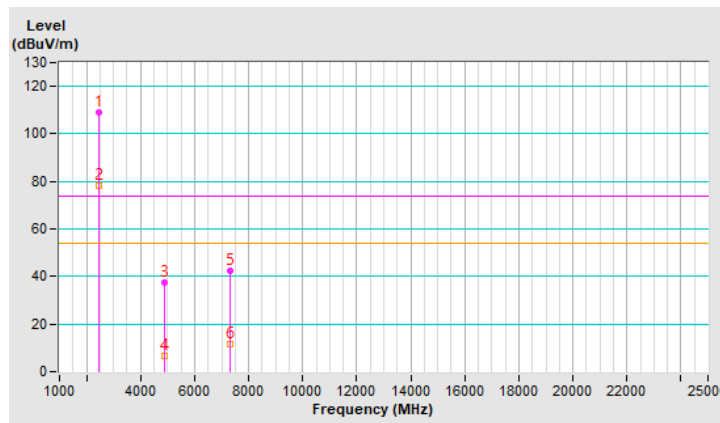

RF Mode	BT GFSK	Channel	CH 78 : 2480 MHz
Frequency Range	1 GHz ~ 25 GHz	Detector Function & Bandwidth	(PK) RB = 1 MHz, VB = 3 MHz (AV) RB = 1 MHz, VB = 3 MHz
Input Power (System)	120 Vac, 60 Hz	Environmental Conditions	28°C, 75% RH
Tested By	Louis Yang		

Antenna Polarity & Test Distance : Horizontal at 3 m								
No	Frequency (MHz)	Emission Level (dBuV/m)	Limit (dBuV/m)	Margin (dB)	Antenna Height (m)	Table Angle (Degree)	Raw Value (dBuV)	Correction Factor (dB/m)
1	*2480.00	95.2 PK			2.29 H	300	100.9	-5.7
2	*2480.00	64.4 AV			2.29 H	300	70.1	-5.7
3	2483.50	53.4 PK	74.0	-20.6	2.29 H	300	59.1	-5.7
4	2483.50	43.3 AV	54.0	-10.7	2.29 H	300	49.0	-5.7
5	4960.00	36.9 PK	74.0	-37.1	1.78 H	221	36.4	0.5
6	4960.00	6.1 AV	54.0	-47.9	1.78 H	221	5.6	0.5
7	7440.00	41.0 PK	74.0	-33.0	1.08 H	314	33.6	7.4
8	7440.00	10.2 AV	54.0	-43.8	1.08 H	314	2.8	7.4

Remarks:

1. Emission Level(dBuV/m) = Raw Value(dBuV) + Correction Factor(dB/m)
2. Correction Factor(dB/m) = Antenna Factor(dB/m) + Cable Factor(dB) – Pre-Amplifier Factor(dB)
3. Margin value = Emission Level – Limit value
4. The other emission levels were very low against the limit.
5. " * ": Fundamental frequency, the limit was restricted at the RF Output Power.
6. The average value of fundamental and harmonic frequency is: Average = Peak value + 20 log(Duty cycle) Where the duty cycle correction factor is calculated from following formula:
 $20 \log(\text{Duty cycle}) = 20 \log(2.888 \text{ ms} / 100 \text{ ms}) = -30.8 \text{ dB}$

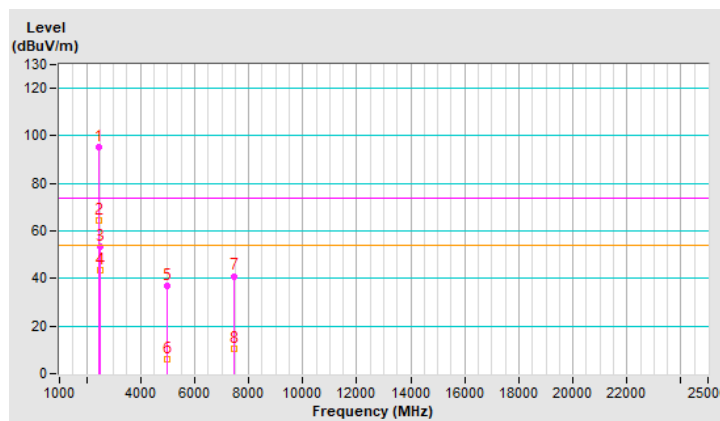

RF Mode	BT GFSK	Channel	CH 78 : 2480 MHz
Frequency Range	1 GHz ~ 25 GHz	Detector Function & Bandwidth	(PK) RB = 1 MHz, VB = 3 MHz (AV) RB = 1 MHz, VB = 3 MHz
Input Power (System)	120 Vac, 60 Hz	Environmental Conditions	28°C, 75% RH
Tested By	Louis Yang		

Antenna Polarity & Test Distance : Vertical at 3 m								
No	Frequency (MHz)	Emission Level (dBUV/m)	Limit (dBUV/m)	Margin (dB)	Antenna Height (m)	Table Angle (Degree)	Raw Value (dBUV)	Correction Factor (dB/m)
1	*2480.00	108.0 PK			1.64 V	19	113.7	-5.7
2	*2480.00	77.2 AV			1.64 V	19	82.9	-5.7
3	2483.50	53.5 PK	74.0	-20.5	1.64 V	19	59.2	-5.7
4	2483.50	42.7 AV	54.0	-11.3	1.64 V	19	48.4	-5.7
5	4960.00	37.1 PK	74.0	-36.9	1.45 V	6	36.6	0.5
6	4960.00	6.3 AV	54.0	-47.7	1.45 V	6	5.8	0.5
7	7440.00	42.6 PK	74.0	-31.4	1.07 V	18	35.2	7.4
8	7440.00	11.8 AV	54.0	-42.2	1.07 V	18	4.4	7.4

Remarks:

1. Emission Level(dBUV/m) = Raw Value(dBUV) + Correction Factor(dB/m)
2. Correction Factor(dB/m) = Antenna Factor(dB/m) + Cable Factor(dB) – Pre-Amplifier Factor(dB)
3. Margin value = Emission Level – Limit value
4. The other emission levels were very low against the limit.
5. " * ": Fundamental frequency, the limit was restricted at the RF Output Power.
6. The average value of fundamental and harmonic frequency is: Average = Peak value + 20 log(Duty cycle) Where the duty cycle correction factor is calculated from following formula:
 $20 \log(\text{Duty cycle}) = 20 \log(2.888 \text{ ms} / 100 \text{ ms}) = -30.8 \text{ dB}$

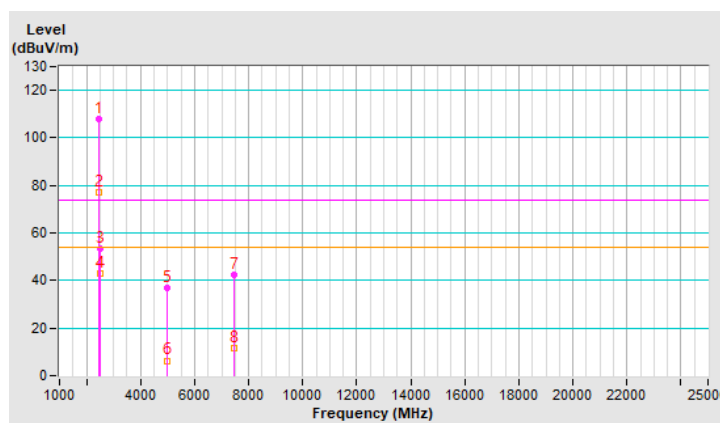

RF Mode	BT 8DPSK	Channel	CH 0 : 2402 MHz
Frequency Range	1 GHz ~ 25 GHz	Detector Function & Bandwidth	(PK) RB = 1 MHz, VB = 3 MHz (AV) RB = 1 MHz, VB = 3 MHz
Input Power (System)	120 Vac, 60 Hz	Environmental Conditions	28°C, 75% RH
Tested By	Louis Yang		

Antenna Polarity & Test Distance : Horizontal at 3 m								
No	Frequency (MHz)	Emission Level (dBuV/m)	Limit (dBuV/m)	Margin (dB)	Antenna Height (m)	Table Angle (Degree)	Raw Value (dBuV)	Correction Factor (dB/m)
1	2390.00	52.6 PK	74.0	-21.4	1.87 H	250	58.3	-5.7
2	2390.00	41.4 AV	54.0	-12.6	1.87 H	250	47.1	-5.7
3	*2402.00	95.2 PK			1.87 H	250	100.9	-5.7
4	*2402.00	64.4 AV			1.87 H	250	70.1	-5.7
5	4804.00	36.8 PK	74.0	-37.2	1.82 H	209	36.5	0.3
6	4804.00	6.0 AV	54.0	-48.0	1.82 H	209	5.7	0.3

Remarks:

1. Emission Level(dBuV/m) = Raw Value(dBuV) + Correction Factor(dB/m)
2. Correction Factor(dB/m) = Antenna Factor(dB/m) + Cable Factor(dB) – Pre-Amplifier Factor(dB)
3. Margin value = Emission Level – Limit value
4. The other emission levels were very low against the limit.
5. " * " : Fundamental frequency, the limit was restricted at the RF Output Power.
6. The average value of fundamental and harmonic frequency is: Average = Peak value + 20 log(Duty cycle) Where the duty cycle correction factor is calculated from following formula:
 $20 \log(\text{Duty cycle}) = 20 \log(2.898 \text{ ms} / 100 \text{ ms}) = -30.8 \text{ dB}$

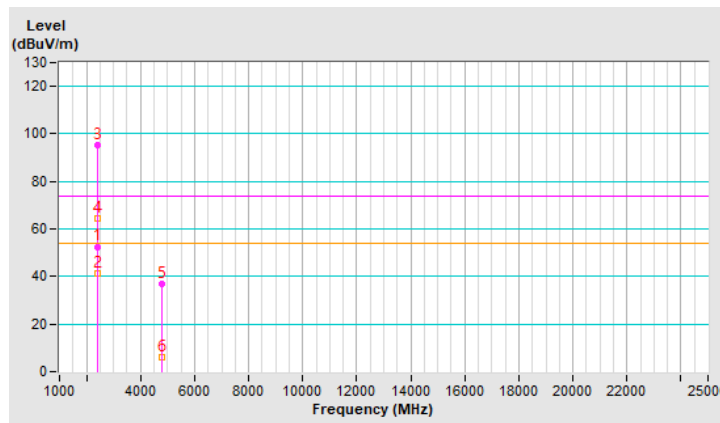

RF Mode	BT 8DPSK	Channel	CH 0 : 2402 MHz
Frequency Range	1 GHz ~ 25 GHz	Detector Function & Bandwidth	(PK) RB = 1 MHz, VB = 3 MHz (AV) RB = 1 MHz, VB = 3 MHz
Input Power (System)	120 Vac, 60 Hz	Environmental Conditions	28°C, 75% RH
Tested By	Louis Yang		

Antenna Polarity & Test Distance : Vertical at 3 m								
No	Frequency (MHz)	Emission Level (dBuV/m)	Limit (dBuV/m)	Margin (dB)	Antenna Height (m)	Table Angle (Degree)	Raw Value (dBuV)	Correction Factor (dB/m)
1	2390.00	54.4 PK	74.0	-19.6	1.28 V	25	60.1	-5.7
2	2390.00	44.0 AV	54.0	-10.0	1.28 V	25	49.7	-5.7
3	*2402.00	109.2 PK			1.28 V	25	114.9	-5.7
4	*2402.00	78.4 AV			1.28 V	25	84.1	-5.7
5	4804.00	37.3 PK	74.0	-36.7	1.50 V	19	37.0	0.3
6	4804.00	6.5 AV	54.0	-47.5	1.50 V	19	6.2	0.3

Remarks:

1. Emission Level(dBuV/m) = Raw Value(dBuV) + Correction Factor(dB/m)
2. Correction Factor(dB/m) = Antenna Factor(dB/m) + Cable Factor(dB) – Pre-Amplifier Factor(dB)
3. Margin value = Emission Level – Limit value
4. The other emission levels were very low against the limit.
5. " * " : Fundamental frequency, the limit was restricted at the RF Output Power.
6. The average value of fundamental and harmonic frequency is: Average = Peak value + 20 log(Duty cycle) Where the duty cycle correction factor is calculated from following formula:
 $20 \log(\text{Duty cycle}) = 20 \log(2.898 \text{ ms} / 100 \text{ ms}) = -30.8 \text{ dB}$

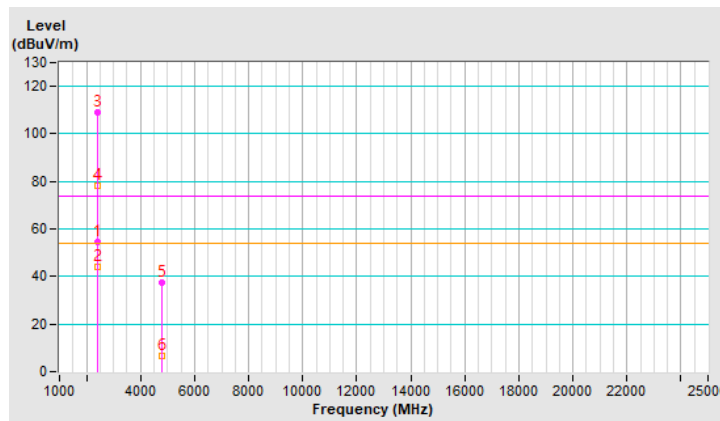

RF Mode	BT 8DPSK	Channel	CH 39 : 2441 MHz
Frequency Range	1 GHz ~ 25 GHz	Detector Function & Bandwidth	(PK) RB = 1 MHz, VB = 3 MHz (AV) RB = 1 MHz, VB = 3 MHz
Input Power (System)	120 Vac, 60 Hz	Environmental Conditions	28°C, 75% RH
Tested By	Louis Yang		

Antenna Polarity & Test Distance : Horizontal at 3 m								
No	Frequency (MHz)	Emission Level (dBuV/m)	Limit (dBuV/m)	Margin (dB)	Antenna Height (m)	Table Angle (Degree)	Raw Value (dBuV)	Correction Factor (dB/m)
1	*2441.00	96.3 PK			1.84 H	274	101.9	-5.6
2	*2441.00	65.5 AV			1.84 H	274	71.1	-5.6
3	4882.00	36.5 PK	74.0	-37.5	1.78 H	237	36.2	0.3
4	4882.00	5.7 AV	54.0	-48.3	1.78 H	237	5.4	0.3
5	7323.00	40.8 PK	74.0	-33.2	1.00 H	359	33.9	6.9
6	7323.00	10.0 AV	54.0	-44.0	1.00 H	359	3.1	6.9

Remarks:

1. Emission Level(dBuV/m) = Raw Value(dBuV) + Correction Factor(dB/m)
2. Correction Factor(dB/m) = Antenna Factor(dB/m) + Cable Factor(dB) – Pre-Amplifier Factor(dB)
3. Margin value = Emission Level – Limit value
4. The other emission levels were very low against the limit.
5. " * " : Fundamental frequency, the limit was restricted at the RF Output Power.
6. The average value of fundamental and harmonic frequency is: Average = Peak value + 20 log(Duty cycle) Where the duty cycle correction factor is calculated from following formula:
 $20 \log(\text{Duty cycle}) = 20 \log(2.898 \text{ ms} / 100 \text{ ms}) = -30.8 \text{ dB}$

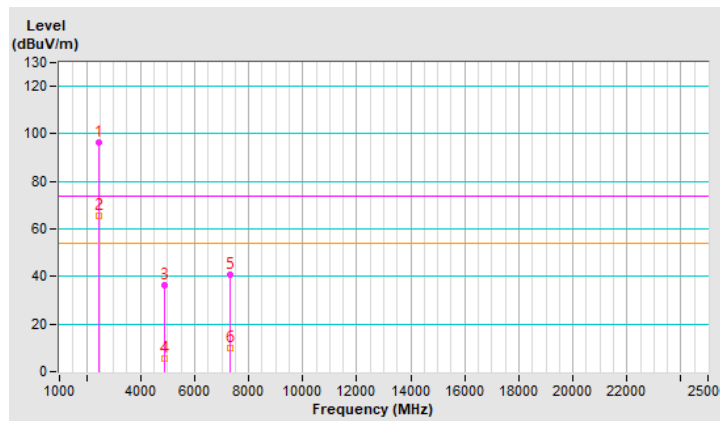

RF Mode	BT 8DPSK	Channel	CH 39 : 2441 MHz
Frequency Range	1 GHz ~ 25 GHz	Detector Function & Bandwidth	(PK) RB = 1 MHz, VB = 3 MHz (AV) RB = 1 MHz, VB = 3 MHz
Input Power (System)	120 Vac, 60 Hz	Environmental Conditions	28°C, 75% RH
Tested By	Louis Yang		

Antenna Polarity & Test Distance : Vertical at 3 m								
No	Frequency (MHz)	Emission Level (dBuV/m)	Limit (dBuV/m)	Margin (dB)	Antenna Height (m)	Table Angle (Degree)	Raw Value (dBuV)	Correction Factor (dB/m)
1	*2441.00	109.3 PK			1.28 V	15	114.9	-5.6
2	*2441.00	78.5 AV			1.28 V	15	84.1	-5.6
3	4882.00	38.1 PK	74.0	-35.9	1.52 V	30	37.8	0.3
4	4882.00	7.3 AV	54.0	-46.7	1.52 V	30	7.0	0.3
5	7323.00	42.2 PK	74.0	-31.8	1.00 V	14	35.3	6.9
6	7323.00	11.4 AV	54.0	-42.6	1.00 V	14	4.5	6.9

Remarks:

1. Emission Level(dBuV/m) = Raw Value(dBuV) + Correction Factor(dB/m)
2. Correction Factor(dB/m) = Antenna Factor(dB/m) + Cable Factor(dB) – Pre-Amplifier Factor(dB)
3. Margin value = Emission Level – Limit value
4. The other emission levels were very low against the limit.
5. " * " : Fundamental frequency, the limit was restricted at the RF Output Power.
6. The average value of fundamental and harmonic frequency is: Average = Peak value + 20 log(Duty cycle) Where the duty cycle correction factor is calculated from following formula:
 $20 \log(\text{Duty cycle}) = 20 \log(2.898 \text{ ms} / 100 \text{ ms}) = -30.8 \text{ dB}$

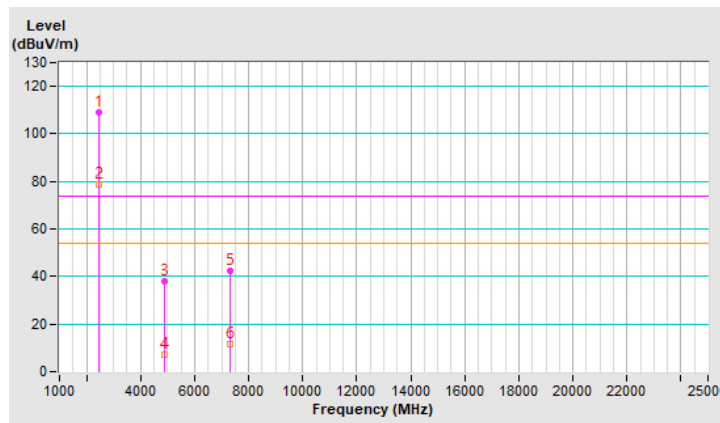

RF Mode	BT 8DPSK	Channel	CH 78 : 2480 MHz
Frequency Range	1 GHz ~ 25 GHz	Detector Function & Bandwidth	(PK) RB = 1 MHz, VB = 3 MHz (AV) RB = 1 MHz, VB = 3 MHz
Input Power (System)	120 Vac, 60 Hz	Environmental Conditions	28°C, 75% RH
Tested By	Louis Yang		

Antenna Polarity & Test Distance : Horizontal at 3 m								
No	Frequency (MHz)	Emission Level (dBuV/m)	Limit (dBuV/m)	Margin (dB)	Antenna Height (m)	Table Angle (Degree)	Raw Value (dBuV)	Correction Factor (dB/m)
1	*2480.00	93.6 PK			2.72 H	271	99.3	-5.7
2	*2480.00	62.8 AV			2.72 H	271	68.5	-5.7
3	2483.50	52.3 PK	74.0	-21.7	2.72 H	271	58.0	-5.7
4	2483.50	42.2 AV	54.0	-11.8	2.72 H	271	47.9	-5.7
5	4960.00	35.8 PK	74.0	-38.2	1.70 H	232	35.3	0.5
6	4960.00	5.0 AV	54.0	-49.0	1.70 H	232	4.5	0.5
7	7440.00	42.4 PK	74.0	-31.6	1.01 H	321	35.0	7.4
8	7440.00	11.6 AV	54.0	-42.4	1.01 H	321	4.2	7.4

Remarks:

1. Emission Level(dBuV/m) = Raw Value(dBuV) + Correction Factor(dB/m)
2. Correction Factor(dB/m) = Antenna Factor(dB/m) + Cable Factor(dB) – Pre-Amplifier Factor(dB)
3. Margin value = Emission Level – Limit value
4. The other emission levels were very low against the limit.
5. " * ": Fundamental frequency, the limit was restricted at the RF Output Power.
6. The average value of fundamental and harmonic frequency is: Average = Peak value + 20 log(Duty cycle) Where the duty cycle correction factor is calculated from following formula:
 $20 \log(\text{Duty cycle}) = 20 \log(2.898 \text{ ms} / 100 \text{ ms}) = -30.8 \text{ dB}$

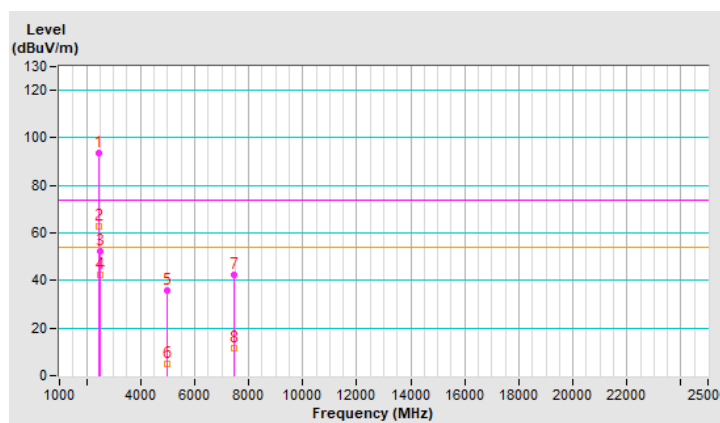

RF Mode	BT 8DPSK	Channel	CH 78 : 2480 MHz
Frequency Range	1 GHz ~ 25 GHz	Detector Function & Bandwidth	(PK) RB = 1 MHz, VB = 3 MHz (AV) RB = 1 MHz, VB = 3 MHz
Input Power (System)	120 Vac, 60 Hz	Environmental Conditions	28°C, 75% RH
Tested By	Louis Yang		

Antenna Polarity & Test Distance : Vertical at 3 m								
No	Frequency (MHz)	Emission Level (dBuV/m)	Limit (dBuV/m)	Margin (dB)	Antenna Height (m)	Table Angle (Degree)	Raw Value (dBuV)	Correction Factor (dB/m)
1	*2480.00	107.1 PK			1.43 V	260	112.8	-5.7
2	*2480.00	76.3 AV			1.43 V	260	82.0	-5.7
3	2483.50	53.8 PK	74.0	-20.2	1.43 V	260	59.5	-5.7
4	2483.50	43.0 AV	54.0	-11.0	1.43 V	260	48.7	-5.7
5	4960.00	37.5 PK	74.0	-36.5	1.54 V	17	37.0	0.5
6	4960.00	6.7 AV	54.0	-47.3	1.54 V	17	6.2	0.5
7	7440.00	42.4 PK	74.0	-31.6	1.04 V	6	35.0	7.4
8	7440.00	11.6 AV	54.0	-42.4	1.04 V	6	4.2	7.4

Remarks:

1. Emission Level(dBuV/m) = Raw Value(dBuV) + Correction Factor(dB/m)
2. Correction Factor(dB/m) = Antenna Factor(dB/m) + Cable Factor(dB) – Pre-Amplifier Factor(dB)
3. Margin value = Emission Level – Limit value
4. The other emission levels were very low against the limit.
5. " * ": Fundamental frequency, the limit was restricted at the RF Output Power.
6. The average value of fundamental and harmonic frequency is: Average = Peak value + 20 log(Duty cycle) Where the duty cycle correction factor is calculated from following formula:
 $20 \log(\text{Duty cycle}) = 20 \log(2.898 \text{ ms} / 100 \text{ ms}) = -30.8 \text{ dB}$

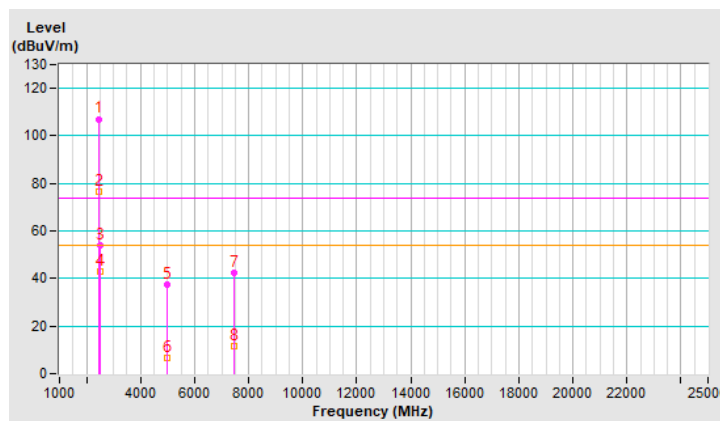

Mode E

RF Mode	BT GFSK	Channel	CH 0 : 2402 MHz
Frequency Range	1 GHz ~ 25 GHz	Detector Function & Bandwidth	(PK) RB = 1 MHz, VB = 3 MHz (AV) RB = 1 MHz, VB = 3 MHz
Input Power (System)	120 Vac, 60 Hz	Environmental Conditions	29°C, 77% RH
Tested By	Louis Yang		

Antenna Polarity & Test Distance : Horizontal at 3 m								
No	Frequency (MHz)	Emission Level (dBuV/m)	Limit (dBuV/m)	Margin (dB)	Antenna Height (m)	Table Angle (Degree)	Raw Value (dBuV)	Correction Factor (dB/m)
1	2390.00	53.6 PK	74.0	-20.4	3.73 H	257	59.3	-5.7
2	2390.00	41.5 AV	54.0	-12.5	3.73 H	257	47.2	-5.7
3	*2402.00	104.5 PK			3.73 H	257	110.2	-5.7
4	*2402.00	73.7 AV			3.73 H	257	79.4	-5.7
5	4804.00	39.4 PK	74.0	-34.6	3.75 H	267	39.1	0.3
6	4804.00	8.6 AV	54.0	-45.4	3.75 H	267	8.3	0.3

Remarks:

1. Emission Level(dBuV/m) = Raw Value(dBuV) + Correction Factor(dB/m)
2. Correction Factor(dB/m) = Antenna Factor(dB/m) + Cable Factor(dB) – Pre-Amplifier Factor(dB)
3. Margin value = Emission Level – Limit value
4. The other emission levels were very low against the limit.
5. " * " : Fundamental frequency, the limit was restricted at the RF Output Power.
6. The average value of fundamental and harmonic frequency is: Average = Peak value + 20 log(Duty cycle) Where the duty cycle correction factor is calculated from following formula:
 $20 \log(\text{Duty cycle}) = 20 \log(2.888 \text{ ms} / 100 \text{ ms}) = -30.8 \text{ dB}$

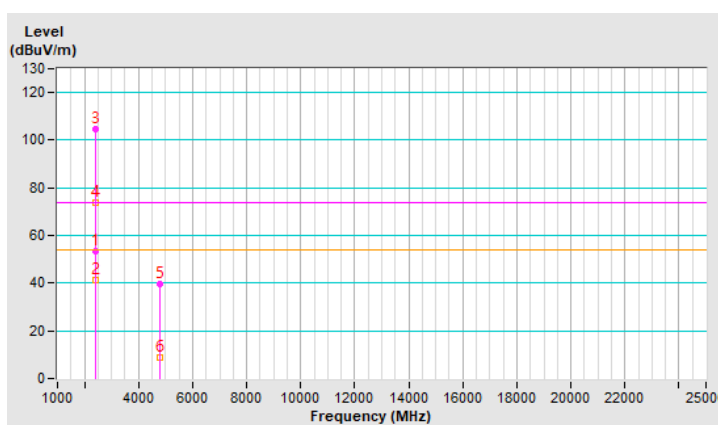

RF Mode	BT GFSK	Channel	CH 0 : 2402 MHz
Frequency Range	1 GHz ~ 25 GHz	Detector Function & Bandwidth	(PK) RB = 1 MHz, VB = 3 MHz (AV) RB = 1 MHz, VB = 3 MHz
Input Power (System)	120 Vac, 60 Hz	Environmental Conditions	29°C, 77% RH
Tested By	Louis Yang		

Antenna Polarity & Test Distance : Vertical at 3 m								
No	Frequency (MHz)	Emission Level (dBuV/m)	Limit (dBuV/m)	Margin (dB)	Antenna Height (m)	Table Angle (Degree)	Raw Value (dBuV)	Correction Factor (dB/m)
1	2390.00	54.5 PK	74.0	-19.5	2.46 V	146	60.2	-5.7
2	2390.00	40.8 AV	54.0	-13.2	2.46 V	146	46.5	-5.7
3	*2402.00	104.4 PK			2.46 V	146	110.1	-5.7
4	*2402.00	73.6 AV			2.46 V	146	79.3	-5.7
5	4804.00	39.3 PK	74.0	-34.7	2.48 V	182	39.0	0.3
6	4804.00	8.5 AV	54.0	-45.5	2.48 V	182	8.2	0.3

Remarks:

1. Emission Level(dBuV/m) = Raw Value(dBuV) + Correction Factor(dB/m)
2. Correction Factor(dB/m) = Antenna Factor(dB/m) + Cable Factor(dB) – Pre-Amplifier Factor(dB)
3. Margin value = Emission Level – Limit value
4. The other emission levels were very low against the limit.
5. " * " : Fundamental frequency, the limit was restricted at the RF Output Power.
6. The average value of fundamental and harmonic frequency is: Average = Peak value + 20 log(Duty cycle) Where the duty cycle correction factor is calculated from following formula:
 $20 \log(\text{Duty cycle}) = 20 \log(2.888 \text{ ms} / 100 \text{ ms}) = -30.8 \text{ dB}$

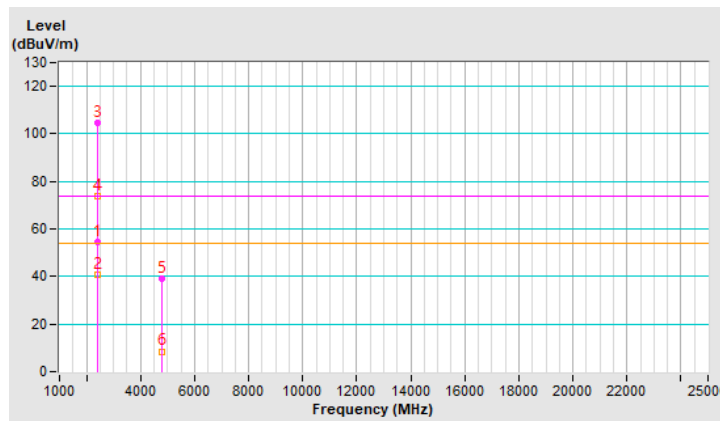

RF Mode	BT GFSK	Channel	CH 39 : 2441 MHz
Frequency Range	1 GHz ~ 25 GHz	Detector Function & Bandwidth	(PK) RB = 1 MHz, VB = 3 MHz (AV) RB = 1 MHz, VB = 3 MHz
Input Power (System)	120 Vac, 60 Hz	Environmental Conditions	29°C, 77% RH
Tested By	Louis Yang		

Antenna Polarity & Test Distance : Horizontal at 3 m								
No	Frequency (MHz)	Emission Level (dBuV/m)	Limit (dBuV/m)	Margin (dB)	Antenna Height (m)	Table Angle (Degree)	Raw Value (dBuV)	Correction Factor (dB/m)
1	*2441.00	105.8 PK			3.71 H	253	111.4	-5.6
2	*2441.00	75.0 AV			3.71 H	253	80.6	-5.6
3	4882.00	40.3 PK	74.0	-33.7	3.61 H	228	40.0	0.3
4	4882.00	9.5 AV	54.0	-44.5	3.61 H	228	9.2	0.3
5	7323.00	49.4 PK	74.0	-24.6	3.49 H	223	42.5	6.9
6	7323.00	18.6 AV	54.0	-35.4	3.49 H	223	11.7	6.9

Remarks:

1. Emission Level(dBuV/m) = Raw Value(dBuV) + Correction Factor(dB/m)
2. Correction Factor(dB/m) = Antenna Factor(dB/m) + Cable Factor(dB) – Pre-Amplifier Factor(dB)
3. Margin value = Emission Level – Limit value
4. The other emission levels were very low against the limit.
5. " * ": Fundamental frequency, the limit was restricted at the RF Output Power.
6. The average value of fundamental and harmonic frequency is: Average = Peak value + 20 log(Duty cycle) Where the duty cycle correction factor is calculated from following formula:
 $20 \log(\text{Duty cycle}) = 20 \log(2.888 \text{ ms} / 100 \text{ ms}) = -30.8 \text{ dB}$

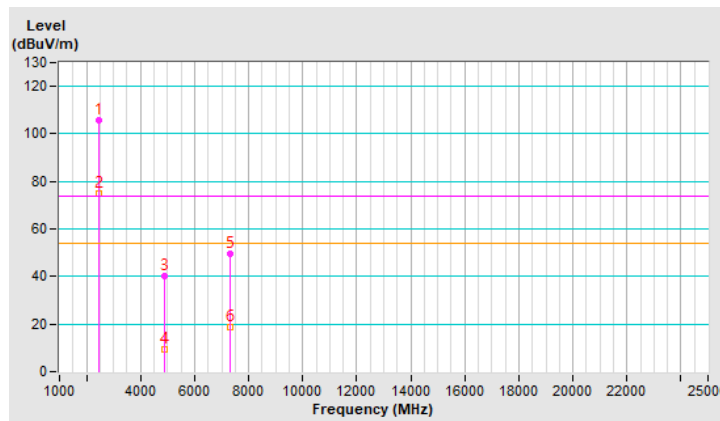

RF Mode	BT GFSK	Channel	CH 39 : 2441 MHz
Frequency Range	1 GHz ~ 25 GHz	Detector Function & Bandwidth	(PK) RB = 1 MHz, VB = 3 MHz (AV) RB = 1 MHz, VB = 3 MHz
Input Power (System)	120 Vac, 60 Hz	Environmental Conditions	29°C, 77% RH
Tested By	Louis Yang		

Antenna Polarity & Test Distance : Vertical at 3 m								
No	Frequency (MHz)	Emission Level (dBuV/m)	Limit (dBuV/m)	Margin (dB)	Antenna Height (m)	Table Angle (Degree)	Raw Value (dBuV)	Correction Factor (dB/m)
1	*2441.00	102.9 PK			2.40 V	176	108.5	-5.6
2	*2441.00	72.1 AV			2.40 V	176	77.7	-5.6
3	4882.00	40.5 PK	74.0	-33.5	2.52 V	139	40.2	0.3
4	4882.00	9.7 AV	54.0	-44.3	2.52 V	139	9.4	0.3
5	7323.00	49.2 PK	74.0	-24.8	2.47 V	139	42.3	6.9
6	7323.00	18.4 AV	54.0	-35.6	2.47 V	139	11.5	6.9

Remarks:

1. Emission Level(dBuV/m) = Raw Value(dBuV) + Correction Factor(dB/m)
2. Correction Factor(dB/m) = Antenna Factor(dB/m) + Cable Factor(dB) – Pre-Amplifier Factor(dB)
3. Margin value = Emission Level – Limit value
4. The other emission levels were very low against the limit.
5. " * " : Fundamental frequency, the limit was restricted at the RF Output Power.
6. The average value of fundamental and harmonic frequency is: Average = Peak value + 20 log(Duty cycle) Where the duty cycle correction factor is calculated from following formula:
 $20 \log(\text{Duty cycle}) = 20 \log(2.888 \text{ ms} / 100 \text{ ms}) = -30.8 \text{ dB}$

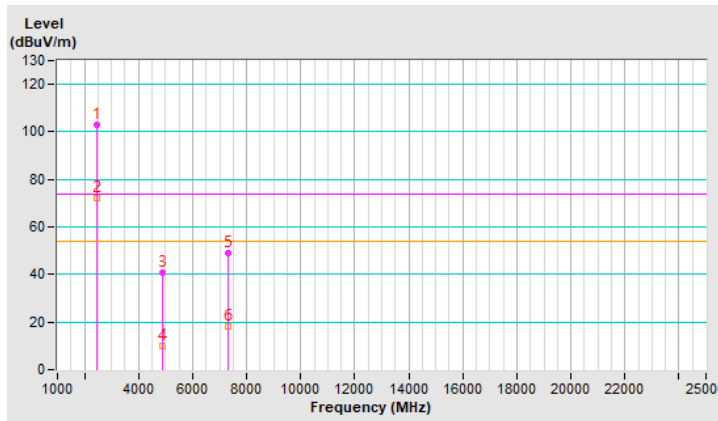

RF Mode	BT GFSK	Channel	CH 78 : 2480 MHz
Frequency Range	1 GHz ~ 25 GHz	Detector Function & Bandwidth	(PK) RB = 1 MHz, VB = 3 MHz (AV) RB = 1 MHz, VB = 3 MHz
Input Power (System)	120 Vac, 60 Hz	Environmental Conditions	29°C, 77% RH
Tested By	Louis Yang		

Antenna Polarity & Test Distance : Horizontal at 3 m								
No	Frequency (MHz)	Emission Level (dBuV/m)	Limit (dBuV/m)	Margin (dB)	Antenna Height (m)	Table Angle (Degree)	Raw Value (dBuV)	Correction Factor (dB/m)
1	*2480.00	105.0 PK			3.44 H	263	110.7	-5.7
2	*2480.00	74.2 AV			3.44 H	263	79.9	-5.7
3	2483.50	53.2 PK	74.0	-20.8	3.44 H	263	58.9	-5.7
4	2483.50	42.5 AV	54.0	-11.5	3.44 H	263	48.2	-5.7
5	4960.00	40.6 PK	74.0	-33.4	3.58 H	233	40.1	0.5
6	4960.00	9.8 AV	54.0	-44.2	3.58 H	233	9.3	0.5
7	7440.00	50.0 PK	74.0	-24.0	3.67 H	243	42.6	7.4
8	7440.00	19.2 AV	54.0	-34.8	3.67 H	243	11.8	7.4

Remarks:

1. Emission Level(dBuV/m) = Raw Value(dBuV) + Correction Factor(dB/m)
2. Correction Factor(dB/m) = Antenna Factor(dB/m) + Cable Factor(dB) – Pre-Amplifier Factor(dB)
3. Margin value = Emission Level – Limit value
4. The other emission levels were very low against the limit.
5. " * ": Fundamental frequency, the limit was restricted at the RF Output Power.
6. The average value of fundamental and harmonic frequency is: Average = Peak value + 20 log(Duty cycle) Where the duty cycle correction factor is calculated from following formula:
 $20 \log(\text{Duty cycle}) = 20 \log(2.888 \text{ ms} / 100 \text{ ms}) = -30.8 \text{ dB}$

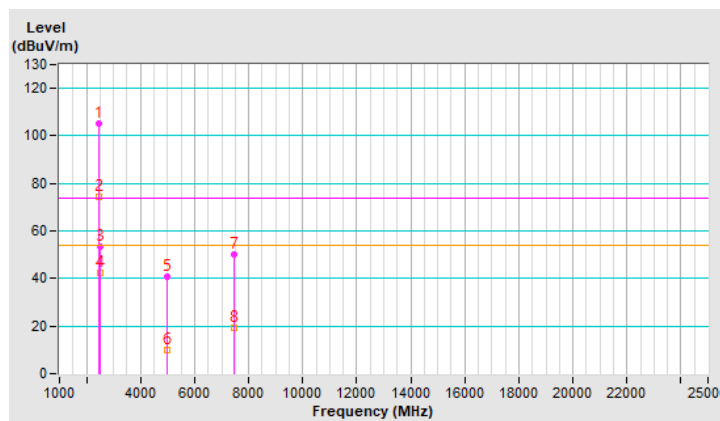

RF Mode	BT GFSK	Channel	CH 78 : 2480 MHz
Frequency Range	1 GHz ~ 25 GHz	Detector Function & Bandwidth	(PK) RB = 1 MHz, VB = 3 MHz (AV) RB = 1 MHz, VB = 3 MHz
Input Power (System)	120 Vac, 60 Hz	Environmental Conditions	29°C, 77% RH
Tested By	Louis Yang		

Antenna Polarity & Test Distance : Vertical at 3 m								
No	Frequency (MHz)	Emission Level (dBuV/m)	Limit (dBuV/m)	Margin (dB)	Antenna Height (m)	Table Angle (Degree)	Raw Value (dBuV)	Correction Factor (dB/m)
1	*2480.00	103.8 PK			2.25 V	139	109.5	-5.7
2	*2480.00	73.0 AV			2.25 V	139	78.7	-5.7
3	2483.50	53.7 PK	74.0	-20.3	2.25 V	139	59.4	-5.7
4	2483.50	42.1 AV	54.0	-11.9	2.25 V	139	47.8	-5.7
5	4960.00	40.6 PK	74.0	-33.4	2.29 V	173	40.1	0.5
6	4960.00	9.8 AV	54.0	-44.2	2.29 V	173	9.3	0.5
7	7440.00	48.5 PK	74.0	-25.5	2.06 V	160	41.1	7.4
8	7440.00	17.7 AV	54.0	-36.3	2.06 V	160	10.3	7.4

Remarks:

1. Emission Level(dBuV/m) = Raw Value(dBuV) + Correction Factor(dB/m)
2. Correction Factor(dB/m) = Antenna Factor(dB/m) + Cable Factor(dB) – Pre-Amplifier Factor(dB)
3. Margin value = Emission Level – Limit value
4. The other emission levels were very low against the limit.
5. " * ": Fundamental frequency, the limit was restricted at the RF Output Power.
6. The average value of fundamental and harmonic frequency is: Average = Peak value + 20 log(Duty cycle) Where the duty cycle correction factor is calculated from following formula:
 $20 \log(\text{Duty cycle}) = 20 \log(2.888 \text{ ms} / 100 \text{ ms}) = -30.8 \text{ dB}$

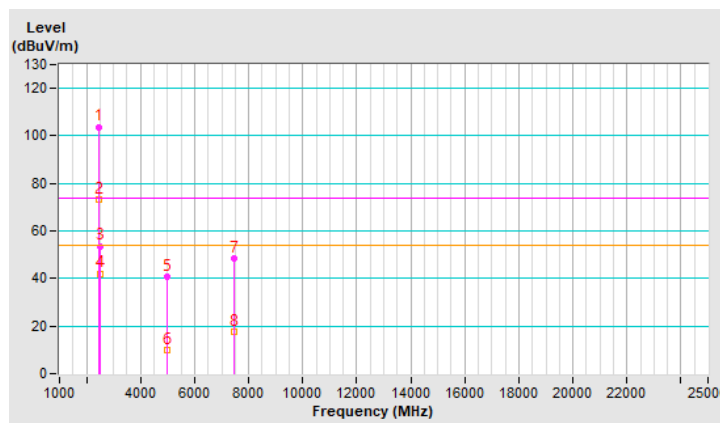

RF Mode	BT 8DPSK	Channel	CH 0 : 2402 MHz
Frequency Range	1 GHz ~ 25 GHz	Detector Function & Bandwidth	(PK) RB = 1 MHz, VB = 3 MHz (AV) RB = 1 MHz, VB = 3 MHz
Input Power (System)	120 Vac, 60 Hz	Environmental Conditions	29°C, 77% RH
Tested By	Louis Yang		

Antenna Polarity & Test Distance : Horizontal at 3 m								
No	Frequency (MHz)	Emission Level (dBuV/m)	Limit (dBuV/m)	Margin (dB)	Antenna Height (m)	Table Angle (Degree)	Raw Value (dBuV)	Correction Factor (dB/m)
1	2390.00	53.5 PK	74.0	-20.5	3.79 H	252	59.2	-5.7
2	2390.00	42.3 AV	54.0	-11.7	3.79 H	252	48.0	-5.7
3	*2402.00	105.1 PK			3.67 H	264	110.8	-5.7
4	*2402.00	74.3 AV			3.67 H	264	80.0	-5.7
5	4804.00	39.7 PK	74.0	-34.3	3.66 H	260	39.4	0.3
6	4804.00	8.9 AV	54.0	-45.1	3.66 H	260	8.6	0.3

Remarks:

1. Emission Level(dBuV/m) = Raw Value(dBuV) + Correction Factor(dB/m)
2. Correction Factor(dB/m) = Antenna Factor(dB/m) + Cable Factor(dB) – Pre-Amplifier Factor(dB)
3. Margin value = Emission Level – Limit value
4. The other emission levels were very low against the limit.
5. " * " : Fundamental frequency, the limit was restricted at the RF Output Power.
6. The average value of fundamental and harmonic frequency is: Average = Peak value + 20 log(Duty cycle) Where the duty cycle correction factor is calculated from following formula:
 $20 \log(\text{Duty cycle}) = 20 \log(2.898 \text{ ms} / 100 \text{ ms}) = -30.8 \text{ dB}$

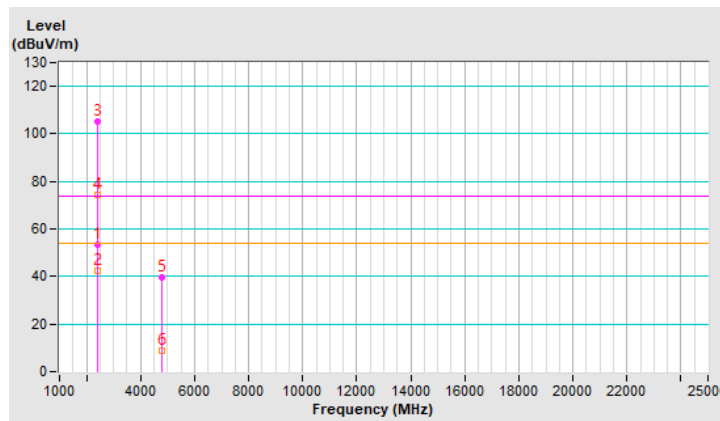

RF Mode	BT 8DPSK	Channel	CH 0 : 2402 MHz
Frequency Range	1 GHz ~ 25 GHz	Detector Function & Bandwidth	(PK) RB = 1 MHz, VB = 3 MHz (AV) RB = 1 MHz, VB = 3 MHz
Input Power (System)	120 Vac, 60 Hz	Environmental Conditions	29°C, 77% RH
Tested By	Louis Yang		

Antenna Polarity & Test Distance : Vertical at 3 m								
No	Frequency (MHz)	Emission Level (dBuV/m)	Limit (dBuV/m)	Margin (dB)	Antenna Height (m)	Table Angle (Degree)	Raw Value (dBuV)	Correction Factor (dB/m)
1	2390.00	51.6 PK	74.0	-22.4	2.65 V	167	57.3	-5.7
2	2390.00	40.6 AV	54.0	-13.4	2.65 V	167	46.3	-5.7
3	*2402.00	102.8 PK			2.59 V	135	108.5	-5.7
4	*2402.00	72.0 AV			2.59 V	135	77.7	-5.7
5	4804.00	41.3 PK	74.0	-32.7	2.73 V	153	41.0	0.3
6	4804.00	10.5 AV	54.0	-43.5	2.73 V	153	10.2	0.3

Remarks:

- Emission Level(dBuV/m) = Raw Value(dBuV) + Correction Factor(dB/m)
- Correction Factor(dB/m) = Antenna Factor(dB/m) + Cable Factor(dB) – Pre-Amplifier Factor(dB)
- Margin value = Emission Level – Limit value
- The other emission levels were very low against the limit.
- " * " : Fundamental frequency, the limit was restricted at the RF Output Power.
- The average value of fundamental and harmonic frequency is: Average = Peak value + 20 log(Duty cycle) Where the duty cycle correction factor is calculated from following formula:
 $20 \log(\text{Duty cycle}) = 20 \log(2.898 \text{ ms} / 100 \text{ ms}) = -30.8 \text{ dB}$

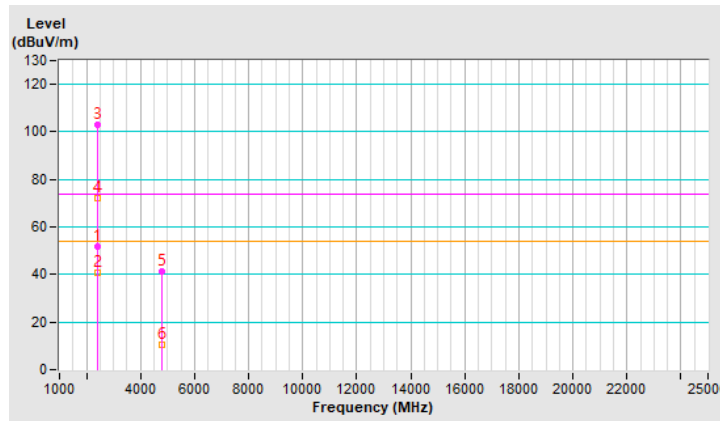

RF Mode	BT 8DPSK	Channel	CH 39 : 2441 MHz
Frequency Range	1 GHz ~ 25 GHz	Detector Function & Bandwidth	(PK) RB = 1 MHz, VB = 3 MHz (AV) RB = 1 MHz, VB = 3 MHz
Input Power (System)	120 Vac, 60 Hz	Environmental Conditions	29°C, 77% RH
Tested By	Louis Yang		

Antenna Polarity & Test Distance : Horizontal at 3 m								
No	Frequency (MHz)	Emission Level (dBuV/m)	Limit (dBuV/m)	Margin (dB)	Antenna Height (m)	Table Angle (Degree)	Raw Value (dBuV)	Correction Factor (dB/m)
1	*2441.00	103.7 PK			3.77 H	225	109.3	-5.6
2	*2441.00	72.9 AV			3.77 H	225	78.5	-5.6
3	4882.00	40.7 PK	74.0	-33.3	3.64 H	237	40.4	0.3
4	4882.00	9.9 AV	54.0	-44.1	3.64 H	237	9.6	0.3
5	7323.00	49.8 PK	74.0	-24.2	3.50 H	250	42.9	6.9
6	7323.00	19.0 AV	54.0	-35.0	3.50 H	250	12.1	6.9

Remarks:

1. Emission Level(dBuV/m) = Raw Value(dBuV) + Correction Factor(dB/m)
2. Correction Factor(dB/m) = Antenna Factor(dB/m) + Cable Factor(dB) – Pre-Amplifier Factor(dB)
3. Margin value = Emission Level – Limit value
4. The other emission levels were very low against the limit.
5. " * " : Fundamental frequency, the limit was restricted at the RF Output Power.
6. The average value of fundamental and harmonic frequency is: Average = Peak value + 20 log(Duty cycle) Where the duty cycle correction factor is calculated from following formula:
 $20 \log(\text{Duty cycle}) = 20 \log(2.898 \text{ ms} / 100 \text{ ms}) = -30.8 \text{ dB}$

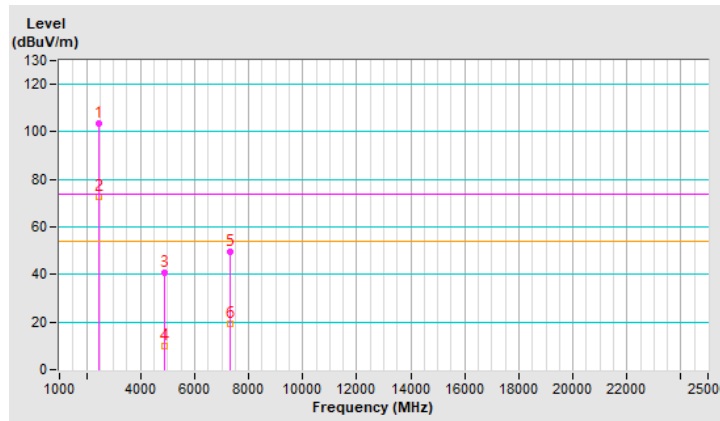

RF Mode	BT 8DPSK	Channel	CH 39 : 2441 MHz
Frequency Range	1 GHz ~ 25 GHz	Detector Function & Bandwidth	(PK) RB = 1 MHz, VB = 3 MHz (AV) RB = 1 MHz, VB = 3 MHz
Input Power (System)	120 Vac, 60 Hz	Environmental Conditions	29°C, 77% RH
Tested By	Louis Yang		

Antenna Polarity & Test Distance : Vertical at 3 m								
No	Frequency (MHz)	Emission Level (dBuV/m)	Limit (dBuV/m)	Margin (dB)	Antenna Height (m)	Table Angle (Degree)	Raw Value (dBuV)	Correction Factor (dB/m)
1	*2441.00	102.6 PK			2.47 V	162	108.2	-5.6
2	*2441.00	71.8 AV			2.47 V	162	77.4	-5.6
3	4882.00	39.6 PK	74.0	-34.4	2.55 V	153	39.3	0.3
4	4882.00	8.8 AV	54.0	-45.2	2.55 V	153	8.5	0.3
5	7323.00	49.4 PK	74.0	-24.6	2.65 V	206	42.5	6.9
6	7323.00	18.6 AV	54.0	-35.4	2.65 V	206	11.7	6.9

Remarks:

1. Emission Level(dBuV/m) = Raw Value(dBuV) + Correction Factor(dB/m)
2. Correction Factor(dB/m) = Antenna Factor(dB/m) + Cable Factor(dB) – Pre-Amplifier Factor(dB)
3. Margin value = Emission Level – Limit value
4. The other emission levels were very low against the limit.
5. " * " : Fundamental frequency, the limit was restricted at the RF Output Power.
6. The average value of fundamental and harmonic frequency is: Average = Peak value + 20 log(Duty cycle) Where the duty cycle correction factor is calculated from following formula:
 $20 \log(\text{Duty cycle}) = 20 \log(2.898 \text{ ms} / 100 \text{ ms}) = -30.8 \text{ dB}$

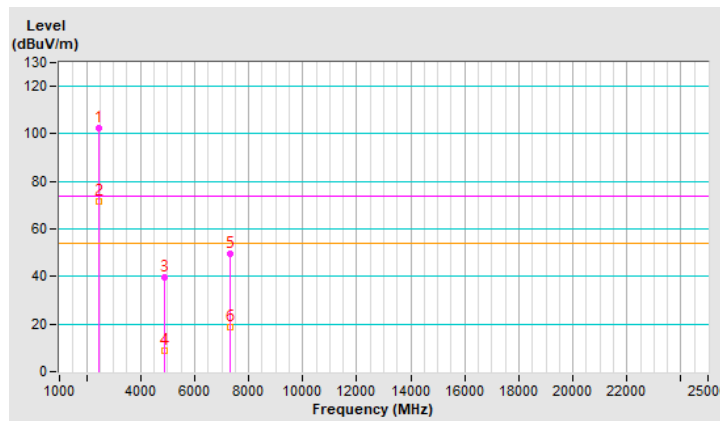

RF Mode	BT 8DPSK	Channel	CH 78 : 2480 MHz
Frequency Range	1 GHz ~ 25 GHz	Detector Function & Bandwidth	(PK) RB = 1 MHz, VB = 3 MHz (AV) RB = 1 MHz, VB = 3 MHz
Input Power (System)	120 Vac, 60 Hz	Environmental Conditions	29°C, 77% RH
Tested By	Louis Yang		

Antenna Polarity & Test Distance : Horizontal at 3 m								
No	Frequency (MHz)	Emission Level (dBuV/m)	Limit (dBuV/m)	Margin (dB)	Antenna Height (m)	Table Angle (Degree)	Raw Value (dBuV)	Correction Factor (dB/m)
1	*2480.00	105.1 PK			3.41 H	265	110.8	-5.7
2	*2480.00	74.3 AV			3.41 H	265	80.0	-5.7
3	2483.50	52.9 PK	74.0	-21.1	3.41 H	265	58.6	-5.7
4	2483.50	42.1 AV	54.0	-11.9	3.41 H	265	47.8	-5.7
5	4960.00	40.6 PK	74.0	-33.4	3.43 H	246	40.1	0.5
6	4960.00	9.8 AV	54.0	-44.2	3.43 H	246	9.3	0.5
7	7440.00	49.7 PK	74.0	-24.3	3.51 H	273	42.3	7.4
8	7440.00	18.9 AV	54.0	-35.1	3.51 H	273	11.5	7.4

Remarks:

1. Emission Level(dBuV/m) = Raw Value(dBuV) + Correction Factor(dB/m)
2. Correction Factor(dB/m) = Antenna Factor(dB/m) + Cable Factor(dB) – Pre-Amplifier Factor(dB)
3. Margin value = Emission Level – Limit value
4. The other emission levels were very low against the limit.
5. " * ": Fundamental frequency, the limit was restricted at the RF Output Power.
6. The average value of fundamental and harmonic frequency is: Average = Peak value + 20 log(Duty cycle) Where the duty cycle correction factor is calculated from following formula:
 $20 \log(\text{Duty cycle}) = 20 \log(2.898 \text{ ms} / 100 \text{ ms}) = -30.8 \text{ dB}$

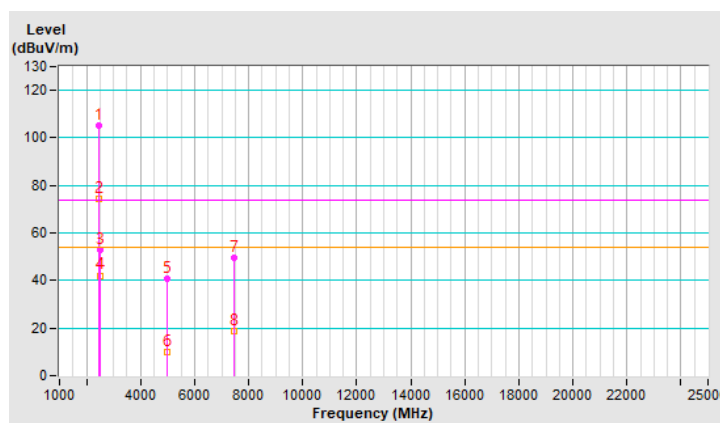

RF Mode	BT 8DPSK	Channel	CH 78 : 2480 MHz
Frequency Range	1 GHz ~ 25 GHz	Detector Function & Bandwidth	(PK) RB = 1 MHz, VB = 3 MHz (AV) RB = 1 MHz, VB = 3 MHz
Input Power (System)	120 Vac, 60 Hz	Environmental Conditions	29°C, 77% RH
Tested By	Louis Yang		

Antenna Polarity & Test Distance : Vertical at 3 m								
No	Frequency (MHz)	Emission Level (dBuV/m)	Limit (dBuV/m)	Margin (dB)	Antenna Height (m)	Table Angle (Degree)	Raw Value (dBuV)	Correction Factor (dB/m)
1	*2480.00	103.2 PK			2.42 V	163	108.9	-5.7
2	*2480.00	72.4 AV			2.42 V	163	78.1	-5.7
3	2483.50	52.4 PK	74.0	-21.6	2.42 V	163	58.1	-5.7
4	2483.50	40.5 AV	54.0	-13.5	2.42 V	163	46.2	-5.7
5	4960.00	40.3 PK	74.0	-33.7	2.47 V	181	39.8	0.5
6	4960.00	9.5 AV	54.0	-44.5	2.47 V	181	9.0	0.5
7	7440.00	49.0 PK	74.0	-25.0	2.35 V	157	41.6	7.4
8	7440.00	18.2 AV	54.0	-35.8	2.35 V	157	10.8	7.4

Remarks:

1. Emission Level(dBuV/m) = Raw Value(dBuV) + Correction Factor(dB/m)
2. Correction Factor(dB/m) = Antenna Factor(dB/m) + Cable Factor(dB) – Pre-Amplifier Factor(dB)
3. Margin value = Emission Level – Limit value
4. The other emission levels were very low against the limit.
5. " * ": Fundamental frequency, the limit was restricted at the RF Output Power.
6. The average value of fundamental and harmonic frequency is: Average = Peak value + 20 log(Duty cycle) Where the duty cycle correction factor is calculated from following formula:
 $20 \log(\text{Duty cycle}) = 20 \log(2.898 \text{ ms} / 100 \text{ ms}) = -30.8 \text{ dB}$

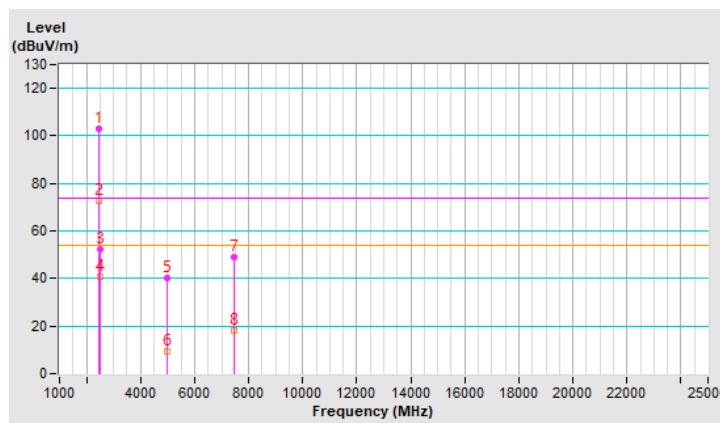

Mode F

RF Mode	BT GFSK	Channel	CH 0 : 2402 MHz
Frequency Range	1 GHz ~ 25 GHz	Detector Function & Bandwidth	(PK) RB = 1 MHz, VB = 3 MHz (AV) RB = 1 MHz, VB = 3 MHz
Input Power (System)	120 Vac, 60 Hz	Environmental Conditions	30°C, 77% RH
Tested By	Louis Yang		

Antenna Polarity & Test Distance : Horizontal at 3 m								
No	Frequency (MHz)	Emission Level (dBuV/m)	Limit (dBuV/m)	Margin (dB)	Antenna Height (m)	Table Angle (Degree)	Raw Value (dBuV)	Correction Factor (dB/m)
1	2390.00	54.2 PK	74.0	-19.8	1.12 H	224	59.9	-5.7
2	2390.00	42.5 AV	54.0	-11.5	1.12 H	224	48.2	-5.7
3	*2402.00	105.6 PK			1.12 H	224	111.3	-5.7
4	*2402.00	74.8 AV			1.12 H	224	80.5	-5.7
5	4804.00	46.4 PK	74.0	-27.6	1.13 H	198	46.1	0.3
6	4804.00	15.6 AV	54.0	-38.4	1.13 H	198	15.3	0.3

Remarks:

1. Emission Level(dBuV/m) = Raw Value(dBuV) + Correction Factor(dB/m)
2. Correction Factor(dB/m) = Antenna Factor(dB/m) + Cable Factor(dB) – Pre-Amplifier Factor(dB)
3. Margin value = Emission Level – Limit value
4. The other emission levels were very low against the limit.
5. " * " : Fundamental frequency, the limit was restricted at the RF Output Power.
6. The average value of fundamental and harmonic frequency is: Average = Peak value + 20 log(Duty cycle) Where the duty cycle correction factor is calculated from following formula:
 $20 \log(\text{Duty cycle}) = 20 \log(2.888 \text{ ms} / 100 \text{ ms}) = -30.8 \text{ dB}$

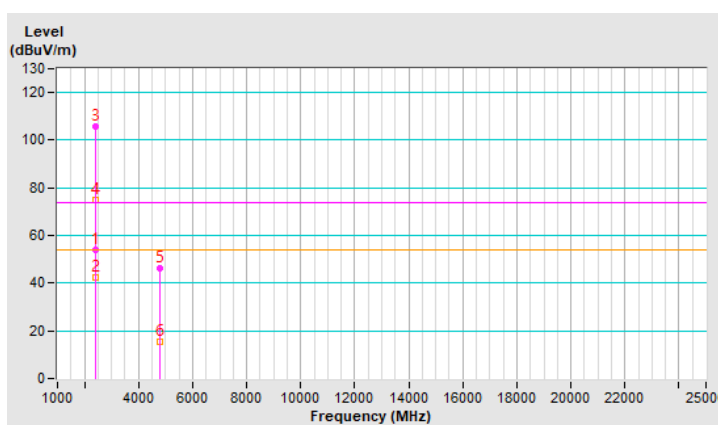

RF Mode	BT GFSK	Channel	CH 0 : 2402 MHz
Frequency Range	1 GHz ~ 25 GHz	Detector Function & Bandwidth	(PK) RB = 1 MHz, VB = 3 MHz (AV) RB = 1 MHz, VB = 3 MHz
Input Power (System)	120 Vac, 60 Hz	Environmental Conditions	30°C, 77% RH
Tested By	Louis Yang		

Antenna Polarity & Test Distance : Vertical at 3 m								
No	Frequency (MHz)	Emission Level (dBuV/m)	Limit (dBuV/m)	Margin (dB)	Antenna Height (m)	Table Angle (Degree)	Raw Value (dBuV)	Correction Factor (dB/m)
1	2390.00	52.3 PK	74.0	-21.7	1.50 V	118	58.0	-5.7
2	2390.00	40.4 AV	54.0	-13.6	1.50 V	118	46.1	-5.7
3	*2402.00	98.4 PK			1.50 V	118	104.1	-5.7
4	*2402.00	67.6 AV			1.50 V	118	73.3	-5.7
5	4804.00	44.3 PK	74.0	-29.7	1.40 V	257	44.0	0.3
6	4804.00	13.5 AV	54.0	-40.5	1.40 V	257	13.2	0.3

Remarks:

1. Emission Level(dBuV/m) = Raw Value(dBuV) + Correction Factor(dB/m)
2. Correction Factor(dB/m) = Antenna Factor(dB/m) + Cable Factor(dB) – Pre-Amplifier Factor(dB)
3. Margin value = Emission Level – Limit value
4. The other emission levels were very low against the limit.
5. " * " : Fundamental frequency, the limit was restricted at the RF Output Power.
6. The average value of fundamental and harmonic frequency is: Average = Peak value + 20 log(Duty cycle) Where the duty cycle correction factor is calculated from following formula:
 $20 \log(\text{Duty cycle}) = 20 \log(2.888 \text{ ms} / 100 \text{ ms}) = -30.8 \text{ dB}$

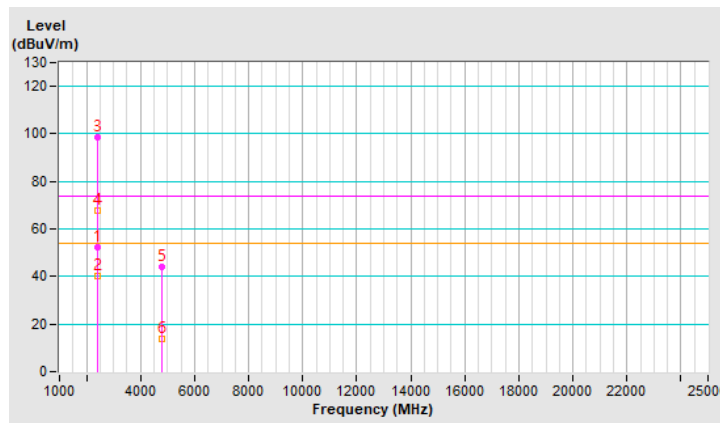

RF Mode	BT GFSK	Channel	CH 39 : 2441 MHz
Frequency Range	1 GHz ~ 25 GHz	Detector Function & Bandwidth	(PK) RB = 1 MHz, VB = 3 MHz (AV) RB = 1 MHz, VB = 3 MHz
Input Power (System)	120 Vac, 60 Hz	Environmental Conditions	30°C, 77% RH
Tested By	Louis Yang		

Antenna Polarity & Test Distance : Horizontal at 3 m								
No	Frequency (MHz)	Emission Level (dBuV/m)	Limit (dBuV/m)	Margin (dB)	Antenna Height (m)	Table Angle (Degree)	Raw Value (dBuV)	Correction Factor (dB/m)
1	*2441.00	106.0 PK			1.14 H	207	111.6	-5.6
2	*2441.00	75.2 AV			1.14 H	207	80.8	-5.6
3	4882.00	45.5 PK	74.0	-28.5	2.31 H	236	45.2	0.3
4	4882.00	14.7 AV	54.0	-39.3	2.31 H	236	14.4	0.3
5	7323.00	42.3 PK	74.0	-31.7	1.52 H	129	35.4	6.9
6	7323.00	11.5 AV	54.0	-42.5	1.52 H	129	4.6	6.9

Remarks:

1. Emission Level(dBuV/m) = Raw Value(dBuV) + Correction Factor(dB/m)
2. Correction Factor(dB/m) = Antenna Factor(dB/m) + Cable Factor(dB) – Pre-Amplifier Factor(dB)
3. Margin value = Emission Level – Limit value
4. The other emission levels were very low against the limit.
5. " * " : Fundamental frequency, the limit was restricted at the RF Output Power.
6. The average value of fundamental and harmonic frequency is: Average = Peak value + 20 log(Duty cycle) Where the duty cycle correction factor is calculated from following formula:
 $20 \log(\text{Duty cycle}) = 20 \log(2.888 \text{ ms} / 100 \text{ ms}) = -30.8 \text{ dB}$

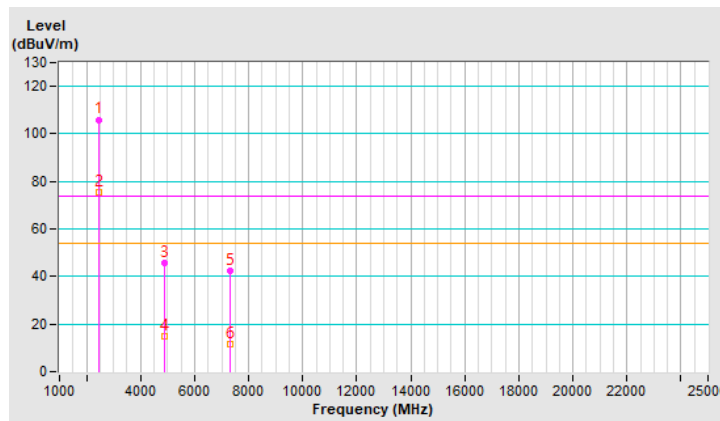

RF Mode	BT GFSK	Channel	CH 39 : 2441 MHz
Frequency Range	1 GHz ~ 25 GHz	Detector Function & Bandwidth	(PK) RB = 1 MHz, VB = 3 MHz (AV) RB = 1 MHz, VB = 3 MHz
Input Power (System)	120 Vac, 60 Hz	Environmental Conditions	30°C, 77% RH
Tested By	Louis Yang		

Antenna Polarity & Test Distance : Vertical at 3 m								
No	Frequency (MHz)	Emission Level (dBuV/m)	Limit (dBuV/m)	Margin (dB)	Antenna Height (m)	Table Angle (Degree)	Raw Value (dBuV)	Correction Factor (dB/m)
1	*2441.00	101.3 PK			1.92 V	141	106.9	-5.6
2	*2441.00	70.5 AV			1.92 V	141	76.1	-5.6
3	4882.00	50.4 PK	74.0	-23.6	2.47 V	223	50.1	0.3
4	4882.00	19.6 AV	54.0	-34.4	2.47 V	223	19.3	0.3
5	7323.00	42.9 PK	74.0	-31.1	1.53 V	133	36.0	6.9
6	7323.00	12.1 AV	54.0	-41.9	1.53 V	133	5.2	6.9

Remarks:

1. Emission Level(dBuV/m) = Raw Value(dBuV) + Correction Factor(dB/m)
2. Correction Factor(dB/m) = Antenna Factor(dB/m) + Cable Factor(dB) – Pre-Amplifier Factor(dB)
3. Margin value = Emission Level – Limit value
4. The other emission levels were very low against the limit.
5. " * " : Fundamental frequency, the limit was restricted at the RF Output Power.
6. The average value of fundamental and harmonic frequency is: Average = Peak value + 20 log(Duty cycle) Where the duty cycle correction factor is calculated from following formula:
 $20 \log(\text{Duty cycle}) = 20 \log(2.888 \text{ ms} / 100 \text{ ms}) = -30.8 \text{ dB}$

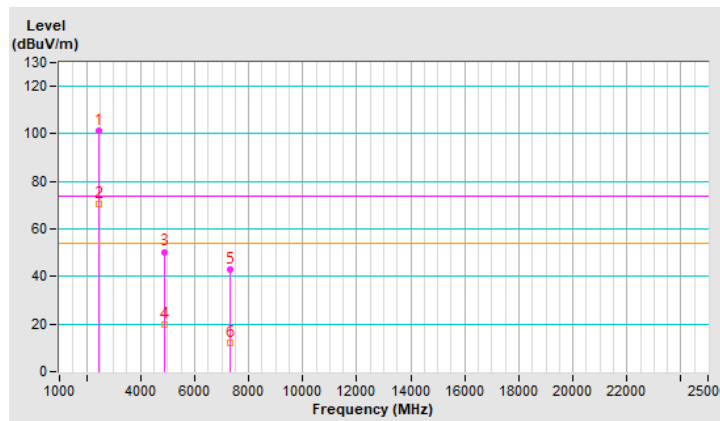

RF Mode	BT GFSK	Channel	CH 78 : 2480 MHz
Frequency Range	1 GHz ~ 25 GHz	Detector Function & Bandwidth	(PK) RB = 1 MHz, VB = 3 MHz (AV) RB = 1 MHz, VB = 3 MHz
Input Power (System)	120 Vac, 60 Hz	Environmental Conditions	30°C, 77% RH
Tested By	Louis Yang		

Antenna Polarity & Test Distance : Horizontal at 3 m								
No	Frequency (MHz)	Emission Level (dBuV/m)	Limit (dBuV/m)	Margin (dB)	Antenna Height (m)	Table Angle (Degree)	Raw Value (dBuV)	Correction Factor (dB/m)
1	*2480.00	106.7 PK			1.16 H	188	112.4	-5.7
2	*2480.00	75.9 AV			1.16 H	188	81.6	-5.7
3	2483.50	61.2 PK	74.0	-12.8	1.16 H	188	66.9	-5.7
4	2483.50	46.1 AV	54.0	-7.9	1.16 H	188	51.8	-5.7
5	4960.00	46.8 PK	74.0	-27.2	2.30 H	231	46.3	0.5
6	4960.00	16.0 AV	54.0	-38.0	2.30 H	231	15.5	0.5
7	7440.00	41.5 PK	74.0	-32.5	1.51 H	131	34.1	7.4
8	7440.00	10.7 AV	54.0	-43.3	1.51 H	131	3.3	7.4

Remarks:

1. Emission Level(dBuV/m) = Raw Value(dBuV) + Correction Factor(dB/m)
2. Correction Factor(dB/m) = Antenna Factor(dB/m) + Cable Factor(dB) – Pre-Amplifier Factor(dB)
3. Margin value = Emission Level – Limit value
4. The other emission levels were very low against the limit.
5. " * ": Fundamental frequency, the limit was restricted at the RF Output Power.
6. The average value of fundamental and harmonic frequency is: Average = Peak value + 20 log(Duty cycle) Where the duty cycle correction factor is calculated from following formula:
 $20 \log(\text{Duty cycle}) = 20 \log(2.888 \text{ ms} / 100 \text{ ms}) = -30.8 \text{ dB}$

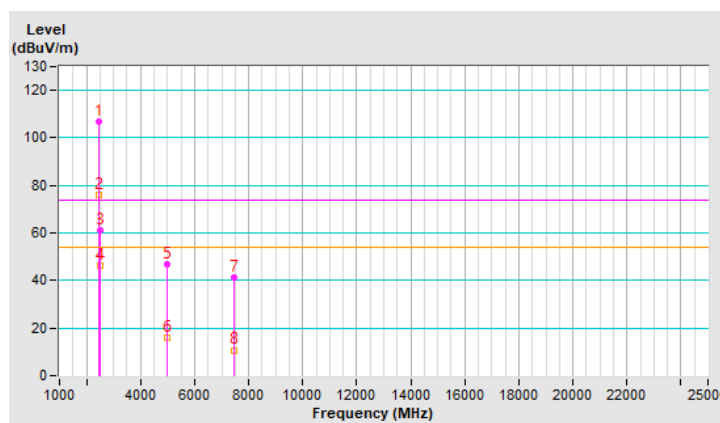

RF Mode	BT GFSK	Channel	CH 78 : 2480 MHz
Frequency Range	1 GHz ~ 25 GHz	Detector Function & Bandwidth	(PK) RB = 1 MHz, VB = 3 MHz (AV) RB = 1 MHz, VB = 3 MHz
Input Power (System)	120 Vac, 60 Hz	Environmental Conditions	30°C, 77% RH
Tested By	Louis Yang		

Antenna Polarity & Test Distance : Vertical at 3 m								
No	Frequency (MHz)	Emission Level (dBuV/m)	Limit (dBuV/m)	Margin (dB)	Antenna Height (m)	Table Angle (Degree)	Raw Value (dBuV)	Correction Factor (dB/m)
1	*2480.00	100.1 PK			1.70 V	74	105.8	-5.7
2	*2480.00	69.3 AV			1.70 V	74	75.0	-5.7
3	2483.50	61.3 PK	74.0	-12.7	1.70 V	74	67.0	-5.7
4	2483.50	47.1 AV	54.0	-6.9	1.70 V	74	52.8	-5.7
5	4960.00	50.0 PK	74.0	-24.0	2.51 V	234	49.5	0.5
6	4960.00	19.2 AV	54.0	-34.8	2.51 V	234	18.7	0.5
7	7440.00	41.8 PK	74.0	-32.2	1.71 V	116	34.4	7.4
8	7440.00	11.0 AV	54.0	-43.0	1.71 V	116	3.6	7.4

Remarks:

1. Emission Level(dBuV/m) = Raw Value(dBuV) + Correction Factor(dB/m)
2. Correction Factor(dB/m) = Antenna Factor(dB/m) + Cable Factor(dB) – Pre-Amplifier Factor(dB)
3. Margin value = Emission Level – Limit value
4. The other emission levels were very low against the limit.
5. " * ": Fundamental frequency, the limit was restricted at the RF Output Power.
6. The average value of fundamental and harmonic frequency is: Average = Peak value + 20 log(Duty cycle) Where the duty cycle correction factor is calculated from following formula:
 $20 \log(\text{Duty cycle}) = 20 \log(2.888 \text{ ms} / 100 \text{ ms}) = -30.8 \text{ dB}$

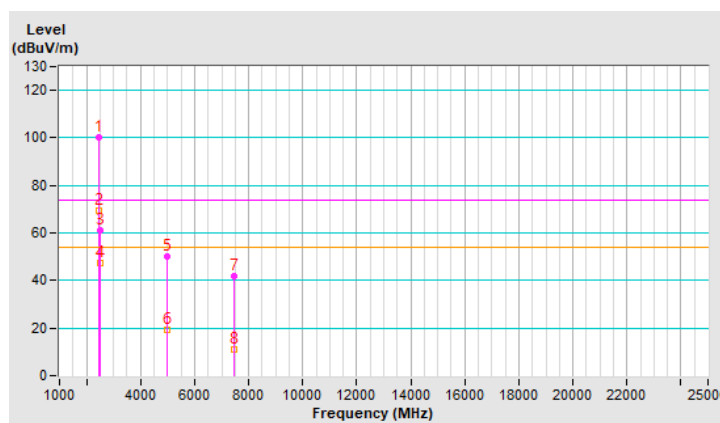

RF Mode	BT 8DPSK	Channel	CH 0 : 2402 MHz
Frequency Range	1 GHz ~ 25 GHz	Detector Function & Bandwidth	(PK) RB = 1 MHz, VB = 3 MHz (AV) RB = 1 MHz, VB = 3 MHz
Input Power (System)	120 Vac, 60 Hz	Environmental Conditions	30°C, 77% RH
Tested By	Louis Yang		

Antenna Polarity & Test Distance : Horizontal at 3 m								
No	Frequency (MHz)	Emission Level (dBuV/m)	Limit (dBuV/m)	Margin (dB)	Antenna Height (m)	Table Angle (Degree)	Raw Value (dBuV)	Correction Factor (dB/m)
1	2390.00	53.0 PK	74.0	-21.0	1.19 H	184	58.7	-5.7
2	2390.00	41.9 AV	54.0	-12.1	1.19 H	184	47.6	-5.7
3	*2402.00	107.0 PK			1.19 H	184	112.7	-5.7
4	*2402.00	76.2 AV			1.19 H	184	81.9	-5.7
5	4804.00	45.7 PK	74.0	-28.3	1.11 H	173	45.4	0.3
6	4804.00	14.9 AV	54.0	-39.1	1.11 H	173	14.6	0.3

Remarks:

1. Emission Level(dBuV/m) = Raw Value(dBuV) + Correction Factor(dB/m)
2. Correction Factor(dB/m) = Antenna Factor(dB/m) + Cable Factor(dB) – Pre-Amplifier Factor(dB)
3. Margin value = Emission Level – Limit value
4. The other emission levels were very low against the limit.
5. " * " : Fundamental frequency, the limit was restricted at the RF Output Power.
6. The average value of fundamental and harmonic frequency is: Average = Peak value + 20 log(Duty cycle) Where the duty cycle correction factor is calculated from following formula:
 $20 \log(\text{Duty cycle}) = 20 \log(2.898 \text{ ms} / 100 \text{ ms}) = -30.8 \text{ dB}$

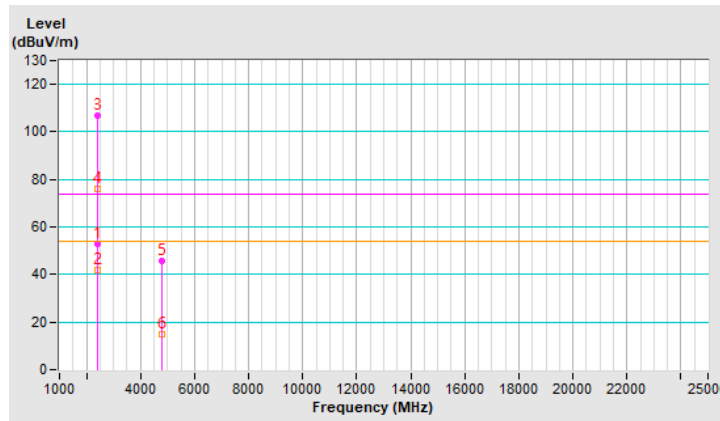

RF Mode	BT 8DPSK	Channel	CH 0 : 2402 MHz
Frequency Range	1 GHz ~ 25 GHz	Detector Function & Bandwidth	(PK) RB = 1 MHz, VB = 3 MHz (AV) RB = 1 MHz, VB = 3 MHz
Input Power (System)	120 Vac, 60 Hz	Environmental Conditions	30°C, 77% RH
Tested By	Louis Yang		

Antenna Polarity & Test Distance : Vertical at 3 m								
No	Frequency (MHz)	Emission Level (dBuV/m)	Limit (dBuV/m)	Margin (dB)	Antenna Height (m)	Table Angle (Degree)	Raw Value (dBuV)	Correction Factor (dB/m)
1	2390.00	52.1 PK	74.0	-21.9	1.65 V	108	57.8	-5.7
2	2390.00	40.6 AV	54.0	-13.4	1.65 V	108	46.3	-5.7
3	*2402.00	98.1 PK			1.65 V	108	103.8	-5.7
4	*2402.00	67.3 AV			1.65 V	108	73.0	-5.7
5	4804.00	43.6 PK	74.0	-30.4	1.70 V	168	43.3	0.3
6	4804.00	12.8 AV	54.0	-41.2	1.70 V	168	12.5	0.3

Remarks:

1. Emission Level(dBuV/m) = Raw Value(dBuV) + Correction Factor(dB/m)
2. Correction Factor(dB/m) = Antenna Factor(dB/m) + Cable Factor(dB) – Pre-Amplifier Factor(dB)
3. Margin value = Emission Level – Limit value
4. The other emission levels were very low against the limit.
5. " * " : Fundamental frequency, the limit was restricted at the RF Output Power.
6. The average value of fundamental and harmonic frequency is: Average = Peak value + 20 log(Duty cycle) Where the duty cycle correction factor is calculated from following formula:
 $20 \log(\text{Duty cycle}) = 20 \log(2.898 \text{ ms} / 100 \text{ ms}) = -30.8 \text{ dB}$

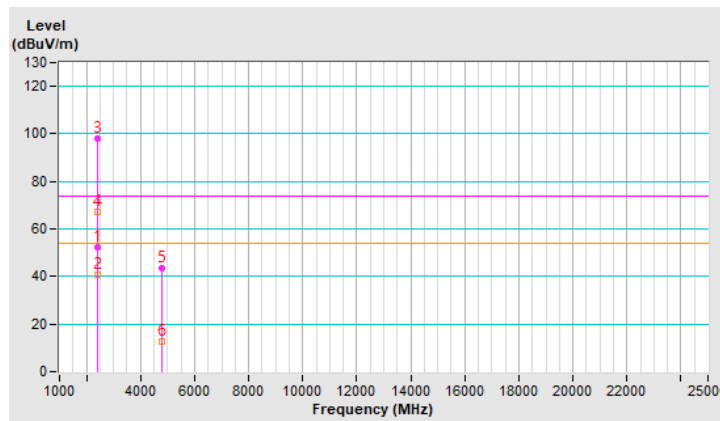

RF Mode	BT 8DPSK	Channel	CH 39 : 2441 MHz
Frequency Range	1 GHz ~ 25 GHz	Detector Function & Bandwidth	(PK) RB = 1 MHz, VB = 3 MHz (AV) RB = 1 MHz, VB = 3 MHz
Input Power (System)	120 Vac, 60 Hz	Environmental Conditions	30°C, 77% RH
Tested By	Louis Yang		

Antenna Polarity & Test Distance : Horizontal at 3 m								
No	Frequency (MHz)	Emission Level (dBuV/m)	Limit (dBuV/m)	Margin (dB)	Antenna Height (m)	Table Angle (Degree)	Raw Value (dBuV)	Correction Factor (dB/m)
1	*2441.00	106.9 PK			1.11 H	170	112.5	-5.6
2	*2441.00	76.1 AV			1.11 H	170	81.7	-5.6
3	4882.00	46.2 PK	74.0	-27.8	2.19 H	244	45.9	0.3
4	4882.00	15.4 AV	54.0	-38.6	2.19 H	244	15.1	0.3
5	7323.00	42.4 PK	74.0	-31.6	1.62 H	157	35.5	6.9
6	7323.00	11.6 AV	54.0	-42.4	1.62 H	157	4.7	6.9

Remarks:

1. Emission Level(dBuV/m) = Raw Value(dBuV) + Correction Factor(dB/m)
2. Correction Factor(dB/m) = Antenna Factor(dB/m) + Cable Factor(dB) – Pre-Amplifier Factor(dB)
3. Margin value = Emission Level – Limit value
4. The other emission levels were very low against the limit.
5. " * " : Fundamental frequency, the limit was restricted at the RF Output Power.
6. The average value of fundamental and harmonic frequency is: Average = Peak value + 20 log(Duty cycle) Where the duty cycle correction factor is calculated from following formula:
 $20 \log(\text{Duty cycle}) = 20 \log(2.898 \text{ ms} / 100 \text{ ms}) = -30.8 \text{ dB}$

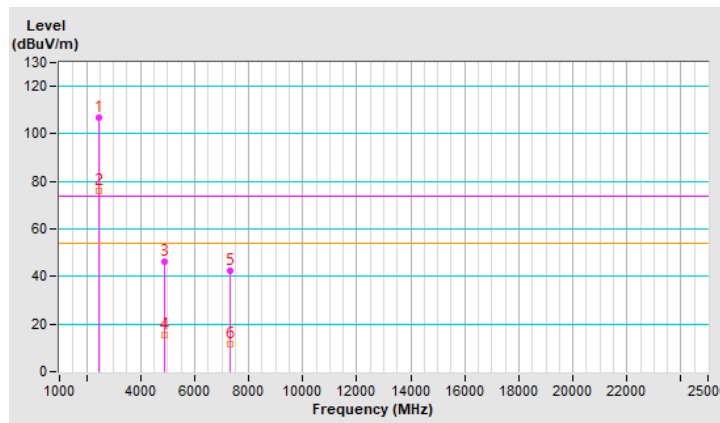

RF Mode	BT 8DPSK	Channel	CH 39 : 2441 MHz
Frequency Range	1 GHz ~ 25 GHz	Detector Function & Bandwidth	(PK) RB = 1 MHz, VB = 3 MHz (AV) RB = 1 MHz, VB = 3 MHz
Input Power (System)	120 Vac, 60 Hz	Environmental Conditions	30°C, 77% RH
Tested By	Louis Yang		

Antenna Polarity & Test Distance : Vertical at 3 m								
No	Frequency (MHz)	Emission Level (dBuV/m)	Limit (dBuV/m)	Margin (dB)	Antenna Height (m)	Table Angle (Degree)	Raw Value (dBuV)	Correction Factor (dB/m)
1	*2441.00	101.4 PK			1.62 V	81	107.0	-5.6
2	*2441.00	70.6 AV			1.62 V	81	76.2	-5.6
3	4882.00	50.6 PK	74.0	-23.4	2.48 V	202	50.3	0.3
4	4882.00	19.8 AV	54.0	-34.2	2.48 V	202	19.5	0.3
5	7323.00	42.4 PK	74.0	-31.6	1.71 V	141	35.5	6.9
6	7323.00	11.6 AV	54.0	-42.4	1.71 V	141	4.7	6.9

Remarks:

1. Emission Level(dBuV/m) = Raw Value(dBuV) + Correction Factor(dB/m)
2. Correction Factor(dB/m) = Antenna Factor(dB/m) + Cable Factor(dB) – Pre-Amplifier Factor(dB)
3. Margin value = Emission Level – Limit value
4. The other emission levels were very low against the limit.
5. " * " : Fundamental frequency, the limit was restricted at the RF Output Power.
6. The average value of fundamental and harmonic frequency is: Average = Peak value + 20 log(Duty cycle) Where the duty cycle correction factor is calculated from following formula:
 $20 \log(\text{Duty cycle}) = 20 \log(2.898 \text{ ms} / 100 \text{ ms}) = -30.8 \text{ dB}$

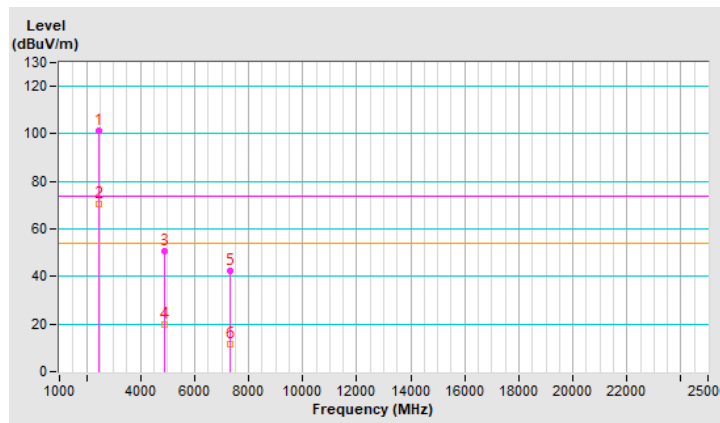

RF Mode	BT 8DPSK	Channel	CH 78 : 2480 MHz
Frequency Range	1 GHz ~ 25 GHz	Detector Function & Bandwidth	(PK) RB = 1 MHz, VB = 3 MHz (AV) RB = 1 MHz, VB = 3 MHz
Input Power (System)	120 Vac, 60 Hz	Environmental Conditions	30°C, 77% RH
Tested By	Louis Yang		

Antenna Polarity & Test Distance : Horizontal at 3 m								
No	Frequency (MHz)	Emission Level (dBuV/m)	Limit (dBuV/m)	Margin (dB)	Antenna Height (m)	Table Angle (Degree)	Raw Value (dBuV)	Correction Factor (dB/m)
1	*2480.00	105.4 PK			1.01 H	203	111.1	-5.7
2	*2480.00	74.6 AV			1.01 H	203	80.3	-5.7
3	2483.50	61.3 PK	74.0	-12.7	1.01 H	203	67.0	-5.7
4	2483.50	46.2 AV	54.0	-7.8	1.01 H	203	51.9	-5.7
5	4960.00	45.5 PK	74.0	-28.5	2.39 H	256	45.0	0.5
6	4960.00	14.7 AV	54.0	-39.3	2.39 H	256	14.2	0.5
7	7440.00	42.6 PK	74.0	-31.4	1.59 H	165	35.2	7.4
8	7440.00	11.8 AV	54.0	-42.2	1.59 H	165	4.4	7.4

Remarks:

1. Emission Level(dBuV/m) = Raw Value(dBuV) + Correction Factor(dB/m)
2. Correction Factor(dB/m) = Antenna Factor(dB/m) + Cable Factor(dB) – Pre-Amplifier Factor(dB)
3. Margin value = Emission Level – Limit value
4. The other emission levels were very low against the limit.
5. " * ": Fundamental frequency, the limit was restricted at the RF Output Power.
6. The average value of fundamental and harmonic frequency is: Average = Peak value + 20 log(Duty cycle) Where the duty cycle correction factor is calculated from following formula:
 $20 \log(\text{Duty cycle}) = 20 \log(2.898 \text{ ms} / 100 \text{ ms}) = -30.8 \text{ dB}$

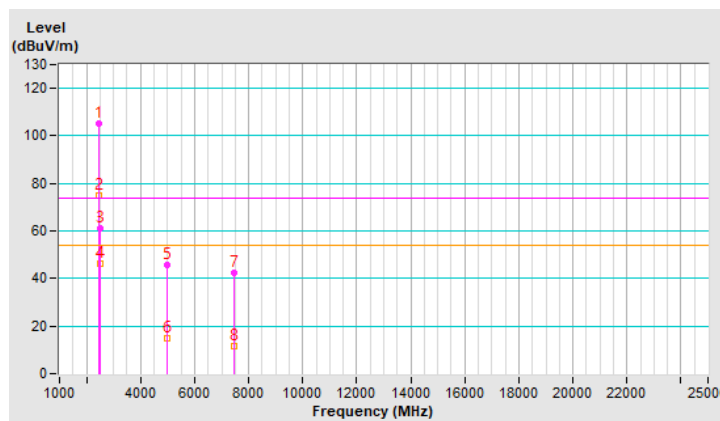

RF Mode	BT 8DPSK	Channel	CH 78 : 2480 MHz
Frequency Range	1 GHz ~ 25 GHz	Detector Function & Bandwidth	(PK) RB = 1 MHz, VB = 3 MHz (AV) RB = 1 MHz, VB = 3 MHz
Input Power (System)	120 Vac, 60 Hz	Environmental Conditions	30°C, 77% RH
Tested By	Louis Yang		

Antenna Polarity & Test Distance : Vertical at 3 m								
No	Frequency (MHz)	Emission Level (dBuV/m)	Limit (dBuV/m)	Margin (dB)	Antenna Height (m)	Table Angle (Degree)	Raw Value (dBuV)	Correction Factor (dB/m)
1	*2480.00	99.7 PK			2.03 V	169	105.4	-5.7
2	*2480.00	68.9 AV			2.03 V	169	74.6	-5.7
3	2483.50	60.8 PK	74.0	-13.2	2.03 V	169	66.5	-5.7
4	2483.50	46.3 AV	54.0	-7.7	2.03 V	169	52.0	-5.7
5	4960.00	49.9 PK	74.0	-24.1	2.32 V	228	49.4	0.5
6	4960.00	19.1 AV	54.0	-34.9	2.32 V	228	18.6	0.5
7	7440.00	41.7 PK	74.0	-32.3	1.55 V	139	34.3	7.4
8	7440.00	10.9 AV	54.0	-43.1	1.55 V	139	3.5	7.4

Remarks:

1. Emission Level(dBuV/m) = Raw Value(dBuV) + Correction Factor(dB/m)
2. Correction Factor(dB/m) = Antenna Factor(dB/m) + Cable Factor(dB) – Pre-Amplifier Factor(dB)
3. Margin value = Emission Level – Limit value
4. The other emission levels were very low against the limit.
5. " * ": Fundamental frequency, the limit was restricted at the RF Output Power.
6. The average value of fundamental and harmonic frequency is: Average = Peak value + 20 log(Duty cycle) Where the duty cycle correction factor is calculated from following formula:
 $20 \log(\text{Duty cycle}) = 20 \log(2.898 \text{ ms} / 100 \text{ ms}) = -30.8 \text{ dB}$

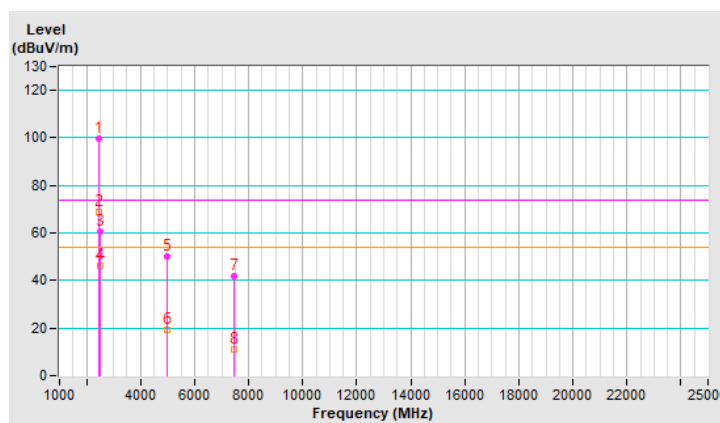

Plot of Band Edge Mode A

BT GFSK Channel 0

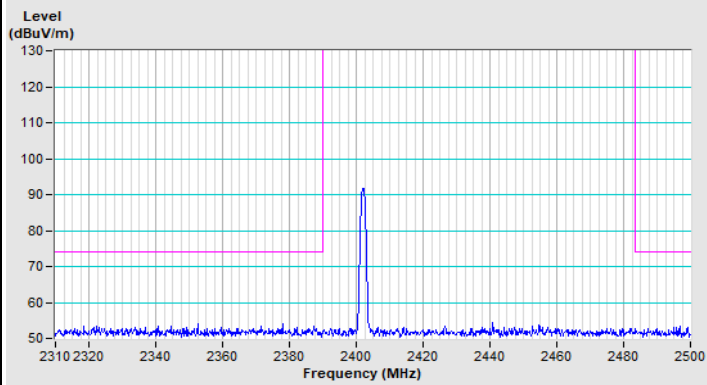

Horizontal (Peak)

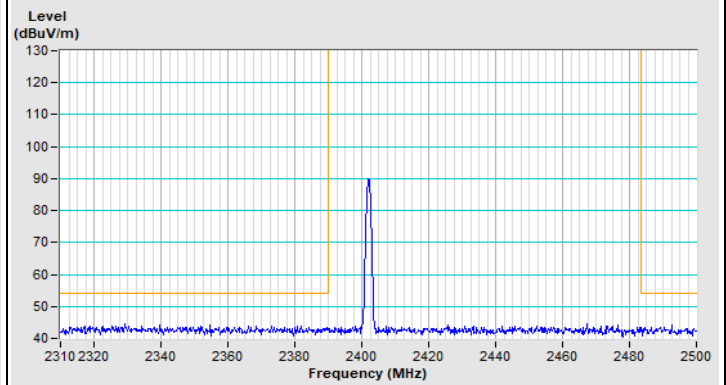

Horizontal (Average)

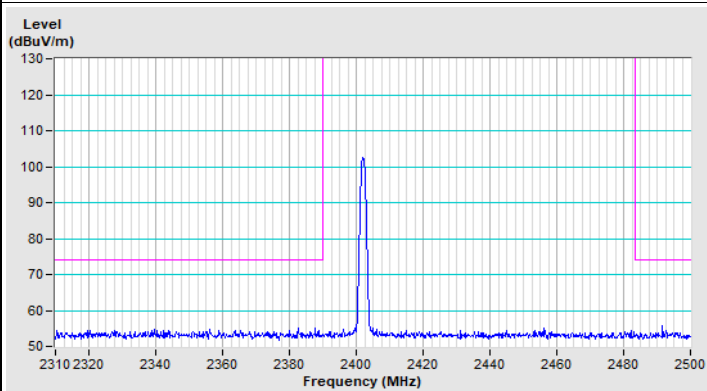

Vertical (Peak)

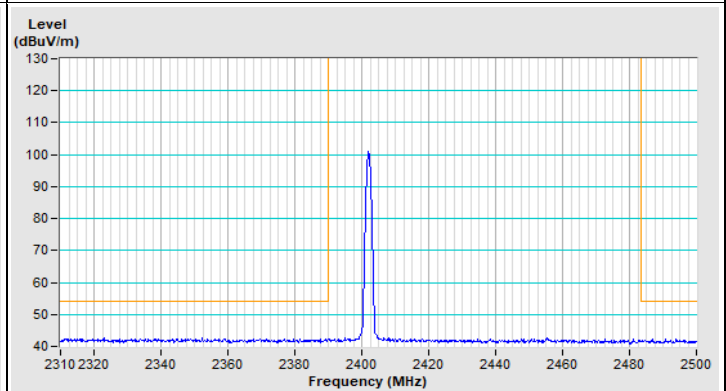

Vertical (Average)

BT GFSK Channel 78

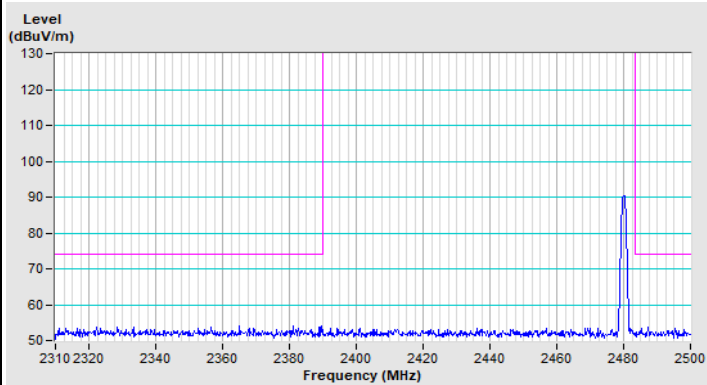

Horizontal (Peak)

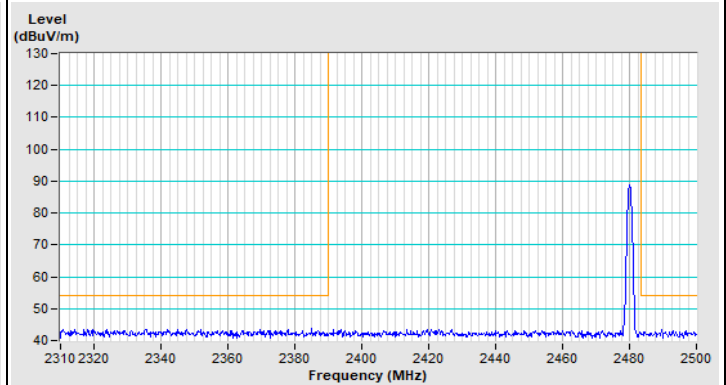

Horizontal (Average)

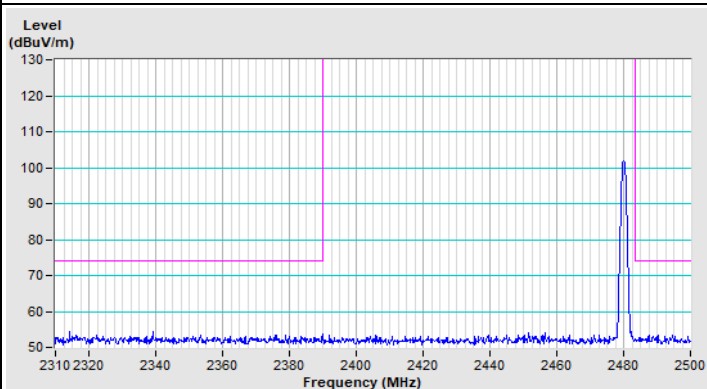

Vertical (Peak)

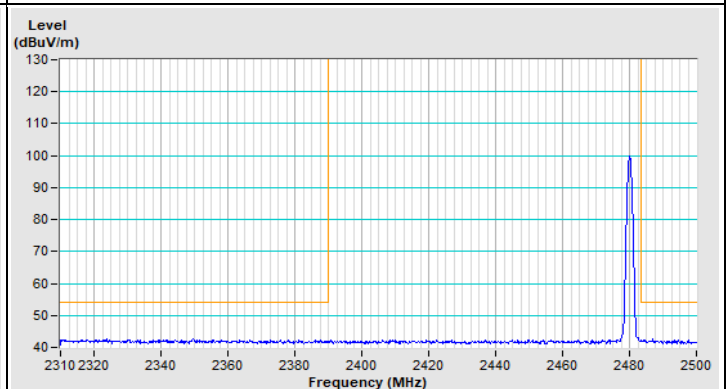

Vertical (Average)

BT 8DPSK Channel 0

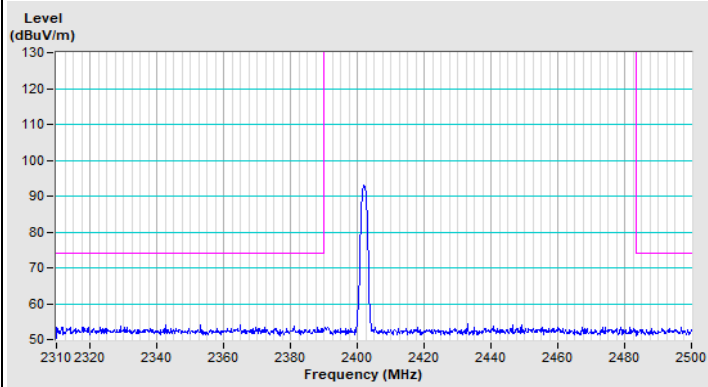

Horizontal (Peak)

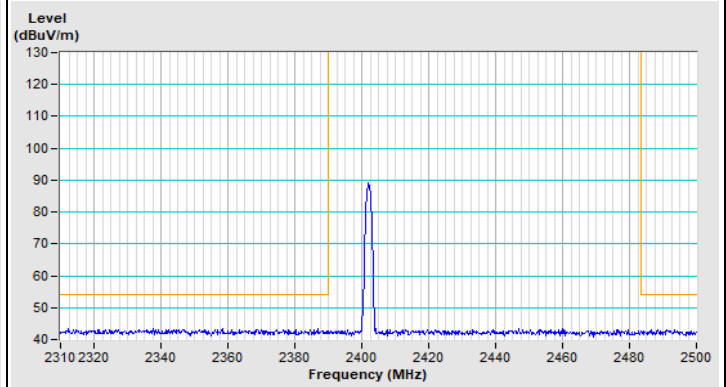

Horizontal (Average)

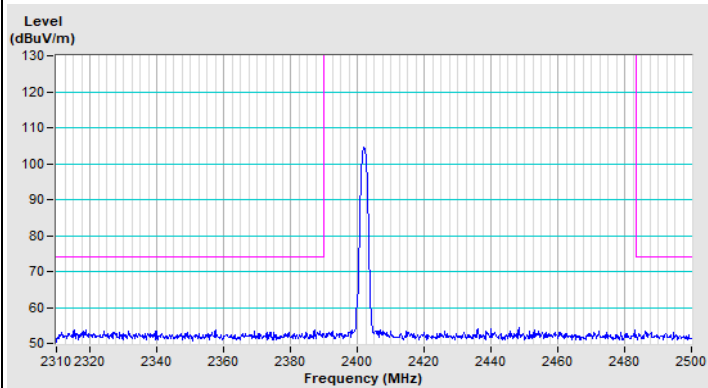

Vertical (Peak)

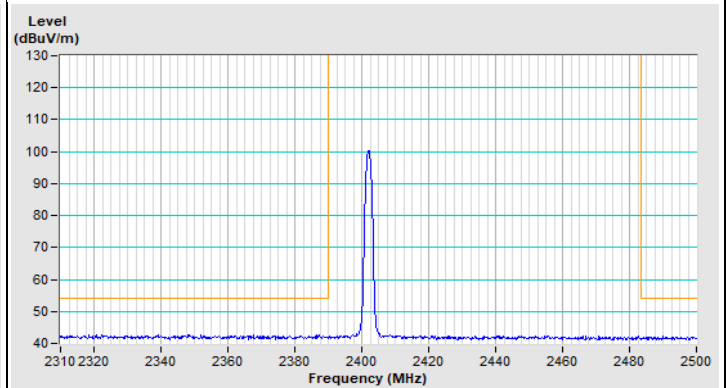

Vertical (Average)

BT 8DPSK Channel 78

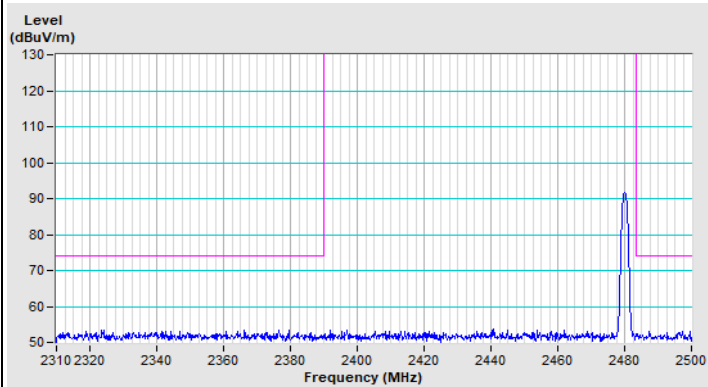

Horizontal (Peak)

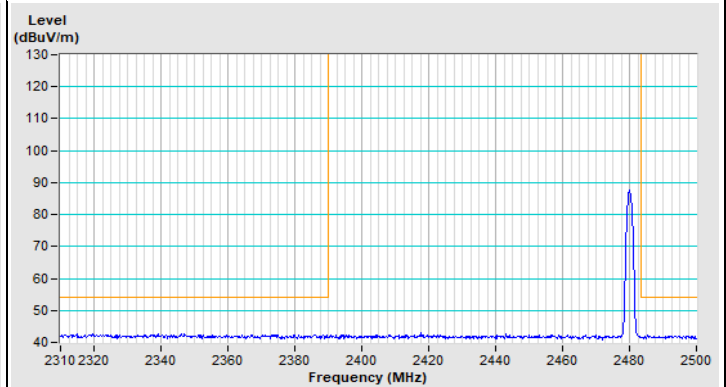

Horizontal (Average)

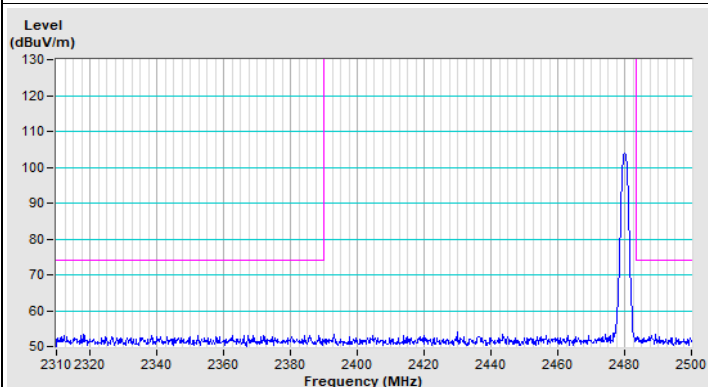

Vertical (Peak)

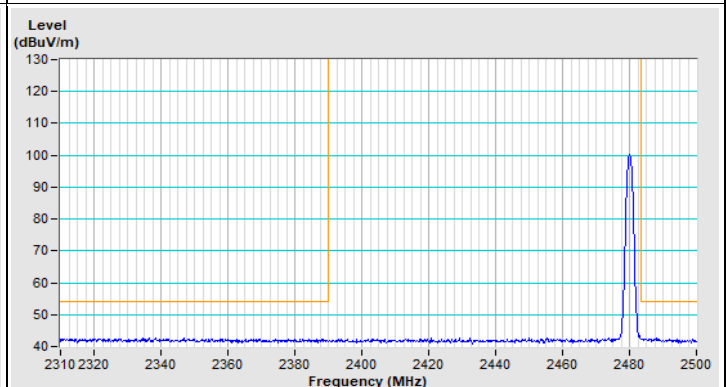

Vertical (Average)

Plot of Band Edge Mode B

BT GFSK Channel 0

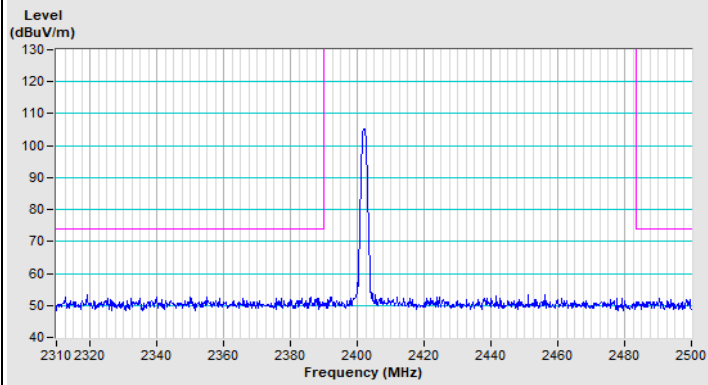

Horizontal (Peak)

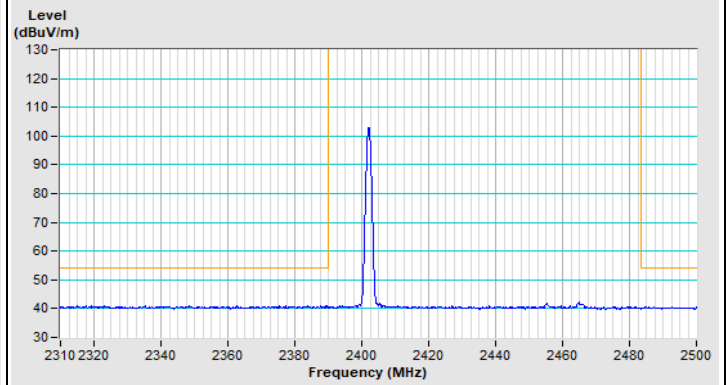

Horizontal (Average)

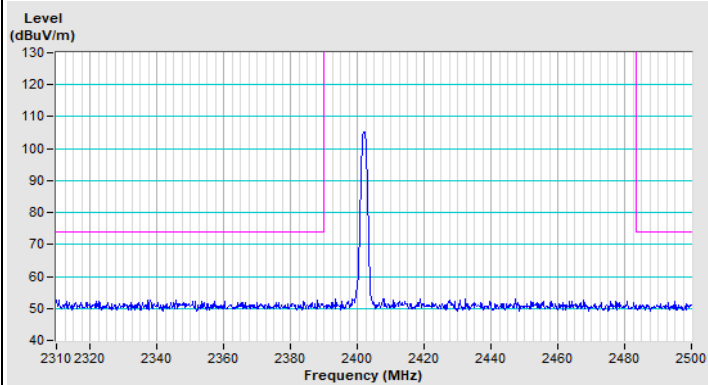

Vertical (Peak)

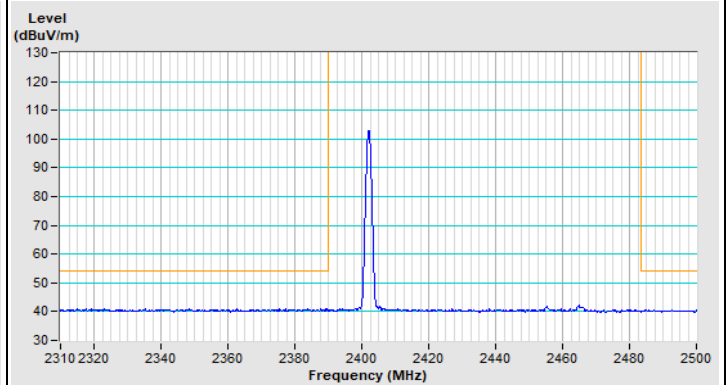

Vertical (Average)

BT GFSK Channel 78

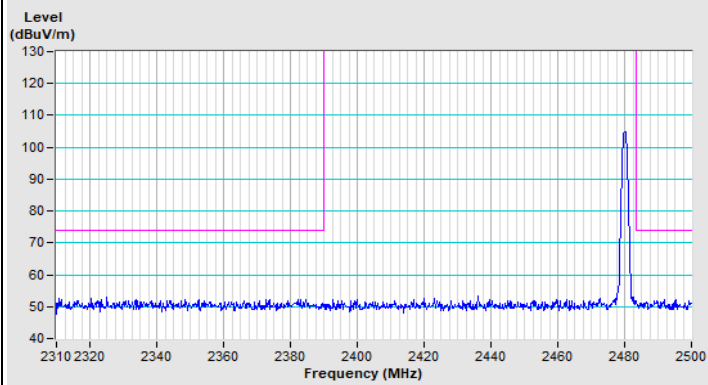

Horizontal (Peak)

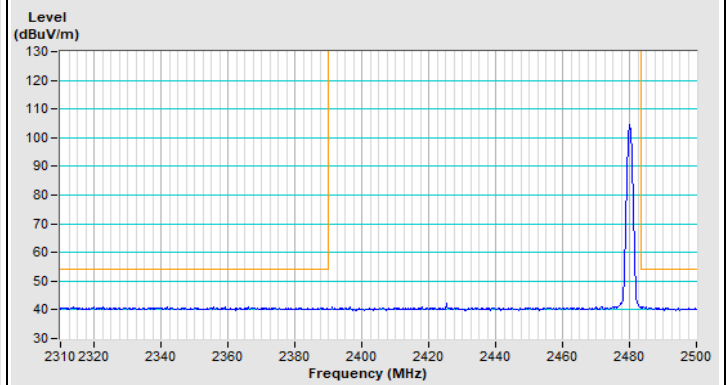

Horizontal (Average)

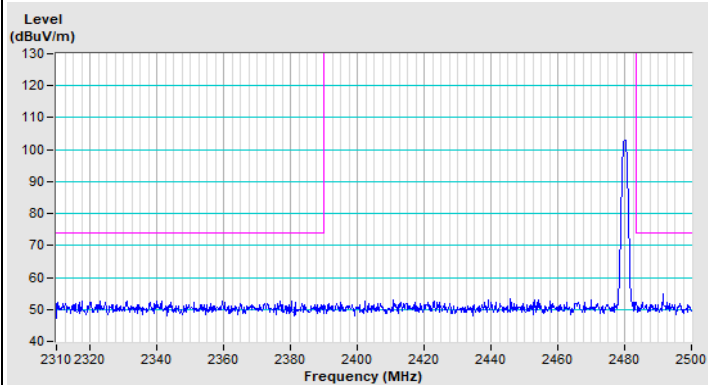

Vertical (Peak)

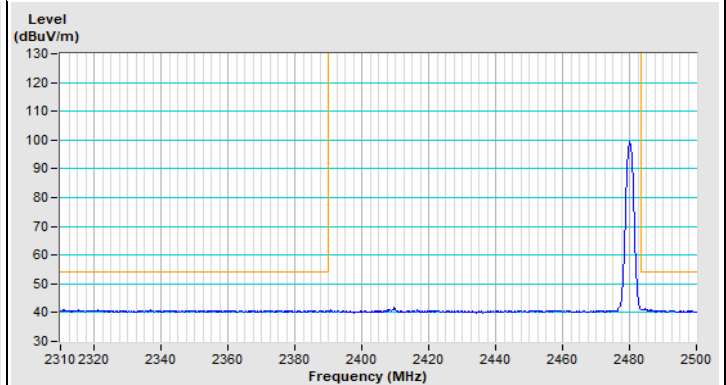

Vertical (Average)

BT 8DPSK Channel 0

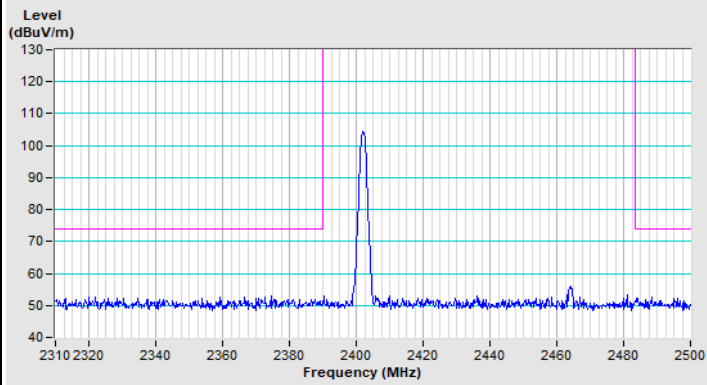

Horizontal (Peak)

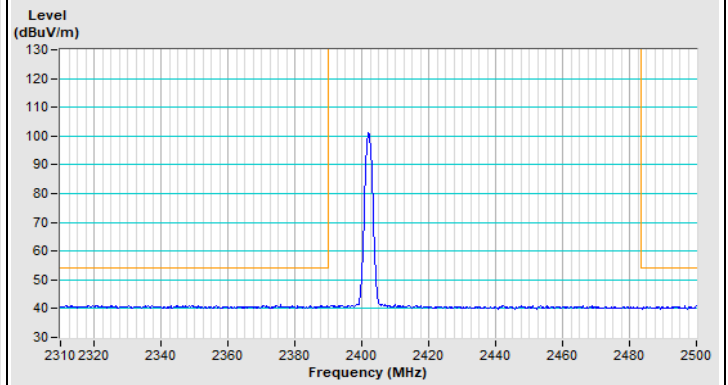

Horizontal (Average)

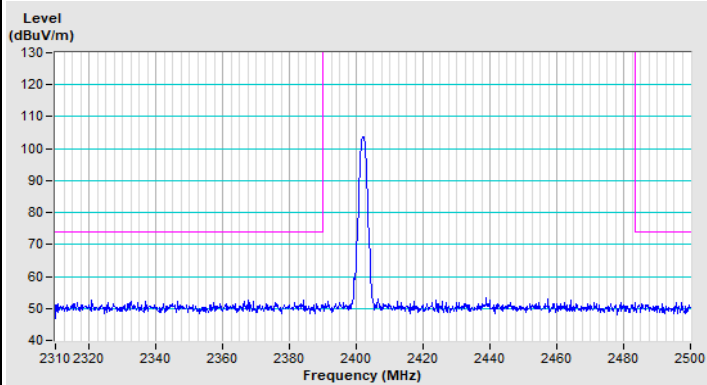

Vertical (Peak)

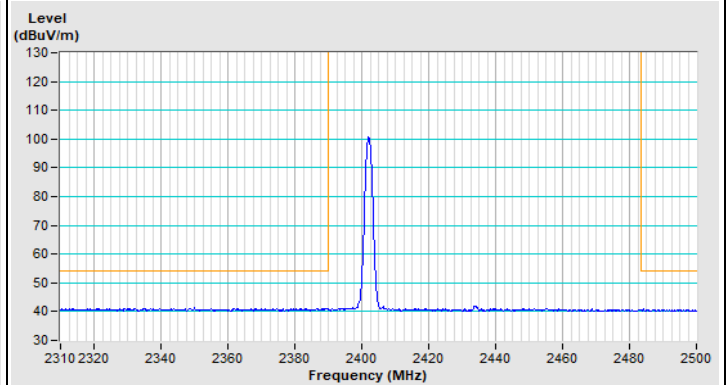

Vertical (Average)

BT 8DPSK Channel 78

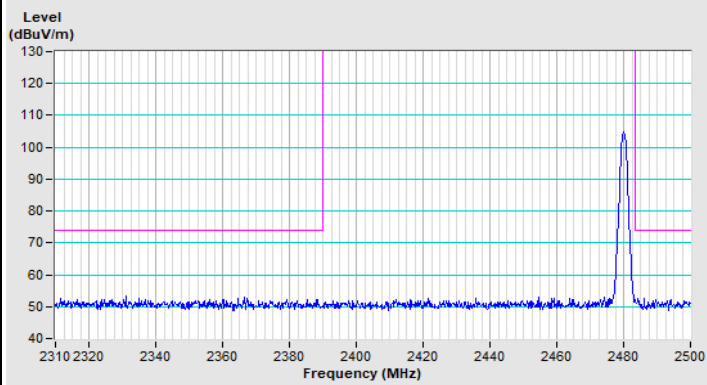

Horizontal (Peak)

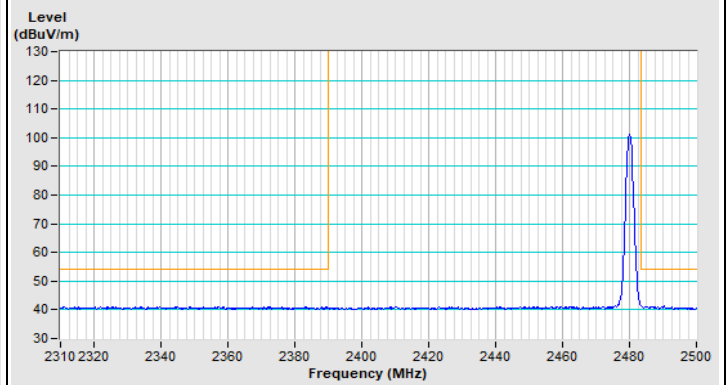

Horizontal (Average)

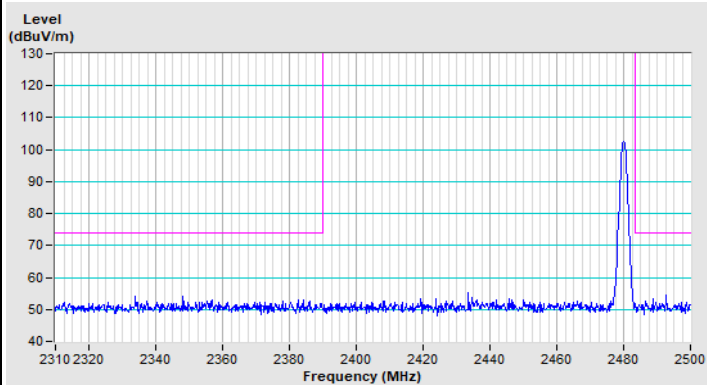

Vertical (Peak)

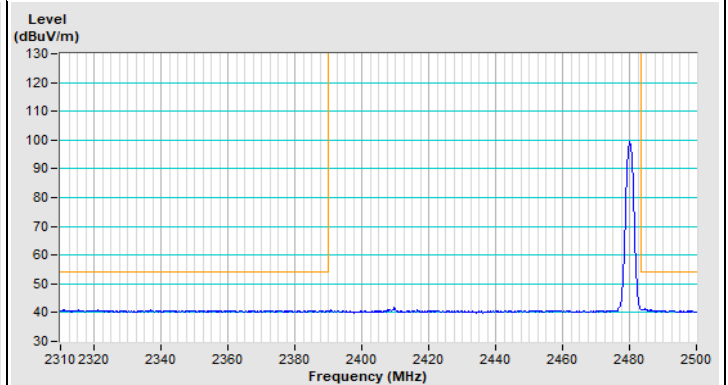

Vertical (Average)

Plot of Band Edge Mode C

BT GFSK Channel 0

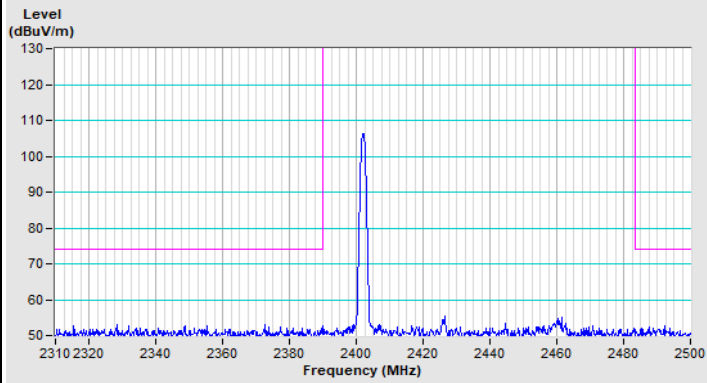

Horizontal (Peak)

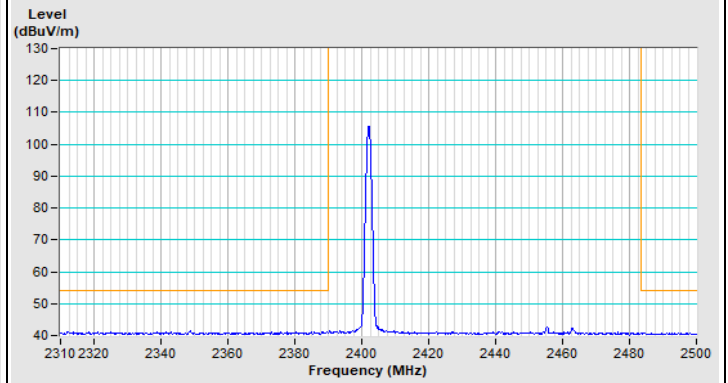

Horizontal (Average)

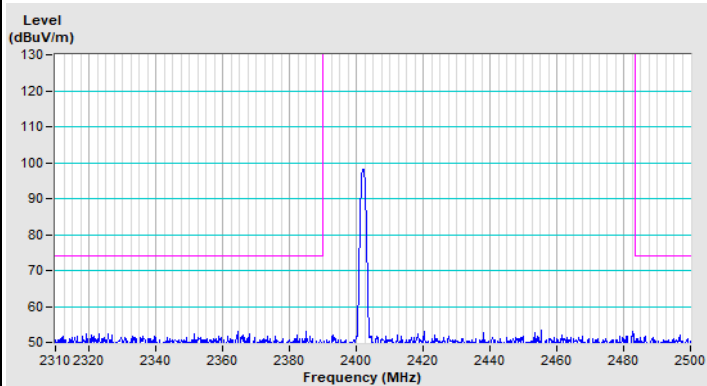

Vertical (Peak)

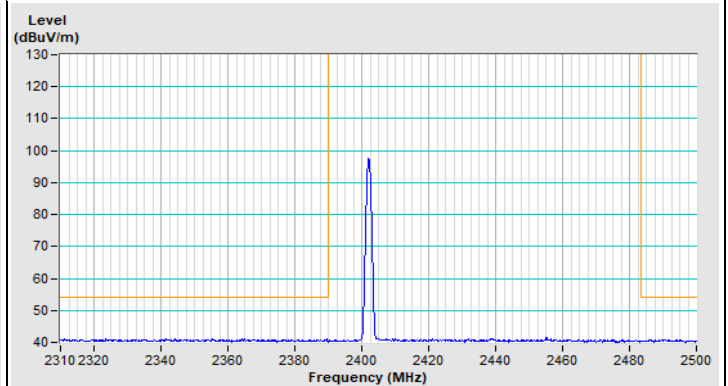

Vertical (Average)

BT GFSK Channel 78

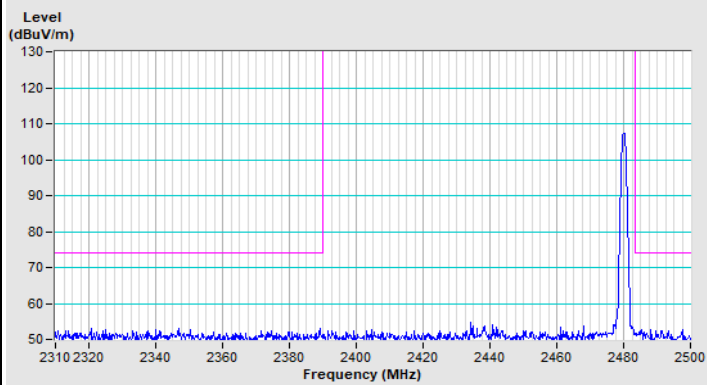

Horizontal (Peak)

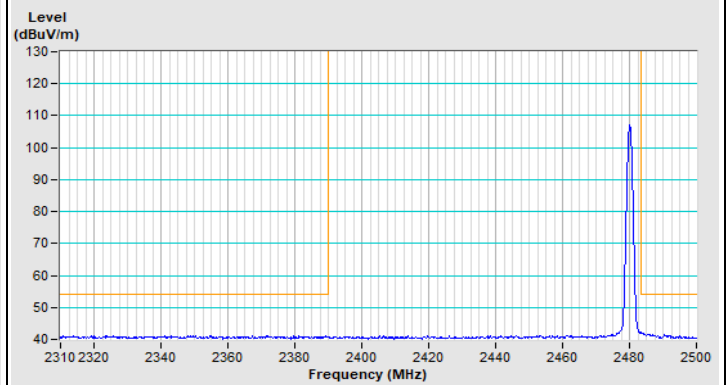

Horizontal (Average)

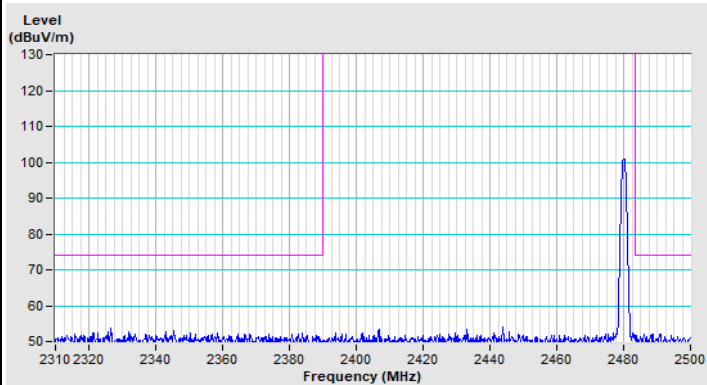

Vertical (Peak)

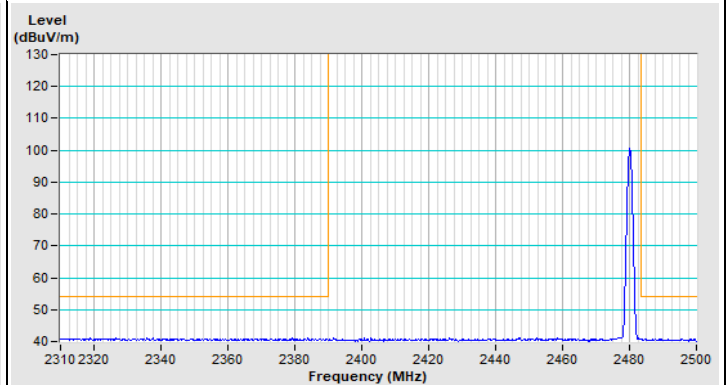

Vertical (Average)

BT 8DPSK Channel 0

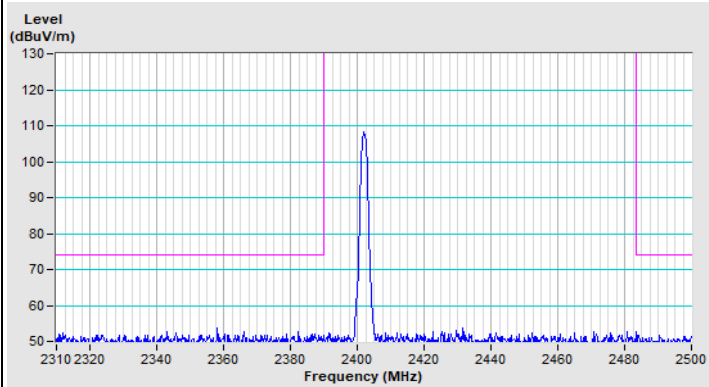

Horizontal (Peak)

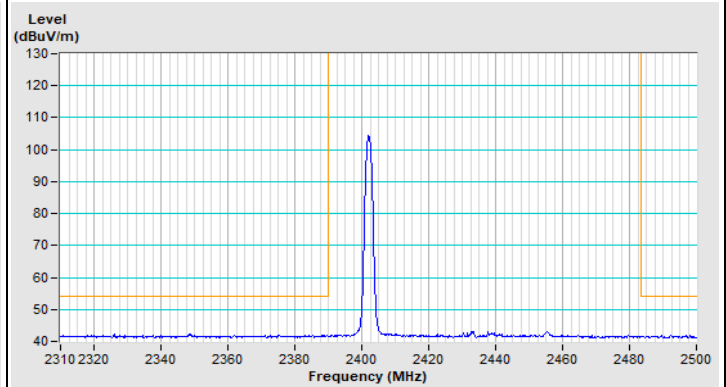

Horizontal (Average)

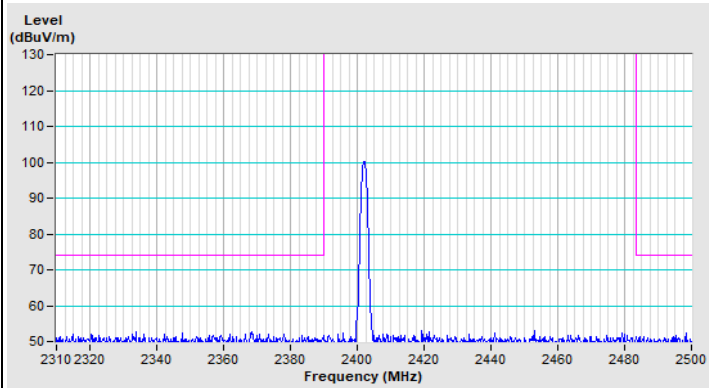

Vertical (Peak)

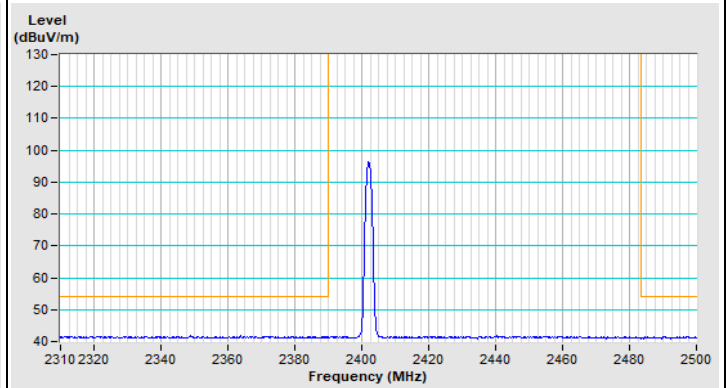

Vertical (Average)

BT 8DPSK Channel 78

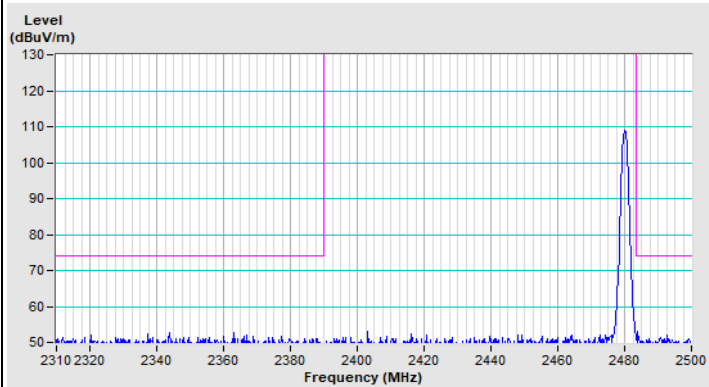

Horizontal (Peak)

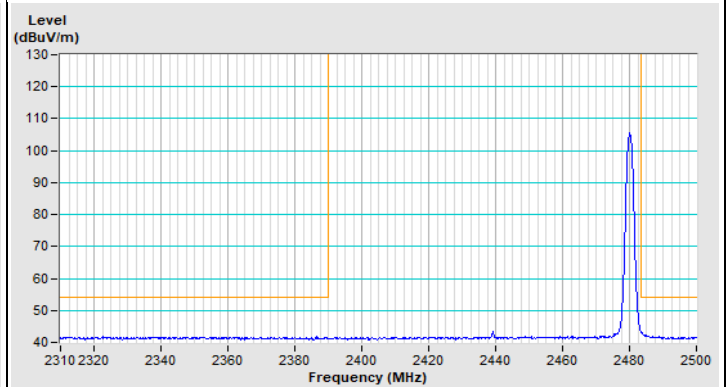

Horizontal (Average)

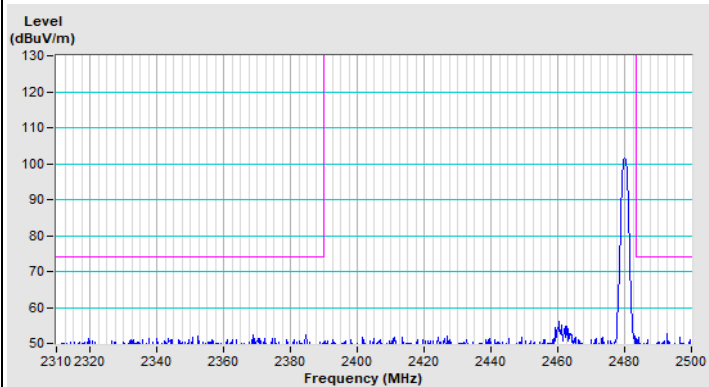

Vertical (Peak)

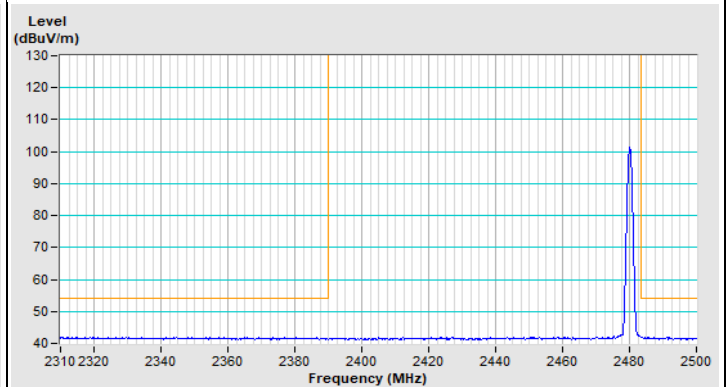

Vertical (Average)

Plot of Band Edge Mode D

BT GFSK Channel 0

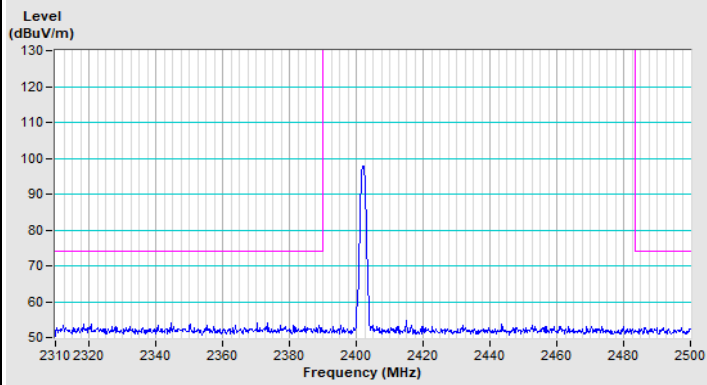

Horizontal (Peak)

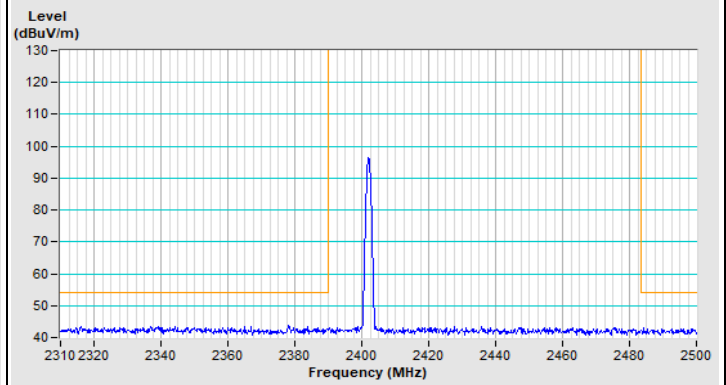

Horizontal (Average)

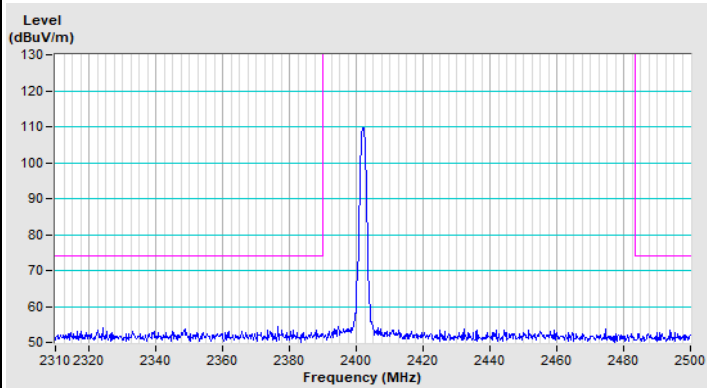

Vertical (Peak)

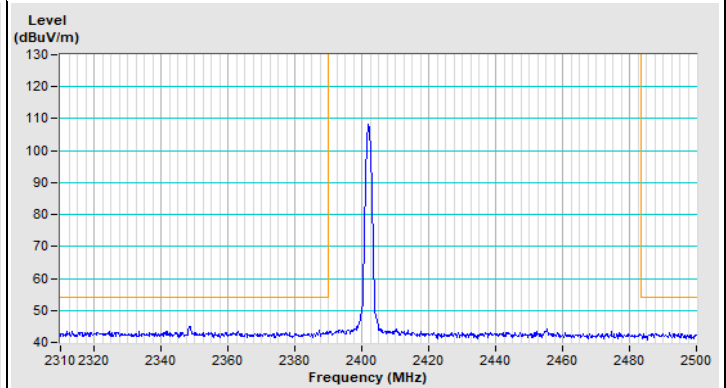

Vertical (Average)

BT GFSK Channel 78

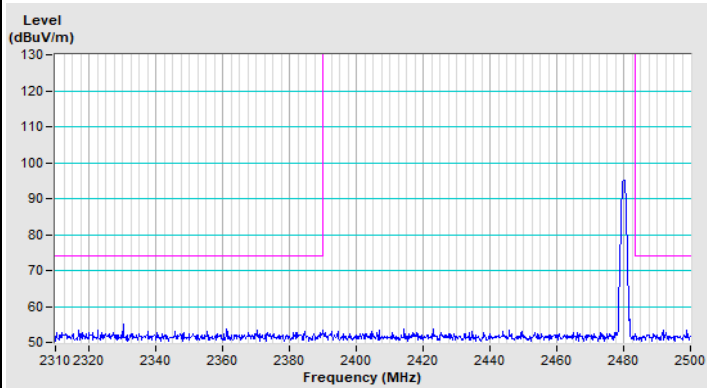

Horizontal (Peak)

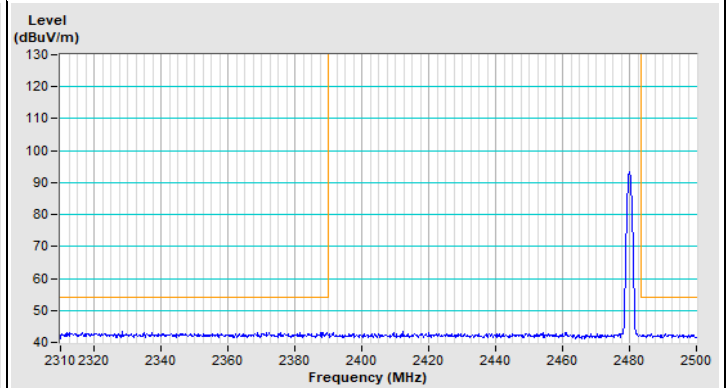

Horizontal (Average)

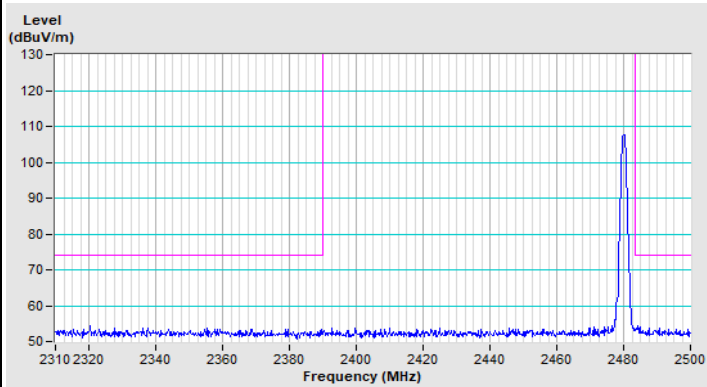

Vertical (Peak)

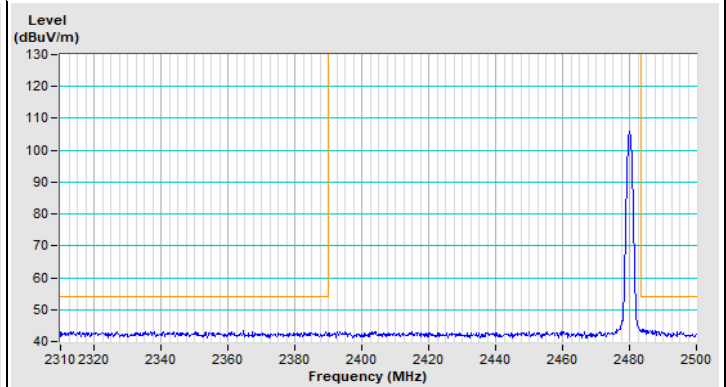

Vertical (Average)

BT 8DPSK Channel 0

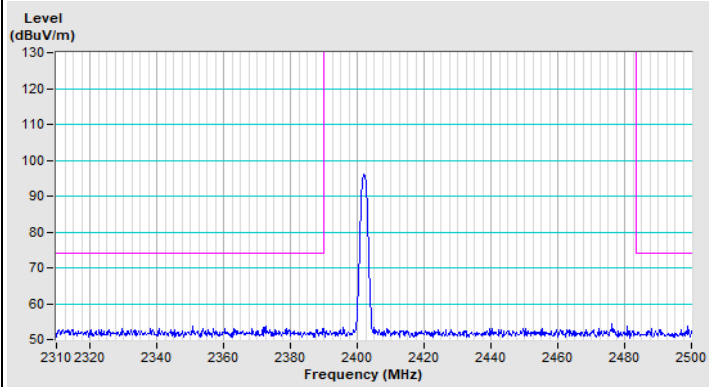

Horizontal (Peak)

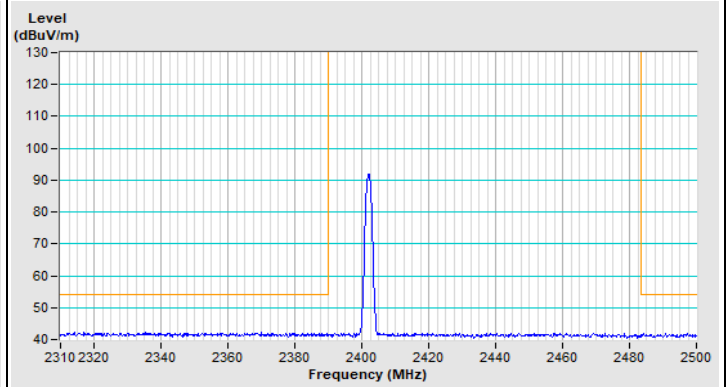

Horizontal (Average)

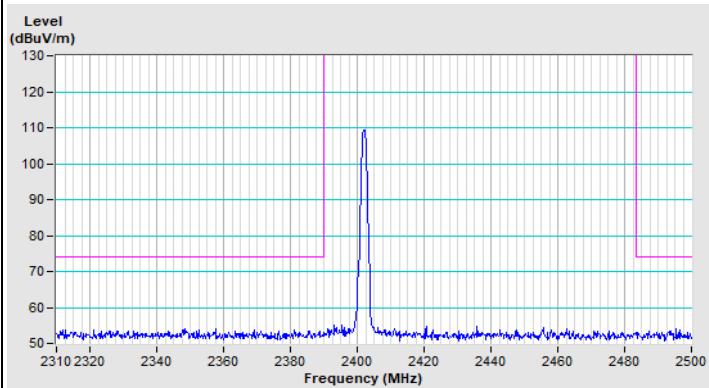

Vertical (Peak)

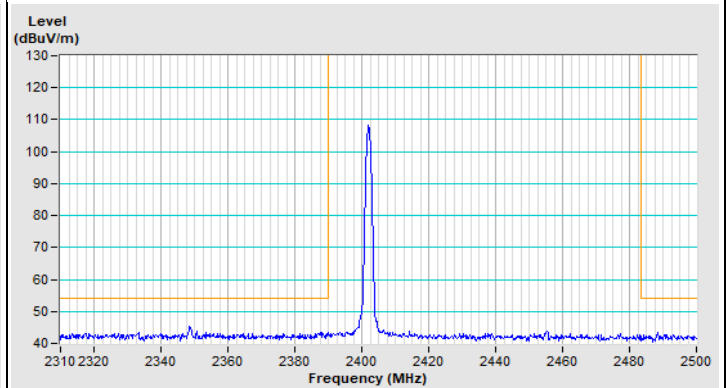

Vertical (Average)

BT 8DPSK Channel 78

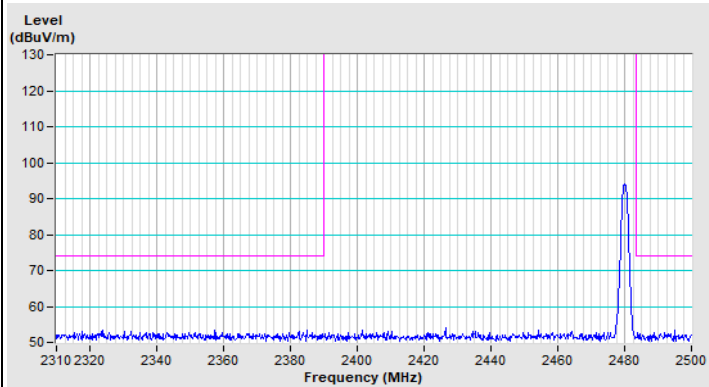

Horizontal (Peak)

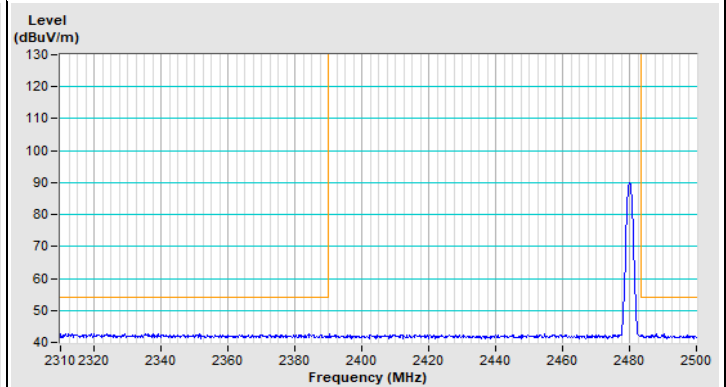

Horizontal (Average)

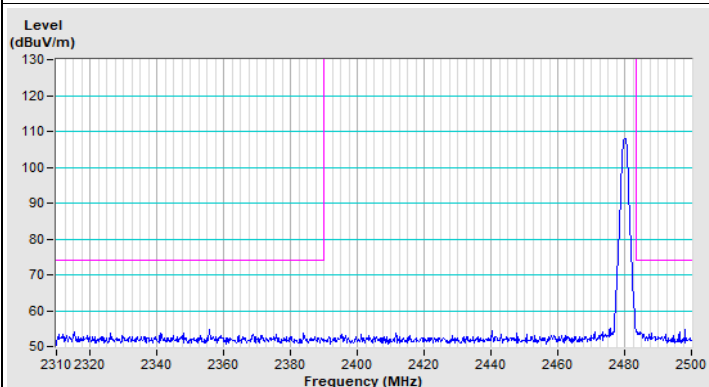

Vertical (Peak)

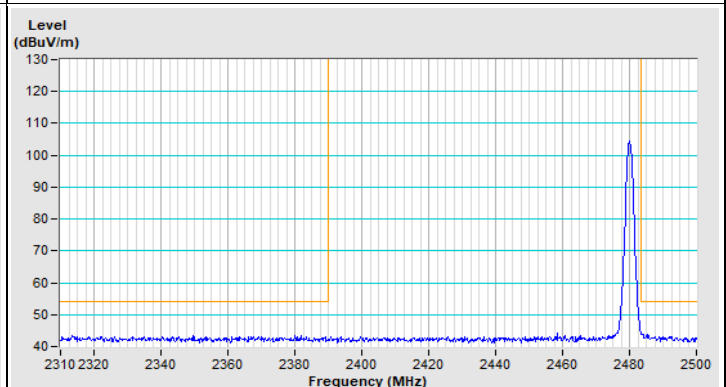

Vertical (Average)

Plot of Band Edge Mode E

BT GFSK Channel 0

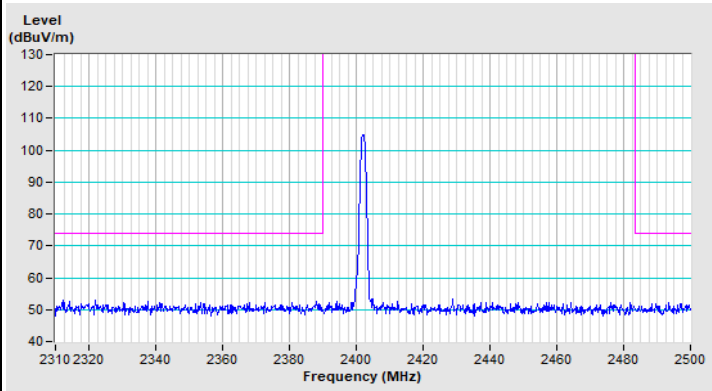

Horizontal (Peak)

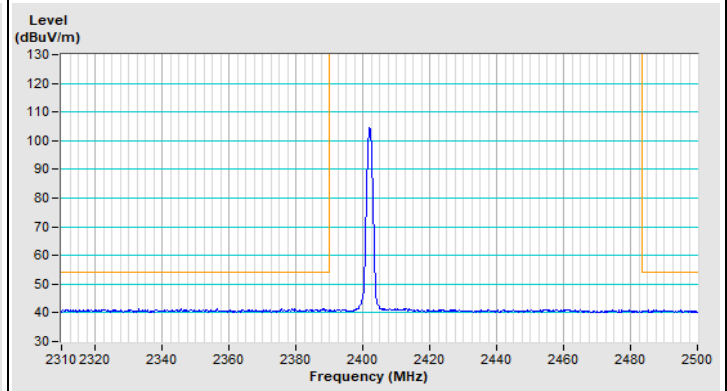

Horizontal (Average)

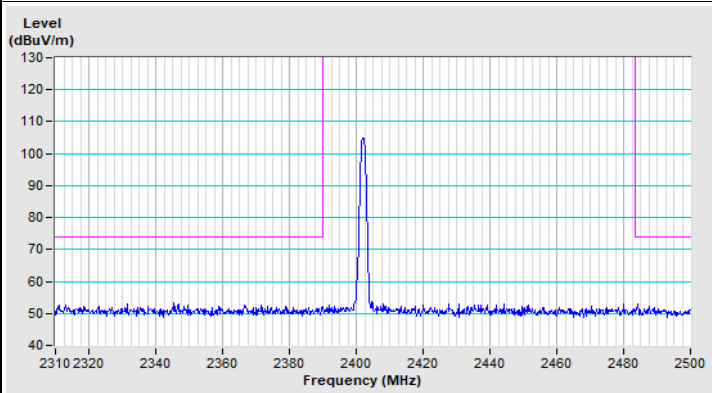

Vertical (Peak)

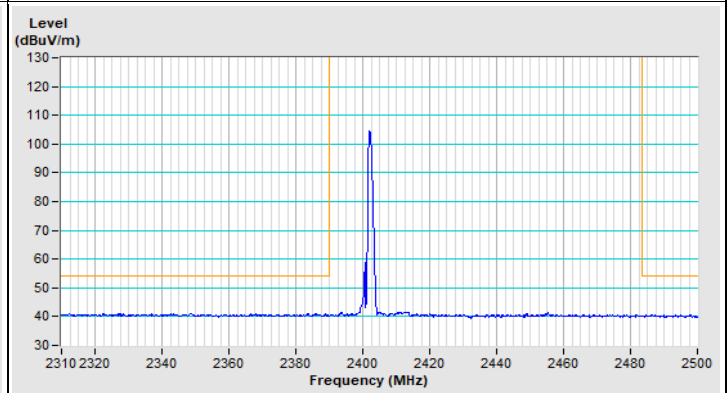

Vertical (Average)

BT GFSK Channel 78

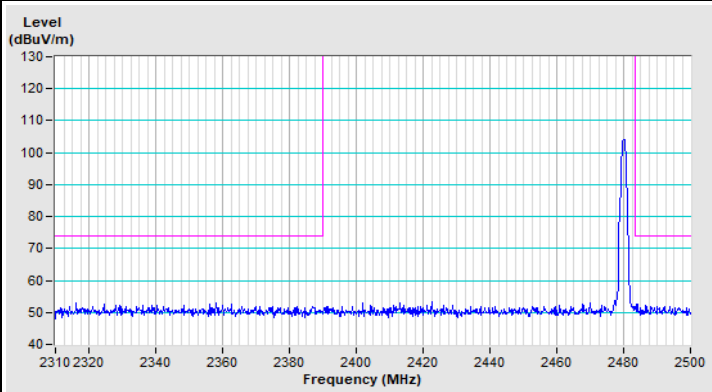

Horizontal (Peak)

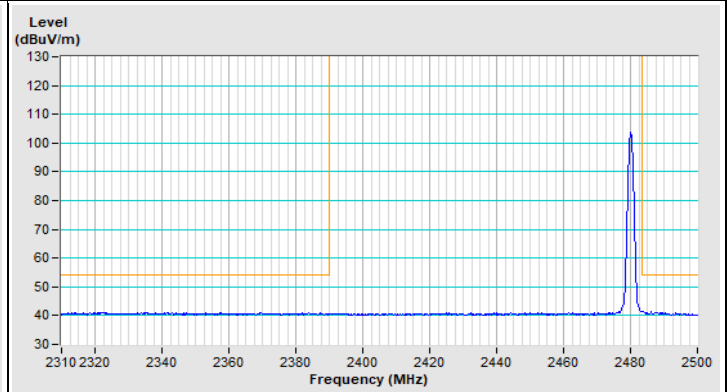

Horizontal (Average)

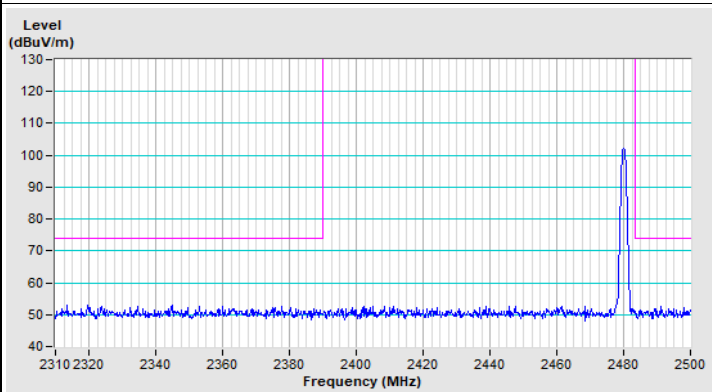

Vertical (Peak)

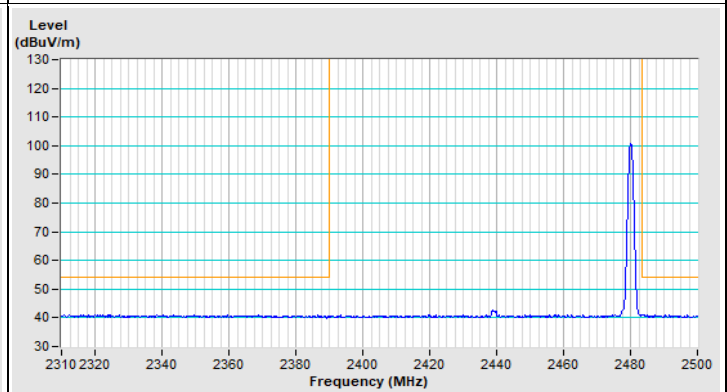

Vertical (Average)

BT 8DPSK Channel 0

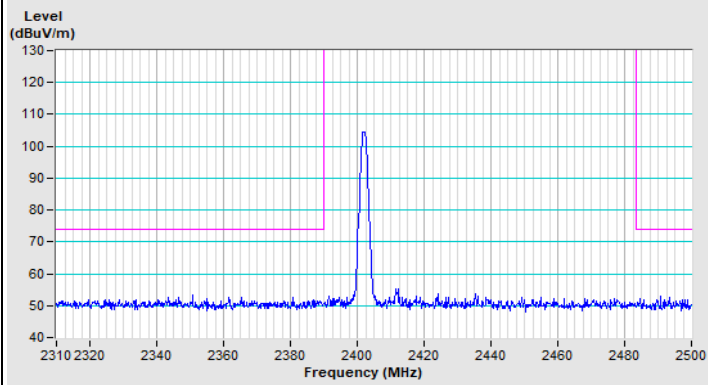

Horizontal (Peak)

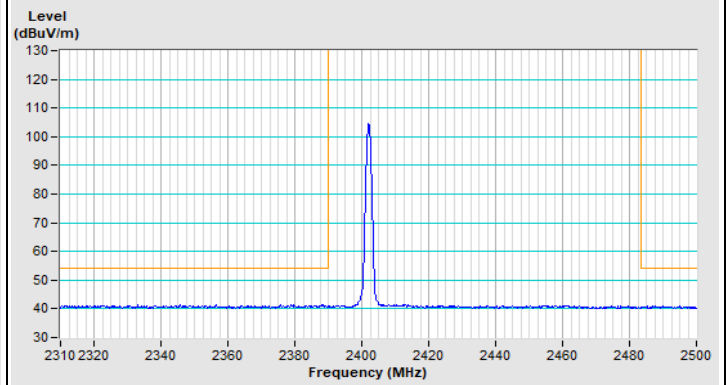

Horizontal (Average)

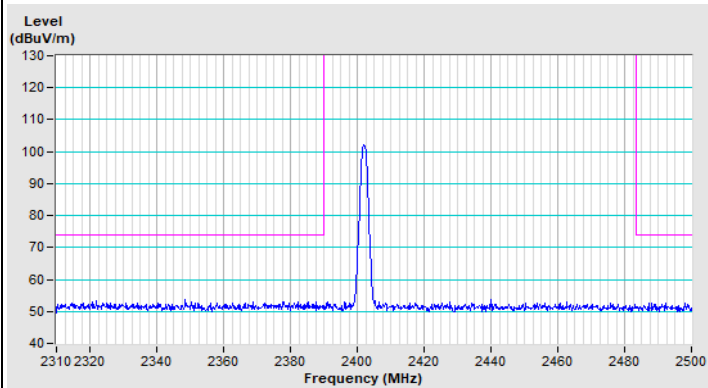

Vertical (Peak)

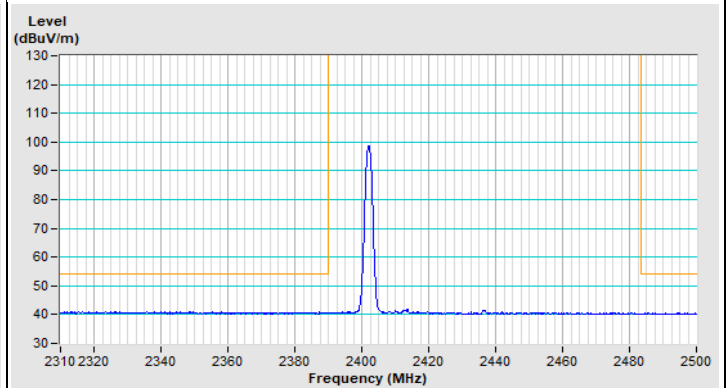

Vertical (Average)

BT 8DPSK Channel 78

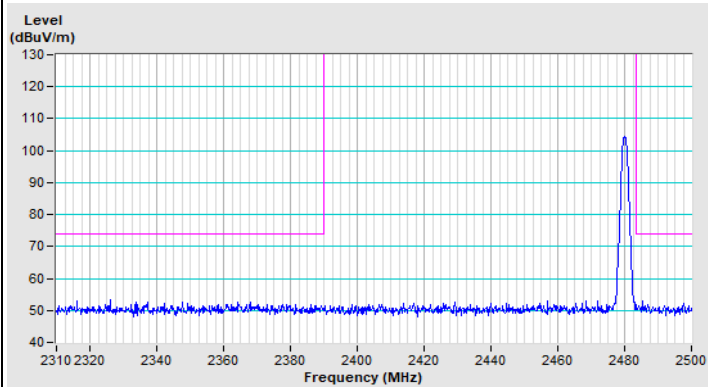

Horizontal (Peak)

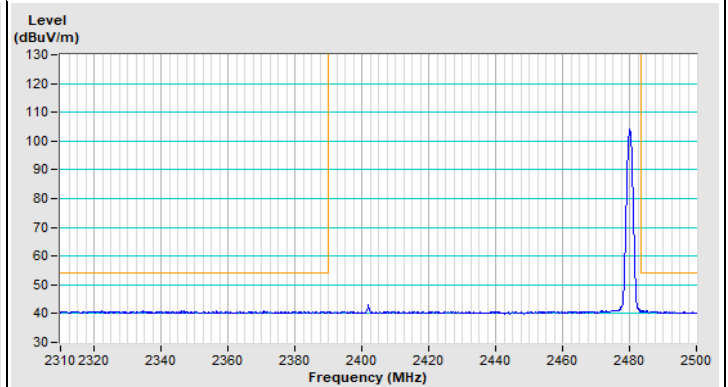

Horizontal (Average)

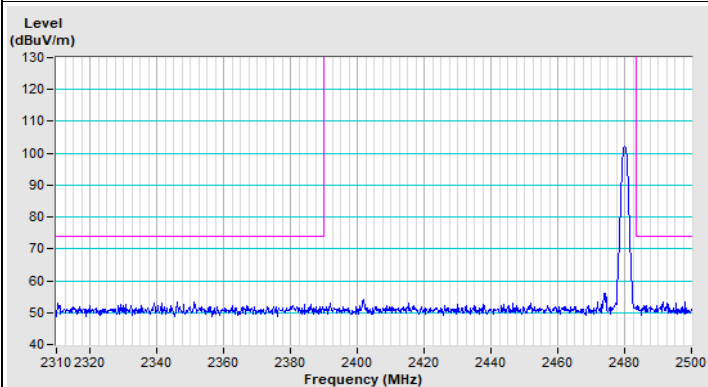

Vertical (Peak)

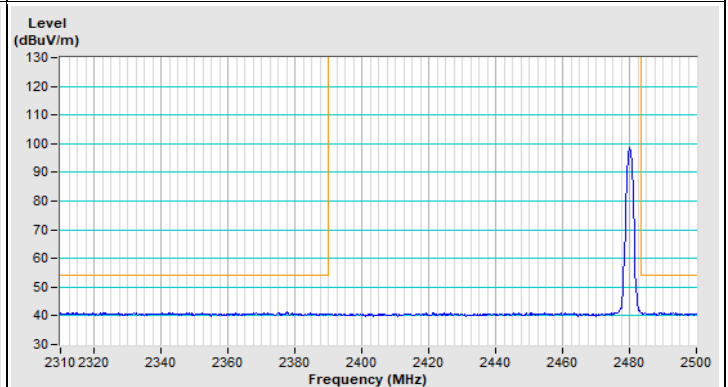

Vertical (Average)



Plot of Band Edge Mode F

BT GFSK Channel 0

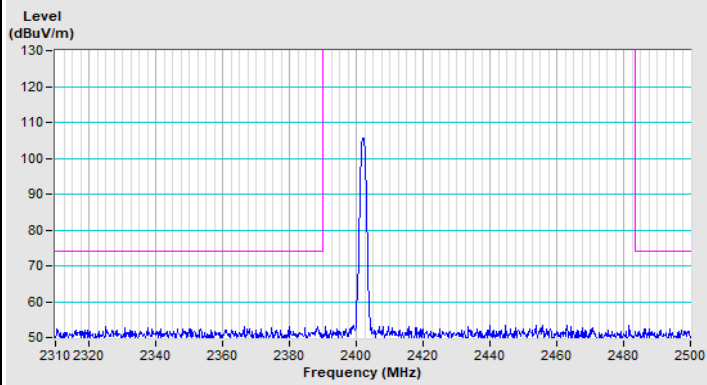

Horizontal (Peak)

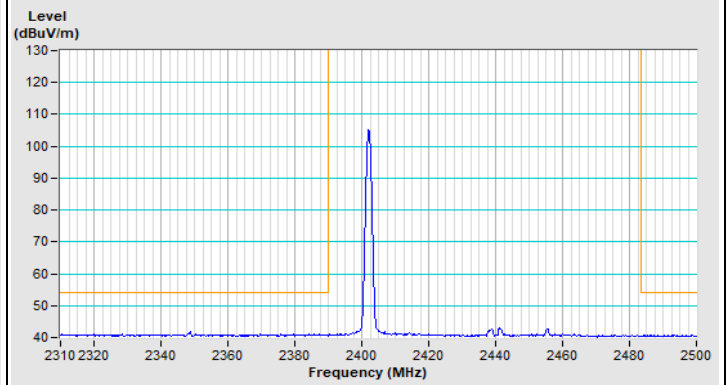

Horizontal (Average)

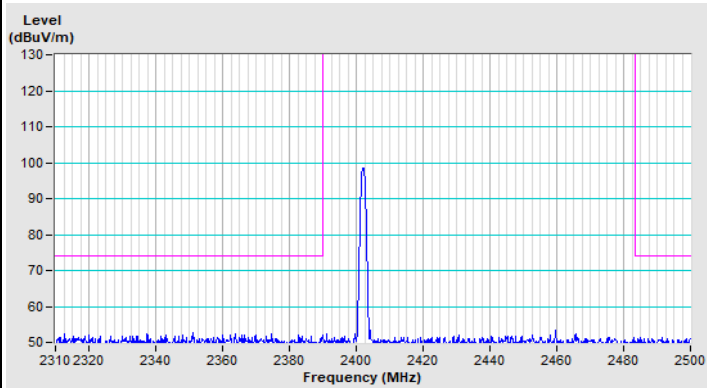

Vertical (Peak)

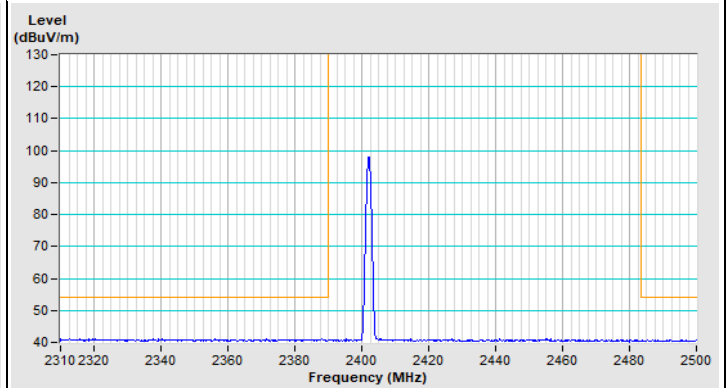

Vertical (Average)

BT GFSK Channel 78

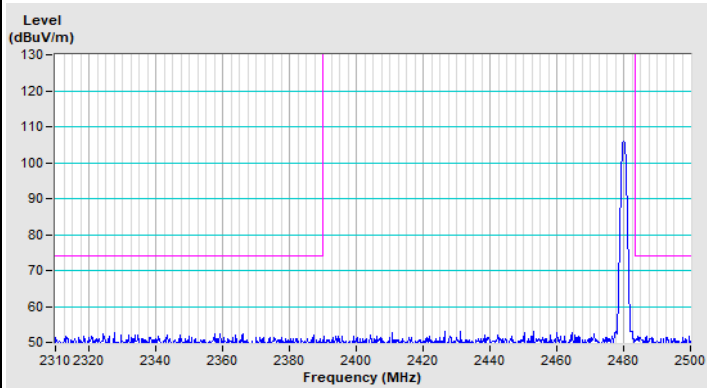

Horizontal (Peak)

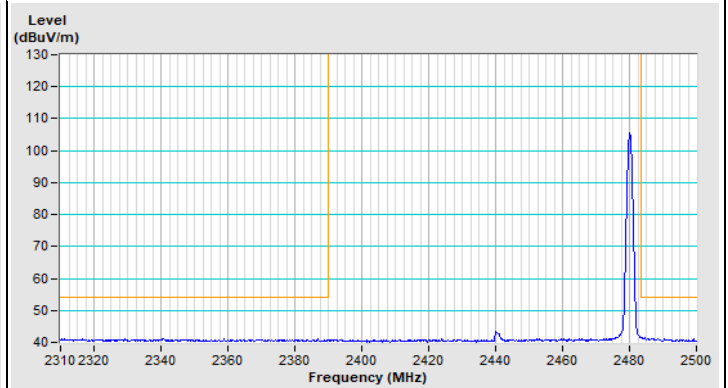

Horizontal (Average)

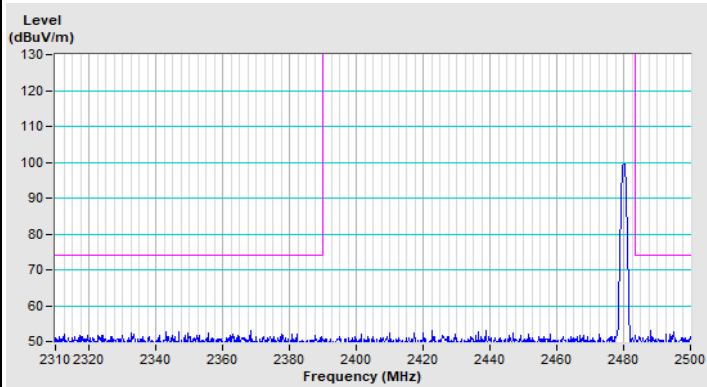

Vertical (Peak)

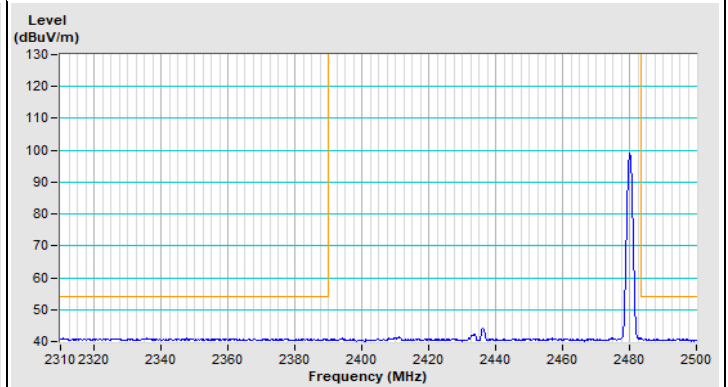

Vertical (Average)

BT 8DPSK Channel 0

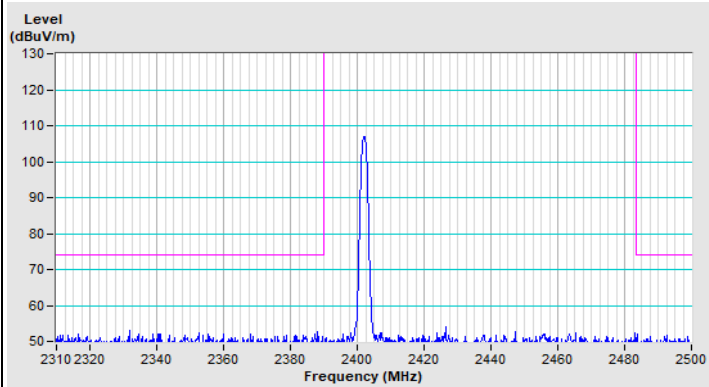

Horizontal (Peak)

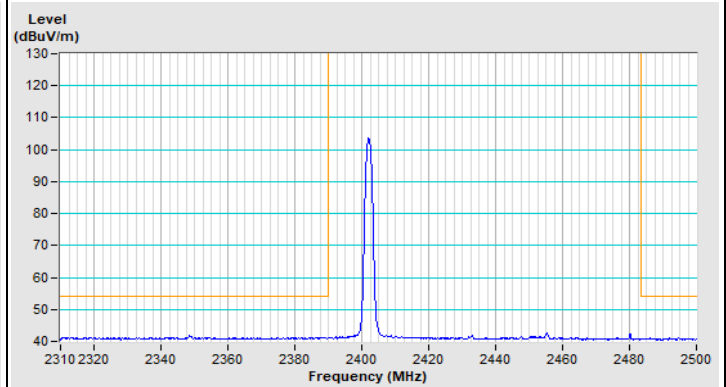

Horizontal (Average)

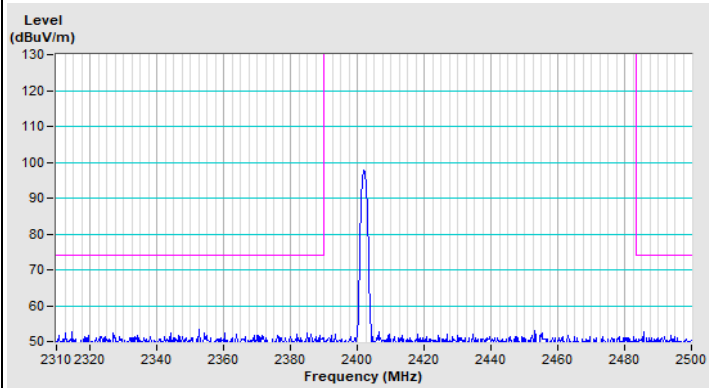

Vertical (Peak)

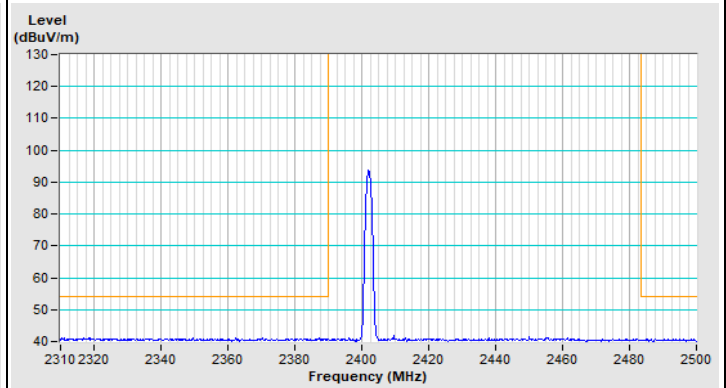

Vertical (Average)

BT 8DPSK Channel 78

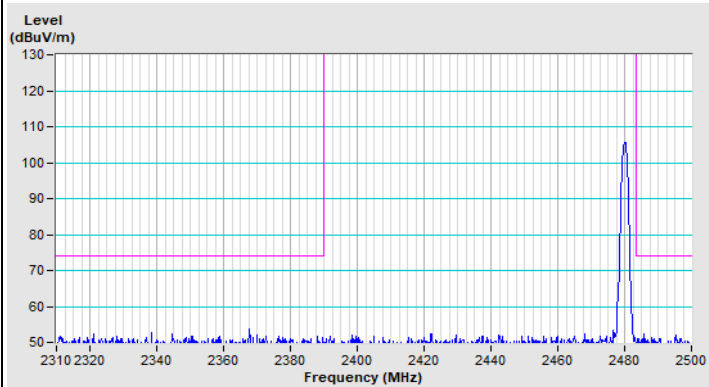

Horizontal (Peak)

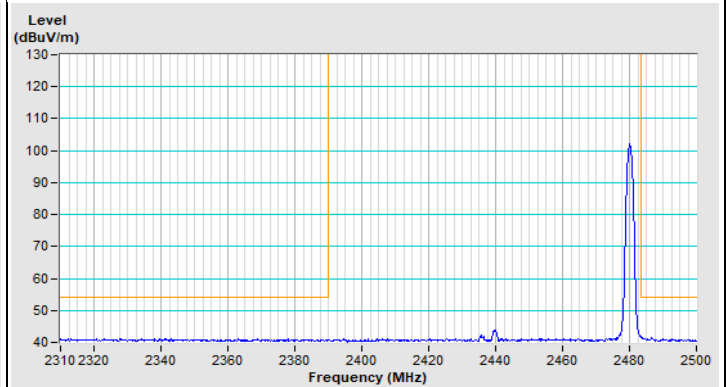

Horizontal (Average)

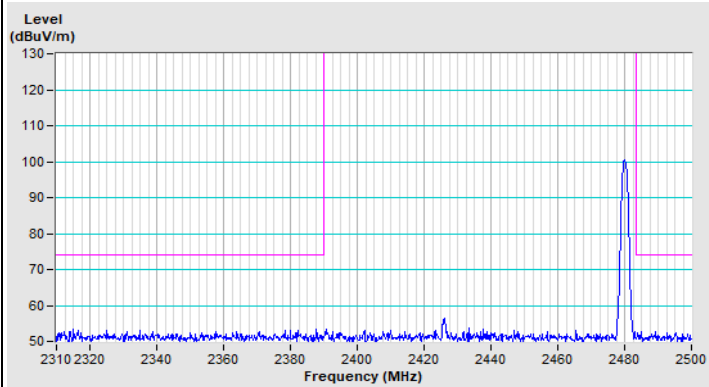

Vertical (Peak)

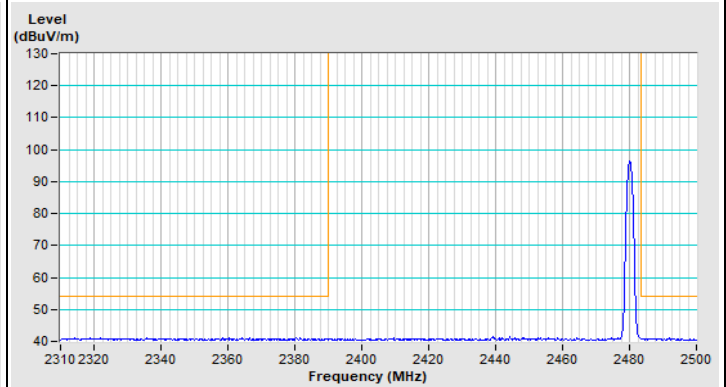

Vertical (Average)

8 Pictures of Test Arrangements

Please refer to the attached file (Test Setup Photo)

9 Information of the Testing Laboratories

We, Bureau Veritas Consumer Products Services (H.K.) Ltd., Taoyuan Branch, were founded in 1988 to provide our best service in EMC, Radio, Telecom and Safety consultation. Our laboratories are FCC recognized accredited test firms and accredited according to ISO/IEC 17025.

If you have any comments, please feel free to contact us at the following:

Lin Kou EMC/RF Lab

Tel: 886-2-26052180

Fax: 886-2-26051924

Hsin Chu EMC/RF/Telecom Lab

Tel: 886-3-6668565

Fax: 886-3-6668323

Hwa Ya EMC/RF/Safety Lab

Tel: 886-3-3183232

Fax: 886-3-3270892

Email: service.adt@bureauveritas.com

Web Site: <http://ee.bureauveritas.com.tw>

The address and road map of all our labs can be found in our web site also.

--- END ---