

# Lenovo YOGA 730

YOGA 730-13IKB | YOGA 730-15IKB

## User Guide



Read the safety notices and important tips in the included manuals before using your computer.

**Lenovo**<sup>™</sup>

## Notes

- Before using the product, be sure to read *Lenovo Safety and General Information Guide* first.
- The latest electronic compliance and environmental information are available from the Lenovo compliance information Web sites.
  - To view compliance information go to: <http://www.lenovo.com/compliance>
  - To download environmental information go to: <http://www.lenovo.com/ecodeclaration>
- Some instructions in this guide may assume that you are using Windows® 10. If you are using another Windows operating system, some operations may be slightly different. If you are using other operating systems, some operations may not apply to you.
- The features described in this guide are common to most models. Some features may not be available on your computer or your computer may include features that are not described in this user guide.
- The illustrations used in this manual are for Lenovo YOGA 730-15IKB unless otherwise stated.
- The illustrations in this manual may differ from the actual product. Please refer to the actual product.

## Regulatory Notice

- For details, refer to **Guides & Manuals** at <http://support.lenovo.com>.

**First Edition (December 2017)**

**© Copyright Lenovo 2017.**

**LIMITED AND RESTRICTED RIGHTS NOTICE:** If data or software is delivered pursuant to a General Services Administration "GSA" contract, use, reproduction, or disclosure is subject to restrictions set forth in Contract No. GS-35F-05925.

# Contents

<b>Chapter 1. Getting to know your computer .....</b>	<b>1</b>
Top view.....	1
Left-side view .....	10
Right-side view.....	13
Rear view.....	14
Bottom view.....	15
To use the Lenovo Active Pen2 (on select models).....	17
<b>Chapter 2. Starting to use Windows 10.....</b>	<b>19</b>
Configuring the operating system for the first time.....	19
Operating system interface.....	19
Putting the computer to sleep or shutting it down.....	21
Task and desktop management.....	23
Connecting to a wireless network.....	24
Touch screen operation.....	25
<b>Chapter 3. Recovery system .....</b>	<b>28</b>
Reset this PC.....	28
<b>Chapter 4. Troubleshooting.....</b>	<b>29</b>
Frequently asked questions.....	29
Troubleshooting.....	31
<b>Trademarks.....</b>	<b>34</b>



# Chapter 1. Getting to know your computer

## ■ ■ Top view

---

### ■ Lenovo YOGA 730-13IKB

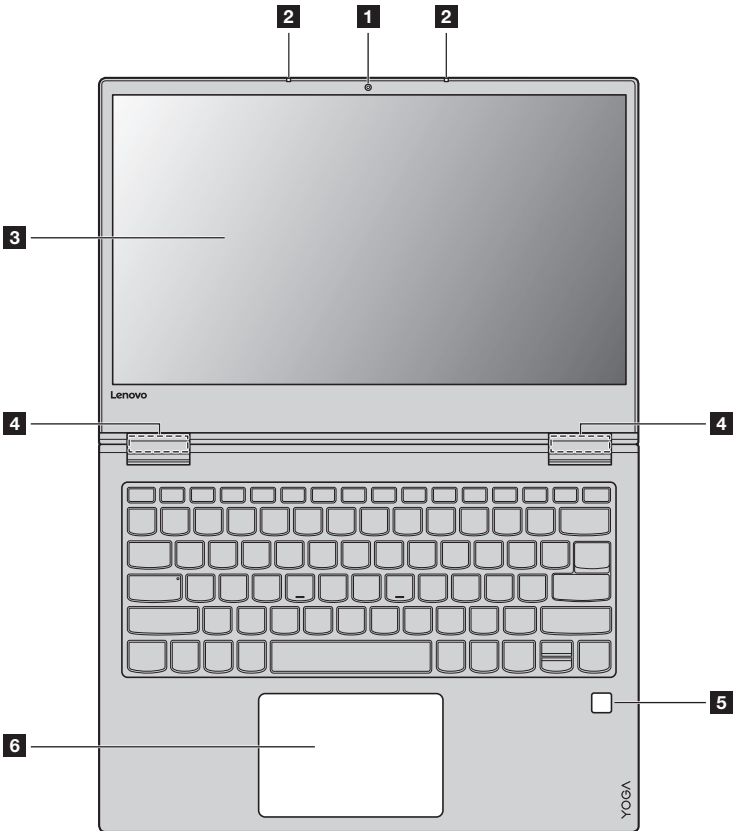

## Chapter 1. Getting to know your computer

### ■ Lenovo YOGA 730-15IKB

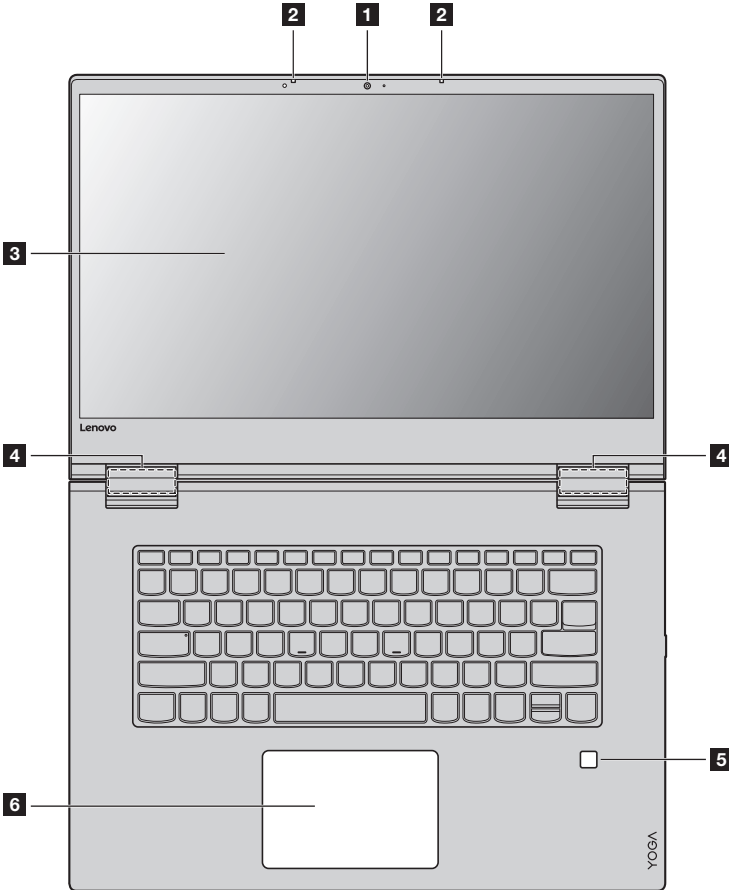

**Note:** The dashed areas indicate parts that are not visible externally.

#### ⓘ Attention:

- When closing the display panel, be careful *not* to leave pens or any other objects in between the display panel and the keyboard. Otherwise, the display panel may be damaged.

- 1 Integrated camera** Use the camera for video communication or taking photos.
- 2 Built-in microphone** Captures sound which can be used for video conferencing, voice narration, or audio recording.
- 3 Multi-touch screen** The LCD display with LED backlight provides brilliant visual output. Multi-touch function is available on this display.
- 4 Wireless LAN antennas** Connect to a wireless LAN adapter to send and receive wireless radio signals.
- 5 Fingerprint reader** Registers fingerprints that can be used as passwords to secure your computer.
- 6 Touchpad**

The touchpad functions as a conventional mouse.

**One piece multi-touch ClickPad:** To move the pointer on the screen, slide your fingertip over the pad in the direction in which you want the pointer to move.

**Left-click area:** Clicking in this area corresponds to the functions of clicking the left button on a conventional mouse.

**Right-click area:** Clicking in this area corresponds to the functions of clicking the right button on a conventional mouse.

**Note:** You can enable/disable the touchpad by pressing F6 (  ).

## Chapter 1. Getting to know your computer

### ■ Using the keyboard

#### Function key combinations

Through the use of the function keys, you can change operational features instantly. To use this function, press and hold **Fn** **1**; then press one of the function keys **2**.

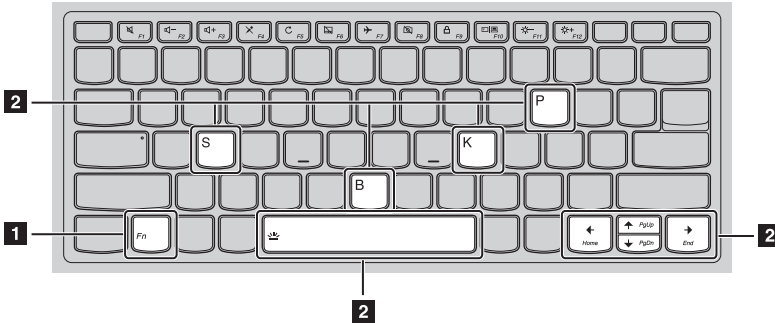

The following describes the features of each function key.









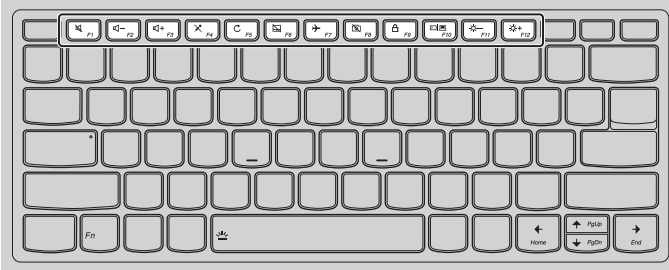



<b>Fn + B:</b>	Activates the break function.
<b>Fn + P:</b>	Activates the pause function.
<b>Fn + K:</b>	Enables/disables the scroll lock.
<b>Fn + S:</b>	Activates the system request.
<b>Fn + ↑:</b>	Activates the Pgup key function.
<b>Fn + ↓:</b>	Activates the Pgdn key function.
<b>Fn + ←:</b>	Activates the home key function.
<b>Fn + →:</b>	Activates the end key function.
<b>Fn + Space:</b>	Adjusts the keyboard backlight (off → dim → bright → off).



## Hotkeys

You can access certain system settings quickly by pressing the appropriate hotkeys.



	: Mutes/unmutes the sound.		: Enables/disables Airplane mode.
	: Decreases the volume level.		: Enables/disables the integrated camera.
	: Increases the volume level.		: Locks the screen.
	: Enables/disables the microphone.		: Toggles the display between the computer and an external display device.
	: Refreshes the desktop or the currently active window.		: Decreases the display brightness.
	: Enables/disables the touchpad.		: Increases the display brightness.

**Note:** You can use the Lenovo Setting to enable/disable the hotkey function.

## Chapter 1. Getting to know your computer

### ■ Positioning the display panel

The display panel can be opened to any angle up to 360 degrees.

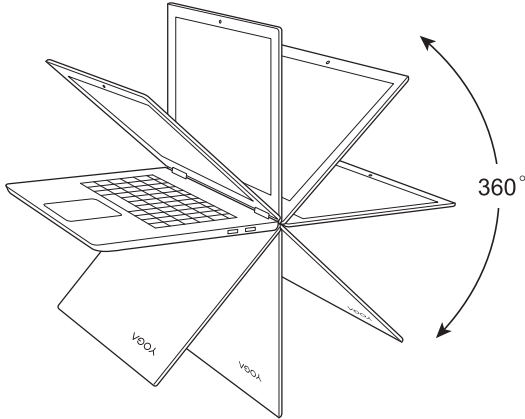

### Notebook Mode

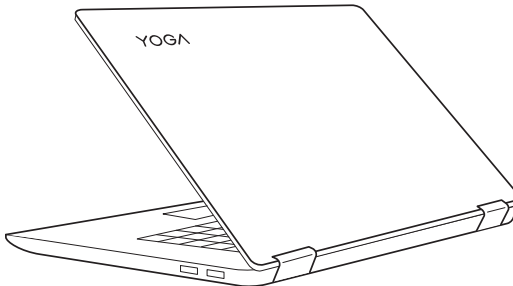

Suitable for tasks that require a keyboard and mouse (such as creating documents, writing e-mails, and so on).

**Stand Mode (Theater Mode)**

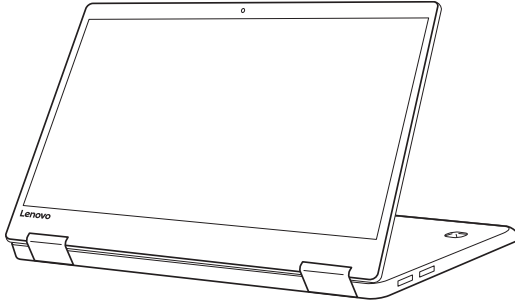

Suitable for tasks that require little or no touch (such as viewing photos or playing videos).

**Tablet Mode**

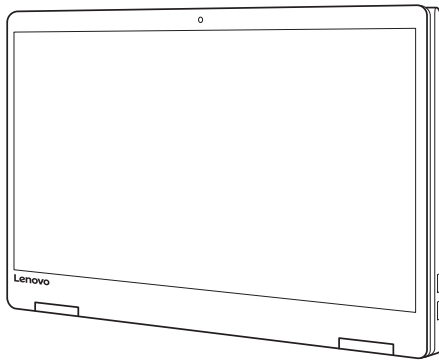

Suitable for tasks that require touching the screen often (such as surfing the Web, playing games, and so on).

## Chapter 1. Getting to know your computer

### Tent Mode (Presentation Mode)

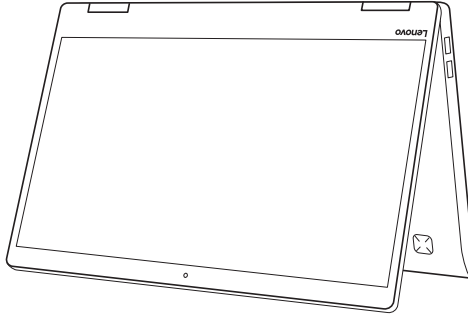

Suitable for tasks that require limited interaction with the touch screen (such as displaying graphs or PowerPoint presentations).

Ⓢ **Attention:**

- Do *not* open the display with too much force, otherwise the panel or hinges may be damaged.

**Note:** The keyboard and touchpad are automatically locked when the screen is opened beyond 190 degrees (approximately).

■ **Screen orientation**

You can rotate the display panel to your preferred orientation.

The orientation of the display automatically changes (alternating between portrait and landscape modes) depending on how you hold it.

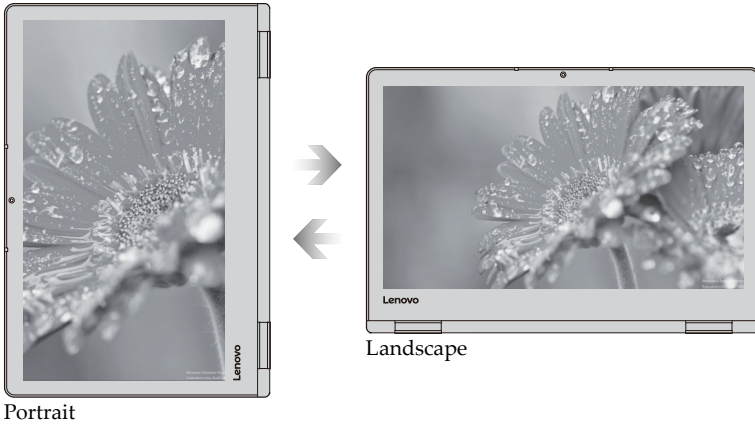

## Chapter 1. Getting to know your computer

### ■ ■ Left-side view

#### ■ Lenovo YOGA 730-13IKB

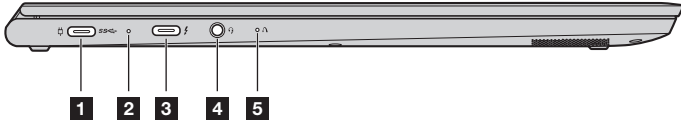

#### ■ Lenovo YOGA 730-15IKB

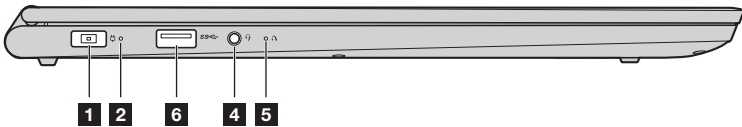

- 1 AC power adapter jack** Connects to the AC power adapter.

**Note:** For Lenovo YOGA 730-13IKB, the AC power adapter jack is compatible with Type-C USB 3.0 devices.

- 2 Battery status indicator**

Indicator	Indicator status	Charge status	Meaning
Battery status indicator	On (solid white)	Charging	The battery has more than 80% charge.
	On (solid amber)	Discharging	The battery has between 5% and 20% charge.
	Blinking slowly (white)	Charging	The battery has between 20% and 80% charge. When the battery reaches 80% charge, the light will stop blinking. However, charging will continue until the battery is fully charged.
	Blinking slowly (amber)	Charging	The battery has less than 20% charge. When the battery charge reaches 20%, the blinking color will change to white.
	Blinking quickly (amber)	Discharging	The battery has less than 5% charge.
	Off	Discharging	The battery has more than 20% charge.

**3 Type-C port** Type-C port is compatible with:

- Thunderbolt output

**4 Combo audio jack** Connects to headsets.

**Notes:**

- The combo audio jack does not support conventional microphones.
- The recording function might not be supported if third-party headphones or headsets are connected, due to different industry standards.

**5 Novo button** When the computer is off, press this button to start the recovery system or the BIOS setup utility, or to enter the boot menu.

**Notes:**

- You can use the tip of an unfolded paper clip (or similar object without a sharp tip) to gently press the Novo button.
- For details, see “Recovery system” on page 28.

**6 USB 3.0 port** Connects to USB devices.

**Note:** For details, see “Connecting USB device” on page 12.

## Chapter 1. Getting to know your computer

### ■ Connecting USB device

You can connect a USB device to your computer by inserting its USB plug (Type A/Type C) into the USB port on your computer.

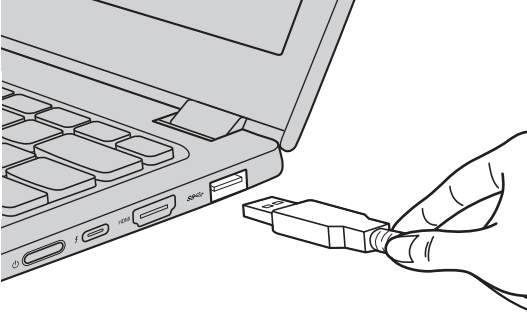

The first time you plug a USB device into a particular USB port on your computer, Windows automatically installs a driver for that device. After the driver has been installed, you can disconnect and reconnect the device without performing any additional steps.

**Note:** Typically, Windows detects a new device after it has been connected, and then installs the driver automatically. However, some devices may require you to install the driver before connecting. Check the documentation provided by the device's manufacturer before connecting the device.

Before disconnecting a USB storage device, make sure your computer has finished transferring data to that device. Click the **Safely Remove Hardware and Eject Media** icon in the Windows notification area to remove the device before disconnecting.

**Note:** If your USB device uses a power cord, connect the device to a power source before connecting it. Otherwise, the device may not be recognized.



## ■ ■ Right-side view

---

### ■ Lenovo YOGA 730-13IKB

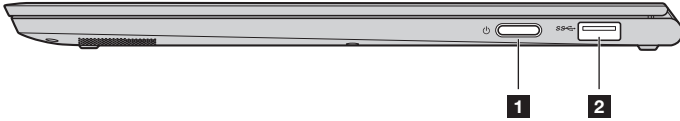

### ■ Lenovo YOGA 730-15IKB

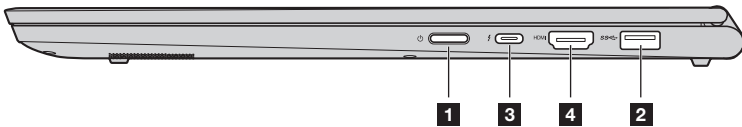

**1 Power button** Press this button to turn on the computer.

**2 USB 3.0 port** Connects to USB devices.

**Note:** For details, see “Connecting USB device” on page 12.

**3 Type-C port** Type-C port is compatible with:

- Thunderbolt output

**4 HDMI port** Connects to devices with HDMI input such as a TV or an external display.

■ ■ Rear view

---

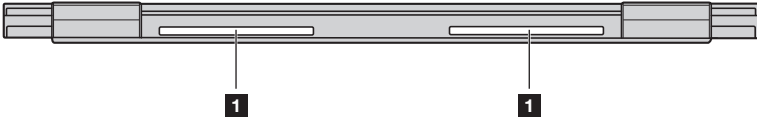

- 1** **Ventilation slots** Dissipate internal heat.

**Note:** Make sure that the ventilation slots are not blocked or else the computer may overheat.

■ ■ Bottom view

---

■ Lenovo YOGA 730-13IKB

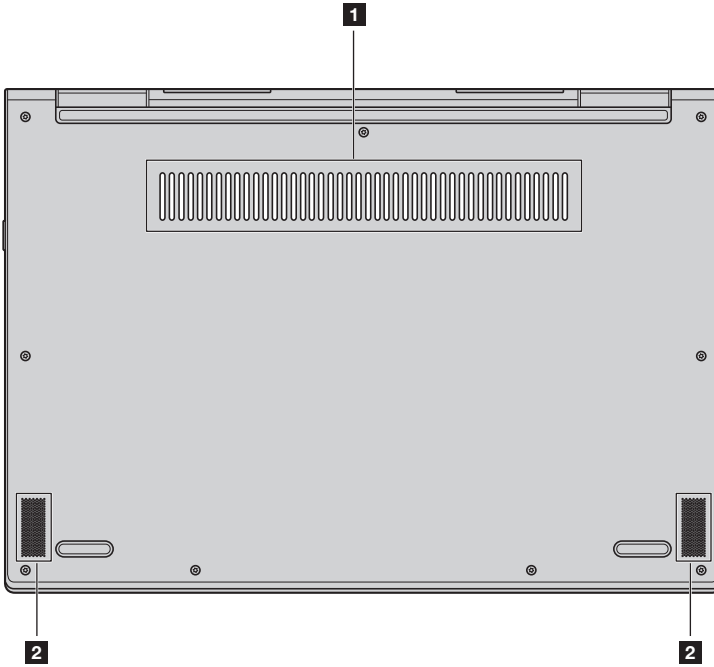

## Chapter 1. Getting to know your computer

### ■ Lenovo YOGA 730-15IKB

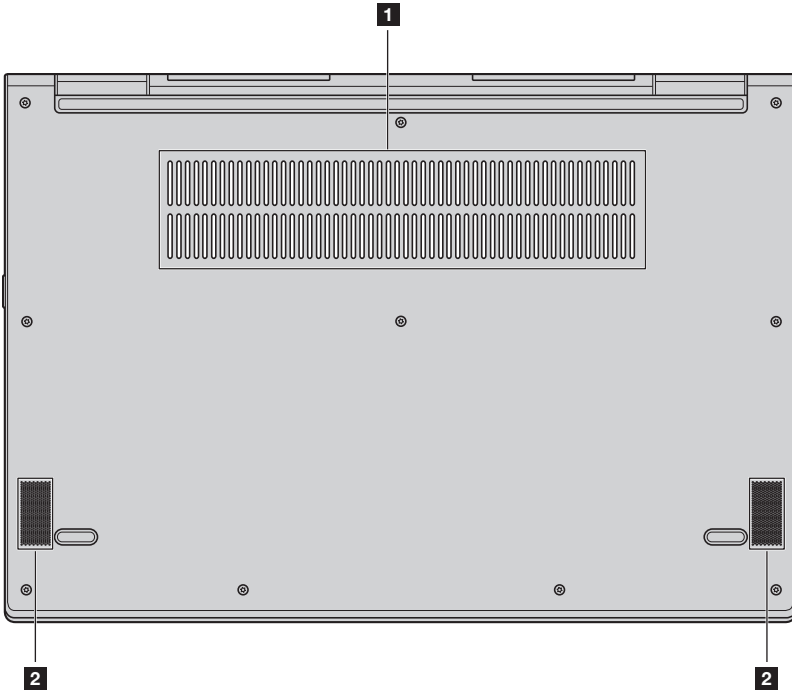

**1 Louvers**

Allow air to enter the computer for cooling.

**2 Speakers**

Provide audio output.

## ■ ■ To use the Lenovo Active Pen2 (on select models)

Select model is equipped with the Lenovo Active Pen2, to use it, refer to the following illustrations.

### Pairing

Press and hold the Bluetooth button for more than three seconds to enter pairing mode.

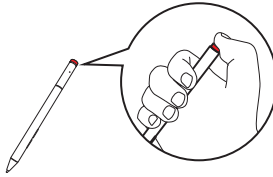

**Note:** Make sure to set the Bluetooth switch of your computer to On before pairing.

### Functions

#### Writing

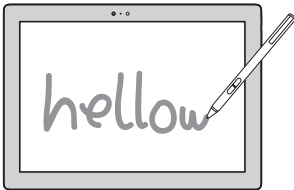

#### Displaying the function menu

Press and hold the upper button of the active pen when it approaches the display screen and the cursor appears.

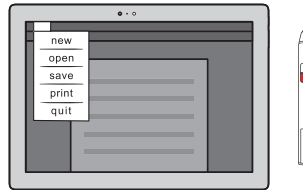

#### Right-clicking function

Press the upper button, then click on the touch screen.

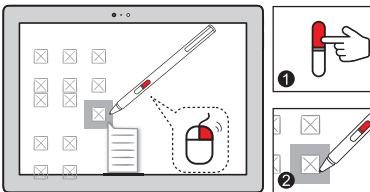

#### Erasing

Press the lower button when writing.

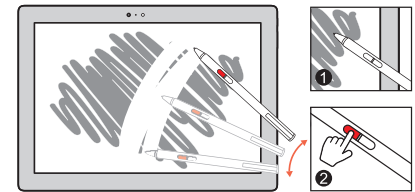

### Functions

#### One-click function of the Bluetooth button

Depends on the app preinstalled.



#### Double-click function of the Bluetooth button

Depends on the app preinstalled.



### To replace the battery

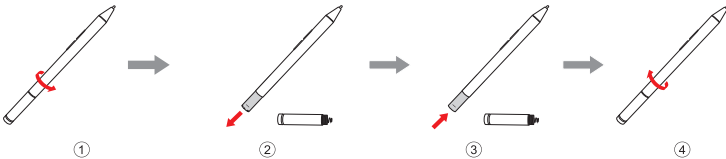

**Note:** Insert the battery by matching the + and - terminals on the battery to the + and - terminals in the battery compartment.

### To replace the rear Bluetooth module battery

When the battery is low, the red LED indicator will flash.

To replace the rear Bluetooth module battery:

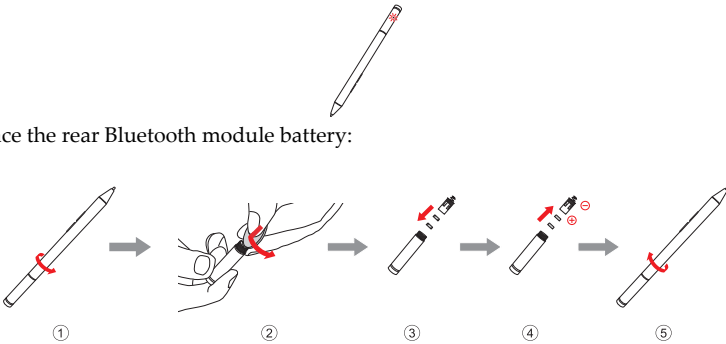

**Note:** Select the appropriate coin or screwdriver for removal.

## Chapter 2. Starting to use Windows 10

**Note:** Windows® 10 has an updated version. If you are using the updated version, some operations may be different. Please refer to the actual product.

### ■ ■ Configuring the operating system for the first time

You may need to configure the operating system when it is first used.



The configuration process may include the procedures below:

- Accepting the end user license agreement
- Configuring the Internet connection
- Registering the operating system
- Creating a user account

### ■ ■ Operating system interface

Windows 10 comes with a powerful and useful start menu.

To open the start menu, do one of the following:

- Press the Windows key  on the keyboard.
- Select **Start**  on the lower-left corner of the desktop.



**1** Settings button

**2** Power button

**3** Start button

**4** Search box

**5** Task view button

## Chapter 2. Starting to use Windows 10

### ■ Settings

**Settings** lets you perform basic tasks. You can also search for more settings with the settings search box in the upper-right corner.

To open the settings, do the following:

- Open the start menu, and then select **Settings** .

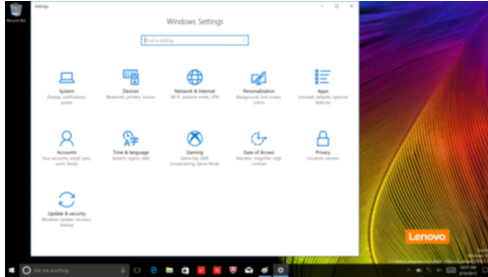

### ■ Personalize the start menu

You can personalize the start menu with your favorite apps.

To personalize the start menu, do the following:

- ① Open the start menu and find the apps list on the left.
- ② Right click the app you want to add to the start menu, and then select **Pin to Start**.

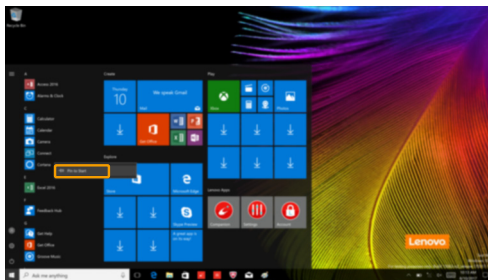

**Note:** You can also drag apps from the apps list to add them to the start menu.



## ■ ■ Putting the computer to sleep or shutting it down

When you have finished working with your computer, you can put it to sleep or shut it down.

### ■ Putting your computer to sleep

If you will be away from your computer for only a short time, put the computer to sleep. When the computer is in sleep mode, you can quickly wake it to resume use, bypassing the startup process.

To put the computer to sleep, do one of the following:

- Close the display lid.
- Press the Power button.
- Open the start menu, and then select **Power**  → **Sleep**.

**Note:** Wait until the power indicator light starts blinking (indicating that the computer is in sleep mode) before you move your computer. Moving your computer while the hard disk is spinning can damage the hard disk, causing loss of data.

To wake the computer, do one of the following:

- Press any key on the keyboard. (Notebook mode only)
- Press the Power button.

## Chapter 2. Starting to use Windows 10

### ■ Shutting down the computer

If you are not going to use your computer for a long time, shut it down. To shut down the computer, do one of the following:

- Open the start menu, and then select **Power**  → **Shut down**.



- Press and hold or right-click the **Start** button in the lower-left corner and select **Shut down** or **sign out** → **Shut down**.

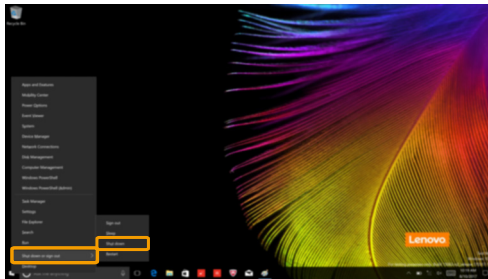



## ■ ■ Task and desktop management

---

### ■ Task view

To open the task view, do one of the following:

- Select the Task view button  on the task bar.
- Press the Windows key  + Tab.
- Swiping in from the left edge of the screen.

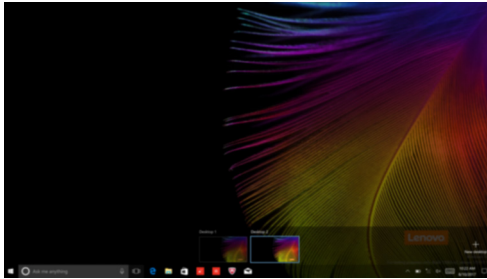



### ■ Virtual desktop management

Windows 10 supports the ability to create, manage and switch between virtual desktops.

To create a new virtual desktop, do one of the following:

- Open the task view, and then select **New desktop**.
- Press the Windows key  + Ctrl + D.



To switch between different desktops, do one of the following:

- Open the task view and select the desktop you want active.
- Press the Windows key  + Ctrl +  /  to scroll through the desktops you've created.

## ■ ■ Connecting to a wireless network

### Enabling wireless connection

To enable wireless functions, do the following:

- 1 Press F7 (  ) to disable airplane mode.
- 2 Click  on the lower-right corner of the task bar to open the network configuration page.

### Connecting to a wireless network

After wireless has been enabled, the computer will automatically scan for available wireless networks and display them in the wireless network list. To connect to a wireless network, click the network name in the list, and then click **Connect**.

**Note:** Some networks require a network security key or passphrase for connection. To connect to one of those networks, ask the network administrator or the Internet service provider (ISP) for the security key or passphrase.

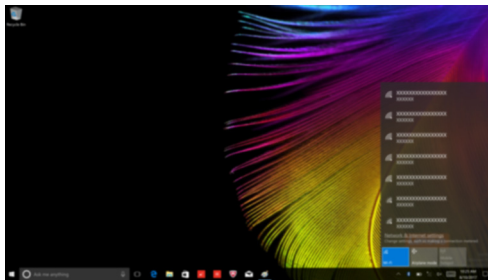

## ■ ■ Touch screen operation



The display panel can accept inputs like a tablet, using the multi-touch screen, or like a traditional notebook computer, using the keyboard and touchpad.

### ■ Multi-touch gestures

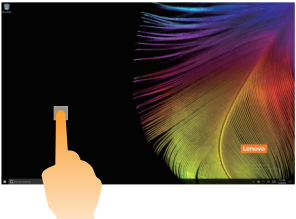
You can touch the screen with one or more fingertips to perform a variety of tasks.

Frequently used gestures	Tasks performed
<p><b>Tap</b> Tap once on an item.</p> 	<p>Performs an action, such as starting an app, opening a link, or performing a command. Similar to left-clicking with a mouse.</p>
<p><b>Press and hold</b> Press your finger down and leave it there for a moment.</p> 	<p>Enables you to see detailed information before selecting an action. Can also open a menu with more options. Similar to right-clicking with a mouse.</p>

(continued)

Frequently used gestures	Tasks performed
<p><b>Zoom</b> Move two fingers together or apart while touching the screen.</p> 	<p>Zooms in and out on visual apps, such as pictures and maps. Can also jump to the beginning or end of a list.</p>
<p><b>Rotate</b> Place two or more fingers on an item and then turn your hand.</p> 	<p>Rotates an object (Note: Not all items can be rotated, depending upon the app.).</p>
<p><b>Slide</b> Drag your finger across the screen.</p> 	<p>Pans or scrolls through lists and pages. Can also move an object or be used to draw or write, depending upon the app. Similar to pressing and holding to pan and to scrolling with a mouse.</p>

(continued)

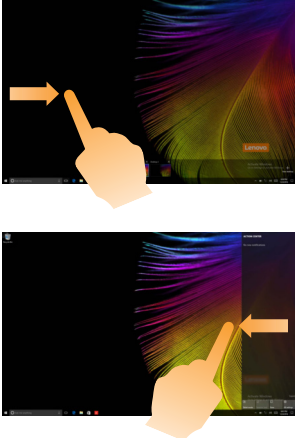
Frequently used gestures	Tasks performed
<p data-bbox="140 320 210 347"><b>Swipe</b></p> <p data-bbox="140 352 554 403">Start from left/right edge of the screen, then swipe inwards toward the center.</p> 	<p data-bbox="610 408 1013 459">Swiping in from the left edge of the screen can open the task view.</p> <p data-bbox="610 639 1024 691">Swiping in from the right edge of the screen displays the action center.</p>

# Chapter 3. Recovery system

## ■ ■ Reset this PC

---

### ■ Introduction

**Reset this PC** is a built-in recovery tool that enables users to restore their operating system to its original state. This preserves their data and important customizations, without the need to back up their data in advance.

The following **Reset this PC** features are available to users from multiple locations within Windows:

#### **Keep my files**

Fixes software problems by reinstalling the factory default configuration. This preserves personal files, and deletes apps and settings.

#### **Remove everything**

Prepares the computer for recycling or transfer of ownership. This reinstalls the factory default configuration and returns all user data and applications to the state of their original Out-of-Box Experience (OOBE).

### ■ Using Reset this PC

**Reset this PC** can be launched using one of the following methods:

- Novo Menu:
  - Shut down the computer and wait at least five seconds. Press the Novo button to open the Novo Menu, then select **System Recovery** → **Troubleshoot** → **Reset this PC**.
- Windows PC settings:
  - Windows PC settings → **Update & security** → **Recovery** → **Reset this PC** → select **Get started**.

For more instructions, see the Windows Help and Support file on your computer.



## Chapter 4. Troubleshooting

### ■ ■ Frequently asked questions

---

This section lists frequently asked questions by category.

#### ■ Finding information

##### What safety precautions should I follow when using my computer?

Read and follow all safety precautions included in *Lenovo Safety and General Information Guide*.

**Note:** To view *Lenovo Safety and General Information Guide*, select the **Companion** (or **Lenovo PC Manager**) icon on the taskbar. You can also download it from the Lenovo Support Web site.

##### What is the address of the Lenovo support Web site?

<http://support.lenovo.com>

##### Where can I find warranty information?

Visit the Lenovo Support Web site and type the serial number for your computer to look up warranty information.

#### ■ Lenovo preinstalled operating system and software

##### What is the Lenovo preinstalled operating system?

Some Lenovo computers come with copies of the operating system installed at factory. Lenovo provides computers with a preinstalled operating system for your convenience. If you purchased such a computer, you can use your computer out of the box and do not need to install a separate operating system.

##### What is Lenovo preinstalled software?

This is software (developed by Lenovo or other software vendors) installed and licensed at the factory for your convenience. The license for some preinstalled software may be for trial versions. When the trial period expires, you may need to purchase a license if you want to continue to use the software.

**Note:** If a license agreement is displayed when you first start the software, read the agreement carefully. If you don't accept the terms of the agreement, do not use the software.

##### When I purchased my computer, it included a copy of Windows. How can I determine whether the copy of Windows is preinstalled by Lenovo?

On the outside of the sales package of your computer, you should find a label containing configuration information for your computer. Check the printed string next to **OS**. If it contains **Windows** or **WIN**, the copy of Windows was preinstalled by Lenovo.

##### I uninstalled a preinstalled software, but there is no significant increase in the free drive space.

The copy of Windows running on your computer may be Compact-enabled. For computers with Compact-enabled Windows, the majority of files needed for preinstalled software are installed on the Recovery Partition and won't be deleted through normal uninstallation.

## Chapter 4. Troubleshooting

### How can I determine whether the Windows running on my computer is Compact enabled?

Compact technology is normally enabled on copies of Windows 10 Update running on SSD (or eMMC) -only computer models. To check your computer,

- 1 Right-click the Start button in the lower-left corner and select **Disk Management**.
- 2 The Disk Management program starts.

If **Compact** is labeled on the Windows partition, Compact is enabled on your copy of Windows.

### Where can I find drivers for the various hardware devices of my computer?

If your computer is preinstalled with a Windows operating system, first check the installation program on the C partition of your hard disk (for select models, on the D partition). If you cannot find the drivers for all the hardware devices that you need there, download the drivers from the Lenovo consumer support website.

**Note:** The Lenovo support Web site contains the latest drivers.

## ■ BIOS setup utility

### What is the BIOS setup utility?

The BIOS setup utility is ROM-based software. It communicates basic computer information and provides options for setting boot devices, security, hardware mode, and other preferences.

### How can I start the BIOS setup utility?

To start the BIOS setup utility:

- 1 Shut down the computer.
- 2 Press the Novo button and then select **BIOS Setup**.

### How can I change the boot mode? (on select models)

There are two boot modes: **UEFI First** and **Legacy Support**. To change the boot mode, start the BIOS setup utility and set boot mode to **UEFI First** or **Legacy Support** on the boot menu.

### When do I need to change the boot mode? (on select models)

The default boot mode for your computer is **UEFI First** mode. If you need to install a legacy Windows operating system on your computer, you must change the boot mode to **Legacy Support**. The legacy Windows operating system cannot be installed if you don't change the boot mode.

## ■ Getting help

### How can I contact the customer support center?

See "Chapter 3. Getting help and service" of Lenovo *Safety and General Information Guide*.

## ■ ■ Troubleshooting

### Display problems

When I turn on the computer, nothing appears on the screen.

- If the screen is blank, make sure that:
  - The AC power adapter is connected to the computer, and plugged into a working electrical outlet.
  - The computer power is on. Press the Power button again for confirmation.
- If these items are properly set, and the screen remains blank, have the computer serviced.

When I turn on the computer, only a white cursor appears on a blank screen.

- Restore backed-up files to your Windows environment or the entire contents of your hard disk to its original factory contents using the Reset this PC. If you still see only the cursor on the screen, have the computer serviced.

The screen goes blank while the computer is on.

- Your screen saver or power management may be enabled. Do one of the following to resume from sleep mode:
  - Press any key on the keyboard. (Notebook mode only)
  - Press the Power button.

### Sleep problems

The critical low-battery error message appears, and the computer immediately turns off.

- The battery power is getting low. Connect the AC power adapter to the computer.

The computer enters sleep mode immediately after Power-on self-test (POST).

- Make sure that:
  - The battery pack is charged.
  - The operating temperature is within the acceptable range. See “Chapter 2. Use and care Information” in the *Lenovo Safety and General Information Guide*.

**Note:** If the battery pack is charged and the temperature is within range, have the computer serviced.

The computer does not return from sleep mode, and the computer does not work.

- If your computer is in sleep mode, connect the AC power adapter to the computer, then press the Power button.
- If the system still does not return from sleep mode, stops responding, or cannot be turned off, reset the computer. Unsaved data may be lost. To reset the computer, press and hold the Power button for eight seconds or more. If the computer is still not reset, remove the AC power adapter.

## Chapter 4. Troubleshooting

### Display panel problems

The screen is blank.

- Do the following:
  - If you are using the AC power adapter or the battery pack, and the battery status indicator is on, press **F12** (  ) to make the screen brighter.
  - If the power indicator is blinking, press the Power button to resume from sleep mode.
  - If the problem persists, follow the solution in the next problem "The screen is unreadable or distorted."

The screen is unreadable or distorted.

- Make sure that:
  - The screen resolution and color quality are correctly set.
  - The monitor type is correct.

Incorrect characters appear on the screen.

- Is the operating system or programs installed correctly? If they are installed and configured correctly, have the computer serviced.

### Sound problems

No sound can be heard from the speakers even when the volume is turned up.

- Make sure that:
  - The Mute function is off.
  - The combo audio jack is not being used.
  - Speakers are selected as the playback device.

### Battery pack problems

Your computer shuts down before the battery status indicator shows empty.

*-or-*

Your computer operates after the battery status indicator shows empty.

- Recharge the battery.

### Other problems

Your computer does not respond.

- To turn off your computer, press and hold the Power button for eight seconds or more. If the computer still does not respond, remove the AC power adapter.
- Your computer might lock when it enters sleep mode during a communication operation. Disable the sleep timer when you are working on the network.

The connected external device does not work.

- Do *not* connect or disconnect any external device cables other than USB while the computer power is on. Otherwise, you might damage your computer.
- When using high power consumption external devices such as an external USB optical disk drive, use an external device power adapter. Otherwise, the device may not be recognized, or the system may shut down as a result.

## Trademarks

Lenovo is a trademark or registered trademark of Lenovo in the United States, other countries, or both.

Microsoft and Windows are trademarks of Microsoft Corporation in the United States, other countries, or both.

Other company, products, or service names may be trademarks or service marks of others.

