



# FCC TEST REPORT

**REPORT NO.:** RF970815A04

**MODEL NO.:** PZ310

**RECEIVED:** Aug. 5, 2008

**TESTED:** Aug. 5 ~19, 2008

**ISSUED:** Aug. 29, 2008

**APPLICANT:** Hon Hai Precision Ind. Co., Ltd. Nei-Hu Branch Office

**ADDRESS:** No.32, Ji-Hu Road, Nei-Hu, Taipei 114, Taiwan, R.O.C.

**ISSUED BY:** Advance Data Technology Corporation

**LAB LOCATION:** No. 47, 14<sup>th</sup> Ling, Chia Pau Tsuen, Lin Kou Hsiang 244, Taipei Hsien, Taiwan, R.O.C.

This test report consists of 70 pages in total. It may be duplicated completely for legal use with the approval of the applicant. It should not be reproduced except in full, without the written approval of our laboratory. The client should not use it to claim product endorsement by TAF or any government agencies. The test results in the report only apply to the tested sample.





## TABLE OF CONTENTS

1.	CERTIFICATION .....	4
2.	SUMMARY OF TEST RESULTS .....	5
2.1	MEASUREMENT UNCERTAINTY .....	6
3.	GENERAL INFORMATION .....	7
3.1	GENERAL DESCRIPTION OF EUT .....	7
3.2	DESCRIPTION OF TEST MODES .....	8
3.2.1	CONFIGURATION OF SYSTEM UNDER TEST .....	9
3.2.2	TEST MODE APPLICABILITY AND TESTED CHANNEL DETAIL .....	10
3.2.3	GENERAL DESCRIPTION OF APPLIED STANDARDS .....	12
3.2.4	DESCRIPTION OF SUPPORT UNITS .....	12
4.	TEST TYPES AND RESULTS .....	13
4.1	CONDUCTED EMISSION MEASUREMENT .....	13
4.1.1	LIMITS OF CONDUCTED EMISSION MEASUREMENT .....	13
4.1.2	TEST INSTRUMENTS .....	13
4.1.3	TEST PROCEDURES .....	14
4.1.4	DEVIATION FROM TEST STANDARD .....	14
4.1.5	TEST SETUP .....	14
4.1.6	EUT OPERATING CONDITIONS .....	14
4.1.7	TEST RESULTS .....	15
4.2	RADIATED EMISSION MEASUREMENT .....	17
4.2.1	LIMITS OF RADIATED EMISSION MEASUREMENT .....	17
4.2.2	TEST INSTRUMENTS .....	18
4.2.3	TEST PROCEDURES .....	19
4.2.4	DEVIATION FROM TEST STANDARD .....	19
4.2.5	TEST SETUP .....	20
4.2.6	EUT OPERATING CONDITIONS .....	20
4.2.7	TEST RESULTS .....	21
4.3	NUMBER OF HOPPING FREQUENCY USED .....	29
4.3.1	LIMIT OF HOPPING FREQUENCY USED .....	29
4.3.2	TEST INSTRUMENTS .....	29
4.3.3	TEST PROCEDURES .....	29
4.3.4	DEVIATION FROM TEST STANDARD .....	30
4.3.5	TEST SETUP .....	30
4.3.6	TEST RESULTS .....	30
4.4	DWELL TIME ON EACH CHANNEL .....	33
4.4.1	LIMIT OF DWELL TIME USED .....	33
4.4.2	TEST INSTRUMENTS .....	33
4.4.3	TEST PROCEDURES .....	33
4.4.4	DEVIATION FROM TEST STANDARD .....	33
4.4.5	TEST SETUP .....	34
4.4.6	TEST RESULTS .....	34
4.5	CHANNEL BANDWIDTH .....	39
4.5.1	LIMITS OF CHANNEL BANDWIDTH .....	42
4.5.2	TEST INSTRUMENTS .....	42
4.5.3	TEST PROCEDURE .....	42
4.5.4	DEVIATION FROM TEST STANDARD .....	43



4.5.5	TEST SETUP .....	43
4.5.6	EUT OPERATING CONDITION .....	43
4.5.7	TEST RESULTS.....	44
4.6	HOPPING CHANNEL SEPARATION .....	48
4.6.1	LIMIT OF HOPPING CHANNEL SEPARATION .....	48
4.6.2	TEST INSTRUMENTS .....	48
4.6.3	TEST PROCEDURES.....	48
4.6.4	DEVIATION FROM TEST STANDARD .....	49
4.6.5	TEST SETUP .....	49
4.6.6	TEST RESULTS.....	49
4.7	MAXIMUM PEAK OUTPUT POWER .....	54
4.7.1	LIMITS OF MAXIMUM PEAK OUTPUT POWER MEASUREMENT .....	54
4.7.2	TEST INSTRUMENTS .....	54
4.7.3	TEST PROCEDURES.....	54
4.7.4	DEVIATION FROM TEST STANDARD .....	54
4.7.5	TEST SETUP .....	55
4.7.6	EUT OPERATING CONDITION .....	55
4.7.7	TEST RESULTS.....	55
4.8	BAND EDGES MEASUREMENT .....	60
4.8.1	LIMITS OF BAND EDGES MEASUREMENT .....	60
4.8.2	TEST INSTRUMENTS .....	60
4.8.3	TEST PROCEDURE .....	60
4.8.4	DEVIATION FROM TEST STANDARD .....	60
4.8.5	EUT OPERATING CONDITION .....	60
4.8.6	TEST RESULTS.....	61
4.9	ANTENNA REQUIREMENT .....	67
4.9.1	STANDARD APPLICABLE .....	67
4.9.2	ANTENNA CONNECTED CONSTRUCTION .....	67
5.	PHOTOGRAPHS OF THE TEST CONFIGURATION.....	68
6.	INFORMATION ON THE TESTING LABORATORIES .....	69
7.	APPENDIX A – MODIFICATIONS RECORDERS FOR ENGINEERING CHANGES TO THE EUT BY THE LAB .....	70



## 1. CERTIFICATION

**PRODUCT:** Z Printer  
**BRAND NAME:** DELL  
**MODEL NO.:** PZ310  
**APPLICANT:** Hon Hai Precision Ind. Co., Ltd. Nei-Hu Branch Office  
**TESTED:** Aug. 5 ~19, 2008  
**TEST SAMPLE:** ENGINEERING SAMPLE  
**STANDARDS:** FCC Part 15, Subpart C (Section 15.247),  
ANSI C63.4-2003

The above equipment has been tested by **Advance Data Technology Corporation**, and found compliance with the requirement of the above standards. The test record, data evaluation & Equipment Under Test (EUT) configurations represented herein are true and accurate accounts of the measurements of the sample's EMC characteristics under the conditions specified in this report.

**PREPARED BY** :           *Jessica Cheng*           , **DATE:**           Aug. 29, 2008            
( Jessica Cheng / Specialist )

**TECHNICAL ACCEPTANCE** :           *Jamison Chan*           , **DATE:**           Aug. 29, 2008            
Responsible for RF (Jamison Chan / Supervisor)

**APPROVED BY** :           *Ken Liu*           , **DATE:**           Aug. 29, 2008            
( Ken Liu / Deputy Manager )

## 2. SUMMARY OF TEST RESULTS

The EUT has been tested according to the following specifications:

APPLIED STANDARD: FCC Part 15, Subpart C			
STANDARD SECTION	TEST TYPE AND LIMIT	RESULT	REMARK
15.207	AC Power Conducted Emission	PASS	Meet the requirement of limit. Minimum passing margin is -19.86dB at 0.178MHz.
15.247(a)(1)(iii)	Number of Hopping Frequency Used Spec.: At least 15 channels	PASS	Meet the requirement of limit.
15.247(a)(1)(iii)	Dwell Time on Each Channel Spec. : Max. 0.4 second within 31.6 second	PASS	Meet the requirement of limit.
15.247(a)(1)	1. Hopping Channel Separation Spec. : Min. 25 kHz or 20 dB bandwidth, whichever is greater (see Note) 2. Spectrum Bandwidth of a Frequency Hopping Sequence Spread Spectrum System	PASS	Meet the requirement of limit.
15.247(b)	Maximum Peak Output Power Spec.: max. 21dBm (see Note)	PASS	Meet the requirement of limit.
15.247(d)	Transmitter Radiated Emissions Spec.: Table 15.209	PASS	Meet the requirement of limit. Minimum passing margin is -8.94dB at 274.930MHz.
15.247(d)	Band Edge Measurement	PASS	Meet the requirement of limit.

**NOTE:** If The Frequency Hopping System operating in 2400-2483.5MHz band and the output power less than 125mW. The hopping channel carrier frequencies separated by a minimum of 25kHz or two-thirds of the 20dB bandwidth of hopping channel whichever is greater.

## 2.1 MEASUREMENT UNCERTAINTY

Where relevant, the following measurement uncertainty levels have been estimated for tests performed on the EUT as specified in CISPR 16-4-2:

This uncertainty represents an expanded uncertainty expressed at approximately the 95% confidence level using a coverage factor of  $k=2$ .

MEASUREMENT	FREQUENCY	UNCERTAINTY
Conducted emissions	9kHz ~ 30MHz	2.44 dB
Radiated emissions	30MHz ~ 1GHz	3.72 dB
	1GHz ~ 40GHz	2.89 dB

### 3. GENERAL INFORMATION

#### 3.1 GENERAL DESCRIPTION OF EUT

<b>PRODUCT</b>	Z Printer
<b>MODEL NO.</b>	PZ310
<b>FCC ID</b>	TVRDELLPZ310
<b>POWER SUPPLY</b>	7.4Vdc from battery, 9Vdc from AC adapter
<b>MODULATION TYPE</b>	GFSK, $\pi/4$ -DQPSK, 8DPSK
<b>RADIO TECHNOLOGY</b>	FHSS
<b>TRANSFER RATE</b>	1/2/3Mbps
<b>OPERATING FREQUENCY</b>	2402 ~ 2480MHz
<b>NUMBER OF CHANNEL</b>	79
<b>OUTPUT POWER</b>	0.411mW
<b>ANTENNA TYPE</b>	Chip antenna with -2.10dBi gain
<b>DATA CABLE</b>	1.8 m USB cable
<b>I/O PORTS</b>	N/A

#### NOTE:

1. The EUT is a Z Printer, with Bluetooth technology.
2. The EUT was power supplied from the following power adapter and battery:

Item	Brand	Model	Rating
Adapter	Sunny	SYS1319-2709	AC I/P: 100-240V, 50-60Hz, 1.0A DC O/P: 9V, 3.0A Non-shielded DC (1.8m) with one core. AC 2-pin
Battery	-	-	7.4Vdc

3. The above EUT information was declared by the manufacturer and for more detailed features description, please refer to the manufacturer's specifications or User's Manual.

### 3.2 DESCRIPTION OF TEST MODES

79 channels are provided to this EUT:

CHANNEL	FREQ. (MHz)	CHANNEL	FREQ. (MHz)	CHANNEL	FREQ. (MHz)	CHANNEL	FREQ. (MHz)
0	2402	20	2422	40	2442	60	2462
1	2403	21	2423	41	2443	61	2463
2	2404	22	2424	42	2444	62	2464
3	2405	23	2425	43	2445	63	2465
4	2406	24	2426	44	2446	64	2466
5	2407	25	2427	45	2447	65	2467
6	2408	26	2428	46	2448	66	2468
7	2409	27	2429	47	2449	67	2469
8	2410	28	2430	48	2450	68	2470
9	2411	29	2431	49	2451	69	2471
10	2412	30	2432	50	2452	70	2472
11	2413	31	2433	51	2453	71	2473
12	2414	32	2434	52	2454	72	2474
13	2415	33	2435	53	2455	73	2475
14	2416	34	2436	54	2456	74	2476
15	2417	35	2437	55	2457	75	2477
16	2418	36	2438	56	2458	76	2478
17	2419	37	2439	57	2459	77	2479
18	2420	38	2440	58	2460	78	2480
19	2421	39	2441	59	2461		



### 3.2.1 CONFIGURATION OF SYSTEM UNDER TEST

#### FOR MODE A:

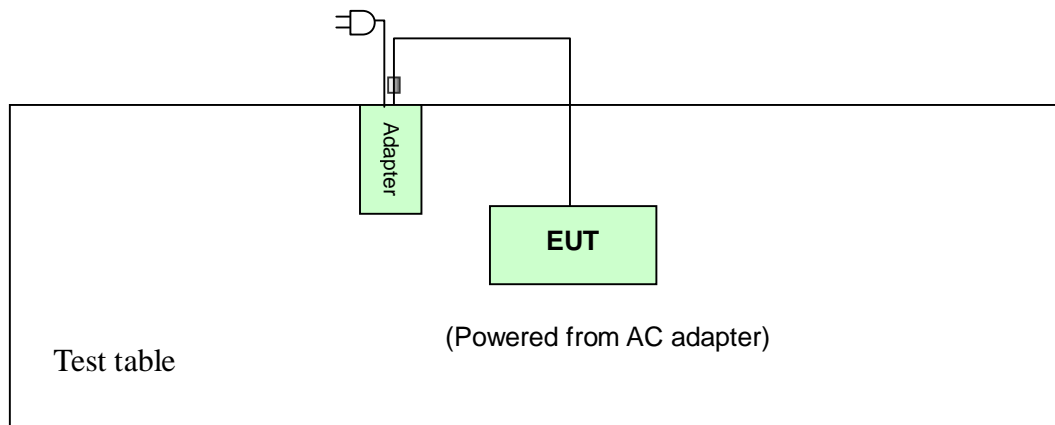

#### FOR MODE B:

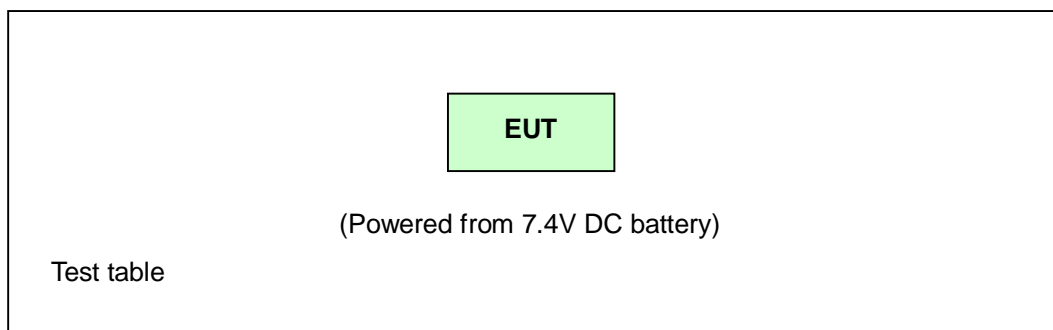



### 3.2.2 TEST MODE APPLICABILITY AND TESTED CHANNEL DETAIL

EUT CONFIGURE MODE	Applicable to				Description
	PLC	RE<1G	RE <sup>≥</sup> 1G	APCM	
A	√	√	√	√	Operating Mode (EUT with adapter)
B	Note	√	-	-	Operating Mode (EUT only)

Where **PLC**: Power Line Conducted Emission      **RE<1G**: Radiated Emission below 1GHz  
**RE<sup>≥</sup>1G**: Radiated Emission above 1GHz      **APCM**: Antenna Port Conducted Measurement  
**Note**: No need to concern of Conducted Emission due to the EUT is powered by battery.  
 "-" means no effect.

#### **POWER LINE CONDUCTED EMISSION TEST:**

- Pre-Scan has been conducted to determine the worst-case mode from all possible combinations between available modulations and packet types.
- Following channel(s) was (were) selected for the final test as listed below.

EUT CONFIGURE MODE	AVAILABLE CHANNEL	TESTED CHANNEL	MODULATION TECHNOLOGY	MODULATION TYPE	PACKET TYPE	DATE RATE
A	0 to 78	0	FHSS	GFSK	DH5	1

#### **RADIATED EMISSION TEST (BELOW 1 GHz):**

- Pre-Scan has been conducted to determine the worst-case mode from all possible combinations between available modulations, data rates and antenna ports (if EUT with antenna diversity architecture).
- Following channel(s) was (were) selected for the final test as listed below.

EUT CONFIGURE MODE	AVAILABLE CHANNEL	TESTED CHANNEL	MODULATION TECHNOLOGY	MODULATION TYPE	PACKET TYPE	DATE RATE
A	0 to 78	0	FHSS	GFSK	DH5	1
B	0 to 78	0	FHSS	GFSK	DH5	1



**RADIATED EMISSION TEST (ABOVE 1 GHz):**

- Pre-Scan has been conducted to determine the worst-case mode from all possible combinations between available modulations, data rates and antenna ports (if EUT with antenna diversity architecture).
- Following channel(s) was (were) selected for the final test as listed below.

EUT CONFIGURE MODE	AVAILABLE CHANNEL	TESTED CHANNEL	MODULATION TECHNOLOGY	MODULATION TYPE	PACKET TYPE	DATE RATE
A	0 to 78	0, 39, 78	FHSS	GFSK	DH5	1
A	0 to 78	0, 39, 78	FHSS	8DPSK	DH5	3

**BANDEDGE MEASUREMENT:**

- Pre-Scan has been conducted to determine the worst-case mode from all possible combinations between available modulations and packet types of the antenna and antenna ports (if EUT with antenna diversity architecture).
- Following channel(s) was (were) selected for the final test as listed below.

EUT CONFIGURE MODE	AVAILABLE CHANNEL	TESTED CHANNEL	MODULATION TECHNOLOGY	MODULATION TYPE	PACKET TYPE	DATE RATE
A	0 to 78	0, 78	FHSS	GFSK	DH5	1
A	0 to 78	0, 78	FHSS	8DPSK	DH5	3

**ANTENNA PORT CONDUCTED MEASUREMENT:**

- Pre-Scan has been conducted to determine the worst-case mode from all possible combinations between available modulations and packet types of the antenna and antenna ports (if EUT with antenna diversity architecture).
- Following channel(s) was (were) selected for the final test as listed below.

EUT CONFIGURE MODE	AVAILABLE CHANNEL	TESTED CHANNEL	MODULATION TECHNOLOGY	MODULATION TYPE	PACKET TYPE	DATE RATE
A	0 to 78	0, 39, 78	FHSS	GFSK	DH5	1
A	0 to 78	0, 39, 78	FHSS	8DPSK	DH5	3



### **3.2.3 GENERAL DESCRIPTION OF APPLIED STANDARDS**

The EUT is a RF Product. According to the specifications of the manufacturer, it must comply with the requirements of the following standards:

**FCC Part 15, Subpart C. (15.247)**

**ANSI C63.4- 2003**

All test items have been performed and recorded as per the above standards.

**NOTE:** The product has been verified to comply with the requirements of FCC Part 15, Subpart B, Class B (DoC). The test report has been issued separately.

### **3.2.4 DESCRIPTION OF SUPPORT UNITS**

The EUT has been tested as an independent unit together without any necessary accessory or support unit.



## 4. TEST TYPES AND RESULTS

### 4.1 CONDUCTED EMISSION MEASUREMENT

#### 4.1.1 LIMITS OF CONDUCTED EMISSION MEASUREMENT

FREQUENCY OF EMISSION (MHz)	CONDUCTED LIMIT (dB $\mu$ V)	
	Quasi-peak	Average
0.15 ~ 0.5	66 to 56	56 to 46
0.5 ~ 5	56	46
5 ~ 30	60	50

- NOTE:**
1. The lower limit shall apply at the transition frequencies.
  2. The limit decreases in line with the logarithm of the frequency in the range of 0.15 to 0.50 MHz.
  3. All emanations from a class A/B digital device or system, including any network of conductors and apparatus connected thereto, shall not exceed the level of field strengths specified above.

#### 4.1.2 TEST INSTRUMENTS

DESCRIPTION & MANUFACTURER	MODEL NO.	SERIAL NO.	CALIBRATED DATE	CALIBRATED UNTIL
ROHDE & SCHWARZ Test Receiver	ESCS 30	838251/021	Dec. 20, 2007	Dec. 19, 2008
ROHDE & SCHWARZ Artificial Mains Network (for EUT)	ESH3-Z5	100218	Nov. 21, 2007	Nov. 20, 2008
LISN With Adapter (for EUT)	AD10	C10Ada-001	Nov. 22, 2007	Nov. 21, 2008
ROHDE & SCHWARZ Artificial Mains Network (for peripherals)	ESH3-Z5	100219	Nov. 09, 2007	Nov. 08, 2008
ROHDE & SCHWARZ Artificial Mains Network (for peripherals)	ESH3-Z5	100220	Oct. 26, 2007	Oct. 25, 2008
Software	ADT_Cond_V7.3.5	NA	NA	NA
Software	ADT_ISN_V7.3.5	NA	NA	NA
RF cable (JYEBAO)	5D-FB	Cable-C10.01	Feb. 27, 2008	Feb. 26, 2009
SUHNTER Terminator (For ROHDE & SCHWARZ LISN)	65BNC-5001	E1-010773	Feb. 14, 2008	Feb. 13, 2009

- NOTE:**
1. The calibration interval of the above test instruments is 12 months and the calibrations are traceable to NML/ROC and NIST/USA.
  2. The test was performed in Shielded Room No. 10.
  3. The VCCI Site Registration No. C-1852.

### 4.1.3 TEST PROCEDURES

- a. The EUT was placed 0.4 meters from the conducting wall of the shielded room with EUT being connected to the power mains through a line impedance stabilization network (LISN). Other support units were connected to the power mains through another LISN. The two LISNs provide 50 ohm/ 50uH of coupling impedance for the measuring instrument.
- b. Both lines of the power mains connected to the EUT were checked for maximum conducted interference.
- c. The frequency range from 150kHz to 30MHz was searched. Emission levels under (Limit - 20dB) was not recorded.

### 4.1.4 DEVIATION FROM TEST STANDARD

No deviation

### 4.1.5 TEST SETUP

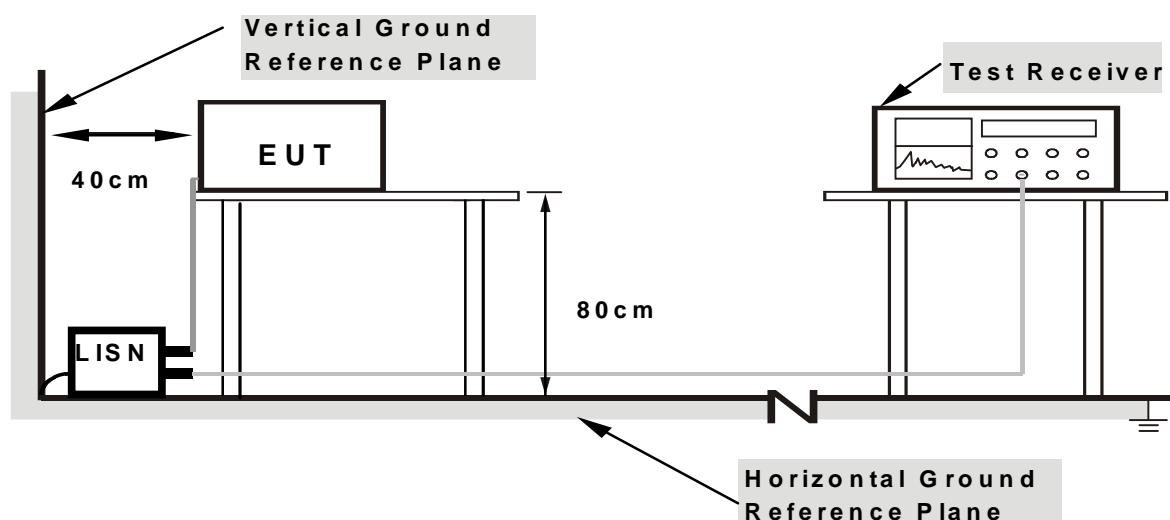

- Note:**
1. Support units were connected to second LISN.
  2. Both of LISNs (AMN) are 80 cm from EUT and at least 80 cm from other units and other metal planes support units.

For the actual test configuration, please refer to the related item – Photographs of the Test Configuration.

### 4.1.6 EUT OPERATING CONDITIONS

Set the EUT under transmission/receiving condition continuously at specific channel frequency.

## 4.1.7 TEST RESULTS

<b>TEST MODE</b>	A		
<b>MODULATION TYPE</b>	GFSK	<b>CHANNEL</b>	0
<b>INPUT POWER</b>	120Vac, 60 Hz	<b>6dB BANDWIDTH</b>	9 kHz
<b>ENVIRONMENTAL CONDITIONS</b>	27deg. C, 55% RH, 1000hPa	<b>PHASE</b>	Line 1
<b>TESTED BY</b>	Chad Lee		

No	Freq. [MHz]	Corr. Factor (dB)	Reading Value		Emission Level		Limit		Margin	
			[dB (uV)]		[dB (uV)]		[dB (uV)]		(dB)	
	Q.P.	AV.	Q.P.	AV.	Q.P.	AV.	Q.P.	AV.	Q.P.	AV.
1	0.180	0.19	43.35	-	43.54	-	64.48	54.48	-20.94	-
2	0.242	0.19	35.49	-	35.68	-	62.03	52.03	-26.35	-
3	0.314	0.20	30.28	-	30.48	-	59.86	49.86	-29.38	-
4	0.408	0.20	23.42	-	23.62	-	57.69	47.69	-34.07	-
5	0.476	0.20	23.66	-	23.86	-	56.40	46.40	-32.54	-
6	3.534	0.39	28.49	-	28.88	-	56.00	46.00	-27.12	-

- REMARKS:**
1. Q.P. and AV. are abbreviations of quasi-peak and average individually.
  2. "-": The Quasi-peak reading value also meets average limit and measurement with the average detector is unnecessary.
  3. The emission levels of other frequencies were very low against the limit.
  4. Margin value = Emission level - Limit value
  5. Correction factor = Insertion loss + Cable loss
  6. Emission Level = Correction Factor + Reading Value.

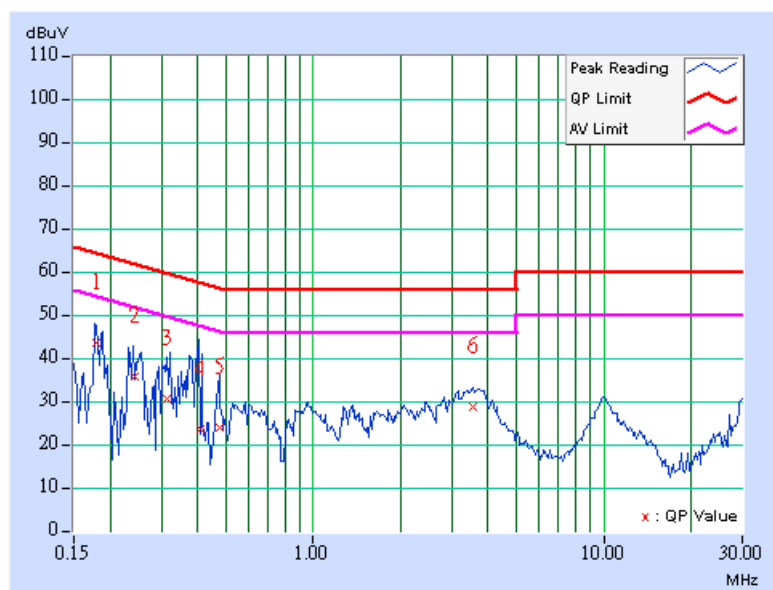

<b>TEST MODE</b>	A		
<b>MODULATION TYPE</b>	GFSK	<b>CHANNEL</b>	0
<b>INPUT POWER</b>	120Vac, 60 Hz	<b>6dB BANDWIDTH</b>	9 kHz
<b>ENVIRONMENTAL CONDITIONS</b>	27deg. C, 55% RH, 1000hPa	<b>PHASE</b>	Line 2
<b>TESTED BY</b>	Chad Lee		

No	Freq. [MHz]	Corr. Factor (dB)	Reading Value		Emission Level		Limit		Margin	
			[dB (uV)]		[dB (uV)]		[dB (uV)]		(dB)	
			Q.P.	AV.	Q.P.	AV.	Q.P.	AV.	Q.P.	AV.
1	0.178	0.19	44.53	-	44.72	-	64.58	54.58	-19.86	-
2	0.255	0.19	38.50	-	38.69	-	61.60	51.60	-22.90	-
3	0.302	0.20	34.86	-	35.06	-	60.18	50.18	-25.13	-
4	0.378	0.20	32.08	-	32.28	-	58.32	48.32	-26.04	-
5	0.536	0.20	29.93	-	30.13	-	56.00	46.00	-25.87	-
6	3.530	0.40	27.42	-	27.82	-	56.00	46.00	-28.18	-

- REMARKS:**
1. Q.P. and AV. are abbreviations of quasi-peak and average individually.
  2. "-": The Quasi-peak reading value also meets average limit and measurement with the average detector is unnecessary.
  3. The emission levels of other frequencies were very low against the limit.
  4. Margin value = Emission level - Limit value
  5. Correction factor = Insertion loss + Cable loss
  6. Emission Level = Correction Factor + Reading Value.

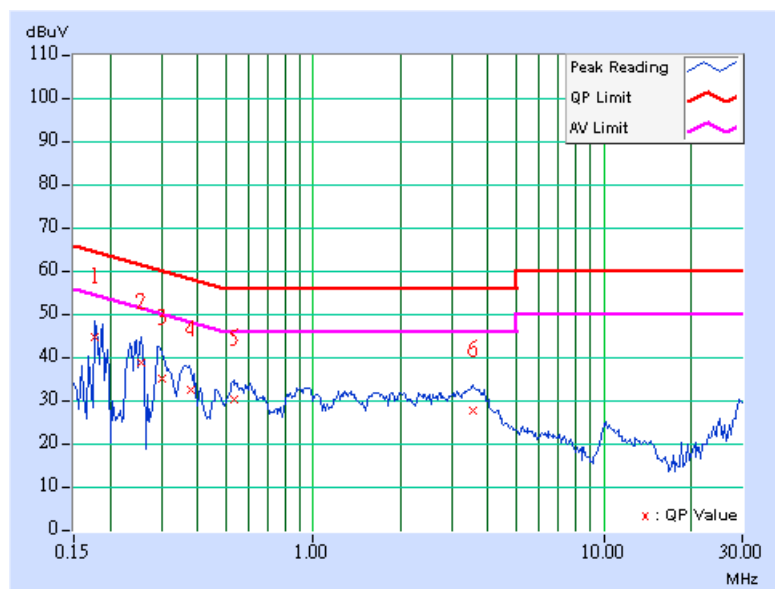





## 4.2 RADIATED EMISSION MEASUREMENT

### 4.2.1 LIMITS OF RADIATED EMISSION MEASUREMENT

Emissions radiated outside of the specified bands, shall be according to the general radiated limits in 15.209 as following:

FREQUENCIES (MHz)	FIELD STRENGTH (microvolts/meter)	MEASUREMENT DISTANCE (meters)
0.009 ~ 0.490	2400/F(kHz)	300
0.490 ~ 1.705	24000/F(kHz)	30
1.705 ~ 30.0	30	30
30 ~ 88	100	3
88 ~ 216	150	3
216 ~ 960	200	3
Above 960	500	3

**NOTE:**

1. The lower limit shall apply at the transition frequencies.
2. Emission level (dBuV/m) = 20 log Emission level (uV/m).
3. As shown in 15.35(b), for frequencies above 1000MHz, the field strength limits are based on average detector, however, the peak field strength of any emission shall not exceed the maximum permitted average limits, specified above by more than 20dB under any condition of modulation.



## 4.2.2 TEST INSTRUMENTS

DESCRIPTION & MANUFACTURER	MODEL NO.	SERIAL NO.	CALIBRATED DATE	CALIBRATED UNTIL
HP Preamplifier	8447D	2432A03504	May 09, 2008	May 08, 2009
HP Preamplifier	8449B	3008A01201	Oct. 02, 2007	Oct. 01, 2008
HP Preamplifier	8449B	3008A01292	Aug. 06, 2008	Aug. 05, 2009
ROHDE & SCHWARZ TEST RECEIVER	ESI7	836697/012	Dec. 06, 2007	Dec. 05, 2008
Schwarzbeck Antenna	VULB 9168	137	May 02, 2008	May 01, 2009
Schwarzbeck Antenna	VHBA 9123	480	Apr. 23, 2008	Apr. 22, 2009
EMCO Horn Antenna	3115	6714	Oct. 19, 2007	Oct. 18, 2008
EMCO Horn Antenna	3115	9312-4192	Apr. 21, 2008	Apr. 20, 2009
ADT. Turn Table	TT100	0306	NA	NA
ADT. Tower	AT100	0306	NA	NA
Software	ADT_Radiated_V 7.6.15	NA	NA	NA
SUHNER RF cable	SF104-26.5	CABLE-CH6-17m -01	Nov. 05, 2007	Nov. 04, 2008
ROHDE & SCHWARZ Spectrum Analyzer	FSP 40	100035	Mar. 26, 2008	Mar. 25, 2009

- NOTE:**
1. The calibration interval of the above test instruments is 12 months. And the calibrations are traceable to NML/ROC and NIST/USA.
  2. The horn antenna and HP preamplifier (model: 8449B) are used only for the measurement of emission frequency above 1GHz if tested.
  3. The test was performed in Chamber No. 6.
  4. The Industry Canada Reference No. IC 3789-6.
  5. The FCC Site Registration No. is 447212.

### 4.2.3 TEST PROCEDURES

- a. The EUT was placed on the top of a rotating table 0.8 meters above the ground at a 3 meter semi-anechoic chamber. The table was rotated 360 degrees to determine the position of the highest radiation.
- b. The EUT was set 3 meters away from the interference-receiving antenna, which was mounted on the top of a variable-height antenna tower.
- c. The antenna is a broadband antenna, and its height is varied from one meter to four meters above the ground to determine the maximum value of the field strength. Both horizontal and vertical polarizations of the antenna are set to make the measurement.
- d. For each suspected emission, the EUT was arranged to its worst case and then the antenna was tuned to heights from 1 meter to 4 meters and the rotatable table was turned from 0 degrees to 360 degrees to find the maximum reading.
- e. The test-receiver system was set to Peak Detect Function and Specified Bandwidth with Maximum Hold Mode.
- f. If the emission level of the EUT in peak mode was lower than the limit specified, then testing could be stopped and the peak values of the EUT would be reported. Otherwise the emissions would be re-tested one by one using peak, quasi-peak or average method as specified and then reported in a data sheet.

**NOTE:**

1. The resolution bandwidth of test receiver/spectrum analyzer is 120kHz for Quasi-peak detection at frequency below 1GHz.
2. The resolution bandwidth is 1MHz and video bandwidth of test receiver/spectrum analyzer is 3MHz for Peak detection at frequency above 1GHz. The resolution bandwidth of test receiver/spectrum analyzer is 1 MHz for Average detection (AV) at frequency above 1GHz.
3. For measurement of frequency above 1000 MHz, the EUT was set 3 meters away from the interference-receiving antenna.

### 4.2.4 DEVIATION FROM TEST STANDARD

No deviation

## 4.2.5 TEST SETUP

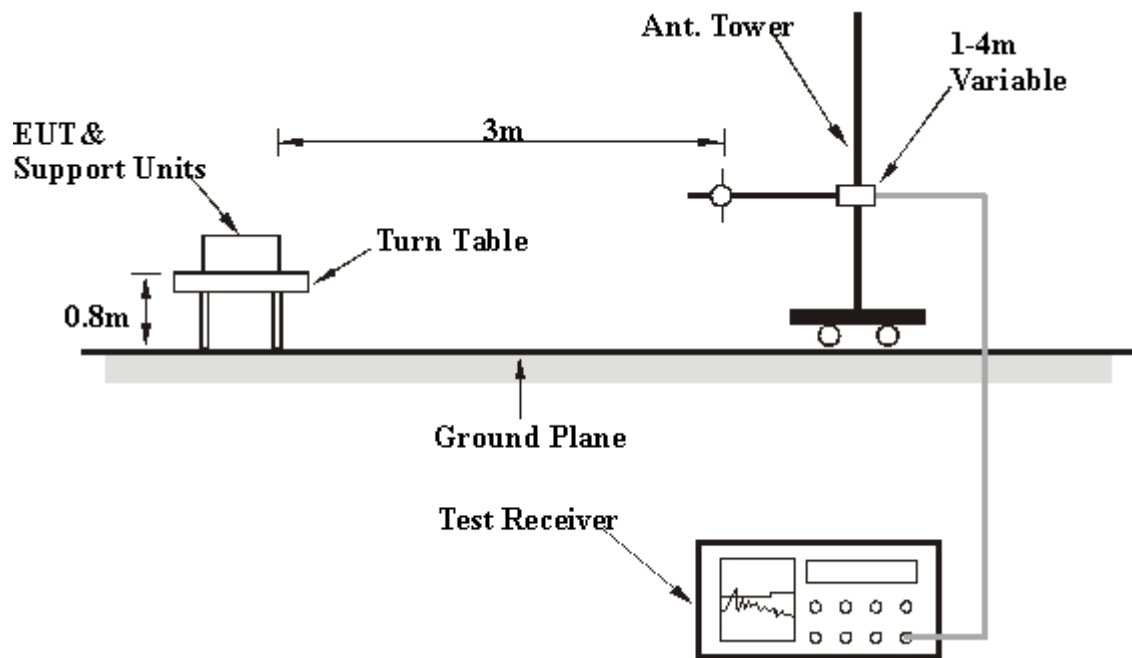

For the actual test configuration, please refer to the related item – Photographs of the Test Configuration.

## 4.2.6 EUT OPERATING CONDITIONS

Same as item 4.1.6.



## 4.2.7 TEST RESULTS

### RADIATED WORST CASE DATA: FOR GFSK (BELOW 1GHz)

<b>TEST MODE</b>	A		
<b>MODULATION TYPE</b>	GFSK	<b>CHANNEL</b>	0
<b>INPUT POWER</b>	120Vac, 60 Hz	<b>FREQUENCY RANGE</b>	Below 1000MHz
<b>ENVIRONMENTAL CONDITIONS</b>	26deg. C, 65% RH, 993hPa	<b>DETECTOR FUNCTION</b>	Quasi-Peak
<b>TESTED BY</b>	Chad Lee		

### ANTENNA POLARITY & TEST DISTANCE: HORIZONTAL AT 3 M

No.	Freq. (MHz)	Emission Level (dBuV/m)	Limit (dBuV/m)	Margin (dB)	Antenna Height (m)	Table Angle (Degree)	Raw Value (dBuV)	Correction Factor (dB/m)
1	257.435	26.45 QP	46.00	-19.55	1.00 H	145	11.15	15.30
2	276.874	35.15 QP	46.00	-10.85	1.00 H	133	19.51	15.63
3	319.639	35.14 QP	46.00	-10.86	1.00 H	73	18.62	16.52
4	720.080	27.08 QP	46.00	-18.92	1.00 H	136	2.05	25.03
5	830.882	25.34 QP	46.00	-20.66	1.00 H	10	-2.11	27.45
6	873.647	26.33 QP	46.00	-19.67	1.00 H	10	-1.70	28.03

### ANTENNA POLARITY & TEST DISTANCE: VERTICAL AT 3 M

No.	Freq. (MHz)	Emission Level (dBuV/m)	Limit (dBuV/m)	Margin (dB)	Antenna Height (m)	Table Angle (Degree)	Raw Value (dBuV)	Correction Factor (dB/m)
1	121.363	24.27 QP	43.50	-19.23	1.32 V	229	10.93	13.34
2	148.577	25.20 QP	43.50	-18.30	1.00 V	223	10.65	14.56
3	253.547	25.31 QP	46.00	-20.69	1.63 V	175	10.06	15.25
4	276.874	30.85 QP	46.00	-15.15	1.47 V	175	15.22	15.63
5	801.723	25.94 QP	46.00	-20.06	1.33 V	136	-1.13	27.07
6	842.545	25.43 QP	46.00	-20.57	1.00 V	337	-2.17	27.60

- REMARKS:**
1. Emission level (dBuV/m) = Raw Value (dBuV) + Correction Factor (dB/m).
  2. Correction Factor (dB/m) = Antenna Factor (dB/m) + Cable Factor (dB).
  3. The other emission levels were very low against the limit.
  4. Margin value = Emission level – Limit value.



<b>TEST MODE</b>	B		
<b>MODULATION TYPE</b>	GFSK	<b>CHANNEL</b>	0
<b>INPUT POWER</b>	7.4Vdc	<b>FREQUENCY RANGE</b>	Below 1000MHz
<b>ENVIRONMENTAL CONDITIONS</b>	26deg. C, 65% RH, 993hPa	<b>DETECTOR FUNCTION</b>	Quasi-Peak
<b>TESTED BY</b>	Chad Lee		

#### ANTENNA POLARITY & TEST DISTANCE: HORIZONTAL AT 3 M

No.	Freq. (MHz)	Emission Level (dBuV/m)	Limit (dBuV/m)	Margin (dB)	Antenna Height (m)	Table Angle (Degree)	Raw Value (dBuV)	Correction Factor (dB/m)
1	224.389	24.92 QP	46.00	-21.08	1.06 H	262	11.53	13.39
2	257.435	28.81 QP	46.00	-17.19	1.12 H	259	13.51	15.30
<b>3</b>	<b>274.930</b>	<b>37.06 QP</b>	<b>46.00</b>	<b>-8.94</b>	<b>1.56 H</b>	<b>97</b>	<b>21.45</b>	<b>15.61</b>
4	480.982	22.58 QP	46.00	-23.42	1.00 H	70	1.76	20.82
5	739.519	23.29 QP	46.00	-22.71	1.42 H	10	-2.20	25.49
6	801.723	30.30 QP	46.00	-15.70	1.00 H	283	3.22	27.07

#### ANTENNA POLARITY & TEST DISTANCE: VERTICAL AT 3 M

No.	Freq. (MHz)	Emission Level (dBuV/m)	Limit (dBuV/m)	Margin (dB)	Antenna Height (m)	Table Angle (Degree)	Raw Value (dBuV)	Correction Factor (dB/m)
1	64.990	20.36 QP	40.00	-19.64	1.00 V	172	7.36	13.00
2	319.639	24.37 QP	46.00	-21.63	1.29 V	7	7.85	16.52
3	459.599	23.40 QP	46.00	-22.60	1.08 V	154	3.08	20.32
4	640.381	23.66 QP	46.00	-22.34	1.00 V	166	-0.26	23.92
5	749.238	22.85 QP	46.00	-23.15	1.33 V	208	-2.87	25.72
6	766.733	24.36 QP	46.00	-21.64	1.42 V	289	-1.82	26.18

- REMARKS:**
1. Emission level (dBuV/m) = Raw Value (dBuV) + Correction Factor (dB/m).
  2. Correction Factor (dB/m) = Antenna Factor (dB/m) + Cable Factor (dB).
  3. The other emission levels were very low against the limit.
  4. Margin value = Emission level – Limit value.



**RADIATED DATA: FOR GFSK (ABOVE 1GHz)**

<b>TEST MODE</b>	A		
<b>MODULATION TYPE</b>	GFSK	<b>CHANNEL</b>	0
<b>INPUT POWER</b>	120Vac, 60 Hz	<b>FREQUENCY RANGE</b>	1 ~ 25GHz
<b>ENVIRONMENTAL CONDITIONS</b>	26deg. C, 65% RH, 994hPa	<b>DETECTOR FUNCTION</b>	Peak (PK) Average (AV)
<b>TESTED BY</b>	Chad Lee		

**ANTENNA POLARITY & TEST DISTANCE: HORIZONTAL AT 3 M**

No.	Freq. (MHz)	Emission Level (dBuV/m)	Limit (dBuV/m)	Margin (dB)	Antenna Height (m)	Table Angle (Degree)	Raw Value (dBuV)	Correction Factor (dB/m)
1	1602.000	41.52 PK	74.00	-32.48	1.00 H	160	10.24	31.27
2	1602.000	33.03 AV	54.00	-20.97	1.00 H	160	1.75	31.27
3	2390.000	56.95 PK	74.00	-17.05	1.00 H	175	23.65	33.30
4	2390.000	26.85 AV	54.00	-27.15	1.00 H	175	-6.45	33.30
5	*2402.000	97.52 PK			1.00 H	175	64.17	33.35
6	*2402.000	67.42 AV			1.00 H	175	34.07	33.35
7	4804.000	49.41 PK	74.00	-24.59	1.00 H	13	9.02	40.39
8	4804.000	19.31 AV	54.00	-34.69	1.00 H	13	-21.08	40.39

**ANTENNA POLARITY & TEST DISTANCE: VERTICAL AT 3 M**

No.	Freq. (MHz)	Emission Level (dBuV/m)	Limit (dBuV/m)	Margin (dB)	Antenna Height (m)	Table Angle (Degree)	Raw Value (dBuV)	Correction Factor (dB/m)
1	1602.000	41.54 PK	74.00	-32.46	1.00 V	338	10.26	31.27
2	1602.000	31.04 AV	54.00	-22.96	1.00 V	338	-0.24	31.27
3	2390.000	56.69 PK	74.00	-17.31	1.00 V	204	23.39	33.30
4	2390.000	26.59 AV	54.00	-27.41	1.00 V	204	-6.71	33.30
5	*2402.000	96.50 PK			1.00 V	204	63.15	33.35
6	*2402.000	66.40 AV			1.00 V	204	33.05	33.35
7	4804.000	49.98 PK	74.00	-24.02	1.00 V	37	9.59	40.39
8	4804.000	19.88 AV	54.00	-34.12	1.00 V	37	-20.51	40.39

- REMARKS:**
1. Emission level (dBuV/m) = Raw Value (dBuV) + Correction Factor (dB/m).
  2. Correction Factor (dB/m) = Antenna Factor (dB/m) + Cable Factor (dB).
  3. The other emission levels were very low against the limit.
  4. Margin value = Emission level – Limit value.
  5. The DH5 packet was the worse case duty cycle for a transmit dwell time on a channel, based upon bluetooth theory the transmitter is on 0.625 \* 5 per 296.25 ms per channel. Therefore, the duty cycle be equal to:  $20\log(3.125/100) = -30.1$  dB.
  6. Average value = peak reading +  $20\log(\text{duty cycle})$ .



<b>TEST MODE</b>	A		
<b>MODULATION TYPE</b>	GFSK	<b>CHANNEL</b>	39
<b>INPUT POWER</b>	120Vac, 60 Hz	<b>FREQUENCY RANGE</b>	1 ~ 25GHz
<b>ENVIRONMENTAL CONDITIONS</b>	26deg. C, 65% RH, 994hPa	<b>DETECTOR FUNCTION</b>	Peak (PK) Average (AV)
<b>TESTED BY</b>	Chad Lee		

#### ANTENNA POLARITY & TEST DISTANCE: HORIZONTAL AT 3 M

No.	Freq. (MHz)	Emission Level (dBuV/m)	Limit (dBuV/m)	Margin (dB)	Antenna Height (m)	Table Angle (Degree)	Raw Value (dBuV)	Correction Factor (dB/m)
1	1628.000	41.32 PK	74.00	-32.68	1.00 H	120	10.03	31.29
2	1628.000	30.45 AV	54.00	-23.55	1.00 H	120	-0.84	31.29
3	*2441.000	100.41 PK			1.12 H	113	66.88	33.53
4	*2441.000	70.31 AV			1.12 H	113	36.78	33.53
5	4882.000	49.95 PK	74.00	-24.05	1.00 H	19	9.38	40.57
6	4882.000	19.85 AV	54.00	-34.15	1.00 H	19	-20.72	40.57

#### ANTENNA POLARITY & TEST DISTANCE: VERTICAL AT 3 M

No.	Freq. (MHz)	Emission Level (dBuV/m)	Limit (dBuV/m)	Margin (dB)	Antenna Height (m)	Table Angle (Degree)	Raw Value (dBuV)	Correction Factor (dB/m)
1	1628.000	41.00 PK	74.00	-33.00	1.00 V	199	9.71	31.29
2	1628.000	30.79 AV	54.00	-23.21	1.00 V	199	-0.50	31.29
3	*2441.000	99.73 PK			1.00 V	208	66.20	33.53
4	*2441.000	69.63 AV			1.00 V	208	36.10	33.53
5	4882.000	50.16 PK	74.00	-23.84	1.00 V	39	9.59	40.57
6	4882.000	20.06 AV	54.00	-33.94	1.00 V	39	-20.51	40.57

- REMARKS:**
1. Emission level (dBuV/m) = Raw Value (dBuV) + Correction Factor (dB/m).
  2. Correction Factor (dB/m) = Antenna Factor (dB/m) + Cable Factor (dB).
  3. The other emission levels were very low against the limit.
  4. Margin value = Emission level – Limit value.
  5. The DH5 packet was the worse case duty cycle for a transmit dwell time on a channel, based upon bluetooth theory the transmitter is on  $0.625 * 5$  per 296.25 ms per channel. Therefore, the duty cycle be equal to:  $20\log(3.125/100) = -30.1$  dB.
  6. Average value = peak reading +  $20\log(\text{duty cycle})$ .





<b>TEST MODE</b>	A		
<b>MODULATION TYPE</b>	GFSK	<b>CHANNEL</b>	78
<b>INPUT POWER</b>	120Vac, 60 Hz	<b>FREQUENCY RANGE</b>	1 ~ 25GHz
<b>ENVIRONMENTAL CONDITIONS</b>	26deg. C, 65% RH, 994hPa	<b>DETECTOR FUNCTION</b>	Peak (PK) Average (AV)
<b>TESTED BY</b>	Chad Lee		

#### ANTENNA POLARITY & TEST DISTANCE: HORIZONTAL AT 3 M

No.	Freq. (MHz)	Emission Level (dBuV/m)	Limit (dBuV/m)	Margin (dB)	Antenna Height (m)	Table Angle (Degree)	Raw Value (dBuV)	Correction Factor (dB/m)
1	1654.000	41.39 PK	74.00	-32.61	1.00 H	359	10.08	31.31
2	1654.000	31.76 AV	54.00	-22.24	1.00 H	359	0.45	31.31
3	*2480.000	98.98 PK			1.05 H	114	65.28	33.70
4	*2480.000	68.88 AV			1.05 H	114	35.18	33.70
5	2483.500	47.70 PK	74.00	-26.30	1.05 H	114	13.98	33.72
6	2483.500	17.60 AV	54.00	-36.40	1.05 H	114	-16.12	33.72
7	4960.000	50.15 PK	74.00	-23.85	1.00 H	37	9.39	40.76
8	4960.000	20.05 AV	54.00	-33.95	1.00 H	37	-20.71	40.76

#### ANTENNA POLARITY & TEST DISTANCE: VERTICAL AT 3 M

No.	Freq. (MHz)	Emission Level (dBuV/m)	Limit (dBuV/m)	Margin (dB)	Antenna Height (m)	Table Angle (Degree)	Raw Value (dBuV)	Correction Factor (dB/m)
1	1654.000	43.14 PK	74.00	-30.86	1.03 V	195	11.83	31.31
2	1654.000	32.87 AV	54.00	-21.13	1.03 V	195	1.56	31.31
3	*2480.000	100.29 PK			1.00 V	206	66.59	33.70
4	*2480.000	70.19 AV			1.00 V	206	36.49	33.70
5	2483.500	49.20 PK	74.00	-24.80	1.00 V	206	15.48	33.72
6	2483.500	19.10 AV	54.00	-34.90	1.00 V	206	-14.62	33.72
7	4960.000	52.14 PK	74.00	-21.86	1.00 V	13	11.38	40.76
8	4960.000	22.04 AV	54.00	-31.96	1.00 V	13	-18.72	40.76

- REMARKS:**
1. Emission level (dBuV/m) = Raw Value (dBuV) + Correction Factor (dB/m).
  2. Correction Factor (dB/m) = Antenna Factor (dB/m) + Cable Factor (dB).
  3. The other emission levels were very low against the limit.
  4. Margin value = Emission level – Limit value.
  5. The DH5 packet was the worse case duty cycle for a transmit dwell time on a channel, based upon bluetooth theory the transmitter is on 0.625 \* 5 per 296.25 ms per channel. Therefore, the duty cycle be equal to:  $20\log(3.125/100) = -30.1$  dB.
  6. Average value = peak reading +  $20\log(\text{duty cycle})$ .



**RADIATED DATA: FOR 8DPSK (ABOVE 1GHz)**

<b>TEST MODE</b>	A		
<b>MODULATION TYPE</b>	8DPSK	<b>CHANNEL</b>	0
<b>INPUT POWER</b>	120Vac, 60 Hz	<b>FREQUENCY RANGE</b>	1 ~ 25GHz
<b>ENVIRONMENTAL CONDITIONS</b>	26deg. C, 65% RH, 994hPa	<b>DETECTOR FUNCTION</b>	Peak (PK) Average (AV)
<b>TESTED BY</b>	Chad Lee		

**ANTENNA POLARITY & TEST DISTANCE: HORIZONTAL AT 3 M**

No.	Freq. (MHz)	Emission Level (dBuV/m)	Limit (dBuV/m)	Margin (dB)	Antenna Height (m)	Table Angle (Degree)	Raw Value (dBuV)	Correction Factor (dB/m)
1	1602.000	42.28 PK	74.00	-31.72	1.00 H	137	11.00	31.27
2	1602.000	32.93 AV	54.00	-21.07	1.00 H	137	1.65	31.27
3	2390.000	57.45 PK	74.00	-16.55	1.21 H	188	24.15	33.30
4	2390.000	27.35 AV	54.00	-26.65	1.21 H	188	-5.95	33.30
5	*2402.000	99.07 PK			1.21 H	188	65.72	33.35
6	*2402.000	68.97 AV			1.21 H	188	35.62	33.35
7	4804.000	50.23 PK	74.00	-23.77	1.00 H	13	9.84	40.39
8	4804.000	20.13 AV	54.00	-33.87	1.00 H	13	-20.26	40.39

**ANTENNA POLARITY & TEST DISTANCE: VERTICAL AT 3 M**

No.	Freq. (MHz)	Emission Level (dBuV/m)	Limit (dBuV/m)	Margin (dB)	Antenna Height (m)	Table Angle (Degree)	Raw Value (dBuV)	Correction Factor (dB/m)
1	1602.000	40.66 PK	74.00	-33.34	1.05 V	105	9.38	31.27
2	1602.000	30.15 AV	54.00	-23.85	1.05 V	105	-1.13	31.27
3	2390.000	57.24 PK	74.00	-16.76	1.00 V	215	23.94	33.30
4	2390.000	27.14 AV	54.00	-26.86	1.00 V	215	-6.16	33.30
5	*2402.000	97.32 PK			1.00 V	215	63.97	33.35
6	*2402.000	67.22 AV			1.00 V	215	33.87	33.35
7	4804.000	50.36 PK	74.00	-23.64	1.00 V	3	9.97	40.39
8	4804.000	20.26 AV	54.00	-33.74	1.00 V	3	-20.13	40.39

- REMARKS:**
1. Emission level (dBuV/m) = Raw Value (dBuV) + Correction Factor (dB/m).
  2. Correction Factor (dB/m) = Antenna Factor (dB/m) + Cable Factor (dB).
  3. The other emission levels were very low against the limit.
  4. Margin value = Emission level – Limit value.
  5. The DH5 packet was the worse case duty cycle for a transmit dwell time on a channel, based upon bluetooth theory the transmitter is on 0.625 \* 5 per 296.25 ms per channel. Therefore, the duty cycle be equal to:  $20\log(3.125/100) = -30.1$  dB.
  6. Average value = peak reading +  $20\log(\text{duty cycle})$ .



<b>TEST MODE</b>	A		
<b>MODULATION TYPE</b>	8DPSK	<b>CHANNEL</b>	39
<b>INPUT POWER</b>	120Vac, 60 Hz	<b>FREQUENCY RANGE</b>	1 ~ 25GHz
<b>ENVIRONMENTAL CONDITIONS</b>	26deg. C, 65% RH, 994hPa	<b>DETECTOR FUNCTION</b>	Peak (PK) Average (AV)
<b>TESTED BY</b>	Chad Lee		

#### ANTENNA POLARITY & TEST DISTANCE: HORIZONTAL AT 3 M

No.	Freq. (MHz)	Emission Level (dBuV/m)	Limit (dBuV/m)	Margin (dB)	Antenna Height (m)	Table Angle (Degree)	Raw Value (dBuV)	Correction Factor (dB/m)
1	1628.000	41.59 PK	74.00	-32.41	1.03 H	120	10.30	31.29
2	1628.000	31.79 AV	54.00	-22.21	1.03 H	120	0.50	31.29
3	*2441.000	103.35 PK			1.12 H	112	69.82	33.53
4	*2441.000	73.25 AV			1.12 H	112	39.72	33.53
5	4882.000	51.38 PK	74.00	-22.62	1.00 H	233	10.81	40.57
6	4882.000	21.28 AV	54.00	-32.72	1.00 H	233	-19.29	40.57

#### ANTENNA POLARITY & TEST DISTANCE: VERTICAL AT 3 M

No.	Freq. (MHz)	Emission Level (dBuV/m)	Limit (dBuV/m)	Margin (dB)	Antenna Height (m)	Table Angle (Degree)	Raw Value (dBuV)	Correction Factor (dB/m)
1	1628.000	41.24 PK	74.00	-32.76	1.10 V	8	9.95	31.29
2	1628.000	30.48 AV	54.00	-23.52	1.10 V	8	-0.81	31.29
3	*2441.000	100.99 PK			1.00 V	204	67.46	33.53
4	*2441.000	70.89 AV			1.00 V	204	37.36	33.53
5	4882.000	50.40 PK	74.00	-23.60	1.00 V	65	9.83	40.57
6	4882.000	20.30 AV	54.00	-33.70	1.00 V	65	-20.27	40.57

- REMARKS:**
1. Emission level (dBuV/m) = Raw Value (dBuV) + Correction Factor (dB/m).
  2. Correction Factor (dB/m) = Antenna Factor (dB/m) + Cable Factor (dB).
  3. The other emission levels were very low against the limit.
  4. Margin value = Emission level – Limit value.
  5. The DH5 packet was the worse case duty cycle for a transmit dwell time on a channel, based upon bluetooth theory the transmitter is on  $0.625 * 5$  per 296.25 ms per channel. Therefore, the duty cycle be equal to:  $20\log(3.125/100) = -30.1$  dB.
  6. Average value = peak reading +  $20\log(\text{duty cycle})$ .



<b>TEST MODE</b>	A		
<b>MODULATION TYPE</b>	8DPSK	<b>CHANNEL</b>	78
<b>INPUT POWER</b>	120Vac, 60 Hz	<b>FREQUENCY RANGE</b>	1 ~ 25GHz
<b>ENVIRONMENTAL CONDITIONS</b>	26deg. C, 65% RH, 994hPa	<b>DETECTOR FUNCTION</b>	Peak (PK) Average (AV)
<b>TESTED BY</b>	Chad Lee		

#### ANTENNA POLARITY & TEST DISTANCE: HORIZONTAL AT 3 M

No.	Freq. (MHz)	Emission Level (dBuV/m)	Limit (dBuV/m)	Margin (dB)	Antenna Height (m)	Table Angle (Degree)	Raw Value (dBuV)	Correction Factor (dB/m)
1	1654.000	42.57 PK	74.00	-31.43	1.00 H	358	11.26	31.31
2	1654.000	32.47 AV	54.00	-21.53	1.00 H	358	1.16	31.31
3	*2480.000	103.89 PK			1.05 H	116	70.19	33.70
4	*2480.000	73.79 AV			1.05 H	116	40.09	33.70
5	2483.500	52.57 PK	74.00	-21.43	1.05 H	116	18.85	33.72
6	2483.500	22.47 AV	54.00	-31.53	1.05 H	116	-11.25	33.72
7	4960.000	49.73 PK	74.00	-24.27	1.00 H	37	8.97	40.76
8	4960.000	19.63 AV	54.00	-34.37	1.00 H	37	-21.13	40.76

#### ANTENNA POLARITY & TEST DISTANCE: VERTICAL AT 3 M

No.	Freq. (MHz)	Emission Level (dBuV/m)	Limit (dBuV/m)	Margin (dB)	Antenna Height (m)	Table Angle (Degree)	Raw Value (dBuV)	Correction Factor (dB/m)
1	1654.000	42.55 PK	74.00	-31.45	1.03 V	198	11.24	31.31
2	1654.000	32.82 AV	54.00	-21.18	1.03 V	198	1.51	31.31
3	*2480.000	102.04 PK			1.00 V	211	68.34	33.70
4	*2480.000	71.94 AV			1.00 V	211	38.24	33.70
5	2483.500	49.58 PK	74.00	-24.42	1.00 V	211	15.86	33.72
6	2483.500	19.48 AV	54.00	-34.52	1.00 V	211	-14.24	33.72
7	4960.000	50.91 PK	74.00	-23.09	1.00 V	13	10.15	40.76
8	4960.000	20.81 AV	54.00	-33.19	1.00 V	13	-19.95	40.76

- REMARKS:**
1. Emission level (dBuV/m) = Raw Value (dBuV) + Correction Factor (dB/m).
  2. Correction Factor (dB/m) = Antenna Factor (dB/m) + Cable Factor (dB).
  3. The other emission levels were very low against the limit.
  4. Margin value = Emission level – Limit value.
  5. The DH5 packet was the worse case duty cycle for a transmit dwell time on a channel, based upon bluetooth theory the transmitter is on  $0.625 * 5$  per 296.25 ms per channel. Therefore, the duty cycle be equal to:  $20\log(3.125/100) = -30.1$  dB.
  6. Average value = peak reading +  $20\log(\text{duty cycle})$ .



## 4.3 NUMBER OF HOPPING FREQUENCY USED

### 4.3.1 LIMIT OF HOPPING FREQUENCY USED

At least 15 channels frequencies, and should be equally spaced.

### 4.3.2 TEST INSTRUMENTS

DESCRIPTION & MANUFACTURER	MODEL NO.	SERIAL NO.	CALIBRATED DATE	CALIBRATED UNTIL
SPECTRUM ANALYZER	FSP 40	100035	Mar. 26, 2008	Mar. 25, 2009

**NOTE:** The calibration interval of the above test instruments is 12 months and the calibrations are traceable to NML/ROC and NIST/USA.

### 4.3.3 TEST PROCEDURES

- a. Check the calibration of the measuring instrument (SA) using either an internal calibrator or a known signal from an external generator.
- b. Turn on the EUT and connect its antenna terminal to measurement via a low loss cable. Then set it to any one measured frequency within its operating range and make sure the instrument is operated in its linear range.
- c. Set the SA on MaxHold Mode, and then keep the EUT in hopping mode. Record all the signals from each channel until each one has been recorded.
- d. Set the SA on View mode and then plot the result on SA screen.
- e. Repeat above procedures until all frequencies measured were complete.

#### 4.3.4 DEVIATION FROM TEST STANDARD

No deviation.

#### 4.3.5 TEST SETUP

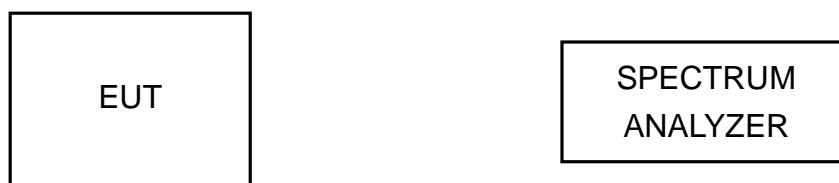

#### 4.3.6 TEST RESULTS

There are 79 hopping frequencies in the hopping mode. Please refer to next two pages for the test result. On the plots, it shows that the hopping frequencies are equally spaced.

### MODE A FOR GFSK MODULATION

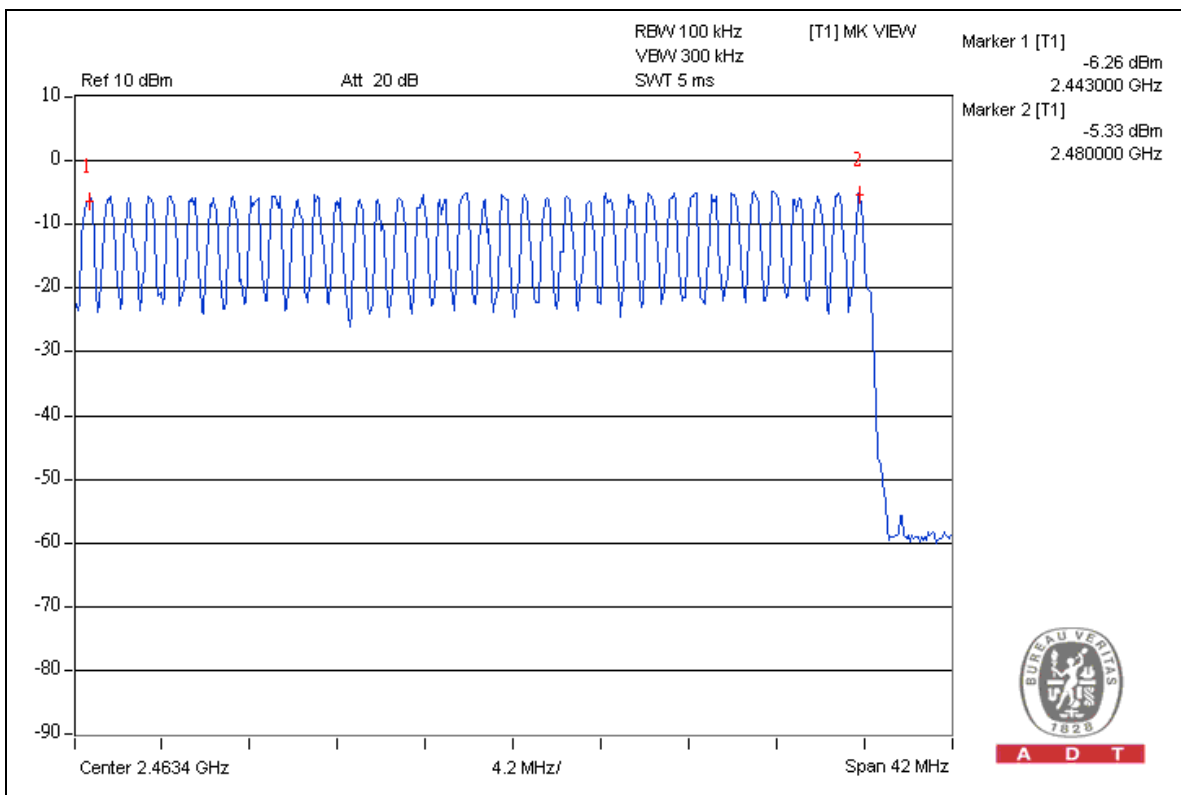
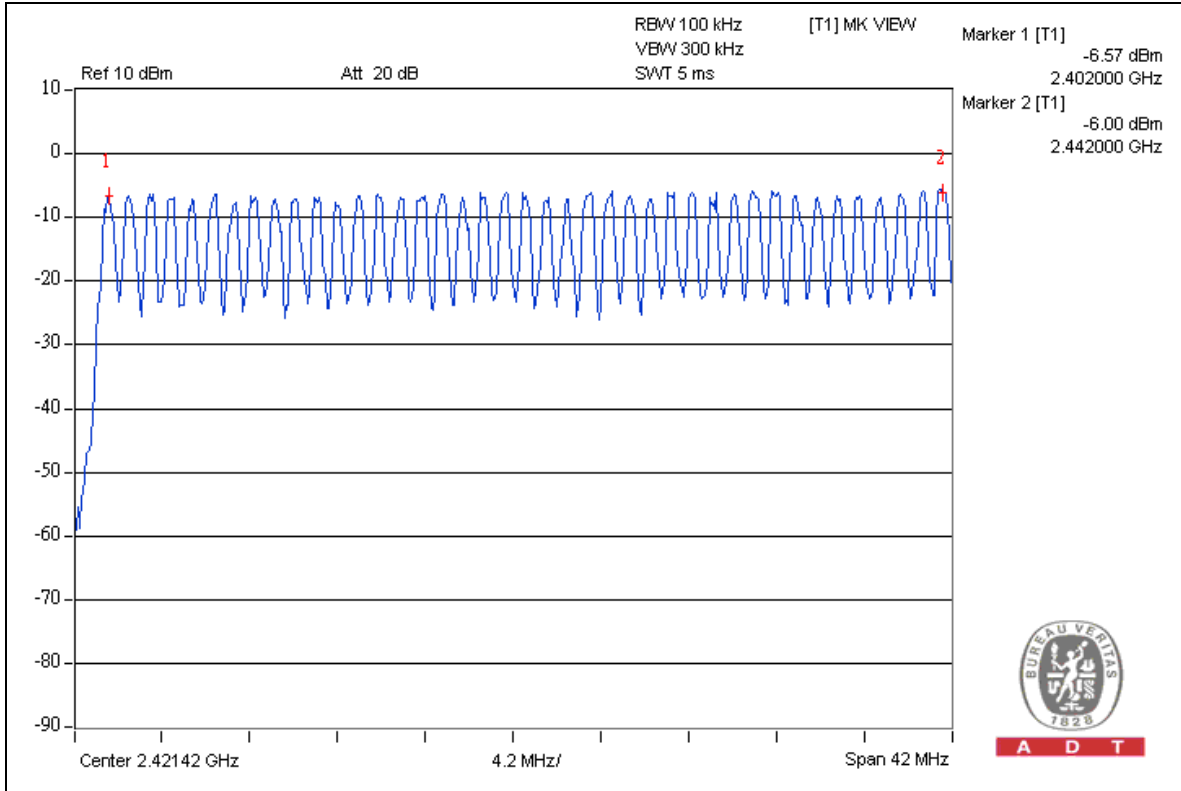

### MODE A FOR 8DPSK MODULATION

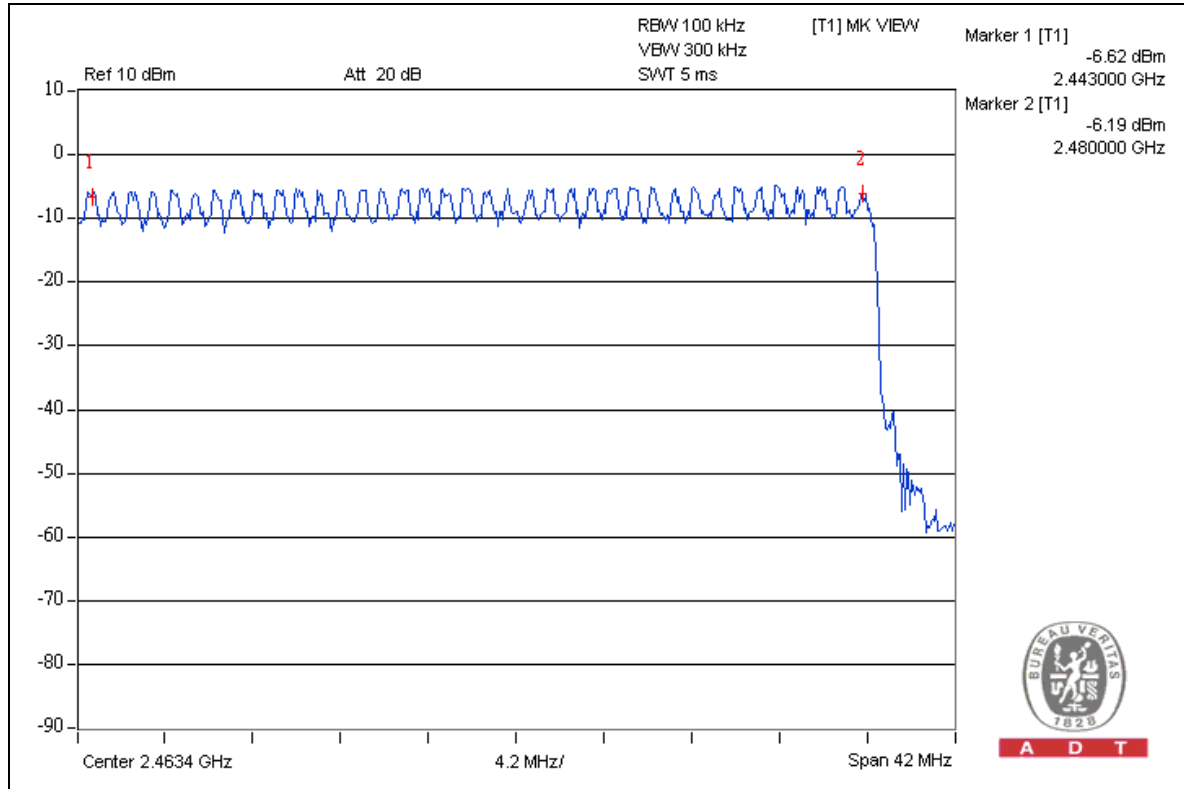
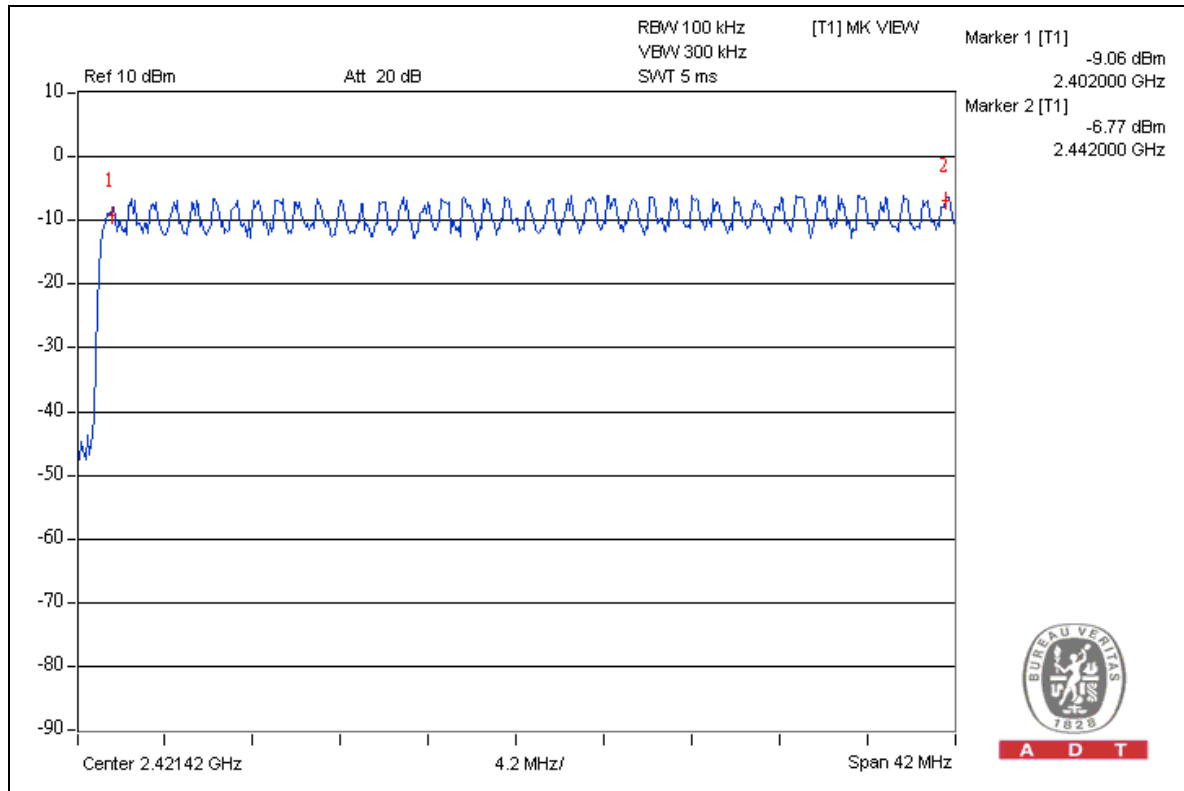





## 4.4 DWELL TIME ON EACH CHANNEL

### 4.4.1 LIMIT OF DWELL TIME USED

The average time of occupancy on any channel shall not be greater than 0.4 seconds within a period of 0.4 seconds multiplied by the number of hopping channels employed.

### 4.4.2 TEST INSTRUMENTS

DESCRIPTION & MANUFACTURER	MODEL NO.	SERIAL NO.	CALIBRATED DATE	CALIBRATED UNTIL
SPECTRUM ANALYZER	FSP 40	100035	Mar. 26, 2008	Mar. 25, 2009

**NOTE:** The calibration interval of the above test instruments is 12 months and the calibrations are traceable to NML/ROC and NIST/USA.

### 4.4.3 TEST PROCEDURES

- a. Check the calibration of the measuring instrument (SA) using either an internal calibrator or a known signal from an external generator.
- b. Turn on the EUT and connect its antenna terminal to measurement via a low loss cable. Then set it to any one measured frequency within its operating range and make sure the instrument is operated in its linear range.
- c. Adjust the center frequency of SA on any frequency be measured and set SA to zero span mode. And then, set RBW and VBW of spectrum analyzer to proper value.
- d. Measure the time duration of one transmission on the measured frequency. And then plot the result with time difference of this time duration.
- e. Repeat above procedures until all different time-slot modes have been completed.

### 4.4.4 DEVIATION FROM TEST STANDARD

No deviation.

#### 4.4.5 TEST SETUP

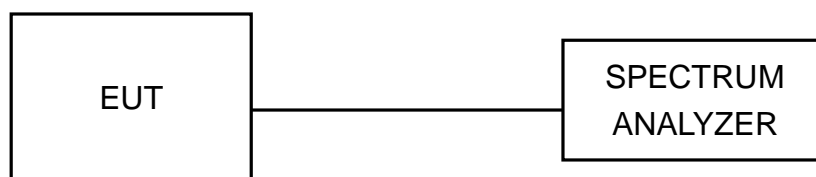

#### 4.4.6 TEST RESULTS

##### MODE A FOR GFSK MODULATION

Mode	Number of transmission in a 31.6 (79Hopping*0.4)	Length of transmission time (msec)	Result (msec)	Limit (msec)
DH1	50 (times / 5 sec) *6.32=316.00 times	0.516	163.056	400
DH3	25 (times / 5 sec) *6.32=158.00 times	1.788	282.504	400
DH5	18 (times / 5 sec) *6.32=113.76 times	3.03	344.6928	400

**NOTE:** Test plots of the transmitting time slot are shown on next 3 pages.

DH1

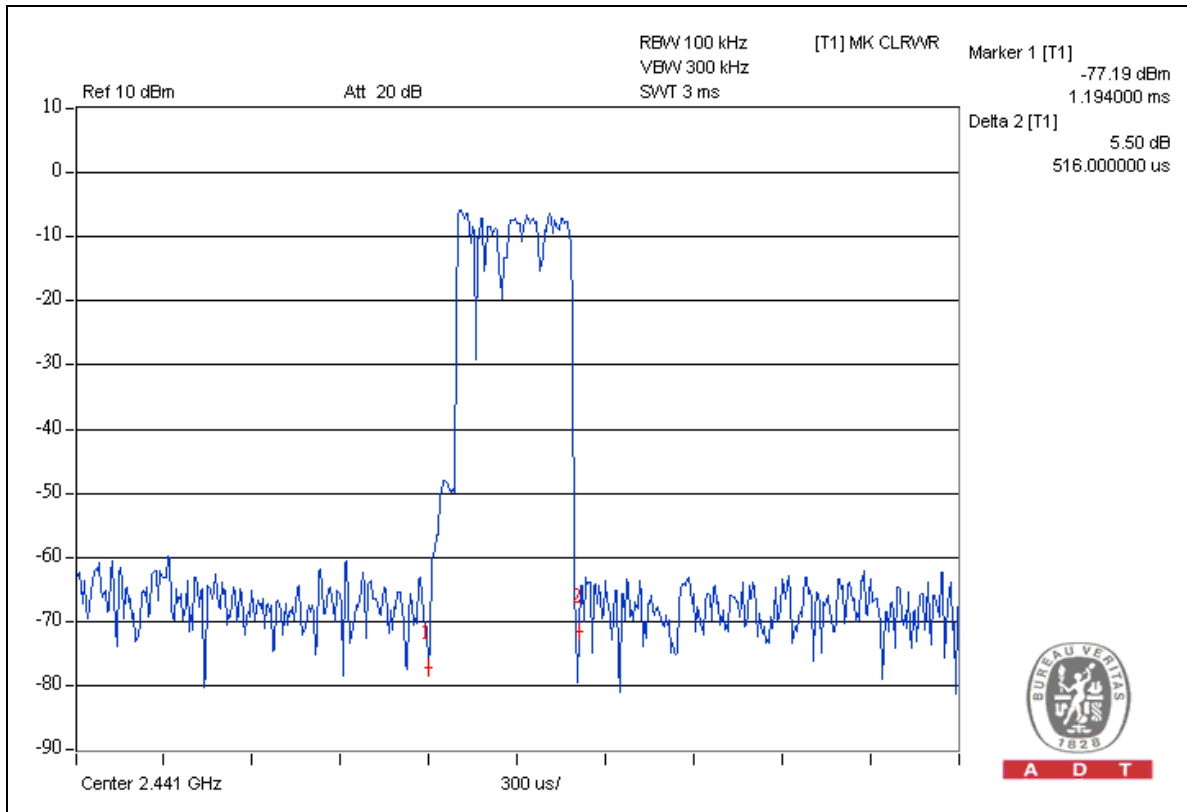
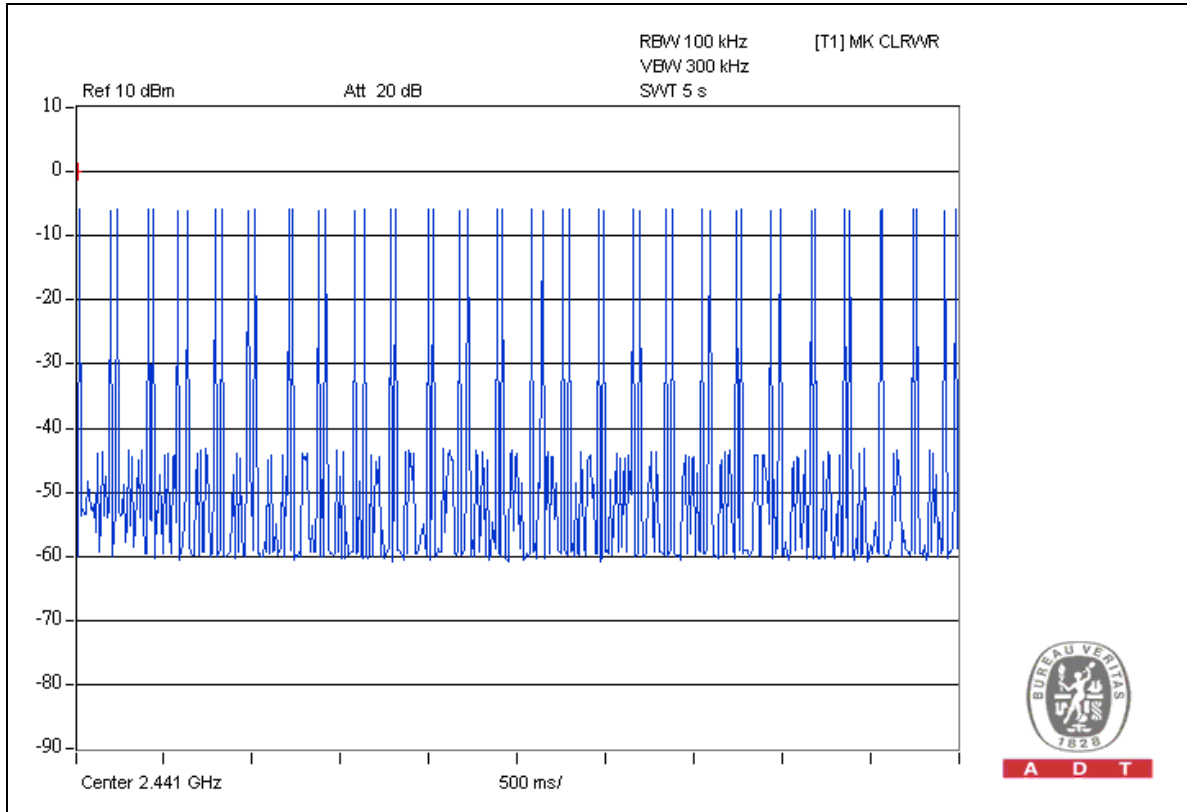

DH3

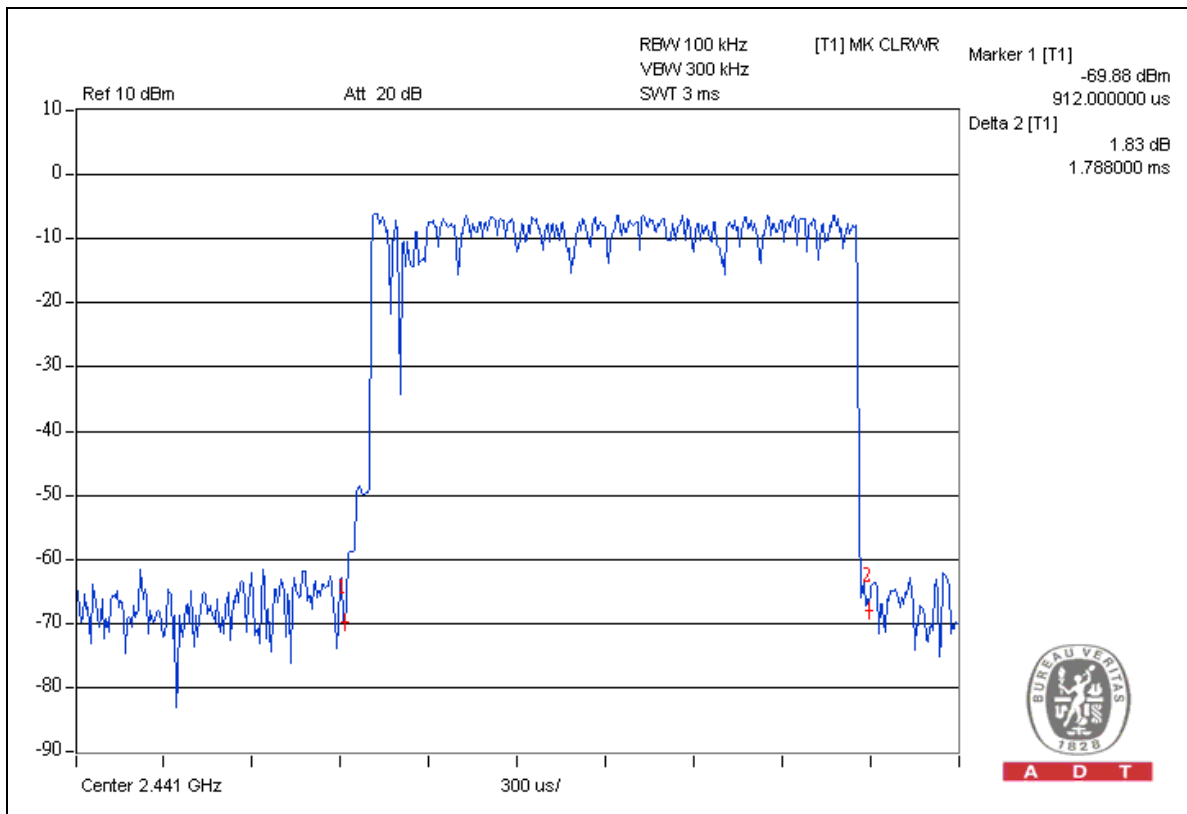
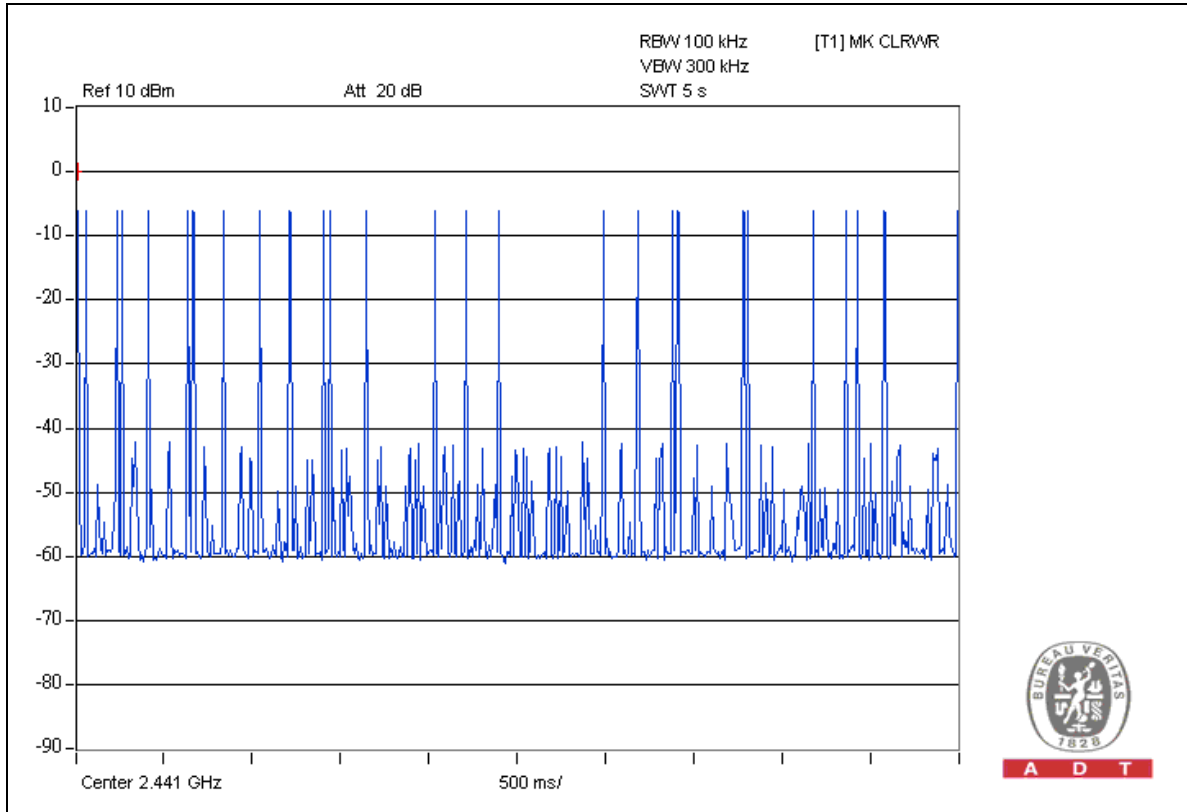

DH5

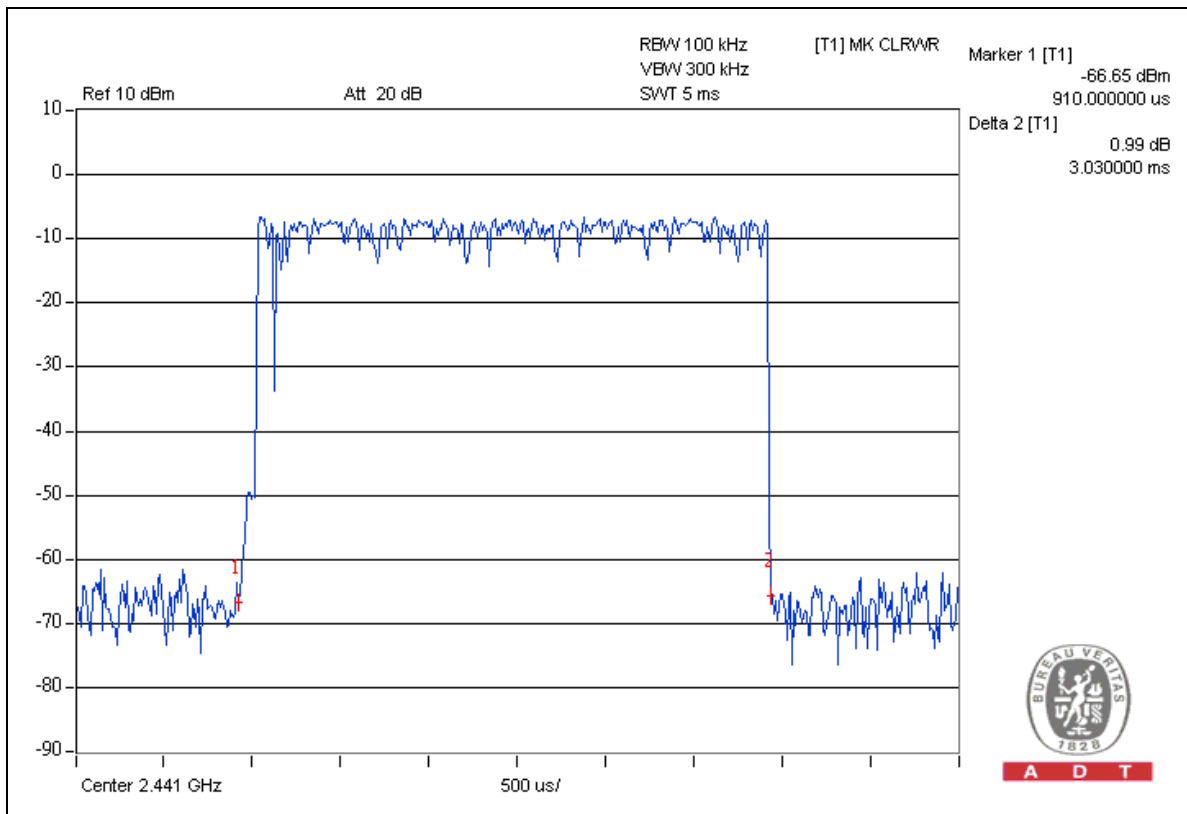
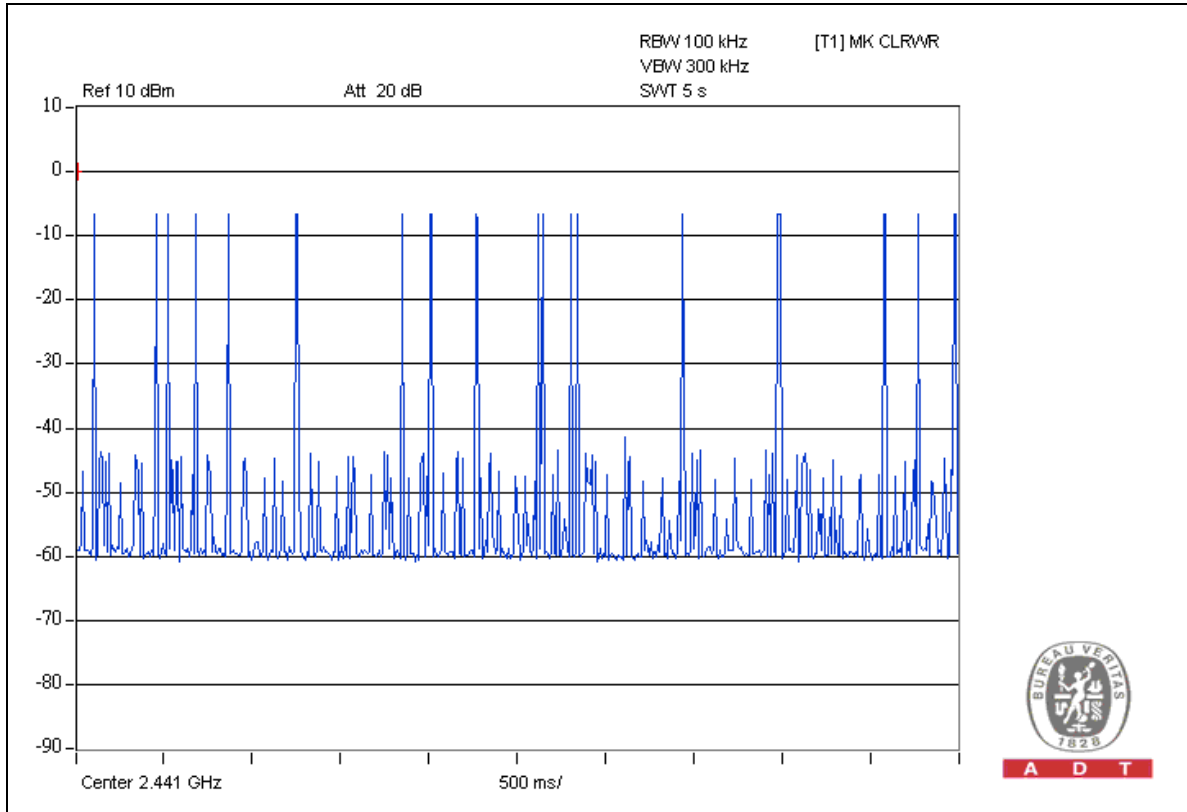

### MODE A FOR 8DPSK MODULATION

Mode	Number of transmission in a 31.6 (79Hopping*0.4)	Length of transmission time (msec)	Result (msec)	Limit (msec)
DH1	50 (times / 5 sec) *6.32=316.00 times	0.504	159.264	400
DH3	25 (times / 5 sec) *6.32=158.00 times	1.656	261.648	400
DH5	16 (times / 5 sec) *6.32=101.12 times	3.04	307.4048	400

**NOTE:** Test plots of the transmitting time slot are shown on next 3 pages.

DH1

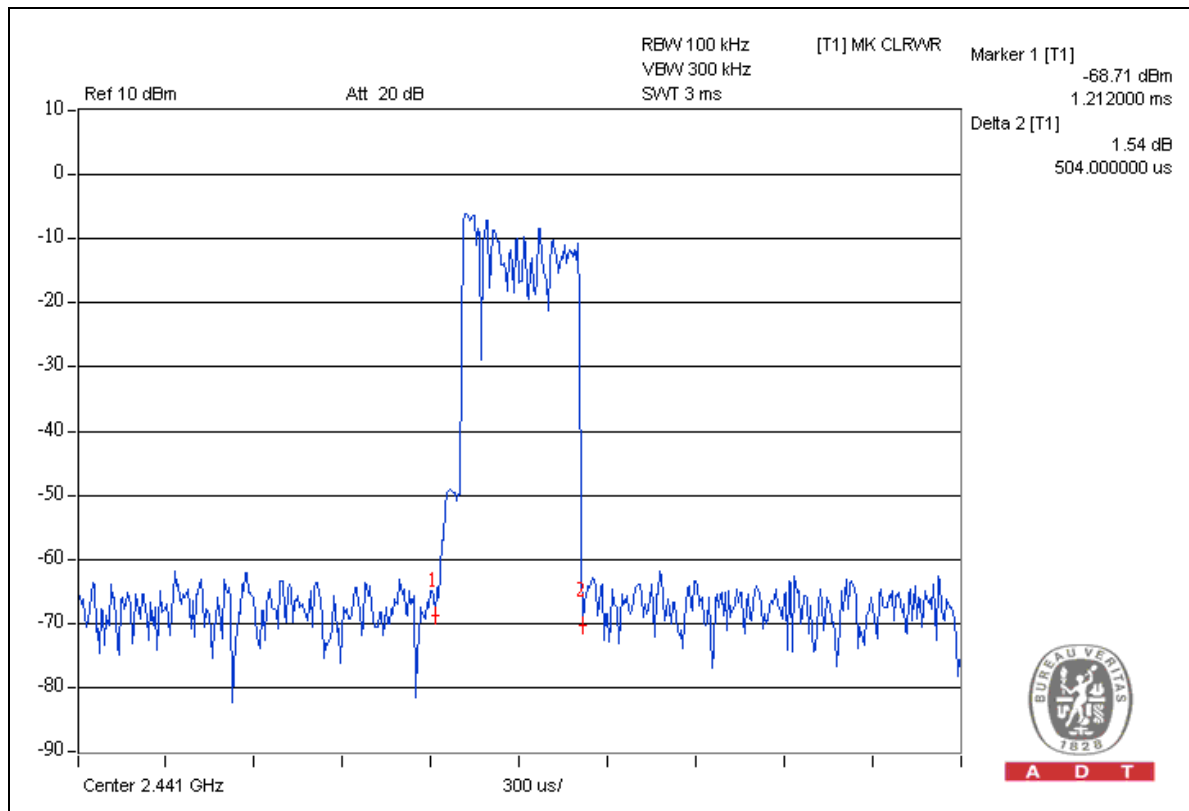
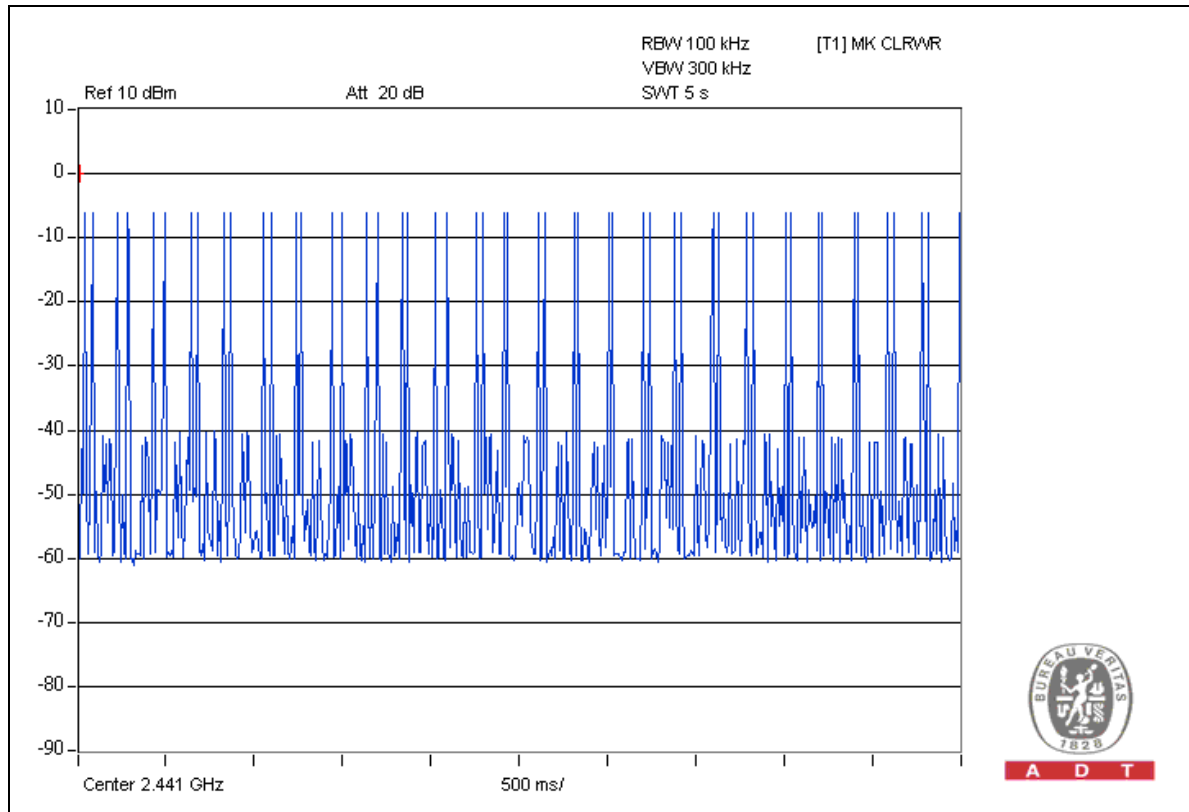

DH3

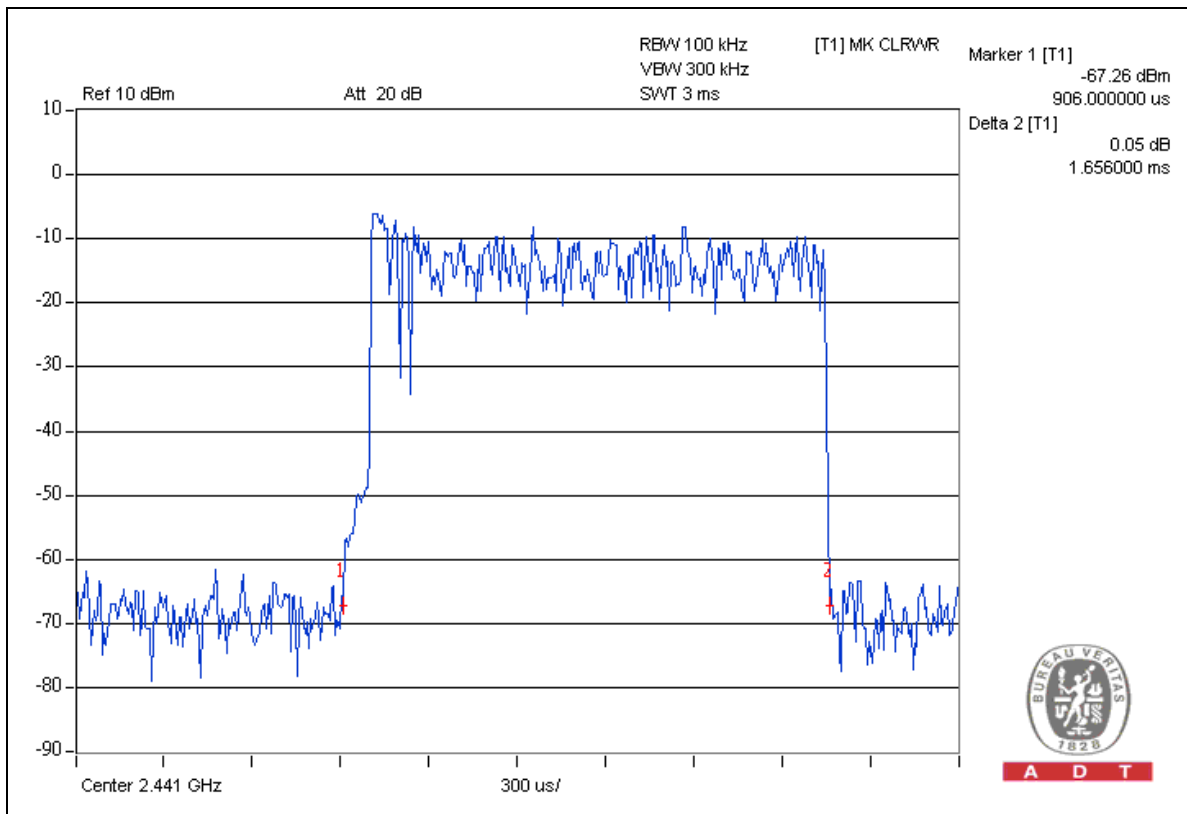
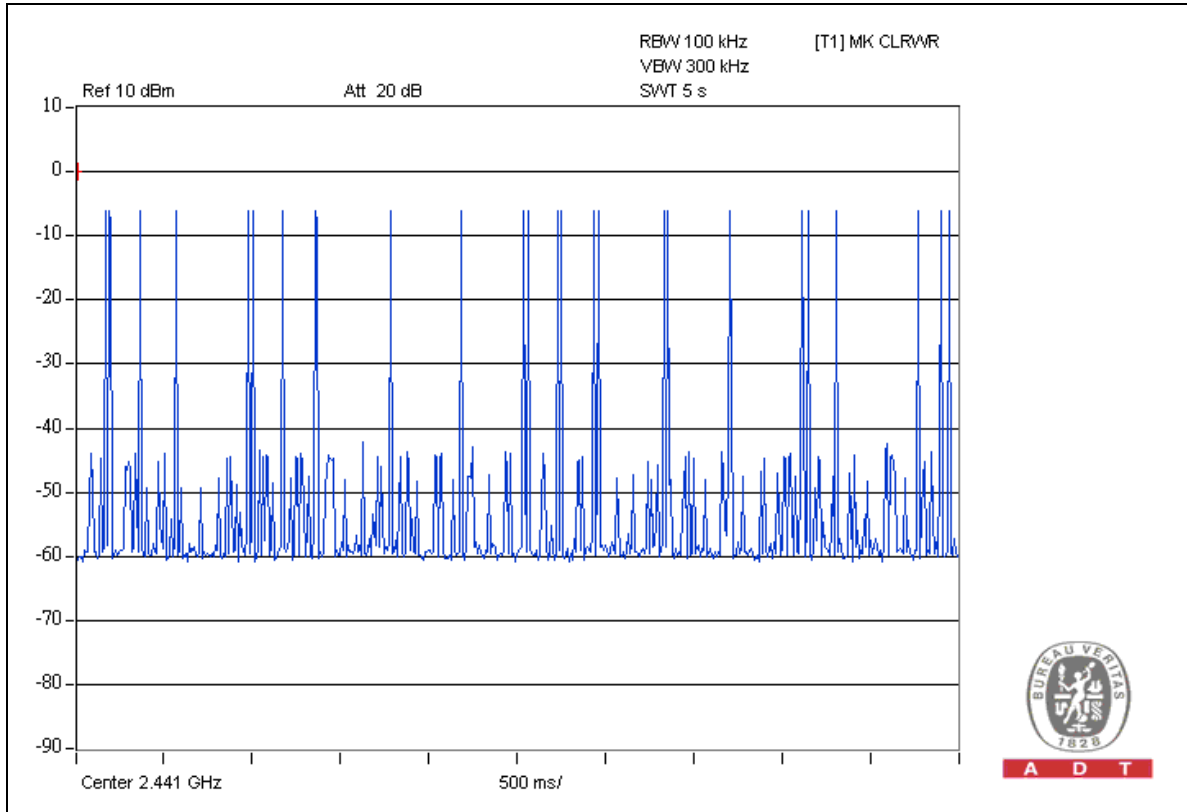



DH5

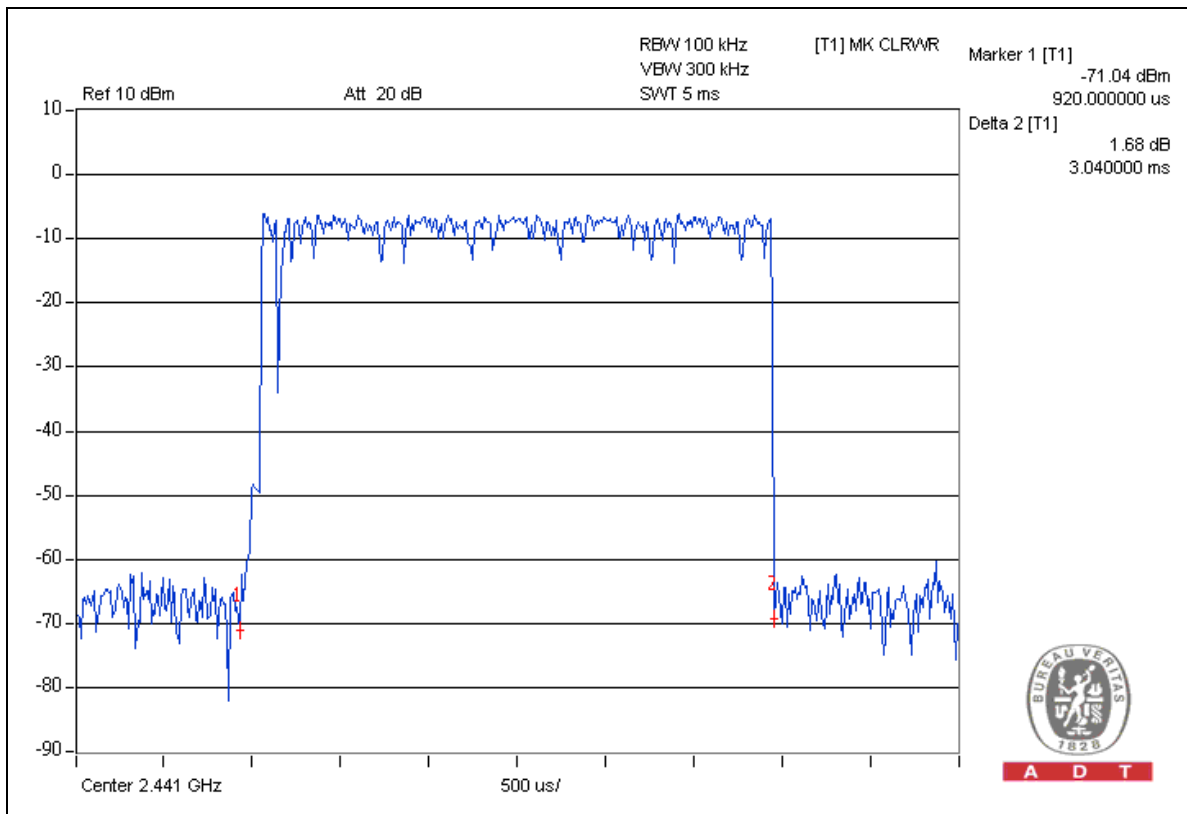
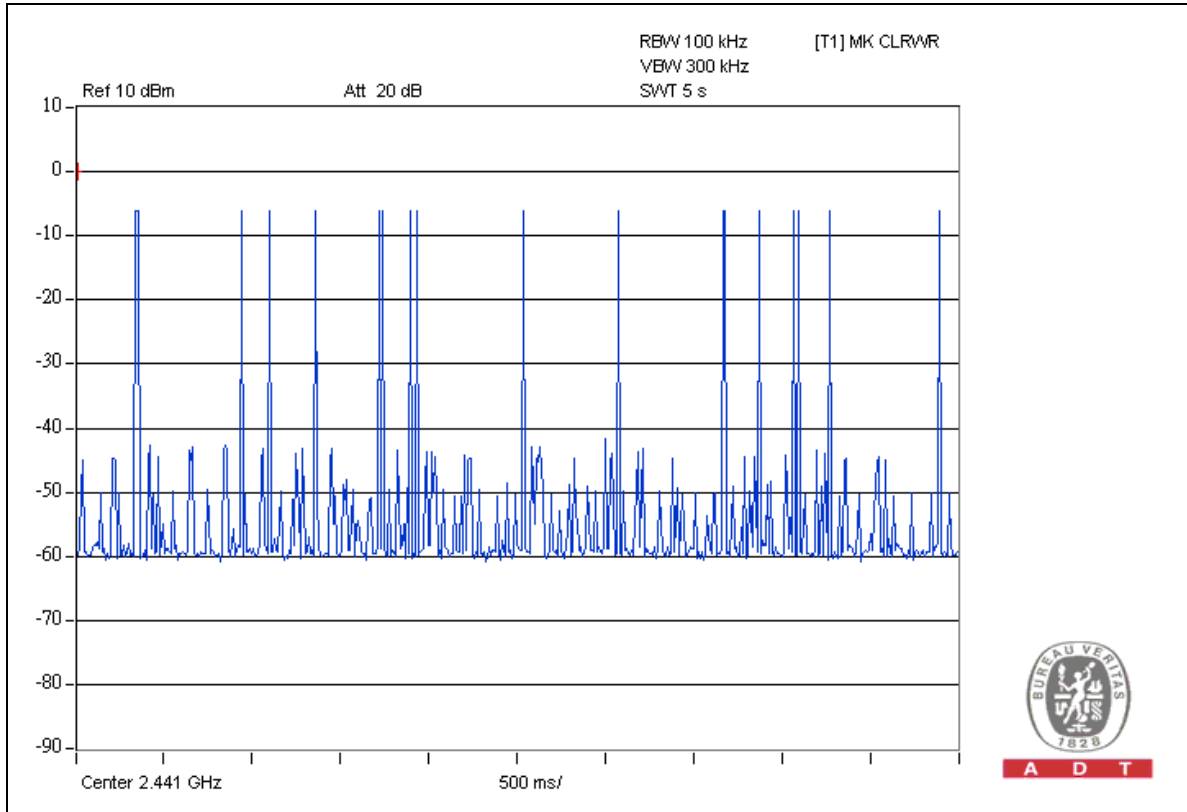



## 4.5 CHANNEL BANDWIDTH

### 4.5.1 LIMITS OF CHANNEL BANDWIDTH

For frequency hopping system operating in the 2400-2483.5MHz, If the 20dB bandwidth of hopping channel is greater than 25kHz, two-thirds 20dB bandwidth of hopping channel shall be a minimum limit for the hopping channel separation.

### 4.5.2 TEST INSTRUMENTS

DESCRIPTION & MANUFACTURER	MODEL NO.	SERIAL NO.	CALIBRATED DATE	CALIBRATED UNTIL
SPECTRUM ANALYZER	FSP 40	100035	Mar. 26, 2008	Mar. 25, 2009

**NOTE:** The calibration interval of the above test instruments is 12 months and the calibrations are traceable to NML/ROC and NIST/USA.

### 4.5.3 TEST PROCEDURE

- a. Check the calibration of the measuring instrument using either an internal calibrator or a known signal from an external generator.
- b. Turn on the EUT and connect it to measurement instrument. Then set it to any one convenient frequency within its operating range. Set a reference level on the measuring instrument equal to the highest peak value.
- c. Measure the frequency difference of two frequencies that were attenuated 20dB from the reference level. Record the frequency difference as the emission bandwidth.
- d. Repeat above procedures until all frequencies measured were complete.

#### **4.5.4 DEVIATION FROM TEST STANDARD**

No deviation.

#### **4.5.5 TEST SETUP**

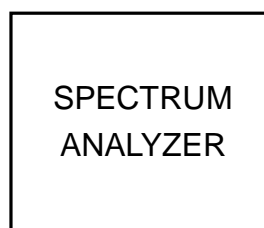

#### **4.5.6 EUT OPERATING CONDITION**

The software provided by client enabled the EUT to transmit and receive data at lowest, middle and highest channel frequencies individually.

## 4.5.7 TEST RESULTS

### FOR GFSK MODULATION

<b>TEST MODE</b>	A		
<b>MODULATION TYPE</b>	GFSK	<b>CHANNEL</b>	0, 39, 78
<b>INPUT POWER</b>	120Vac, 60 Hz	<b>ENVIRONMENTAL CONDITIONS</b>	26deg. C, 65% RH, 1000hPa
<b>TESTED BY</b>	Chad Lee		

CHANNEL	CHANNEL FREQUENCY (MHz)	20dB BANDWIDTH (MHz)
0	2402	0.943
39	2441	0.952
78	2480	0.947

### CH 0

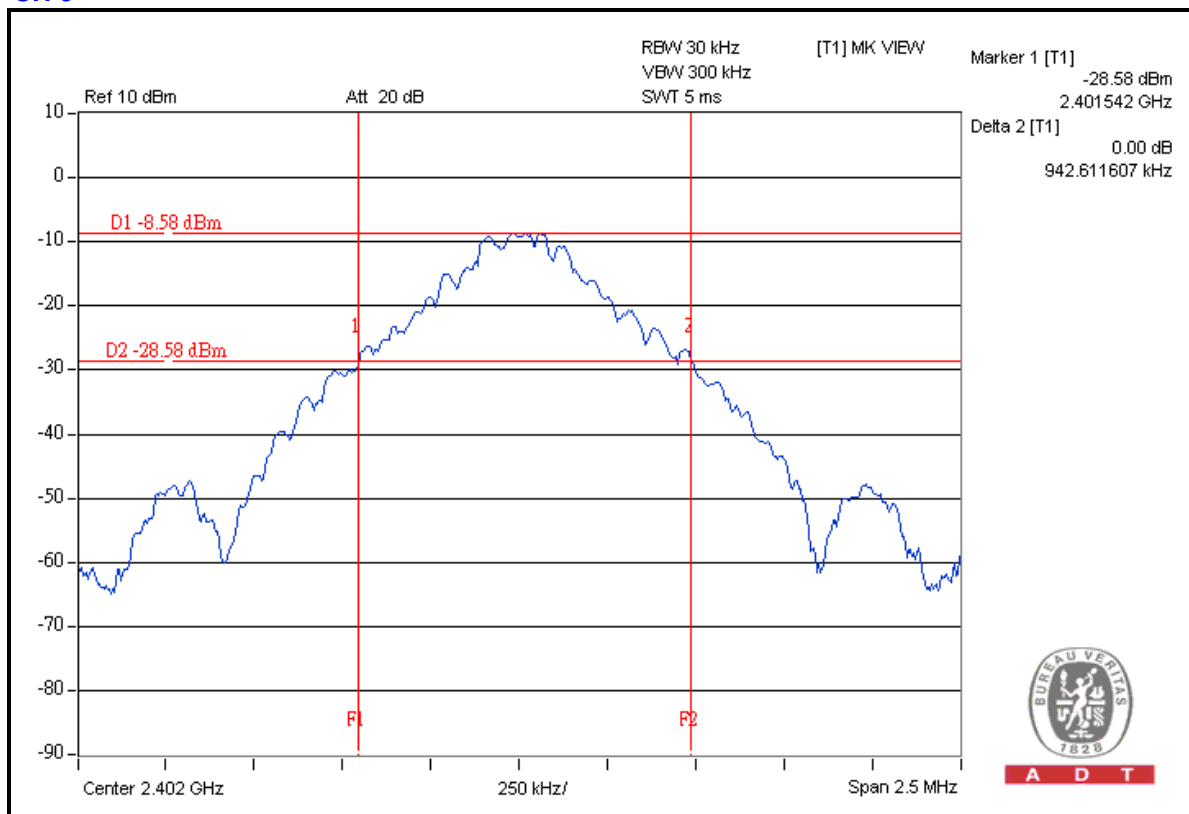

### CH 39

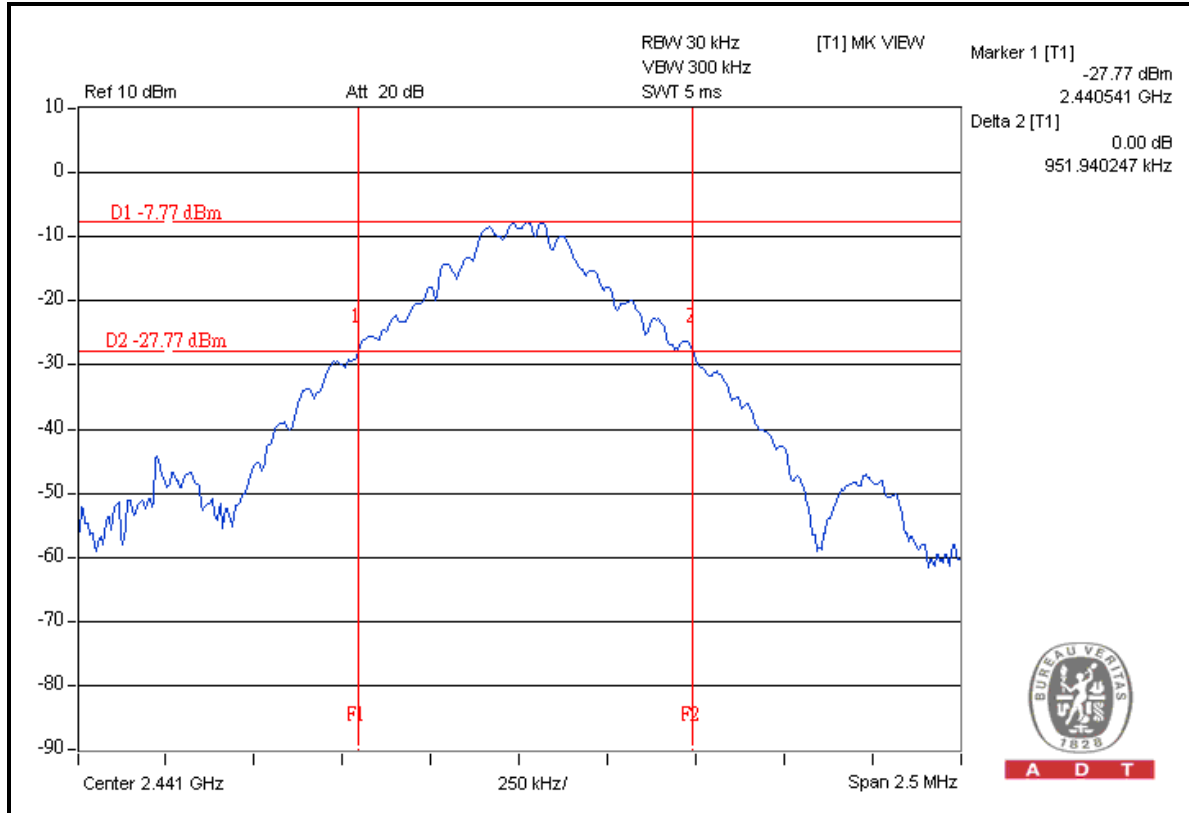

### CH 78

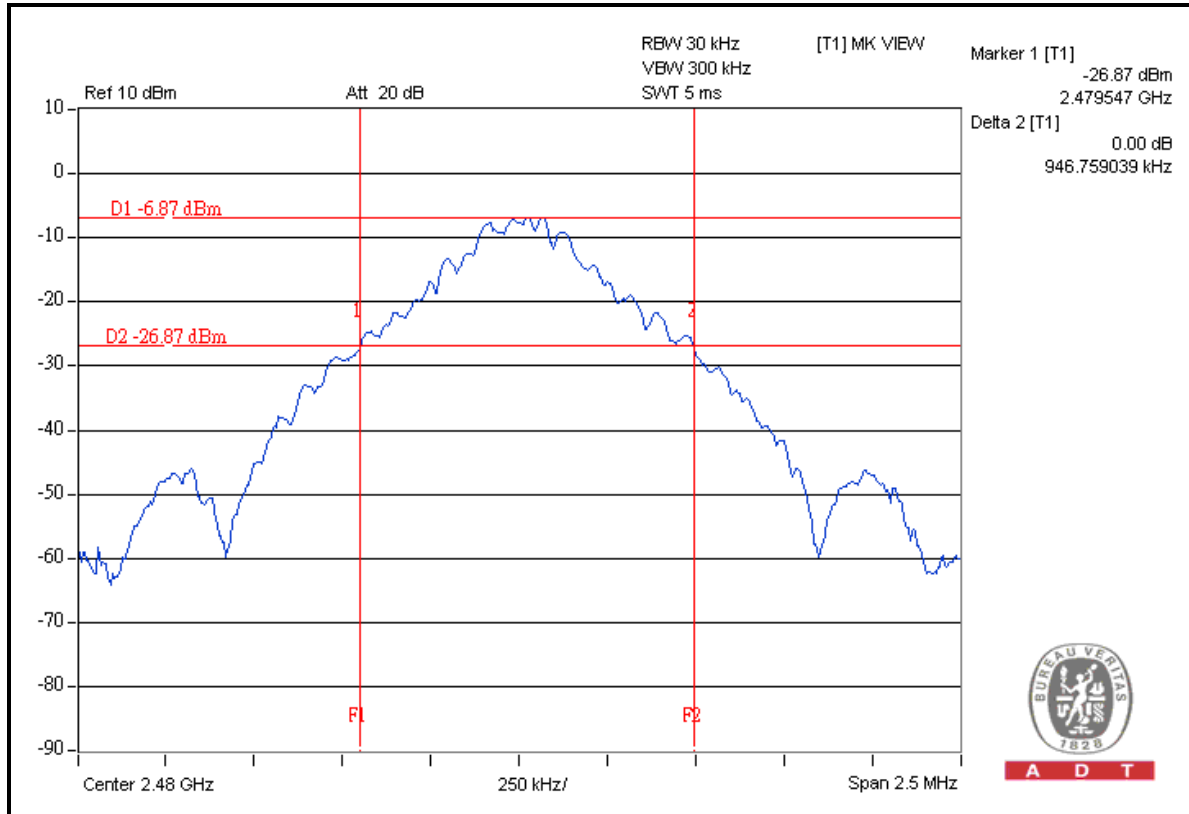



**FOR 8DPSK MODULATION**

<b>TEST MODE</b>	A		
<b>MODULATION TYPE</b>	8DPSK	<b>CHANNEL</b>	0, 39, 78
<b>INPUT POWER</b>	120Vac, 60 Hz	<b>ENVIRONMENTAL CONDITIONS</b>	26deg. C, 65% RH, 1000hPa
<b>TESTED BY</b>	Chad Lee		

CHANNEL	CHANNEL FREQUENCY (MHz)	20dB BANDWIDTH (MHz)
0	2402	1.348
39	2441	1.352
78	2480	1.355

**CH 0**

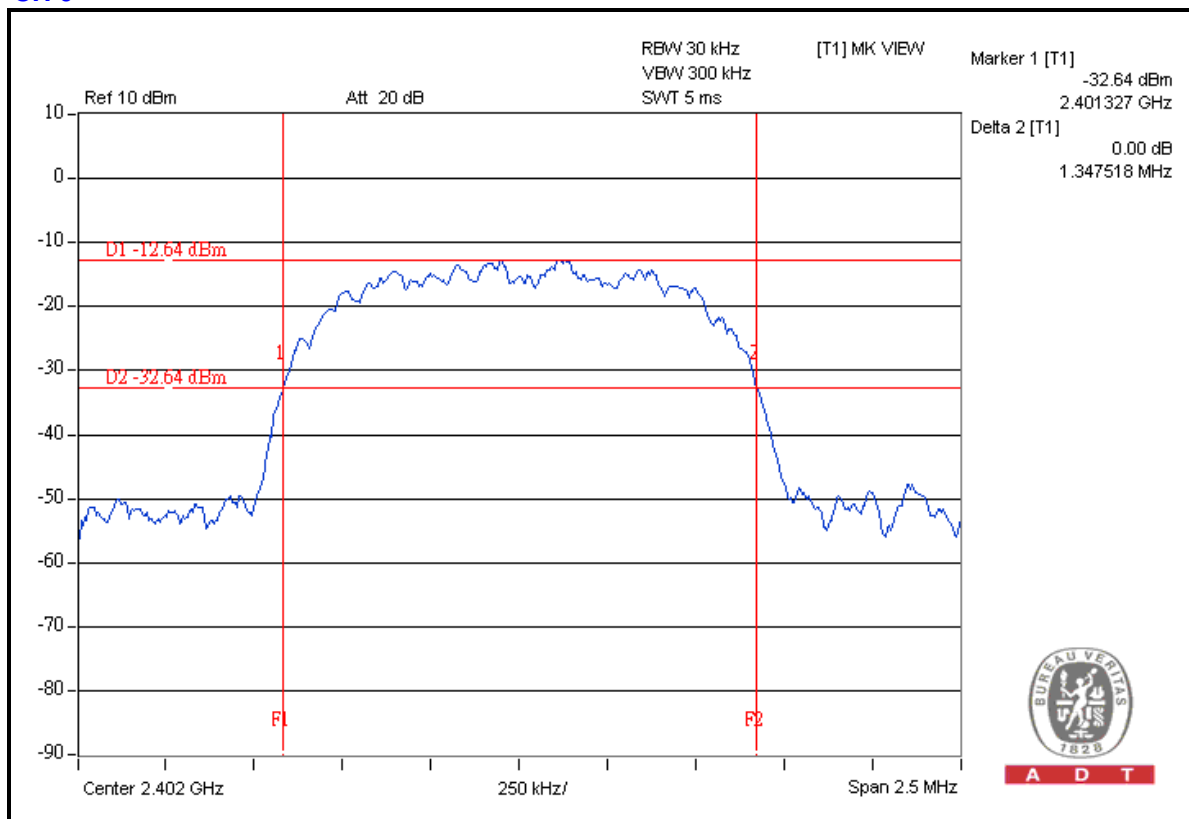

### CH 39

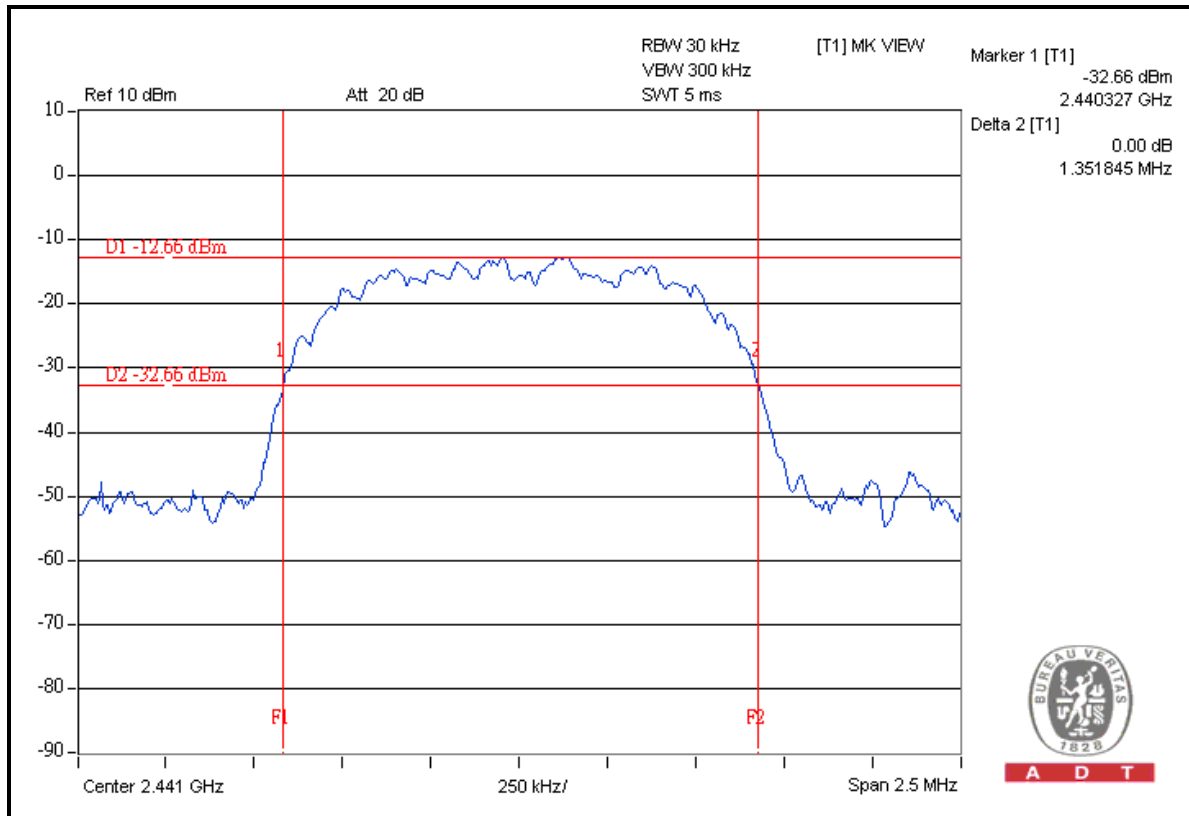

### CH 78

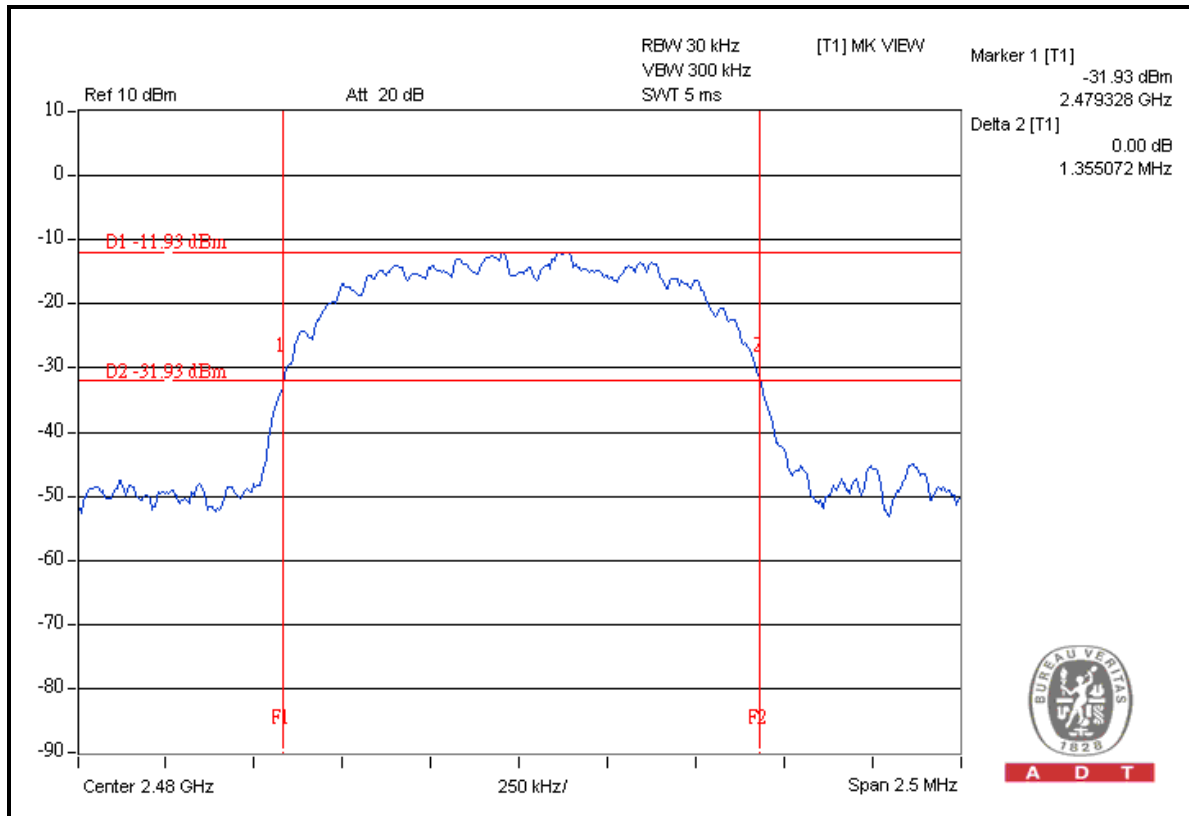



## 4.6 HOPPING CHANNEL SEPARATION

### 4.6.1 LIMIT OF HOPPING CHANNEL SEPARATION

At least 25kHz or two-third of 20dB hopping channel bandwidth (whichever is greater).

### 4.6.2 TEST INSTRUMENTS

DESCRIPTION & MANUFACTURER	MODEL NO.	SERIAL NO.	CALIBRATED DATE	CALIBRATED UNTIL
SPECTRUM ANALYZER	FSP 40	100035	Mar. 26, 2008	Mar. 25, 2009

**NOTE:** The calibration interval of the above test instruments is 12 months and the calibrations are traceable to NML/ROC and NIST/USA.

### 4.6.3 TEST PROCEDURES

1. Check the calibration of the measuring instrument using either an internal calibrator or a known signal from an external generator.
2. Turn on the EUT and connect it to measurement instrument. Then set it to any one convenient frequency within its operating range.
3. By using the MaxHold function record the separation of two adjacent channels.
4. Measure the frequency difference of these two adjacent channels by SA MARK function. And then plot the result on SA screen.
5. Repeat above procedures until all frequencies measured were complete.



#### 4.6.4 DEVIATION FROM TEST STANDARD

No deviation.

#### 4.6.5 TEST SETUP

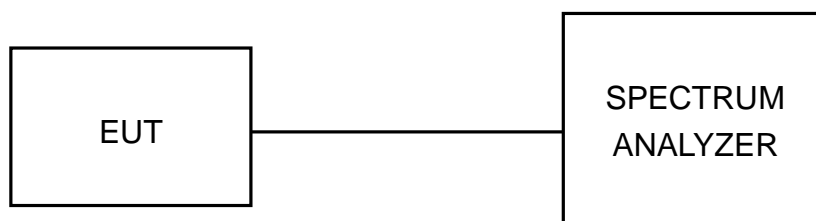

#### 4.6.6 TEST RESULTS

##### FOR GFSK MODULATION

<b>TEST MODE</b>	A		
<b>MODULATION TYPE</b>	GFSK	<b>CHANNEL</b>	0, 39, 78
<b>INPUT POWER</b>	120Vac, 60 Hz	<b>ENVIRONMENTAL CONDITIONS</b>	26deg. C, 65% RH, 1000hPa
<b>TESTED BY</b>	Chad Lee		

CHANNEL	FREQUENCY (MHz)	ADJACENT CHANNEL SEPARATION (MHz)	20dB BANDWIDTH (MHz)	MINIMUM LIMIT (MHz)	PASS / FAIL
0	2402	1.000	0.943	0.629	PASS
39	2441	1.006	0.952	0.635	PASS
78	2480	1.006	0.947	0.631	PASS

**NOTE:** The minimum limit is two-third 20dB bandwidth. Test results please refer to next two pages.

**CH 0**

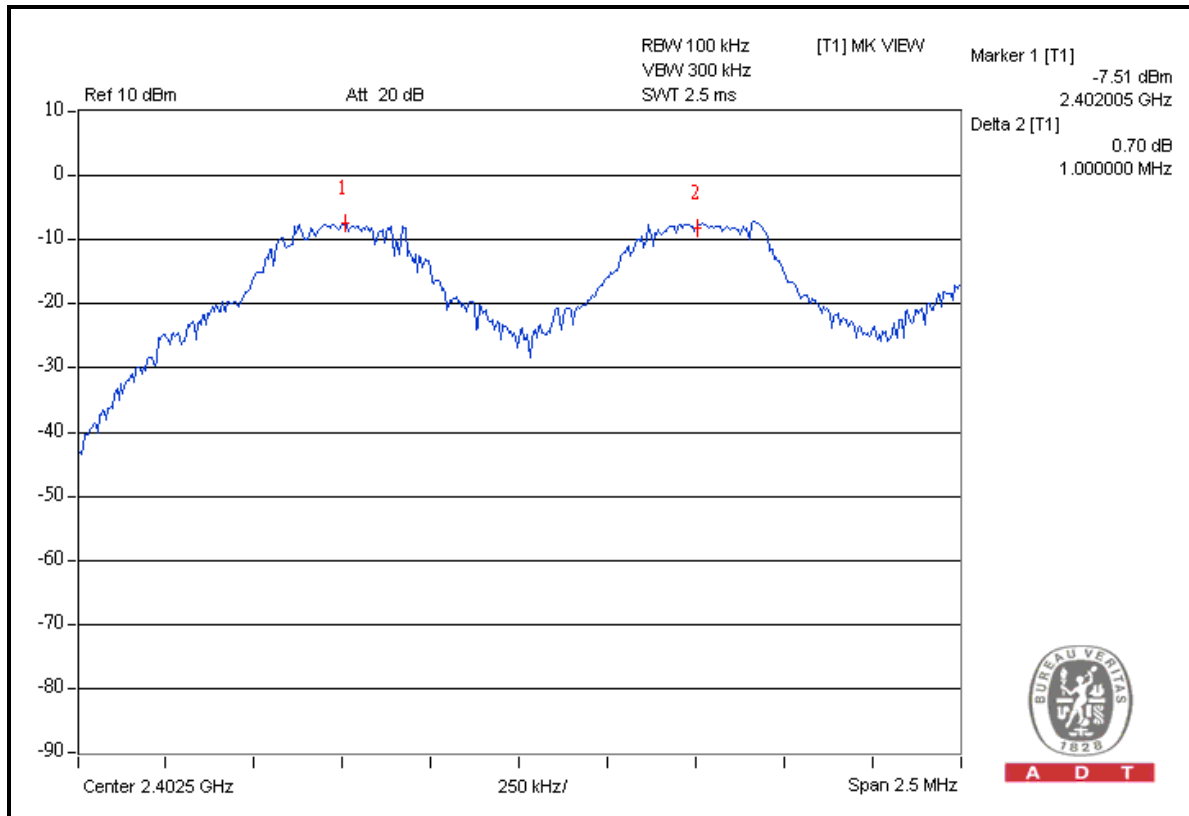

**CH 39**

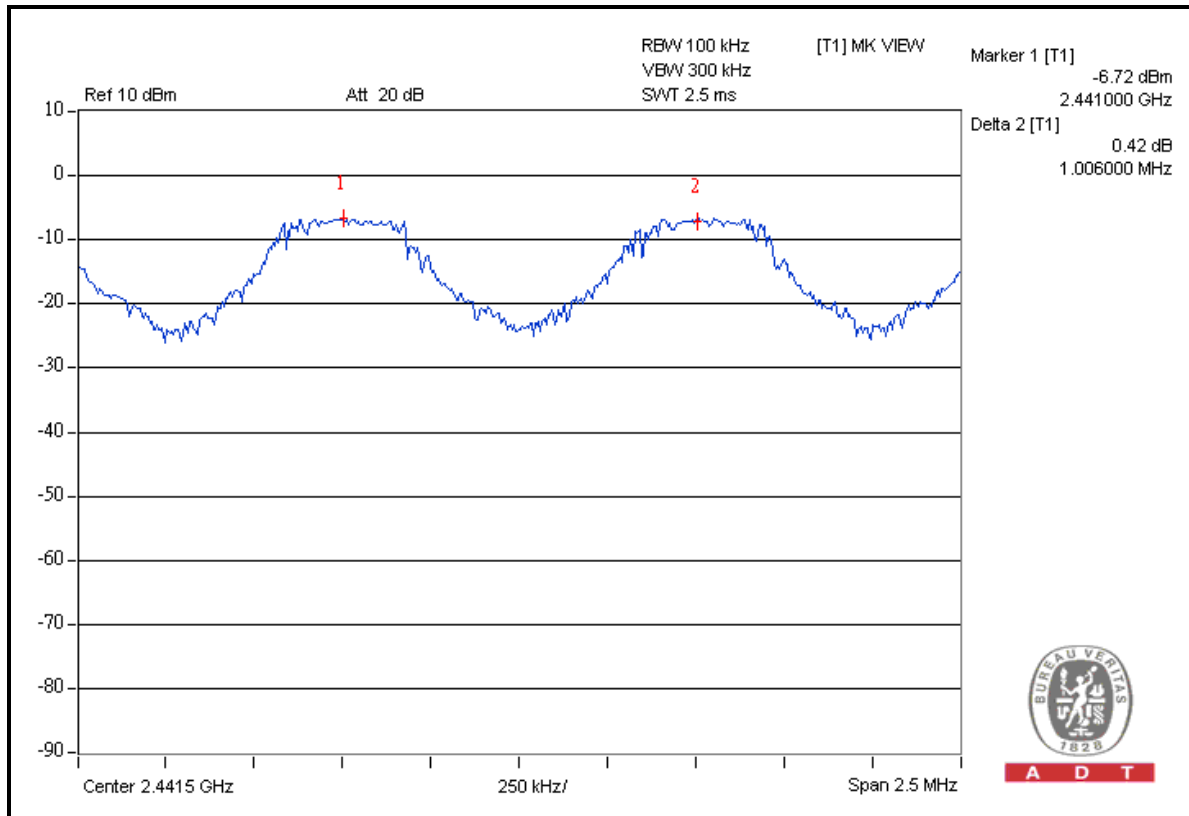

CH 78

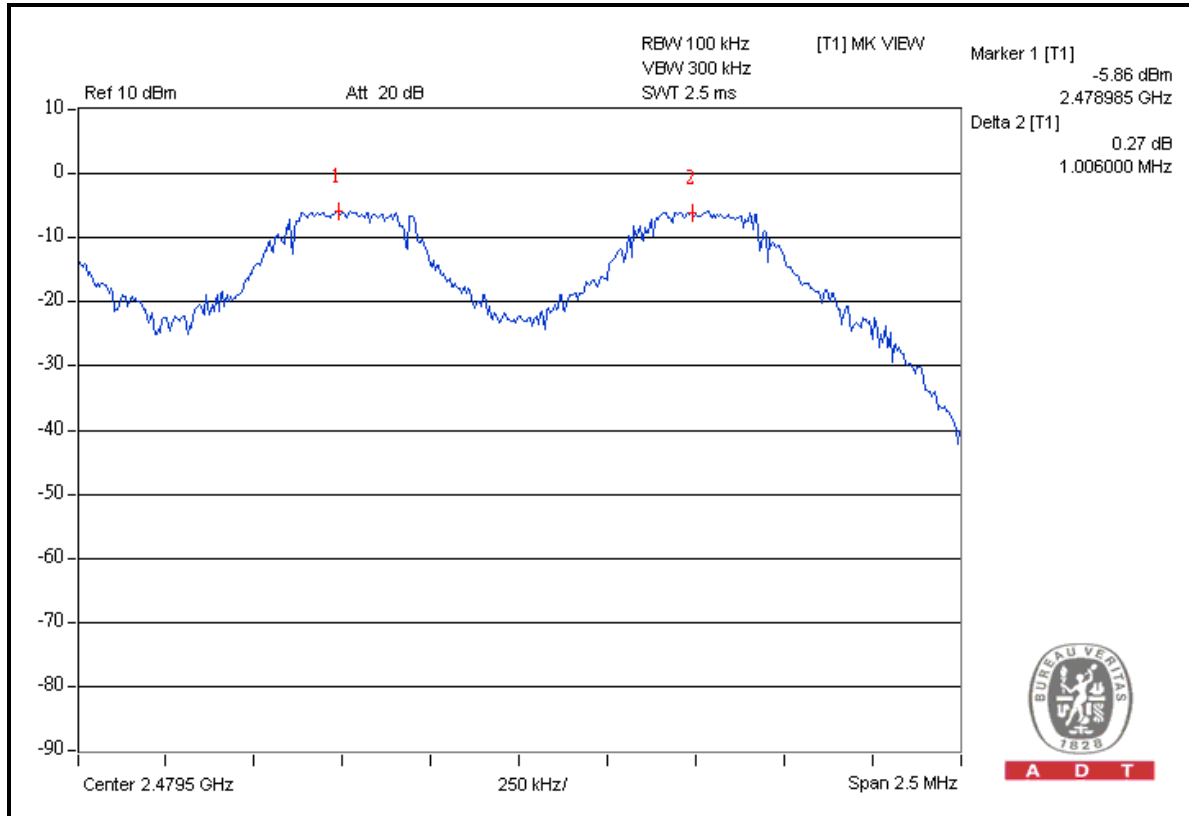



**CH 39**

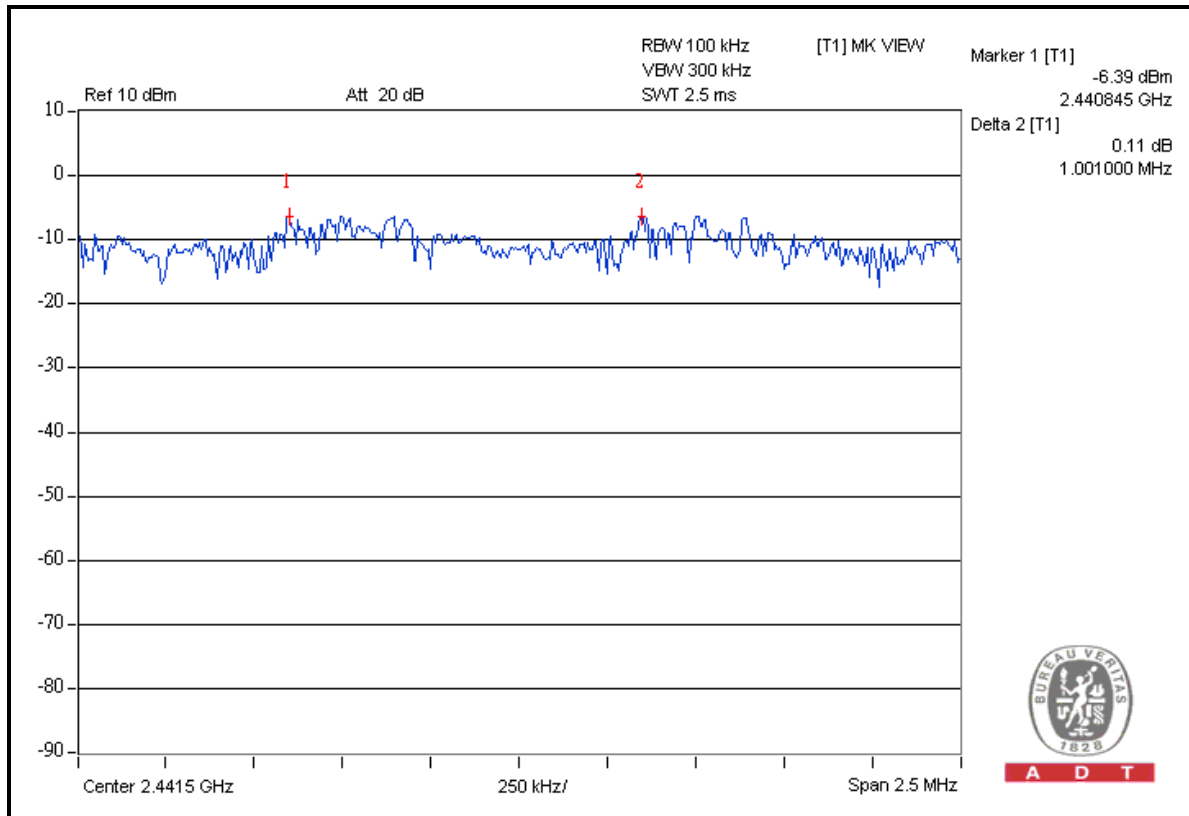

**CH 78**

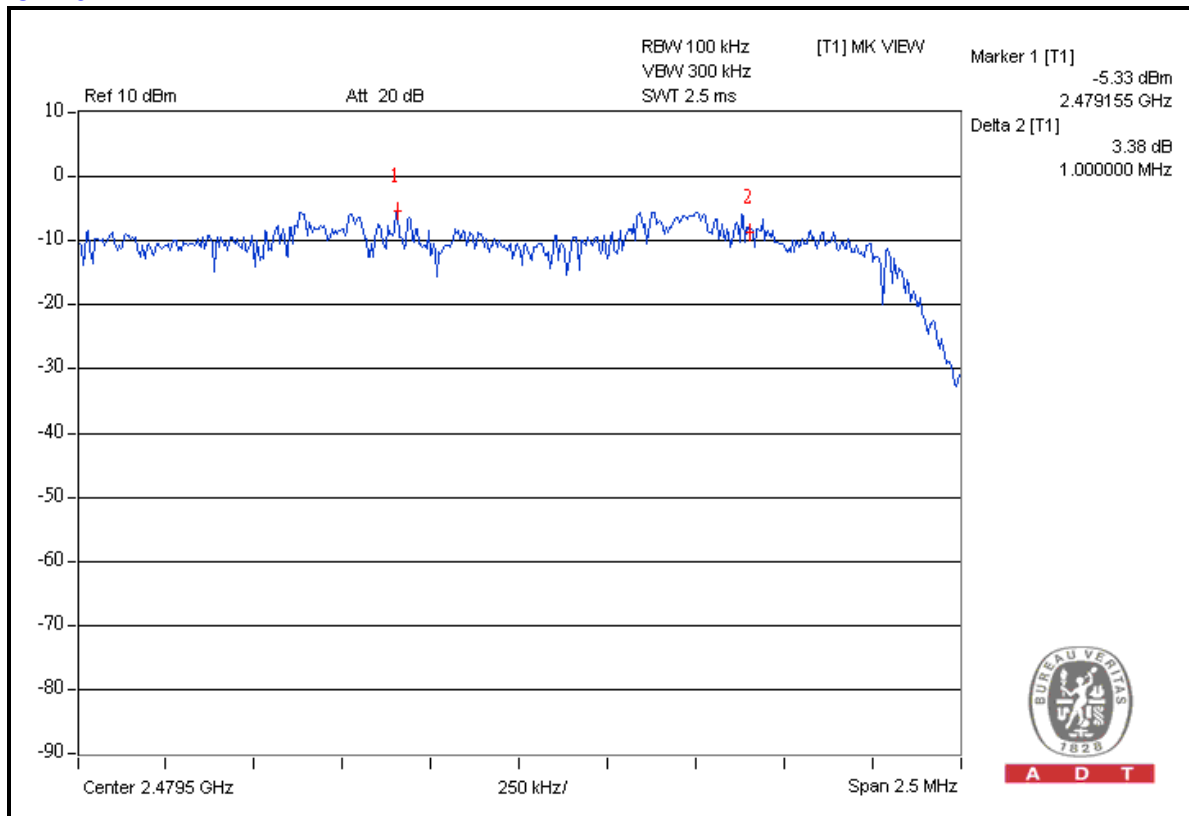



## 4.7 MAXIMUM PEAK OUTPUT POWER

### 4.7.1 LIMITS OF MAXIMUM PEAK OUTPUT POWER MEASUREMENT

The Maximum Peak Output Power Measurement is 125mW.

### 4.7.2 TEST INSTRUMENTS

DESCRIPTION & MANUFACTURER	MODEL NO.	SERIAL NO.	CALIBRATED DATE	CALIBRATED UNTIL
SPECTRUM ANALYZER	FSP 40	100035	Mar. 26, 2008	Mar. 25, 2009

**NOTE:** The calibration interval of the above test instruments is 12 months and the calibrations are traceable to NML/ROC and NIST/USA.

### 4.7.3 TEST PROCEDURES

- a. Check the calibration of the measuring instrument using either an internal calibrator or a known signal from an external generator.
- b. Turn on the EUT and connect it to measurement instrument. Then set it to any one convenient frequency within its operating range. Set a reference level on the measuring instrument equal to the highest peak value.
- c. The center frequency of the spectrum analyzer is set to the fundamental frequency and using 3MHz RBW and 10 MHz VBW.
- d. Measure the captured power within the band and recording the plot.
- e. Repeat above procedures until all frequencies required were complete.

### 4.7.4 DEVIATION FROM TEST STANDARD

No deviation

## 4.7.5 TEST SETUP

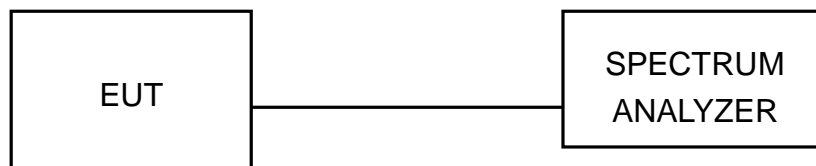

For the actual test configuration, please refer to the related Item – Photographs of the Test Configuration.

## 4.7.6 EUT OPERATING CONDITION

The software provided by client enabled the EUT to transmit and receive data at lowest, middle and highest channel frequencies individually.

## 4.7.7 TEST RESULTS

### FOR GFSK MODULATION

<b>TEST MODE</b>	A		
<b>MODULATION TYPE</b>	GFSK	<b>CHANNEL</b>	0, 39, 78
<b>INPUT POWER</b>	120Vac, 60 Hz	<b>ENVIRONMENTAL CONDITIONS</b>	26deg. C, 65% RH, 1000hPa
<b>TESTED BY</b>	Chad Lee		

CHANNEL	CHANNEL FREQUENCY (MHz)	PEAK POWER OUTPUT (mW)	PEAK POWER OUTPUT (dBm)	PEAK POWER LIMIT (mW)	PASS/FAIL
0	2402	0.234	-6.30	125	PASS
39	2441	0.262	-5.81	125	PASS
78	2480	0.338	-4.71	125	PASS

**CH 0**

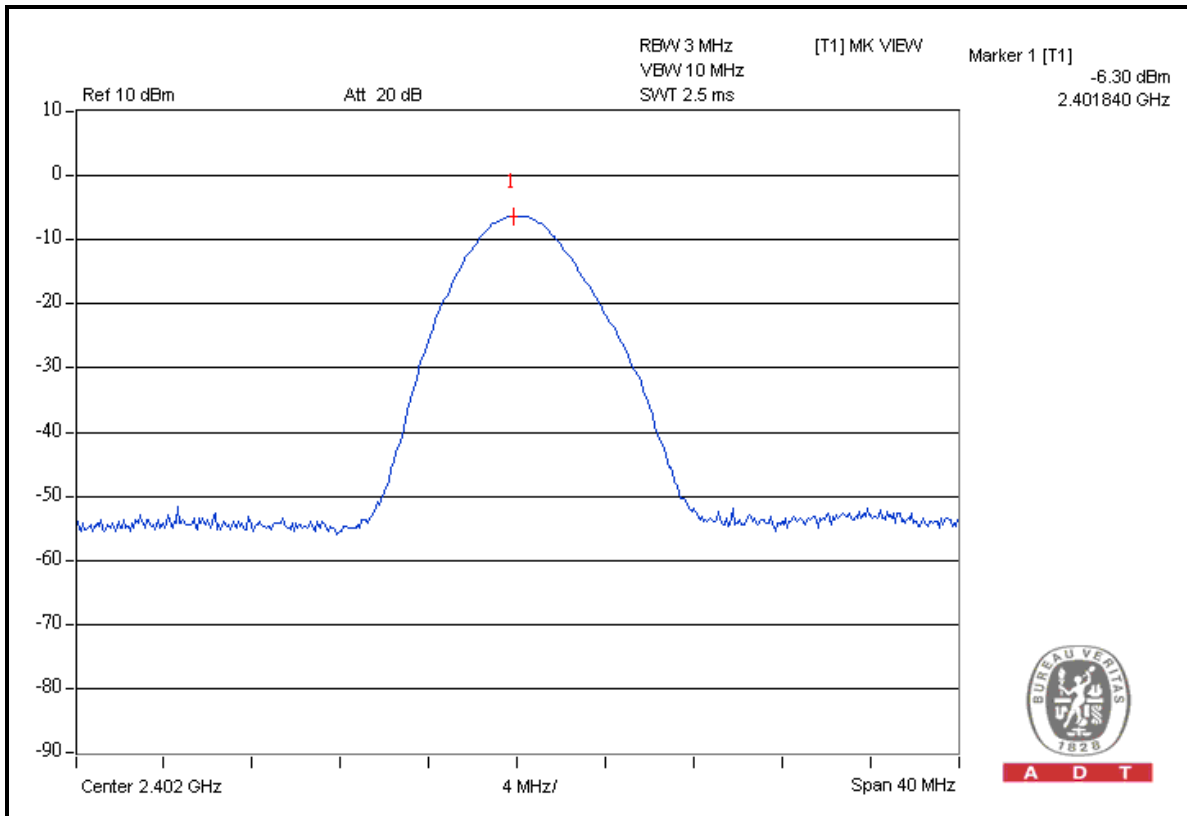

**CH 39**

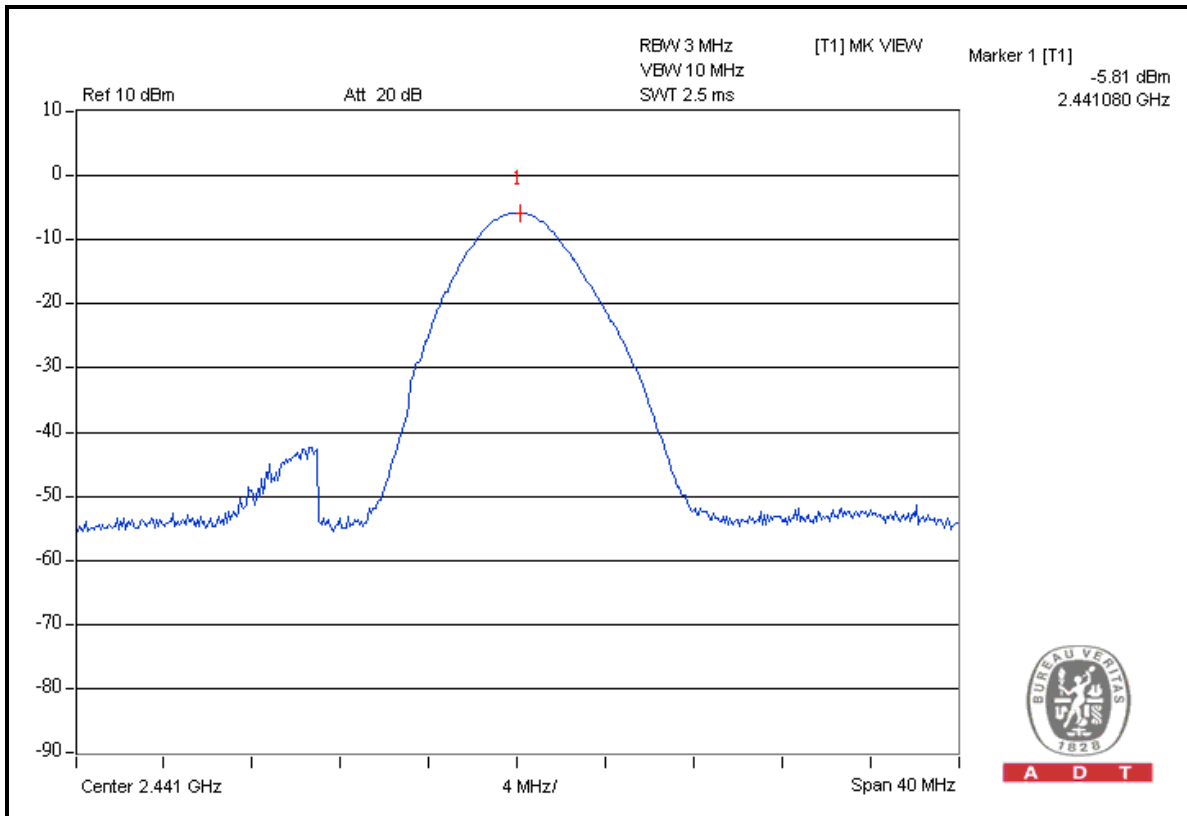







**FOR 8DPSK MODULATION**

<b>TEST MODE</b>	A		
<b>MODULATION TYPE</b>	8DPSK	<b>CHANNEL</b>	0, 39, 78
<b>INPUT POWER</b>	120Vac, 60 Hz	<b>ENVIRONMENTAL CONDITIONS</b>	26deg. C, 65% RH, 1000hPa
<b>TESTED BY</b>	Chad Lee		

CHANNEL	CHANNEL FREQUENCY (MHz)	PEAK POWER OUTPUT (mW)	PEAK POWER OUTPUT (dBm)	PEAK POWER LIMIT (mW)	PASS/FAIL
0	2402	0.368	-4.34	125	PASS
39	2441	0.360	-4.44	125	PASS
78	2480	0.411	-3.86	125	PASS

**CH 0**

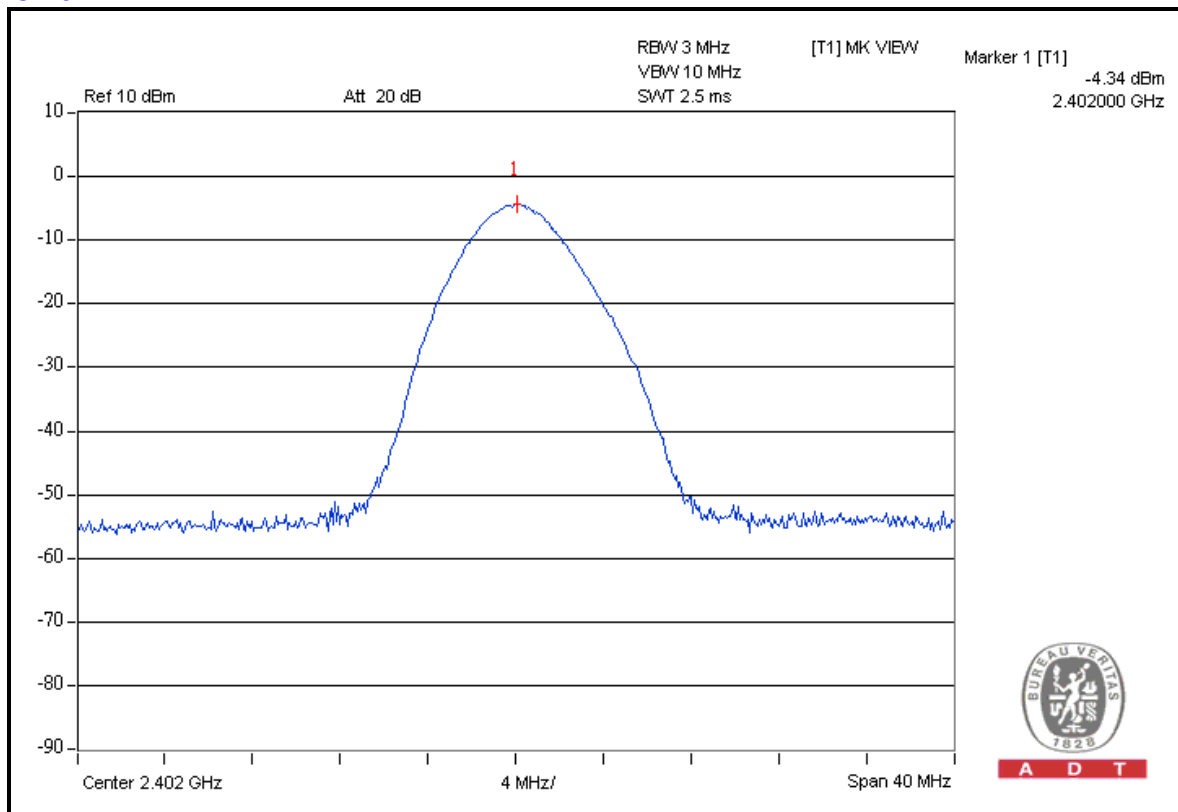





## 4.8 BAND EDGES MEASUREMENT

### 4.8.1 LIMITS OF BAND EDGES MEASUREMENT

Below  $-20\text{dB}$  of the highest emission level of operating band (in 100KHz RBW).

### 4.8.2 TEST INSTRUMENTS

DESCRIPTION & MANUFACTURER	MODEL NO.	SERIAL NO.	CALIBRATED DATE	CALIBRATED UNTIL
SPECTRUM ANALYZER	FSP 40	100035	Mar. 26, 2008	Mar. 25, 2009

**NOTE:** The calibration interval of the above test instruments is 12 months and the calibrations are traceable to NML/ROC and NIST/USA.

### 4.8.3 TEST PROCEDURE

The transmitter output was connected to the spectrum analyzer via a low lose cable. Set both RBW and VBW of spectrum analyzer to 100 kHz and 300 kHz with suitable frequency span including 100 MHz bandwidth from band edge. The band edges was measured and recorded.

The spectrum plots are attached on the following pages.

### 4.8.4 DEVIATION FROM TEST STANDARD

No deviation.

### 4.8.5 EUT OPERATING CONDITION

The software provided by client enabled the EUT to transmit and receive data at lowest, middle and highest channel frequencies individually.

## 4.8.6 TEST RESULTS

The spectrum plots are attached on the following 8 images. D1 line indicates the highest level, D2 line indicates the 20dB offset below D1. It shows compliance with the requirement in part 15.247(d).

### MODE A FOR GFSK MODULATION

#### NOTE 1:

The band edge emission plot on the next page shows 52.22dBc between carrier maximum power and local maximum emission in restrict band (2.38640GHz). The emission of carrier strength list in the test result of channel 0 at the item 4.2.7 is 97.52dBuV/m (Peak), so the maximum field strength in restrict band is  $97.52 - 52.22 = 45.3$  dBuV/m, which is under 74 dBuV/m limit.

Average value =  $45.3 - 30.10 = 15.2$  dBuV/m, which is under 54dBuV/m limit.

\*The DH5 packet was the worse case duty cycle for a transmit dwell time on a channel, based upon bluetooth theory the transmitter is on  $0.625 * 5$  per 296.25 ms per channel. Therefore, the duty cycle be equal to:  $20\log(3.125/100) = -30.1$  dB.

Average value = peak reading  $-30.10$ .

#### NOTE 2:

The band edge emission plot on the next second page shows 52.71dBc between carrier maximum power and local maximum emission in restrict band (2.49620GHz). The emission of carrier strength list in the test result of channel 78 at the item 4.2.7 is 100.29dBuV/m (Peak), so the maximum field strength in restrict band is  $100.29 - 52.71 = 47.58$  dBuV/m, which is under 74 dBuV/m limit.

Average value =  $47.58 - 30.10 = 17.48$  dBuV/m, which is under 54dBuV/m limit.

\*The DH5 packet was the worse case duty cycle for a transmit dwell time on a channel, based upon bluetooth theory the transmitter is on  $0.625 * 5$  per 296.25 ms per channel. Therefore, the duty cycle be equal to:  $20\log(3.125/100) = -30.1$  dB.

Average value = peak reading  $-30.10$ .

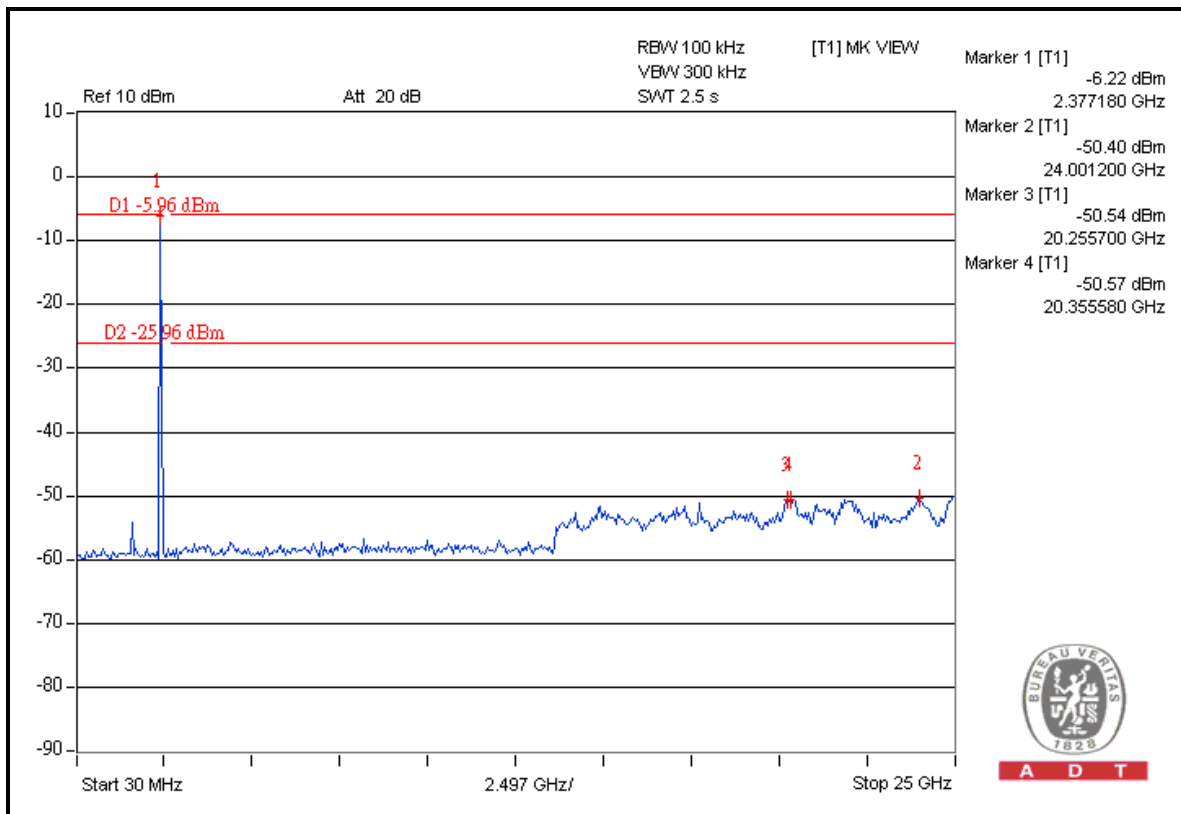
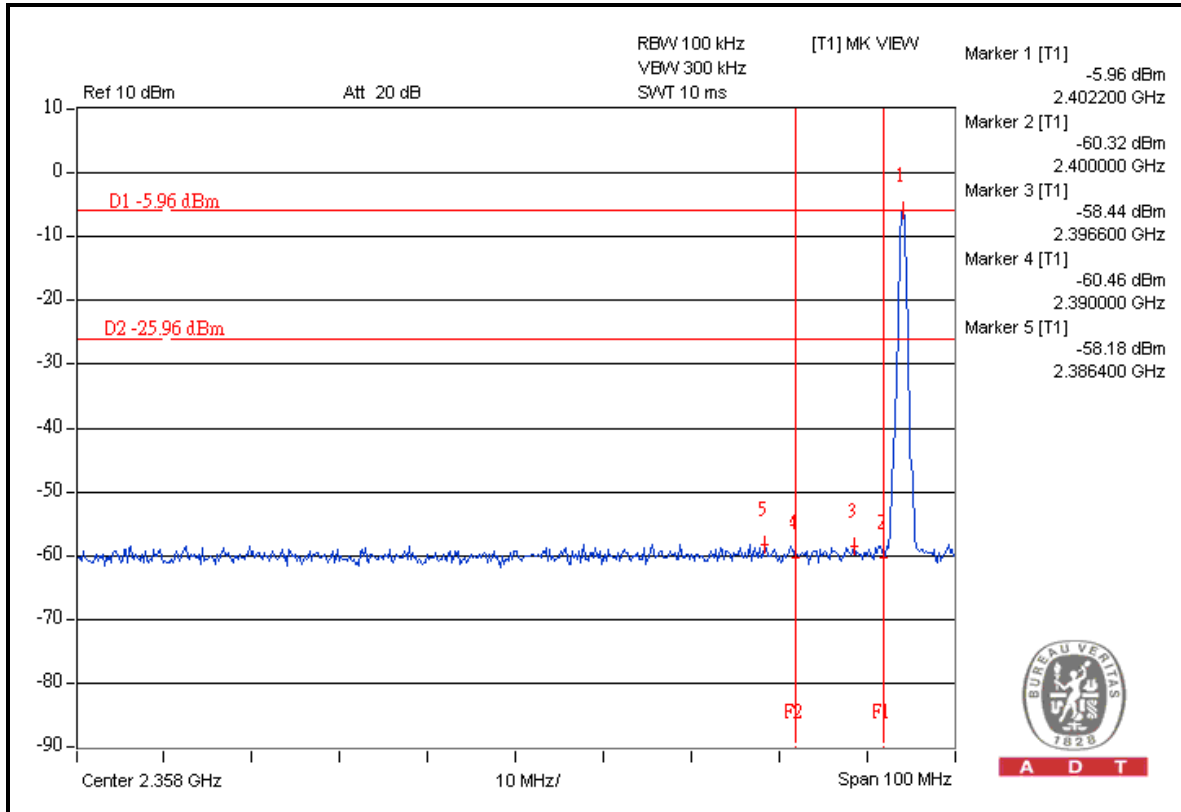

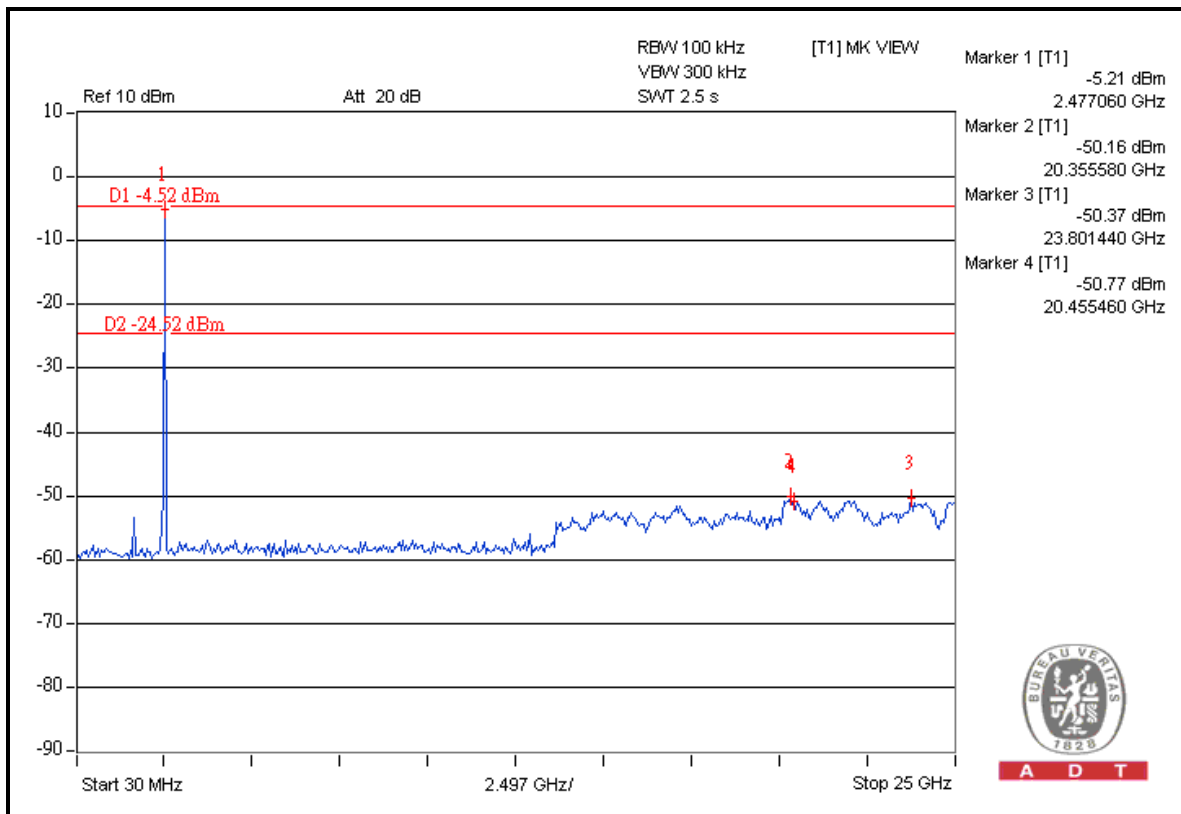
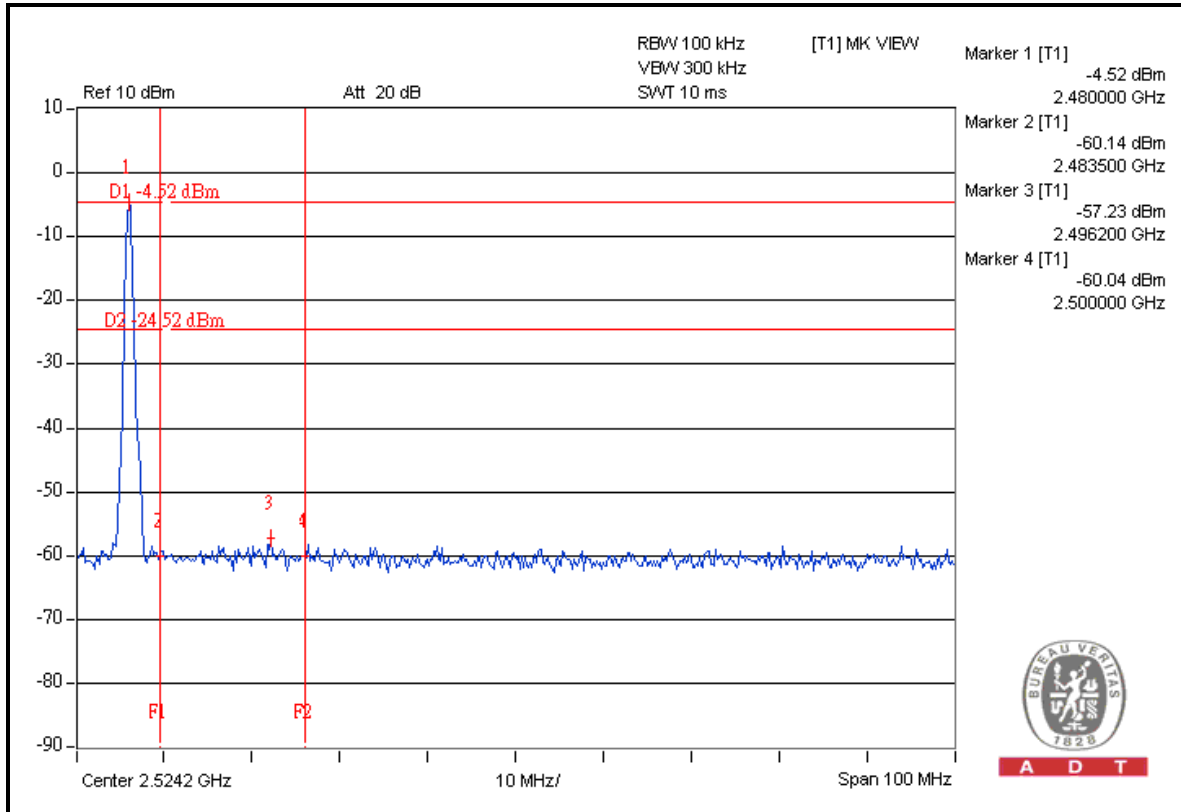

## MODE A FOR 8DPSK MODULATION

### NOTE 1:

The band edge emission plot on the next page shows 49.89dBc between carrier maximum power and local maximum emission in restrict band (2.3858GHz). The emission of carrier strength list in the test result of channel 0 at the item 4.2.7 is 99.07dBuV/m (Peak), so the maximum field strength in restrict band is  $99.07 - 49.89 = 49.18$ dBuV/m, which is under 74 dBuV/m limit.

Average value =  $49.18 - 30.10 = 19.08$ dBuV/m, which is under 54dBuV/m limit.

\*The DH5 packet was the worse case duty cycle for a transmit dwell time on a channel, based upon bluetooth theory the transmitter is on  $0.625 * 5$  per 296.25 ms per channel. Therefore, the duty cycle be equal to:  $20\log(3.125/100) = -30.1$  dB.

Average value = peak reading  $-30.10$ .

### NOTE 2:

The band edge emission plot on the next second page shows 50.46dBc between carrier maximum power and local maximum emission in restrict band (2.4958GHz). The emission of carrier strength list in the test result of channel 78 at the item 4.2.7 is 103.89dBuV/m (Peak), so the maximum field strength in restrict band is  $103.89 - 50.46 = 53.43$ BuV/m, which is under 74 dBuV/m limit.

Average value =  $53.43 - 30.10 = 23.33$ dBuV/m, which is under 54dBuV/m limit.

\*The DH5 packet was the worse case duty cycle for a transmit dwell time on a channel, based upon bluetooth theory the transmitter is on  $0.625 * 5$  per 296.25 ms per channel. Therefore, the duty cycle be equal to:  $20\log(3.125/100) = -30.1$  dB.

Average value = peak reading  $-30.10$ .



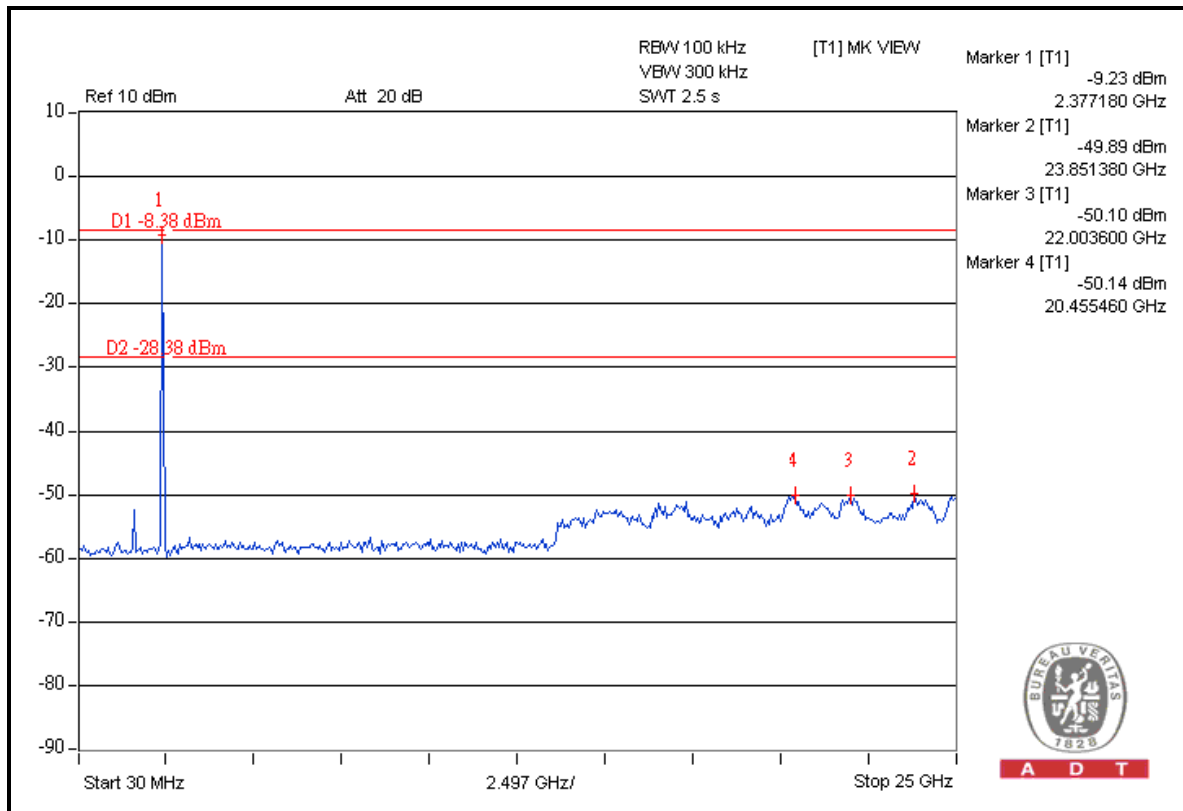
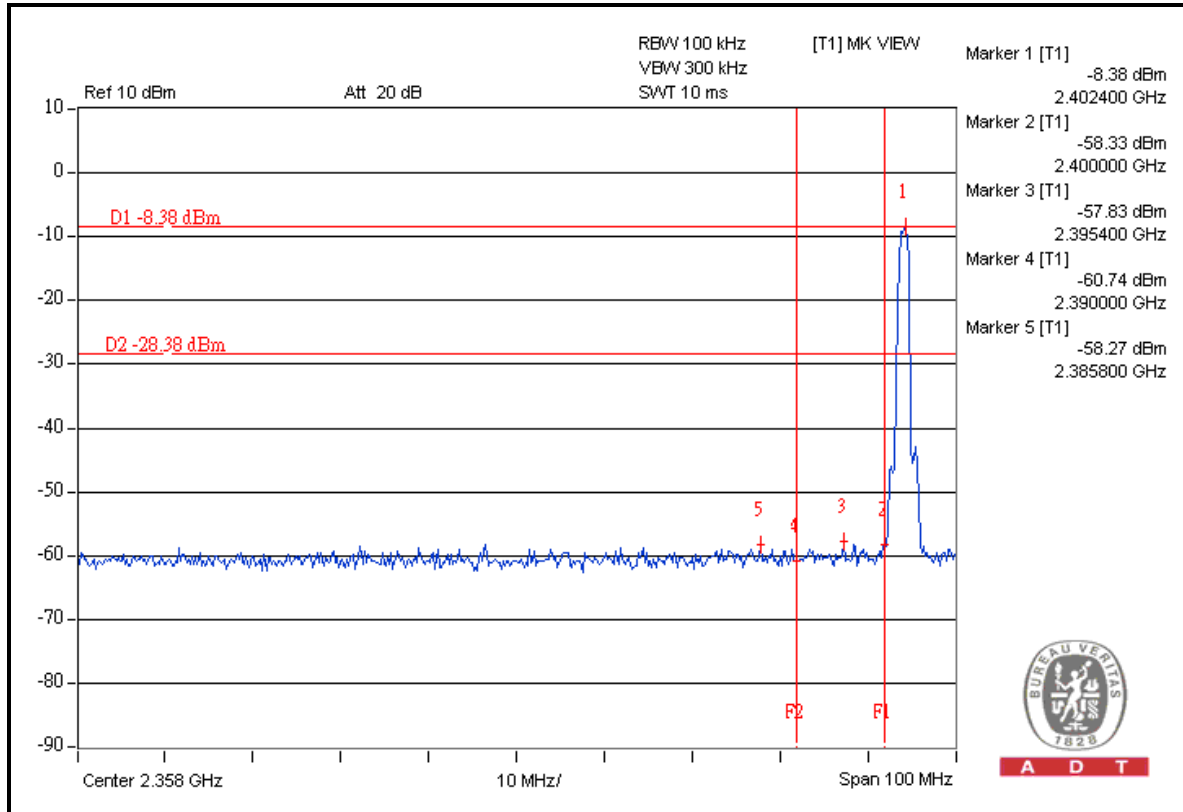

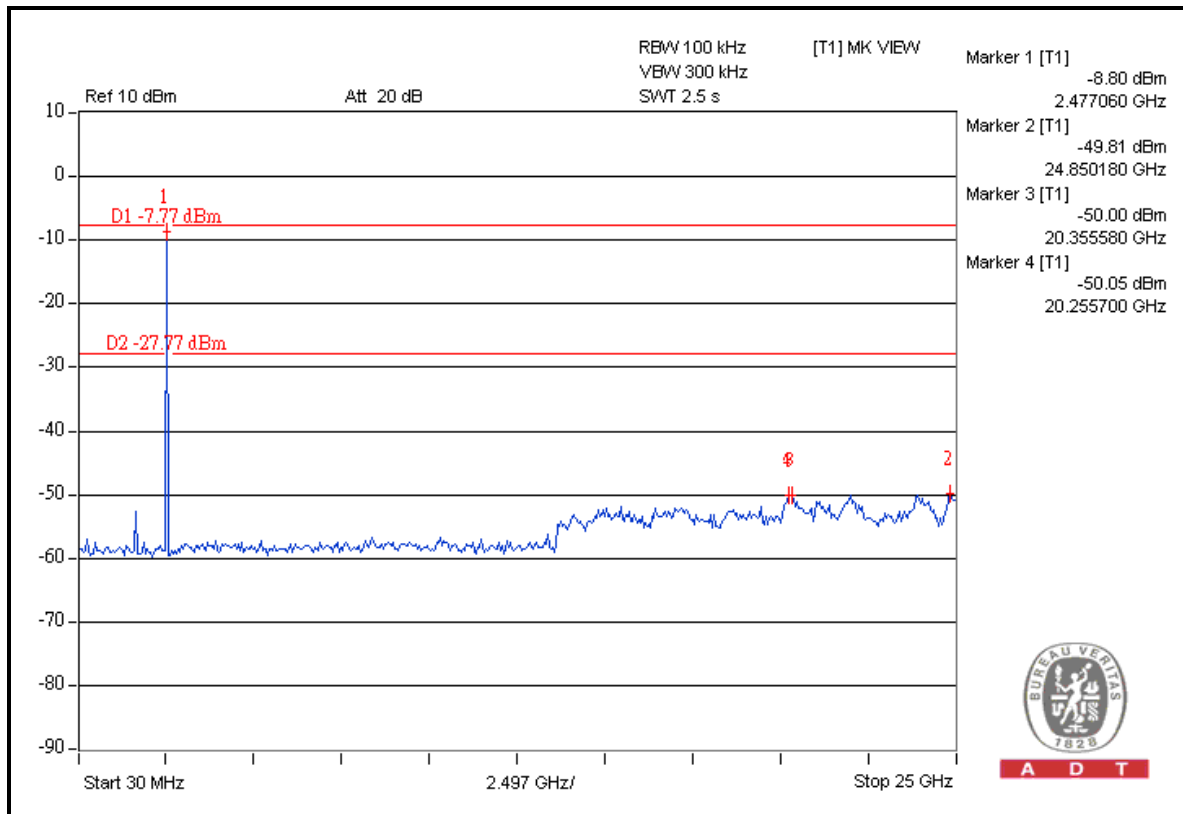
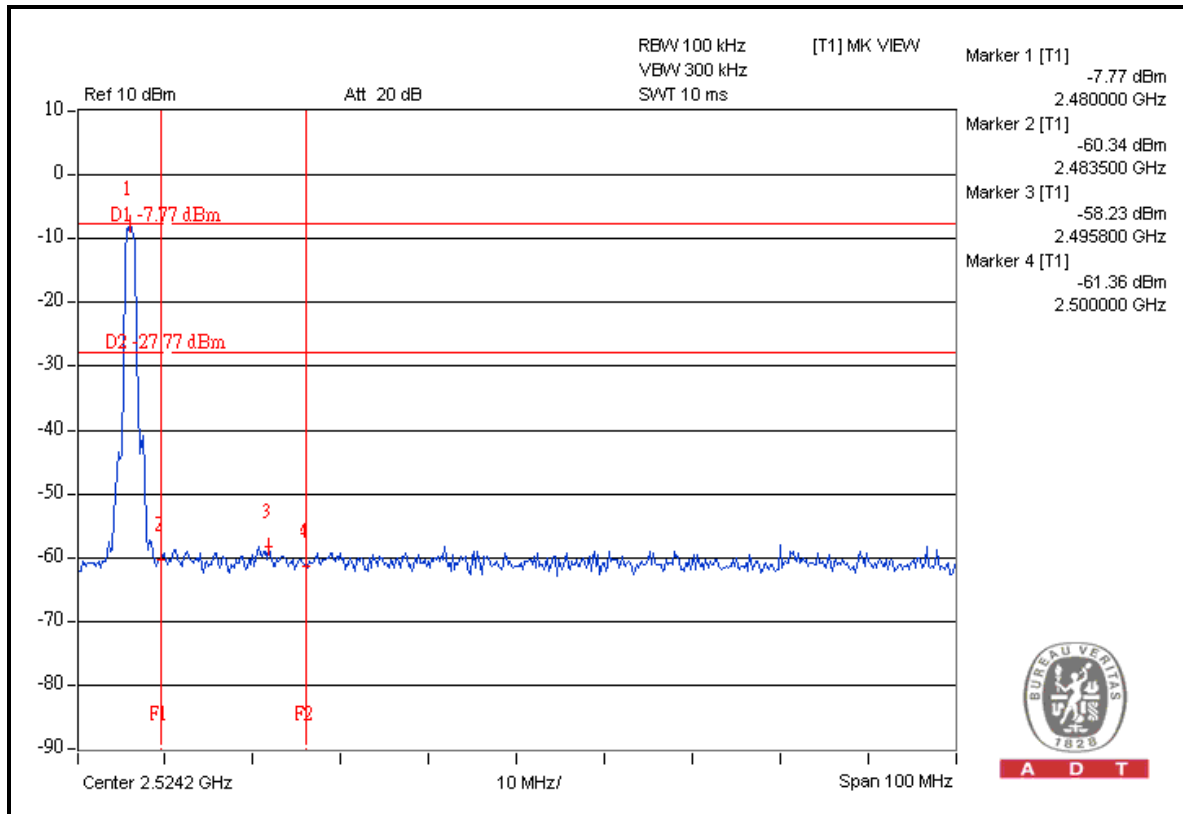



## **4.9 ANTENNA REQUIREMENT**

### **4.9.1 STANDARD APPLICABLE**

For intentional device, according to FCC 47 CFR Section 15.203, an intentional radiator shall be designed to ensure that no antenna other than that furnished by the responsible party shall be used with the device.

And according to FCC 47 CFR Section 15.247 (b), if transmitting antennas of directional gain greater than 6 dBi are used, the power shall be reduced by the amount in dB that the directional gain of the antenna exceeds 6 dBi.

### **4.9.2 ANTENNA CONNECTED CONSTRUCTION**

The antenna used in this product is Chip antenna without antenna connector. The maximum gain of this antenna is -2.10dBi.



## **5. PHOTOGRAPHS OF THE TEST CONFIGURATION**

Please refer to the attached file (Test Setup Photo).



## 6. INFORMATION ON THE TESTING LABORATORIES

We, ADT Corp., were founded in 1988 to provide our best service in EMC, Radio, Telecom and Safety consultation. Our laboratories are accredited and approved by the following approval agencies according to ISO/IEC 17025.

<b>USA</b>	FCC, UL
<b>Germany</b>	TUV Rheinland
<b>Japan</b>	VCCI
<b>Norway</b>	NEMKO
<b>Canada</b>	INDUSTRY CANADA, CSA
<b>R.O.C.</b>	TAF, BSMI, NCC
<b>Netherlands</b>	Telefication
<b>Singapore</b>	GOST-ASIA(MOU)
<b>Russia</b>	CERTIS(MOU)

Copies of accreditation certificates of our laboratories obtained from approval agencies can be downloaded from our web site: [www.adt.com.tw/index.5/phtml](http://www.adt.com.tw/index.5/phtml).

If you have any comments, please feel free to contact us at the following:

**Linko EMC/RF Lab:**

Tel: 886-2-26052180

Fax: 886-2-26051924

**Hsin Chu EMC/RF Lab:**

Tel: 886-3-5935343

Fax: 886-3-5935342

**Hwa Ya EMC/RF/Safety Telecom Lab:**

Tel: 886-3-3183232

Fax: 886-3-3185050

**Web Site:** [www.adt.com.tw](http://www.adt.com.tw)

The address and road map of all our labs can be found in our web site also.

## **7. APPENDIX A – MODIFICATIONS RECORDERS FOR ENGINEERING CHANGES TO THE EUT BY THE LAB**

No any modifications are made to the EUT by the lab during the test.

**---END---**