

# **AW-HM593**

## **IEEE 802.11ah Wireless LAN Module**

### **Datasheet**

**Rev. C**

**DF**

(For STD)

## Features

### General

- Support programmable operation between 850 ~ 950MHz
  - Support single-stream data rate up to 32.5Mbps (MCS=7, 64-QAM, 8MHz channel, 4 uSec GI)
  - Support channel width options of 1/2/4/8 MHz
  - Support Modulation and Coding Scheme (MCS) levels MCS 0-7 and MCS 10
  - Modulation: BPSK & QPSK, 16-QAM & 64-QAM
  - Support 1 MHz duplicate mode
- WPA3 including protected management frames (PMF)
  - Opportunistic Wireless Encryption (OWE)

### Peripheral Interfaces

- SDIO/SPI, I2C and UART
- Support for STA and AP roles

### Host interface

- SDIO 2.0 (slave) Default Speed (DS) at 25MHz
- SDIO 2.0 (slave) High Speed (HS) at 50MHz
- Support for both 1-bit and 4-bit data mode
- Support for SPI mode operation

### Standards Supported

- IEEE Std 802.11ah-2016 compliant

### Security Features

- AES encryption engine
- Hardware support for SHA1 and SHA2 hash functions (SHA-256, SHA-384,SHA-512)

## Revision History

Document NO: R2-2593-DST-01

Version	Revision Date	DCN NO.	Description	Initials	Approved
A	2022/06/29	DCN026640	<ul style="list-style-type: none"> <li>Initial version</li> </ul>	Daniel Lee	N.C. Chen
B	2023/12/14	DCN030777	<ul style="list-style-type: none"> <li>Modify Block Diagram</li> </ul>	Daniel Lee	N.C. Chen
C	2024/05/21	DCN031435	<ul style="list-style-type: none"> <li>Add Tx/Rx Spec.</li> </ul>	Daniel Lee	N.C. Chen
D	2024/06/03		<ul style="list-style-type: none"> <li>Modify Antenna Spec.</li> <li>Add FCC/ISED Warning Statements</li> <li>Add Antenna Trace Design</li> <li>Remove Block Diagram</li> </ul>	Daniel Lee	N.C. Chen

## Table of Contents

<b>Features .....</b>	<b>2</b>
General .....	2
Host interface .....	2
Standards Supported .....	2
Security Features .....	2
Peripheral Interfaces .....	2
<b>Revision History .....</b>	<b>3</b>
<b>Table of Contents .....</b>	<b>4</b>
<b>1. Introduction .....</b>	<b>5</b>
<b>1.1 Product Overview .....</b>	<b>5</b>
<b>1.2 Specifications Table .....</b>	<b>6</b>
1.2.1 General .....	6
1.2.2 WLAN .....	6
1.2.3 Operating Conditions .....	8
<b>2. Pin Definition .....</b>	<b>9</b>
<b>2.1 Pin Map .....</b>	<b>9</b>
<b>3. Electrical Characteristics .....</b>	<b>12</b>
<b>3.1 Absolute Maximum Ratings .....</b>	<b>12</b>
<b>3.2 Recommended Operating Conditions .....</b>	<b>12</b>
<b>3.3 Timing Sequence .....</b>	<b>13</b>
3.3.1 SDIO Bus Timing .....	13
3.3.2 SPI Bus .....	14
3.3.3 UART Bus .....	14
3.3.4 I2C Bus Timing .....	15
<b>3.4 Power Consumption .....</b>	<b>16</b>
3.4.1 Transmit Power Consumption .....	16
3.4.2 Receive Power Consumption .....	16
<b>4. Mechanical Information .....</b>	<b>17</b>
<b>4.1 Mechanical Drawing .....</b>	<b>17</b>
<b>5. Packing Information .....</b>	<b>18</b>
<b>6. Warning Statements .....</b>	<b>22</b>



## 1. Introduction

### 1.1 Product Overview

**AzureWave Technologies, Inc.** introduces the pioneer of the IEEE 802.11ah WIFI stamp module --- **AW-HM593**. The **AW-HM593** is an IEEE 802.11ah Wi-Fi module that operates in the Sub 1GHz license-exempt band, offering longer ranager and higher data rate for internet of things (IoT) applications. The **AW-HM593** enables streamlined data transfer interoperability with existing Wi-Fi networks while meeting up to 1KM long range data transfer with low power consumption requirements.

The **AW-HM593** integrated Morse Micro MM6108 and external RF front end module (FEM) which can increase transmission power. MM6108 supports SDIO 2.0 compliant slave interface and SPI mode operation, and many peripherals such as general I2C, UART and GPIOs. In addition, its MAC supports for STA and AP roles.

## 1.2 Specifications Table

### 1.2.1 General

Features	Description
<b>Product Description</b>	IEEE 802.11ah Wireless LAN Module
<b>Major Chipset</b>	Morse Micro MM6108 (48-pin QFN)
<b>Host Interface</b>	SDIO/SPI
<b>Dimension</b>	14mm x 18.5mm x 2.25mm (Tolerance remarked in mechanical drawing)
<b>Form Factor</b>	Stamp module, 38 pins
<b>Antenna</b>	<ul style="list-style-type: none"> <li>For Stamp Module, "1T1R, external"</li> </ul> ANT Main : TX/RX Model: AN0915-5001BSM, Type: Dipole Antenna, Gain: 2.34dBi
<b>Weight</b>	1.0g

### 1.2.2 WLAN

Features	Description				
<b>WLAN Standard</b>	IEEE 802.11ah				
<b>Frequency Range</b>	US (903.5 – 926.5 MHz)				
<b>Modulation</b>	OFDM, BPSK, QPSK, 16-QAM, 64-QAM				
<b>Channel Bandwidth</b>	1/2/4/8 MHz				
<b>Output Power (Board Level Limit)*</b>		Min	Typ	Max	Unit
	MCS0 (1/2 MHz) @EVM ≤ -5dB	18	20	22	dBm
	MCS0 BW-4MHz 906MHz (Ch8) @EVM ≤ -5dB	18	20	22	dBm
	MCS0 BW-4MHz 914MHz (Ch24) @EVM ≤ -5dB	18	20	22	dBm

	MCS0 BW-4MHz 926MHz (Ch48) @EVM $\leq$ -5dB	15	17	19	dBm
	MCS0 BW-8MHz 908MHz (Ch12) @EVM $\leq$ -5dB	18	20	22	dBm
	MCS0 BW-8MHz 916MHz (Ch28) @EVM $\leq$ -5dB	18	20	22	dBm
	MCS0 BW-8MHz 924MHz (Ch44) @EVM $\leq$ -5dB	17	19	21	dBm
	MCS7 (1/2/4/8 MHz) @EVM $\leq$ -27dB	14	16	18	dBm
<b>Receiver Sensitivity</b>		Min	Typ	Max	Unit
	MCS0 (1 MHz)		-104	-100	dBm
	MCS0 (2 MHz)		-101	-97	dBm
	MCS0 (4 MHz)		-99	-95	dBm
	MCS0 (8 MHz)		-95	-91	dBm
	MCS7 (1 MHz)		-87	-81	dBm
	MCS7 (2 MHz)		-84	-78	dBm
	MCS7 (4 MHz)		-81	-75	dBm
	MCS7 (8 MHz)		-78	-72	dBm
<b>Data Rate</b>	<ul style="list-style-type: none"> <li>■ 1 MHz Bandwidth: up to 3.333Mbps</li> <li>■ 2 MHz Bandwidth: up to 7.222Mbps</li> <li>■ 4 MHz Bandwidth: up to 15Mbps</li> <li>■ 8 MHz Bandwidth: up to 32.5Mbps</li> </ul>				
<b>Security</b>	<ul style="list-style-type: none"> <li>■ AES encryption engine</li> <li>■ Hardware support for SHA1 and SHA2 hash functions (SHA-256, SHA-384,SHA-512)</li> <li>■ WPA3 including protected management frames (PMF)</li> <li>■ Opportunistic Wireless Encryption (OWE)</li> </ul>				

**\* If you have any certification questions about output power please contact FAE directly.**

### 1.2.3 Operating Conditions

Features	Description
<b>Operating Conditions</b>	
<b>Voltage</b>	VBAT: 3.3V VDD_FEM: 3.3V VDDIO: 3.3V
<b>Operating Temperature</b>	-40°C ~85 °C
<b>Operating Humidity</b>	less than 85%R.H
<b>Storage Temperature</b>	-40°C ~90 °C
<b>Storage Humidity</b>	less than 60%R.H
<b>ESD Protection</b>	
<b>Human Body Model</b>	+/-1000V (RF Input pin.38), +/-2000V (All pins except RF Input)
<b>Changed Device Model</b>	+/-500V (All pins)



## 2. Pin Definition

### 2.1 Pin Map

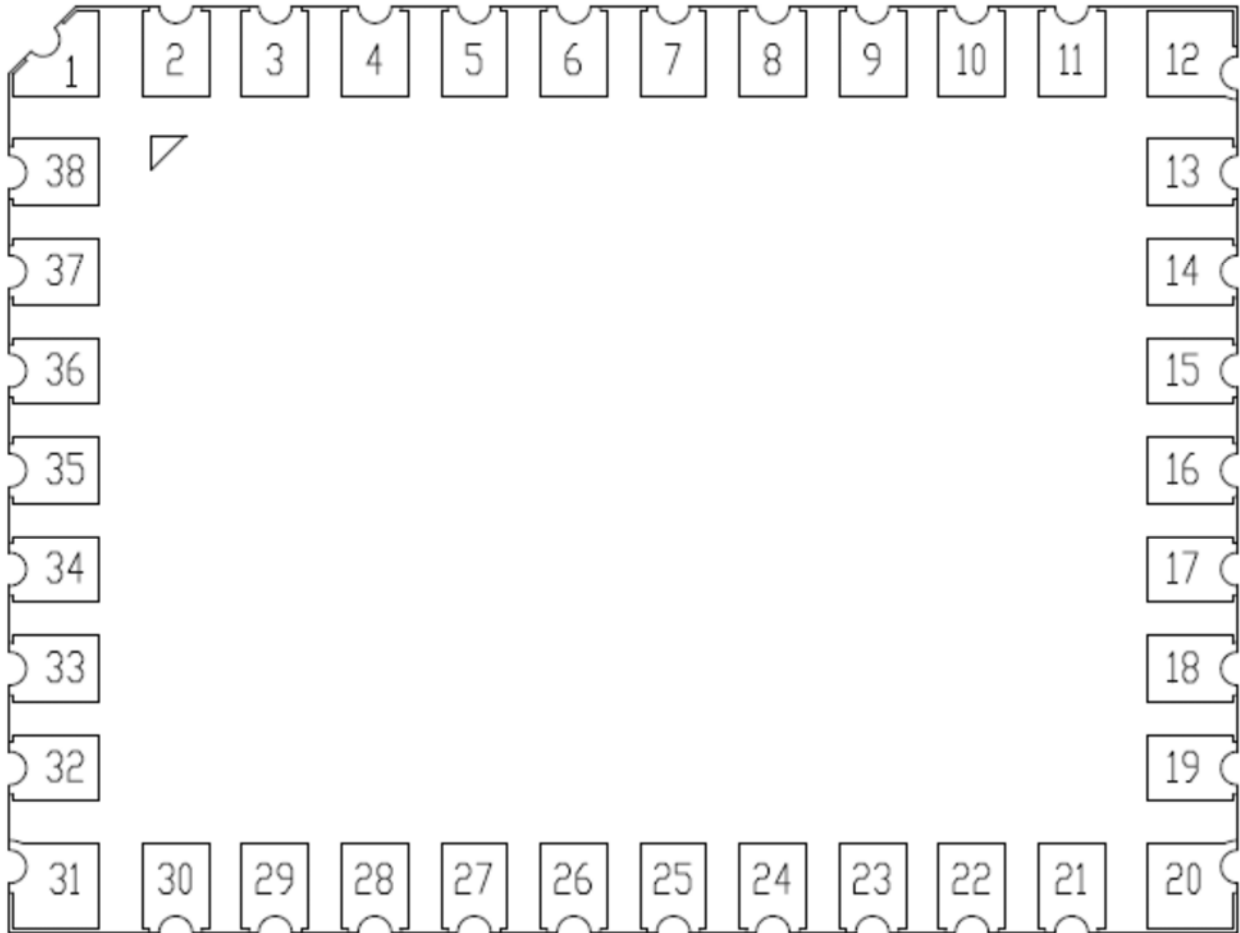

PIN DEFINED(TOP VIEW)

### **AW-HM593 Pin Map (Top View)**

## 2.2 Pin Table

Pin No.	Definition	Basic Description	Voltage	Type
1	GND	GROUND		GND
2	GND	GROUND		GND
3	GND	GROUND		GND
4	MM_JTAG_TCK	JTAG clock		I
5	MM_JTAG_TDI	JTAG data input		I
6	NC	No Connection		
7	MM_JTAG_TMS	JTAG mode selection		I
8	MM_JTAG_TRST	JTAG reset		I
9	MM_JTAG_TDO	JTAG data output		O
10	NC	No Connection		I
11	MM_GPIO10	General purpose I/O		I/O
12	GND	GROUND		GND
13	MM_GPIO9	General purpose I/O		I/O
14	MM_GPIO8	General purpose I/O		I/O
15	MM_GPIO7	General purpose I/O		I/O
16	MM_SD_D1	SDIO Data pin 1		I/O
17	MM_SD_D0	SDIO Data pin 0		I/O
18	MM_SD_CLK	SDIO Clock pin (input)		I
19	VDDIO	I/O supply Input		Power
20	GND	GROUND		GND
21	MM_SD_CMD	SDIO Command pin		I/O
22	MM_SD_D3	SDIO Data pin 3		I/O
23	MM_SD_D2	SDIO Data pin 2		I/O

24	MM_GPIO6	General purpose I/O		I/O
25	VBAT	3.3V power supply	3.3V	Power
26	GND	GROUND		GND
27	MM_GPIO5	General purpose I/O		I/O
28	MM_GPIO4	General purpose I/O		I/O
29	MM_GPIO3	General purpose I/O		I/O
30	MM_GPIO2	General purpose I/O		I/O
31	GND	GROUND		GND
32	VDD_FEM	Front End Module power input	3.3V	Power
33	MM_GPIO1	General purpose I/O		I/O
34	Busy	WiFi Busy		I/O
35	MM_RESET_N	Reset (active low)		I/O
36	MM_WAKE	WAKE from sleep		I
37	GND	GROUND		GND
38	ANT	RF IN/OUT		I/O

### 3. Electrical Characteristics

#### 3.1 Absolute Maximum Ratings

Symbol	Parameter	Minimum	Typical	Maximum	Unit
VDD_FEM	Front End Module power input	-0.5	-	5.5	V
VBAT	3.3V power supply	-0.5	-	4.3	V
VDDIO	I/O supply Input	-0.5	-	4.3	V
T <sub>stg</sub>	Storage temperature	-40	-	90	°C

#### 3.2 Recommended Operating Conditions

Symbol	Parameter	Minimum	Typical	Maximum	Unit
VDD_FEM	Front End Module power input	3.0	3.3	3.6	V
VBAT	3.3V power supply	3.0	3.3	3.6	V
VDDIO	3.3V I/O supply Input	1.8	3.3	VBAT	V
T <sub>AMBIENT</sub>	Ambient temperature	-40	25	85	°C

### 3.3 Timing Sequence

#### 3.3.1 SDIO Bus Timing

The SDIO clock rate supports up to 50MHz. The device always operates in SD high speed mode.

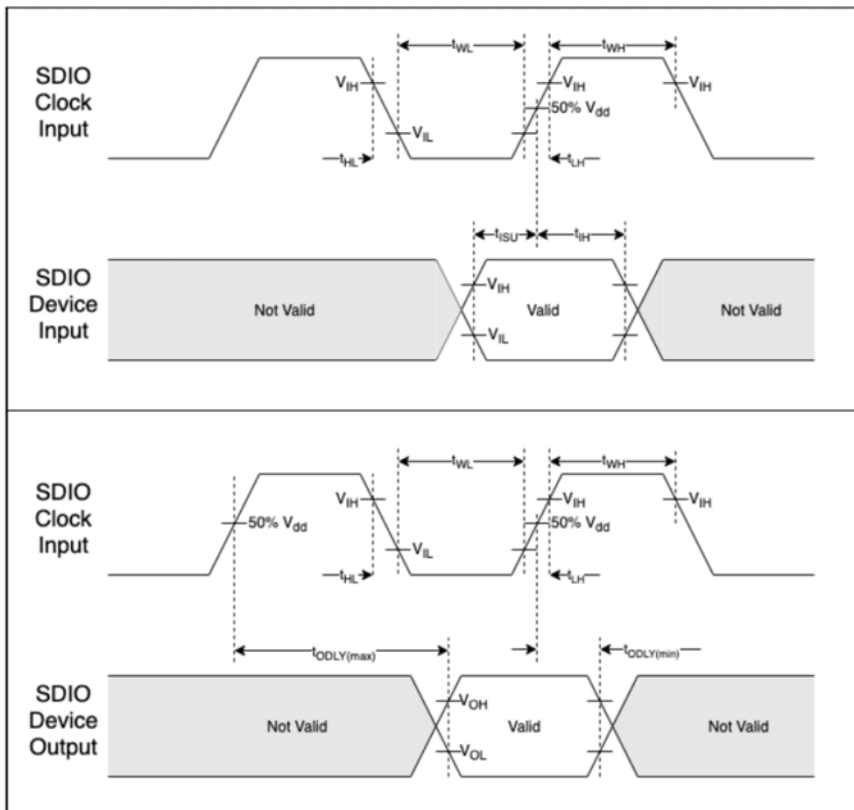

Parameter	Min	Max
Clock parameters		
Clock frequency	0MHz	50MHz
Clock low time ( $t_{WL}$ )	7ns	
Clock high time ( $t_{WH}$ )	7ns	
Clock rise time ( $t_{LH}$ )		3ns
Clock fall time ( $t_{FL}$ )		3ns
Inputs on CMD, DAT lines to device from host		
Input setup time ( $t_{ISU}$ )	6ns	
Input hold time ( $t_{IH}$ )	2ns	
Outputs on CMD, DAT lines from device to host		
Output delay ( $t_{ODLY(max)}$ )		14ns
Output hold time ( $t_{ODLY(min)}$ )	2.5ns	
Total system capacitance for each line		40pF

### 3.3.2 SPI Bus

The SPI clock rate supports up to 50MHz. The SPI bus timing is identical to the SDIO bus timing, where MOSI and MISO are considered input and output timing, respectively, in the SDIO timing specification.

The SPI bus defaults to clock idling at logical 0 (CPOL=0), and data is launched and captured on the positive edges of the clock, as per SDIO high-speed mode. It may be configured to behave like CPHA=0 (drive output on negative edge, sample on positive edge) after being initialized.

### 3.3.3 UART Bus

Two universal asynchronous receiver/transmitter (UARTs) are available and provide a means for serial communication to off-chip devices. The UART cores are as-provided by the SiFive IP repository. The UART peripheral does not support hardware flow control or other modem control signals, or synchronous serial data transfers.

We will clock the UARTs with a maximum clock speed of 30MHz (TBD), meaning maximum baud of the UART will be around 30Mbaud or 30Mbits/s if a divisor of 0 is specified.

Pin	Name	Default Function	I/O Function
15	MM_GPIO7	GPIO	UART1 Tx
24	MM_GPIO6	GPIO	UART1 Rx
29	MM_GPIO3	GPIO	UART0 Tx
30	MM_GPIO2	GPIO	UART0 Rx

### 3.3.4 I2C Bus Timing

An I2C master interface is available. It consists of two lines, SDA and SCL, which are bidirectional, connected to a positive supply voltage via a current-source or pull-up resistor.

Pin	Name	Default Function	I/O Function
27	MM_GPIO5	GPIO	I2C SCL
28	MM_GPIO4	GPIO	I2C SDA

Definition of timing for F/S-mode devices on the I2C-bus. All values referred to

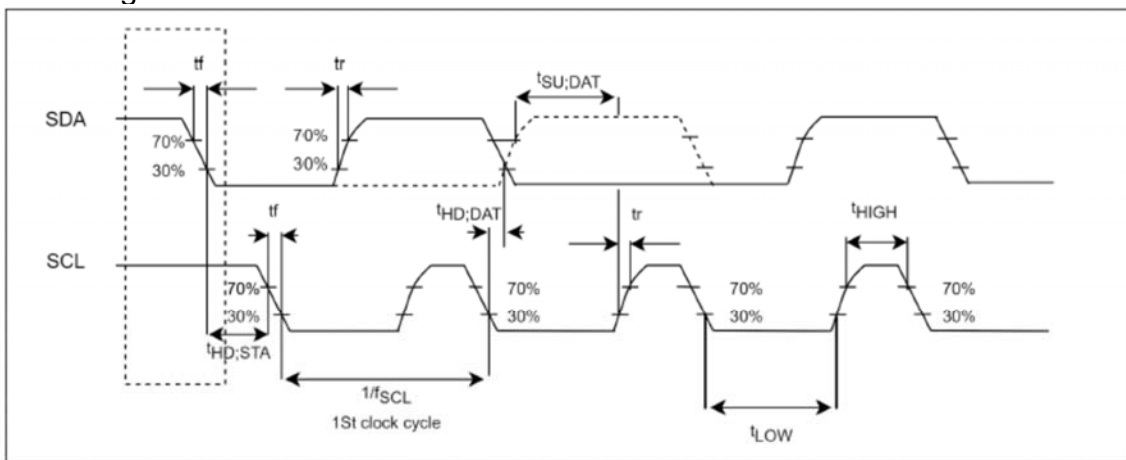

$V_{IH(min)}$ ( $0.3V_{DD}$ ) and  $V_{IL(max)}$ ( $0.7V_{DD}$ ) levels.

Parameter	Standard-mode		Fast-mode	
	Min	Max	Min	Max
Clock frequency( $f_{SCL}$ )	0	100kHz	0	400kHz
Fall time of both SDA and SCL ( $t_f$ )	-	300ns	20x ( $V_{DD}/5.5V$ )	300ns
Rise time of both SDA and SCL signals( $t_r$ )	-	1000ns	20ns	300ns
Data hold time ( $t_{HD:DAT}$ )	5.0us	-	-	-
Data set-up time ( $t_{SU:DAT}$ )	250ns	-	100ns	-
LOW period of the SCL clock	4.7us	-	1.3us	-
HIGH period of the SCL clock	4.0us	-	0.6us	-
Hold time- START,first clock is generated after this( $t_{HD:STA}$ )	4us	-	0.6us	-

### 3.4 Power Consumption

#### 3.4.1 Transmit Power Consumption

Band (MHz)	Modulation	BW (MHz)	DUT Condition	VBAT = 3.3V, VDD_FEM = 3.3V	
				VBAT (mA)	VDD_FEM (mA)
				Avg.	Avg.
915	MCS0	1	Tx @ 20 dBm	68.5	140.4
		2		68.3	124.3
		4		71.7	108.2
		8		78.7	92.2
	MCS7	1	Tx @ 16 dBm	59.8	80.2
		2		57.7	60.1
		4		61.8	52.7
		8		69.6	49.2

\* The power consumption is based on AzureWave test environment, these data for reference only.

#### 3.4.2 Receive Power Consumption

Band (MHz)	Modulation	BW (MHz)	DUT Condition	VBAT = 3.3V, VDD_FEM = 3.3V	
				VBAT (mA)	VDD_FEM (mA)
				Avg.	Avg.
915	MCS0	1	Continuous Rx @ -95 dBm	40.4	4.8
		2	Continuous Rx @ -92 dBm	43.2	4.8
		4	Continuous Rx @ -89 dBm	50.2	4.8
		8	Continuous Rx @ -86 dBm	66.5	4.8
	MCS7	1	Continuous Rx @ -77 dBm	41.0	4.8
		2	Continuous Rx @ -74 dBm	43.7	4.8
		4	Continuous Rx @ -71 dBm	49.9	4.8
		8	Continuous Rx @ -68 dBm	62.5	4.8

\* The power consumption is based on AzureWave test environment, these data for reference only.



## 4. Mechanical Information

### 4.1 Mechanical Drawing

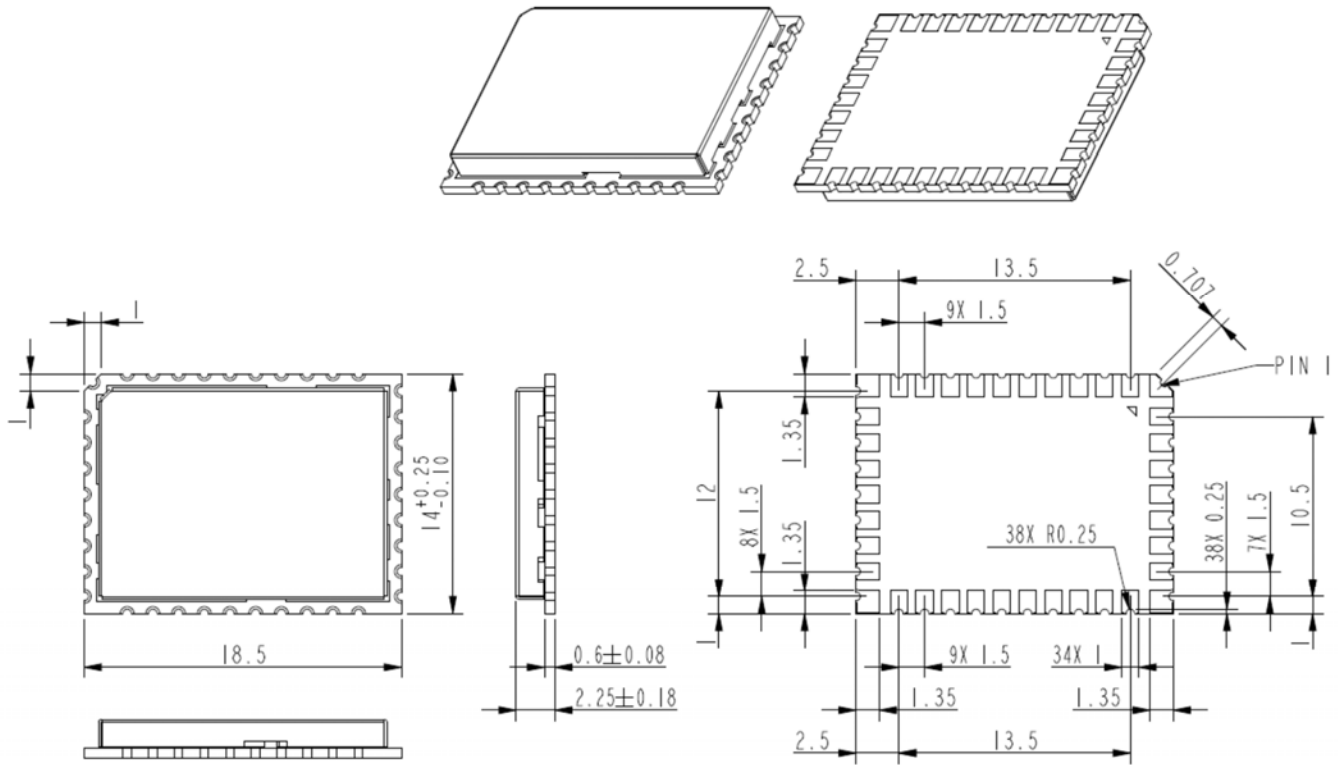

TOLERANCE UNLESS OTHERWISE SPECIFIED:  $\pm 0.1\text{mm}$

## 5. Packing Information

1. One reel can pack 1000pcs
2. One production label is pasted on the reel, one desiccant and one humidity indicator card are put on the reel

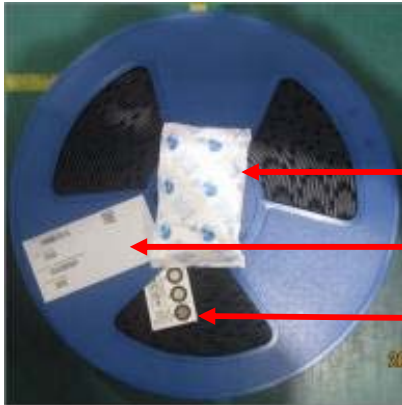

One desiccant

One production label

One humidity indicator card

3. One reel is put into the anti-static moisture barrier bag, and then one label is pasted on the bag



One production label

4. A bag is put into the anti-static pink bubble wrap

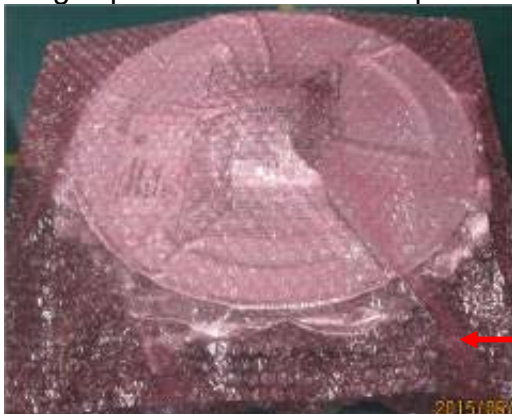

One anti-static pink bubble wrap

5. A bubble wrap is put into the inner box and then one label is pasted on the inner box



One production label

6. **4 inner boxes** could be put into one carton













7. Sealing the carton by AzureWave tape



8. One carton label and one box label are pasted on the carton. If one carton is not full, one balance label pasted on the carton



<p>Example of carton label</p>	<table border="1"> <tr> <td colspan="2" style="text-align: center;">  </td> </tr> <tr> <td>AzureWave P/N</td> <td>AW-HM593</td> </tr> <tr> <td>Customer</td> <td>由業務提供</td> </tr> <tr> <td>Customer P/N</td> <td>由業務提供</td> </tr> <tr> <td>Customer PO</td> <td>由業務提供</td> </tr> <tr> <td>Description</td> <td>AW-XXXXXX</td> </tr> <tr> <td>QTY</td> <td>1200 pes</td> </tr> <tr> <td>C/N</td> <td></td> </tr> <tr> <td>N.W.</td> <td>G.W.</td> </tr> <tr> <td colspan="2" style="text-align: center;">  </td> </tr> </table>			AzureWave P/N	AW-HM593	Customer	由業務提供	Customer P/N	由業務提供	Customer PO	由業務提供	Description	AW-XXXXXX	QTY	1200 pes	C/N		N.W.	G.W.		
																					
AzureWave P/N	AW-HM593																				
Customer	由業務提供																				
Customer P/N	由業務提供																				
Customer PO	由業務提供																				
Description	AW-XXXXXX																				
QTY	1200 pes																				
C/N																					
N.W.	G.W.																				
																					
<p>Example of box label</p>																					
<p>Example of production label</p>	<table border="1"> <tr> <td>P/N: AW-HM593</td> <td rowspan="2" style="text-align: center;">  </td> </tr> <tr> <td>D/C: 1309</td> </tr> <tr> <td>PCK NO.: PCKNO0069097</td> <td></td> </tr> <tr> <td>QTY: 294</td> <td></td> </tr> <tr> <td colspan="2" style="text-align: right;">BAG SEAL DATE: _____</td> </tr> </table>	P/N: AW-HM593		D/C: 1309	PCK NO.: PCKNO0069097		QTY: 294		BAG SEAL DATE: _____												
P/N: AW-HM593																					
D/C: 1309																					
PCK NO.: PCKNO0069097																					
QTY: 294																					
BAG SEAL DATE: _____																					

Example of balance label	
--------------------------	--

## 6. Warning Statements

### **Federal Communication Commission Interference Statement**

This equipment has been tested and found to comply with the limits for a Class B digital device, pursuant to Part 15 of the FCC Rules. These limits are designed to provide reasonable protection against harmful interference in a residential installation. This equipment generates, uses and can radiate radio frequency energy and, if not installed and used in accordance with the instructions, may cause harmful interference to radio communications. However, there is no guarantee that interference will not occur in a particular installation. If this equipment does cause harmful interference to radio or television reception, which can be determined by turning the equipment off and on, the user is encouraged to try to correct the interference by one of the following measures:

- Reorient or relocate the receiving antenna.
- Increase the separation between the equipment and receiver.
- Connect the equipment into an outlet on a circuit different from that to which the receiver is connected.
- Consult the dealer or an experienced radio/TV technician for help.

FCC Caution: Any changes or modifications not expressly approved by the party responsible for compliance could void the user's authority to operate this equipment.

This device complies with Part 15 of the FCC Rules. Operation is subject to the following two conditions: (1) This device may not cause harmful interference, and (2) this device must accept any interference received, including interference that may cause undesired operation.

### **FCC Radiation Exposure Statement:**

This equipment complies with FCC radiation exposure limits set forth for an uncontrolled environment. This equipment should be installed and operated with a minimum distance 20cm between the radiator and your body.

### **IMPORTANT NOTE:**

This module has been tested and found to comply with the following requirements for Modular Approval.

- Part 15.247 - Operation within the bands 902-928 MHz, 2400-2483.5 MHz, and 5725-5850 MHz.

### **RF exposure considerations**

In the end product, the antenna(s) used with this transmitter must be installed to provide a separation distance of at least 20cm from all persons and must not be co-located or operation in conjunction with any other antenna or transmitter except in accordance with multi-transmitter product procedures. User and installers must be provided with antenna installation instructions and transmitter operating conditions for satisfying the RF exposure compliance.



**Antennas**

This radio transmitter has been approved by the FCC to operate with the antenna types listed below with the maximum permissible gain indicated. Antenna types not included in this list, having a gain greater than the maximum gain indicated for that type, are strictly prohibited for use with this device.

Radio	Antenna Type	Freq. (MHz)	Peak Antenna Gain (dBi)
802.11 ah	Dipole	902 – 928	2.34

**Required End Product Labeling**

Any device incorporating this module must include an external, visible, permanent marking or label which states: "Contains FCC ID: TLZ-HM593W"

**Test Modes**

This device uses various test mode programs for test set up which operate separate from production firmware. Host integrators should contact the grantee for assistance with test modes needed for module/host compliance test requirements.

**Additional testing, Part 15 Subpart B disclaimer**

The modular transmitter is only FCC authorized for the specific rule parts (i.e. FCC transmitter rules) listed on the grant, and that the host product manufacturer is responsible for compliance to any other FCC rules that apply to the host not covered by the modular transmitter grant of certification.

The final host product still requires Part 15 Subpart B compliance testing with the modular transmitter installed.

**EMI Considerations**

Note that a host manufacture is recommended to use KDB996369 D04 Module Integration Guide recommending as "best practice" RF design engineering testing and evaluation in case non-linear interactions generate additional non-compliant limits due to module placement to host components or properties.

For standalone mode, reference the guidance in KDB996369 D04 Module Integration Guide and for simultaneous mode; see KDB996369 D02 Module Q&A Question 12, which permits the host manufacturer to confirm compliance.

**How to make changes**

Only Grantees are permitted to make permissive changes, if the module will be used differently than granted conditions, please contact us to ensure modifications will not affect compliance.



### Antenna Trace Design

The modular transmitter is configured for monostatic operation, which requires only a single RF I/O pin for full duplex communication. The output must be routed to the antenna via 50 ohm microstrip or strapline on the OEM PCB. No coupling capacitor is required given that the RF pin is AC-coupled internally.

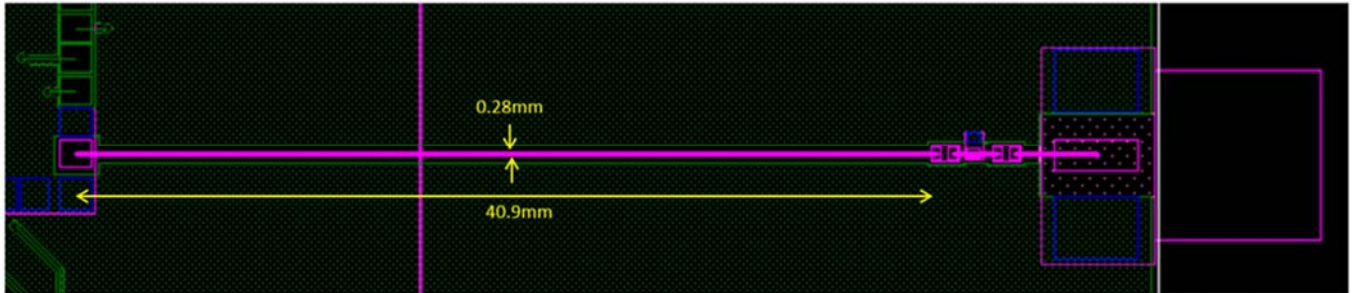

Length: 40.9mm  
Width: 0.28mm  
Thickness: 0.18mm  
Type of trace: 1oz  
Dielectric constant: 4.2  
Antenna connector: 50ohm SMA Male

The trace from Pin No. 38 to antenna connector on the OEM PCB must be maintained identical as the above specification with Reversed SMA connector. Only trace designs approved with an original grant or through permissive change can be used by an OEM, any changes are deemed as antenna type change and should be reviewed to ensure compliance with the FCC and ISED requirements.

Verification must be conducted and the results shall not exceed below ranges to ensure identical antenna design is applied to subsequent integration and end product production.

Impedance 50 ohm +/- 10%  
Input power is 21.5dBm (Average power)  
VSWR absolute max 5dBm (Average power) subsequent integrat  
VSWR recommended 5dBm (Average power) subsequent integration and end pr

### Test procedure of verification

1. Set module device in support transmission mode.
2. Verify RF power through conducted measurement at balanced impedance of 50ohms, the KDB 971168 D01 Power Meas License Digital System shall be used as the supplemental test methodology to adjust the proper setting obtaining the measurement results.
3. Verify the Tx power in the datasheet, and compliance test reports.



**Innovation, Science and Economic Development Statement**

This device contains license-exempt transmitter(s) / receiver(s) that comply with Innovation, Science and Economic Development Canada’s license-exempt RSS(s). Operation is subject to the following two conditions:

1. This device may not cause interference, and
2. This device must accept any interference, including interference that may cause undesired operation of the device.

L'émetteur/récepteur exempt de licence contenu dans le présent appareil est conforme aux CNR d'Innovation, Sciences et Développement économique Canada applicables aux appareils radio exempts de licence. L'exploitation est autorisée aux deux conditions suivantes :

1. L'appareil ne doit pas produire de brouillage, et
2. L'utilisateur de l'appareil doit accepter tout brouillage radioélectrique subi, même si le brouillage est susceptible d'en compromettre le fonctionnement.

**Caution: Exposure to Radio Frequency Radiation**

1. To comply with the Canadian RF exposure compliance requirements, this device and its antenna must not be co-located or operating in conjunction with any other antenna or transmitter.
2. To comply with RSS 102 RF exposure compliance requirements, a separation distance of at least 20 cm must be maintained between the antenna of this device and all persons.

**Attention: exposition au rayonnement radiofréquence**

1. Pour se conformer aux exigences de conformité RF canadienne l'exposition, cet appareil et son antenne ne doivent pas être co-localisés ou fonctionnant en conjonction avec une autre antenne ou transmetteur.
2. Pour se conformer aux exigences de conformité CNR 102 RF exposition, une distance de séparation d'au moins 20 cm doit être maintenue entre l'antenne de cet appareil et toutes les personnes.

**Antennas**

This radio transmitter has been approved by the ISED to operate with the antenna types listed below with the maximum permissible gain indicated. Antenna types not included in this list, having a gain greater than the maximum gain indicated for that type, are strictly prohibited for use with this device.

**Antennes**

Cet émetteur radio a été approuvé par la ISED pour fonctionner avec les types d'antennes répertoriés ci-dessous avec le gain maximal autorisé indiqué. Les types d'antennes non inclus dans cette liste, ayant un gain supérieur au gain maximum indiqué pour ce type, sont strictement interdits pour une utilisation avec cet appareil.

Radio	Antenna Type	Freq. (MHz)	Peak Antenna Gain (dBi)
802.11 ah	Dipole	902 – 928	2.34



**Required End Product Labeling**

Any device incorporating this module must include an external, visible, permanent marking or label which states: "Contains IC: 6100A-HM593"

**Obligation d'étiquetage du produit final:**

Tout dispositif intégrant ce module doit comporter un externe, visible, marquage permanent ou une étiquette qui dit: "Contient IC: 6100A-HM593"