



## Test Report for FCC

FCC ID :TKWFL-DB

Report Number		ESTRFC1906-003		
Applicant	Company name	Suprema Inc		
	Address	16F, Parkview Office Tower, 248, Jeongjail-ro, Bundang-gu, Seongnam, Gyeonggi, South Korea		
	Telephone	+82-31-710-4908		
	Contact person	Bongseop Song		
Product	Product name	Facelite		
	Model No.	FL-DB	Manufacturer	Suprema Inc
	Serial No.	None	Country of origin	KOREA
Test date	22-May-19 ~ 28-May-19		Date of issue	10-Jun-19
Testing location	347-69, Jungbu-daero 147beon-gil, Majang-myeon, Icheon-si, Gyeonggi-do 467-811, R. O. Korea			
Standard	FCC PART 15 Subpart C (15.247), ANSI C 63.10(2013), KDB 558074 D01			
Measurement facility registration number		659627		
Tested by	Engineer H.G. Lee		(Signature)	
Reviewed by	Engineering Manager I.K. Hong		(Signature)	
Abbreviation				
<p>* Note</p> <ul style="list-style-type: none"> <li>- This test report is not permitted to copy partly without our permission</li> <li>- This test result is dependent on only equipment to be used</li> <li>- This test result based on a single evaluation of one sample of the above mentioned</li> </ul>				



## Contents

1. Laboratory Information .....	3
2. Description of EUT .....	4
3. Test Standards .....	6
4. Measurement condition .....	7
5. DTS bandwidth .....	11
5.1 Test procedure .....	11
5.2 Test instruments and measurement setup .....	11
5.3 Measurement results .....	11
5.4 Trace data .....	12
6. Maximum Peak Output Power .....	14
6.1 Test procedure .....	14
6.2 Test instruments and measurement setup .....	14
6.3 Measurement results .....	14
7. Maximum conducted (average) output power .....	15
7.1 Test procedure .....	15
7.2 Test instruments and measurement setup .....	15
7.3 Measurement results .....	15
7.4 Trace data(Peak, Average).....	16
8. Maximum power spectral density level in the fundamental emission .....	19
8.1 Test procedure .....	19
8.2 Test instruments and measurement setup .....	19
8.3 Measurement results .....	19
8.4 Trace data .....	20
9. Emissions in non-restricted frequency bands .....	22
9.1 Test procedure .....	22
9.2 Test instruments and measurement setup .....	22
9.3 Measurement results .....	22
9.4 Trace data of band-edge & out of emissioin .....	23
10. Measurement of radiated emission .....	27
10.1 Measurement equipment .....	27
10.2 Environmental conditions .....	27
10.3 Measurement Instrument setting for Radiated Emission .....	28
10.4 Test Data .....	29
11. Measurement of conducted emission .....	37
11.1 Measurement equipment .....	37
11.2 Environmental conditions .....	37
11.3 Test Data .....	38

Appendix 1. Special diagram

Appendix 2. Antenna Requirement



## 1. Laboratory Information

### 1.1 General

This EUT (Equipment Under Test) has been shown to be capable of compliance with the applicable technical standards and is tested in accordance with the measurement procedures as indicated in this report.

ESTECH Lab attests to accuracy of test data. All measurement reported herein were performed by ESTECH Co., Ltd.

ESTECH Lab assume full responsibility for the completeness of these measurements and vouch for the qualifications of all persons taking them.

### 1.2 Test Lab.

Corporation Name : ESTECH Co., Ltd.

Head Office : Suite 1015 World Meridian II, 123 Gasan Digital 2-ro, Geumcheon-gu, Seoul 153-759, R. O. Korea

EMC/Telecom/Safety Test Lab : 347-69, Jungbu-daero 147beon-gil, Majang-myeon, Icheon-si,  
Gyeonggi-do 467-811, R. O. Korea

### 1.3 Official Qualification(s)

MSIP : Granted Accreditation from Ministry of Information & Communication for EMC, Safety and Telecommunication

KOLAS : Accredited Lab By Korea Laboratory Accreditation Schema base on CENELEC requirements

FCC : Conformity Assessment Body(CAB) with registration number 659627 under APEC TEL MRA between the RRA and the FCC

VCCI : Granted Accreditation from Voluntary Control Council for Interference from ITE



## 2. Description of EUT

### 2.1 Summary of Equipment Under Test

Modulation Type	: Bluetooth (GFSK)
Transfer Rate	: 1 Mbps
Number of Channel	: 40 ch
PEAK Output Power	: 1.545 mW
Rating	: INPUT: AC(100 – 240) V, (50–60)Hz, 1.7 A : OUTPUT: DC 24 V, 2.5 A
Receipt Date	: 25-Mar-19
X-tal list(s) or Frequencies generated	: The highest operating frequency is 2480 MHz(Bluetooth) : Bluetooth : 2.4 GHz

## 2.2 General descriptions of EUT

Category	Feature	Specification
Credential	Biometric	Face
	RF Option	FL-DB: 112.9 kHz EM & 13.56 MHz MIFARE, MIFARE Plus, DESFire/EV1, FeliCa, NFC & 2.4 GHz BLE
	RF read range*	MIFARE/DESFire: 50 mm, EM/Felica: 30 mm, BLE: 50 mm
	LFD	Supported
General	CPU	1.2 GHz Quad Core
	Memory	8GB Flash + 1GB RAM
	LCD type	2" color TFT LCD
	Sound	24 bit Voice DSP
	Operating temperature	-20 °C – 50 °C
	Storage temperature	-40 °C ~ 70 °C
	Operating humidity	0 % – 80 %, non-condensed
	Dimension (W x H x D)	80 mm x 160.3 mm x 71.8 mm
	Weight	Device: 296 g Bracket: 41 g (Including washer and bolt)
Interface	Wi-fi	Not Supported
	Ethernet	Supported (10/100 Mbps, auto MDI/MDI-X)
	RS-485	1ch Host or Slave (Selectable)
	Wiegand	1 ch Input / Output (Selectable)
	TTL input	2 ch Input
	USB	USB 2.0 (Host)
	Relay	1 Relay
	Tamper	Supported
Electrical	Power	Voltage: 24 VDC, Current: Max. 2.5 A
	Switch input VIH	Min. 3V, Max. 5V
	Switch input VIL	Max. 1V
	Wiegand output Pull-up resistance	Internally pulled-up with 1 kΩ
	Switch Pull-up resistance	4.7kΩ (The input ports are pulled up with 4.7kΩ.)
	Relay	Voltage: Max. 30 VDC, Current: Max. 2A

\* RF read range will vary depending on the installation environment.

### 3. Test Standards

#### Test Standard : FCC PART 15 Subpart C (15.247)

This Standard sets out the regulations under which an intentional, unintentional, or incidental radiator may be operated without an individual license. It also contains the technical specifications, administrative requirements and other conditions relating to the marketing of Part 15 devices.

#### Test Method : ANSI C 63.10 (2013) & KDB558074 D01

This standard sets forth uniform methods of measurement of radio-frequency (RF) signals and noise emitted from both unintentional and intentional emitters of RF energy in the frequency range 9 kHz to 40 GHz. Methods for the measurement of radiated and AC power-line conducted radio noise are covered and may be applied to any such equipment unless otherwise specified by individual equipment requirements. These methods cover measurement of certain devices that deliberately radiate energy, such as intentional emitters, but does not cover licensed transmitters. This standard is not intended for certification/approval of avionic equipment or for industrial, scientific, and medical (ISM) equipment. These methods apply to the measurement of individual units or systems comprised of multiple units.

#### Summary of Test Results

Applied Standard : 47 CFR Part 15 Subpart C				remark
Standard	Test Type	Result	Remark	Limit
15.207	AC Power Conducted Emission	Pass	Meet the requirement	
15.205 & 15.209	Restricted band / Intentional Radiated Emission	Pass	Meet the requirement	
15.247(a)(2)	6 dB Bandwidth	Pass	Meet the requirement	Min. 500 kHz
	Occupied Bandwidth			
15.247(b)(3)	Maximum Peak/average output power	Pass	Meet the requirement	Max. 30 dBm
15.247(c)	Transmitter Radiated Emission	Pass	Meet the requirement	Table 15.209
15.247(e)	Power Spectral Density	Pass	Meet the requirement	Max. 8 dBm
15.247(d)	Band Edge Measurement	Pass	Meet the requirement	20 dB less

## 4. Measurement Condition

### 4.1 EUT Operation

#### a. Channel

Ch.	Frequency	Ch.	Frequency
0	2402 MHz	20	2442 MHz
1	2404 MHz	21	2444 MHz
2	2406 MHz	22	2446 MHz
3	2408 MHz	23	2448 MHz
4	2410 MHz	24	2450 MHz
5	2412 MHz	25	2452 MHz
6	2414 MHz	...	...
...	...	39	2480 MHz
19	2440 MHz		

b. Measurement Channel : Bluetooth : Low(2402 MHz), Middle(2440 MHz), High(2480 MHz)

c. Test Mode : Continuous Output, GFSK

d. Test rate : 1 Mbps

## 4.2 EUT Operation.

- The EUT was in the following operation mode during all testing
  - \* Bluetooth operation check
  - \* Transmit mode were measured each channels(Low, Middle, High)

## 4.3 Configuration and Peripherals

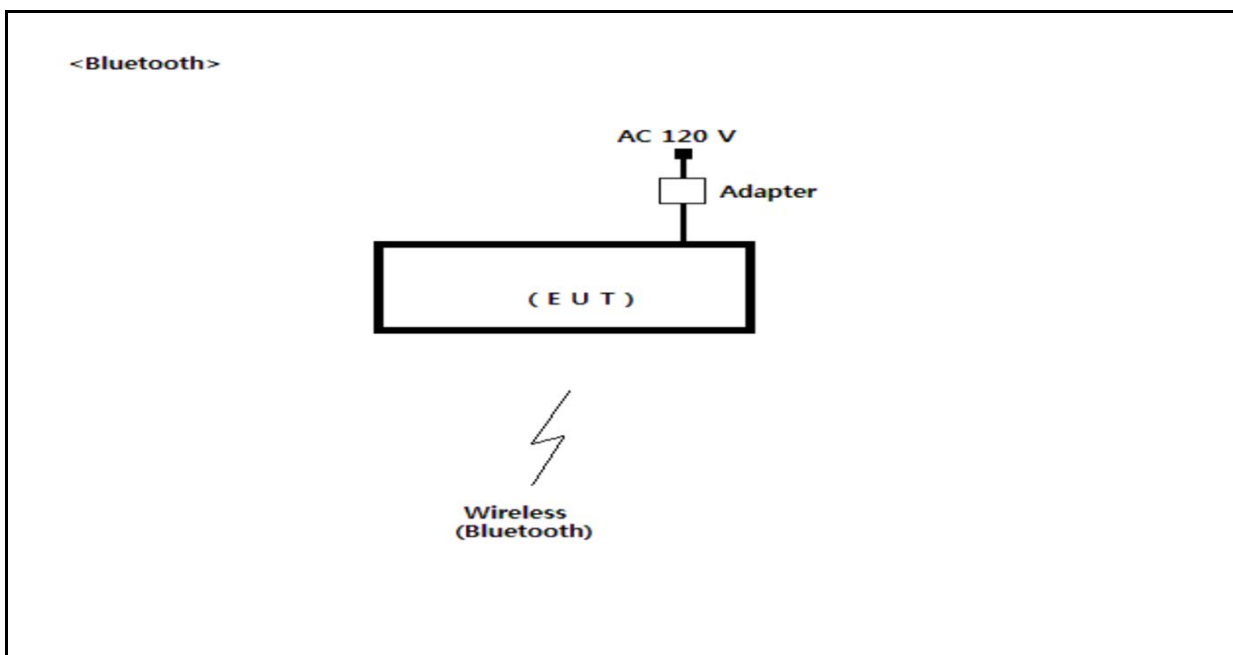



#### 4.4 EUT and Support equipment

Equipment Name	Model Name	S/N	Manufacturer	Remark (FCC ID)
Facelite	FL-DB	NONE	Suprema Inc	EUT
Adapter	KPL-060M	NONE	Channel Well Technology(Guangzhou)Co., Ltd.	

#### 4.5 Cable Connecting

Start Equipment		End Equipment		Cable Standard		Remark
Name	I/O port	Name	I/O port	Length	Shielded	
Facelite	Wireless (Bluetooth)	-	-	-	-	
Facelite	Power	Adapter	-	2.0	Unshielded	

## 4.6 DUTY CYCLE OF TEST SIGNAL

Duty cycle is < 98%, duty factor shall be considered.

duty cycle =  $0.382/0.625=0.6112$ , duty factor =  $10*\log(1/0.611)=2.138$

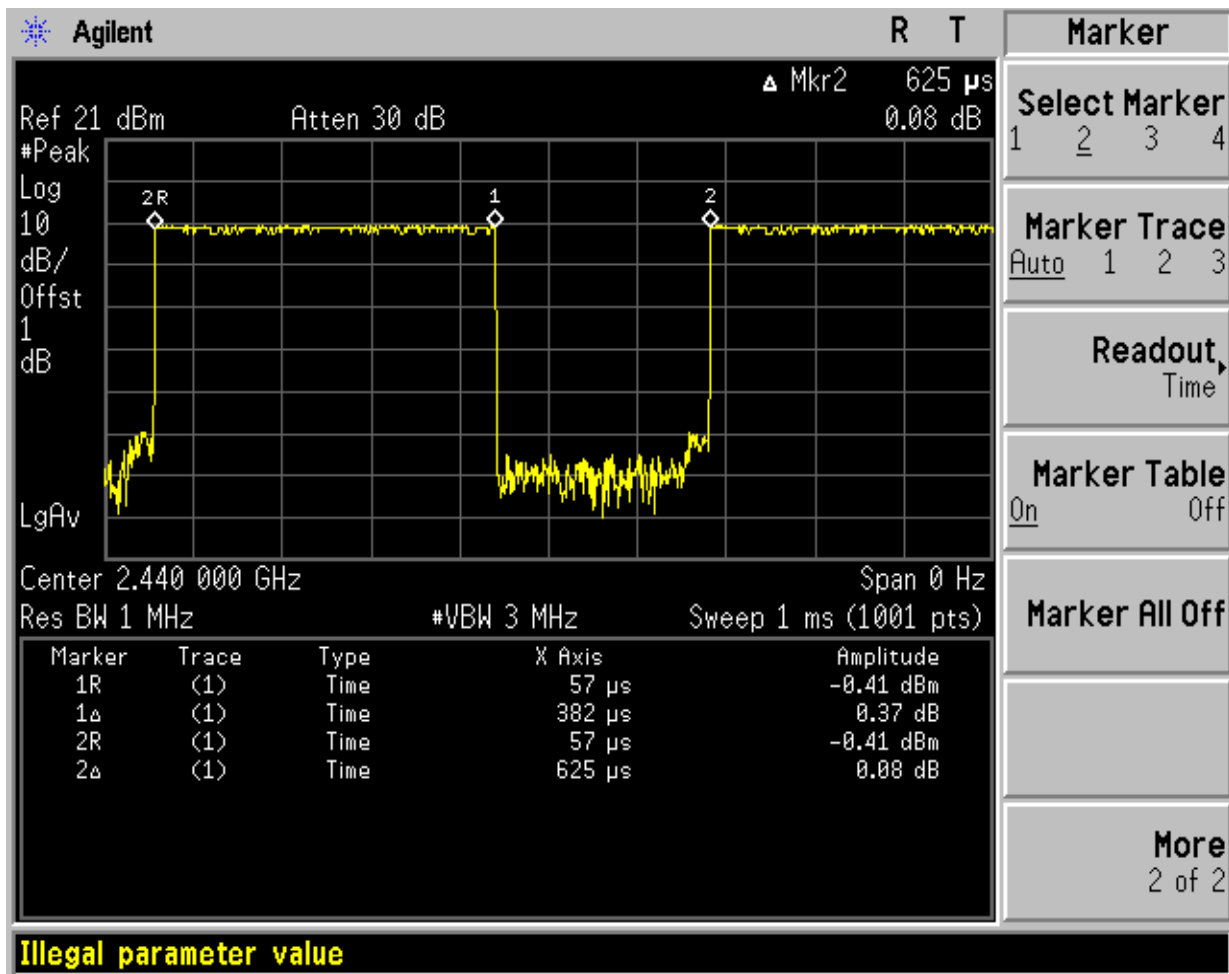

## 5. DTS bandwidth

### 5.1 Test procedure

558074 D01 DTS Meas Guidance v03r05 Option 2

### 5.2 Test instruments and measurement setup

The automatic bandwidth measurement capability of an instrument may be employed using the X dB bandwidth mode with X set to 6 dB, if the functionality described above (i.e., RBW = 100 kHz, VBW  $\geq$  3 X RBW, peak detector with maximum hold) is implemented by the instrumentation function. When using this capability, care shall be taken so that the bandwidth measurement is not influenced by any intermediate power nulls in the fundamental emission that might be  $\geq$  6 dB.

Limits : FCC § 15.247(a)(2)

#### 6dB Bandwidth Test Instruments

Description	Model	Serial Number	Cal. Due Date
Spectrum Analyzer	E4440A	US41421291	19-Dec-19
RF Cable	Length: 30 cm	–	
–Spectrum Analyzer $\Leftrightarrow$ EUT	Loss: 1 dB	–	

### 5.3 Measurement results

EUT	Facelite	MODEL	FL-DB
MODE	GFSK	ENVIRONMENTAL CONDITION	22.6 °C, 43.1 % R.H.
INPUT POWER	24.0 Vd.c.		

Channel Frequency (MHz)	Occupied Bandwidth(MHz)	Bandwidth at 6dB below(MHz)	Minimum Limit (MHz)	PASS/FAIL
2402	1.11	0.72	0.5	PASS
2440	1.09	0.70	0.5	PASS
2480	1.09	0.70	0.5	PASS

### 5.4 Trace data (ch\_0)

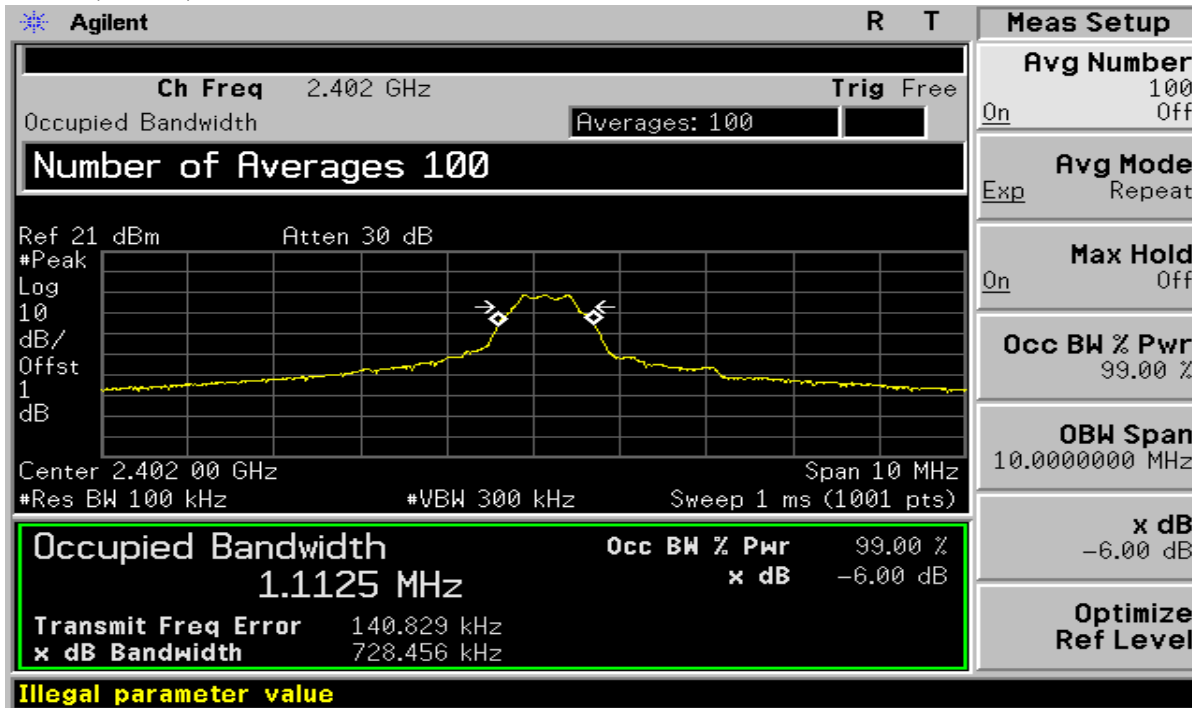

### (ch\_19)

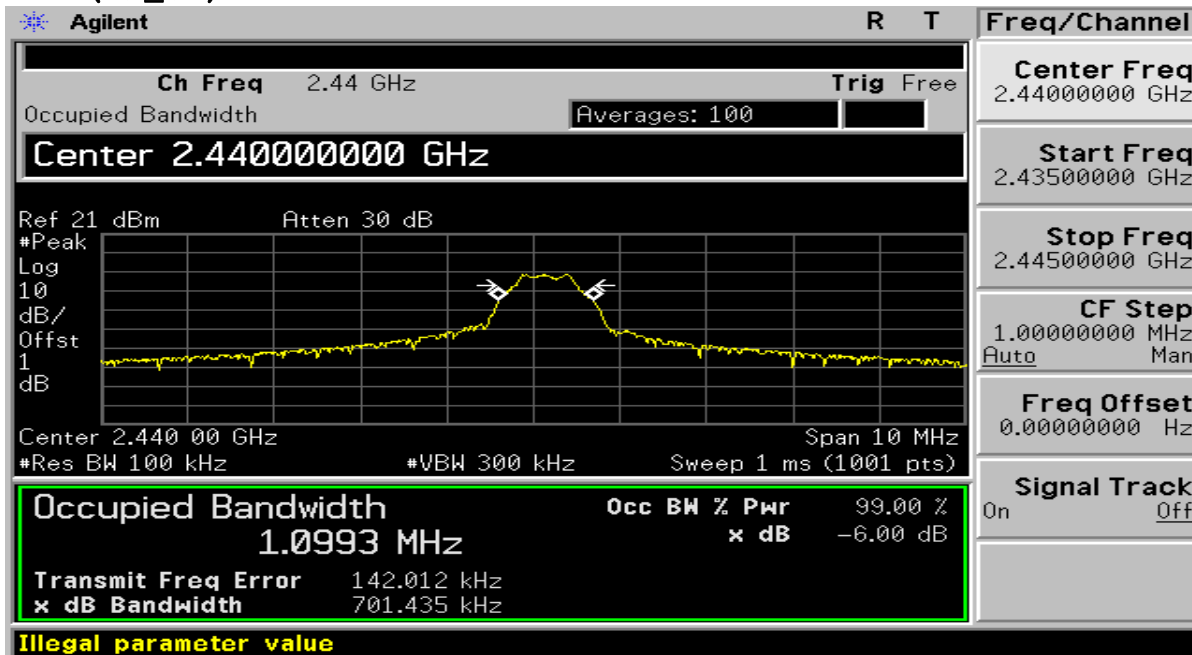



**Estech**  
your best partner

(ch\_39)

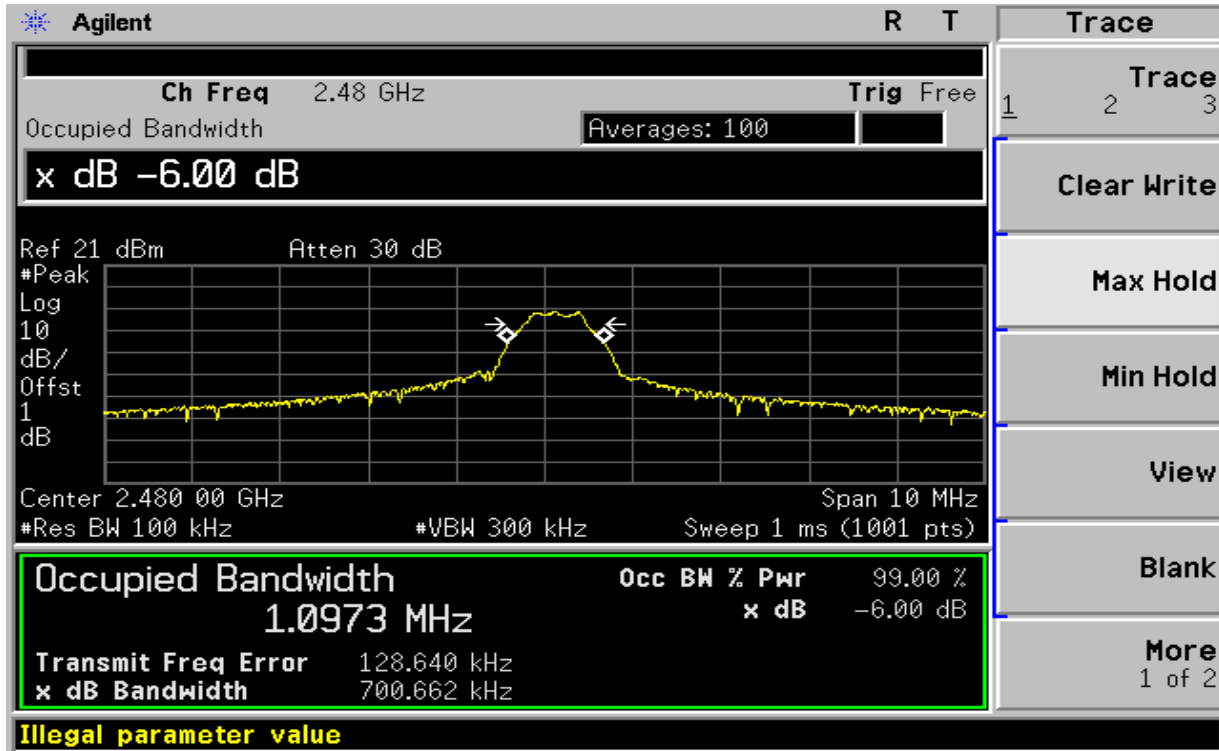

## 6. Maximum peak conducted output power

### 6.1 Test procedure

KDB 558074 D01 DTS Meas Guidance V03r05 9.1.1 Integrated band power method

### 6.2 Test instruments and measurement setup

- a) Set the RBW = 1 MHz.
- b) Set VBW  $\geq 3 \times$  RBW.
- c) Set span  $\geq 3 \times$  RBW
- d) Detector = peak.
- e) Sweep time = auto couple.
- f) Trace mode = max hold.
- g) Allow trace to fully stabilize.
- h) Use peak marker function to determine the peak amplitude level.

Limits : FCC § 15.247

#### Maximum Peak Output Power Test Instruments

Description	Model	Serial Number	Cal. Due Date
Spectrum Analyzer	E4440A	US41421291	19-Dec-19
RF Cable	Length: 30 cm	-	
-Spectrum Analyzer <=> EUT	Loss: 1 dB	-	

### 6.3 Measurement results

EUT	Facelite	MODEL	FL-DB
MODE	GFSK	ENVIRONMENTAL CONDITION	22.6 °C, 44.4 % R.H.
INPUT POWER	24.0 Vd.c.		

CHANNEL	Channel requency (MHz)	Conducted Power Output(dBm)			Limit[1W] (dBm)	PASS/FAIL
		Detector	(dBm)	(mW)		
0	2 402	PEAK	-0.05	0.989	30.0	PASS
19	2 440	PEAK	0.05	1.012	30.0	PASS
39	2 480	PEAK	-0.19	0.957	30.0	PASS

## 7. Maximum conducted (average) output power

### 7.1 Test procedure

KDB 558074 D01 DTS Meas Guidance V03r03 9.2.2.2 Method AVGSA-1 (trace averaging with the EUT transmitting at full power throughout each sweep)

### 7.2 Test instruments and measurement setup

- a) Set span to at least 1.5 times the OBW.
- b) Set RBW = 1–5% of the OBW, not to exceed 1 MHz.
- c) Set VBW  $\geq 3 \times$  RBW.
- d) Number of points in sweep  $\geq 2 \times$  span / RBW. (This gives bin-to-bin spacing  $\leq$  RBW/2, so that narrowband signals are not lost between frequency bins.)
- e) Sweep time = auto.
- f) Detector = RMS (i.e., power averaging), if available. Otherwise, use sample detector mode.
- g) If transmit duty cycle  $< 98 \%$ , use a sweep trigger with the level set to enable triggering only on full power pulses. The transmitter shall operate at maximum power control level for the entire duration of every sweep. If the EUT transmits continuously (i.e., with no off intervals) or at duty cycle  $\geq 98 \%$ , and if each transmission is entirely at the maximum power control level, then the trigger shall be set to “free run”.
- h) Trace average at least 100 traces in power averaging (i.e., RMS) mode.
- i) Compute power by integrating the spectrum across the OBW of the signal using the instrument’s band power measurement function, with band limits set equal to the OBW band edges. If the instrument does not have a band power function, sum the spectrum levels (in power units) at intervals equal to the RBW extending across the entire OBW of the spectrum.

#### Maximum Peak Output Power Test Instruments

Description	Model	Serial Number	Cal. Due Date
Spectrum Analyzer	E4440A	US42041291	19-Dec-19
RF Cable	Length: 30 cm	–	
–Spectrum Analyzer $\leftrightarrow$ EUT	Loss: 1 dB	–	

### 7.3 Measurement results

EUT	Facelite	MODEL	FL-DB
MODE	GFSK	ENVIRONMENTAL CONDITION	22.5 °C, 44.7 % R.H.
INPUT POWER	24.0 Vd.c.		

CHANNEL	Channel frequency (MHz)	Conducted Power Output(dBm)			Measured + Duty Cycle(dBm)	Measured + Duty Cycle(mW)
		Detector	(dBm)	Duty Cycle		
0	2 402	AVG	–8.07	2.138	–5.93	0.255
19	2 440	AVG	–8.52	2.138	–6.38	0.230
39	2 480	AVG	–9.08	2.138	–6.94	0.202

7.4 Trace data (Peak)  
(ch\_0)  
(Peak)

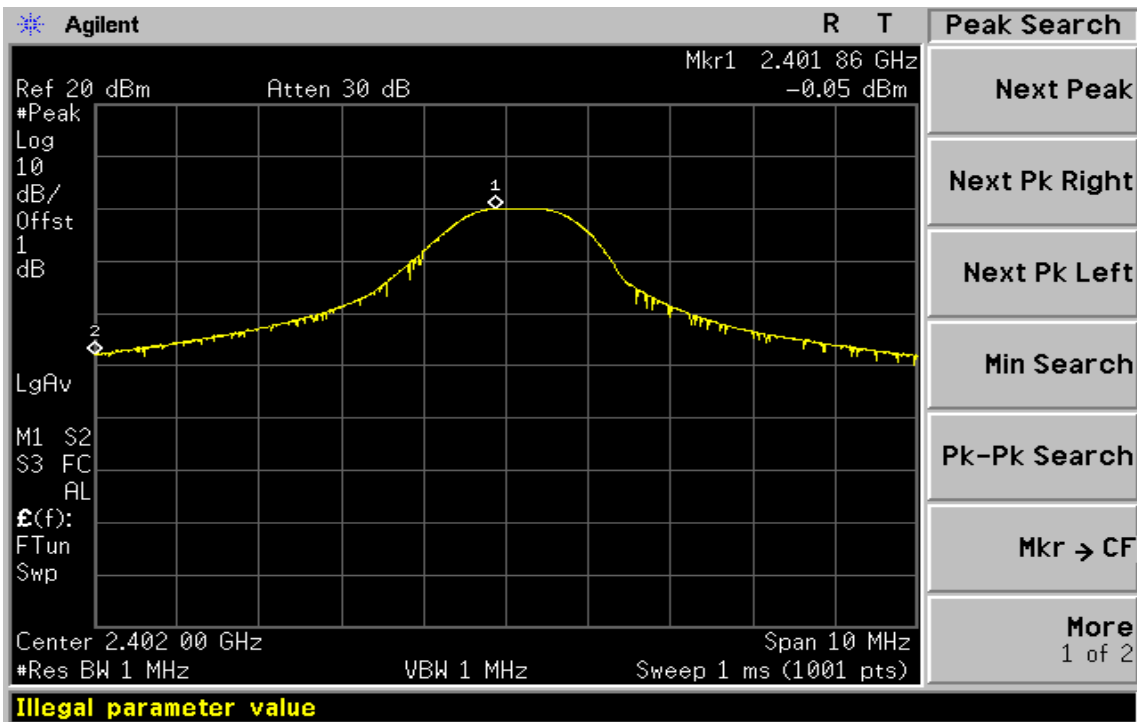

(Average)

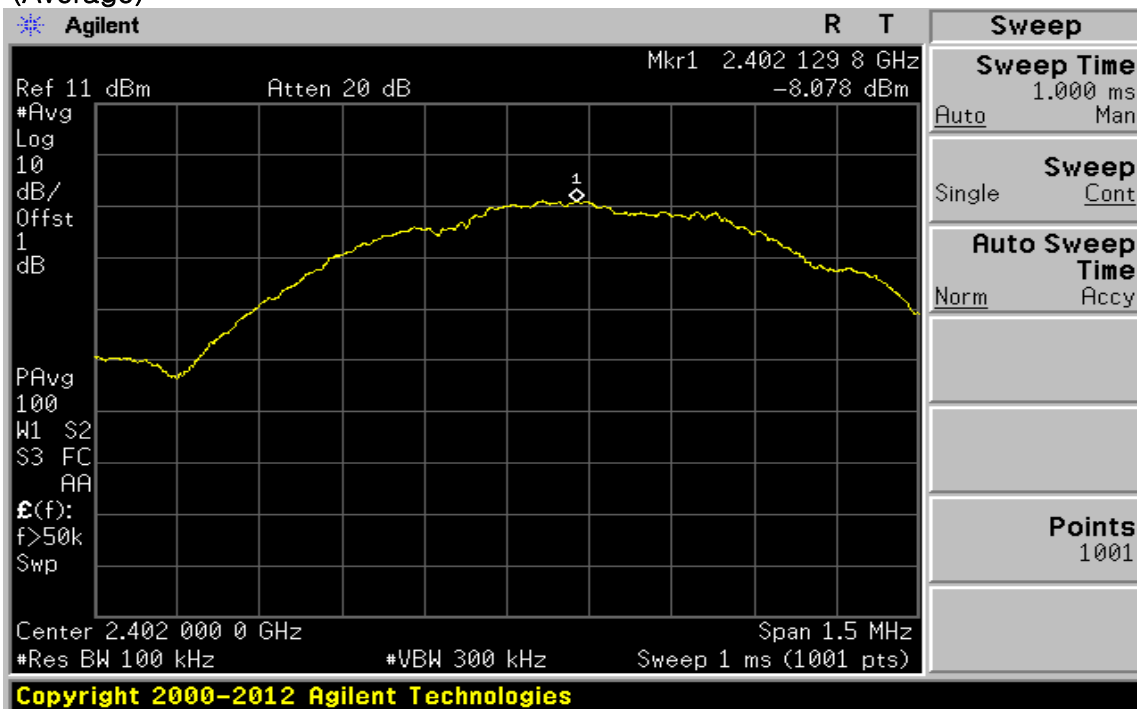





**Estech**  
your best partner

(ch\_19)

(Peak)

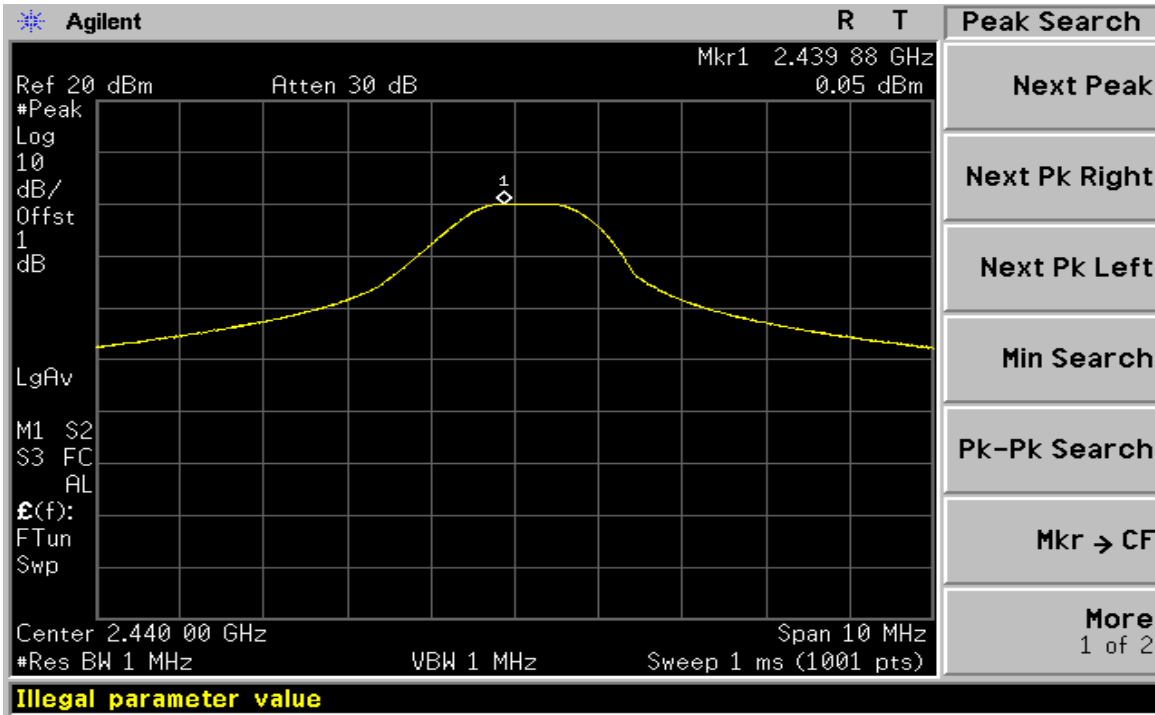

(Average)

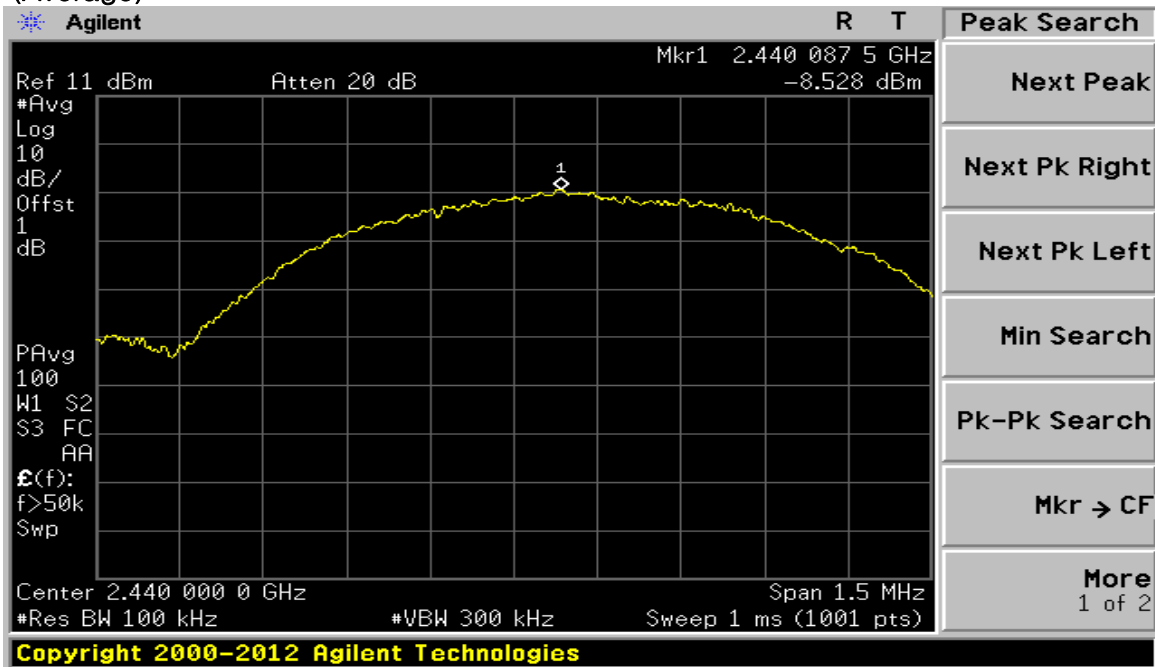



**Estech**  
your best partner

(ch\_39)

(Peak)

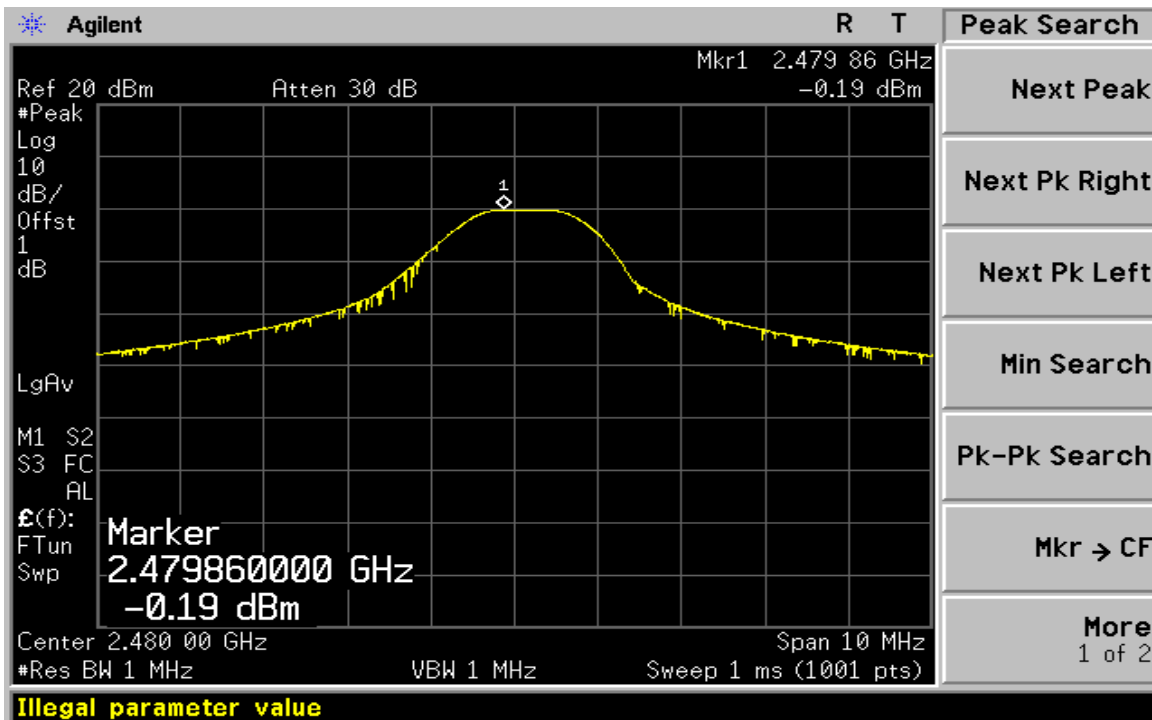

(Average)

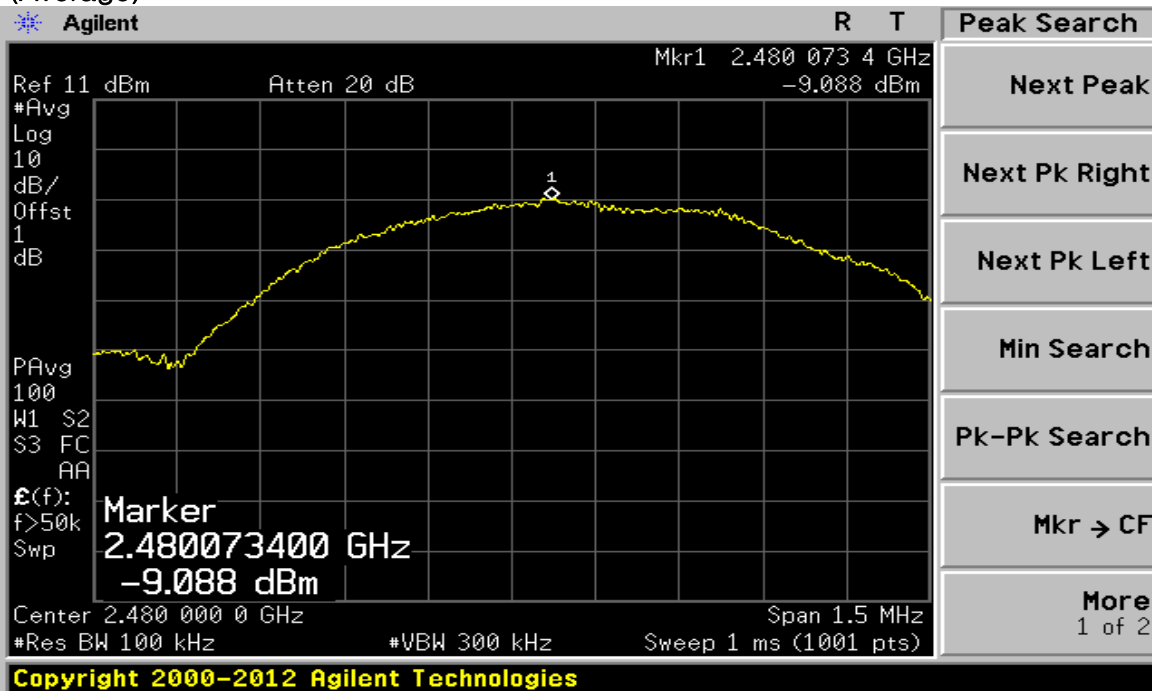



## 8. Maximum power spectral density level in the fundamental emission

### 8.1 Test procedure

KDB 558074 D01 DTS Meas Guidance V03r05 10.2 Method PKPSD (peak PSD)

### 8.2 Test instruments and measurement setup

This procedure shall be used if maximum peak conducted output power was used to demonstrate compliance, and is optional if the maximum conducted (average) output power was used to demonstrate compliance.

- a) Set analyzer center frequency to DTS channel center frequency.
- b) Set the span to 1.5 times the DTS bandwidth.
- c) Set the RBW to:  $3 \text{ kHz} \leq \text{RBW} \leq 100 \text{ kHz}$ .
- d) Set the VBW  $\geq 3 \times \text{RBW}$
- e) Detector = peak.
- f) Sweep time = auto couple.
- g) Trace mode = max hold.
- h) Allow trace to fully stabilize.
- i) Use the peak marker function to determine the maximum amplitude level within the RBW.
- j) If measured value exceeds limit, reduce RBW (no less than 3 kHz) and repeat.

Limits FCC § 15.247

#### The peak power density Test Instruments

Description	Model	Serial Number	Cal. Due Date
Spectrum Analyzer	E440A	US42041291	19-Dec-19
RF Cable	Length: 30 cm	-	
-Spectrum Analyzer <=> EUT	Loss: 1 dB	-	

### 8.3 Measurement results

EUT	Facelite	MODEL	FL-DB	
MODE	GFSK	ENVIRONMENTAL CONDITION	22.1 °C, 44.9 % R.H.	
INPUT POWER	24.0 Vd.c.			
CHANNEL	Channel Frequency (MHz)	Measured Power Spectral Density (dBm)	Maximum Permissible Power Density (dBm/3kHz)	Margin
0	2 402	-14.49	8.0	22.49
19	2 440	-14.61	8.0	22.61
39	2 480	-14.74	8.0	22.74

### 8.4 Trace data (ch\_0)

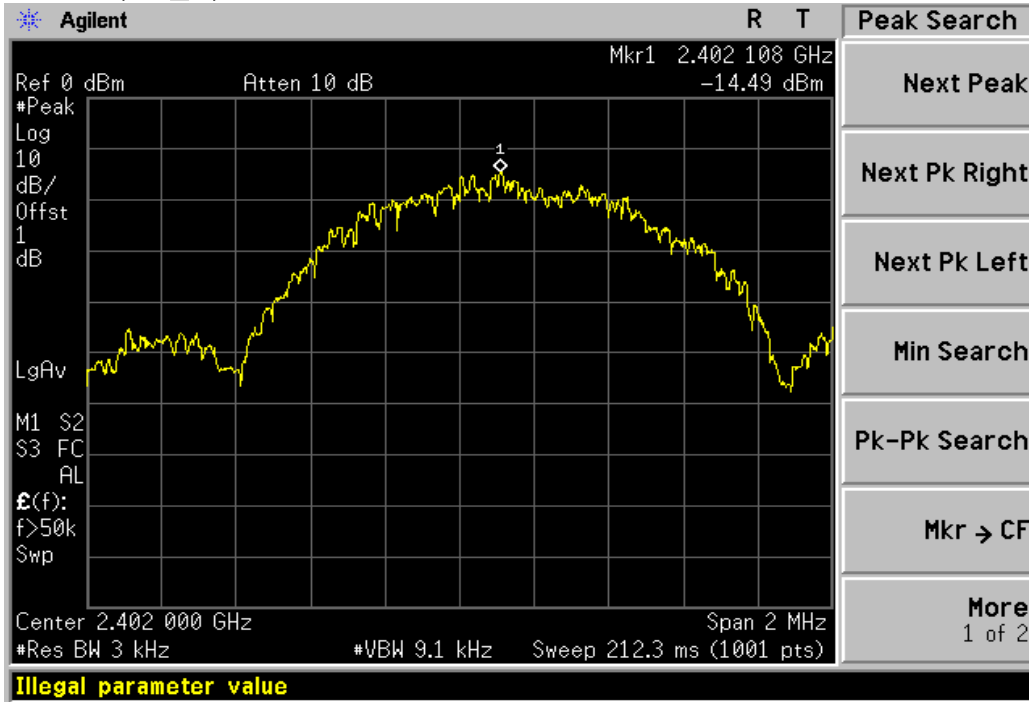

### (ch\_19)

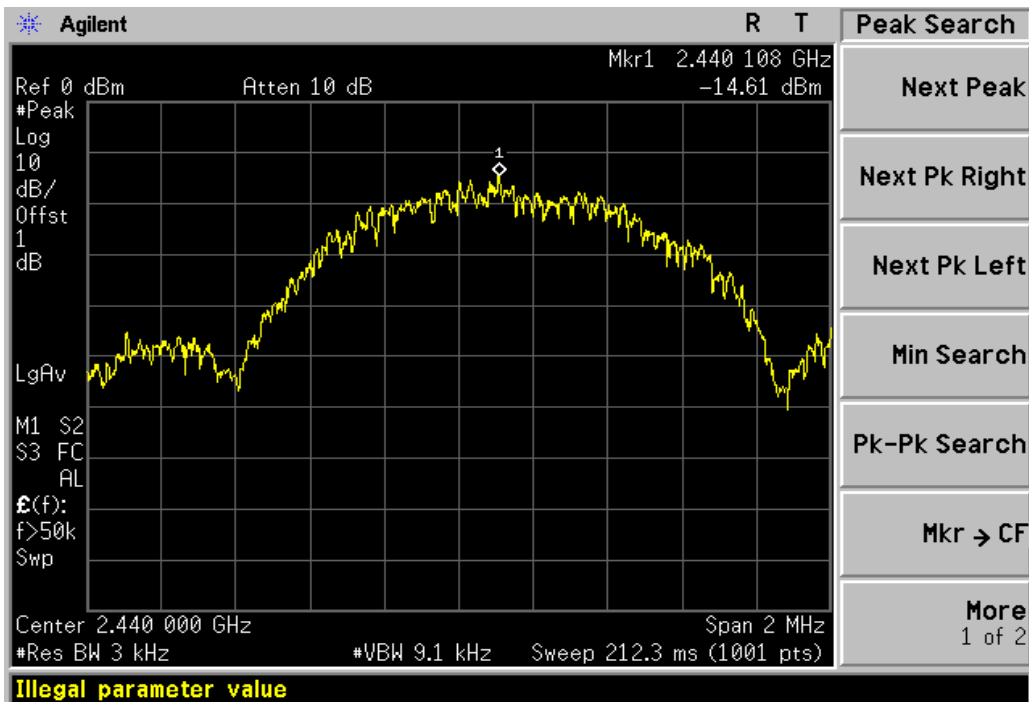



**Estech**  
your best partner

(ch\_39)

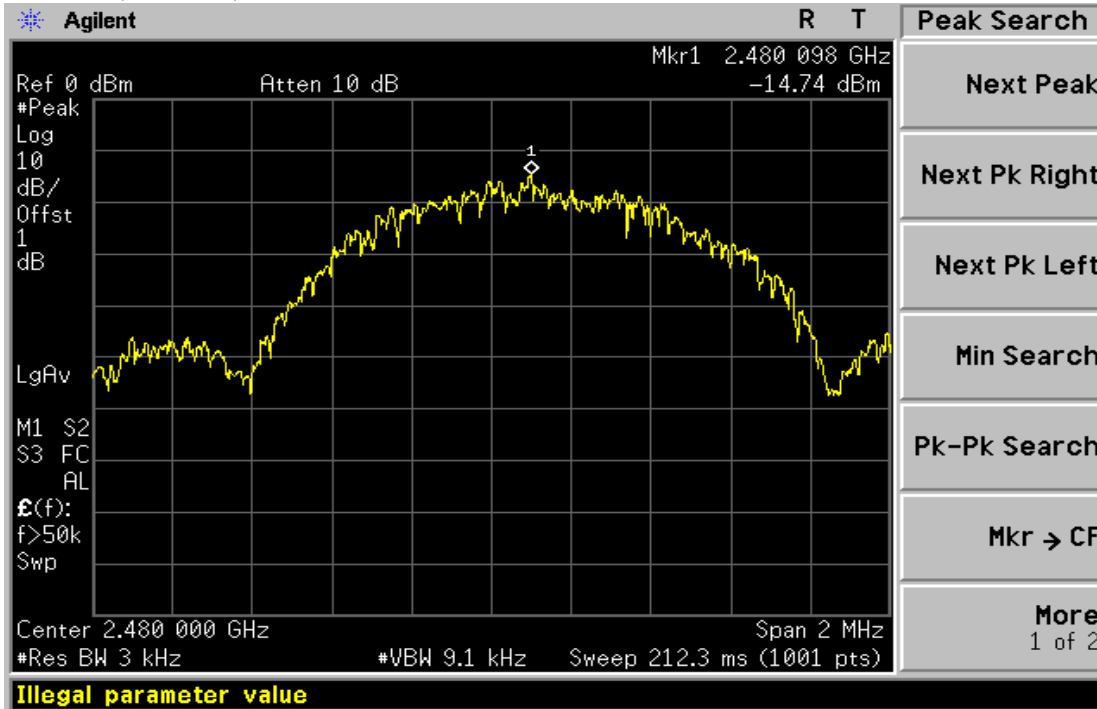

## 9. Emissions in non-restricted frequency bands

### 9.1 Test procedure

KDB 558074 D01 DTS Meas Guidance V03r05 11.0 Emissions in non-restricted frequency

### 9.2 Test instruments and measurement setup

The DTS rules specify that in any 100 kHz bandwidth outside of the authorized frequency band, the power shall be attenuated according to the following conditions(15.247(d))

- a) Set instrument center frequency to DTS channel center frequency.
- b) Set the span to  $\geq 1.5$  times the DTS bandwidth.
- c) Set the RBW = 100 kHz.
- d) Set the VBW  $\geq 3 \times$  RBW.
- e) Detector = peak.
- f) Sweep time = auto couple.
- g) Trace mode = max hold.
- h) Allow trace to fully stabilize.
- i) Use the peak marker function to determine the maximum PSD level.

Limits FCC § 15.247

#### Band Edge&Out of Emission Test Instruments

Description	Model	Serial Number	Cal. Due Date
Spectrum Analyzer	E4440A	US42041291	19-Dec-19
RF Cable	Length: 30 cm		-
-Spectrum Analyzer <=> EUT	Loss: 1 dB		-

### 9.3 Measurement results of band-edge & out of emission

EUT	Facelite	MODEL	FL-DB
MODE	GFSK	ENVIRONMENTAL CONDITION	23.0 °C, 44.0 % R.H.
INPUT POWER	24.0 Vd.c.		

CHANNEL	Channel Frequency (MHz)	limit	PASS/FAIL
0	2 402	20dBc	PASS
39	2 480	20dBc	PASS

### 9.4 Trace data of band-edge & Out of Emission (ch\_0)

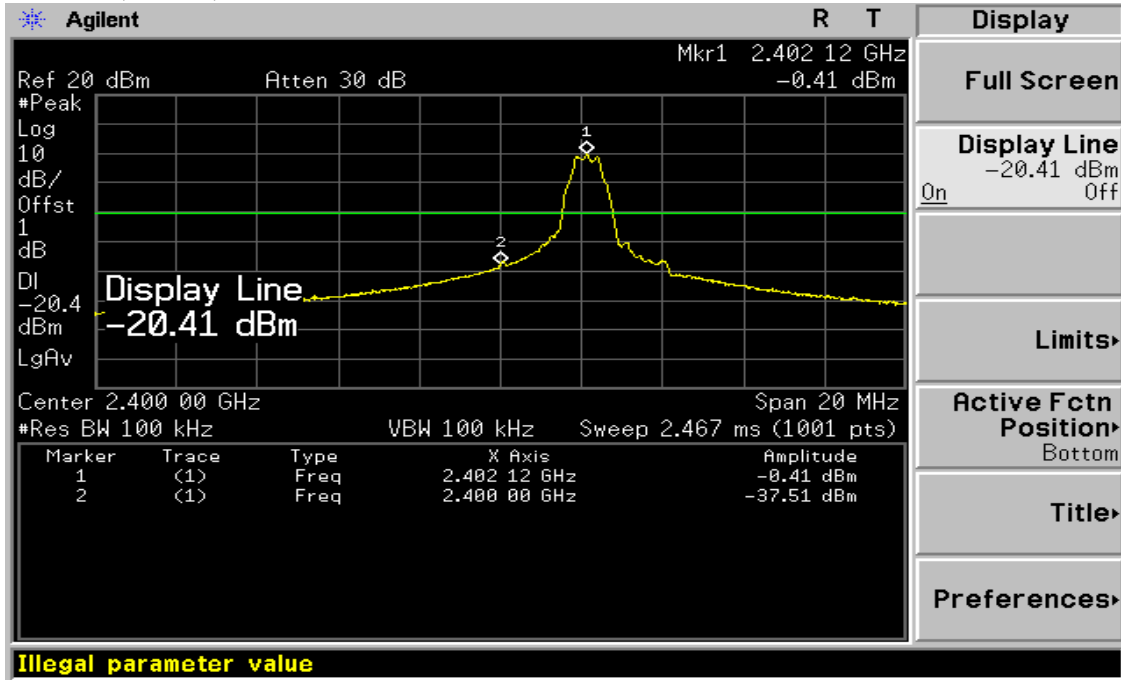

### (ch\_39)

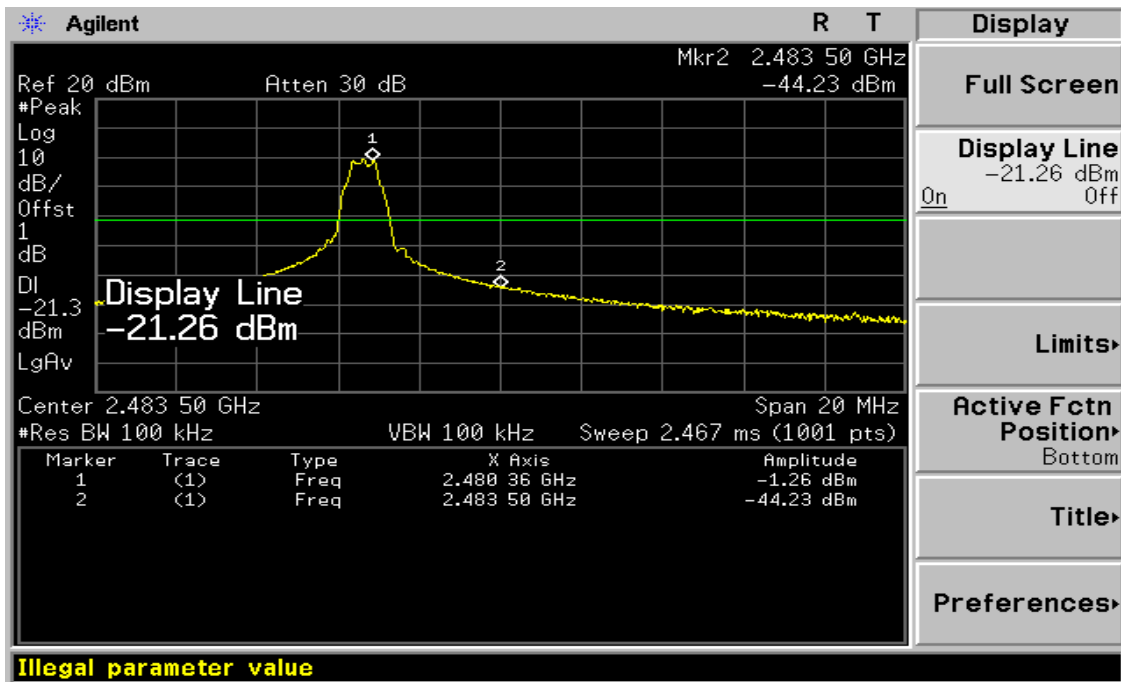



**Estech**  
your best partner

(ch\_0)

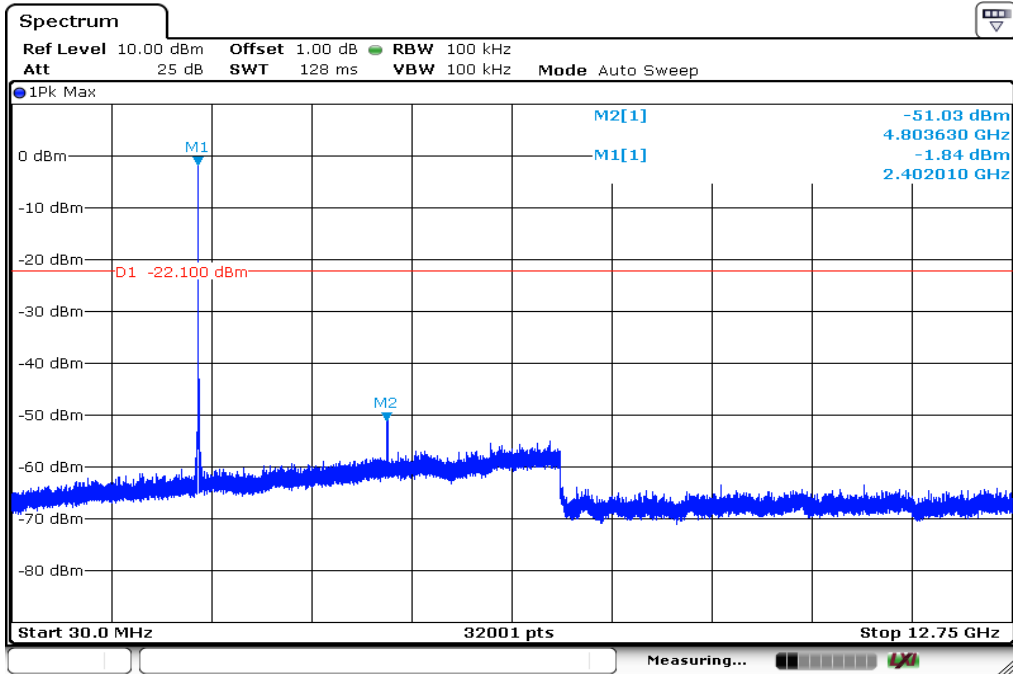

PL-DB





**Estech**  
your best partner

(ch\_19)

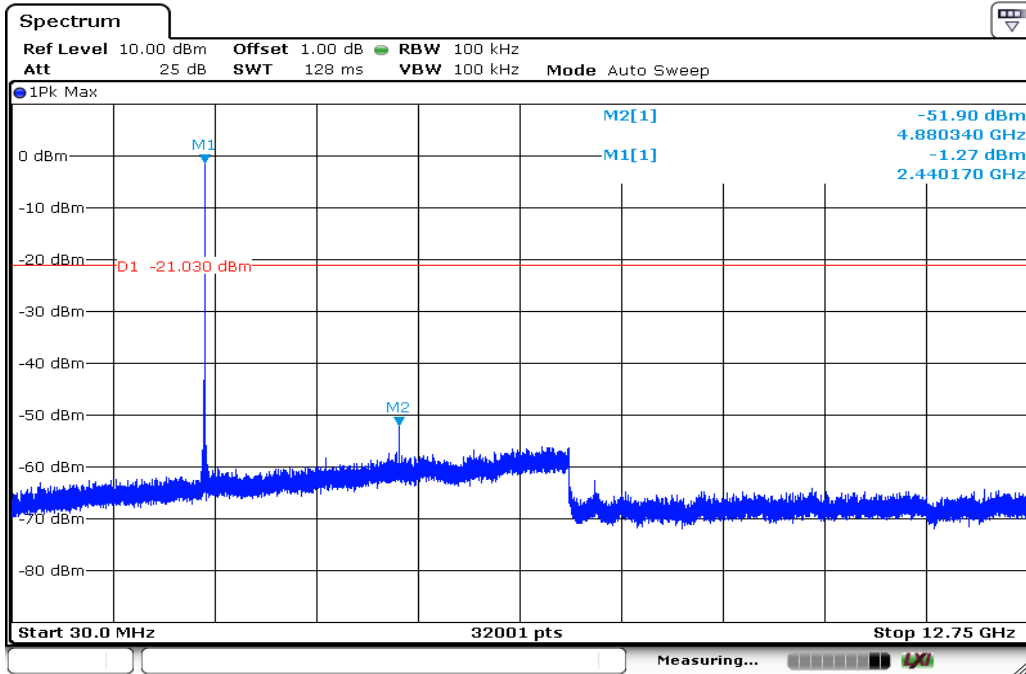

FL-DB



**Estech**  
your best partner

(ch\_39)

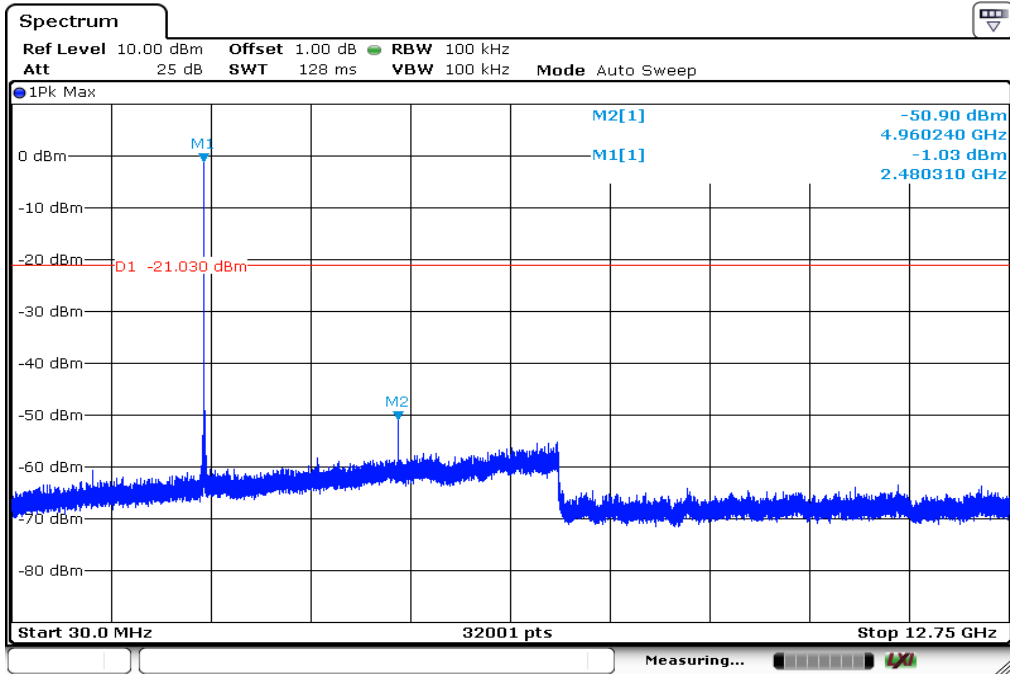

PL-DB

## 10. Measurement of radiated disturbance

Above 30 MHz Electric Field strength was measured in accordance with FCC PART 15.205, 15.209 . The test setup was made according to ANSI C 63.10 (2013) & KDB 558074 D01 Semi-anechoic chamber, which allows a 3 m distance measurement. The EUT was placed in the center of styrofoam. turntable. The height of this table was 0.8 m. The measurement was conducted with both horizontal and vertical antenna polarization. The turntable has fully rotated. For further description of the configuration refer to the picture of the test setup.

### 10.1 Measurement equipments

Equipment Name	Type	Manufacturer	Serial No.	Next Calibration date
TEST Receiver	ESCI7	ROHDE & SCHWARZ	100916	19-Oct-19
Logbicon Antenna	VULB 9168	SCHWARZBECK	193	15-Oct-19
Turn Table	DT3000-2t	Innco System GmbH	N/A	-
Antenna Mast	MA4000-EP	Innco System GmbH	N/A	-
PREAMPLIFIER	8449B	AGILENT	3008A00581	22-Oct-19
Horn Antenna	BBHA9120D	SCHWARZBECK	469	30-Apr-19
Test Receiver	ESPI7	ROHDE & SCHWARZ	100185	22-Oct-19
Signal Analyzer	FSV40	ROHDE & SCHWARZ	100393	21-Dec-19
Turn Table	DT1500-S	Innco System GmbH	N/A	-
Antenna Mast	MA4000-EP	Innco System GmbH	N/A	-
Horn Antenna	BBHA 9170	SCHWARZBECK	752	1-Nov-19
Antenna Master & Turn table controller	C02000-P	Innco System GmbH	CO2000/642 /28051111/L	-

### 10.2 Environmental Condition

Below 1 GHz –Test Place : 10 m Semi-anechoic chamber

#### BT(BLE) MODE

Temperature (°C) : 22.6 °C

Humidity (% R.H.) : 45.7 % R.H.

Above 1 GHz–Test Place : 3 m Semi-anechoic chamber

#### BT(BLE) MODE

Temperature (°C) : 22.4 °C

Humidity (% R.H.) : 48.6 % R.H.

## 10.3 Measurement Instrument setting for Radiated Emission

### 10.3.1 Frequency range below 1 GHz

Detector : Quasi-Peak

### 10.3.2 Frequency range above 1 GHz

#### Peak Power Measurement Procedure (KDB 558074 section 12.2.4)

- a. RBW : 1 MHz , VBW : 3 MHz
- b. Trace mode = max hold
- c. Detector : Peak
- d. Sweep time = auto

#### Average Power Measurement Procedures (KDB 558074 section 12.2.5.2)

- a. Set analyzer center frequency to the frequency associated with the emission
- b. RBW : 1 MHz , VBW : 3 MHz
- c. Detector : RMS
- d. Sweep time = auto

Note

Band	Duty cycle(%)	Ton (ms)	Ton + Toff (ms)	DCF=10*log(1/Duty) (dB)
BT(BLE)	61.1	0.382	0.625	2.138

\* This was not applied of duty cycle factor for average value because of measured with the EUT transmitting continuously more than 98 % duty cycle at its maximum power control level.

### 10.4 Test data(30 MHz ~ 1 000 MHz)

Test Date : 23-May-19

Measurement Distance : 3 m

Frequency (MHz)	Reading (dB $\mu$ V)	Position (V/H)	Height (m)	Correction Factor		Result Value(Quasi-peak)		
				Ant Factor (dB)	Cable (dB)	Limit (dB $\mu$ V/m)	Result (dB $\mu$ V/m)	Margin (dB)
400.00	15.94	V	1.2	15.63	3.16	46.00	34.73	11.27
500.00	17.15	V	1.1	17.84	3.52	46.00	38.51	7.49
550.00	19.76	V	1.0	18.97	3.73	46.00	42.45	3.55
600.00	12.47	V	1.0	19.72	3.93	46.00	36.12	9.88
650.00	16.57	V	1.0	20.51	4.10	46.00	41.18	4.82
750.00	14.88	H	1.0	21.87	4.45	46.00	41.20	4.80
Remark	<p>H : Horizontal, V : Vertical TEST MODE : BT BLE (CH : 19 - 2 440 MHz)</p> <p>*Checked in all 3 axis and the maximum measured data were reported.( Worst data is Z axis of position)</p> <p>*CL = Cable Loss(In case of below 1 000 MHz)</p> <p>*Result Value = Reading + Ant Factor + Cable loss</p> <p>*The resolution bandwidth and video bandwidth of test receiver/spectrum analyzer is 120 kHz for Quasi-peak detection at frequency below 1 GHz.</p>							

### 10.4-1 Test Data(Low)

Test Date : 23-May-19

Measurement Distance : 3 m

Frequency (MHz)	Reading (dB $\mu$ V)	Position (V/H)	Height (m)	Correction Factor		Duty Cycle Correction(dB)	Result Value		
				Ant Factor (dB)	AMP & Cable (dB)		Limit (dB $\mu$ V/m)	Result (dB $\mu$ V/m)	Margin (dB)
PEAK(RBW: 1 MHz VBW: 3 MHz)									
2390.00	26.54	V	1.5	26.11	5.87		74.00	58.52	15.48
2390.00	26.06	H	1.6	26.11	5.87		74.00	58.04	15.96
4804.00	41.12	V	1.5	30.93	-27.04		74.00	45.01	28.99
4804.00	41.05	H	1.6	30.93	-27.04		74.00	44.94	29.06
AV(RBW: 1 MHz VBW: 3 MHz)									
2390.00	14.57	V	1.5	26.11	5.87	2.14	54.00	48.69	5.31
2390.00	14.54	H	1.6	26.11	5.87	2.14	54.00	48.66	5.34
4804.00	29.52	V	1.5	30.93	-27.04	2.14	54.00	35.55	18.45
4804.00	29.43	H	1.6	30.93	-27.04	2.14	54.00	35.46	18.54
Remark	<p>H : Horizontal, V : Vertical TEST MODE : CH : 0 - 2 402 MHz (x postion)</p> <p>*The TX signal wasn't detected from 3th harmonics.            *Checked in all 3 axis and the maximum measured data were reported.( Worst data is Z axis of position)            *Total = Reading Value + Antenna Factor + Cable Loss - Amp Gain + Duty Cycle Correction</p>								

### 10.4-2 Test Data(Middle)

Test Date : 3-May-18

Measurement Distance : 3 m

Frequency (MHz)	Reading (dB $\mu$ V)	Position (V/H)	Height (m)	Correction Factor		Duty Cycle Correction(dB)	Result Value		
				Ant Factor (dB)	AMP & Cable (dB)		Limit (dB $\mu$ V/m)	Result (dB $\mu$ V/m)	Margin (dB)
PEAK(RBW: 1 MHz VBW: 3 MHz)									
4880.00	41.23	H	1.6	31.15	-26.82		74.00	45.56	28.44
4880.00	41.08	V	1.5	31.15	-26.82		74.00	45.41	28.59
AV(RBW: 1 MHz VBW: 3 MHz)									
4880.00	28.93	H	1.6	31.15	-26.82	2.32	54.00	35.58	18.42
4880.00	28.52	V	1.5	31.15	-26.82	2.32	54.00	35.17	18.83
Remark	<p>H : Horizontal, V : Vertical TEST MODE : CH : 19 - 2 440 MHz (x postion)</p> <p>*The TX signal wasn't detected from 3th harmonics.</p> <p>*Checked in all 3 axis and the maximum measured data were reported.( Worst data is Z axis of position)</p> <p>*Total = Reading Value + Antenna Factor + Cable Loss - Amp Gain + Duty Cycle Correction</p>								

### 10.4-3 Test Data(High)

Test Date : 3-May-19

Measurement Distance : 3 m

Frequency (MHz)	Reading (dB $\mu$ V)	Position (V/H)	Height (m)	Correction Factor		Duty Cycle Correction(dB)	Result Value		
				Ant Factor (dB)	AMP & Cable (dB)		Limit (dB $\mu$ V/m)	Result (dB $\mu$ V/m)	Margin (dB)
PEAK(RBW: 1 MHz VBW: 3 MHz)									
2483.50	36.12	H	1.5	26.30	5.95		74.00	68.37	5.63
2483.50	37.88	V	1.6	26.30	5.95		74.00	70.13	3.87
4960.00	41.34	H	1.4	31.38	-26.70		74.00	46.02	27.98
4960.00	41.24	V	1.4	31.38	-26.70		74.00	45.92	28.08
AV(RBW: 1 MHz VBW: 3 MHz)									
2483.50	16.42	H	1.5	26.30	5.95	2.14	54.00	50.81	3.19
2483.50	15.57	V	1.6	26.30	5.95	2.14	54.00	49.96	4.04
4960.00	29.37	H	1.4	31.38	-26.70	2.14	54.00	36.19	17.81
4960.00	28.97	V	1.4	31.38	-26.70	2.14	54.00	35.79	18.21
Remark	<p>H : Horizontal, V : Vertical TEST MODE : CH : 39 - 2 480 MHz (x postion)</p> <p>*The TX signal wasn't detected from 3th harmonics.</p> <p>*Checked in all 3 axis and the maximum measured data were reported.( Worst data is Z axis of position)</p> <p>*Total = Reading Value + Antenna Factor + Cable Loss - Amp Gain + Duty Cycle Correction</p>								



## 10.4-4 Restricted Band Edges

Band Edges(CH Low)

Detector mode:Peak

Polarity:Horizontal

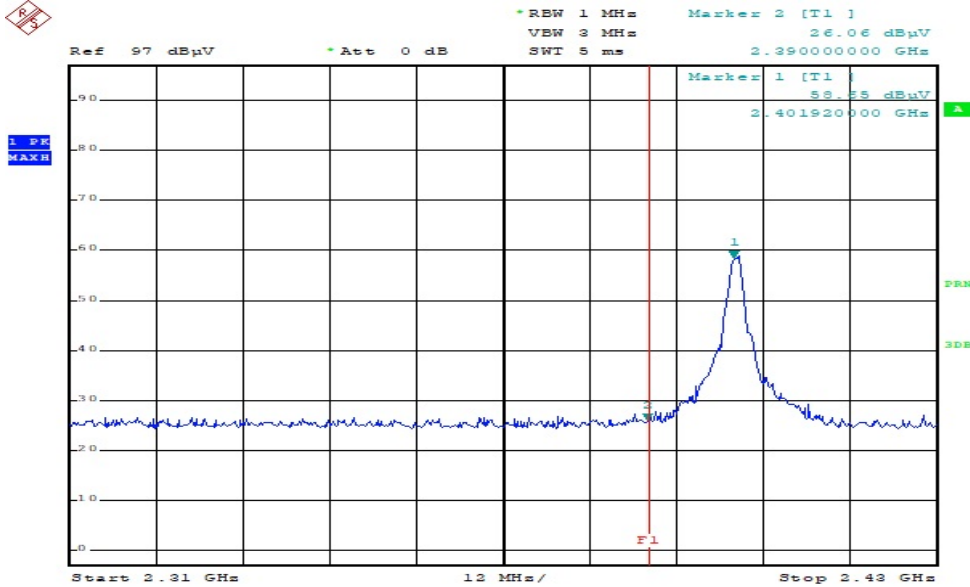

Comment: FL-DB\_CH0\_PEAK\_HOR

Detector mode:Average

Polarity:Horizontal

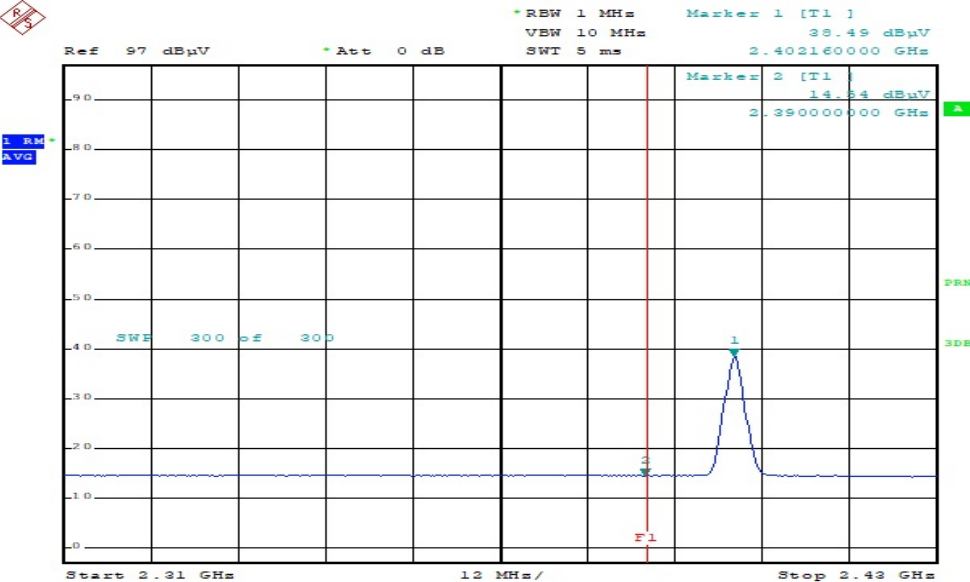

Comment: FL-DB\_CH0\_AV\_HOR

Band Edges(CH Low)

Detector mode:Peak

Polarity:Vertical

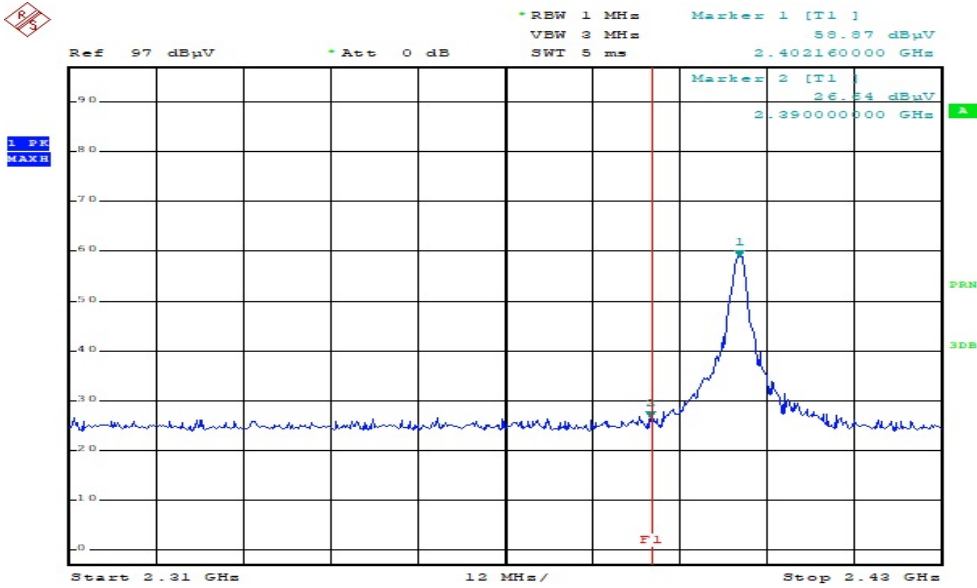

Comment: FL-DB\_CHO\_PEAK\_VER

Detector mode:Average

Polarity:Vertical

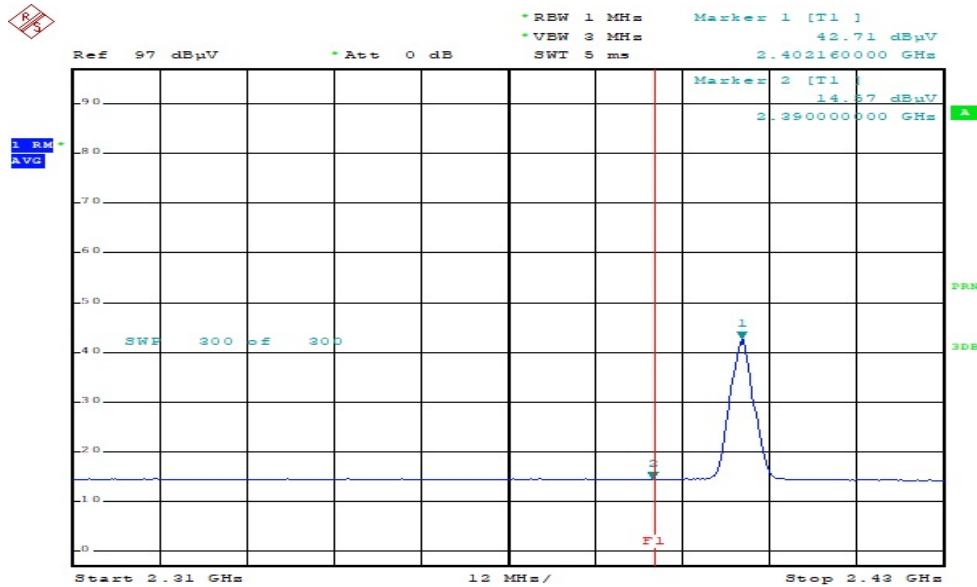

Comment: FL-DB\_CHO\_AV\_VER

Band Edges(CH High)

Detector mode:Peak

Polarity:Horizontal

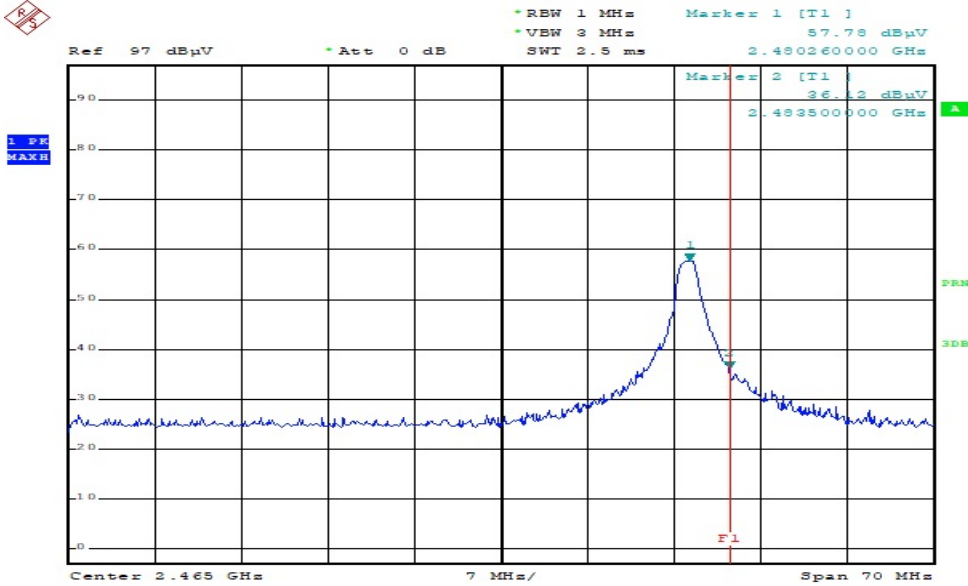

Comment: FL-DE\_CH39\_PEAK\_HOR

Detector mode:Average

Polarity:Horizontal

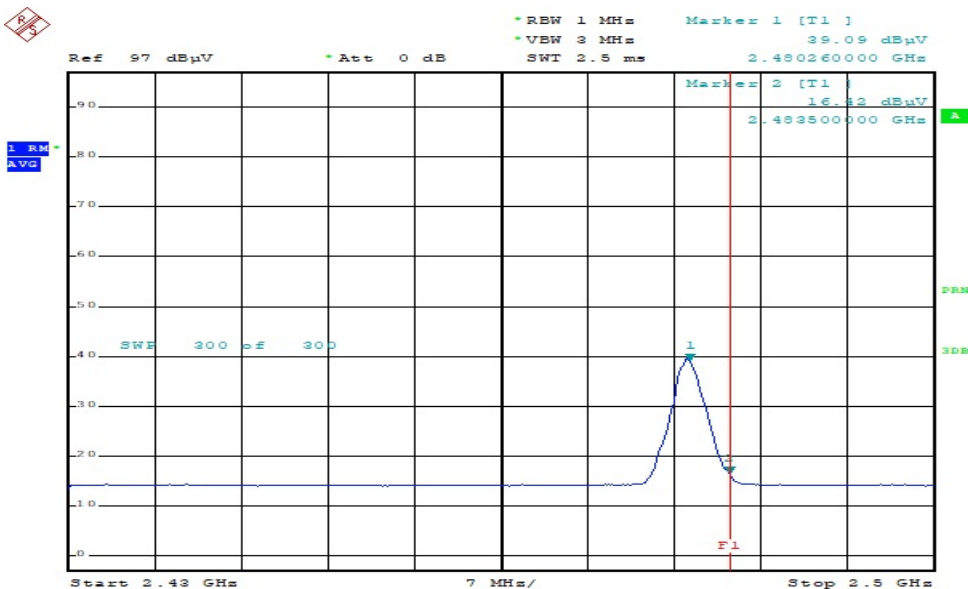

Comment: FL-DE\_CH39\_AV\_HOR

Band Edges(CH High)

Detector mode:Peak

Polarity:Vertical

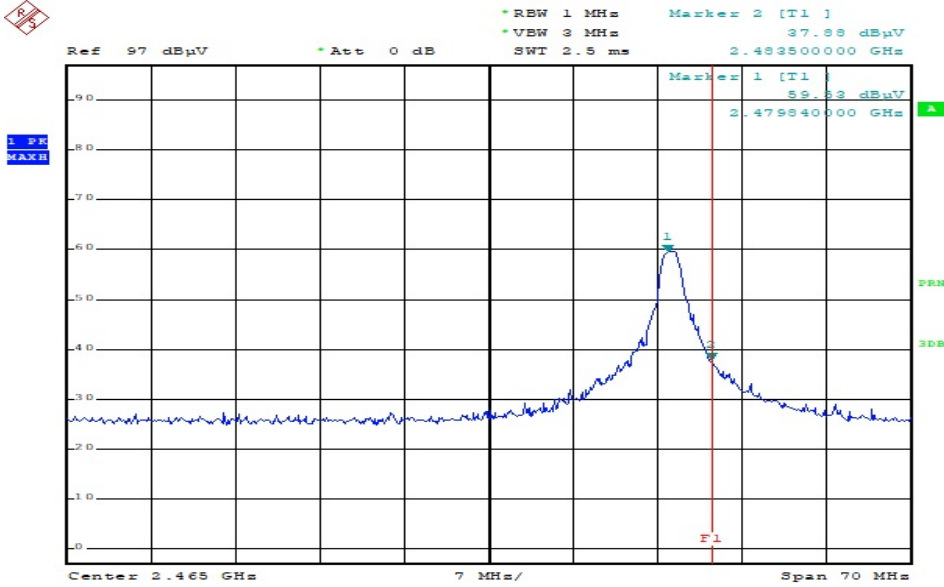

Comment: FL-DB CH39 PEAK VER

Detector mode:Average

Polarity:Vertical

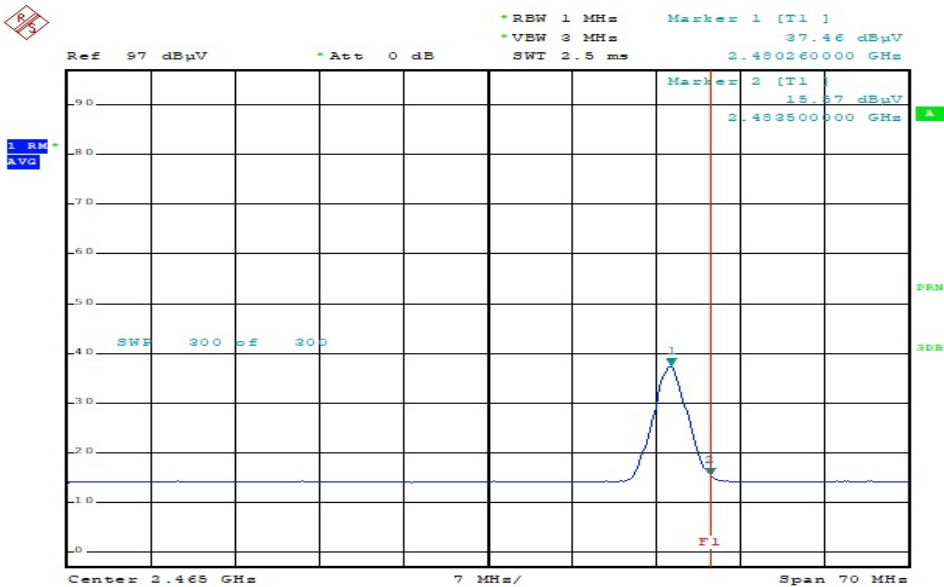

Comment: FL-DB\_CH39\_AV\_VER

## 11. Measurement of conducted disturbance

The continuous disturbance voltage of AC Mains in the frequency from 0.15 MHz to 30 MHz was measured in accordance to FCC PART 15.207. The test setup was made according to ANSI C 63.10 (2009) in a shielded room. The EUT was placed on a non-conductive table at least 0.8 m above the ground plan. A grounded vertical reference plane was positioned in a distance of 0.4 m from the EUT. The distance from the EUT to other metal surfaces was at least 0.8 m. The EUT was only earthen by its power cord through the line impedance stabilizing network. The power cord has been bundled to a length of 1.0 m. The test receiver with Quasi Peak detector complies with CISPR 16.

### 11.1 Measurement equipments

Equipment Name	Type	Manufacturer	Serial No.	Next Calibration date
TEST RECEIVER	ESPI	Rohde & Schwarz	100005	24-Oct-19
LISN	ESH3-Z5	Rohde & Schwarz	836679/025	24-Oct-19
Pulse Limiter	ESH3-Z2	Rohde & Schwarz	NONE	23-Oct-19

### 11.2 Environmental Condition

Test Place : Shielded Room

Temperature (°C) : 23.3 °C

Humidity (% R.H.) : 44.8 % R.H.



### 8.3 Test data

Test Date : 28-May-19

Frequency (MHz)	Correction Factor		Line (H/N)	Quasi-peak Value			Average Value		
	Lisn (dB)	Cable (dB)		Limit (dB $\mu$ V)	Reading (dB $\mu$ V)	Result (dB $\mu$ V)	Limit (dB $\mu$ V)	Reading (dB $\mu$ V)	Result (dB)
0.20	0.09	0.20	N	63.45	34.47	34.76	53.45	33.14	33.43
0.27	0.16	0.20	H	61.12	37.51	37.87	51.12	33.50	33.86
0.41	0.16	0.21	H	57.75	32.38	32.75	47.75	29.03	29.40
0.54	0.16	0.21	H	56.00	34.86	35.23	46.00	32.43	32.80
0.61	0.17	0.22	H	56.00	37.18	37.56	46.00	34.71	35.09
0.68	0.17	0.22	H	56.00	37.89	38.28	46.00	35.77	36.16
Remark	H : Hot Line, N : Neutral Line *Correction Factor = Lisn + Cable *Result = Correction Factor + Reading								

# Appendix 1. Special diagram

## \* HOT LINE

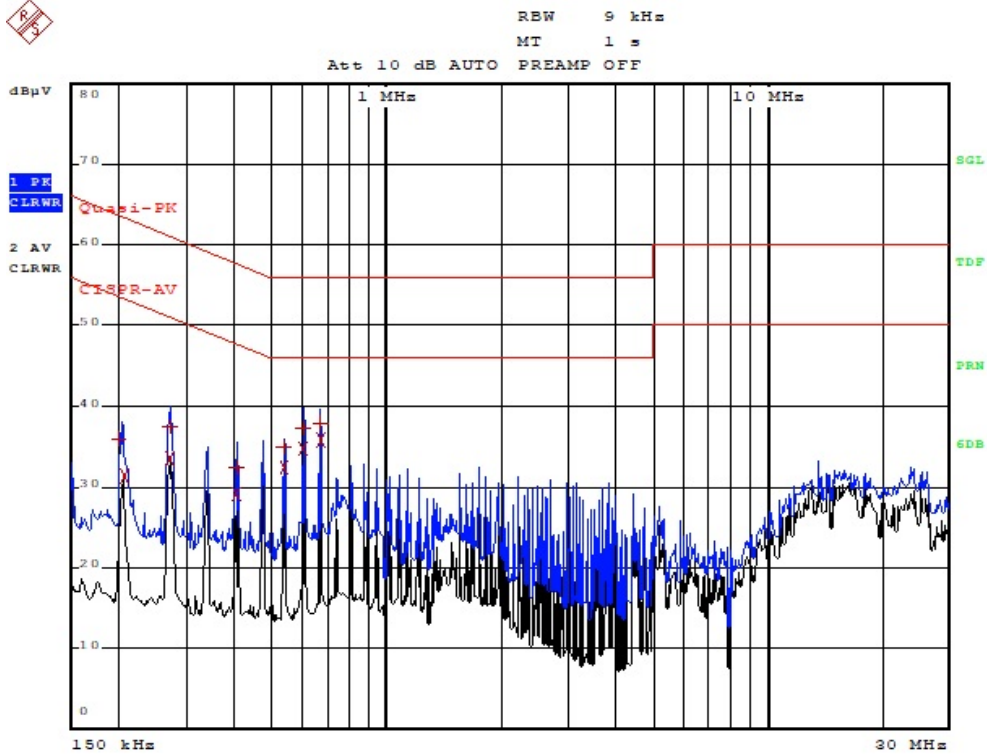

Comment: FL-DE\_BLE\_HOT

## \* NEUTRAL LINE

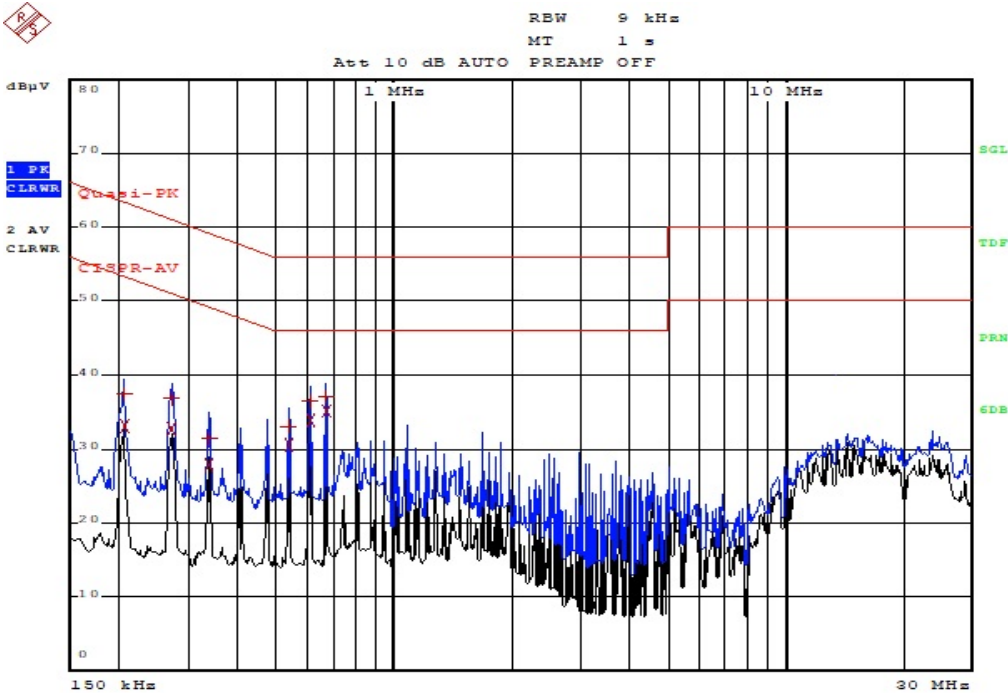

Comment: FL-DE\_BLE\_NEUTRAL

## Appendix 2. Antenna Requirement

### 1. Antenna Requirement

#### 1.1 Standard Applicable

For intentional device, according to FCC 47 CFR Section 15.203, an intentional radiator shall be designed to ensure that no antenna other than that furnished by the responsible party shall be used with the device.

And according to FCC 47 CFR Section 15.204

#### 1.2 Antenna Connected Construction

The antenna types used in this product are PIFA PCB antenna . The maximum Gain of this antenna is 0.9 dBi.