



中国认可
国际互认
检测
TESTING
CNAS L5313



SAR Test Report

Product Name : AC450 Wireless Nano USB Adapter

Model No. : Archer T1U

FCC ID : TE7T1UV1

Applicant : TP-Link Technologies Co., Ltd.

Address : Building 24 (floors 1,3,4,5) and 28 (floors1-4)
Central Science and Technology Park,Shennan Rd,
Nanshan, Shenzhen, China

Date of Receipt : Mar. 14th, 2017

Test Date : Mar. 14th, 2017~ Jun. 30st, 2017

Issued Date : Aug. 04th, 2017

Report No. : 1732062R-HP-US-P03V01

Report Version : V1.1

The test results relate only to the samples tested.

The test results shown in the test report are traceable to the national/international standard through the calibration of the equipment and evaluated measurement uncertainty herein.

This report must not be used to claim product endorsement by CNAS, TAF or any agency of the government.

The test report shall not be reproduced without the written approval of DEKRA Testing and Certification (Suzhou) Co., Ltd.

Test Report Certification

Issued Date: Aug. 04th, 2017

Report No: 1732062R-HP-US-P03V01

Product Name : AC450 Wireless Nano USB Adapter
Applicant : TP-Link Technologies Co., Ltd.
Address : Building 24 (floors 1,3,4,5) and 28 (floors1-4) Central Science and Technology Park,Shennan Rd, Nanshan, Shenzhen,China
Manufacturer : TP-Link Technologies Co., Ltd.
Address : Building 24 (floors 1,3,4,5) and 28 (floors1-4) Central Science and Technology Park,Shennan Rd, Nanshan, Shenzhen,China
FCC ID : TE7T1UV1
Model No. : Archer T1U
Brand Name : tp-link
EUT Voltage : DC 5V
Applicable Standard : FCC KDB Publication 248227 D01v02r02
FCC KDB Publication 447498 D01v06
FCC KDB Publication 447498 D02v02r01
FCC KDB Publication 865664 D01v01r04
IEEE Std. 1528-2013
FCC 47CFR §2.1093
ANSI C95.1-2005
Test Result : Max. SAR Measurement (1g)
802.11a: **1.14** W/kg
Performed Location : DEKRA Testing and Certification (Suzhou) Co., Ltd.
No.99 Hongye Rd., Suzhou Industrial Park, Suzhou,215006,
Jiangsu, China
TEL: +86-512-6251-5088 / FAX: +86-512-6251-5098
FCC Registration Number: 800392;

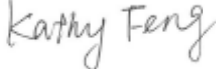
Documented By : 

(Adm. Specialist: Kathy Feng)

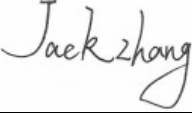
Reviewed By : 

(Senior Engineer: Jack Zhang)

Approved By : 

(Engineering Manager: Harry Zhao)

TABLE OF CONTENTS

Description	Page
1. General Information.....	6
1.1. EUT Description.....	6
1.2. Test Environment	11
1.3. Power Reduction for SAR.....	12
1.4. Guidance Documents	12
2. SAR Measurement System	13
2.1. DASY5 System Description	13
2.1.1. Applications.....	14
2.1.2. Area Scans	14
2.1.3. Zoom Scan (Cube Scan Averaging)	14
2.1.4. Uncertainty of Inter-/Extrapolation and Averaging	14
2.2. DASY5 E-Field Probe	15
2.2.1. Isotropic E-Field Probe Specification	15
2.3. Boundary Detection Unit and Probe Mounting Device.....	16
2.4. DATA Acquisition Electronics (DAE) and Measurement Server	16
2.5. Robot	17
2.6. Light Beam Unit	17
2.7. Device Holder	18
2.8. SAM Twin Phantom	18
3. Tissue Simulating Liquid	19
3.1. The composition of the tissue simulating liquid.....	19
3.2. Tissue Calibration Result	20
3.3. Tissue Dielectric Parameters for Head and Body Phantoms	21
4. SAR Measurement Procedure	22
4.1. SAR System Validation	22
4.1.1. Validation Dipoles.....	22
4.1.2. Validation Result	22
4.2. SAR Measurement Procedure	23
4.3. SAR Measurement Conditions for 802.11 Device.....	24
4.3.1. Duty Factor Control.....	24
4.3.2. Initial Test Position SAR Test Reduction Procedure.....	24
5. SAR Exposure Limits	25

6. Test Equipment List.....	26
7. Measurement Uncertainty.....	27
8. Conducted Power Measurement	29
9. Test Procedures	31
9.1. SAR Test Results Summary.....	31
9.2. Test position and configuration	36
Appendix A. SAR System Validation Data.....	37
Appendix B. SAR measurement Data.....	40
Appendix C. Probe Calibration Data.....	40
Appendix D. Dipole Calibration Data	82
Appendix E. DAE Calibration Data.....	95

History of This Test Report

REPORT NO.	VERSION	DESCRIPTION	ISSUED DATE
1732062R-HP-US-P03V01	V1.0	Initial Issued Report	Jul. 24th, 2017
1732062R-HP-US-P03V01	V1.1	Modified the data for 802.11a 5580MHz Body-Horizontal Down at P62&63.	Aug. 04th, 2017

1. General Information

1.1. EUT Description

Product Name	AC450 Wireless Nano USB Adapter
Brand Name	tp-link
Model No.	Archer T1U
EUT Voltage	DC 5V
Frequency Range	For 5GHz Band 802.11a/n/ac(20MHz): 5180~5320MHz, 5500~5580MHz, 5660~5700MHz, 5745~5825MHz 802.11n/ac(40MHz): 5190~5310MHz, 5510~5550MHz, 5670MHz, 5755~5795MHz 802.11ac(80MHz):5210MHz,5290MHz,5530MHz,5775MHz
Channel Number	For 5GHz Band 802.11a/n/ac(20MHz): 21 802.11n/ac(40MHz): 9 802.11ac(80MHz): 4
Type of Modulation	802.11a/n/ac: OFDM
Data Rate	802.11a: 6/9/12/18/24/36/48/54 Mbps 802.11n: up to 150 Mbps 802.11ac: up to 433.3 Mbps
Channel Control	Auto
Antenna Delivery	1*Tx + 1*Rx
Antenna Type	Reference to Antenna List
Peak Antenna Gain	Reference to Antenna List

For 5.0GHz Band

802.11a/n(20MHz)/ac(20MHz) Working Frequency of Each Channel:							
Channel	Frequency	Channel	Frequency	Channel	Frequency	Channel	Frequency
36	5180 MHz	40	5200 MHz	44	5220 MHz	48	5240 MHz
52	5260MHz	56	5280 MHz	60	5300 MHz	64	5320 MHz
100	5500MHz	104	5520 MHz	108	5540 MHz	112	5550 MHz
116	5580MHz	132	5660 MHz	136	5680 MHz	140	5700 MHz
149	5745 MHz	153	5765 MHz	157	5785 MHz	161	5805 MHz
165	5825MHz	N/A	N/A	N/A	N/A	N/A	N/A
802.11n(40MHz)/ac(40MHz) Working Frequency of Each Channel:							
Channel	Frequency	Channel	Frequency	Channel	Frequency	Channel	Frequency
38	5190 MHz	46	5230 MHz	54	5270 MHz	62	5310 MHz
102	5510 MHz	110	5550 MHz	134	5670 MHz	151	5755 MHz
159	5795 MHz	N/A	N/A	N/A	N/A	N/A	N/A
802.11ac(80MHz) Working Frequency of Each Channel:							
Channel	Frequency	Channel	Frequency	Channel	Frequency	Channel	Frequency
42	5210 MHz	58	5290 MHz	106	5530MHz	155	5775 MHz

1.2. Antenna information

Antenna Model No.	N/A		
Antenna manufacturer	N/A		
Antenna Delivery	<input checked="" type="checkbox"/> 1*TX+1*RX	<input type="checkbox"/> 2*TX+2*RX	<input type="checkbox"/> 3*TX+3*RX
Antenna technology	<input checked="" type="checkbox"/> SISO		
	<input type="checkbox"/> MIMO	<input type="checkbox"/> Basic	
		<input type="checkbox"/> Sectorized antenna systems	
		<input type="checkbox"/> Cross-polarized antennas	
		<input type="checkbox"/> Unequal antenna gains, with equal transmit powers	
		<input type="checkbox"/> Spatial Multiplexing	
		<input type="checkbox"/> CDD	
		<input type="checkbox"/> Beam-forming	
Antenna Type	<input type="checkbox"/> External	<input type="checkbox"/> Dipole	
	<input checked="" type="checkbox"/> Internal	<input checked="" type="checkbox"/> PIFA	
		<input type="checkbox"/> PCB	
		<input type="checkbox"/> Ceramic Chip Antenna	
		<input type="checkbox"/> Metal plate type F antenna	
		<input type="checkbox"/> Cross-polarize Antenna	
Antenna Gain	2dBi		

Power Parameter Value of the test software

Test Mode	Test Channel	Power Setting
802.11a	5180	1D
	5200	1D
	5220	1D
	5240	1D
	5260	21
	5300	21
	5320	21
	5500	26
	5580	26
	5700	26
	5745	3F
	5785	3F
	5825	3F
802.11n(20MHz)	5180	21
	5200	21
	5220	21
	5240	21
	5260	24
	5300	24
	5320	24
	5500	2C
	5580	2C
	5700	2C
	5745	3F
	5785	3F
	5825	3F

802.11ac(20MHz)	5180	21
	5200	21
	5220	21
	5240	21
	5260	24
	5300	24
	5320	24
	5500	2E
	5580	2E
	5700	2E
	5745	3F
	5785	3F
	5825	3F
	802.11n(40MHz)	5190
5230		22
5270		24
5310		24
5510		25
5550		34
5670		34
5755		3F
5795		3F
802.11ac(40MHz)	5190	20
	5230	23
	5270	24
	5310	24
	5510	25
	5550	34
	5670	34
	5755	3F
	5795	3F
802.11ac(80MHz)	5210	20
	5290	25
	5530	21
	5775	3F

The test mode of the test software can support.

Test Mode	Ant 0
802.11a	√
802.11n(20MHz)	√
802.11n(40MHz)	√
802.11ac(20MHz)	√
802.11ac(40MHz)	√
802.11ac(80MHz)	√

1.3. Test Environment

Ambient conditions in the laboratory:

Items	Required	Actual
Temperature (°C)	18-25	21.5± 2
Humidity (%RH)	30-70	52

1.4. Power Reduction for SAR

There is no power reduction used for any band/mode implemented in this device for SAR purposes.

1.5. Guidance Documents

- 1) FCC KDB Publication 447498 D01v06 (General SAR Guidance)
- 2) FCC KDB Publication 447498 D02v02r01 (SAR Measurement Procedures for USB Dongle Transmitters)
- 3) FCC KDB Publication 865664 D01v01r04(SAR measurement 100 MHz to 6 GHz)
- 4) FCC KDB Publication 248227 D01v02r02 (SAR Considerations for 802.11 Devices)
- 5) IEEE Std. 1528-2013 (IEEE Recommended Practice for Determining the Peak Spatial-Average Specific Absorption Rate (SAR) in the Human Head from Wireless Communications Devices: Measurement Techniques)
- 6) FCC 47CFR §2.1093 Radiofrequency radiation exposure evaluation: portable devices
- 7) ANSI C95.1-2005 - IEEE Standard for Safety Levels with Respect to Human Exposure to Radio Frequency Electromagnetic Fields, 3 kHz to 300 GHz

2. SAR Measurement System

2.1. DASY5 System Description

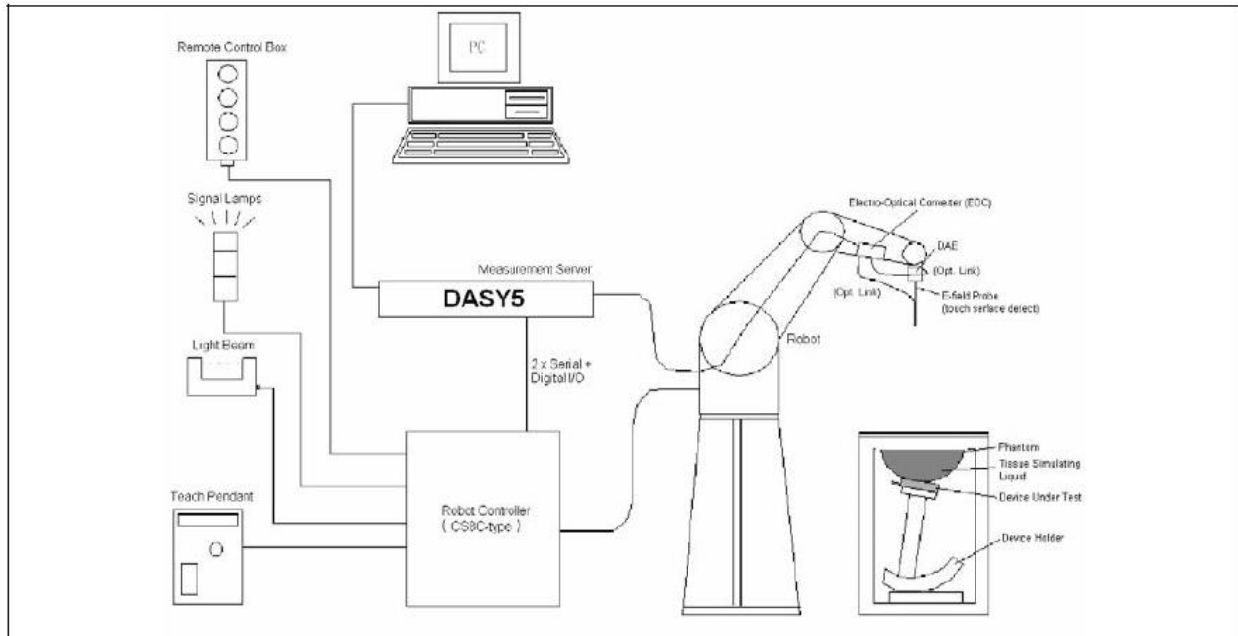

The DASY5 system for performing compliance tests consists of the following items:

- A standard high precision 6-axis robot with controller, teach pendant and software. An arm extension for accommodating the data acquisition electronics (DAE).
- A data acquisition electronics (DAE) which performs the signal amplification, signal multiplexing, AD-conversion, offset measurements, mechanical surface detection, collision detection, etc. The unit is battery powered with standard or rechargeable batteries. The signal is optically transmitted to the EOC.
- The Electro-optical converter (EOC) performs the conversion from optical to electrical signals for the digital communication to the DAE. To use optical surface detection, a special version of the EOC is required. The EOC signal is transmitted to the measurement server.
- The Light Beam used is for probe alignment. This improves the (absolute) accuracy of the probe positioning.
- A computer running WinXP and the DASY5 software.
- Remote control and teach pendant as well as additional circuitry for robot safety such as warning lamps, etc.
- The phantom, the device holder and other accessories according to the targeted measurement.

2.1.1. Applications

Predefined procedures and evaluations for automated compliance testing with all worldwide standards, e.g., IEEE 1528, OET 65, IEC 62209-1, IEC 62209-2, EN 50360, EN 50383 and others.

2.1.2. Area Scans

Area scans are defined prior to the measurement process being executed with a user defined variable spacing between each measurement point (integral) allowing low uncertainty measurements to be conducted. Scans defined for FCC applications utilize a 10mm² step integral, with 1mm interpolation used to locate the peak SAR area used for zoom scan assessments.

When an Area Scan has measured all reachable points, it computes the field maxima found in the scanned area, within a range of the global maximum. The range (in dB) is specified in the standards for compliance testing. For example, a 2 dB range is required in IEEE 1528-2003, EN 50361 and IEC 62209 standards, whereby 3 dB is a requirement when compliance is assessed in accordance with the ARIB standard (Japan).

2.1.3. Zoom Scan (Cube Scan Averaging)

Zoom Scans are used to assess the peak spatial SAR values within a cubic averaging volume containing 1 g and 10 g of simulated tissue. A density of 1000 kg/m³ is used to represent the head and body tissue density and not the phantom liquid density, in order to be consistent with the definition of the liquid dielectric properties, i.e. the side length of the 1 g cube is 10mm, with the side length of the 10 g cube 21,5mm.

The zoom scan integer steps can be user defined so as to reduce uncertainty, but normal practice for typical test applications utilize a physical step of 7x7x7 (5mmx5mmx5mm) providing a volume of 30mm in the X & Y axis, and 30mm in the Z axis.

2.1.4. Uncertainty of Inter-/Extrapolation and Averaging

In order to evaluate the uncertainty of the interpolation, extrapolation and averaged SAR calculation algorithms of the Postprocessor, DASY5 allows the generation of measurement grids which are artificially predefined by analytically based test functions. Therefore, the grids of area scans and zoom scans can be filled with uncertainty test data, according to the SAR benchmark functions of IEEE 1528. The three analytical functions shown in equations as below are used to describe the possible range of the expected SAR distributions for the tested handsets. The field gradients are covered by the spatially flat distribution f1, the spatially steep distribution f3 and f2 accounts for H-field cancellation on the phantom/tissue surface.

$$f_1(x, y, z) = Ae^{-\frac{z}{2a}} \cos^2 \left(\frac{\pi \sqrt{x'^2 + y'^2}}{2 \cdot 5a} \right)$$

$$f_2(x, y, z) = Ae^{-\frac{z}{a}} \frac{a^2}{a^2 + x'^2} \left(3 - e^{-\frac{2z}{a}} \right) \cos^2 \left(\frac{\pi y'}{2 \cdot 3a} \right)$$

$$f_3(x, y, z) = A \frac{a^2}{\frac{a^2}{4} + x'^2 + y'^2} \left(e^{-\frac{2z}{a}} + \frac{a^2}{2(a + 2z)^2} \right)$$

2.2. DASY5 E-Field Probe

The SAR measurement is conducted with the dosimetric probe manufactured by SPEAG. The probe is specially designed and calibrated for use in liquid with high permittivity. The dosimetric probe has special calibration in liquid at different frequency.

SPEAG conducts the probe calibration in compliance with international and national standards (e.g. IEEE 1528, EN 62209-1, IEC 62209, etc.) under ISO 17025. The calibration data are in Appendix D.

2.2.1. Isotropic E-Field Probe Specification

Model	EX3DV4	
Construction	Symmetrical design with triangular core Built-in shielding against static charges PEEK enclosure material (resistant to organic solvents, e.g., DGBE)	
Frequency	10 MHz to 6 GHz Linearity: ± 0.2 dB (30 MHz to 6 GHz)	
Directivity	± 0.3 dB in HSL (rotation around probe axis) ± 0.5 dB in tissue material (rotation normal to probe axis)	
Dynamic Range	10 µW/g to 100 mW/g Linearity: ± 0.2 dB (noise: typically < 1 µW/g)	
Dimensions	Overall length: 330 mm (Tip: 20 mm) Tip diameter: 2.5 mm (Body: 12 mm) Typical distance from probe tip to dipole centers: 1 mm	
Application	High precision dosimetric measurements in any exposure scenario (e.g., very strong gradient fields). Only probe which enables compliance testing for frequencies up to 6 GHz with precision of better 30%.	

2.3. Boundary Detection Unit and Probe Mounting Device

The DASY probes use a precise connector and an additional holder for the probe, consisting of a plastic tube and a flexible silicon ring to center the probe. The connector at the DAE is flexibly mounted and held in the default position with magnets and springs. Two switching systems in the connector mount detect frontal and lateral probe collisions and trigger the necessary software response.



2.4. DATA Acquisition Electronics (DAE) and Measurement Server

The data acquisition electronics (DAE) consists of a highly sensitive electrometer-grade preamplifier with auto-zeroing, a channel and gain-switching multiplexer, a fast 16 bit AD-converter and a command decoder and control logic unit.

Transmission to the measurement server is accomplished through an optical downlink for data and status information as well as an optical uplink for commands and the clock.

The input impedance of the DAE4 is 200M Ohm; the inputs are symmetrical and floating. Common mode rejection is above 80dB.

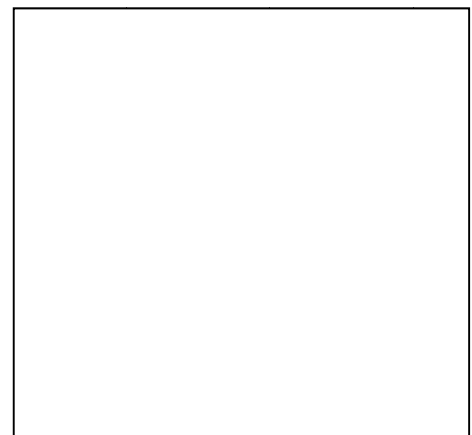

The DASY5 measurement server is based on a PC/104 CPU board with a 400MHz intel ULV Celeron, 128MB chipdisk and 128MB RAM. The necessary circuits for communication with the DAE electronics box, as well as the 16 bit AD converter system for optical detection and digital I/O interface are contained on the DASY5 I/O board, which is directly connected to the PC/104 bus of the CPU board.



2.5. Robot

The DASY5 system uses the high precision robots TX90 XL type out of the newer series from Stäubli SA (France). For the 6-axis controller DASY5 system, the CS8C robot controller version from Stäubli is used.

The XL robot series have many features that are important for our application:

- High precision (repeatability 0.02 mm)
- High reliability (industrial design)
- Jerk-free straight movements
- Low ELF interference (the closed metallic construction shields against motor control fields)
- 6-axis controller

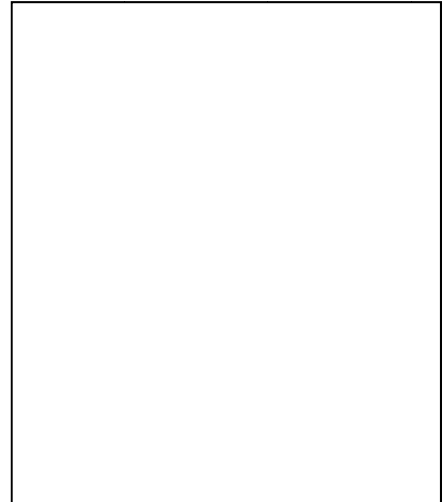

2.6. Light Beam Unit

The light beam switch allows automatic "tooling" of the probe. During the process, the actual position of the probe tip with respect to the robot arm is measured, as well as the probe length and the horizontal probe offset. The software then corrects all movements, such that the robot coordinates are valid for the probe tip.

The repeatability of this process is better than 0.1 mm. If a position has been taught with an aligned probe, the same position will be reached with another aligned probe within 0.1 mm, even if the other probe has different dimensions. During probe rotations, the probe tip will keep its actual position.



2.7. Device Holder

The DASY5 device holder is designed to cope with different positions given in the standard. It has two scales for the device rotation (with respect to the body axis) and the device inclination (with respect to the line between the ear reference points). The rotation center for both scales is the ear reference point (EPR).

Thus the device needs no repositioning when changing the angles.

The DASY5 device holder has been made out of low-loss POM material having the following dielectric parameters: relative permittivity $\epsilon_r = 3$ and loss tangent $\delta = 0.02$. The amount of dielectric material has been reduced in the closest vicinity of the device, since measurements have suggested that the influence of the clamp on the test results could thus be lowered.



2.8. SAM Twin Phantom

The SAM twin phantom is a fiberglass shell phantom with 2mm shell thickness (except the ear region where shell thickness increases to 6mm). It has three measurement areas:

- Left head
- Right head
- Flat phantom



The bottom plate contains three pair of bolts for locking the device holder. The device holder positions are adjusted to the standard measurement positions in the three sections. A white cover is provided to tap the phantom during off-periods to prevent water evaporation and changes in the liquid parameters. On the phantom tip, three reference markers are provided to identify the phantom position with respect to the robot.

3. Tissue Simulating Liquid

3.1. The composition of the tissue simulating liquid

INGREDIENT (% Weight)	5250MHz Body	5600MHz Body	5750MHz Body
Water	75.68	75.68	75.68
Salt	0.43	0.43	0.43
Sugar	0.00	0.00	0.00
HEC	0.00	0.00	0.00
Preventol	0.00	0.00	0.00
DGBE	4.42	4.42	4.42
Triton X-100	19.47	19.47	19.47

3.2. Tissue Calibration Result

The dielectric parameters of the liquids were verified prior to the SAR evaluation using DASY5 Dielectric Probe Kit and Agilent Vector Network Analyzer E5071C

Body Tissue Simulant Measurement				
Frequency [MHz]	Description	Dielectric Parameters		Tissue Temp. [°C]
		ϵ_r	σ [s/m]	
5250MHz	Reference result ± 5% window	49.0 46.55 to 51.45	5.36 5.09 to 5.63	N/A
	06-21-2017	49.2	5.41	21.0
5600MHz	Reference result ± 5% window	48.5 46.10 to 50.90	5.77 5.48 to 6.06	N/A
	06-21-2017	48.15	5.87	21.0
5750MHz	Reference result ± 5% window	48.3 45.86 to 50.69	5.94 5.65 to 6.24	N/A
	06-21-2017	47.84	6.09	21.0

3.3. Tissue Dielectric Parameters for Head and Body Phantoms

The head tissue dielectric parameters recommended by the IEEE SCC-34/SC-2 in P1528 have been incorporated in the following table. These head parameters are derived from planar layer models simulating the highest expected SAR for the dielectric properties and tissue thickness variations in a human head. Other head and body tissue parameters that have not been specified in P1528 are derived from the tissue dielectric parameters computed from the 4-Cole-Cole equations described in Reference [12] and extrapolated according to the head parameters specified in P1528.

Target Frequency (MHz)	Head		Body	
	ϵ_r	σ (S/m)	ϵ_r	σ (S/m)
150	52.3	0.76	61.9	0.80
300	45.3	0.87	58.2	0.92
450	43.5	0.87	56.7	0.94
835	41.5	0.90	55.2	0.97
900	41.5	0.97	55.0	1.05
915	41.5	0.98	55.0	1.06
1450	40.5	1.20	54.0	1.30
1610	40.3	1.29	53.8	1.40
1800 – 2000	40.0	1.40	53.3	1.52
2450	39.2	1.80	52.7	1.95
3000	38.5	2.40	52.0	2.73
5800	35.3	5.27	48.2	6.00

(ϵ_r = relative permittivity, σ = conductivity and $\rho = 1000 \text{ kg/m}^3$)

4. SAR Measurement Procedure

4.1. SAR System Validation

4.1.1. Validation Dipoles

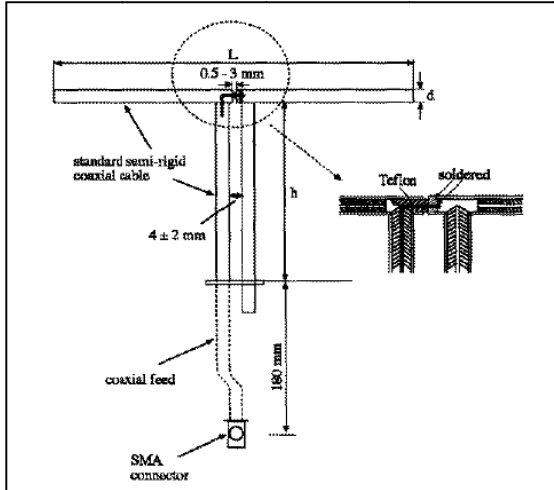

The dipoles used is based on the IEEE-1528 standard, and is complied with mechanical and electrical specifications in line with the requirements of both IEEE and FCC Supplement C. the table below provides details for the mechanical and electrical specifications for the dipoles.

Frequency	L (mm)	h (mm)	d (mm)
5250MHz	20.6	14.2	3.6
5600MHz	20.6	14.2	3.6
5750MHz	20.6	14.2	3.6

4.1.2. Validation Result

System Performance Check at 5250MHz, 5600 MHz and 5750MHz for Body				
Validation Dipole: D5GHzV2, SN: 1203				
5250 MHz	Reference result ± 10% window	73.7 66.33 to 81.07	20.8 18.72 to 22.88	N/A
	06-21-2017	78.5	21.9	21.0
Validation Dipole: D5GHzV2, SN: 1203				
5600 MHz	Reference result ± 10% window	78.8 70.92 to 86.68	22.3 20.07 to 24.53	N/A
	06-21-2017	84.1	23.8	21.0
Validation Dipole: D5GHzV2, SN: 1203				
5750 MHz	Reference result ± 10% window	75.2 67.68 to 82.72	21.1 18.99 to 23.21	N/A
	06-21-2017	79.2	21.1	21.0
Note: All SAR values are normalized to 1W forward power.				

4.2. SAR Measurement Procedure

The DASY 5 calculates SAR using the following equation,

$$SAR = \frac{\sigma |E|^2}{\rho}$$

σ : represents the simulated tissue conductivity

ρ : represents the tissue density

The EUT is set to transmit at the required power in line with product specification, at each frequency relating to the LOW, MID, and HIGH channel settings.

Pre-scans are made on the device to establish the location for the transmitting antenna, using a large area scan in either air or tissue simulation fluid.

The EUT is placed against the Universal Phantom where the maximum area scan dimensions are larger than the physical size of the resonating antenna. When the scan size is not large enough to cover the peak SAR distribution, it is modified by either extending the area scan size in both the X and Y directions, or the device is shifted within the predefined area.

The area scan is then run to establish the peak SAR location (interpolated resolution set at 1mm^2) which is then used to orient the center of the zoom scan. The zoom scan is then executed and the 1g and 10g averages are derived from the zoom scan volume (interpolated resolution set at 1mm^3).

4.3. SAR Measurement Conditions for 802.11 Device

4.3.1. Duty Factor Control

Unless it is permitted by specific KDB procedures or continuous transmission is specifically restricted by the device, the reported SAR must be scaled to 100% transmission duty factor to determine compliance at the maximum tune-up tolerance limit.

4.3.2. Initial Test Position SAR Test Reduction Procedure

DSSS and OFDM configurations are considered separately according to the required SAR procedures. SAR is measured in the initial test position using the 802.11 transmission mode configuration required by the DSSS procedure or initial test configuration and subsequent test configuration(s) according to the OFDM procedures.¹⁶ The initial test position procedure is described in the following:

When the reported SAR of the initial test position is ≤ 0.4 W/kg, further SAR measurement is not required for the other (remaining) test positions in that exposure configuration and 802.11 transmission mode combinations within the frequency band or aggregated band. SAR is also not required for that exposure configuration in the subsequent test configuration(s).

a) When the reported SAR of the initial test position is > 0.4 W/kg, SAR is repeated for the 802.11 transmission mode configuration tested in the initial test position using subsequent highest extrapolated or estimated 1-g SAR conditions determined by area scans or next closest/smallest test separation distance and maximum RF coupling test positions based on manufacturer justification, on the highest maximum output power channel, until the reported SAR is ≤ 0.8 W/kg or all required test positions (left, right, touch, tilt or subsequent surfaces and edges) are tested.

b) For all positions/configurations tested using the initial test position and subsequent test positions, when the reported SAR is > 0.8 W/kg, SAR is measured for these test positions/configurations on the subsequent next highest measured output power channel(s) until the reported SAR is ≤ 1.2 W/kg or all required channels are tested.

Additional power measurements may be required for this step, which should be limited to those necessary for identifying the subsequent highest output power channels.

5. SAR Exposure Limits

SAR assessments have been made in line with the requirements of IEEE-1528, FCC Supplement C, and comply with ANSI/IEEE C95.1-1992 “Uncontrolled Environments” limits. These limits apply to a location which is deemed as “Uncontrolled Environment” which can be described as a situation where the general public may be exposed to an RF source with no prior knowledge or control over their exposure.

Limits for General Population/Uncontrolled Exposure (W/kg)

Type Exposure	Uncontrolled Environment Limit
Spatial Peak SAR (1g cube tissue for brain or body)	1.60 W/kg
Spatial Average SAR (whole body)	0.08 W/kg
Spatial Peak SAR (10g for hands, feet, ankles and wrist)	4.00 W/kg

6. Test Equipment List

Instrument	Manufacturer	Model No.	Serial No.	Cali. Due Date
Stäubli Robot TX60L	Stäubli	TX60L	F10/5C90A1/A/01	N/A
Controller	Stäubli	SP1	S-0034	N/A
Dipole Validation Kits	Speag	D5GHzV2	1078	2018.02.09
SAM Twin Phantom	Speag	SAM	TP-1561/1562	N/A
Device Holder	Speag	SD 000 H01 HA	N/A	N/A
Data Acquisition Electronic	Speag	DAE4	1220	2018.02.20
E-Field Probe	Speag	EX3DV4	3710	2018.02.22
SAR Software	Speag	DASY5	V5.2 Build 162	N/A
Power Amplifier	Mini-Circuit	ZVA-183-S+	N657400950	N/A
Directional Coupler	Agilent	778D	20160	N/A
Universal Radio Communication Tester	R&S	CMU 200	117088	2018.03.10
Vector Network	Agilent	E5071C	MY48367267	2018.03.10
Signal Generator	Agilent	E4438C	MY49070163	2018.03.10
Power Meter	Anritsu	ML2495A	0905006	2017.10.29
Wide Bandwidth Sensor	Anritsu	MA2411B	0846014	2017.10.29

7. Measurement Uncertainty

DASY5 Uncertainty according to IEEE std. 1528-2013 Measurement uncertainty for 300 MHz to 3 GHz averaged over 1 gram / 10 gram.								
Error Description	Uncert. value	Prob. Dist.	Div.	(ci) 1g	(ci) 10g	Std. Unc. (1g)	Std. Unc. (10g)	(vi) V_{eff}
Measurement System								
Probe Calibration	±6.0%	N	1	1	1	±6.0%	±6.0%	∞
Axial Isotropy	±4.7%	R		0.7	0.7	±1.9%	±1.9%	∞
Hemispherical Isotropy	±9.6%	R		0.7	0.7	±3.9%	±3.9%	∞
Boundary Effects	±1.0%	R		1	1	±0.6%	±0.6%	∞
Linearity	±4.7%	R		1	1	±2.7%	±2.7%	∞
System Detection Limits	±1.0%	R		1	1	±0.6%	±0.6%	∞
Readout Electronics	±0.3%	N	1	1	1	±0.3%	±0.3%	∞
Response Time	±0.8%	R		1	1	±0.5%	±0.5%	∞
Integration Time	±2.6%	R		1	1	±1.5%	±1.5%	∞
RF Ambient Noise	±3.0%	R		1	1	±1.7%	±1.7%	∞
RF Ambient Reflections	±3.0%	R		1	1	±1.7%	±1.7%	∞
Probe Positioner	±0.4%	R		1	1	±0.2%	±0.2%	∞
Probe Positioning	±2.9%	R		1	1	±1.7%	±1.7%	∞
Max. SAR Eval.	±1.0%	R		1	1	±0.6%	±0.6%	∞
Test Sample Related								
Device Positioning	±2.9%	N	1	1	1	±2.9%	±2.9%	145
Device Holder	±3.6%	N	1	1	1	±3.6%	±3.6%	5
Power Drift	±5.0%	R		1	1	±2.9%	±2.9%	∞
Phantom and Setup								
Phantom Uncertainty	±4.0%	R		1	1	±2.3%	±2.3%	∞
Liquid Conductivity (target)	±5.0%	R		0.64	0.43	±1.8%	±1.2%	∞
Liquid Conductivity (meas.)	±2.5%	N	1	0.64	0.43	±1.6%	±1.1%	∞
Liquid Permittivity (target)	±5.0%	R		0.6	0.49	±1.7%	±1.4%	∞
Liquid Permittivity (meas.)	±2.5%	N	1	0.6	0.49	±1.5%	±1.2%	∞
Combined Std. Uncertainty						±11.0%	±10.8%	387
Expanded STD Uncertainty						±22.0%	±21.5%	

DASY5 Uncertainty according to IEEE std. 1528-2013								
Measurement uncertainty for 3 GHz to 6 GHz averaged over 1 gram / 10 gram.								
Error Description	Uncert. value	Prob. Dist.	Div.	(ci) 1g	(ci) 10g	Std. Unc. (1g)	Std. Unc. (10g)	(vi) V _{eff}
Measurement System								
Probe Calibration	±6.55%	N	1	1	1	±6.55%	±6.55%	∞
Axial Isotropy	±4.7%	R		0.7	0.7	±1.9%	±1.9%	∞
Hemispherical Isotropy	±9.6%	R		0.7	0.7	±3.9%	±3.9%	∞
Boundary Effects	±2.0%	R		1	1	±1.2%	±1.2%	∞
Linearity	±4.7%	R		1	1	±2.7%	±2.7%	∞
System Detection Limits	±1.0%	R		1	1	±0.6%	±0.6%	∞
Readout Electronics	±0.3%	N	1	1	1	±0.3%	±0.3%	∞
Response Time	±0.8%	R		1	1	±0.5%	±0.5%	∞
Integration Time	±2.6%	R		1	1	±1.5%	±1.5%	∞
RF Ambient Noise	±3.0%	R		1	1	±1.7%	±1.7%	∞
RF Ambient Reflections	±3.0%	R		1	1	±1.7%	±1.7%	∞
Probe Positioner	±0.8%	R		1	1	±0.5%	±0.5%	∞
Probe Positioning	±9.9%	R		1	1	±5.7%	±5.7%	∞
Max. SAR Eval.	±4.0%	R		1	1	±2.3%	±2.3%	∞
Test Sample Related								
Device Positioning	±2.9%	N	1	1	1	±2.9%	±2.9%	145
Device Holder	±3.6%	N	1	1	1	±3.6%	±3.6%	5
Power Drift	±5.0%	R		1	1	±2.9%	±2.9%	∞
Phantom and Setup								
Phantom Uncertainty	±4.0%	R		1	1	±2.3%	±2.3%	∞
Liquid Conductivity (target)	±5.0%	R		0.64	0.43	±1.8%	±1.2%	∞
Liquid Conductivity (meas.)	±2.5%	N	1	0.64	0.43	±1.6%	±1.1%	∞
Liquid Permittivity (target)	±5.0%	R		0.6	0.49	±1.7%	±1.4%	∞
Liquid Permittivity (meas.)	±2.5%	N	1	0.6	0.49	±1.5%	±1.2%	∞
Combined Std. Uncertainty						±12.8%	±12.6%	330
Expanded STD Uncertainty						±25.6%	±25.2%	

8. Conducted Power Measurement

Test Mode	Frequency (MHz)	Avg. Burst Power (dBm)	Max. Power (dBm)	Scaling Factor
802.11a	5180	15.71	16.0	1.069
	5200	15.90	16.0	1.023
	5220	15.82	16.0	1.042
	5240	15.86	16.0	1.033
	5260	17.66	18.0	1.081
	5300	17.51	18.0	1.119
	5320	17.62	18.0	1.091
	5500	20.23	20.5	1.064
	5580	20.18	20.5	1.076
	5700	20.21	20.5	1.069
	5745	21.35	21.7	1.084
	5785	21.64	21.7	1.014
	5825	21.48	21.7	1.052
802.11n(20MHz)	5180	15.63	16.0	1.089
	5200	15.72	16.0	1.067
	5220	15.71	16.0	1.069
	5240	15.68	16.0	1.076
	5260	16.79	17.0	1.050
	5300	16.83	17.0	1.040
	5320	16.75	17.0	1.059
	5500	20.81	21.0	1.045
	5580	20.65	21.0	1.084
	5700	20.73	21.0	1.064
	5745	21.54	21.6	1.014
	5785	21.28	21.6	1.076
	5825	21.17	21.6	1.104
802.11ac(20MHz)	5180	15.72	16.0	1.067
	5200	15.73	16.0	1.064
	5220	15.68	16.0	1.076
	5240	15.59	16.0	1.099
	5260	16.61	17.0	1.094
	5300	16.56	17.0	1.107
	5320	16.67	17.0	1.079
	5500	21.32	21.5	1.042

	5580	21.04	21.5	1.112
	5700	21.17	21.5	1.079
	5745	21.59	21.6	1.002
	5785	21.47	21.5	1.007
	5825	21.25	21.5	1.059
802.11n(40MHz)	5190	16.13	16.8	1.167
	5230	16.21	16.8	1.146
	5270	16.73	16.8	1.016
	5310	16.36	16.8	1.107
	5510	17.22	17.5	1.067
	5550	21.51	21.6	1.021
	5670	21.32	21.6	1.067
	5755	21.54	21.6	1.014
	5795	21.38	21.6	1.052
802.11ac(40MHz)	5190	15.01	16.8	1.510
	5230	16.62	16.8	1.042
	5270	16.65	16.8	1.035
	5310	16.74	16.8	1.014
	5510	17.34	17.5	1.038
	5550	21.51	21.6	1.021
	5670	21.45	21.6	1.035
	5755	21.52	21.6	1.019
	5795	21.41	21.6	1.045
802.11ac(80MHz)	5210	15.02	15.1	1.019
	5290	17.04	17.1	1.014
	5530	14.73	15.1	1.089
	5775	21.52	21.6	1.019

9. Test Procedures

9.1. SAR Test Results Summary

SAR MEASUREMENT										
Ambient Temperature (°C) : 21.5 ± 2					Relative Humidity (%): 52					
Liquid Temperature (°C) : 21.0 ± 2					Depth of Liquid (cm):>15					
Product: AC450 Wireless Nano USB Adapter										
Frequency: 5180 ~ 5240MHz										
Test Mode:802.11a										
Test Position Body (5mm gap)	Antenna Position	Frequency		Frame Power (dBm)	Power Drift (<±0.2)	SAR 1g (W/kg)	Scaling Factor	Duty factor	Duty Cycle Scaled SAR 1g (W/kg)	Limit (W/kg)
		Channel	MHz							
Horizontal Up	Fixed	40	5200	15.90	0.06	0.789	1.023	1.00	0.807	1.6
Horizontal Down	Fixed	40	5200	15.90	0.10	1.01	1.023	1.00	1.033	1.6
Vertical Front	Fixed	40	5200	15.90	0.07	1.08	1.023	1.00	1.105	1.6
Vertical Front*	Fixed	40	5200	15.90	-0.17	1.05	1.023	1.00	1.074	1.6
Vertical Back	Fixed	40	5200	15.90	0.06	0.655	1.023	1.00	0.670	1.6
Tip	Fixed	40	5200	15.90	-0.11	0.572	1.023	1.00	0.585	1.6
Horizontal Up	Fixed	48	5240	15.86	-0.04	0.827	1.033	1.00	0.854	1.6
Horizontal Down	Fixed	48	5240	15.86	0.09	0.933	1.033	1.00	0.964	1.6
Vertical Front	Fixed	48	5240	15.86	0.01	0.982	1.033	1.00	1.014	1.6
Test Mode:802.11n(40MHz)										
Vertical Front	Fixed	46	5230	16.21	-0.15	0.998	1.146	1.00	1.14	1.6
Horizontal Up	Fixed	46	5230	16.21	0.01	0.955	1.146	1.00	1.09	1.6
Horizontal Down	Fixed	46	5230	16.21	0.18	0.599	1.146	1.00	0.686	1.6
Test Mode:802.11ac(40MHz)										
Vertical Front	Fixed	46	5230	16.62	0.03	1.09	1.042	1.00	1.14	1.6
Horizontal Up	Fixed	46	5230	16.62	0.12	1.07	1.042	1.00	1.11	1.6
Horizontal Down	Fixed	46	5230	16.62	-0.19	0.723	1.042	1.00	0.753	1.6

Note 1: * - repeated at the highest measured SAR according to the FCC KDB 865664

2: When the reported SAR of the initial test position is > 0.4 W/kg, on the highest maximum output power channel, until the reported SAR is ≤ 0.8 W/kg or all required test positions (left, right, touch, tilt or subsequent surfaces and edges) are tested.

3: For all positions/configurations tested using the initial test position and subsequent test positions, when the reported SAR is > 0.8 W/kg, SAR is measured for these test positions/configurations on the subsequent next highest measured output power channel(s) until the reported SAR is ≤ 1.2 W/kg or all required channels are tested.

4: Reported SAR were scaled to the maximum duty factor to demonstrate compliance per FCC KDB 248227 D01 802.11 Wi-Fi SAR v02r02.

5: When the highest reported SAR for the initial test configuration (when applicable, include subsequent highest output channels), according to the initial test position or fixed exposure position requirements, is adjusted by the ratio of the subsequent test configuration to initial test configuration specified maximum output power and the adjusted SAR is ≤ 1.2 W/kg, SAR is not required for that subsequent test configuration. So 802.11n(20MHz)& ac(20MHz)& 802.11ac(80MHz) didn't tested according to above description.

SAR MEASUREMENT										
Ambient Temperature (°C) : 21.5 ± 2					Relative Humidity (%): 52					
Liquid Temperature (°C) : 21.0 ± 2					Depth of Liquid (cm):>15					
Product: AC450 Wireless Nano USB Adapter										
Frequency: 5260 ~ 5320MHz										
Test Mode:802.11a										
Test Position Body (5mm gap)	Antenna Position	Frequency		Frame Power (dBm)	Power Drift (± 0.2)	SAR 1g (W/kg)	Scaling Factor	Duty factor	Duty Cycle Scaled SAR 1g (W/kg)	Limit (W/kg)
		Channel	MHz							
Horizontal Up	Fixed	60	5300	17.51	0.05	0.633	1.119	1.00	0.708	1.6
Horizontal Down	Fixed	60	5300	17.51	0.05	0.863	1.119	1.00	0.966	1.6
Vertical Front	Fixed	60	5300	17.51	-0.12	1.01	1.119	1.00	1.130	1.6
Horizontal Down	Fixed	52	5260	17.66	0.01	0.855	1.081	1.00	0.924	1.6
Vertical Front	Fixed	52	5260	17.66	0.01	1.02	1.081	1.00	1.103	1.6
Vertical Front*	Fixed	52	5260	17.66	-0.08	0.953	1.081	1.00	1.030	1.6

Note 1: * - repeated at the highest measured SAR according to the FCC KDB 865664

2: When the reported SAR of the initial test position is > 0.4 W/kg, on the highest maximum output power channel, until the reported SAR is ≤ 0.8 W/kg or all required test positions (left, right, touch, tilt or subsequent surfaces and edges) are tested.

3: For all positions/configurations tested using the initial test position and subsequent test positions, when the reported SAR is > 0.8 W/kg, SAR is measured for these test positions/configurations on the subsequent next highest measured output power channel(s) until the reported SAR is ≤ 1.2 W/kg or all required channels are tested.

4: Reported SAR were scaled to the maximum duty factor to demonstrate compliance per FCC KDB 248227 D01 802.11 Wi-Fi SAR v02r02.

5: When the highest reported SAR for the initial test configuration (when applicable, include subsequent highest output channels), according to the initial test position or fixed exposure position requirements, is adjusted by the ratio of the subsequent test configuration to initial test configuration specified maximum output power and the adjusted SAR is ≤ 1.2 W/kg, SAR is not required for that subsequent test configuration. So 802.11n(20MHz)&n(40MHz)&ac(20MHz)&ac(40MHz) & 802.11ac(80MHz) didn't tested according to above description.

SAR MEASUREMENT										
Ambient Temperature (°C) : 21.5 ± 2					Relative Humidity (%): 52					
Liquid Temperature (°C) : 21.0 ± 2					Depth of Liquid (cm):>15					
Product: AC450 Wireless Nano USB Adapter										
Frequency: 5500 ~ 5700MHz										
Test Mode:802.11a										
Test Position Body (5mm gap)	Antenna Position	Frequency		Frame Power (dBm)	Power Drift (<±0.2)	SAR 1g (W/kg)	Scaling Factor	Duty factor	Duty Cycle Scaled SAR 1g (W/kg)	Limit (W/kg)
		Channel	MHz							
Horizontal Up	Fixed	116	5580	20.18	-0.13	0.344	1.076	1.00	0.370	1.6
Horizontal Down	Fixed	116	5580	20.18	0.12	0.534	1.076	1.00	0.575	1.6
Vertical Front	Fixed	116	5580	20.18	0.07	0.653	1.076	1.00	0.703	1.6
Horizontal Down	Fixed	100	5500	20.23	0.17	0.439	1.064	1.00	0.467	1.6
Vertical Front	Fixed	100	5500	20.23	0.10	0.588	1.064	1.00	0.626	1.6

Note 1: * - repeated at the highest measured SAR according to the FCC KDB 865664

2: When the reported SAR of the initial test position is > 0.4 W/kg, on the highest maximum output power channel, until the reported SAR is ≤ 0.8 W/kg or all required test positions (left, right, touch, tilt or subsequent surfaces and edges) are tested.

3: For all positions/configurations tested using the initial test position and subsequent test positions, when the reported SAR is > 0.8 W/kg, SAR is measured for these test positions/configurations on the subsequent next highest measured output power channel(s) until the reported SAR is ≤ 1.2 W/kg or all required channels are tested.

4: Reported SAR were scaled to the maximum duty factor to demonstrate compliance per FCC KDB 248227 D01 802.11 Wi-Fi SAR v02r02.

5: When the highest reported SAR for the initial test configuration (when applicable, include subsequent highest output channels), according to the initial test position or fixed exposure position requirements, is adjusted by the ratio of the subsequent test configuration to initial test configuration specified maximum output power and the adjusted SAR is ≤ 1.2 W/kg, SAR is not required for that subsequent test configuration. So 802.11n(20MHz)&n(40MHz)&ac(20MHz)&ac(40MHz) & 802.11ac(80MHz) didn't tested according to above description.

SAR MEASUREMENT										
Ambient Temperature (°C) : 21.5 ± 2					Relative Humidity (%): 52					
Liquid Temperature (°C) : 21.0 ± 2					Depth of Liquid (cm):>15					
Product: AC450 Wireless Nano USB Adapter										
Frequency: 5745 ~ 5825MHz										
Test Mode:802.11a										
Test Position Body (5mm gap)	Antenna Position	Frequency		Frame Power (dBm)	Power Drift (±0.2)	SAR 1g (W/kg)	Scaling Factor	Duty factor	Duty Cycle Scaled SAR 1g (W/kg)	Limit (W/kg)
		Channel	MHz							
Horizontal Up	Fixed	157	5785	21.64	-0.01	0.390	1.014	1.00	0.395	1.6
Horizontal Down	Fixed	157	5785	21.64	-0.10	0.434	1.014	1.00	0.440	1.6
Vertical Front	Fixed	157	5785	21.64	0.07	0.580	1.014	1.00	0.588	1.6
Horizontal Down	Fixed	165	5825	21.48	0.06	0.377	1.052	1.00	0.397	1.6
Vertical Front	Fixed	165	5825	21.48	0.17	0.495	1.052	1.00	0.521	1.6

Note 1: * - repeated at the highest measured SAR according to the FCC KDB 865664

2: When the reported SAR of the initial test position is > 0.4 W/kg, on the highest maximum output power channel, until the reported SAR is ≤ 0.8 W/kg or all required test positions (left, right, touch, tilt or subsequent surfaces and edges) are tested.

3: For all positions/configurations tested using the initial test position and subsequent test positions, when the reported SAR is > 0.8 W/kg, SAR is measured for these test positions/configurations on the subsequent next highest measured output power channel(s) until the reported SAR is ≤ 1.2 W/kg or all required channels are tested.

4: Reported SAR were scaled to the maximum duty factor to demonstrate compliance per FCC KDB 248227 D01 802.11 Wi-Fi SAR v02r02.

5: When the highest reported SAR for the initial test configuration (when applicable, include subsequent highest output channels), according to the initial test position or fixed exposure position requirements, is adjusted by the ratio of the subsequent test configuration to initial test configuration specified maximum output power and the adjusted SAR is ≤ 1.2 W/kg, SAR is not required for that subsequent test configuration. So 802.11n(20MHz)&n(40MHz)&ac(20MHz)&ac(40MHz) & 802.11ac(80MHz) didn't tested according to above description.

9.2. Test position and configuration

1. Liquid tissue depth was at least 15.0 cm for all frequencies.
2. The manufacturer has confirmed that the device(s) tested have the same physical, mechanical and thermal characteristics and are within operational tolerances expected for production units.
3. SAR results were scaled to the maximum allowed power to demonstrate compliance per FCC KDB Publication 447498 D01v06.
4. Reported SAR were scaled to the maximum duty factor to demonstrate compliance per FCC KDB 248227 D01 802.11 Wi-Fi SAR v02r02.
5. SAR was performed with the device configured in the positions according to KDB 447498 D02 SAR Procedures for Dongle Xmtr v02r01, body SAR was performed with the device to phantom separation distance of 5mm. All USB orientations (A: Horizontal-Up, B: Horizontal-Down, C: Vertical-Front, D: Vertical-Back, and E: Tip) were evaluated with 15cm USB cable for extension. Please check the SAR test photos.

WLAN Notes:

When the maximum extrapolated peak SAR of the zoom scan for the maximum output channel is <1.6 W/kg and the reported 1g averaged SAR is <0.8 W/kg, SAR testing on other default channels is not required.

Appendix A. SAR System Validation Data

Date/Time: 06-21-2017

Test Laboratory: DEKRA Lab

System Check Body 5250MHz

DUT: Dipole D5GHzV2; Type: D5GHzV2

Communication System: UID 0, CW (0); Communication System Band: 5GHz(5000.0-6000.0MHz); Duty Cycle: 1:1; Frequency: 5250 MHz; Medium parameters used: $f = 5250$ MHz; $\sigma = 5.41$ S/m; $\epsilon_r = 49.2$; $\rho = 1000$ kg/m³ ; Phantom section: Flat Section ; Input Power=100mW

Ambient temperature (°C): 21.5, Liquid temperature (°C): 21.0

DASY5 Configuration:

- Probe: EX3DV4 - SN3710; ConvF(4.51, 4.51, 4.51); Calibrated: 23/02/2017;
- Sensor-Surface: 4mm (Mechanical Surface Detection)
- Electronics: DAE4 Sn1220; Calibrated: 21/02/2017
- Phantom: SAM2; Type: SAM; Serial: TP1562
- Measurement SW: DASY52, Version 52.8 (8); SEMCAD X Version 14.6.10 (7331)

Configuration/Body 5250MHz/Area Scan (6x6x1): Measurement grid: dx=10mm, dy=10mm

Maximum value of SAR (measured) = 6.69 W/kg

Configuration/Body 5250MHz/Zoom Scan (7x7x7)/Cube 0: Measurement grid: dx=5mm, dy=5mm, dz=5mm; Reference Value = 39.37 V/m; Power Drift = -0.02 dB

Peak SAR (extrapolated) = 46.5 W/kg

SAR(1 g) = 7.85 W/kg; SAR(10 g) = 2.19 W/kg Maximum value of SAR (measured) = 8.21 W/kg

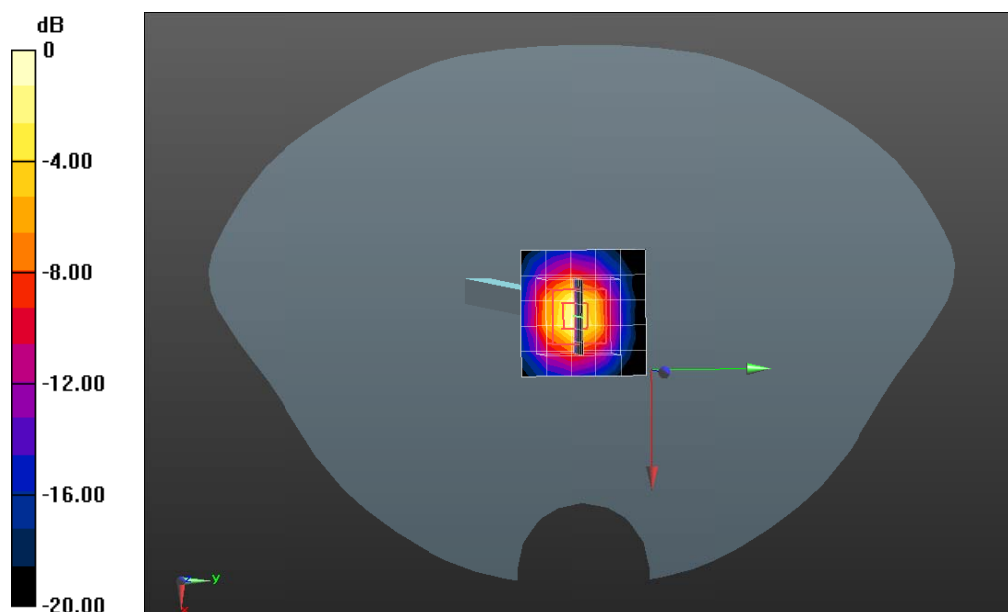

Test Laboratory: DEKRA Lab

System Check Body 5600MHz

DUT: Dipole D5GHzV2; Type: D5GHzV2

Communication System: UID 0, CW (0); Communication System Band: 5GHz(5000.0-6000.0MHz); Duty Cycle: 1:1; Frequency: 5600 MHz; Medium parameters used: $f = 5600$ MHz; $\sigma = 5.87$ S/m; $\epsilon_r = 48.15$; $\rho = 1000$ kg/m³ ; Phantom section: Flat Section ; Input Power=100mW

Ambient temperature (°C): 21.5, Liquid temperature (°C): 21.0

DASY5 Configuration:

- Probe: EX3DV4 - SN3710; ConvF(4.01, 4.01, 4.01); Calibrated: 23/02/2017;
- Sensor-Surface: 4mm (Mechanical Surface Detection)
- Electronics: DAE4 Sn1220; Calibrated: 21/02/2017
- Phantom: SAM2; Type: SAM; Serial: TP1562
- Measurement SW: DASY52, Version 52.8 (8); SEMCAD X Version 14.6.10 (7331)

Configuration/Body 5600MHz/Area Scan (6x6x1): Measurement grid: dx=10mm, dy=10mm

Maximum value of SAR (measured) = 7.08 W/kg

Configuration/Body 5600MHz/Zoom Scan (7x7x7)/Cube 0: Measurement grid: dx=5mm, dy=5mm, dz=5mm; Reference Value = 38.00 V/m; Power Drift = 0.06 dB

Peak SAR (extrapolated) = 49.5 W/kg

SAR(1 g) = 8.41 W/kg; SAR(10 g) = 2.38 W/kg Maximum value of SAR (measured) = 7.90 W/kg

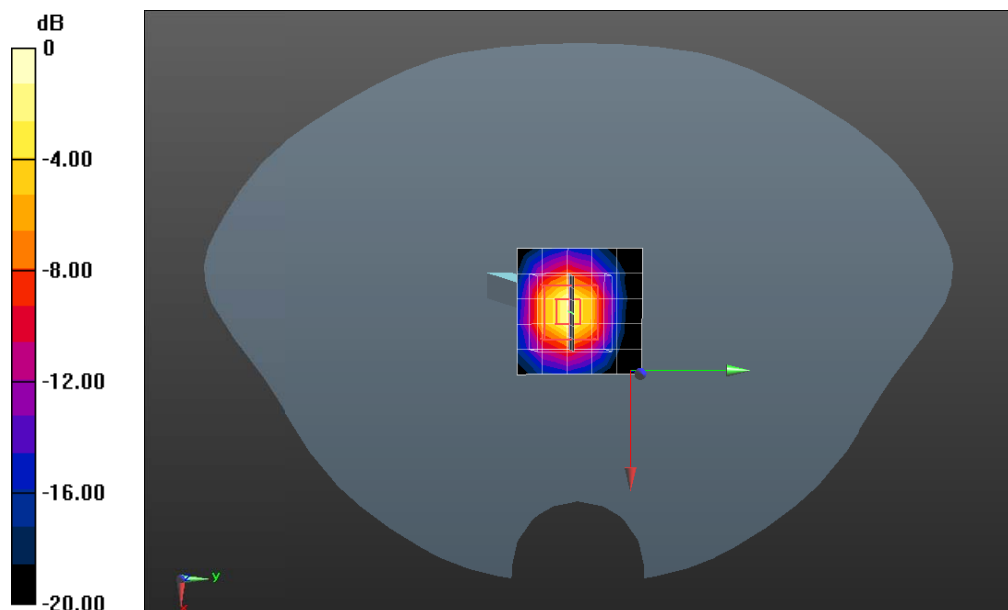

0 dB = 7.90 W/kg = 8.76 dBW/kg

Test Laboratory: DEKRA Lab

System Check Body 5750MHz

DUT: Dipole D5GHzV2; Type: D5GHzV2

Communication System: UID 0, CW (0); Communication System Band: 5GHz(5000.0-6000.0MHz); Duty Cycle: 1:1; Frequency: 5750 MHz; Medium parameters used: $f = 5750$ MHz; $\sigma = 6.09$ S/m; $\epsilon_r = 47.84$; $\rho = 1000$ kg/m³ ; Phantom section: Flat Section ; Input Power=100mW

Ambient temperature (°C): 21.5, Liquid temperature (°C): 21.0

DASY5 Configuration:

- Probe: EX3DV4 - SN3710; ConvF(4.09, 4.09, 4.09); Calibrated: 23/02/2017;
- Sensor-Surface: 2mm (Mechanical Surface Detection)
- Electronics: DAE4 Sn1220; Calibrated: 21/02/2017
- Phantom: SAM2; Type: SAM; Serial: TP1562
- Measurement SW: DASY52, Version 52.8 (8); SEMCAD X Version 14.6.10 (7331)

Configuration/Body 5750MHz/Area Scan (5x8x1): Measurement grid: dx=10mm, dy=10mm

Maximum value of SAR (measured) = 8.58 W/kg

Configuration/Body 5750MHz/Zoom Scan (8x8x10)/Cube 0: Measurement grid: dx=4mm, dy=4mm, dz=2.5mm; Reference Value = 45.49 V/m; Power Drift = 0.13 dB

Peak SAR (extrapolated) = 36.2 W/kg

SAR(1 g) = 7.92 W/kg; SAR(10 g) = 2.11 W/kg Maximum value of SAR (measured) = 10.6 W/kg

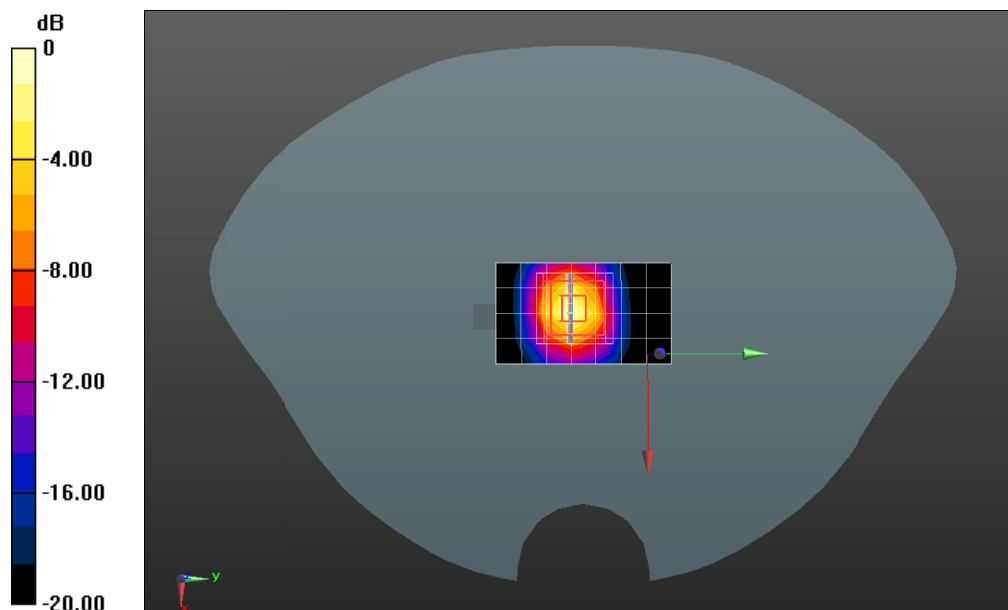

0 dB = 10.6 W/kg = 9.56 dBW/kg

Appendix B. SAR measurement Data

Date/Time: 06-21-2017

Test Laboratory: DEKRA Lab

802.11a 5200MHz Body-Horizontal Up

DUT: AC450 Wireless Nano USB Adapter; Type: Archer T1U

Communication System: UID 0, CW (0); Communication System Band: 5GHz(5000.0-6000.0MHz); Duty Cycle: 1:1.0; Frequency: 5200 MHz; Medium parameters used: $f = 5200$ MHz; $\sigma = 5.32$ S/m; $\epsilon_r = 49.33$; $\rho = 1000$ kg/m³ ; Phantom section: Flat Section

Ambient temperature (°C): 21.5, Liquid temperature (°C): 21.0

DASY5 Configuration:

- Probe: EX3DV4 - SN3710; ConvF(4.51, 4.51, 4.51); Calibrated: 23/02/2017;
- Sensor-Surface: 4mm (Mechanical Surface Detection)
- Electronics: DAE4 Sn1220; Calibrated: 21/02/2017
- Phantom: SAM2; Type: SAM; Serial: TP1562
- Measurement SW: DASY52, Version 52.8 (8); SEMCAD X Version 14.6.10 (7331)

Configuration/802.11a 5200MHz Body-Horizontal Up/Area Scan (7x7x1): Measurement grid: dx=10mm, dy=10mm Maximum value of SAR (measured) = 0.792 W/kg

Configuration/802.11a 5200MHz Body-Horizontal Up/Zoom Scan (7x7x6)/Cube 0: Measurement grid: dx=5mm, dy=5mm, dz=2mm; Reference Value = 11.71 V/m; Power Drift = 0.06 dB

Peak SAR (extrapolated) = 2.62 W/kg

SAR(1 g) = 0.789 W/kg; SAR(10 g) = 0.375 W/kg Maximum value of SAR (measured) = 0.780 W/kg

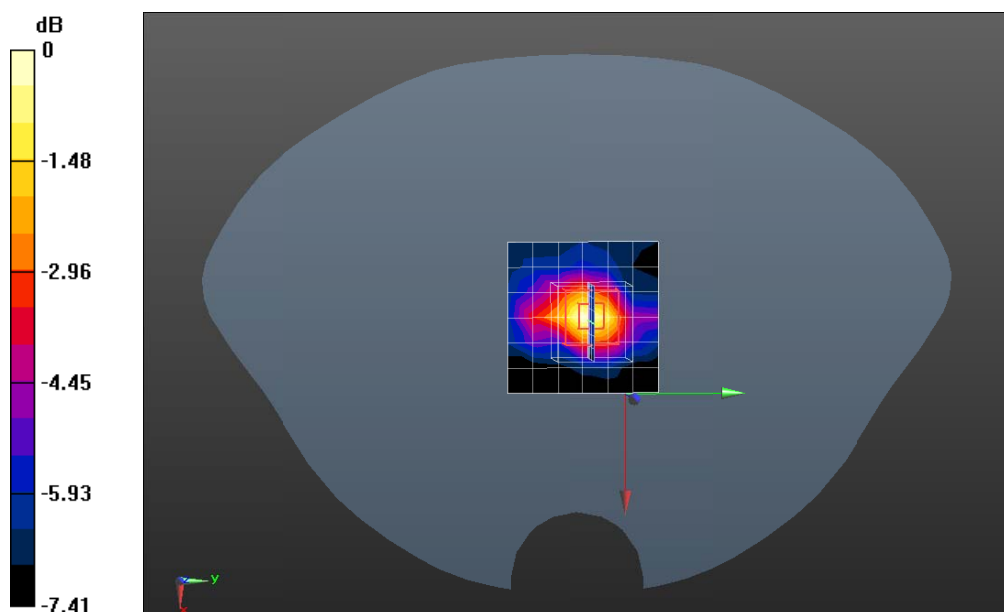

0 dB = 0.780 W/kg = -1.08 dBW/kg

Test Laboratory: DEKRA Lab

802.11a 5200MHz Body-Horizontal Down

DUT: AC450 Wireless Nano USB Adapter; Type: Archer T1U

Communication System: UID 0, CW (0); Communication System Band: 5GHz(5000.0-6000.0MHz); Duty Cycle: 1:1.0; Frequency: 5200 MHz; Medium parameters used: $f = 5200$ MHz; $\sigma = 5.32$ S/m; $\epsilon_r = 49.33$; $\rho = 1000$ kg/m³ ; Phantom section: Flat Section

Ambient temperature (°C): 21.5, Liquid temperature (°C): 21.0

DASY5 Configuration:

- Probe: EX3DV4 - SN3710; ConvF(4.51, 4.51, 4.51); Calibrated: 23/02/2017;
- Sensor-Surface: 4mm (Mechanical Surface Detection)
- Electronics: DAE4 Sn1220; Calibrated: 21/02/2017
- Phantom: SAM2; Type: SAM; Serial: TP1562
- Measurement SW: DASY52, Version 52.8 (8); SEMCAD X Version 14.6.10 (7331)

Configuration/802.11a 5200MHz Body-Horizontal Down/Area Scan (7x7x1): Measurement grid:

dx=10mm, dy=10mm

Maximum value of SAR (measured) = 0.776 W/kg

Configuration/802.11a 5200MHz Body-Horizontal Down/Zoom Scan (7x7x6)/Cube 0: Measurement grid:

dx=5mm, dy=5mm, dz=2mm; Reference Value = 13.60 V/m; Power Drift = 0.10 dB

Peak SAR (extrapolated) = 3.13 W/kg

SAR(1 g) = 1.01 W/kg; SAR(10 g) = 0.427 W/kg Maximum value of SAR (measured) = 1.06 W/kg

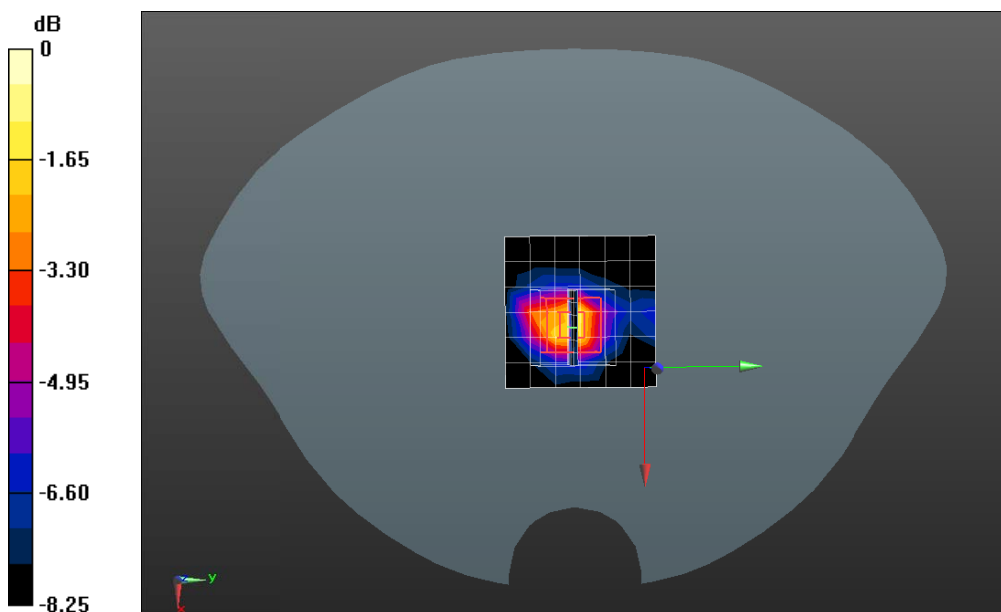

0 dB = 1.06 W/kg = 0.25 dBW/kg

Test Laboratory: DEKRA Lab

802.11a 5200MHz Body-Vertical Front

DUT: AC450 Wireless Nano USB Adapter; Type: Archer T1U

Communication System: UID 0, CW (0); Communication System Band: 5GHz(5000.0-6000.0MHz); Duty Cycle: 1:1.0; Frequency: 5200 MHz; Medium parameters used: $f = 5200$ MHz; $\sigma = 5.32$ S/m; $\epsilon_r = 49.33$; $\rho = 1000$ kg/m³ ; Phantom section: Flat Section

Ambient temperature (°C): 21.5, Liquid temperature (°C): 21.0

DASY5 Configuration:

- Probe: EX3DV4 - SN3710; ConvF(4.51, 4.51, 4.51); Calibrated: 23/02/2017;
- Sensor-Surface: 4mm (Mechanical Surface Detection)
- Electronics: DAE4 Sn1220; Calibrated: 21/02/2017
- Phantom: SAM2; Type: SAM; Serial: TP1562
- Measurement SW: DASY52, Version 52.8 (8); SEMCAD X Version 14.6.10 (7331)

Configuration/802.11a 5200MHz Body-Vertical Front/Area Scan (7x7x1): Measurement grid: dx=10mm, dy=10mm

Maximum value of SAR (measured) = 0.888 W/kg

Configuration/802.11a 5200MHz Body-Vertical Front/Zoom Scan (7x7x6)/Cube 0: Measurement grid:

dx=5mm, dy=5mm, dz=2mm; Reference Value = 12.04 V/m; Power Drift = 0.07 dB

Peak SAR (extrapolated) = 3.32 W/kg

SAR(1 g) = 1.08 W/kg; SAR(10 g) = 0.449 W/kg Maximum value of SAR (measured) = 1.13 W/kg

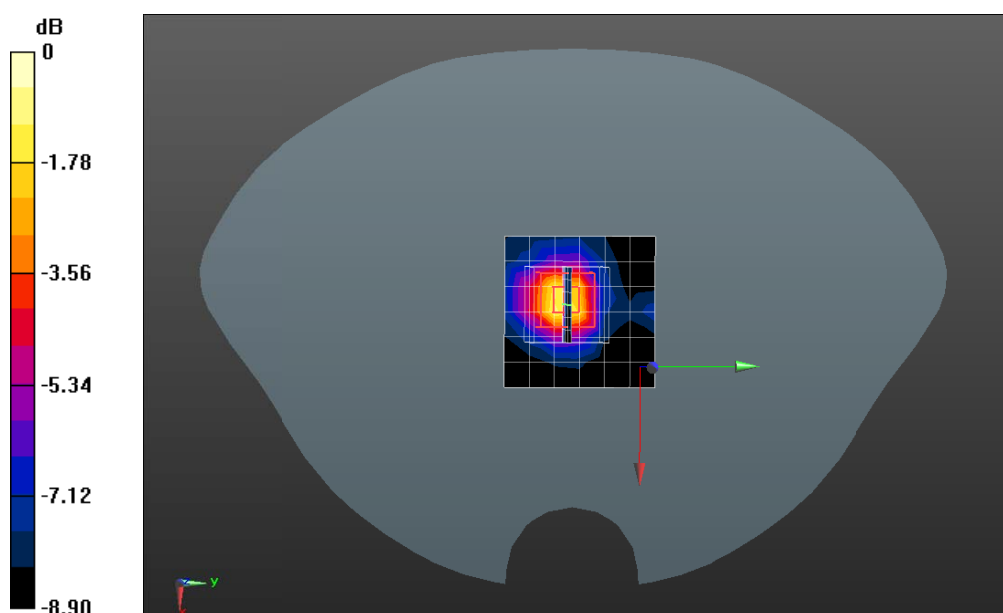

0 dB = 1.13 W/kg = 0.53 dBW/kg

Test Laboratory: DEKRA Lab

802.11a 5200MHz Body-Vertical Front*

DUT: AC450 Wireless Nano USB Adapter; Type: Archer T1U

Communication System: UID 0, CW (0); Communication System Band: 5GHz(5000.0-6000.0MHz); Duty Cycle: 1:1.0; Frequency: 5200 MHz; Medium parameters used: $f = 5200$ MHz; $\sigma = 5.32$ S/m; $\epsilon_r = 49.33$; $\rho = 1000$ kg/m³ ; Phantom section: Flat Section

Ambient temperature (°C): 21.5, Liquid temperature (°C): 21.0

DASY5 Configuration:

- Probe: EX3DV4 - SN3710; ConvF(4.51, 4.51, 4.51); Calibrated: 23/02/2017;
- Sensor-Surface: 4mm (Mechanical Surface Detection)
- Electronics: DAE4 Sn1220; Calibrated: 21/02/2017
- Phantom: SAM2; Type: SAM; Serial: TP1562
- Measurement SW: DASY52, Version 52.8 (8); SEMCAD X Version 14.6.10 (7331)

Configuration/802.11a 5200MHz Body-Vertical Front/Area Scan (7x7x1): Measurement grid: dx=10mm, dy=10mm

Maximum value of SAR (measured) = 0.982 W/kg

Configuration/802.11a 5200MHz Body-Vertical Front/Zoom Scan (7x7x6)/Cube 0: Measurement grid:

dx=5mm, dy=5mm, dz=2mm; Reference Value = 11.57 V/m; Power Drift = -0.17 dB

Peak SAR (extrapolated) = 4.34 W/kg

SAR(1 g) = 1.05 W/kg; SAR(10 g) = 0.443 W/kg Maximum value of SAR (measured) = 1.13 W/kg

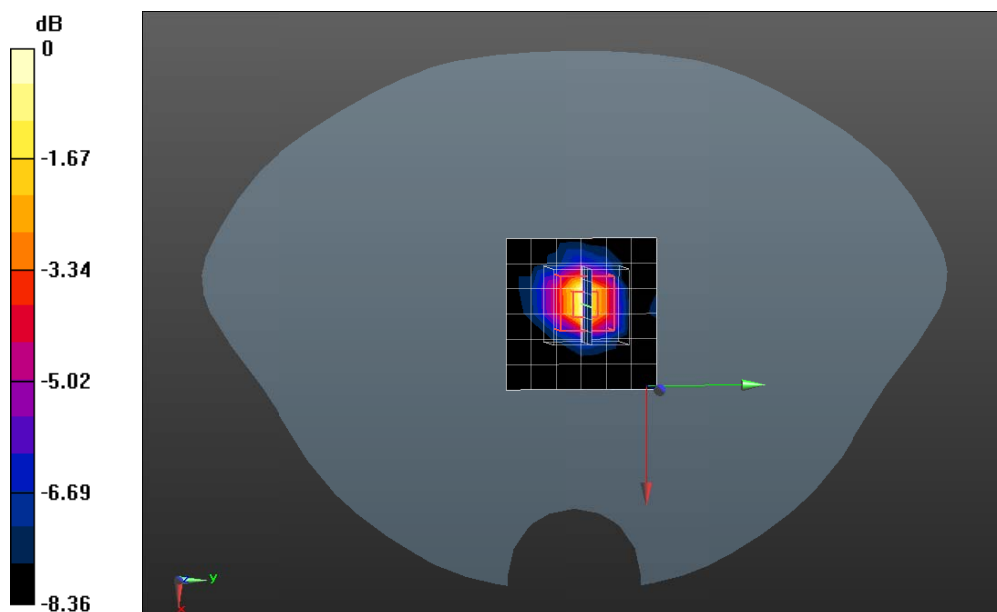

0 dB = 1.13 W/kg = 0.53 dBW/kg

Test Laboratory: DEKRA Lab

802.11a 5200MHz Body-Vertical Back

DUT: AC450 Wireless Nano USB Adapter; Type: Archer T1U

Communication System: UID 0, CW (0); Communication System Band: 5GHz(5000.0-6000.0MHz); Duty Cycle: 1:1.0; Frequency: 5200 MHz; Medium parameters used: $f = 5200$ MHz; $\sigma = 5.32$ S/m; $\epsilon_r = 49.33$; $\rho = 1000$ kg/m³ ; Phantom section: Flat Section

Ambient temperature (°C): 21.5, Liquid temperature (°C): 21.0

DASY5 Configuration:

- Probe: EX3DV4 - SN3710; ConvF(4.51, 4.51, 4.51); Calibrated: 23/02/2017;
- Sensor-Surface: 4mm (Mechanical Surface Detection)
- Electronics: DAE4 Sn1220; Calibrated: 21/02/2017
- Phantom: SAM2; Type: SAM; Serial: TP1562
- Measurement SW: DASY52, Version 52.8 (8); SEMCAD X Version 14.6.10 (7331)

Configuration/802.11a 5200MHz Body-Vertical Back/Area Scan (7x7x1): Measurement grid: dx=10mm, dy=10mm

Maximum value of SAR (measured) = 0.435 W/kg

Configuration/802.11a 5200MHz Body-Vertical Back/Zoom Scan (7x7x6)/Cube 0: Measurement grid: dx=5mm, dy=5mm, dz=2mm; Reference Value = 9.651 V/m; Power Drift = 0.06 dB

Peak SAR (extrapolated) = 2.61 W/kg

SAR(1 g) = 0.655 W/kg; SAR(10 g) = 0.302 W/kg Maximum value of SAR (measured) = 0.643 W/kg

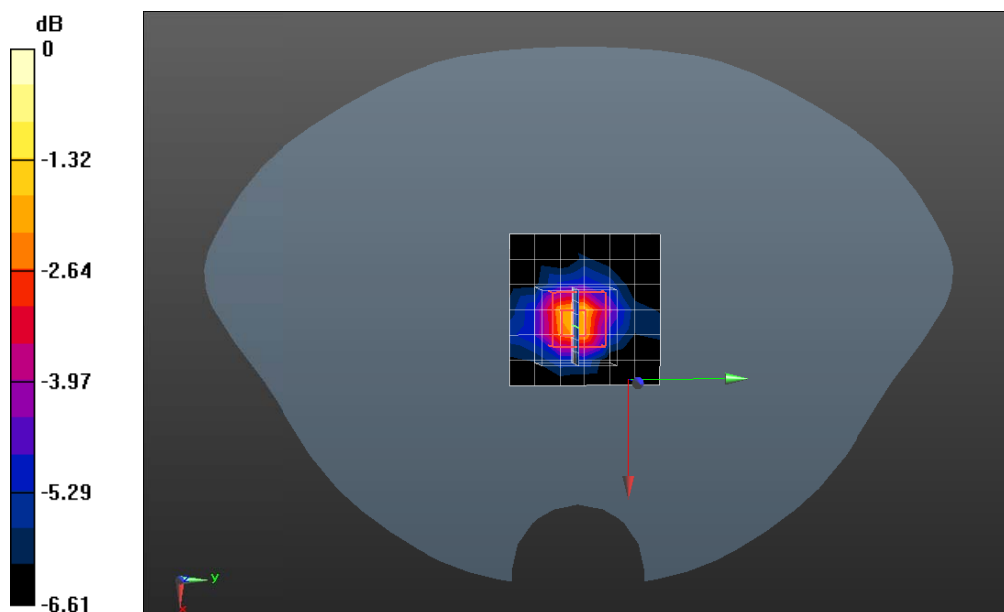

0 dB = 0.643 W/kg = -1.92 dBW/kg

Test Laboratory: DEKRA Lab

802.11a 5200MHz Body-Tip

DUT: AC450 Wireless Nano USB Adapter; Type: Archer T1U

Communication System: UID 0, CW (0); Communication System Band: 5GHz(5000.0-6000.0MHz); Duty Cycle: 1:1.0; Frequency: 5200 MHz; Medium parameters used: $f = 5200$ MHz; $\sigma = 5.32$ S/m; $\epsilon_r = 49.33$; $\rho = 1000$ kg/m³ ; Phantom section: Flat Section

Ambient temperature (°C): 21.5, Liquid temperature (°C): 21.0

DASY5 Configuration:

- Probe: EX3DV4 - SN3710; ConvF(4.51, 4.51, 4.51); Calibrated: 23/02/2017;
- Sensor-Surface: 4mm (Mechanical Surface Detection)
- Electronics: DAE4 Sn1220; Calibrated: 21/02/2017
- Phantom: SAM2; Type: SAM; Serial: TP1562
- Measurement SW: DASY52, Version 52.8 (8); SEMCAD X Version 14.6.10 (7331)

Configuration/802.11a 5200MHz Body-Tip/Area Scan (7x7x1): Measurement grid: dx=10mm, dy=10mm

Maximum value of SAR (measured) = 0.503 W/kg

Configuration/802.11a 5200MHz Body-Tip/Zoom Scan (7x7x6)/Cube 0: Measurement grid: dx=5mm, dy=5mm, dz=2mm; Reference Value = 8.425 V/m; Power Drift = -0.11 dB

Peak SAR (extrapolated) = 2.71 W/kg

SAR(1 g) = 0.572 W/kg; SAR(10 g) = 0.295 W/kg Maximum value of SAR (measured) = 0.602 W/kg

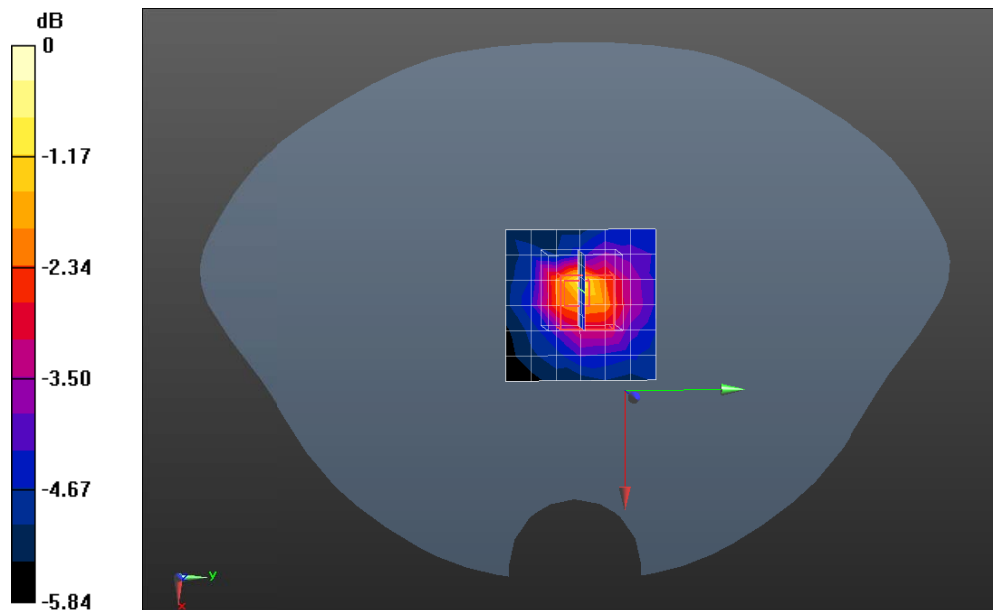

0 dB = 0.602 W/kg = -2.20 dBW/kg

Test Laboratory: DEKRA Lab

802.11a 5240MHz Body-Horizontal-Up

DUT: AC450 Wireless Nano USB Adapter; Type: Archer T1U

Communication System: UID 0, CW (0); Communication System Band: 5GHz(5000.0-6000.0MHz); Duty Cycle: 1:1.0; Frequency: 5240 MHz; Medium parameters used: $f = 5240$ MHz; $\sigma = 5.39$ S/m; $\epsilon_r = 49.22$; $\rho = 1000$ kg/m³ ; Phantom section: Flat Section

Ambient temperature (°C): 21.5, Liquid temperature (°C): 21.0

DASY5 Configuration:

- Probe: EX3DV4 - SN3710; ConvF(4.51, 4.51, 4.51); Calibrated: 23/02/2017;
- Sensor-Surface: 4mm (Mechanical Surface Detection)
- Electronics: DAE4 Sn1220; Calibrated: 21/02/2017
- Phantom: SAM2; Type: SAM; Serial: TP1562
- Measurement SW: DASY52, Version 52.8 (8); SEMCAD X Version 14.6.10 (7331)

Configuration/802.11a 5240MHz Body-Horizontal Up/Area Scan (7x7x1): Measurement grid: dx=10mm, dy=10mm

Maximum value of SAR (measured) = 0.715 W/kg

Configuration/802.11a 5240MHz Body-Horizontal Up/Zoom Scan (7x7x6)/Cube 0: Measurement grid:

dx=5mm, dy=5mm, dz=2mm; Reference Value = 13.32 V/m; Power Drift = -0.04 dB

Peak SAR (extrapolated) = 2.20 W/kg

SAR(1 g) = 0.827 W/kg; SAR(10 g) = 0.409 W/kg Maximum value of SAR (measured) = 0.878 W/kg

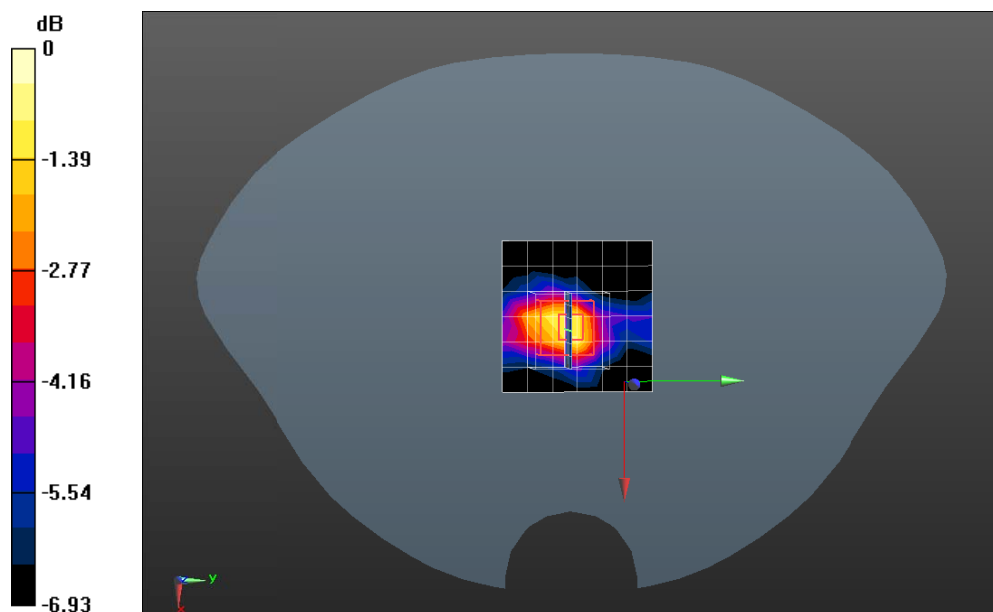

0 dB = 0.878 W/kg = -0.57 dBW/kg

Test Laboratory: DEKRA Lab

802.11a 5240MHz Body-Horizontal Down

DUT: AC450 Wireless Nano USB Adapter; Type: Archer T1U

Communication System: UID 0, CW (0); Communication System Band: 5GHz(5000.0-6000.0MHz); Duty Cycle: 1:1.0; Frequency: 5240 MHz; Medium parameters used: $f = 5240$ MHz; $\sigma = 5.39$ S/m; $\epsilon_r = 49.22$; $\rho = 1000$ kg/m³ ; Phantom section: Flat Section

Ambient temperature (°C): 21.5, Liquid temperature (°C): 21.0

DASY5 Configuration:

- Probe: EX3DV4 - SN3710; ConvF(4.51, 4.51, 4.51); Calibrated: 23/02/2017;
- Sensor-Surface: 4mm (Mechanical Surface Detection)
- Electronics: DAE4 Sn1220; Calibrated: 21/02/2017
- Phantom: SAM2; Type: SAM; Serial: TP1562
- Measurement SW: DASY52, Version 52.8 (8); SEMCAD X Version 14.6.10 (7331)

Configuration/802.11a 5240MHz Body-Horizontal Down/Area Scan (7x7x1): Measurement grid:

dx=10mm, dy=10mm

Maximum value of SAR (measured) = 0.830 W/kg

Configuration/802.11a 5240MHz Body-Horizontal Down/Zoom Scan (7x7x6)/Cube 0: Measurement grid:

dx=5mm, dy=5mm, dz=2mm; Reference Value = 8.805 V/m; Power Drift = 0.09 dB

Peak SAR (extrapolated) = 3.44 W/kg

SAR(1 g) = 0.933 W/kg; SAR(10 g) = 0.399 W/kg Maximum value of SAR (measured) = 0.938 W/kg

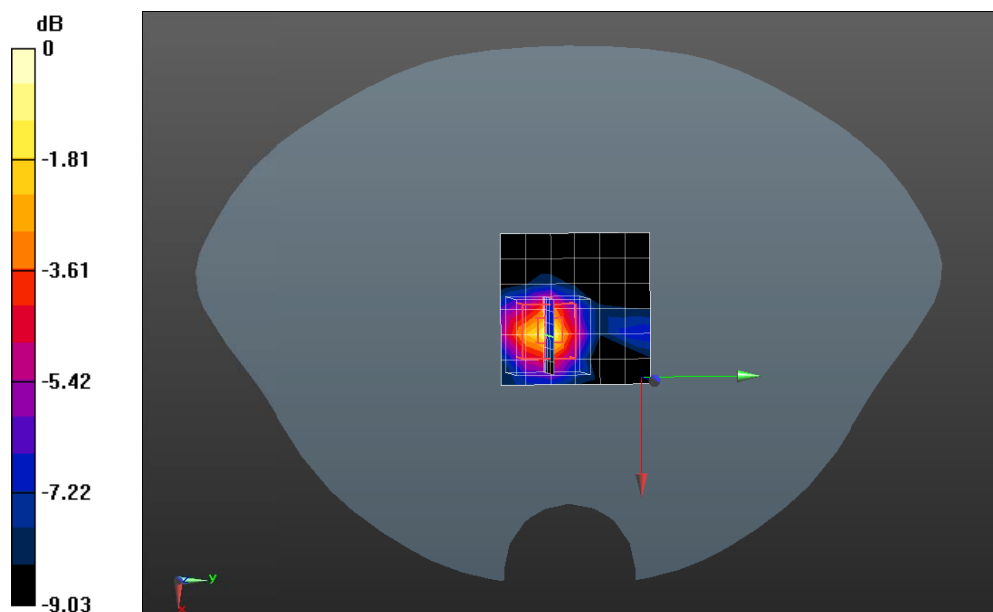

0 dB = 0.938 W/kg = -0.28 dBW/kg

Test Laboratory: DEKRA Lab

802.11a 5240MHz Body-Vertical Front

DUT: AC450 Wireless Nano USB Adapter; Type: Archer T1U

Communication System: UID 0, CW (0); Communication System Band: 5GHz(5000.0-6000.0MHz); Duty Cycle: 1:1.0; Frequency: 5240 MHz; Medium parameters used: $f = 5240$ MHz; $\sigma = 5.39$ S/m; $\epsilon_r = 49.22$; $\rho = 1000$ kg/m³ ; Phantom section: Flat Section

Ambient temperature (°C): 21.5, Liquid temperature (°C): 21.0

DASY5 Configuration:

- Probe: EX3DV4 - SN3710; ConvF(4.51, 4.51, 4.51); Calibrated: 23/02/2017;
- Sensor-Surface: 4mm (Mechanical Surface Detection)
- Electronics: DAE4 Sn1220; Calibrated: 21/02/2017
- Phantom: SAM2; Type: SAM; Serial: TP1562
- Measurement SW: DASY52, Version 52.8 (8); SEMCAD X Version 14.6.10 (7331)

Configuration/802.11a 5240MHz Body-Vertical Front/Area Scan (7x7x1): Measurement grid: dx=10mm, dy=10mm

Maximum value of SAR (measured) = 0.963 W/kg

Configuration/802.11a 5240MHz Body-Vertical Front/Zoom Scan (7x7x6)/Cube 0: Measurement grid:

dx=5mm, dy=5mm, dz=2mm; Reference Value = 12.23 V/m; Power Drift = 0.01 dB

Peak SAR (extrapolated) = 3.89 W/kg

SAR(1 g) = 0.982 W/kg; SAR(10 g) = 0.398 W/kg Maximum value of SAR (measured) = 0.964 W/kg

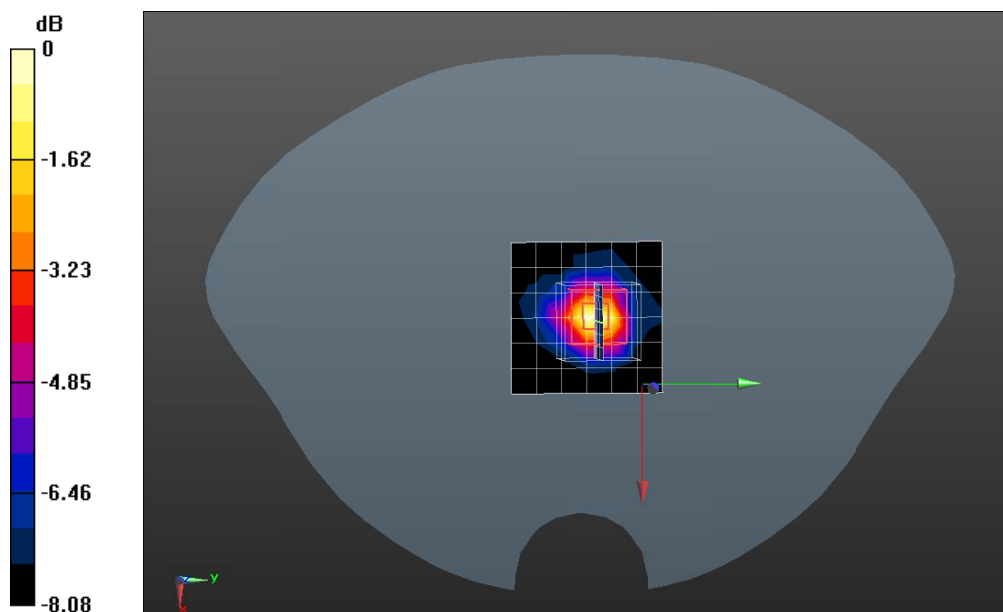

0 dB = 0.964 W/kg = -0.16 dBW/kg

Test Laboratory: DEKRA Lab

802.11n40 5230MHz Body-Vertical Front

DUT: AC450 Wireless Nano USB Adapter; Type: Archer T1U

Communication System: UID 0, CW (0); Communication System Band: 5GHz(5000.0-6000.0MHz); Duty Cycle: 1:1.0; Frequency: 5230 MHz; Medium parameters used: $f = 5230$ MHz; $\sigma = 5.37$ S/m; $\epsilon_r = 49.25$; $\rho = 1000$ kg/m³ ; Phantom section: Flat Section

Ambient temperature (°C): 21.5, Liquid temperature (°C): 21.0

DASY5 Configuration:

- Probe: EX3DV4 - SN3710; ConvF(4.51, 4.51, 4.51); Calibrated: 23/02/2017;
- Sensor-Surface: 4mm (Mechanical Surface Detection)
- Electronics: DAE4 Sn1220; Calibrated: 21/02/2017
- Phantom: SAM2; Type: SAM; Serial: TP1562
- Measurement SW: DASY52, Version 52.8 (8); SEMCAD X Version 14.6.10 (7331)

Configuration/802.11n40 5230MHz Body-Vertical Front/Area Scan (7x7x1): Measurement grid:

dx=10mm, dy=10mm

Maximum value of SAR (measured) = 0.795 W/kg

Configuration/802.11n40 5230MHz Body-Vertical Front/Zoom Scan (7x7x6)/Cube 0: Measurement grid:

dx=5mm, dy=5mm, dz=2mm, Reference Value = 11.80 V/m; Power Drift = -0.15 dB

Peak SAR (extrapolated) = 4.31 W/kg

SAR(1 g) = 0.998 W/kg; SAR(10 g) = 0.414 W/kg Maximum value of SAR (measured) = 0.951 W/kg

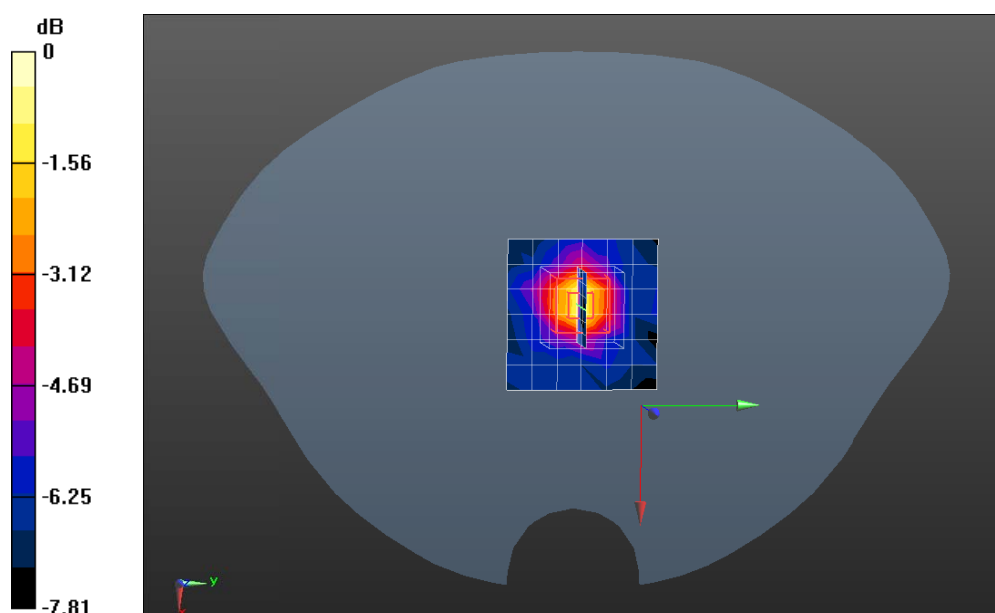

0 dB = 0.951 W/kg = -0.22 dBW/kg

Test Laboratory: DEKRA Lab

802.11n40 5230MHz Body-Horizontal Up

DUT: AC450 Wireless Nano USB Adapter; Type: Archer T1U

Communication System: UID 0, CW (0); Communication System Band: 5GHz(5000.0-6000.0MHz); Duty Cycle: 1:1.0; Frequency: 5230 MHz; Medium parameters used: $f = 5230$ MHz; $\sigma = 5.37$ S/m; $\epsilon_r = 49.25$; $\rho = 1000$ kg/m³ ; Phantom section: Flat Section

Ambient temperature (°C): 21.5, Liquid temperature (°C): 21.0

DASY5 Configuration:

- Probe: EX3DV4 - SN3710; ConvF(4.51, 4.51, 4.51); Calibrated: 23/02/2017;
- Sensor-Surface: 4mm (Mechanical Surface Detection)
- Electronics: DAE4 Sn1220; Calibrated: 21/02/2017
- Phantom: SAM2; Type: SAM; Serial: TP1562
- Measurement SW: DASY52, Version 52.8 (8); SEMCAD X Version 14.6.10 (7331)

Configuration/802.11n40 5230MHz Body-Horizontal Up/Area Scan (7x7x1): Measurement grid:

dx=10mm, dy=10mm

Maximum value of SAR (measured) = 0.863 W/kg

Configuration/802.11n40 5230MHz Body-Horizontal Up/Zoom Scan (7x7x6)/Cube 0: Measurement grid:

dx=5mm, dy=5mm, dz=2mm, Reference Value = 11.42 V/m; Power Drift = 0.01 dB

Peak SAR (extrapolated) = 3.70 W/kg

SAR(1 g) = 0.955 W/kg; SAR(10 g) = 0.413 W/kg Maximum value of SAR (measured) = 0.986 W/kg

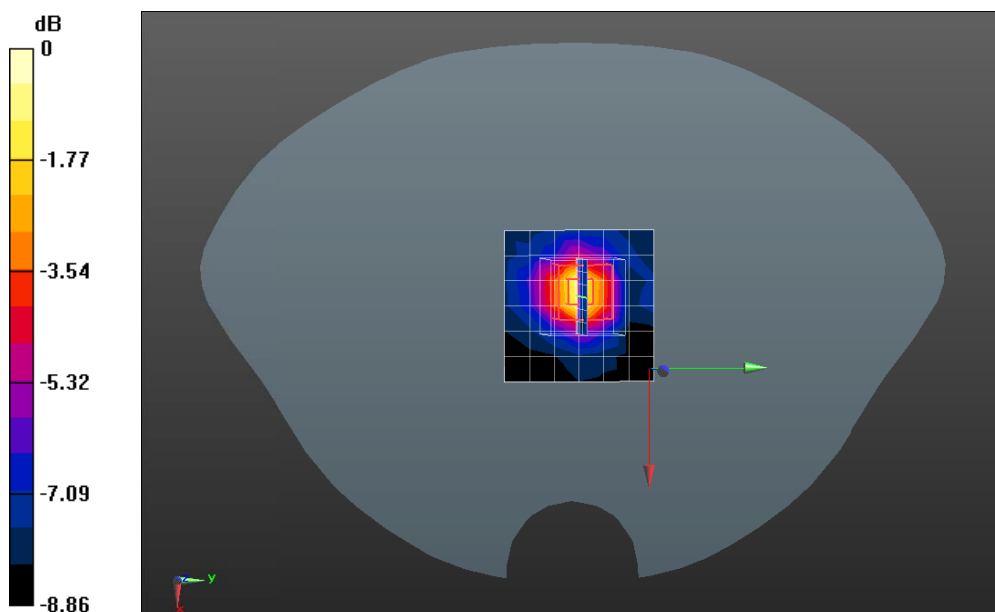

0 dB = 0.986 W/kg = -0.06 dBW/kg

Test Laboratory: DEKRA Lab

802.11n40 5230MHz Body-Horizontal Down

DUT: AC450 Wireless Nano USB Adapter; Type: Archer T1U

Communication System: UID 0, CW (0); Communication System Band: 5GHz(5000.0-6000.0MHz); Duty Cycle: 1:1.0; Frequency: 5230 MHz; Medium parameters used: $f = 5230$ MHz; $\sigma = 5.37$ S/m; $\epsilon_r = 49.25$; $\rho = 1000$ kg/m³ ; Phantom section: Flat Section

Ambient temperature (°C): 21.5, Liquid temperature (°C): 21.0

DASY5 Configuration:

- Probe: EX3DV4 - SN3710; ConvF(4.51, 4.51, 4.51); Calibrated: 23/02/2017;
- Sensor-Surface: 4mm (Mechanical Surface Detection)
- Electronics: DAE4 Sn1220; Calibrated: 21/02/2017
- Phantom: SAM2; Type: SAM; Serial: TP1562
- Measurement SW: DASY52, Version 52.8 (8); SEMCAD X Version 14.6.10 (7331)

Configuration/802.11n40 5230MHz Body-Horizontal Down/Area Scan (7x7x1): Measurement grid:

dx=10mm, dy=10mm

Maximum value of SAR (measured) = 0.488 W/kg

Configuration/802.11n40 5230MHz Body-Horizontal Down/Zoom Scan (7x7x6)/Cube 0: Measurement

grid: dx=5mm, dy=5mm, dz=2mm, Reference Value = 7.989 V/m; Power Drift = 0.18 dB

Peak SAR (extrapolated) = 2.17 W/kg

SAR(1 g) = 0.599 W/kg; SAR(10 g) = 0.299 W/kg Maximum value of SAR (measured) = 0.578 W/kg

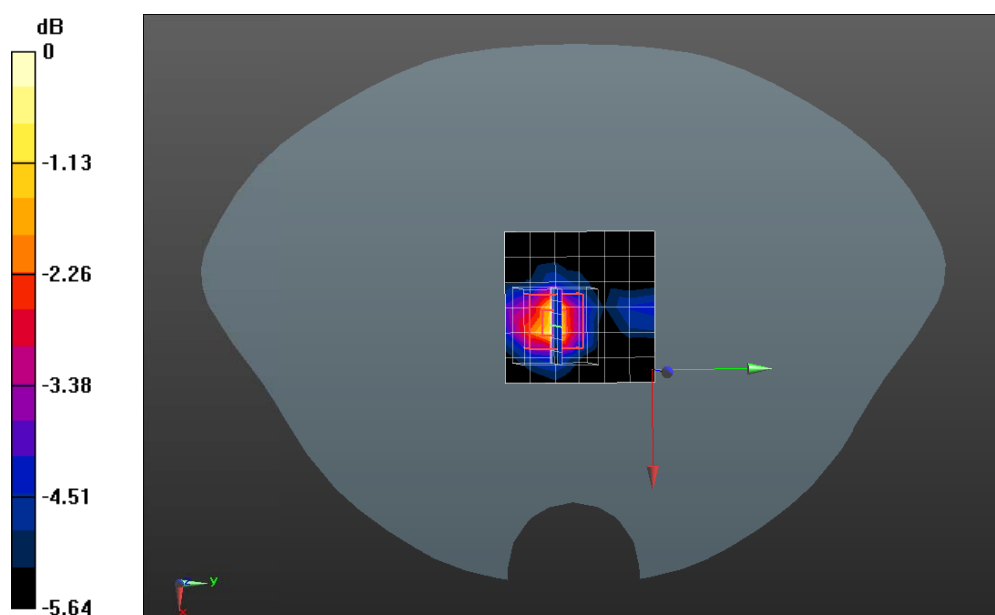

0 dB = 0.578 W/kg = -2.38 dBW/kg

Test Laboratory: DEKRA Lab

802.11ac40 5230MHz Body-Vertical Front

DUT: AC450 Wireless Nano USB Adapter; Type: Archer T1U

Communication System: UID 0, CW (0); Communication System Band: 5GHz(5000.0-6000.0MHz); Duty Cycle: 1:1.0; Frequency: 5230 MHz; Medium parameters used: $f = 5230$ MHz; $\sigma = 5.37$ S/m; $\epsilon_r = 49.25$; $\rho = 1000$ kg/m³ ; Phantom section: Flat Section

Ambient temperature (°C): 21.5, Liquid temperature (°C): 21.0

DASY5 Configuration:

- Probe: EX3DV4 - SN3710; ConvF(4.51, 4.51, 4.51); Calibrated: 23/02/2017;
- Sensor-Surface: 4mm (Mechanical Surface Detection)
- Electronics: DAE4 Sn1220; Calibrated: 21/02/2017
- Phantom: SAM2; Type: SAM; Serial: TP1562
- Measurement SW: DASY52, Version 52.8 (8); SEMCAD X Version 14.6.10 (7331)

Configuration/802.11ac40 5230MHz Body-Vertical Front/Area Scan (7x7x1): Measurement grid:

dx=10mm, dy=10mm

Maximum value of SAR (measured) = 0.854 W/kg

Configuration/802.11ac40 5230MHz Body-Vertical Front/Zoom Scan (7x7x6)/Cube 0: Measurement

grid: dx=5mm, dy=5mm, dz=2mm, Reference Value = 11.41 V/m; Power Drift = 0.03 dB

Peak SAR (extrapolated) = 3.66 W/kg

SAR(1 g) = 1.09 W/kg; SAR(10 g) = 0.439 W/kg Maximum value of SAR (measured) = 1.07 W/kg

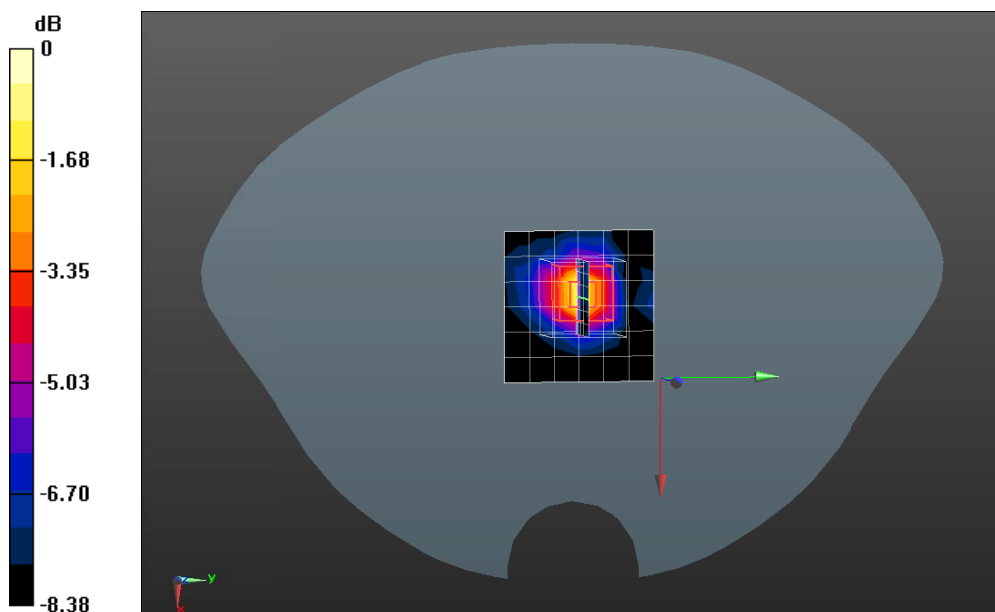

0 dB = 1.07 W/kg = 0.29 dBW/kg

Test Laboratory: DEKRA Lab

802.11ac40 5230MHz Body-Horizontal Up

DUT: AC450 Wireless Nano USB Adapter; Type: Archer T1U

Communication System: UID 0, CW (0); Communication System Band: 5GHz(5000.0-6000.0MHz); Duty Cycle: 1:1.0; Frequency: 5230 MHz; Medium parameters used: $f = 5230$ MHz; $\sigma = 5.37$ S/m; $\epsilon_r = 49.25$; $\rho = 1000$ kg/m³ ; Phantom section: Flat Section

Ambient temperature (°C): 21.5, Liquid temperature (°C): 21.0

DASY5 Configuration:

- Probe: EX3DV4 - SN3710; ConvF(4.51, 4.51, 4.51); Calibrated: 23/02/2017;
- Sensor-Surface: 4mm (Mechanical Surface Detection)
- Electronics: DAE4 Sn1220; Calibrated: 21/02/2017
- Phantom: SAM2; Type: SAM; Serial: TP1562
- Measurement SW: DASY52, Version 52.8 (8); SEMCAD X Version 14.6.10 (7331)

Configuration/802.11ac40 5230MHz Body-Vertical Front/Area Scan (7x7x1): Measurement grid:

dx=10mm, dy=10mm

Maximum value of SAR (measured) = 0.818 W/kg

Configuration/802.11ac40 5230MHz Body-Vertical Front/Zoom Scan (7x7x6)/Cube 0: Measurement

grid: dx=5mm, dy=5mm, dz=2mm, Reference Value = 11.09 V/m; Power Drift = 0.12 dB

Peak SAR (extrapolated) = 4.13 W/kg

SAR(1 g) = 1.07 W/kg; SAR(10 g) = 0.437 W/kg Maximum value of SAR (measured) = 1.09 W/kg

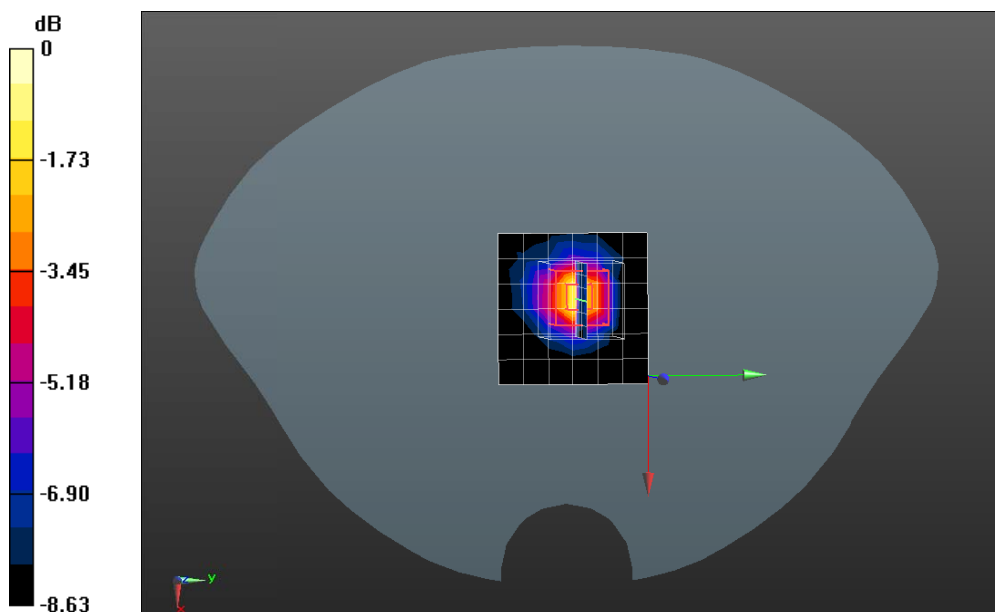

0 dB = 1.09 W/kg = 0.37 dBW/kg

Test Laboratory: DEKRA Lab

802.11ac40 5230MHz Body-Horizontal Down

DUT: AC450 Wireless Nano USB Adapter; Type: Archer T1U

Communication System: UID 0, CW (0); Communication System Band: 5GHz(5000.0-6000.0MHz); Duty Cycle: 1:1.0; Frequency: 5230 MHz; Medium parameters used: $f = 5230$ MHz; $\sigma = 5.37$ S/m; $\epsilon_r = 49.25$; $\rho = 1000$ kg/m³ ; Phantom section: Flat Section

Ambient temperature (°C): 21.5, Liquid temperature (°C): 21.0

DASY5 Configuration:

- Probe: EX3DV4 - SN3710; ConvF(4.51, 4.51, 4.51); Calibrated: 23/02/2017;
- Sensor-Surface: 4mm (Mechanical Surface Detection)
- Electronics: DAE4 Sn1220; Calibrated: 21/02/2017
- Phantom: SAM2; Type: SAM; Serial: TP1562
- Measurement SW: DASY52, Version 52.8 (8); SEMCAD X Version 14.6.10 (7331)

Configuration/802.11ac40 5230MHz Body-Horizontal Down/Area Scan (7x7x1): Measurement grid:

dx=10mm, dy=10mm

Maximum value of SAR (measured) = 0.636 W/kg

Configuration/802.11ac40 5230MHz Body-Horizontal Down/Zoom Scan (7x7x6)/Cube 0: Measurement

grid: dx=5mm, dy=5mm, dz=2mm, Reference Value = 9.040 V/m; Power Drift = -0.19 dB

Peak SAR (extrapolated) = 2.82 W/kg

SAR(1 g) = 0.723 W/kg; SAR(10 g) = 0.334 W/kg Maximum value of SAR (measured) = 0.682 W/kg

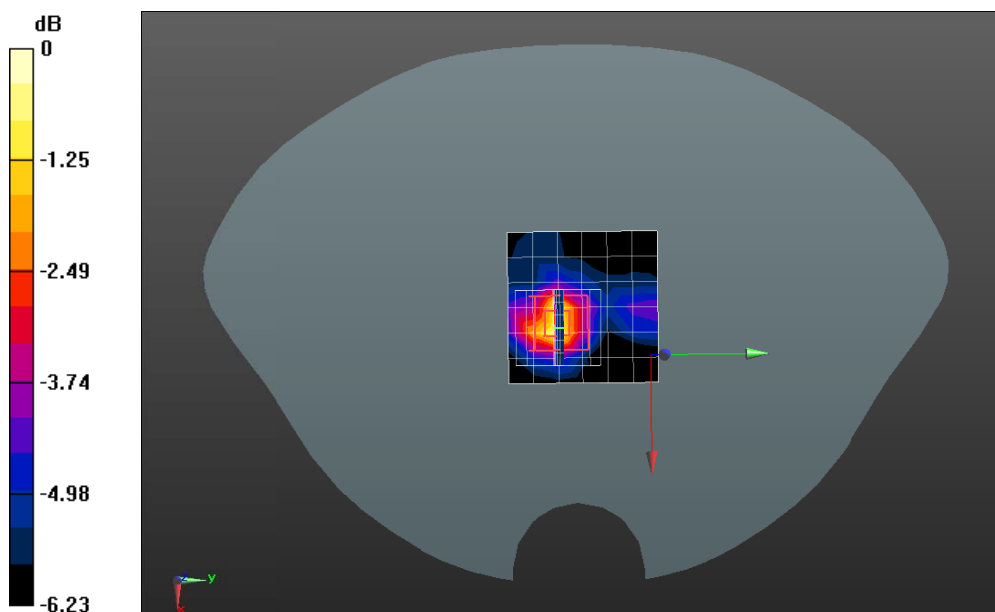

0 dB = 0.682 W/kg = -1.66 dBW/kg

Test Laboratory: DEKRA Lab

802.11a 5300MHz Body-Horizontal Up

DUT: AC450 Wireless Nano USB Adapter; Type: Archer T1U

Communication System: UID 0, CW (0); Communication System Band: 5GHz(5000.0-6000.0MHz); Duty Cycle: 1:1.0; Frequency: 5300 MHz; Medium parameters used: $f = 5300$ MHz; $\sigma = 5.47$ S/m; $\epsilon_r = 49.06$; $\rho = 1000$ kg/m³ ; Phantom section: Flat Section

Ambient temperature (°C): 21.5, Liquid temperature (°C): 21.0

DASY5 Configuration:

- Probe: EX3DV4 - SN3710; ConvF(4.51, 4.51, 4.51); Calibrated: 23/02/2017;
- Sensor-Surface: 4mm (Mechanical Surface Detection)
- Electronics: DAE4 Sn1220; Calibrated: 21/02/2017
- Phantom: SAM2; Type: SAM; Serial: TP1562
- Measurement SW: DASY52, Version 52.8 (8); SEMCAD X Version 14.6.10 (7331)

Configuration/802.11a 5300MHz Body-Horizontal up/Area Scan (7x7x1): Measurement grid: dx=10mm, dy=10mm

Maximum value of SAR (measured) = 0.557 W/kg

Configuration/802.11a 5300MHz Body-Horizontal up/Zoom Scan (7x7x6)/Cube 0: Measurement grid: dx=5mm, dy=5mm, dz=2mm; Reference Value = 6.846 V/m; Power Drift = 0.05 dB

Peak SAR (extrapolated) = 2.51 W/kg

SAR(1 g) = 0.633 W/kg; SAR(10 g) = 0.286 W/kg Maximum value of SAR (measured) = 0.641 W/kg

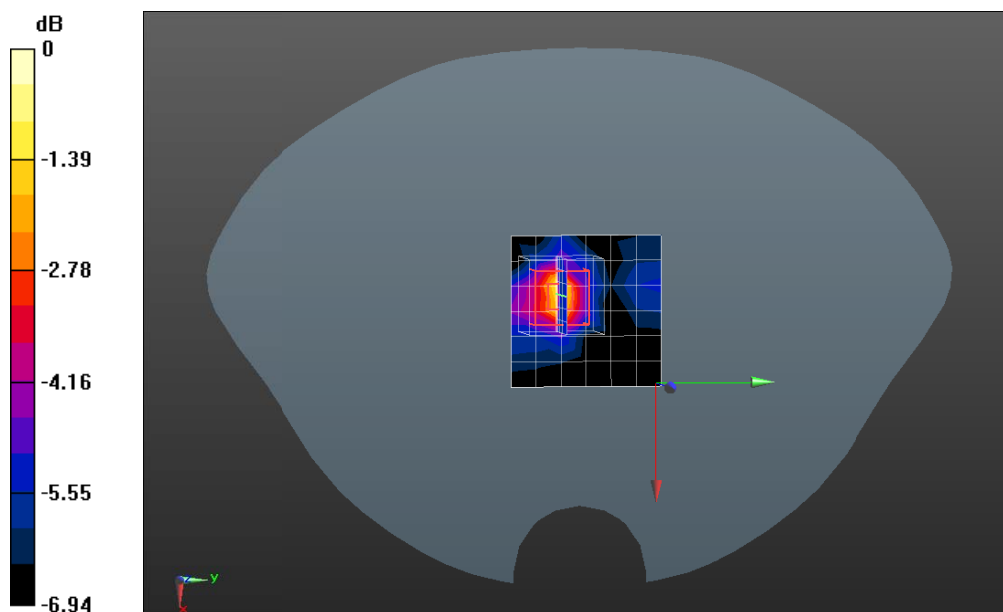

0 dB = 0.641 W/kg = -1.93 dBW/kg

Test Laboratory: DEKRA Lab

802.11a 5300MHz Body-Horizontal Down

DUT: AC450 Wireless Nano USB Adapter; Type: Archer T1U

Communication System: UID 0, CW (0); Communication System Band: 5GHz(5000.0-6000.0MHz); Duty Cycle: 1:1.0; Frequency: 5300 MHz; Medium parameters used: $f = 5300$ MHz; $\sigma = 5.47$ S/m; $\epsilon_r = 49.06$; $\rho = 1000$ kg/m³ ; Phantom section: Flat Section

Ambient temperature (°C): 21.5, Liquid temperature (°C): 21.0

DASY5 Configuration:

- Probe: EX3DV4 - SN3710; ConvF(4.51, 4.51, 4.51); Calibrated: 23/02/2017;
- Sensor-Surface: 4mm (Mechanical Surface Detection)
- Electronics: DAE4 Sn1220; Calibrated: 21/02/2017
- Phantom: SAM2; Type: SAM; Serial: TP1562
- Measurement SW: DASY52, Version 52.8 (8); SEMCAD X Version 14.6.10 (7331)

Configuration/802.11a 5300MHz Body-Horizontal Down/Area Scan (7x7x1): Measurement grid:

dx=10mm, dy=10mm

Maximum value of SAR (measured) = 0.696 W/kg

Configuration/802.11a 5300MHz Body-Horizontal Down/Zoom Scan (7x7x6)/Cube 0: Measurement grid:

dx=5mm, dy=5mm, dz=2mm; Reference Value = 9.072 V/m; Power Drift = 0.05 dB

Peak SAR (extrapolated) = 3.43 W/kg

SAR(1 g) = 0.863 W/kg; SAR(10 g) = 0.379 W/kg Maximum value of SAR (measured) = 0.816 W/kg

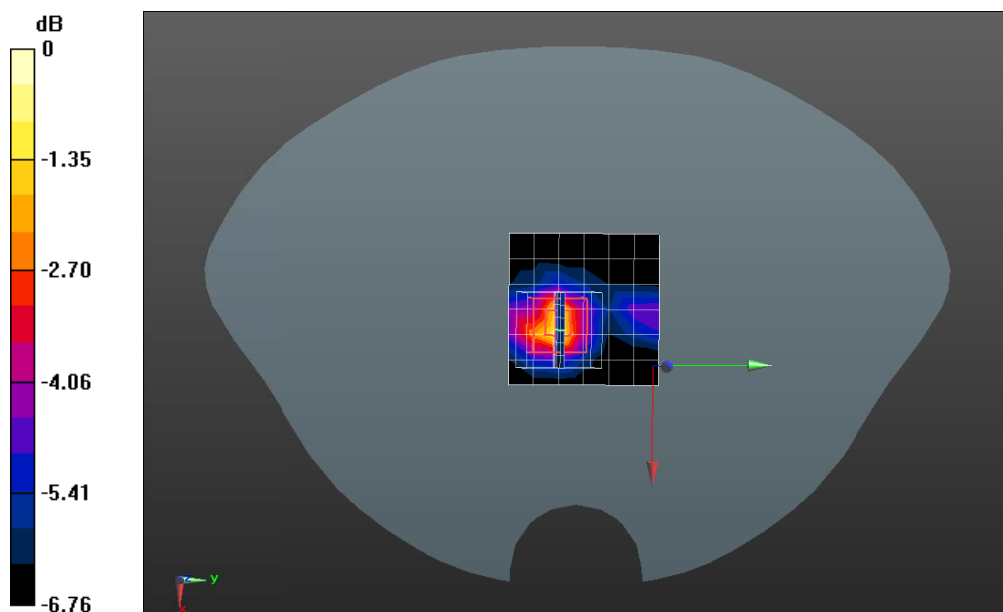

0 dB = 0.816 W/kg = -0.88 dBW/kg

Test Laboratory: DEKRA Lab

802.11a 5300MHz Body-Vertical Front

DUT: AC450 Wireless Nano USB Adapter; Type: Archer T1U

Communication System: UID 0, CW (0); Communication System Band: 5GHz(5000.0-6000.0MHz); Duty Cycle: 1:1.0; Frequency: 5300 MHz; Medium parameters used: $f = 5300$ MHz; $\sigma = 5.47$ S/m; $\epsilon_r = 49.06$; $\rho = 1000$ kg/m³ ; Phantom section: Flat Section

Ambient temperature (°C): 21.5, Liquid temperature (°C): 21.0

DASY5 Configuration:

- Probe: EX3DV4 - SN3710; ConvF(4.51, 4.51, 4.51); Calibrated: 23/02/2017;
- Sensor-Surface: 4mm (Mechanical Surface Detection)
- Electronics: DAE4 Sn1220; Calibrated: 21/02/2017
- Phantom: SAM2; Type: SAM; Serial: TP1562
- Measurement SW: DASY52, Version 52.8 (8); SEMCAD X Version 14.6.10 (7331)

Configuration/802.11a 5300MHz Body-Vertical Front/Area Scan (7x7x1): Measurement grid: dx=10mm, dy=10mm

Maximum value of SAR (measured) = 0.983 W/kg

Configuration/802.11a 5300MHz Body-Vertical Front/Zoom Scan (7x7x6)/Cube 0: Measurement grid:

dx=5mm, dy=5mm, dz=2mm; Reference Value = 11.40 V/m; Power Drift = -0.12 dB

Peak SAR (extrapolated) = 3.86 W/kg

SAR(1 g) = 1.01 W/kg; SAR(10 g) = 0.429 W/kg Maximum value of SAR (measured) = 0.990 W/kg

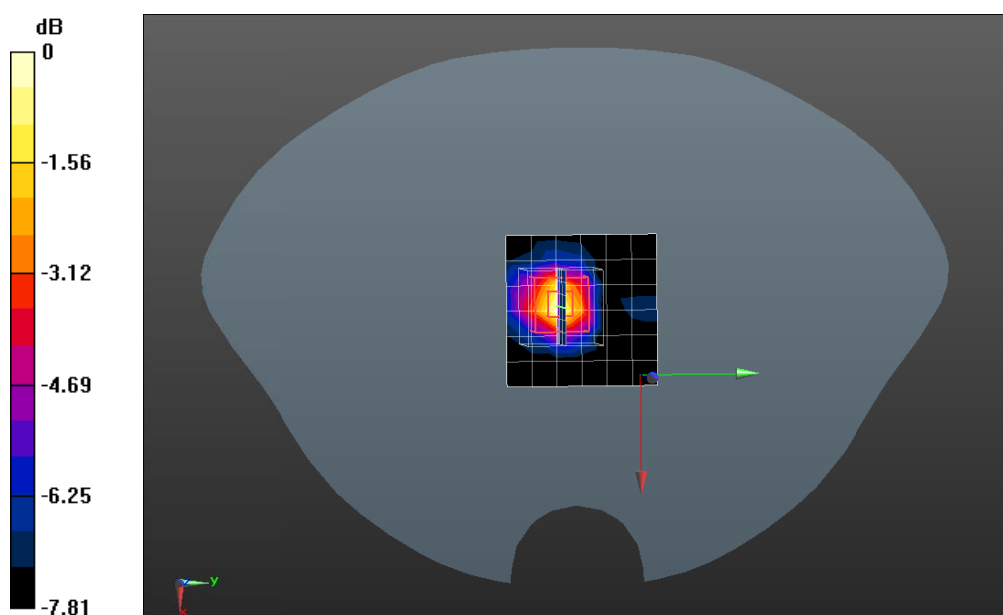

0 dB = 0.990 W/kg = -0.04 dBW/kg

Test Laboratory: DEKRA Lab

802.11a 5260MHz Body-Horizontal Down

DUT: AC450 Wireless Nano USB Adapter; Type: Archer T1U

Communication System: UID 0, CW (0); Communication System Band: 5GHz(5000.0-6000.0MHz); Duty Cycle: 1:1.0; Frequency: 5260 MHz; Medium parameters used: $f = 5260$ MHz; $\sigma = 5.42$ S/m; $\epsilon_r = 49.16$; $\rho = 1000$ kg/m³ ; Phantom section: Flat Section

Ambient temperature (°C): 21.5, Liquid temperature (°C): 21.0

DASY5 Configuration:

- Probe: EX3DV4 - SN3710; ConvF(4.51, 4.51, 4.51); Calibrated: 23/02/2017;
- Sensor-Surface: 4mm (Mechanical Surface Detection)
- Electronics: DAE4 Sn1220; Calibrated: 21/02/2017
- Phantom: SAM2; Type: SAM; Serial: TP1562
- Measurement SW: DASY52, Version 52.8 (8); SEMCAD X Version 14.6.10 (7331)

Configuration/802.11a 5260MHz Body-Horizontal Down/Area Scan (7x7x1): Measurement grid:

dx=10mm, dy=10mm

Maximum value of SAR (measured) = 0.705 W/kg

Configuration/802.11a 5260MHz Body-Horizontal Down/Zoom Scan (7x7x6)/Cube 0: Measurement grid:

dx=5mm, dy=5mm, dz=2mm; Reference Value = 9.152 V/m; Power Drift = 0.01 dB

Peak SAR (extrapolated) = 3.05 W/kg

SAR(1 g) = 0.855 W/kg; SAR(10 g) = 0.378 W/kg Maximum value of SAR (measured) = 0.843 W/kg

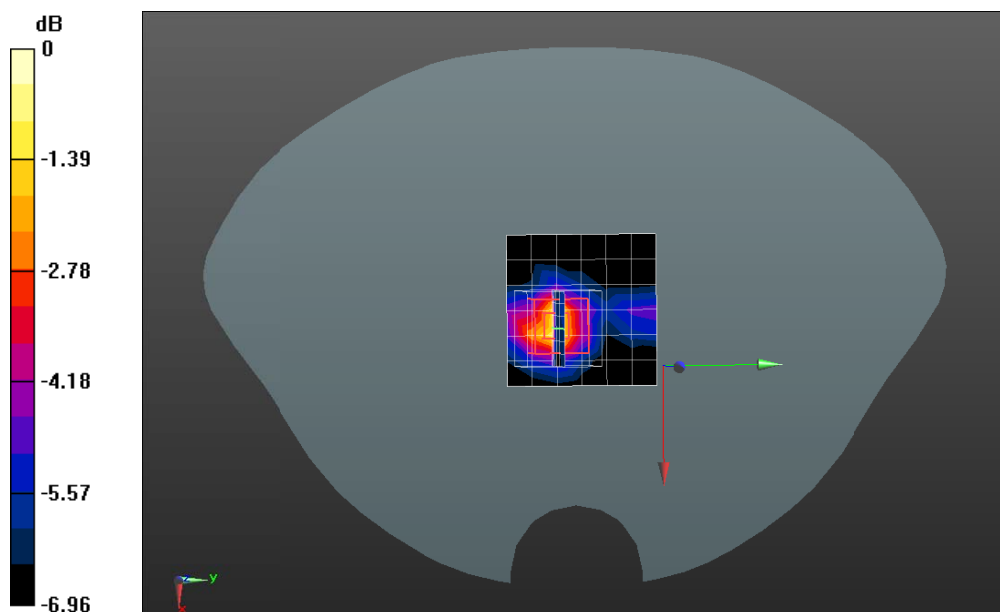

0 dB = 0.843 W/kg = -0.74 dBW/kg

Test Laboratory: DEKRA Lab

802.11a 5260MHz Body-Vertical Front

DUT: AC450 Wireless Nano USB Adapter; Type: Archer T1U

Communication System: UID 0, CW (0); Communication System Band: 5GHz(5000.0-6000.0MHz); Duty Cycle: 1:1.0; Frequency: 5260 MHz; Medium parameters used: $f = 5260$ MHz; $\sigma = 5.42$ S/m; $\epsilon_r = 49.16$; $\rho = 1000$ kg/m³ ; Phantom section: Flat Section

Ambient temperature (°C): 21.5, Liquid temperature (°C): 21.0

DASY5 Configuration:

- Probe: EX3DV4 - SN3710; ConvF(4.51, 4.51, 4.51); Calibrated: 23/02/2017;
- Sensor-Surface: 4mm (Mechanical Surface Detection)
- Electronics: DAE4 Sn1220; Calibrated: 21/02/2017
- Phantom: SAM2; Type: SAM; Serial: TP1562
- Measurement SW: DASY52, Version 52.8 (8); SEMCAD X Version 14.6.10 (7331)

Configuration/802.11a 5260MHz Body-Vertical Front/Area Scan (7x7x1): Measurement grid: dx=10mm, dy=10mm

Maximum value of SAR (measured) = 0.926 W/kg

Configuration/802.11a 5260MHz Body-Vertical Front/Zoom Scan (7x7x6)/Cube 0: Measurement grid: dx=5mm, dy=5mm, dz=2mm; Reference Value = 10.97 V/m; Power Drift = 0.01 dB

Peak SAR (extrapolated) = 3.60 W/kg

SAR(1 g) = 1.02 W/kg; SAR(10 g) = 0.424 W/kg Maximum value of SAR (measured) = 1.04 W/kg

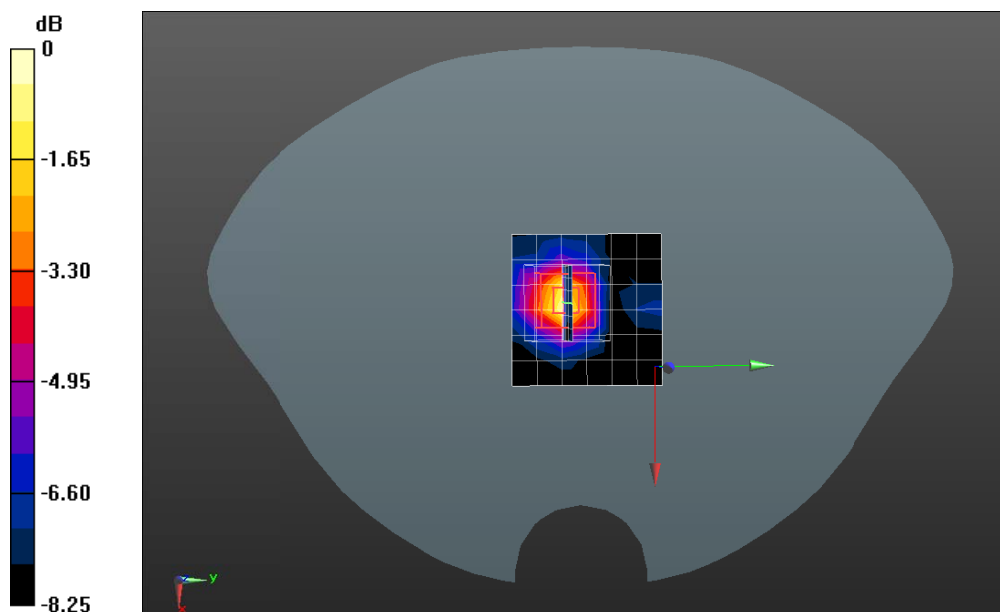

Test Laboratory: DEKRA Lab

802.11a 5260MHz Body-Vertical Front*

DUT: AC450 Wireless Nano USB Adapter; Type: Archer T1U

Communication System: UID 0, CW (0); Communication System Band: 5GHz(5000.0-6000.0MHz); Duty Cycle: 1:1.0; Frequency: 5260 MHz; Medium parameters used: $f = 5260$ MHz; $\sigma = 5.42$ S/m; $\epsilon_r = 49.16$; $\rho = 1000$ kg/m³ ; Phantom section: Flat Section

Ambient temperature (°C): 21.5, Liquid temperature (°C): 21.0

DASY5 Configuration:

- Probe: EX3DV4 - SN3710; ConvF(4.51, 4.51, 4.51); Calibrated: 23/02/2017;
- Sensor-Surface: 4mm (Mechanical Surface Detection)
- Electronics: DAE4 Sn1220; Calibrated: 21/02/2017
- Phantom: SAM2; Type: SAM; Serial: TP1562
- Measurement SW: DASY52, Version 52.8 (8); SEMCAD X Version 14.6.10 (7331)

Configuration/802.11a 5260MHz Body-Vertical Front/Area Scan (7x7x1): Measurement grid: dx=10mm, dy=10mm

Maximum value of SAR (measured) = 0.766 W/kg

Configuration/802.11a 5260MHz Body-Vertical Front/Zoom Scan (7x7x6)/Cube 0: Measurement grid:

dx=5mm, dy=5mm, dz=2mm; Reference Value = 11.45 V/m; Power Drift = -0.08 dB

Peak SAR (extrapolated) = 3.49 W/kg

SAR(1 g) = 0.953 W/kg; SAR(10 g) = 0.410 W/kg Maximum value of SAR (measured) = 0.947 W/kg

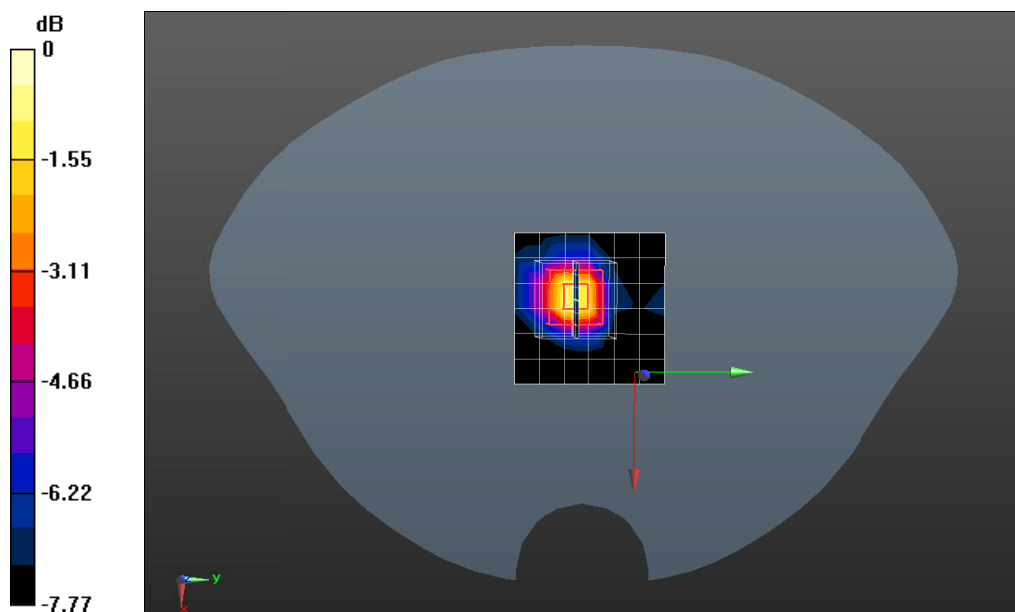

0 dB = 0.947 W/kg = -0.24 dBW/kg

Date/Time: 06-21-2017

Test Laboratory: DEKRA Lab

802.11a 5580MHz Body-Horizontal Up

DUT: AC450 Wireless Nano USB Adapter; Type: Archer T1U

Communication System: UID 0, CW (0); Communication System Band: 5GHz(5000.0-6000.0MHz); Duty Cycle: 1:1.0; Frequency: 5580 MHz; Medium parameters used: $f = 5580$ MHz; $\sigma = 5.85$ S/m; $\epsilon_r = 48.2$; $\rho = 1000$ kg/m³ ; Phantom section: Flat Section

Ambient temperature (°C): 21.5, Liquid temperature (°C): 21.0

DASY5 Configuration:

- Probe: EX3DV4 - SN3710; ConvF(4.01, 4.01, 4.01); Calibrated: 23/02/2017;
- Sensor-Surface: 4mm (Mechanical Surface Detection)
- Electronics: DAE4 Sn1220; Calibrated: 21/02/2017
- Phantom: SAM2; Type: SAM; Serial: TP1562
- Measurement SW: DASY52, Version 52.8 (8); SEMCAD X Version 14.6.10 (7331)

Configuration/802.11a 5580MHz Body-Horizontal Up/Area Scan (7x7x1): Measurement grid: dx=10mm, dy=10mm

Maximum value of SAR (measured) = 0.343 W/kg

Configuration/802.11a 5580MHz Body-Horizontal Up/Zoom Scan (7x7x6)/Cube 0: Measurement grid:

dx=5mm, dy=5mm, dz=2mm; Reference Value = 7.893 V/m; Power Drift = -0.13 dB

Peak SAR (extrapolated) = 0.586 W/kg

SAR(1 g) = 0.344 W/kg; SAR(10 g) = 0.263 W/kg Maximum value of SAR (measured) = 0.382 W/kg

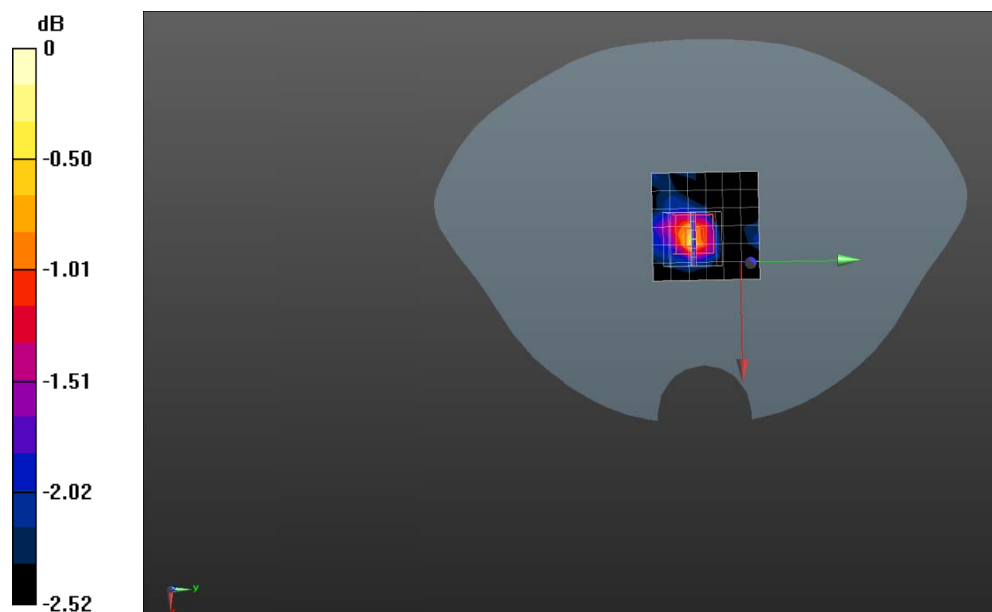

0 dB = 0.382 W/kg = -4.18 dBW/kg

Test Laboratory: DEKRA Lab

802.11a 5580MHz Body-Horizontal Down

DUT: AC450 Wireless Nano USB Adapter; Type: Archer T1U

Communication System: UID 0, CW (0); Communication System Band: 5GHz(5000.0-6000.0MHz); Duty Cycle: 1:1.0; Frequency: 5580 MHz; Medium parameters used: $f = 5580$ MHz; $\sigma = 5.85$ S/m; $\epsilon_r = 48.2$; $\rho = 1000$ kg/m³ ; Phantom section: Flat Section

Ambient temperature (°C): 21.5, Liquid temperature (°C): 21.0

DASY5 Configuration:

- Probe: EX3DV4 - SN3710; ConvF(4.01, 4.01, 4.01); Calibrated: 23/02/2017;
- Sensor-Surface: 4mm (Mechanical Surface Detection)
- Electronics: DAE4 Sn1220; Calibrated: 21/02/2017
- Phantom: SAM2; Type: SAM; Serial: TP1562
- Measurement SW: DASY52, Version 52.8 (8); SEMCAD X Version 14.6.10 (7331)

Configuration/802.11a 5580MHz Body-Horizontal Down/Area Scan (7x7x1): Measurement grid:

dx=10mm, dy=10mm

Maximum value of SAR (measured) = 0.532 W/kg

Configuration/802.11a 5580MHz Body-Horizontal Down/Zoom Scan (7x7x6)/Cube 0: Measurement grid:

dx=5mm, dy=5mm, dz=2mm, Reference Value = 8.448 V/m; Power Drift = 0.12 dB

Peak SAR (extrapolated) = 1.37 W/kg

SAR(1 g) = 0.534 W/kg; SAR(10 g) = 0.275 W/kg Maximum value of SAR (measured) = 0.594 W/kg

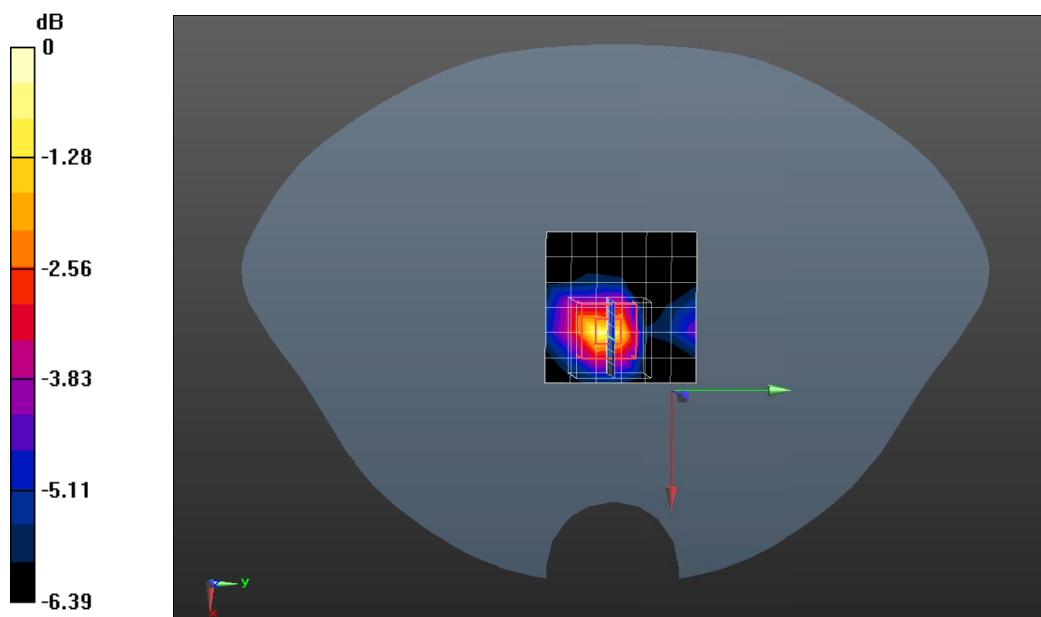

0 dB = 0.594 W/kg = -2.26 dBW/kg

Test Laboratory: DEKRA Lab

802.11a 5580MHz Body-Vertical Front

DUT: AC450 Wireless Nano USB Adapter; Type: Archer T1U

Communication System: UID 0, CW (0); Communication System Band: 5GHz(5000.0-6000.0MHz); Duty Cycle: 1:1.0; Frequency: 5580 MHz; Medium parameters used: $f = 5580$ MHz; $\sigma = 5.85$ S/m; $\epsilon_r = 48.2$; $\rho = 1000$ kg/m³ ; Phantom section: Flat Section

Ambient temperature (°C): 21.5, Liquid temperature (°C): 21.0

DASY5 Configuration:

- Probe: EX3DV4 - SN3710; ConvF(4.01, 4.01, 4.01); Calibrated: 23/02/2017;
- Sensor-Surface: 4mm (Mechanical Surface Detection)
- Electronics: DAE4 Sn1220; Calibrated: 21/02/2017
- Phantom: SAM2; Type: SAM; Serial: TP1562
- Measurement SW: DASY52, Version 52.8 (8); SEMCAD X Version 14.6.10 (7331)

Configuration/802.11a 5580MHz Body-Vertical Front/Area Scan (7x7x1): Measurement grid: dx=10mm, dy=10mm

Maximum value of SAR (measured) = 0.932 W/kg

Configuration/802.11a 5580MHz Body-Vertical Front/Zoom Scan (7x7x6)/Cube 0: Measurement grid: dx=5mm, dy=5mm, dz=2mm, Reference Value = 10.82 V/m; Power Drift = 0.07 dB

Peak SAR (extrapolated) = 1.67 W/kg

SAR(1 g) = 0.653 W/kg; SAR(10 g) = 0.294 W/kg Maximum value of SAR (measured) = 0.812 W/kg

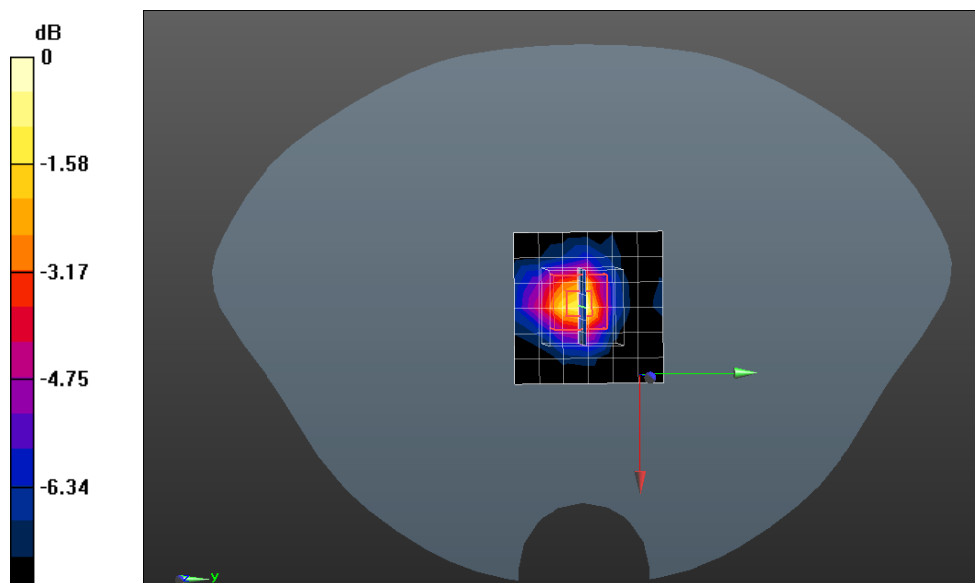

0 dB = 0.812 W/kg = -0.90 dBW/kg

Date/Time: 06-21-2017

Test Laboratory: DEKRA Lab

802.11a 5500MHz Body-Horizontal Down

DUT: AC450 Wireless Nano USB Adapter; Type: Archer T1U

Communication System: UID 0, CW (0); Communication System Band: 5GHz(5000.0-6000.0MHz); Duty Cycle: 1:1.0; Frequency: 5500 MHz; Medium parameters used: $f = 5500$ MHz; $\sigma = 5.7$ S/m; $\epsilon_r = 48.44$; $\rho = 1000$ kg/m³ ; Phantom section: Flat Section

Ambient temperature (°C): 21.5, Liquid temperature (°C): 21.0

DASY5 Configuration:

- Probe: EX3DV4 - SN3710; ConvF(4.01, 4.01, 4.01); Calibrated: 23/02/2017;
- Sensor-Surface: 4mm (Mechanical Surface Detection)
- Electronics: DAE4 Sn1220; Calibrated: 21/02/2017
- Phantom: SAM2; Type: SAM; Serial: TP1562
- Measurement SW: DASY52, Version 52.8 (8); SEMCAD X Version 14.6.10 (7331)

Configuration/802.11a 5500MHz Body-Horizontal Down/Area Scan (7x7x1): Measurement grid:

dx=10mm, dy=10mm

Maximum value of SAR (measured) = 0.473 W/kg

Configuration/802.11a 5500MHz Body-Horizontal Down/Zoom Scan (7x7x6)/Cube 0: Measurement grid:

dx=5mm, dy=5mm, dz=2mm; Reference Value = 9.361 V/m; Power Drift = 0.17 dB

Peak SAR (extrapolated) = 0.985 W/kg

SAR(1 g) = 0.439 W/kg; SAR(10 g) = 0.268 W/kg Maximum value of SAR (measured) = 0.491 W/kg

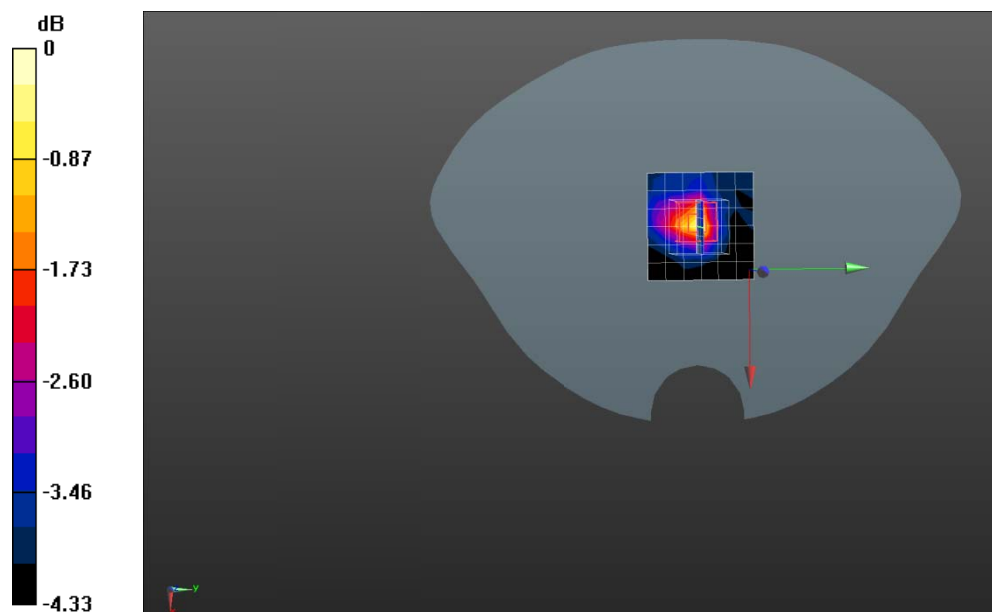

0 dB = 0.491 W/kg = -3.09 dBW/kg

Test Laboratory: DEKRA Lab

802.11a 5500MHz Body-Vertical Front

DUT: AC450 Wireless Nano USB Adapter; Type: Archer T1U

Communication System: UID 0, CW (0); Communication System Band: 5GHz(5000.0-6000.0MHz); Duty Cycle: 1:1.0; Frequency: 5500 MHz; Medium parameters used: $f = 5500$ MHz; $\sigma = 5.7$ S/m; $\epsilon_r = 48.44$; $\rho = 1000$ kg/m³ ; Phantom section: Flat Section

Ambient temperature (°C): 21.5, Liquid temperature (°C): 21.0

DASY5 Configuration:

- Probe: EX3DV4 - SN3710; ConvF(4.01, 4.01, 4.01); Calibrated: 23/02/2017;
- Sensor-Surface: 4mm (Mechanical Surface Detection)
- Electronics: DAE4 Sn1220; Calibrated: 21/02/2017
- Phantom: SAM2; Type: SAM; Serial: TP1562
- Measurement SW: DASY52, Version 52.8 (8); SEMCAD X Version 14.6.10 (7331)

Configuration/802.11a 5500MHz Body-Vertical Front/Area Scan (7x7x1): Measurement grid: dx=10mm, dy=10mm

Maximum value of SAR (measured) = 0.506 W/kg

Configuration/802.11a 5500MHz Body-Vertical Front/Zoom Scan (7x7x6)/Cube 0: Measurement grid: dx=5mm, dy=5mm, dz=2mm; Reference Value = 7.398 V/m; Power Drift = 0.10 dB

Peak SAR (extrapolated) = 2.88 W/kg

SAR(1 g) = 0.588 W/kg; SAR(10 g) = 0.278 W/kg Maximum value of SAR (measured) = 0.646 W/kg

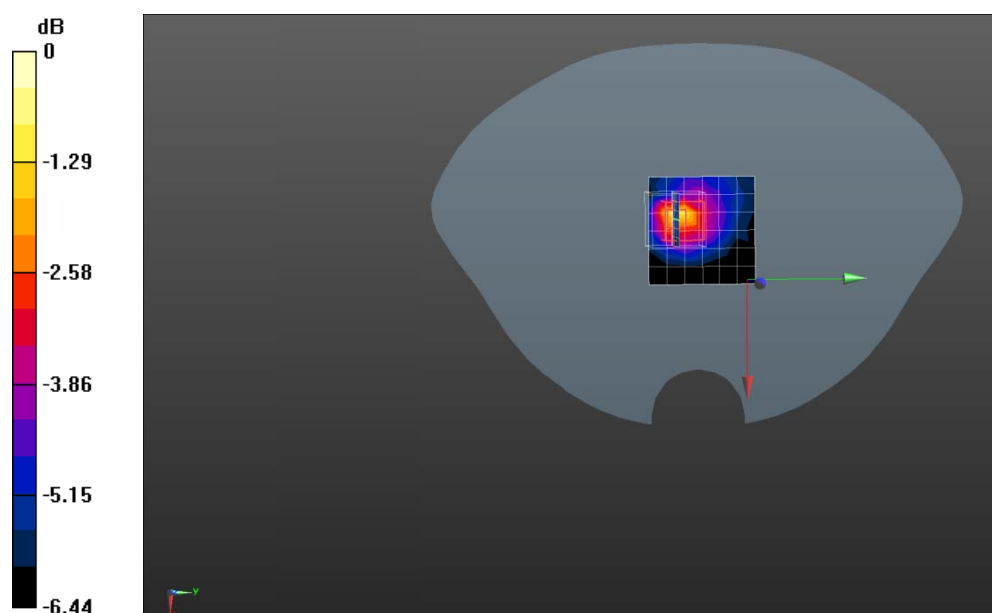

0 dB = 0.646 W/kg = -1.90 dBW/kg

Test Laboratory: DEKRA Lab

802.11a 5785MHz Body-Horizontal Up

DUT: AC450 Wireless Nano USB Adapter; Type: Archer T1U

Communication System: UID 0, CW (0); Communication System Band: 5GHz(5000.0-6000.0MHz); Duty Cycle: 1:1.0; Frequency: 5785 MHz; Medium parameters used: $f = 5785$ MHz; $\sigma = 6.14$ S/m; $\epsilon_r = 47.72$; $\rho = 1000$ kg/m³ ; Phantom section: Flat Section

Ambient temperature (°C): 21.5, Liquid temperature (°C): 21.0

DASY5 Configuration:

- Probe: EX3DV4 - SN3710; ConvF(4.09, 4.09, 4.09); Calibrated: 23/02/2017;
- Sensor-Surface: 4mm (Mechanical Surface Detection)
- Electronics: DAE4 Sn1220; Calibrated: 21/02/2017
- Phantom: SAM2; Type: SAM; Serial: TP1562
- Measurement SW: DASY52, Version 52.8 (8); SEMCAD X Version 14.6.10 (7331)

Configuration/802.11a 5785MHz Body-Horizontal Up/Area Scan (7x7x1): Measurement grid: dx=10mm, dy=10mm

Maximum value of SAR (measured) = 0.394 W/kg

Configuration/802.11a 5785MHz Body-Horizontal Up/Zoom Scan (7x7x6)/Cube 0: Measurement grid: dx=5mm, dy=5mm, dz=2mm; Reference Value = 8.186 V/m; Power Drift = -0.01 dB

Peak SAR (extrapolated) = 0.692 W/kg

SAR(1 g) = 0.390 W/kg; SAR(10 g) = 0.291 W/kg Maximum value of SAR (measured) = 0.419 W/kg

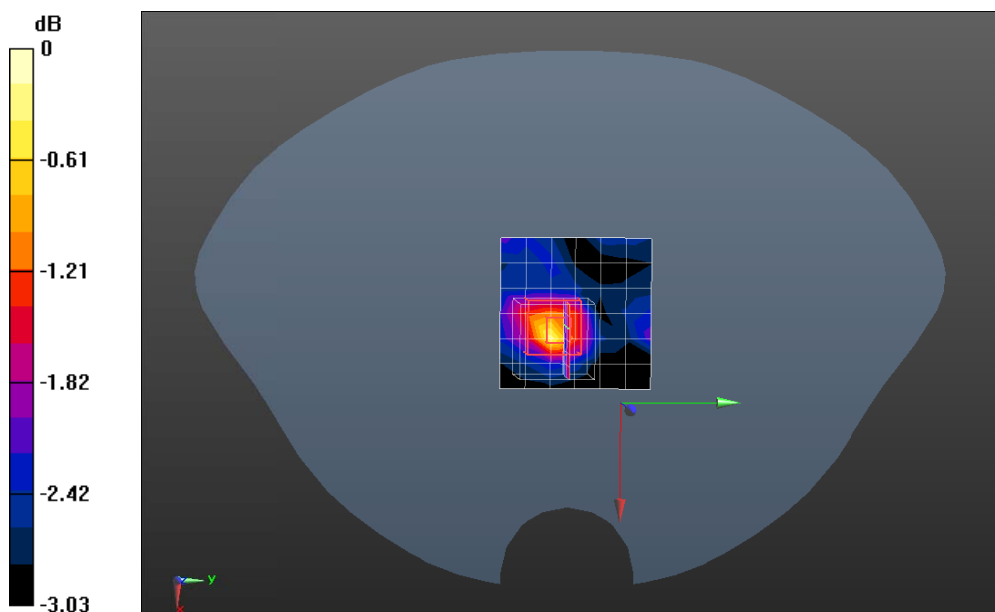

0 dB = 0.419 W/kg = -3.78 dBW/kg

Test Laboratory: DEKRA Lab

802.11a 5785MHz Body-Horizontal Down

DUT: AC450 Wireless Nano USB Adapter; Type: Archer T1U

Communication System: UID 0, CW (0); Communication System Band: 5GHz(5000.0-6000.0MHz); Duty Cycle: 1:1.0; Frequency: 5785 MHz; Medium parameters used: $f = 5785$ MHz; $\sigma = 6.14$ S/m; $\epsilon_r = 47.72$; $\rho = 1000$ kg/m³ ; Phantom section: Flat Section

Ambient temperature (°C): 21.5, Liquid temperature (°C): 21.0

DASY5 Configuration:

- Probe: EX3DV4 - SN3710; ConvF(4.09, 4.09, 4.09); Calibrated: 23/02/2017;
- Sensor-Surface: 4mm (Mechanical Surface Detection)
- Electronics: DAE4 Sn1220; Calibrated: 21/02/2017
- Phantom: SAM2; Type: SAM; Serial: TP1562
- Measurement SW: DASY52, Version 52.8 (8); SEMCAD X Version 14.6.10 (7331)

Configuration/802.11a 5785MHz Body-Horizontal Down/Area Scan (7x7x1): Measurement grid:

dx=10mm, dy=10mm

Maximum value of SAR (measured) = 0.445 W/kg

Configuration/802.11a 5785MHz Body-Horizontal Down/Zoom Scan (7x7x6)/Cube 0: Measurement grid:

dx=5mm, dy=5mm, dz=2mm; Reference Value = 9.017 V/m; Power Drift = -0.10 dB

Peak SAR (extrapolated) = 0.790 W/kg

SAR(1 g) = 0.434 W/kg; SAR(10 g) = 0.318 W/kg Maximum value of SAR (measured) = 0.480 W/kg

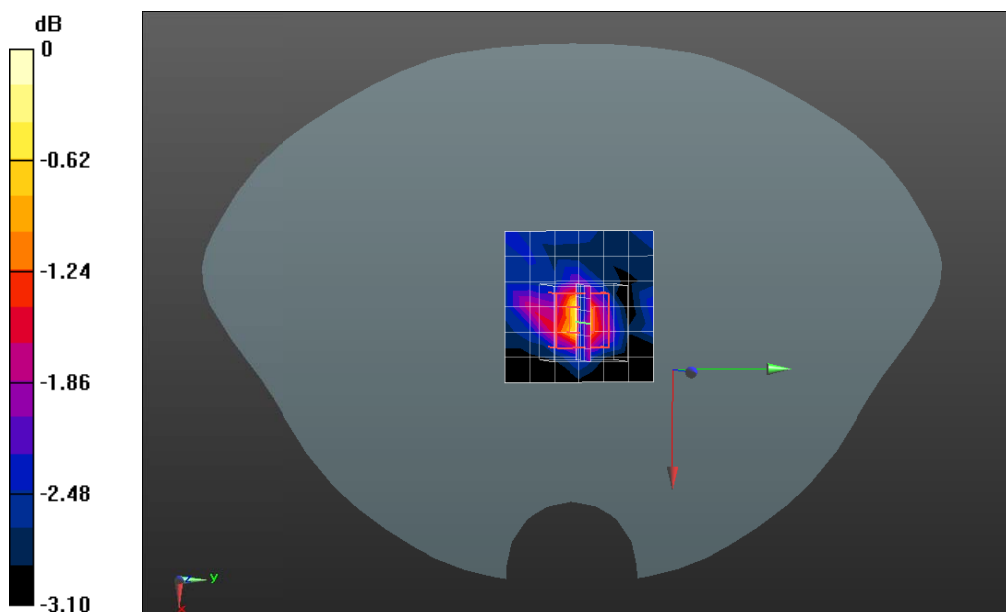

0 dB = 0.480 W/kg = -3.19 dBW/kg

Test Laboratory: DEKRA Lab

802.11a 5785MHz Body-Vertical Front

DUT: AC450 Wireless Nano USB Adapter; Type: Archer T1U

Communication System: UID 0, CW (0); Communication System Band: 5GHz(5000.0-6000.0MHz); Duty Cycle: 1:1.0; Frequency: 5785 MHz; Medium parameters used: $f = 5785$ MHz; $\sigma = 6.14$ S/m; $\epsilon_r = 47.72$; $\rho = 1000$ kg/m³ ; Phantom section: Flat Section

Ambient temperature (°C): 21.5, Liquid temperature (°C): 21.0

DASY5 Configuration:

- Probe: EX3DV4 - SN3710; ConvF(4.09, 4.09, 4.09); Calibrated: 23/02/2017;
- Sensor-Surface: 4mm (Mechanical Surface Detection)
- Electronics: DAE4 Sn1220; Calibrated: 21/02/2017
- Phantom: SAM2; Type: SAM; Serial: TP1562
- Measurement SW: DASY52, Version 52.8 (8); SEMCAD X Version 14.6.10 (7331)

Configuration/802.11a 5785MHz Body-Vertical Front/Area Scan (7x7x1): Measurement grid: dx=10mm, dy=10mm

Maximum value of SAR (measured) = 0.621 W/kg

Configuration/802.11a 5785MHz Body-Vertical Front/Zoom Scan (7x7x6)/Cube 0: Measurement grid: dx=5mm, dy=5mm, dz=2mm; Reference Value = 10.20 V/m; Power Drift = 0.07 dB

Peak SAR (extrapolated) = 1.37 W/kg

SAR(1 g) = 0.580 W/kg; SAR(10 g) = 0.338 W/kg Maximum value of SAR (measured) = 0.655 W/kg

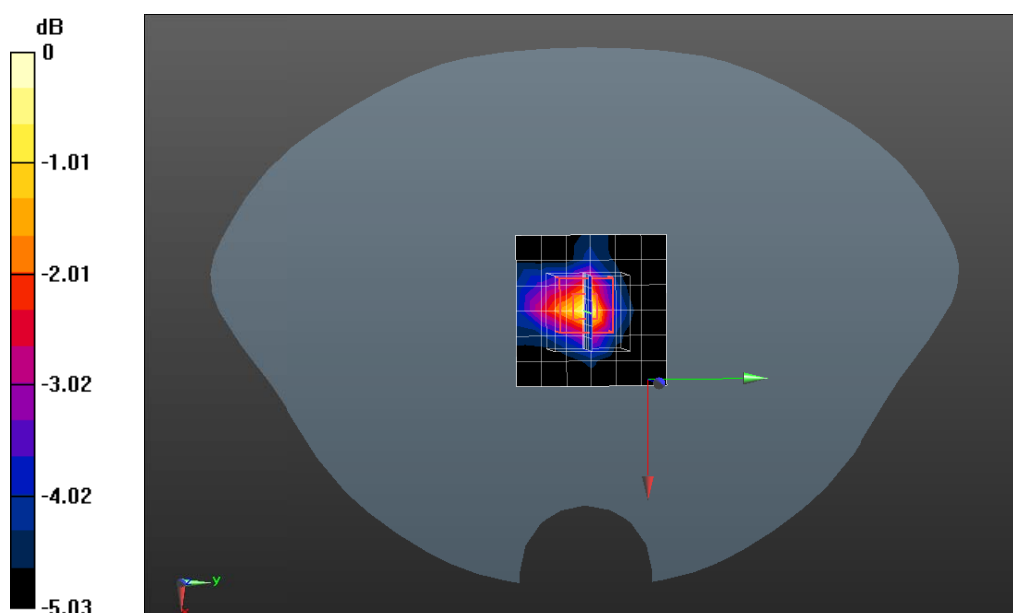

0 dB = 0.655 W/kg = -1.84 dBW/kg

Test Laboratory: DEKRA Lab

802.11a 5825MHz Body-Horizontal Down

DUT: AC450 Wireless Nano USB Adapter; Type: Archer T1U

Communication System: UID 0, CW (0); Communication System Band: 5GHz(5000.0-6000.0MHz); Duty Cycle: 1:1.0; Frequency: 5825 MHz; Medium parameters used: $f = 5825$ MHz; $\sigma = 6.19$ S/m; $\epsilon_r = 47.6$; $\rho = 1000$ kg/m³ ; Phantom section: Flat Section

Ambient temperature (°C): 21.5, Liquid temperature (°C): 21.0

DASY5 Configuration:

- Probe: EX3DV4 - SN3710; ConvF(4.09, 4.09, 4.09); Calibrated: 23/02/2017;
- Sensor-Surface: 4mm (Mechanical Surface Detection)
- Electronics: DAE4 Sn1220; Calibrated: 21/02/2017
- Phantom: SAM2; Type: SAM; Serial: TP1562
- Measurement SW: DASY52, Version 52.8 (8); SEMCAD X Version 14.6.10 (7331)

Configuration/802.11a 5825MHz Body-Horizontal Down/Area Scan (7x7x1): Measurement grid:

dx=10mm, dy=10mm

Maximum value of SAR (measured) = 0.387 W/kg

Configuration/802.11a 5825MHz Body-Horizontal Down/Zoom Scan (7x7x6)/Cube 0: Measurement grid:

dx=5mm, dy=5mm, dz=2mm; Reference Value = 8.013 V/m; Power Drift = 0.06 dB

Peak SAR (extrapolated) = 0.696 W/kg

SAR(1 g) = 0.377 W/kg; SAR(10 g) = 0.280 W/kg Maximum value of SAR (measured) = 0.404 W/kg

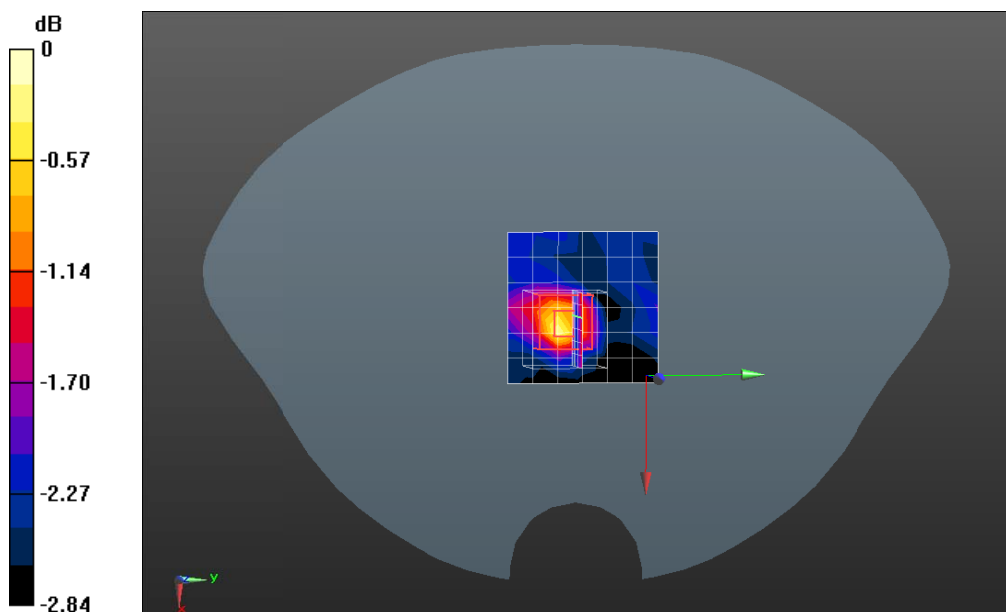

0 dB = 0.404 W/kg = -3.94 dBW/kg

Test Laboratory: DEKRA Lab

802.11a 5825MHz Body-Vertical Front

DUT: AC450 Wireless Nano USB Adapter; Type: Archer T1U

Communication System: UID 0, CW (0); Communication System Band: 5GHz(5000.0-6000.0MHz); Duty Cycle: 1:1.0; Frequency: 5825 MHz; Medium parameters used: $f = 5825$ MHz; $\sigma = 6.19$ S/m; $\epsilon_r = 47.6$; $\rho = 1000$ kg/m³ ; Phantom section: Flat Section

Ambient temperature (°C): 21.5, Liquid temperature (°C): 21.0

DASY5 Configuration:

- Probe: EX3DV4 - SN3710; ConvF(4.09, 4.09, 4.09); Calibrated: 23/02/2017;
- Sensor-Surface: 4mm (Mechanical Surface Detection)
- Electronics: DAE4 Sn1220; Calibrated: 21/02/2017
- Phantom: SAM2; Type: SAM; Serial: TP1562
- Measurement SW: DASY52, Version 52.8 (8); SEMCAD X Version 14.6.10 (7331)

Configuration/802.11a 5825MHz Body-Vertical Front/Area Scan (7x7x1): Measurement grid: dx=10mm, dy=10mm

Maximum value of SAR (measured) = 0.533 W/kg

Configuration/802.11a 5825MHz Body-Vertical Front/Zoom Scan (7x7x6)/Cube 0: Measurement grid: dx=5mm, dy=5mm, dz=2mm; Reference Value = 9.539 V/m; Power Drift = 0.17 dB

Peak SAR (extrapolated) = 1.11 W/kg

SAR(1 g) = 0.495 W/kg; SAR(10 g) = 0.302 W/kg Maximum value of SAR (measured) = 0.553 W/kg

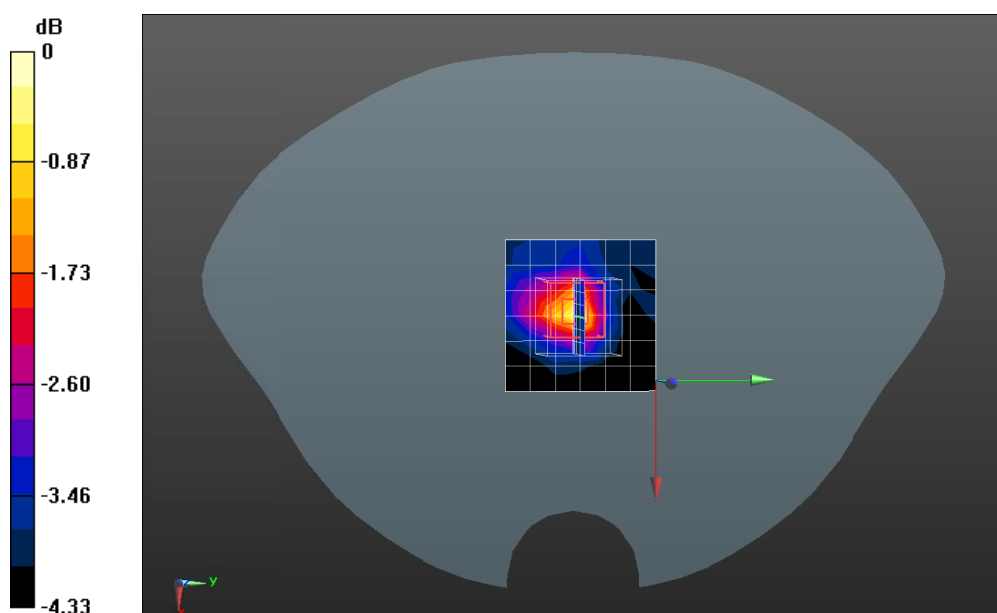

0 dB = 0.553 W/kg = -2.57 dBW/kg

Appendix C. Probe Calibration Data

Calibration Laboratory of
Schmid & Partner
Engineering AG
Zeughausstrasse 43, 8004 Zurich, Switzerland



S Schweizerischer Kalibrierdienst
S Service suisse d'étalonnage
S Servizio svizzero di taratura
S Swiss Calibration Service

Accredited by the Swiss Accreditation Service (SAS)
The Swiss Accreditation Service is one of the signatories to the EA
Multilateral Agreement for the recognition of calibration certificates

Accreditation No.: SCS 0108

Client **QTK-CN (Auden)**

Certificate No: **EX3-3710_Feb17**

CALIBRATION CERTIFICATE

Object: EX3DV4 - SN:3710

Calibration procedure(s): QA CAL-01.v9, QA CAL-12.v9, QA CAL-14.v4, QA CAL-23.v5, QA CAL-25.v6
Calibration procedure for dosimetric E-field probes

Calibration date: February 23, 2017

This calibration certificate documents the traceability to national standards, which realize the physical units of measurements (SI). The measurements and the uncertainties with confidence probability are given on the following pages and are part of the certificate.

All calibrations have been conducted in the closed laboratory facility: environment temperature (22 ± 3)°C and humidity < 70%.

Calibration Equipment used (M&TE critical for calibration)

Primary Standards	ID	Cal Date (Certificate No.)	Scheduled Calibration
Power meter NRP	SN: 104778	08-Apr-16 (No. 217-02288/02289)	Apr-17
Power sensor NRP-Z91	SN: 103244	06-Apr-16 (No. 217-02288)	Apr-17
Power sensor NRP-Z91	SN: 103245	06-Apr-16 (No. 217-02289)	Apr-17
Reference 20 dB Attenuator	SN: S5277 (20x)	05-Apr-16 (No. 217-02293)	Apr-17
Reference Probe ES3DV2	SN: 3013	31-Dec-16 (No. ES3-3013_Dec16)	Dec-17
DAE4	SN: 660	7-Dec-16 (No. DAE4-660_Dec16)	Dec-17
Secondary Standards	ID	Check Date (in house)	Scheduled Check
Power meter E4419B	SN: GB41293874	06-Apr-16 (in house check Jun-16)	In house check: Jun-18
Power sensor E4412A	SN: MY41498087	06-Apr-16 (in house check Jun-16)	In house check: Jun-18
Power sensor E4412A	SN: 000110210	06-Apr-16 (in house check Jun-16)	In house check: Jun-18
RF generator HP 8648C	SN: US3642U01700	04-Aug-99 (in house check Jun-16)	In house check: Jun-18
Network Analyzer HP 8753E	SN: US37390585	18-Oct-01 (in house check Oct-16)	In house check: Oct-17

Calibrated by: **Claudio Leubler** (Name), **Laboratory Technician** (Function), *[Signature]* (Signature)

Approved by: **Katja Pokovic** (Name), **Technical Manager** (Function), *[Signature]* (Signature)

Issued: February 27, 2017

This calibration certificate shall not be reproduced except in full without written approval of the laboratory.

Calibration Laboratory of
Schmid & Partner
Engineering AG
Zeughausstrasse 43, 8004 Zurich, Switzerland



S Schweizerischer Kalibrierdienst
S Service suisse d'étalonnage
S Servizio svizzero di taratura
S Swiss Calibration Service

Accredited by the Swiss Accreditation Service (SAS)

Accreditation No.: SCS 0108

The Swiss Accreditation Service is one of the signatories to the EA
Multilateral Agreement for the recognition of calibration certificates

Glossary:

TSL	tissue simulating liquid
NORM _{x,y,z}	sensitivity in free space
ConvF	sensitivity in TSL / NORM _{x,y,z}
DCP	diode compression point
CF	crest factor (1/duty_cycle) of the RF signal
A, B, C, D	modulation dependent linearization parameters
Polarization φ	φ rotation around probe axis
Polarization θ	θ rotation around an axis that is in the plane normal to probe axis (at measurement center), i.e., $\theta = 0$ is normal to probe axis
Connector Angle	information used in DASY system to align probe sensor X to the robot coordinate system

Calibration is Performed According to the Following Standards:

- a) IEEE Std 1528-2013, "IEEE Recommended Practice for Determining the Peak Spatial-Averaged Specific Absorption Rate (SAR) in the Human Head from Wireless Communications Devices: Measurement Techniques", June 2013
- b) IEC 62209-1, "Procedure to measure the Specific Absorption Rate (SAR) for hand-held devices used in close proximity to the ear (frequency range of 300 MHz to 3 GHz)", February 2005
- c) IEC 62209-2, "Procedure to determine the Specific Absorption Rate (SAR) for wireless communication devices used in close proximity to the human body (frequency range of 30 MHz to 6 GHz)", March 2010
- d) KDB 865664, "SAR Measurement Requirements for 100 MHz to 6 GHz"

Methods Applied and Interpretation of Parameters:

- **NORM_{x,y,z}**: Assessed for E-field polarization $\theta = 0$ ($f \leq 900$ MHz in TEM-cell; $f > 1800$ MHz: R22 waveguide). NORM_{x,y,z} are only intermediate values, i.e., the uncertainties of NORM_{x,y,z} does not affect the E²-field uncertainty inside TSL (see below ConvF).
- **NORM(f)_{x,y,z} = NORM_{x,y,z} * frequency_response** (see Frequency Response Chart). This linearization is implemented in DASY4 software versions later than 4.2. The uncertainty of the frequency response is included in the stated uncertainty of ConvF.
- **DCP_{x,y,z}**: DCP are numerical linearization parameters assessed based on the data of power sweep with CW signal (no uncertainty required). DCP does not depend on frequency nor media.
- **PAR**: PAR is the Peak to Average Ratio that is not calibrated but determined based on the signal characteristics
- **A_{x,y,z}; B_{x,y,z}; C_{x,y,z}; D_{x,y,z}; VR_{x,y,z}**: A, B, C, D are numerical linearization parameters assessed based on the data of power sweep for specific modulation signal. The parameters do not depend on frequency nor media. VR is the maximum calibration range expressed in RMS voltage across the diode.
- **ConvF and Boundary Effect Parameters**: Assessed in flat phantom using E-field (or Temperature Transfer Standard for $f \leq 800$ MHz) and inside waveguide using analytical field distributions based on power measurements for $f > 800$ MHz. The same setups are used for assessment of the parameters applied for boundary compensation (alpha, depth) of which typical uncertainty values are given. These parameters are used in DASY4 software to improve probe accuracy close to the boundary. The sensitivity in TSL corresponds to NORM_{x,y,z} * ConvF whereby the uncertainty corresponds to that given for ConvF. A frequency dependent ConvF is used in DASY version 4.4 and higher which allows extending the validity from ± 50 MHz to ± 100 MHz.
- **Spherical isotropy (3D deviation from isotropy)**: in a field of low gradients realized using a flat phantom exposed by a patch antenna.
- **Sensor Offset**: The sensor offset corresponds to the offset of virtual measurement center from the probe tip (on probe axis). No tolerance required.
- **Connector Angle**: The angle is assessed using the information gained by determining the NORM_x (no uncertainty required).

EX3DV4 – SN:3710

February 23, 2017

Probe EX3DV4

SN:3710

Manufactured: July 21, 2009
Calibrated: February 23, 2017

Calibrated for DASY/EASY Systems
(Note: non-compatible with DASY2 system!)

EX3DV4- SN:3710

February 23, 2017

DASY/EASY - Parameters of Probe: EX3DV4 - SN:3710

Basic Calibration Parameters

	Sensor X	Sensor Y	Sensor Z	Unc (k=2)
Norm ($\mu\text{V}/(\text{V}/\text{m})^2$) ^A	0.39	0.38	0.47	± 10.1 %
DCP (mV) ^B	97.1	102.0	98.7	

Modulation Calibration Parameters

UID	Communication System Name		A dB	B dB $\sqrt{\mu\text{V}}$	C	D dB	VR mV	Unc ^E (k=2)
0	CW	X	0.0	0.0	1.0	0.00	151.5	±3.0 %
		Y	0.0	0.0	1.0		138.1	
		Z	0.0	0.0	1.0		152.5	

The reported uncertainty of measurement is stated as the standard uncertainty of measurement multiplied by the coverage factor k=2, which for a normal distribution corresponds to a coverage probability of approximately 95%.

^A The uncertainties of Norm X,Y,Z do not affect the E²-field uncertainty inside TSL (see Pages 5 and 6).

^B Numerical linearization parameter: uncertainty not required.

^E Uncertainty is determined using the max. deviation from linear response applying rectangular distribution and is expressed for the square of the field value.

DASY/EASY - Parameters of Probe: EX3DV4 - SN:3710**Calibration Parameter Determined in Head Tissue Simulating Media**

f (MHz) ^C	Relative Permittivity ^F	Conductivity (S/m) ^F	ConvF X	ConvF Y	ConvF Z	Alpha ^G	Depth ^G (mm)	Unc (k=2)
450	43.5	0.87	10.52	10.52	10.52	0.14	1.45	± 13.3 %
750	41.9	0.89	10.13	10.13	10.13	0.57	0.80	± 12.0 %
835	41.5	0.90	9.52	9.52	9.52	0.56	0.80	± 12.0 %
900	41.5	0.97	9.23	9.23	9.23	0.54	0.80	± 12.0 %
1810	40.0	1.40	8.34	8.34	8.34	0.33	0.80	± 12.0 %
1900	40.0	1.40	8.19	8.19	8.19	0.33	0.83	± 12.0 %
2450	39.2	1.80	7.40	7.40	7.40	0.23	1.06	± 12.0 %
2600	39.0	1.96	7.17	7.17	7.17	0.33	0.89	± 12.0 %
3500	37.9	2.91	7.11	7.11	7.11	0.30	1.20	± 13.1 %
5250	35.9	4.71	5.30	5.30	5.30	0.40	1.80	± 13.1 %
5600	35.5	5.07	4.85	4.85	4.85	0.40	1.80	± 13.1 %
5750	35.4	5.22	5.01	5.01	5.01	0.40	1.80	± 13.1 %

^C Frequency validity above 300 MHz of ± 100 MHz only applies for DASY v4.4 and higher (see Page 2), else it is restricted to ± 50 MHz. The uncertainty is the RSS of the ConvF uncertainty at calibration frequency and the uncertainty for the indicated frequency band. Frequency validity below 300 MHz is ± 10, 25, 40, 50 and 70 MHz for ConvF assessments at 30, 64, 128, 150 and 220 MHz respectively. Above 5 GHz frequency validity can be extended to ± 110 MHz.

^F At frequencies below 3 GHz, the validity of tissue parameters (ϵ and σ) can be relaxed to ± 10% if liquid compensation formula is applied to measured SAR values. At frequencies above 3 GHz, the validity of tissue parameters (ϵ and σ) is restricted to ± 5%. The uncertainty is the RSS of the ConvF uncertainty for indicated target tissue parameters.

^G Alpha/Depth are determined during calibration. SPEAG warrants that the remaining deviation due to the boundary effect after compensation is always less than ± 1% for frequencies below 3 GHz and below ± 2% for frequencies between 3-6 GHz at any distance larger than half the probe tip diameter from the boundary.

DASY/EASY - Parameters of Probe: EX3DV4 - SN:3710

Calibration Parameter Determined in Body Tissue Simulating Media

f (MHz) ^C	Relative Permittivity ^F	Conductivity (S/m) ^F	ConvF X	ConvF Y	ConvF Z	Alpha ^G	Depth ^G (mm)	Unc (k=2)
450	56.7	0.94	10.73	10.73	10.73	0.07	1.40	± 13.3 %
750	55.5	0.96	9.67	9.67	9.67	0.33	1.35	± 12.0 %
835	55.2	0.97	9.62	9.62	9.62	0.57	0.86	± 12.0 %
900	55.0	1.05	9.57	9.57	9.57	0.47	0.89	± 12.0 %
1810	53.3	1.52	7.92	7.92	7.92	0.36	0.82	± 12.0 %
1900	53.3	1.52	7.68	7.68	7.68	0.21	1.25	± 12.0 %
2450	52.7	1.95	7.52	7.52	7.52	0.39	0.80	± 12.0 %
2600	52.5	2.16	7.21	7.21	7.21	0.31	0.80	± 12.0 %
3500	51.3	3.31	6.48	6.48	6.48	0.25	1.20	± 13.1 %
5250	48.9	5.36	4.51	4.51	4.51	0.50	1.90	± 13.1 %
5600	48.5	5.77	4.01	4.01	4.01	0.50	1.90	± 13.1 %
5750	48.3	5.94	4.09	4.09	4.09	0.50	1.90	± 13.1 %

^C Frequency validity above 300 MHz of ± 100 MHz only applies for DASY v4.4 and higher (see Page 2), else it is restricted to ± 50 MHz. The uncertainty is the RSS of the ConvF uncertainty at calibration frequency and the uncertainty for the indicated frequency band. Frequency validity below 300 MHz is ± 10 , 25, 40, 50 and 70 MHz for ConvF assessments at 30, 64, 128, 150 and 220 MHz respectively. Above 5 GHz frequency validity can be extended to ± 110 MHz.

^F At frequencies below 3 GHz, the validity of tissue parameters (ϵ and σ) can be relaxed to $\pm 10\%$ if liquid compensation formula is applied to measured SAR values. At frequencies above 3 GHz, the validity of tissue parameters (ϵ and σ) is restricted to $\pm 5\%$. The uncertainty is the RSS of the ConvF uncertainty for indicated target tissue parameters.

^G Alpha/Depth are determined during calibration. SPEAG warrants that the remaining deviation due to the boundary effect after compensation is always less than $\pm 1\%$ for frequencies below 3 GHz and below $\pm 2\%$ for frequencies between 3-6 GHz at any distance larger than half the probe tip diameter from the boundary.

EX3DV4- SN:3710

February 23, 2017

Frequency Response of E-Field (TEM-Cell:ifi110 EXX, Waveguide: R22)

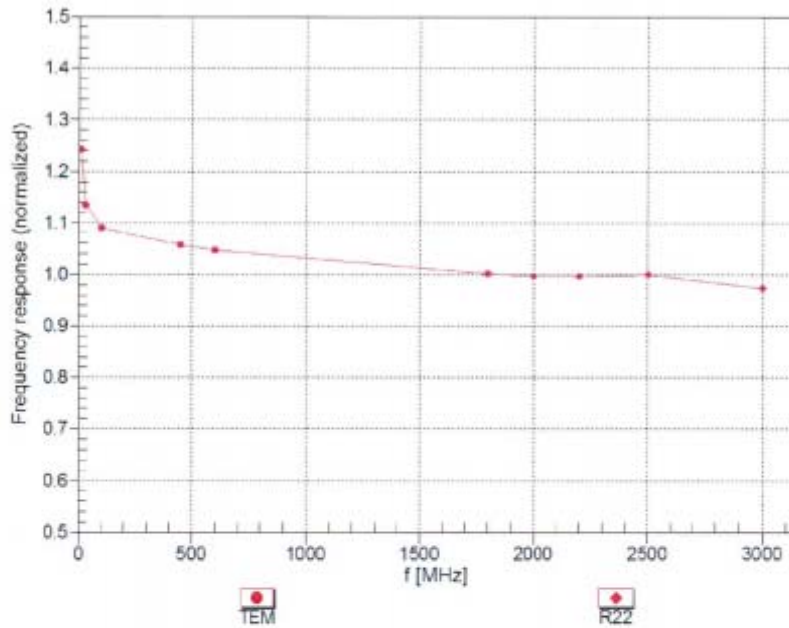

Uncertainty of Frequency Response of E-field: $\pm 6.3\%$ (k=2)

Receiving Pattern (ϕ), $\theta = 0^\circ$

f=600 MHz, TEM

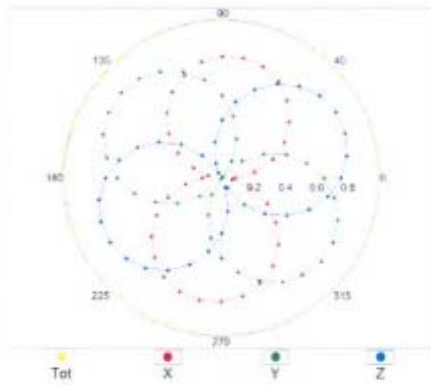

f=1800 MHz, R22

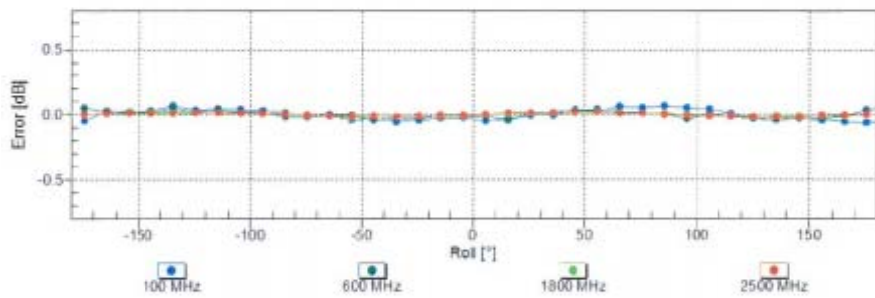
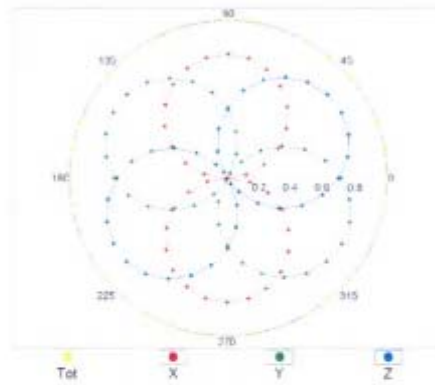

Uncertainty of Axial Isotropy Assessment: $\pm 0.5\%$ (k=2)

Dynamic Range $f(SAR_{head})$ (TEM cell, $f_{eval} = 1900$ MHz)

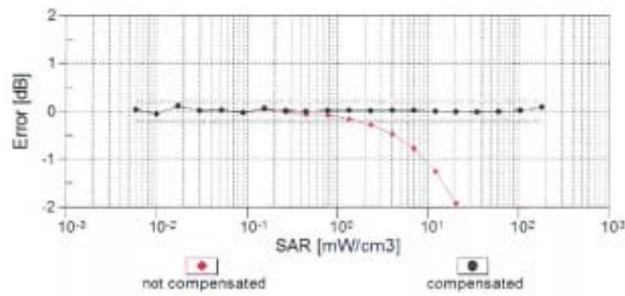
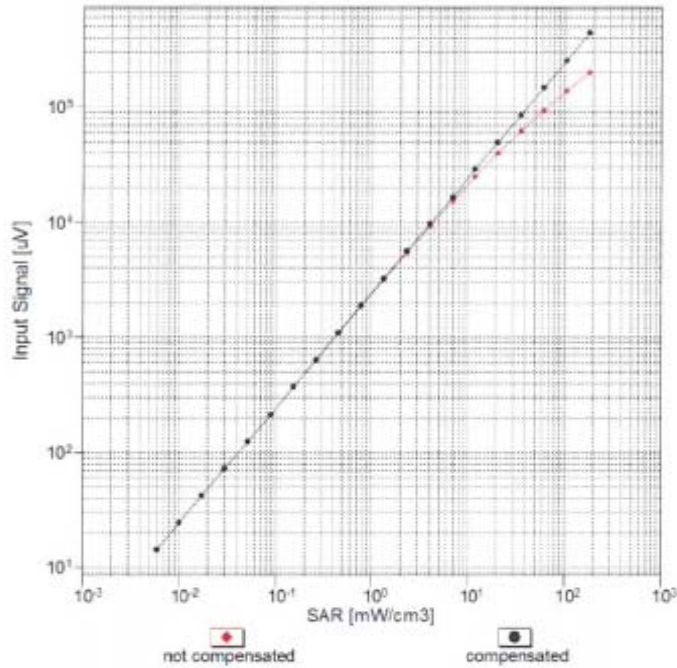

Uncertainty of Linearity Assessment: $\pm 0.6\%$ (k=2)

EX3DV4-SN:3710

February 23, 2017

Conversion Factor Assessment

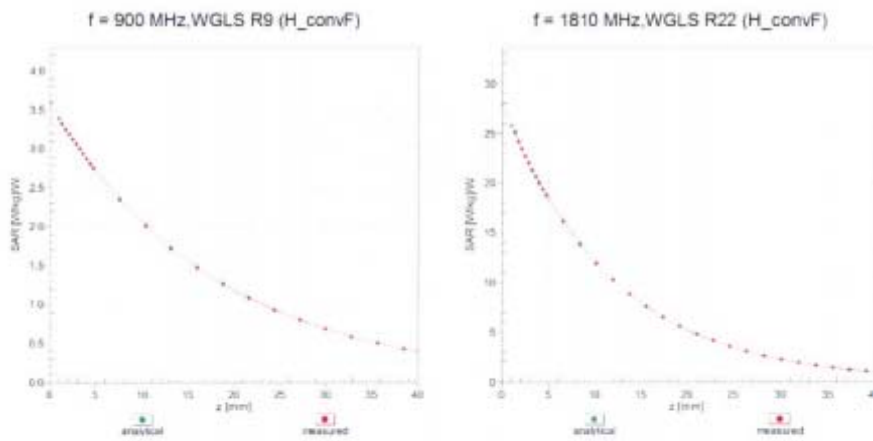

Deviation from Isotropy in Liquid Error (ϕ, θ), f = 900 MHz

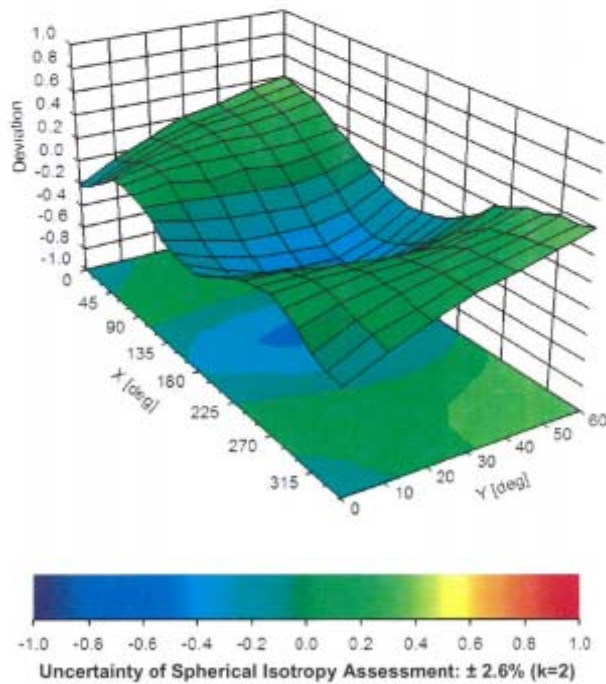

EX3DV4- SN:3710

February 23, 2017

DASY/EASY - Parameters of Probe: EX3DV4 - SN:3710

Other Probe Parameters

Sensor Arrangement	Triangular
Connector Angle (°)	85.6
Mechanical Surface Detection Mode	enabled
Optical Surface Detection Mode	disabled
Probe Overall Length	337 mm
Probe Body Diameter	10 mm
Tip Length	9 mm
Tip Diameter	2.5 mm
Probe Tip to Sensor X Calibration Point	1 mm
Probe Tip to Sensor Y Calibration Point	1 mm
Probe Tip to Sensor Z Calibration Point	1 mm
Recommended Measurement Distance from Surface	1.4 mm

Appendix D. Dipole Calibration Data

DASY5 Validation Report for Head TSL

Date: 04.02.2016

Test Laboratory: SPEAG, Zurich, Switzerland

DUT: Dipole D5GHzV2; Type: D5GHzV2; Serial: D5GHzV2 - SN:1078

Communication System: UID 0 - CW; Frequency: 5250 MHz, Frequency: 5600 MHz, Frequency: 5750 MHz
Medium parameters used: $f = 5250$ MHz; $\sigma = 4.55$ S/m; $\epsilon_r = 35.2$; $\rho = 1000$ kg/m³, Medium parameters used: $f = 5600$ MHz; $\sigma = 4.9$ S/m; $\epsilon_r = 34.7$; $\rho = 1000$ kg/m³, Medium parameters used: $f = 5750$ MHz; $\sigma = 5.05$ S/m; $\epsilon_r = 34.5$; $\rho = 1000$ kg/m³

Phantom section: Flat Section

Measurement Standard: DASY5 (IEEE/IEC/ANSI C63.19-2011)

DASY52 Configuration:

- Probe: EX3DV4 - SN3503; ConvF(5.53, 5.53, 5.53); Calibrated: 31.12.2015, ConvF(4.99, 4.99, 4.99); Calibrated: 31.12.2015, ConvF(4.95, 4.95, 4.95); Calibrated: 31.12.2015;
- Sensor-Surface: 1.4mm (Mechanical Surface Detection)
- Electronics: DAE4 Sn601; Calibrated: 30.12.2015
- Phantom: Flat Phantom 5.0 (front); Type: QD000P50AA; Serial: 1001
- DASY52 52.8.8(1258); SEMCAD X 14.6.10(7372)

Dipole Calibration for Head Tissue/Pin=100mW, dist=10mm, f=5250 MHz/Zoom Scan, dist=1.4mm (8x8x7)/Cube 0:

Measurement grid: dx=4mm, dy=4mm, dz=1.4mm

Reference Value = 72.58 V/m; Power Drift = 0.01 dB

Peak SAR (extrapolated) = 28.2 W/kg

SAR(1 g) = 7.71 W/kg; SAR(10 g) = 2.23 W/kg

Maximum value of SAR (measured) = 17.5 W/kg

Dipole Calibration for Head Tissue/Pin=100mW, dist=10mm, f=5600 MHz/Zoom Scan, dist=1.4mm (8x8x7)/Cube 0:

Measurement grid: dx=4mm, dy=4mm, dz=1.4mm

Reference Value = 72.43 V/m; Power Drift = -0.01 dB

Peak SAR (extrapolated) = 31.4 W/kg

SAR(1 g) = 8.11 W/kg; SAR(10 g) = 2.35 W/kg

Maximum value of SAR (measured) = 18.8 W/kg

Dipole Calibration for Head Tissue/Pin=100mW, dist=10mm, f=5750 MHz/Zoom Scan, dist=1.4mm (8x8x7)/Cube 0:

Measurement grid: dx=4mm, dy=4mm, dz=1.4mm

Reference Value = 70.73 V/m; Power Drift = 0.01 dB

Peak SAR (extrapolated) = 31.4 W/kg

SAR(1 g) = 7.79 W/kg; SAR(10 g) = 2.24 W/kg

Maximum value of SAR (measured) = 18.3 W/kg

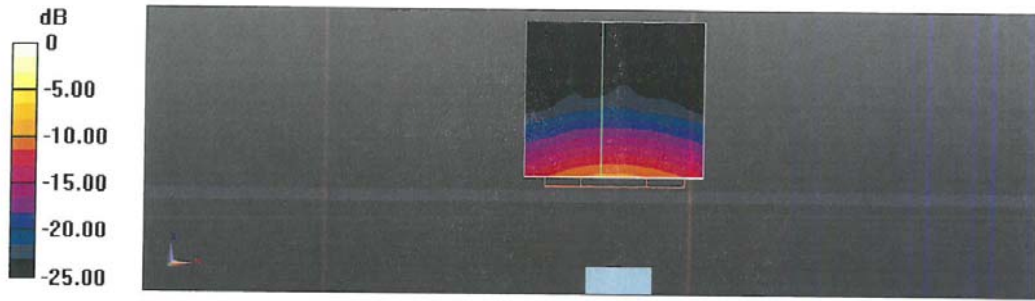

0 dB = 18.3 W/kg = 12.62 dBW/kg

Impedance Measurement Plot for Head TSL

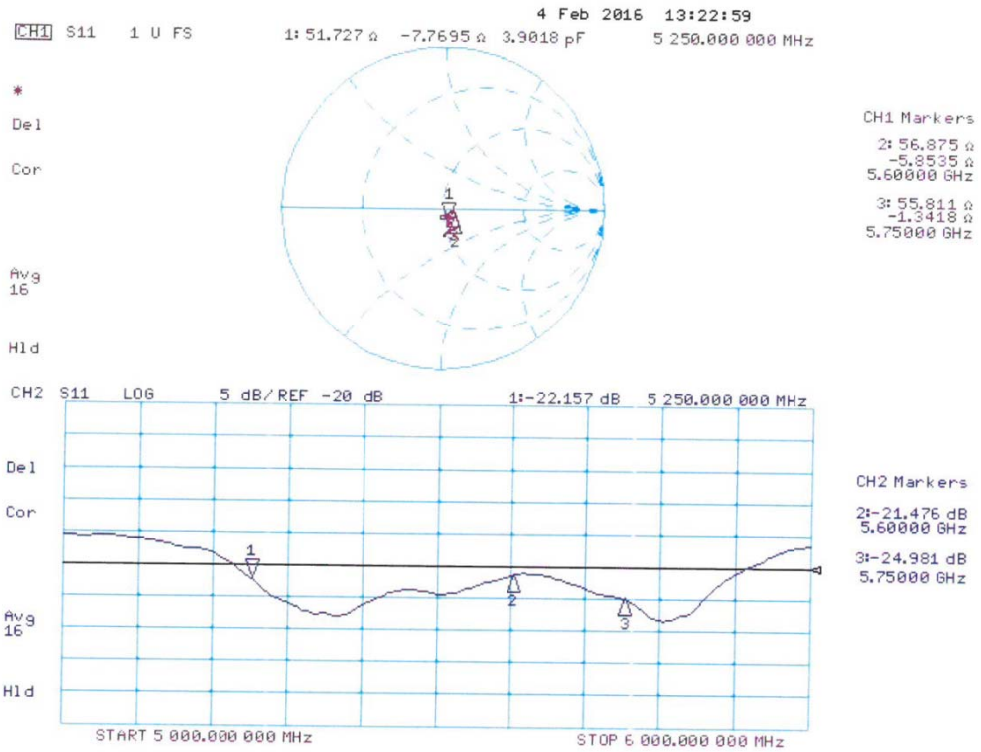

DASY5 Validation Report for Body TSL

Date: 10.02.2016

Test Laboratory: SPEAG, Zurich, Switzerland

DUT: Dipole 5GHz; Type: D5GHzV2; Serial: D5GHzV2 - SN: 1078

Communication System: UID 0 - CW; Frequency: 5250 MHz, Frequency: 5600 MHz, Frequency: 5750 MHz
Medium parameters used: $f = 5250$ MHz; $\sigma = 5.46$ S/m; $\epsilon_r = 47.1$; $\rho = 1000$ kg/m³, Medium parameters used: $f = 5600$ MHz; $\sigma = 5.94$ S/m; $\epsilon_r = 46.4$; $\rho = 1000$ kg/m³, Medium parameters used: $f = 5750$ MHz; $\sigma = 6.15$ S/m; $\epsilon_r = 46.2$; $\rho = 1000$ kg/m³

Phantom section: Flat Section

Measurement Standard: DASY5 (IEEE/IEC/ANSI C63.19-2011)

DASY52 Configuration:

- Probe: EX3DV4 - SN3503; ConvF(4.85, 4.85, 4.85); Calibrated: 31.12.2015, ConvF(4.35, 4.35, 4.35); Calibrated: 31.12.2015, ConvF(4.3, 4.3, 4.3); Calibrated: 31.12.2015;
- Sensor-Surface: 1.4mm (Mechanical Surface Detection)
- Electronics: DAE4 Sn601; Calibrated: 30.12.2015
- Phantom: Flat Phantom 5.0 (back); Type: QD000P50AA; Serial: 1002
- DASY52 52.8.8(1258); SEMCAD X 14.6.10(7372)

Dipole Calibration for Body Tissue/Pin=100mW, dist=10mm, f=5250 MHz/Zoom Scan, dist=1.4mm (8x8x7)/Cube 0:

Measurement grid: dx=4mm, dy=4mm, dz=1.4mm

Reference Value = 66.04 V/m; Power Drift = -0.04 dB

Peak SAR (extrapolated) = 27.8 W/kg

SAR(1 g) = 7.42 W/kg; SAR(10 g) = 2.1 W/kg

Maximum value of SAR (measured) = 17.0 W/kg

Dipole Calibration for Body Tissue/Pin=100mW, dist=10mm, f=5600 MHz/Zoom Scan, dist=1.4mm (8x8x7)/Cube 0:

Measurement grid: dx=4mm, dy=4mm, dz=1.4mm

Reference Value = 66.76 V/m; Power Drift = 0.03 dB

Peak SAR (extrapolated) = 32.7 W/kg

SAR(1 g) = 7.94 W/kg; SAR(10 g) = 2.25 W/kg

Maximum value of SAR (measured) = 19.1 W/kg

Dipole Calibration for Body Tissue/Pin=100mW, dist=10mm, f=5750 MHz/Zoom Scan, dist=1.4mm (8x8x7)/Cube 0:

Measurement grid: dx=4mm, dy=4mm, dz=1.4mm

Reference Value = 64.46 V/m; Power Drift = 0.04 dB

Peak SAR (extrapolated) = 32.4 W/kg

SAR(1 g) = 7.58 W/kg; SAR(10 g) = 2.13 W/kg

Maximum value of SAR (measured) = 18.3 W/kg

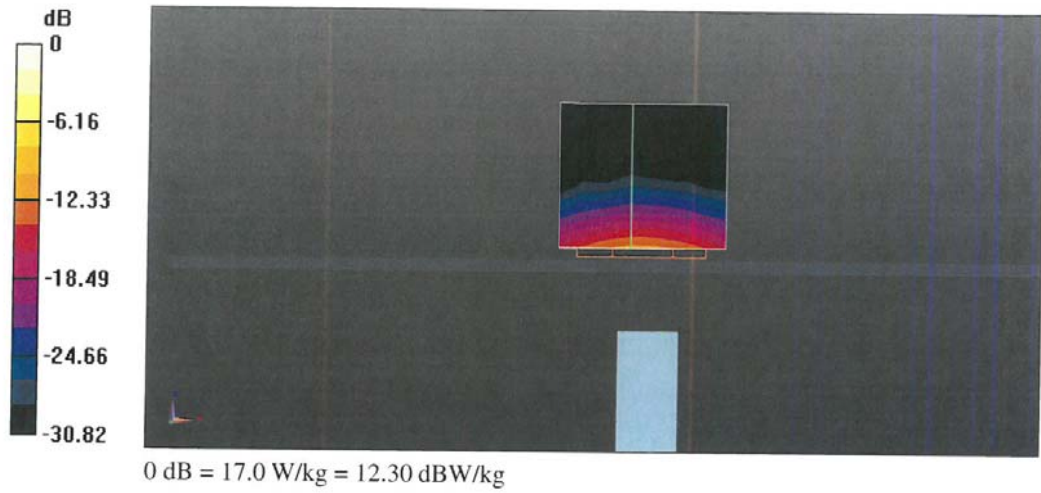

Impedance Measurement Plot for Body TSL

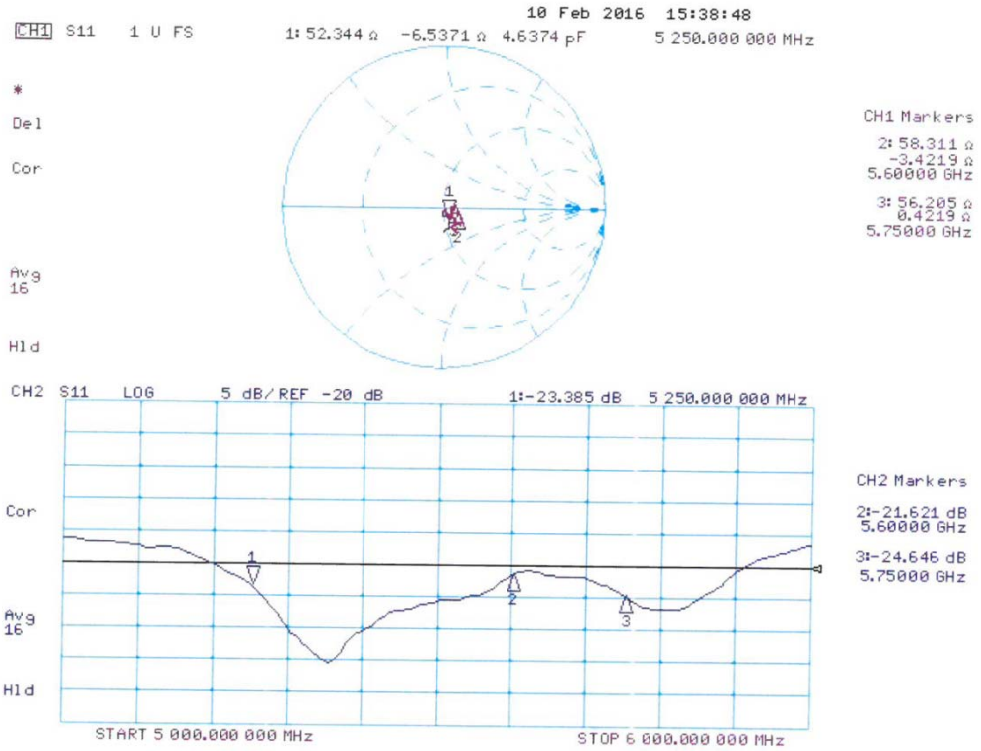

Appendix E. DAE Calibration Data

Schmid & Partner Engineering AG

Zeughausstrasse 43, 8004 Zurich, Switzerland
Phone +41 44 245 9700, Fax +41 44 245 9779
info@speag.com, http://www.speag.com

s p e a g

1220

IMPORTANT NOTICE

USAGE OF THE DAE 4

The DAE unit is a delicate, high precision instrument and requires careful treatment by the user. There are no serviceable parts inside the DAE. Special attention shall be given to the following points:

Battery Exchange: The battery cover of the DAE4 unit is closed using a screw, over tightening the screw may cause the threads inside the DAE to wear out.

Shipping of the DAE: Before shipping the DAE to SPEAG for calibration, remove the batteries and pack the DAE in an antistatic bag. This antistatic bag shall then be packed into a larger box or container which protects the DAE from impacts during transportation. The package shall be marked to indicate that a fragile instrument is inside.

E-Stop Failures: Touch detection may be malfunctioning due to broken magnets in the E-stop. Rough handling of the E-stop may lead to damage of these magnets. Touch and collision errors are often caused by dust and dirt accumulated in the E-stop. To prevent E-stop failure, the customer shall always mount the probe to the DAE carefully and keep the DAE unit in a non-dusty environment if not used for measurements.

Repair: Minor repairs are performed at no extra cost during the annual calibration. However, SPEAG reserves the right to charge for any repair especially if rough unprofessional handling caused the defect.

DASY Configuration Files: Since the exact values of the DAE input resistances, as measured during the calibration procedure of a DAE unit, are not used by the DASY software, a nominal value of 200 MOhm is given in the corresponding configuration file.

Important Note:

Warranty and calibration is void if the DAE unit is disassembled partly or fully by the Customer.

Important Note:

Never attempt to grease or oil the E-stop assembly. Cleaning and readjusting of the E-stop assembly is allowed by certified SPEAG personnel only and is part of the annual calibration procedure.

Important Note:

To prevent damage of the DAE probe connector pins, use great care when installing the probe to the DAE. Carefully connect the probe with the connector notch oriented in the mating position. Avoid any rotational movement of the probe body versus the DAE while turning the locking nut of the connector. The same care shall be used when disconnecting the probe from the DAE.

Schmid & Partner Engineering

TN_BR040315AD DAE4.doc

11.12.2009

**Calibration Laboratory of
Schmid & Partner
Engineering AG**
Zeughausstrasse 43, 8004 Zurich, Switzerland



S Schweizerischer Kalibrierdienst
C Service suisse d'étalonnage
S Servizio svizzero di taratura
S Swiss Calibration Service

Accredited by the Swiss Accreditation Service (SAS)
The Swiss Accreditation Service is one of the signatories to the EA
Multilateral Agreement for the recognition of calibration certificates

Accreditation No.: **SCS 0108**

Client **QTK - CN (Auden)**

Certificate No: **DAE4-1220_Feb17**

CALIBRATION CERTIFICATE

Object: **DAE4 - SD 000 D04 BM - SN: 1220**

Calibration procedure(s): **QA CAL-06.v29
Calibration procedure for the data acquisition electronics (DAE)**

Calibration date: **February 21, 2017**

This calibration certificate documents the traceability to national standards, which realize the physical units of measurements (SI).
The measurements and the uncertainties with confidence probability are given on the following pages and are part of the certificate.

All calibrations have been conducted in the closed laboratory facility: environment temperature (22 ± 3)°C and humidity < 70%.

Calibration Equipment used (M&TE critical for calibration)

Primary Standards	ID #	Cal Date (Certificate No.)	Scheduled Calibration
Keithley Multimeter Type 2001	SN: 0810278	09-Sep-16 (No:19065)	Sep-17
Secondary Standards	ID #	Check Date (in house)	Scheduled Check
Auto DAE Calibration Unit	SE UWS 053 AA 1001	05-Jan-17 (in house check)	In house check: Jan-18
Calibrator Box V2.1	SE UMS 006 AA 1002	05-Jan-17 (in house check)	In house check: Jan-18

	Name	Function	Signature
Calibrated by:	Eric Hainfeld	Technician	
Approved by:	Fin Bomholt	Deputy Technical Manager	

Issued: February 21, 2017

This calibration certificate shall not be reproduced except in full without written approval of the laboratory.

**Calibration Laboratory of
Schmid & Partner
Engineering AG**
Zeughausstrasse 43, 8004 Zurich, Switzerland



S Schweizerischer Kalibrierdienst
C Service suisse d'étalonnage
S Servizio svizzero di taratura
S Swiss Calibration Service

Accredited by the Swiss Accreditation Service (SAS)

The Swiss Accreditation Service is one of the signatories to the EA
Multilateral Agreement for the recognition of calibration certificates

Accreditation No.: **SCS 0108**

Glossary

DAE data acquisition electronics
Connector angle information used in DASY system to align probe sensor X to the robot coordinate system.

Methods Applied and Interpretation of Parameters

- *DC Voltage Measurement:* Calibration Factor assessed for use in DASY system by comparison with a calibrated instrument traceable to national standards. The figure given corresponds to the full scale range of the voltmeter in the respective range.
- *Connector angle:* The angle of the connector is assessed measuring the angle mechanically by a tool inserted. Uncertainty is not required.
- The following parameters as documented in the Appendix contain technical information as a result from the performance test and require no uncertainty.
 - *DC Voltage Measurement Linearity:* Verification of the Linearity at +10% and -10% of the nominal calibration voltage. Influence of offset voltage is included in this measurement.
 - *Common mode sensitivity:* Influence of a positive or negative common mode voltage on the differential measurement.
 - *Channel separation:* Influence of a voltage on the neighbor channels not subject to an input voltage.
 - *AD Converter Values with inputs shorted:* Values on the internal AD converter corresponding to zero input voltage
 - *Input Offset Measurement:* Output voltage and statistical results over a large number of zero voltage measurements.
 - *Input Offset Current:* Typical value for information; Maximum channel input offset current, not considering the input resistance.
 - *Input resistance:* Typical value for information: DAE input resistance at the connector, during internal auto-zeroing and during measurement.
 - *Low Battery Alarm Voltage:* Typical value for information. Below this voltage, a battery alarm signal is generated.
 - *Power consumption:* Typical value for information. Supply currents in various operating modes.

DC Voltage Measurement

A/D - Converter Resolution nominal

High Range: 1LSB = 6.1 μ V, full range = -100...+300 mV
Low Range: 1LSB = 61nV, full range = -1.....+3mV

DASY measurement parameters: Auto Zero Time: 3 sec; Measuring time: 3 sec

Calibration Factors	X	Y	Z
High Range	405.199 \pm 0.02% (k=2)	404.922 \pm 0.02% (k=2)	404.141 \pm 0.02% (k=2)
Low Range	3.97730 \pm 1.50% (k=2)	3.99518 \pm 1.50% (k=2)	3.98697 \pm 1.50% (k=2)

Connector Angle

Connector Angle to be used in DASY system	176.0 $^{\circ}$ \pm 1 $^{\circ}$
---	-------------------------------------

Appendix (Additional assessments outside the scope of SCS0108)

1. DC Voltage Linearity

High Range	Reading (μV)	Difference (μV)	Error (%)
Channel X + Input	200035.74	3.00	0.00
Channel X + Input	20006.48	1.96	0.01
Channel X - Input	-20002.30	2.92	-0.01
Channel Y + Input	200038.34	5.71	0.00
Channel Y + Input	20003.88	-0.58	-0.00
Channel Y - Input	-20005.36	-0.11	0.00
Channel Z + Input	200030.51	-2.34	-0.00
Channel Z + Input	20002.06	-2.34	-0.01
Channel Z - Input	-20005.96	-0.63	0.00

Low Range	Reading (μV)	Difference (μV)	Error (%)
Channel X + Input	1999.95	-0.80	-0.04
Channel X + Input	201.41	0.61	0.30
Channel X - Input	-198.91	0.31	-0.16
Channel Y + Input	2000.74	0.07	0.00
Channel Y + Input	200.23	-0.58	-0.29
Channel Y - Input	-199.81	-0.58	0.29
Channel Z + Input	2000.47	-0.20	-0.01
Channel Z + Input	199.40	-1.36	-0.68
Channel Z - Input	-200.44	-1.17	0.58

2. Common mode sensitivity

DASY measurement parameters: Auto Zero Time: 3 sec; Measuring time: 3 sec

	Common mode Input Voltage (mV)	High Range Average Reading (μV)	Low Range Average Reading (μV)
Channel X	200	10.20	8.02
	-200	-7.68	-9.63
Channel Y	200	-9.03	-9.12
	-200	8.15	7.76
Channel Z	200	11.85	11.86
	-200	-14.62	-14.58

3. Channel separation

DASY measurement parameters: Auto Zero Time: 3 sec; Measuring time: 3 sec

	Input Voltage (mV)	Channel X (μV)	Channel Y (μV)	Channel Z (μV)
Channel X	200	-	1.80	-4.26
Channel Y	200	7.93	-	2.43
Channel Z	200	9.61	5.63	-

4. AD-Converter Values with inputs shorted

DASY measurement parameters: Auto Zero Time: 3 sec; Measuring time: 3 sec

	High Range (LSB)	Low Range (LSB)
Channel X	15882	14946
Channel Y	16015	16273
Channel Z	15704	16009

5. Input Offset Measurement

DASY measurement parameters: Auto Zero Time: 3 sec; Measuring time: 3 sec

Input 10MΩ

	Average (μV)	min. Offset (μV)	max. Offset (μV)	Std. Deviation (μV)
Channel X	0.91	-0.14	2.95	0.44
Channel Y	0.15	-1.00	1.08	0.43
Channel Z	-0.87	-3.63	0.43	0.52

6. Input Offset Current

Nominal Input circuitry offset current on all channels: <25fA

7. Input Resistance (Typical values for information)

	Zeroing (kOhm)	Measuring (MOhm)
Channel X	200	200
Channel Y	200	200
Channel Z	200	200

8. Low Battery Alarm Voltage (Typical values for information)

Typical values	Alarm Level (VDC)
Supply (+ Vcc)	+7.9
Supply (- Vcc)	-7.6

9. Power Consumption (Typical values for information)

Typical values	Switched off (mA)	Stand by (mA)	Transmitting (mA)
Supply (+ Vcc)	+0.01	+6	+14
Supply (- Vcc)	-0.01	-8	-9