



Sverige



Report On

FCC and ISED Testing of the Ericsson RRUS 32A B2 LTE and NR (ESS), KRC 161 418/1 (1900 MHz) Base Station in accordance with FCC CFR 47 Part 2, FCC CFR 47 Part 24, ISED RSS-GEN: and Industry Canada RSS-133

COMMERCIAL-IN-CONFIDENCE

FCC: TA8AKRC161418-1

IC: 287AB-AS1614181

PREPARED BY

APPROVED BY

DATED

Maggie Whiting
Key Account Manager

Steve Scarfe
Authorised Signatory

25 August 2021

Document 75952703 Report 01 Issue 1

August 2021



CONTENTS

Section	Page No
1	REPORT INFORMATION 2
1.1	Report Details 3
1.2	Brief Summary of Results 4
1.3	Test Rationale..... 5
1.4	Configuration Description 6
1.5	Declaration of Build Status 7
1.6	Product Information 8
1.7	Test Setup 9
1.8	Test Conditions..... 10
1.9	Deviation From The Standard 10
1.10	Modification Record 10
1.11	Additional Information 10
2	TEST DETAILS 11
2.1	Maximum Peak Output Power and Peak to Average Ratio - Conducted..... 12
2.2	Occupied Bandwidth..... 30
2.3	Band Edge 49
2.4	Transmitter Spurious Emissions..... 64
3	TEST EQUIPMENT USED 145
3.1	Test Equipment Used 146
3.2	Measurement Uncertainty 149
4	ACCREDITATION, DISCLAIMERS AND COPYRIGHT 150
4.1	Accreditation, Disclaimers and Copyright..... 151
ANNEX A	Module Lists.....A.2



SECTION 1

REPORT INFORMATION



1.1 REPORT DETAILS

Manufacturer	Ericsson
Address	Torshamnsgatan 23 Kista SE-16480 Stockholm Sweden
Product Name & Product Number	RRUS 32A B2 - KRC 161 418/1
Serial Number(s)	D16V513692
Software Version	CXP 901 3268/12 Revision R82CM
Hardware Version	R1E
Test Specification/Issue/Date	FCC CFR 47 Part 2: 2019 FCC CFR 47 Part 24: 2020 ISED RSS-GEN: Issue 5: 2018 and Amendment 1 2019, Amendment 2 2021 Industry Canada RSS-133: Issue 6: 2013 and Amendment 1 2018
Test Plan	Q1 FCC_IC test plan for MR7602-1 ESS V 1.2 Reduced Scope
Start of Test	23 June 2021
Finish of Test	25 June 2021
Name of Engineer(s)	Ashok Kumar Hector Eric Moreno Trujillo
Related Document(s)	KDB 971168 D01 v02r02 KDB 662911 D01 v02r01 KDB 716230 ICES-003:Issue 7 (2020-10) ANSI C63.26-2015

ENGINEERING STATEMENT

The measurements shown in this report were made in accordance with the procedures described on test pages. All reported testing was carried out on a sample equipment to demonstrate compliance with FCC CFR 47 Part 2: 2019, FCC CFR 47 Part 24: 2020. ISED RSS-GEN: Issue 5: 2018 and Amendment 1 2019, Amendment 2 2021 and Industry Canada RSS-133: Issue 6: 2013 and Amendment 1 2018. The sample tested was found to comply with the requirements defined in the applied rules.

Test Engineer(s);

Ashok Kumar

Héctor Trujillo



1.2 BRIEF SUMMARY OF RESULTS

A brief summary of results for each configuration, in accordance with FCC CFR 47 Part 2, FCC CFR 47 Part 24, ISED RSS-GEN and Industry Canada RSS-133 is shown below.

Section	Specification Clause				Test Description	Result
	FCC CFR 47 Part 2	FCC CFR 47 Part 24	RSS-GEN	RSS-133		
2.1	2.1046	24.232	-	6.4	Maximum Peak Output Power and Peak to Average Ratio - Conducted	Pass
2.2	2.1049	24.238 (b)	6.7	-	Occupied Bandwidth	Pass
2.3	2.1051	24.238 (b)	-	6.5	Band Edge	Pass
2.4	2.1051	24.238 (a)	6.13	6.5	Transmitter Spurious Emissions	Pass

Testing in this Report covers only B2A (1900MHz).

For additional configurations and test cases not contained within this test report, refer to the following reports:

Testing for Radiated Spurious Emissions are recorded in the following report:
2104108STO-105 RRUS32AB2 FCC24



1.3 TEST RATIONALE

The tests that have been selected are detailed in the customer Test Plan as defined in section 1.1 of this report. The Test Plan is based on the TÜV SÜD FCC Test Plan Rationale, available on request.



1.4 CONFIGURATION DESCRIPTION

Configuration	RAT	No. Of carriers	Pout (W)	Carrier Bandwidth	Carrier Frequency Configuration (MHz)		
					Bottom	Middle	Top
1	ESS, NR/LTE	1	30	10 MHz- SCS 15kHz	1935	1960	1985
				20 MHz- SCS 15kHz	1940	1960	1980
2		3	30	10 MHz- SCS 15kHz	1935+1945+1955	N/A	1985+1975+1965
3	NR in NR/ESS Setup	1	30	10 MHz- SCS 15kHz	1935	1960	1985
				20 MHz- SCS 15kHz	1940	1960	1980
4		3	30	10 MHz- SCS 15kHz	1935+1945+1955	N/A	1985+1975+1965



1.5 DECLARATION OF BUILD STATUS

Equipment Description						
Technical Description: (Please provide a brief description of the intended use of the equipment including the technologies the product supports)		Multi-standard remote radio unit				
Manufacturer:		Ericsson AB				
Model:		RRUS 32A B2				
Part Number:		KRC 161 418/1				
Hardware Version:		R1E				
Software Version:		CXP 901 326B/12 R82CM				
FCC ID of the product under test		TABAKRC161418-1				
IC ID of the product under test		287AB-AS1614181				
Intentional Radiators						
FDD, TDD		FDD				
Frequency Range (MHz to MHz)		1930MHz - 1990MHz DL 1850MHz - 1910MHz UL				
FDD / TDD		FDD				
Conducted Declared Output Power (dBm)		30W per antenna connector (NB IoT SA carrier max 20W)				
RAT		GSM	WCDMA	NB IoT SA	LTE (incl. NB IoT IB, GB)	NR (incl NB IoT IB)
Supported Bandwidth(s) (MHz)						5,10,15,20MHz 15kHz scs
Modulation Scheme(s) DL		GMSK, 8PSK, AQPSK	GMSK	QPSK, 16QAM, 64QAM	QPSK, 16QAM, 64QAM,	QPSK, 16QAM, 64QAM, 256QAM
ITU Emission Designator		245KGXW 245KG7W	5M00F9W	210KW7D	1M40W7D 3M00W7D 10M0W7D 15M0W7D 20M0W7D	4M47W7D 9M29W7D 9M42W7D 14M11W7D 14M44W7D 18M9W7D 19M2W7D 38M8W7D
IBW		20MHz	90MHz	20MHz	1,4 & 3MHz: 40MHz 5,10,15,20MHz:110MHz	60Mhz
Maximum number of carriers						3
Unintentional Radiators						
Highest frequency generated or used in the device or on which the device operates or tunes		9,8 Gbit/s				
Lowest frequency generated or used in the device or on which the device operates or tunes if <30MHz		-				
Class A Digital Device (Use in commercial, industrial or business environment) or Class B Digital Device (Use in residential environment)		Class B				
DC Power Supply (Delete if Not Applicable)						
Nominal voltage:		-48V				
Extreme upper voltage:		-38V				
Extreme lower voltage:		-58.5V				
Max current:		20A				
Temperature						
Minimum temperature:		-40°C				
Maximum temperature:		55°C				
I hereby declare that I am entitled to sign on behalf of the manufacturer and that the information supplied is correct and complete.						
		<i>Faysal Pirmohamed</i>				
Name:		Faysal Pirmohamed				
Position held:		Regulatory Engineer				
Date:		2021-08-24				

1.6 PRODUCT INFORMATION

1.6.1 Technical Description

The Equipment Under Test (EUT) RRUS 32A B2 - KRC 161 418/1 is an Ericsson AB Radio Unit working in the public mobile service 1900MHz band which provides communication connections to 1900MHz network. The EUT operates from a -48V DC supply.

The Equipment Under Test (EUT) is shown in the photograph below. A full technical description can be found in the Manufacturer's documentation.

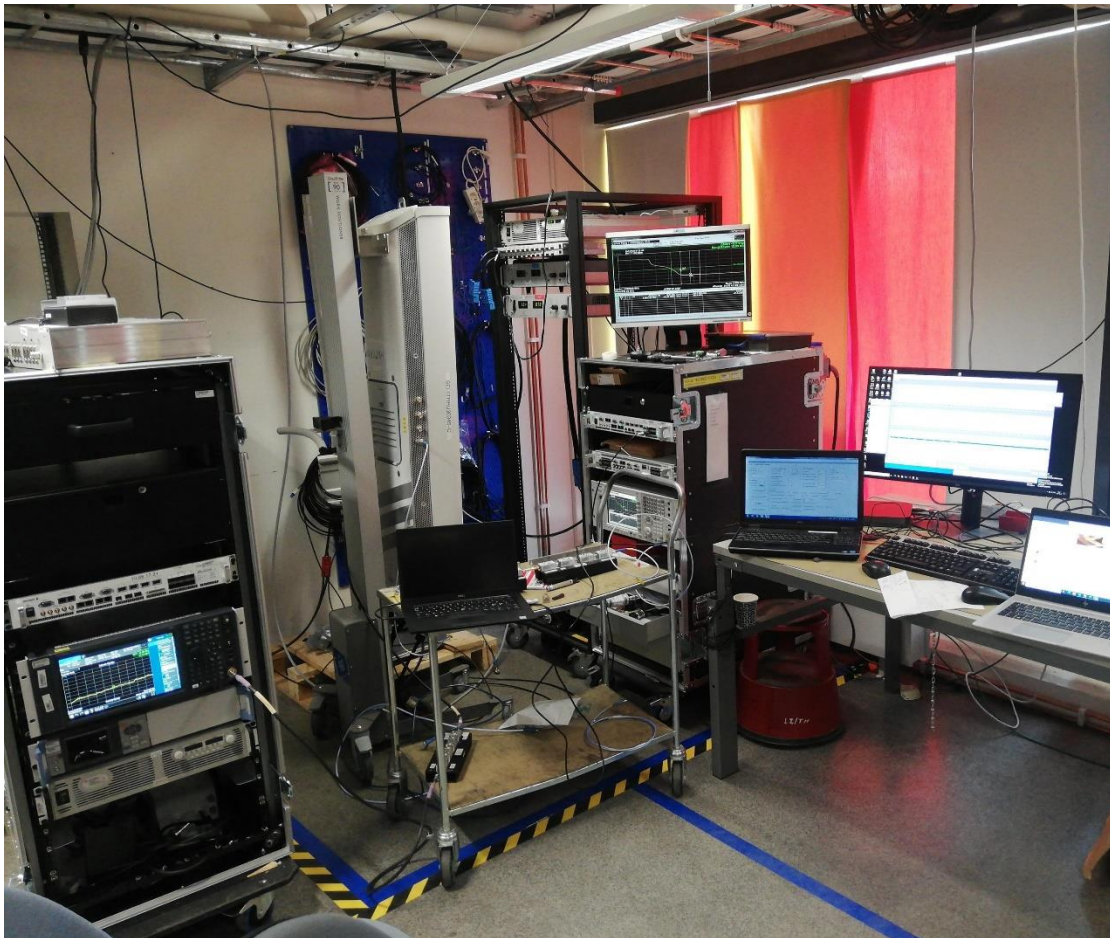

Equipment Under Test



1.7 TEST SETUP

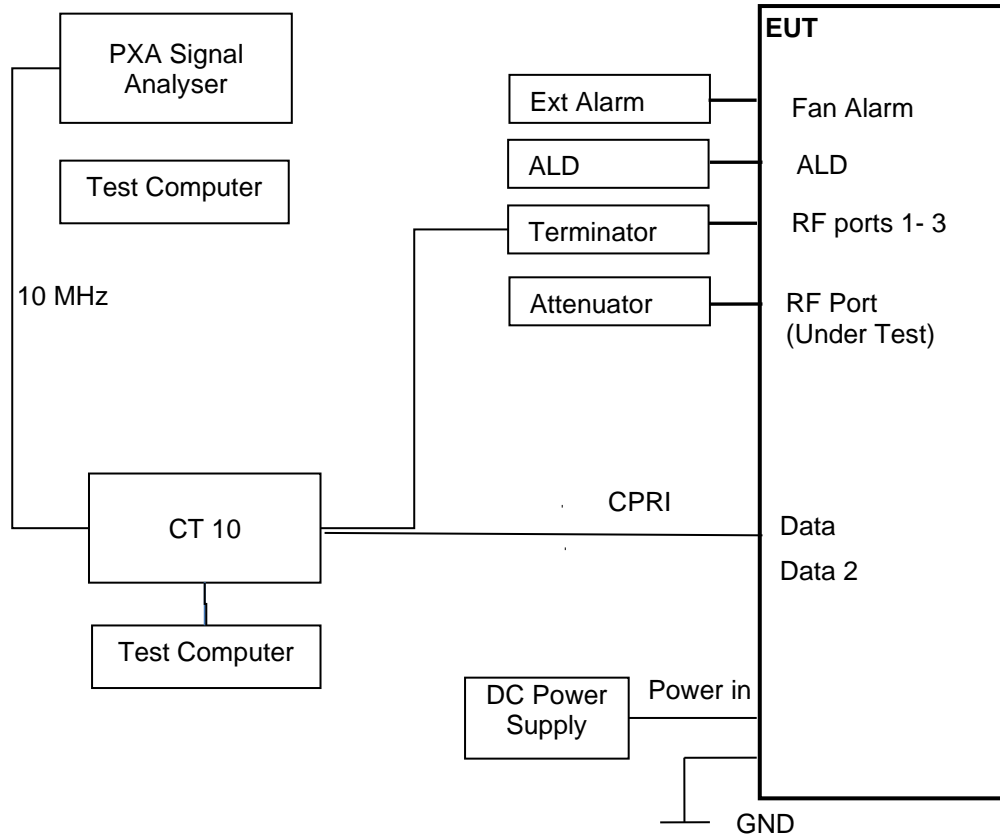



1.8 TEST CONDITIONS

For all tests the EUT was set up in accordance with the relevant test standard and to represent typical operating conditions. Tests were applied with the EUT situated as described in the Test Method for each Test.

The EUT was powered from a -48V DC supply.

FCC Measurement Facility Registration Number
563983 Ericsson Test Laboratory, Kista
Postal Address: Ericsson AB, Isafjordsgatan 10, Stockholm, SE-16 440, Sweden

ISED Accreditation
IC#26170 Ericsson Test Laboratory, Kista
Postal Address: Ericsson AB, Isafjordsgatan 10, Stockholm, SE-164 40, Sweden

Test Name	Name of Engineer(s)
Maximum Peak Output Power and Peak to Average Ratio - Conducted	Ashok Kumar, Hector Eric Moreno Trujillo
Occupied Bandwidth	Ashok Kumar, Hector Eric Moreno Trujillo
Band Edge	Ashok Kumar, Hector Eric Moreno Trujillo
Transmitter Spurious Emissions	Ashok Kumar, Hector Eric Moreno Trujillo

1.9 DEVIATION FROM THE STANDARD

No deviations from the applicable test standards or test plan were made during testing.

1.10 MODIFICATION RECORD

No modifications were made to the EUT during testing.

1.11 ADDITIONAL INFORMATION

This filing is for a Class 2 Permissive change to add ESS, NR in ESS and LTE in ESS modulations to a previously certified Radio for use in the USA and Canada under the following ID's:

FCC ID: TA8AKRC161418-1
IC: 287AB-AS1614181

This device is electrically identical as originally certified as no hardware changes have been made.

Frequency Stability has been verified at time of original certification.

The Test Plan is based on the TUV SUD Document FCC and ISED Test Plan Rationale for Base Station Equipment.

This TX and RX share the same port and therefore Rx Spurious Emissions have not been performed.



SECTION 2

TEST DETAILS



2.1 MAXIMUM PEAK OUTPUT POWER AND PEAK TO AVERAGE RATIO - CONDUCTED

2.1.1 Specification Reference

FCC CFR 47 Part 24, Clause 24.232
 FCC CFR 47 Part 2, Clause 2.1046
 Industry Canada RSS-133, Clause 6.4

2.1.2 Date of Test and Modification State

23 and 24 June 2021 - Modification State 0

2.1.3 Test Equipment Used

The major items of test equipment used for the above tests are identified in Section 3.1.

2.1.4 Environmental Conditions

Ambient Temperature 22.2 - 24.2°C
 Relative Humidity 43.9 - 45.6%

2.1.5 Test Method

All measurements were made in accordance with FCC KDB 971168 D01, clause 5.2.1 and summed in accordance with FCC KDB 662911 D01.

Calculations

Total Power = Measured PSD (Total Power Port A) + 10log (N_{ANT}), where N_{ANT} =4

Maximum Total Power (EIRP) = Total Power (as above) + Declared Antenna Gain

2.1.6 Test Results

Configuration 1

Maximum Output Power 46.00 dBm

Antenna	LTE / NR Modulation	LTE / NR Carrier Bandwidth	Peak to Average Ratio (PAR) / Output Power / PSD				
			Channel Position B				
			PAR (dB)	Average Power/PSD		Total Power Port A+B+C+D	
dBm	dBm/MHz	dBm		dBm/MHz			
A	QPSK	ESS 10/90 10.0 MHz 15 kHz SCS	7.24	44.42	35.66	50.44	41.68
A	QPSK	ESS 10/90 20.0 MHz 15 kHz SCS	7.39	44.32	32.56	50.34	38.58
A	QPSK	ESS 40/60 10.0 MHz 15 kHz SCS	7.27	44.40	35.69	50.42	41.71
A	QPSK	ESS 40/60 20.0 MHz 15 kHz SCS	7.42	44.33	32.63	50.35	38.65
A	QPSK	ESS 90/10 10.0 MHz 15 kHz SCS	7.32	44.31	35.58	50.33	41.60
A	QPSK	ESS 90/10 20.0 MHz 15 kHz SCS	7.46	44.21	32.43	50.23	38.45



LTE/NR Carrier Bandwidth	Total Power PSD	EIRP Limit	EIRP Limit
	(dBm/MHz)	(W/MHz)	(dBm/MHz)
ESS 10/90 10.0 MHz 15 kHz SCS	41.68	1640	62.15
ESS 10/90 20.0 MHz 15 kHz SCS	38.58	1640	62.15
ESS 40/60 10.0 MHz 15 kHz SCS	41.71	1640	62.15
ESS 40/60 20.0 MHz 15 kHz SCS	38.65	1640	62.15
ESS 90/10 10.0 MHz 15 kHz SCS	41.60	1640	62.15
ESS 90/10 20.0 MHz 15 kHz SCS	38.45	1640	62.15

Antenna A - LTE / NR Modulation QPSK - LTE / NR Carrier Bandwidth ESS 10/90 10.0 MHz 15 kHz SCS - Channel Position B

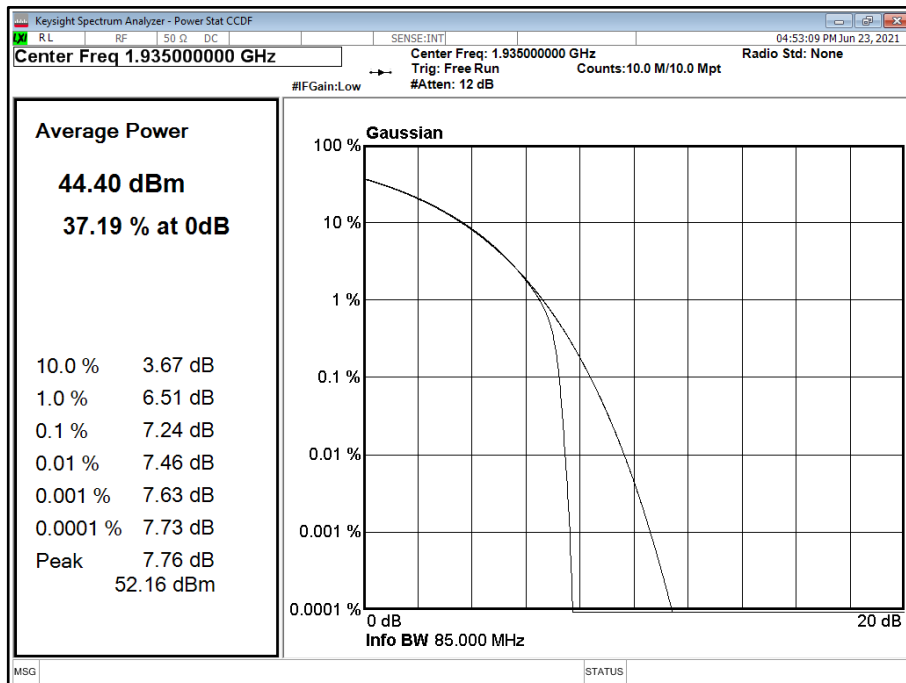



Antenna A - LTE / NR Modulation QPSK - LTE / NR Carrier Bandwidth ESS 10/90 20.0 MHz 15 kHz SCS - Channel Position B

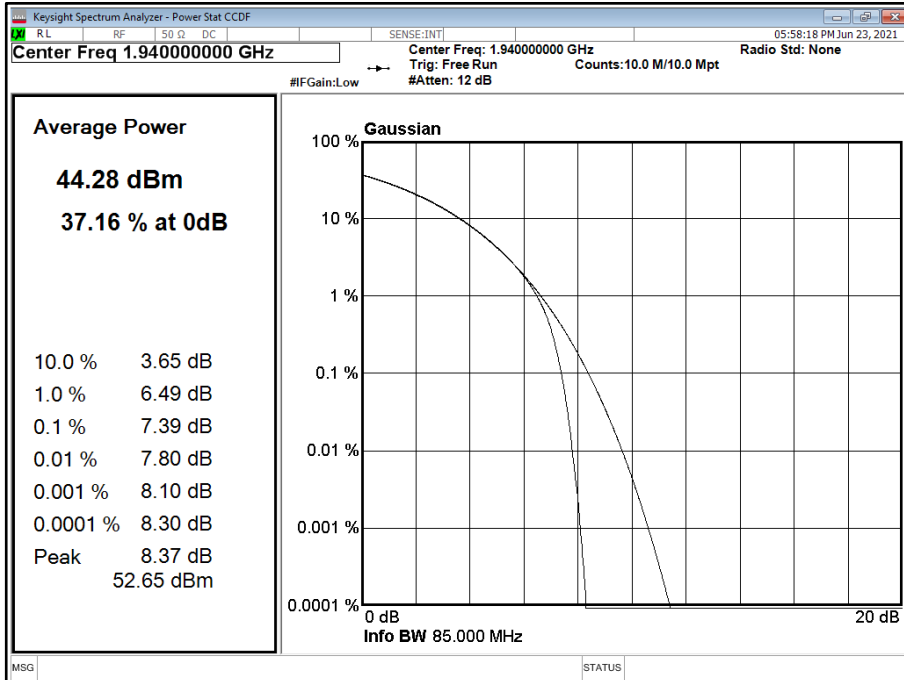

Antenna A - LTE / NR Modulation QPSK - LTE / NR Carrier Bandwidth ESS 40/60 10.0 MHz 15 kHz SCS - Channel Position B

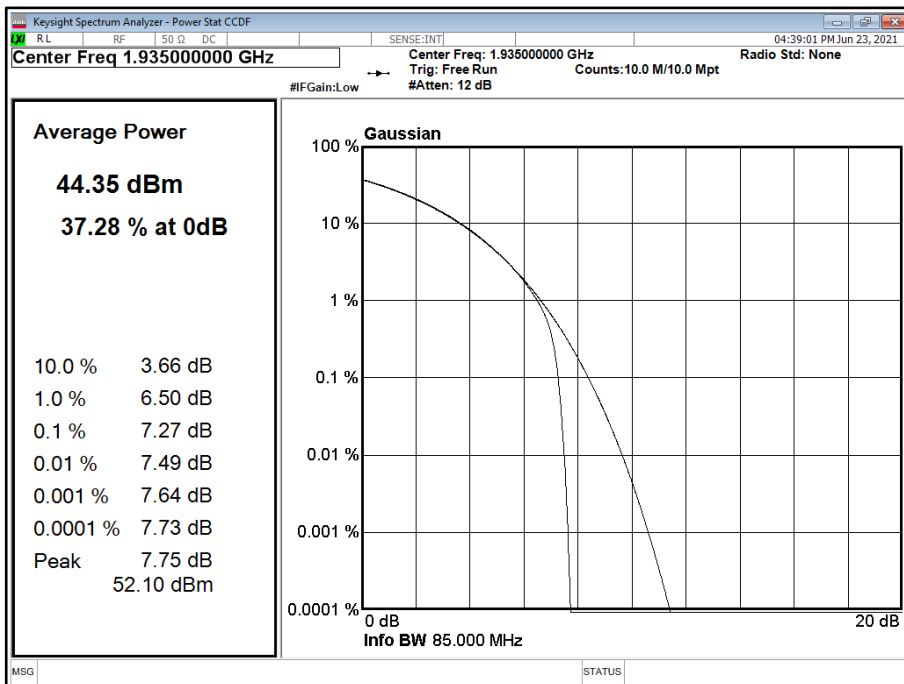



Antenna A - LTE / NR Modulation QPSK - LTE / NR Carrier Bandwidth ESS 40/60 20.0 MHz 15 kHz SCS - Channel Position B

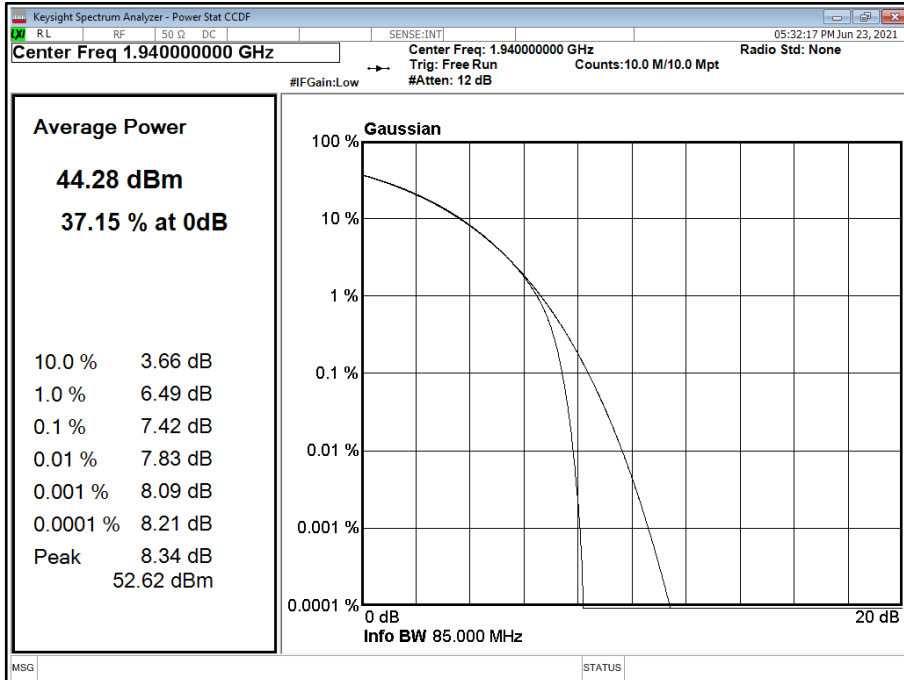

Antenna A - LTE / NR Modulation QPSK - LTE / NR Carrier Bandwidth ESS 90/10 10.0 MHz 15 kHz SCS - Channel Position B

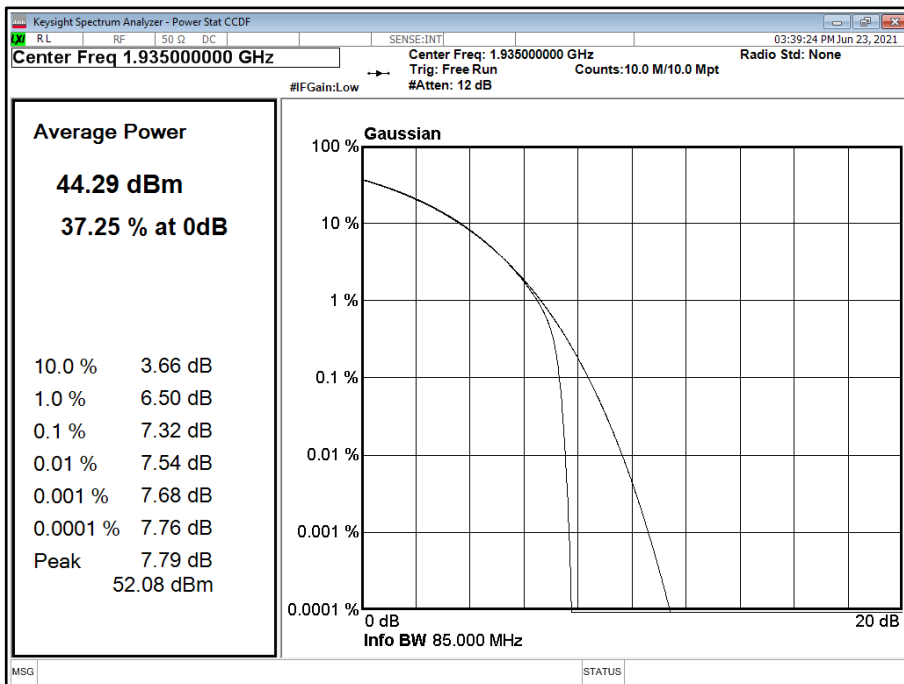



Antenna A - LTE / NR Modulation QPSK - LTE / NR Carrier Bandwidth ESS 90/10 20.0 MHz 15 kHz SCS - Channel Position B

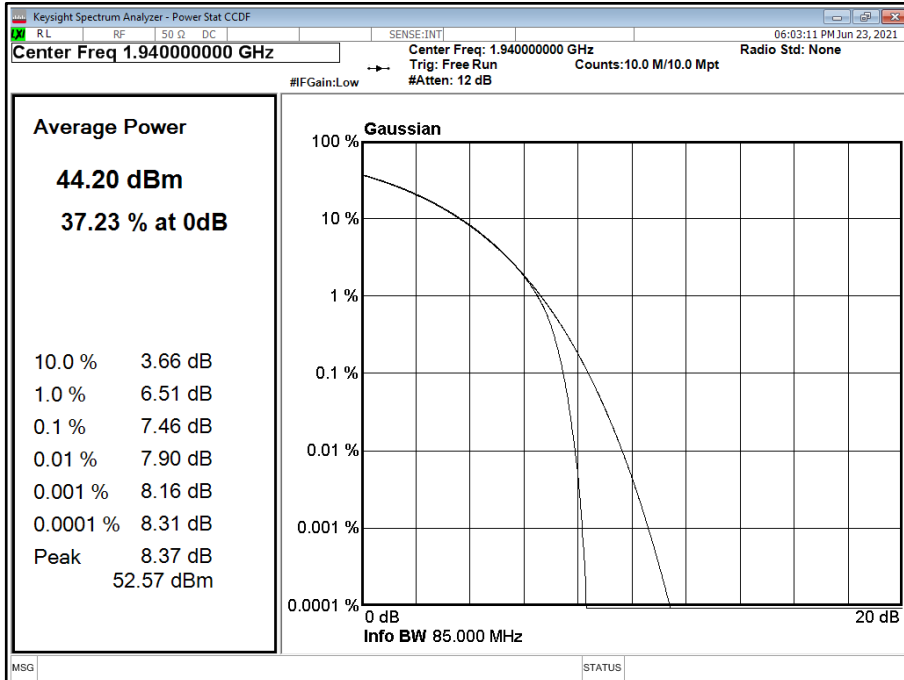

Configuration 1

Maximum Output Power 46.00 dBm

Antenna	LTE / NR Modulation	LTE / NR Carrier Bandwidth	Peak to Average Ratio (PAR) / Output Power / PSD				
			Channel Position M				
			PAR (dB)	Average Power/PSD		Total Power Port A+B+C+D	
	dBm	dBm/MHz	dBm	dBm/MHz			
A	QPSK	ESS 10/90 10.0 MHz 15 kHz SCS	7.19	44.41	35.60	50.43	41.62
A	QPSK	ESS 10/90 20.0 MHz 15 kHz SCS	7.24	44.35	32.60	50.37	38.62
A	QPSK	ESS 40/60 10.0 MHz 15 kHz SCS	7.24	44.36	35.67	50.38	41.69
A	QPSK	ESS 40/60 20.0 MHz 15 kHz SCS	7.26	44.31	32.55	50.33	38.57
A	QPSK	ESS 90/10 10.0 MHz 15 kHz SCS	7.30	44.29	35.49	50.31	41.51
A	QPSK	ESS 90/10 20.0 MHz 15 kHz SCS	7.31	44.26	32.39	50.28	38.41

LTE/NR Carrier Bandwidth	Total Power PSD	EIRP Limit	EIRP Limit
	(dBm/MHz)	(W/MHz)	(dBm/MHz)
ESS 10/90 10.0 MHz 15 kHz SCS	41.62	1640	62.15
ESS 10/90 20.0 MHz 15 kHz SCS	38.62	1640	62.15
ESS 40/60 10.0 MHz 15 kHz SCS	41.69	1640	62.15
ESS 40/60 20.0 MHz 15 kHz SCS	38.57	1640	62.15
ESS 90/10 10.0 MHz 15 kHz SCS	41.51	1640	62.15
ESS 90/10 20.0 MHz 15 kHz SCS	38.41	1640	62.15



Antenna A - LTE / NR Modulation QPSK - LTE / NR Carrier Bandwidth ESS 10/90 10.0 MHz 15 kHz SCS - Channel Position M

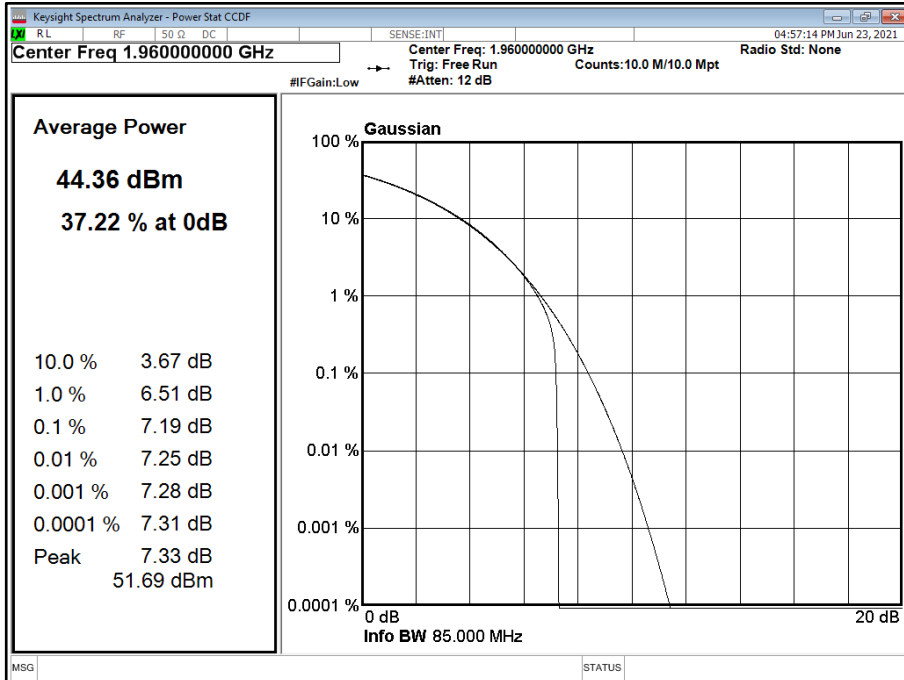

Antenna A - LTE / NR Modulation QPSK - LTE / NR Carrier Bandwidth ESS 10/90 20.0 MHz 15 kHz SCS - Channel Position M

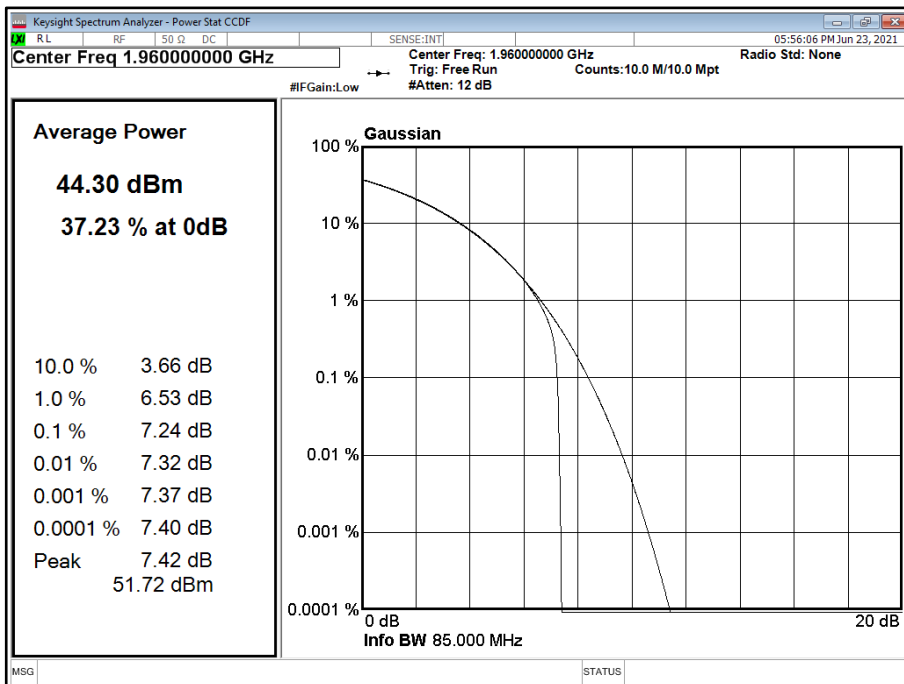



Antenna A - LTE / NR Modulation QPSK - LTE / NR Carrier Bandwidth ESS 40/60 10.0 MHz 15 kHz SCS - Channel Position M

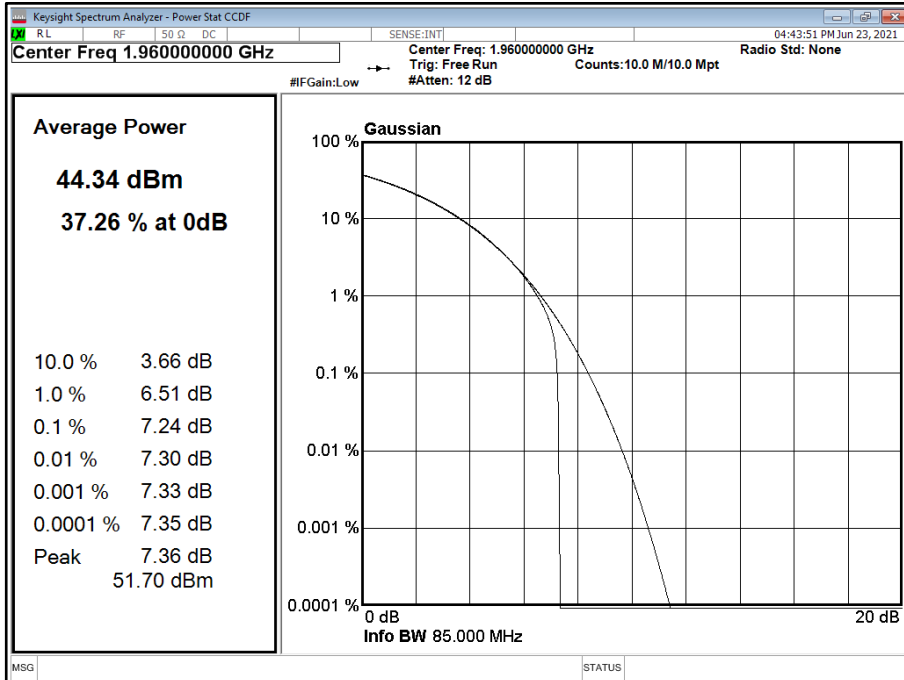

Antenna A - LTE / NR Modulation QPSK - LTE / NR Carrier Bandwidth ESS 40/60 20.0 MHz 15 kHz SCS - Channel Position M

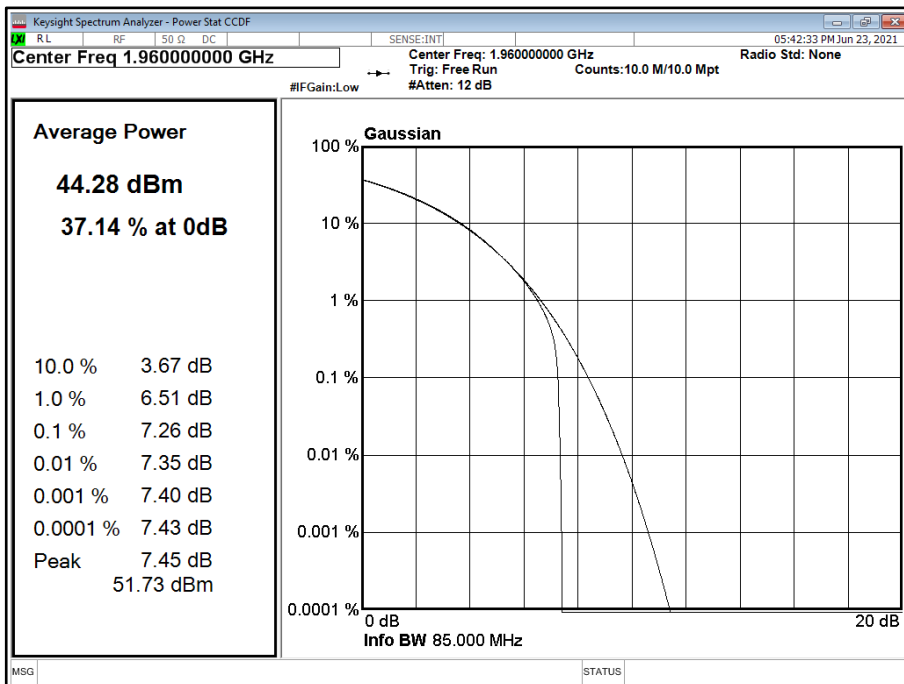



Antenna A - LTE / NR Modulation QPSK - LTE / NR Carrier Bandwidth ESS 90/10 10.0 MHz 15 kHz SCS - Channel Position M

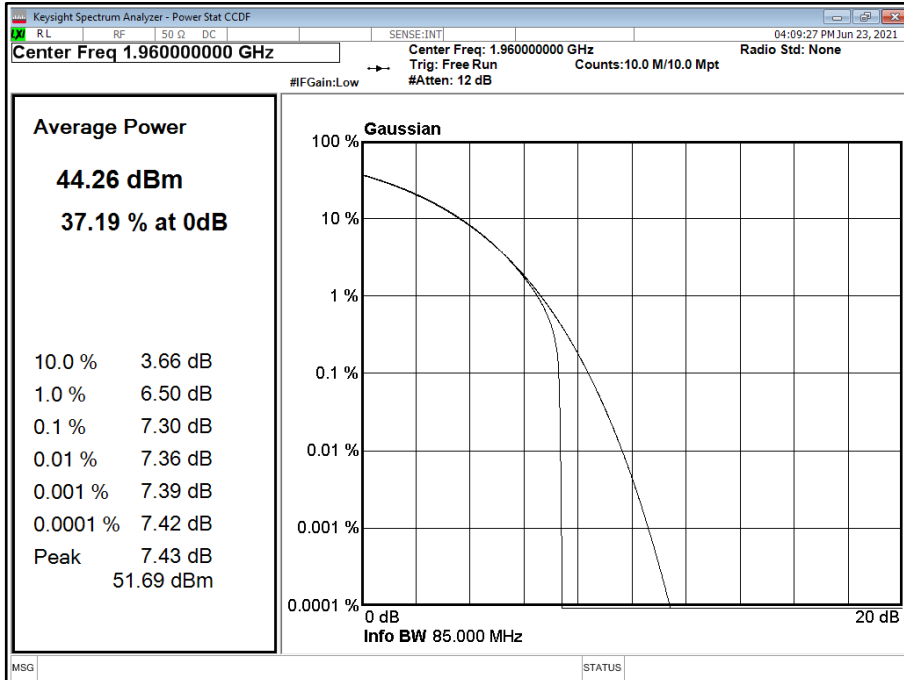

Antenna A - LTE / NR Modulation QPSK - LTE / NR Carrier Bandwidth ESS 90/10 20.0 MHz 15 kHz SCS - Channel Position M

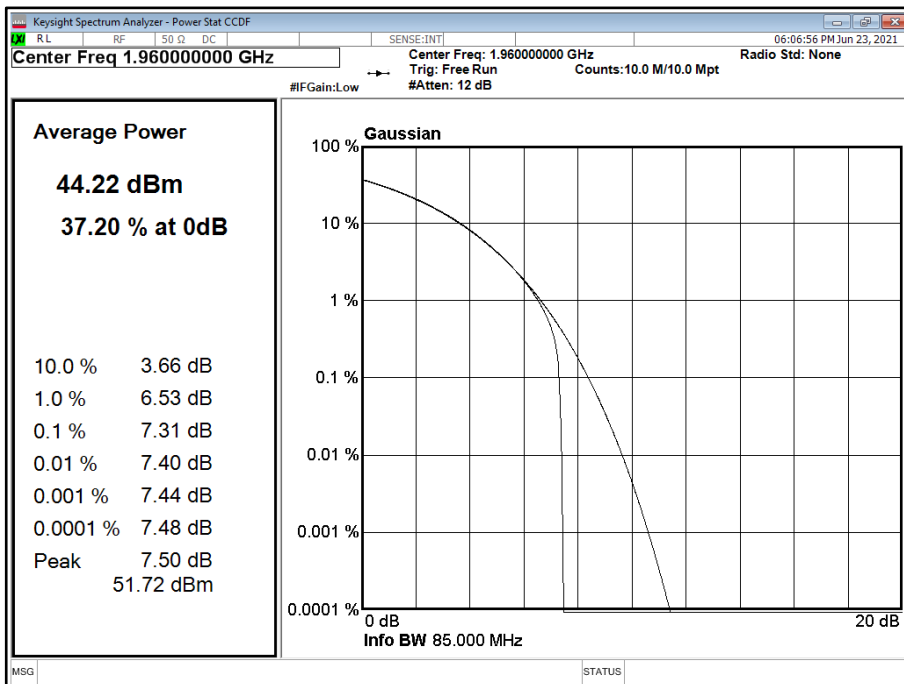



Configuration 1

Maximum Output Power 46.00 dBm

Antenna	LTE / NR Modulation	LTE / NR Carrier Bandwidth	Peak to Average Ratio (PAR) / Output Power / PSD				
			Channel Position T				
			PAR (dB)	Average Power/PSD		Total Power Port A+B+C+D	
dBm	dBm/MHz	dBm		dBm/MHz			
A	QPSK	ESS 10/90 10.0 MHz 15 kHz SCS	7.21	44.41	35.59	50.43	41.61
A	QPSK	ESS 10/90 20.0 MHz 15 kHz SCS	7.31	44.31	32.81	50.33	38.83
A	QPSK	ESS 40/60 10.0 MHz 15 kHz SCS	7.26	44.37	35.65	50.39	41.67
A	QPSK	ESS 40/60 20.0 MHz 15 kHz SCS	7.33	44.34	32.61	50.36	38.63
A	QPSK	ESS 90/10 10.0 MHz 15 kHz SCS	7.30	44.29	35.66	50.31	41.68
A	QPSK	ESS 90/10 20.0 MHz 15 kHz SCS	7.38	44.29	32.43	50.31	38.45

LTE/NR Carrier Bandwidth	Total Power PSD	EIRP Limit	EIRP Limit
	(dBm/MHz)	(W/MHz)	(dBm/MHz)
ESS 10/90 10.0 MHz 15 kHz SCS	41.61	1640	62.15
ESS 10/90 20.0 MHz 15 kHz SCS	38.83	1640	62.15
ESS 40/60 10.0 MHz 15 kHz SCS	41.67	1640	62.15
ESS 40/60 20.0 MHz 15 kHz SCS	38.63	1640	62.15
ESS 90/10 10.0 MHz 15 kHz SCS	41.68	1640	62.15
ESS 90/10 20.0 MHz 15 kHz SCS	38.45	1640	62.15

Antenna A - LTE / NR Modulation QPSK - LTE / NR Carrier Bandwidth ESS 10/90 10.0 MHz 15 kHz SCS - Channel Position T

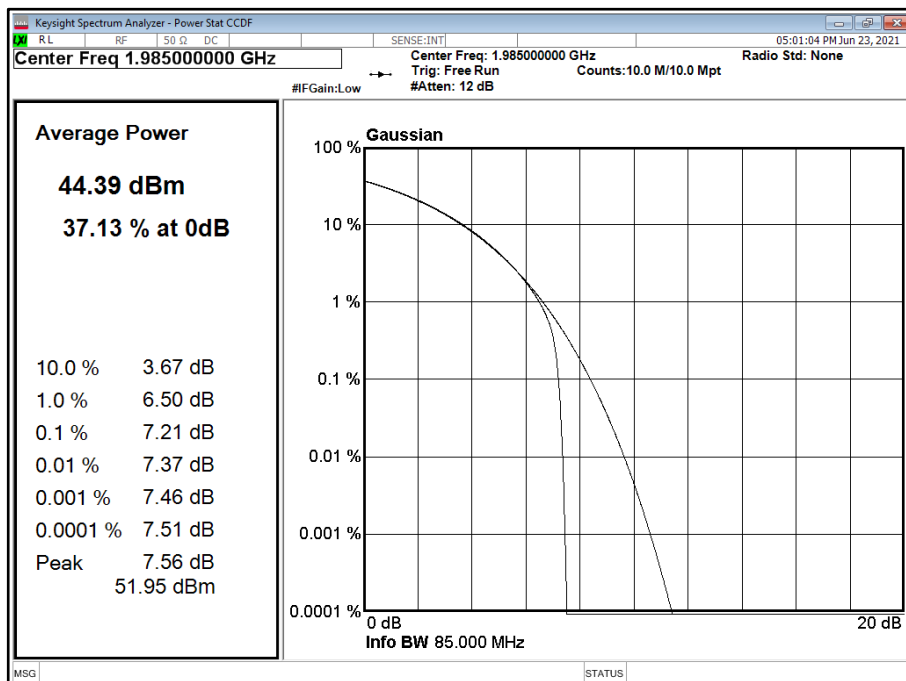



Antenna A - LTE / NR Modulation QPSK - LTE / NR Carrier Bandwidth ESS 10/90 20.0 MHz 15 kHz SCS - Channel Position T

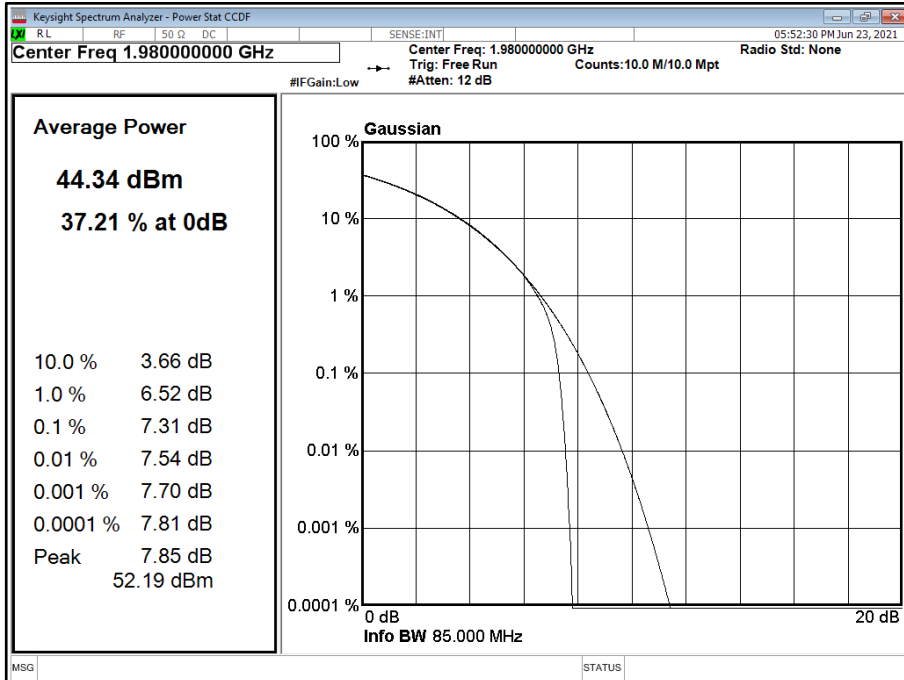

Antenna A - LTE / NR Modulation QPSK - LTE / NR Carrier Bandwidth ESS 40/60 10.0 MHz 15 kHz SCS - Channel Position T

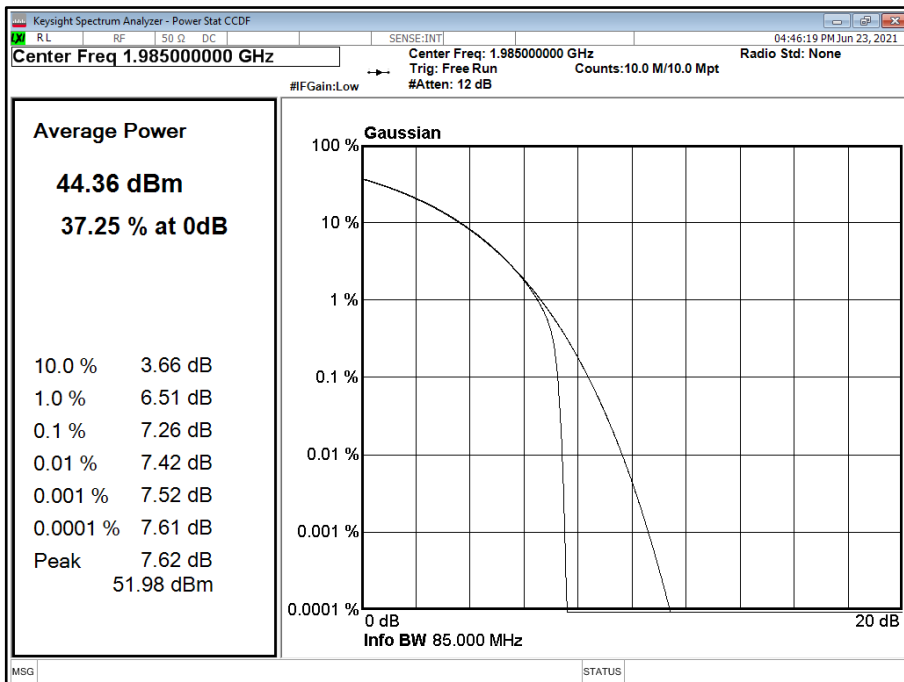



Antenna A - LTE / NR Modulation QPSK - LTE / NR Carrier Bandwidth ESS 40/60 20.0 MHz 15 kHz SCS - Channel Position T

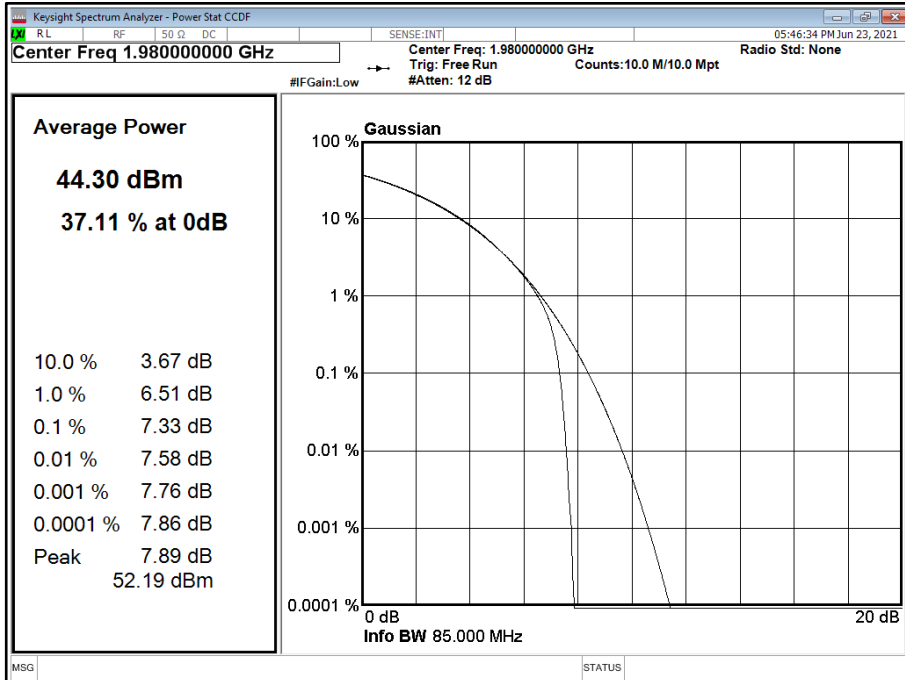

Antenna A - LTE / NR Modulation QPSK - LTE / NR Carrier Bandwidth ESS 90/10 10.0 MHz 15 kHz SCS - Channel Position T

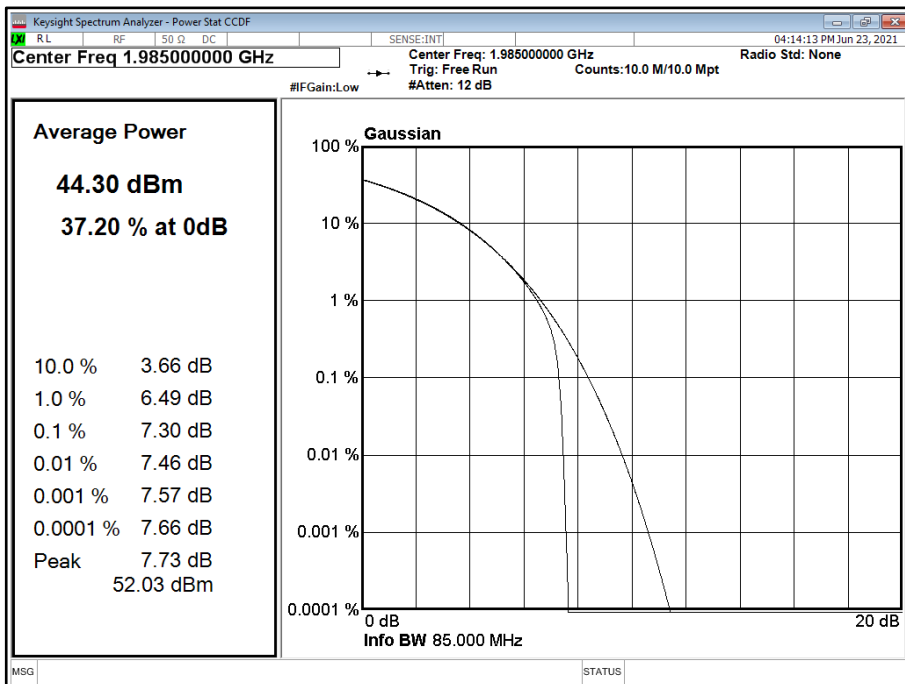



Antenna A - LTE / NR Modulation QPSK - LTE / NR Carrier Bandwidth ESS 90/10 20.0 MHz 15 kHz SCS - Channel Position T

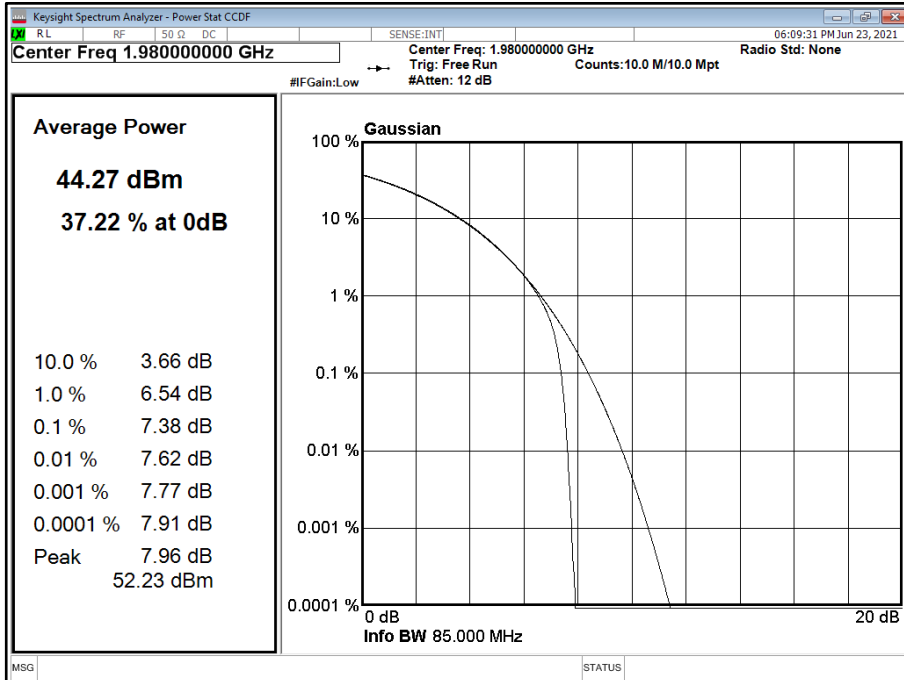

Configuration 2

Maximum Output Power 46.00 dBm

Antenna	LTE / NR Modulation	LTE / NR Carrier Bandwidth	Peak to Average Ratio (PAR) / Output Power / PSD				
			Channel Position B				
			PAR (dB)	Average Power/PSD (dBm)	Total Power Port A+B+C+D (dBm)		
A	QPSK	ESS 10/90 10.0 MHz 15 kHz SCS	-	44.22	31.15	50.24	37.17
A	QPSK	ESS 40/60 10.0 MHz 15 kHz SCS	-	44.23	31.10	50.25	37.12
A	QPSK	ESS 90/10 10.0 MHz 15 kHz SCS	-	44.19	30.87	50.21	36.89

LTE/NR Carrier Bandwidth	Total Power PSD	EIRP Limit	EIRP Limit
	(dBm/MHz)	(W/MHz)	(dBm/MHz)
ESS 10/90 10.0 MHz 15 kHz SCS	37.17	1640	62.15
ESS 40/60 10.0 MHz 15 kHz SCS	37.12	1640	62.15
ESS 90/10 10.0 MHz 15 kHz SCS	36.89	1640	62.15



Configuration 2

Maximum Output Power 46.00 dBm

Antenna	LTE / NR Modulation	LTE / NR Carrier Bandwidth	Peak to Average Ratio (PAR) / Output Power / PSD				
			Channel Position T				
			PAR (dB)	Average Power/PSD		Total Power Port A+B+C+D	
dBm	dBm/MHz	dBm		dBm/MHz			
A	QPSK	ESS 10/90 10.0 MHz 15 kHz SCS	-	44.25	30.90	50.27	36.92
A	QPSK	ESS 40/60 10.0 MHz 15 kHz SCS	-	44.25	31.00	50.27	37.02
A	QPSK	ESS 90/10 10.0 MHz 15 kHz SCS	-	44.18	30.89	50.20	36.91

LTE/NR Carrier Bandwidth	Total Power PSD	EIRP Limit	EIRP Limit
	(dBm/MHz)	(W/MHz)	(dBm/MHz)
ESS 10/90 10.0 MHz 15 kHz SCS	37.17	1640	62.15
ESS 40/60 10.0 MHz 15 kHz SCS	37.12	1640	62.15
ESS 90/10 10.0 MHz 15 kHz SCS	36.89	1640	62.15

Configuration 3

Maximum Output Power 46.00 dBm

Antenna	NR Modulation	NR Carrier Bandwidth	Peak to Average Ratio (PAR) / Output Power / PSD				
			Channel Position B				
			PAR (dB)	Average Power/PSD		Total Power Port A+B+C+D	
dBm	dBm/MHz	dBm		dBm/MHz			
A	QPSK	10.0 MHz 15 kHz SCS	7.22	44.56	35.77	50.58	41.79
A	QPSK	20.0 MHz 15 kHz SCS	7.37	44.47	32.67	50.49	38.69

NR Carrier Bandwidth	Total Power PSD	EIRP Limit	EIRP Limit
	(dBm/MHz)	(W/MHz)	(dBm/MHz)
10.0 MHz 15 kHz SCS	41.79	1640	62.15
20.0 MHz 15 kHz SCS	38.69	1640	62.15



Antenna A - NR Modulation QPSK - NR Carrier Bandwidth 10.0 MHz 15 kHz SCS - Channel Position B

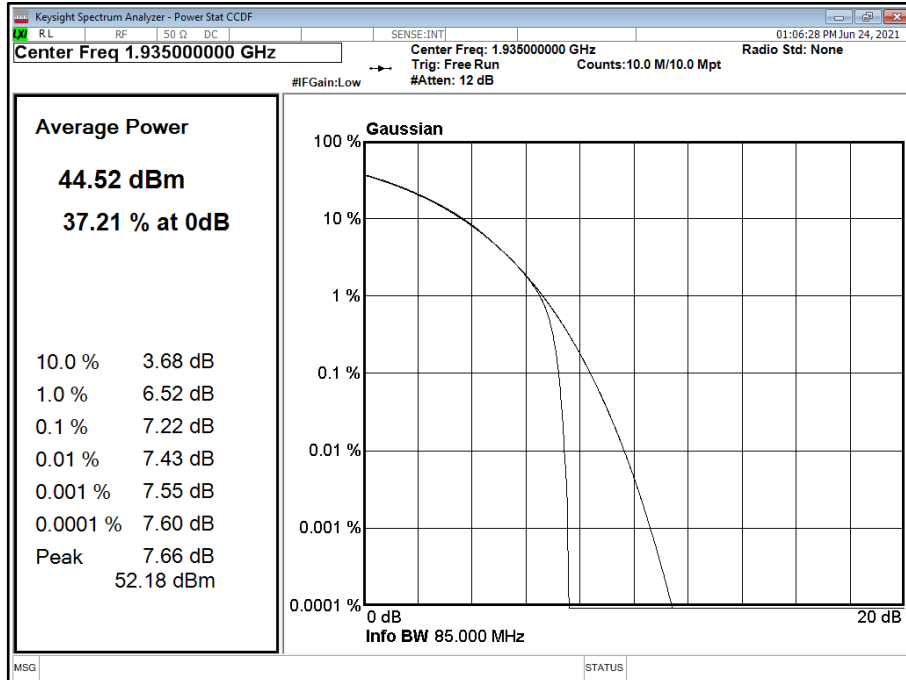

Antenna A - NR Modulation QPSK - NR Carrier Bandwidth 20.0 MHz 15 kHz SCS - Channel Position B

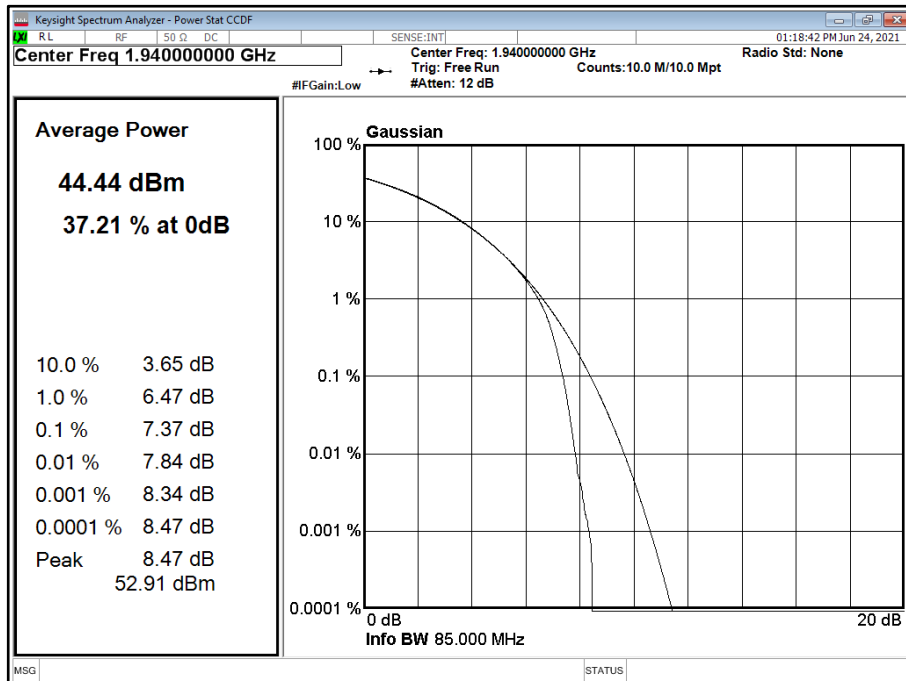



Configuration 3

Maximum Output Power 46.00 dBm

Antenna	NR Modulation	NR Carrier Bandwidth	Peak to Average Ratio (PAR) / Output Power / PSD				
			Channel Position M				
			PAR (dB)	Average Power/PSD		Total Power Port A+B+C+D	
dBm	dBm/MHz	dBm		dBm/MHz			
A	QPSK	10.0 MHz 15 kHz SCS	7.13	44.55	35.62	50.57	41.64
A	QPSK	20.0 MHz 15 kHz SCS	7.12	44.44	32.54	50.46	38.56

NR Carrier Bandwidth	Total Power PSD	EIRP Limit	EIRP Limit
	(dBm/MHz)	(W/MHz)	(dBm/MHz)
10.0 MHz 15 kHz SCS	41.64	1640	62.15
20.0 MHz 15 kHz SCS	38.56	1640	62.15

Antenna A - NR Modulation QPSK - NR Carrier Bandwidth 10.0 MHz 15 kHz SCS - Channel Position M

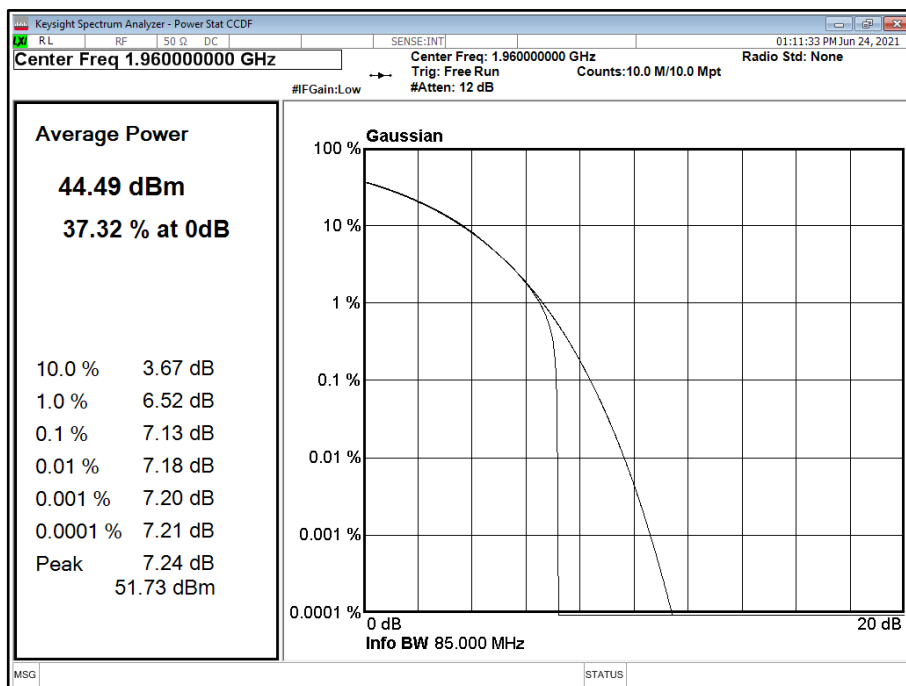



Antenna A - NR Modulation QPSK - NR Carrier Bandwidth 20.0 MHz 15 kHz SCS - Channel Position M

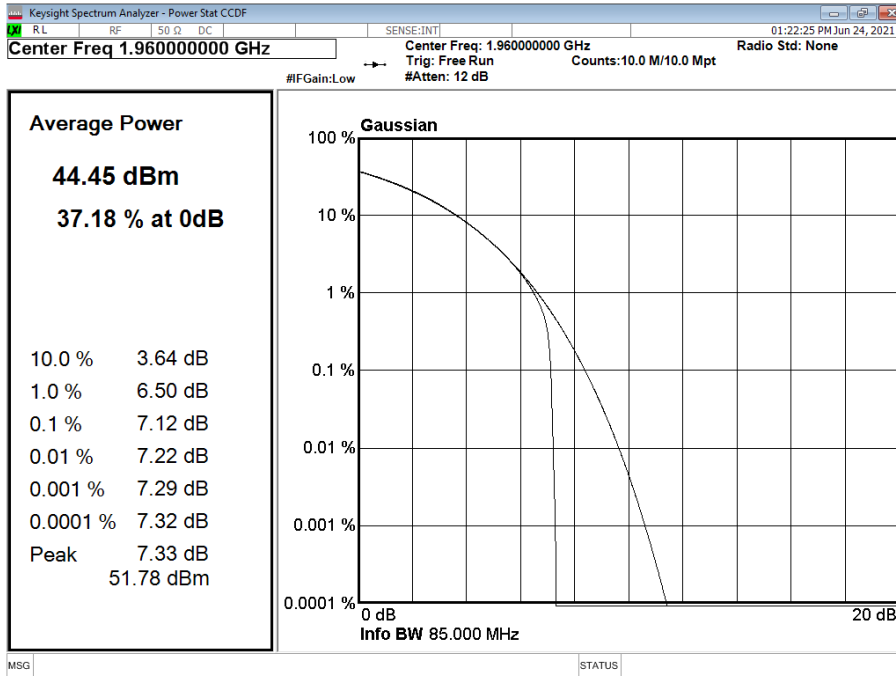

Configuration 3

Maximum Output Power 46.00 dBm

Antenna	NR Modulation	NR Carrier Bandwidth	Peak to Average Ratio (PAR) / Output Power / PSD				
			Channel Position T				
			PAR (dB)	Average Power/PSD		Total Power Port A+B+C+D	
			dBm	dBm/MHz	dBm	dBm/MHz	
A	QPSK	10.0 MHz 15 kHz SCS	7.14	44.52	35.67	50.54	41.69
A	QPSK	20.0 MHz 15 kHz SCS	7.23	44.52	32.56	50.54	38.58

NR Carrier Bandwidth	Total Power PSD	EIRP Limit	EIRP Limit
	(dBm/MHz)	(W/MHz)	(dBm/MHz)
10.0 MHz 15 kHz SCS	41.69	1640	62.15
20.0 MHz 15 kHz SCS	38.58	1640	62.15



Antenna A - NR Modulation QPSK - NR Carrier Bandwidth 10.0 MHz 15 kHz SCS - Channel Position T

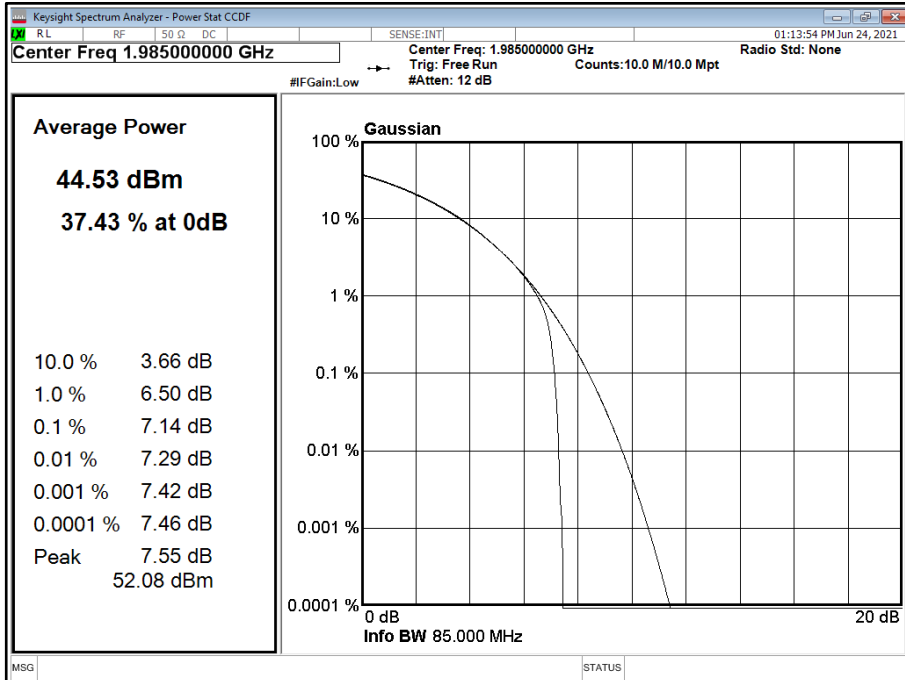

Antenna A - NR Modulation QPSK - NR Carrier Bandwidth 20.0 MHz 15 kHz SCS - Channel Position T

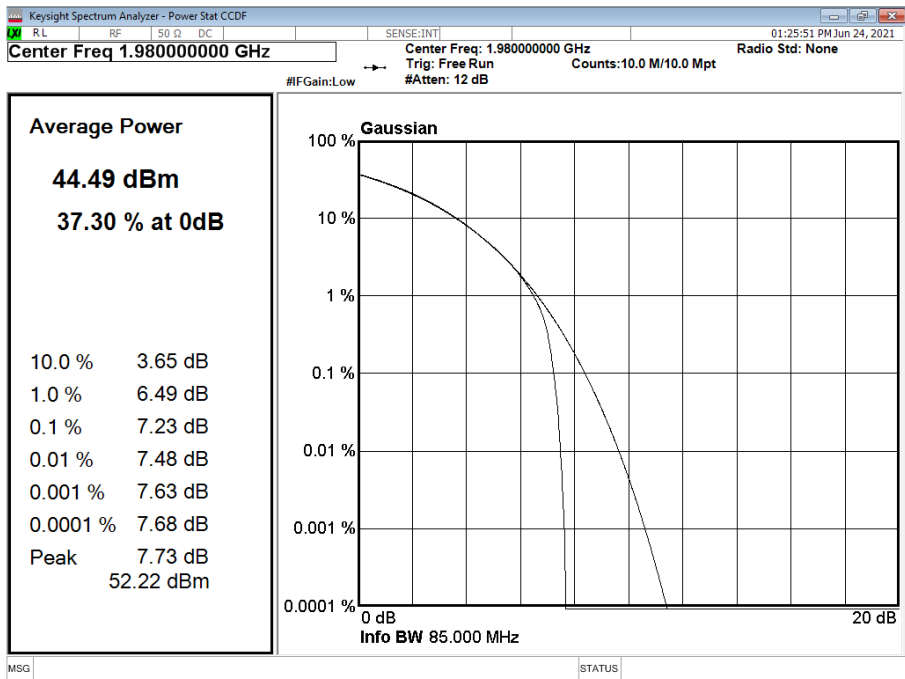



Configuration 4

Maximum Output Power 46.00 dBm

Antenna	NR Modulation	NR Carrier Bandwidth	Peak to Average Ratio (PAR) / Output Power / PSD				
			Channel Position B				
			PAR (dB)	Average Power/PSD		Total Power Port A+B+C+D	
dBm	dBm/MHz	dBm		dBm/MHz			
A	QPSK	10.0 MHz 15 kHz SCS	-	44.34	30.87	50.36	36.89

NR Carrier Bandwidth	Total Power PSD	EIRP Limit	EIRP Limit
	(dBm/MHz)	(W/MHz)	(dBm/MHz)
10.0 MHz 15 kHz SCS	36.89	1640	62.15

Configuration 4

Maximum Output Power 46.00 dBm

Antenna	NR Modulation	NR Carrier Bandwidth	Peak to Average Ratio (PAR) / Output Power / PSD				
			Channel Position T				
			PAR (dB)	Average Power/PSD		Total Power Port A+B+C+D	
dBm	dBm/MHz	dBm		dBm/MHz			
A	QPSK	10.0 MHz 15 kHz SCS	-	44.35	31.13	50.37	37.15

NR Carrier Bandwidth	Total Power PSD	EIRP Limit	EIRP Limit
	(dBm/MHz)	(W/MHz)	(dBm/MHz)
10.0 MHz 15 kHz SCS	37.15	1640	62.15



2.2 OCCUPIED BANDWIDTH

2.2.1 Specification Reference

FCC CFR 47 Part 24, Clause 24.238 (b)
FCC CFR 47 Part 2, Clause 2.1049
ISED RSS-GEN, Clause 6.7

2.2.2 Date of Test and Modification State

23 and 24 June 2021 - Modification State 0

2.2.3 Test Equipment Used

The major items of test equipment used for the above tests are identified in Section 3.1.

2.2.4 Environmental Conditions

Ambient Temperature	22.2 - 24.2°C
Relative Humidity	43.9 - 45.6%

2.2.5 Test Method

All measurements were made in accordance with FCC KDB 971168 D01, Clause 4.3. The Spectrum Analyser RBW was configured to be at least 1% of the channel bandwidth of the carrier to be measured.

For 26 dB Bandwidth, in accordance with KDB 971168 D01, a peak detector and a trace setting of Max Hold were used. The trace was allowed to stabilise. Using the Spectrum Analyser function, the 26dB measurement result was obtained.

4.3 Occupied bandwidth – power bandwidth (99 %) measurement procedure
Subclause 5.4.4 of ANSI C63.26-2015 is applicable (wherein the recommendation is to use the 99 % power bandwidth function of a spectrum analyser).

2.2.6 Test Results

Configuration 1

Maximum Output Power 46.00 dBm



Antenna	LTE / NR Modulation	LTE / NR Carrier Bandwidth	Result (MHz)					
			Channel Position B		Channel Position M		Channel Position T	
			Occupied Bandwidth	-26 dB Bandwidth	Occupied Bandwidth	-26 dB Bandwidth	Occupied Bandwidth	-26 dB Bandwidth
A	QPSK	ESS 10/90 10.0 MHz 15 kHz SCS	9129.54	9694.90	9132.11	9711.34	9118.33	9738.20
A	QPSK	ESS 10/90 20.0 MHz 15 kHz SCS	18419.58	19523.81	18383.84	19640.25	18472.11	19619.71
A	QPSK	ESS 40/60 10.0 MHz 15 kHz SCS	9117.24	9756.08	9129.95	9751.28	9124.01	9709.46
A	QPSK	ESS 40/60 20.0 MHz 15 kHz SCS	18361.71	19570.73	18452.68	19453.34	18384.87	19594.20
A	QPSK	ESS 90/10 10.0 MHz 15 kHz SCS	9130.33	9730.95	9125.59	9750.54	9113.73	9753.18
A	QPSK	ESS 90/10 20.0 MHz 15 kHz SCS	18438.73	19544.13	18390.36	19643.44	18427.09	19634.50

Antenna A - LTE / NR Modulation QPSK - LTE / NR Carrier Bandwidth ESS 10/90 10.0 MHz 15 kHz SCS - Channel Position B

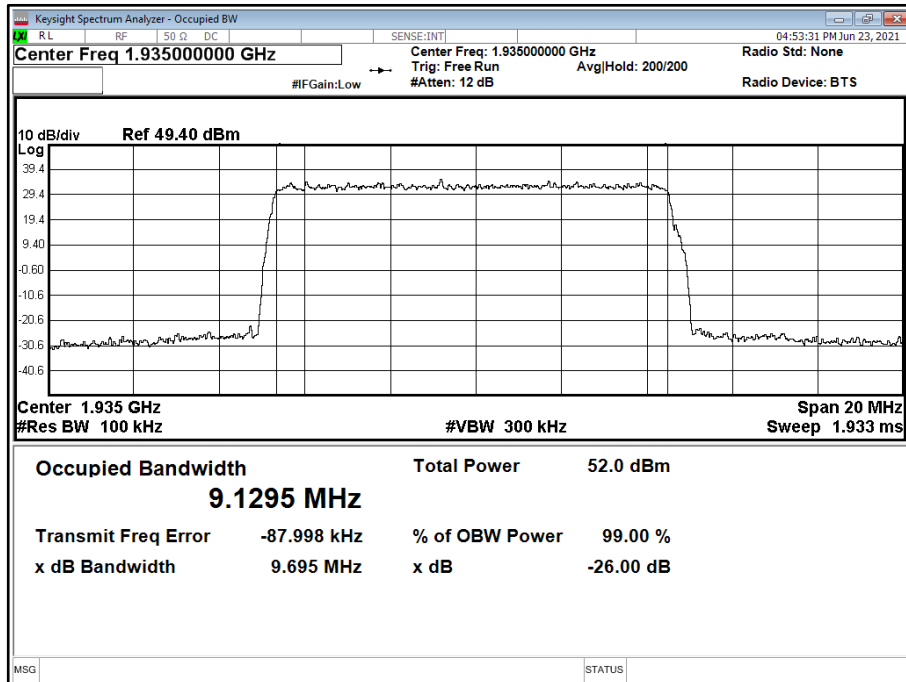



Antenna A - LTE / NR Modulation QPSK - LTE / NR Carrier Bandwidth ESS 10/90 10.0 MHz 15 kHz SCS - Channel Position M

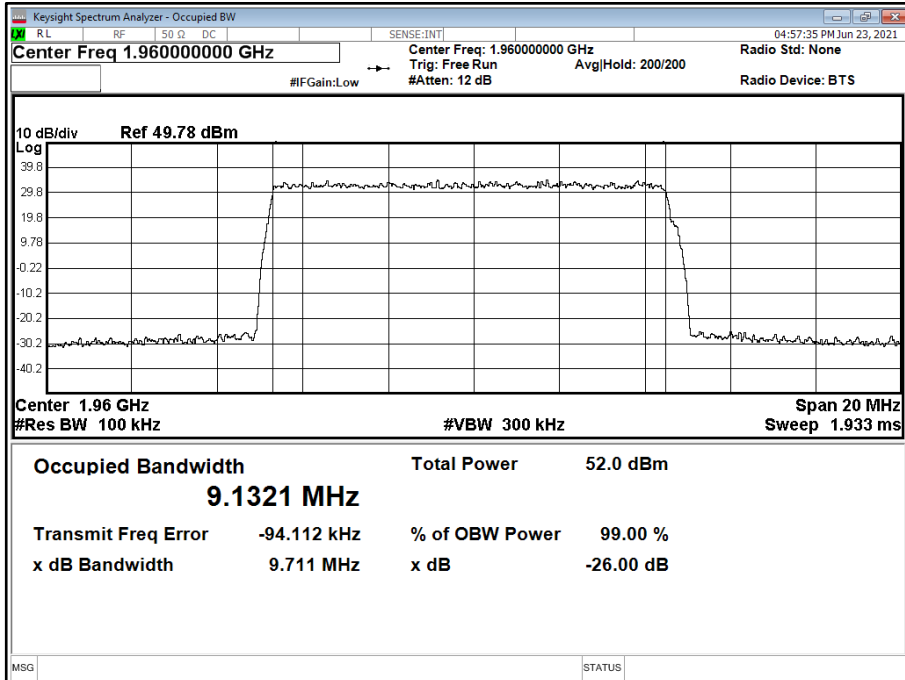

Antenna A - LTE / NR Modulation QPSK - LTE / NR Carrier Bandwidth ESS 10/90 10.0 MHz 15 kHz SCS - Channel Position T

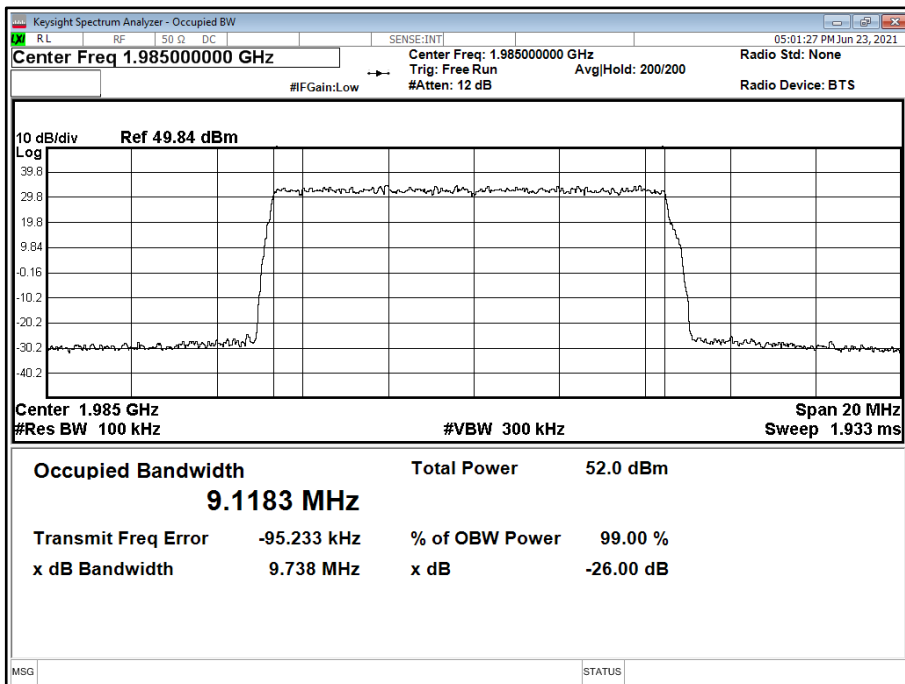



Antenna A - LTE / NR Modulation QPSK - LTE / NR Carrier Bandwidth ESS 10/90 20.0 MHz 15 kHz SCS - Channel Position B

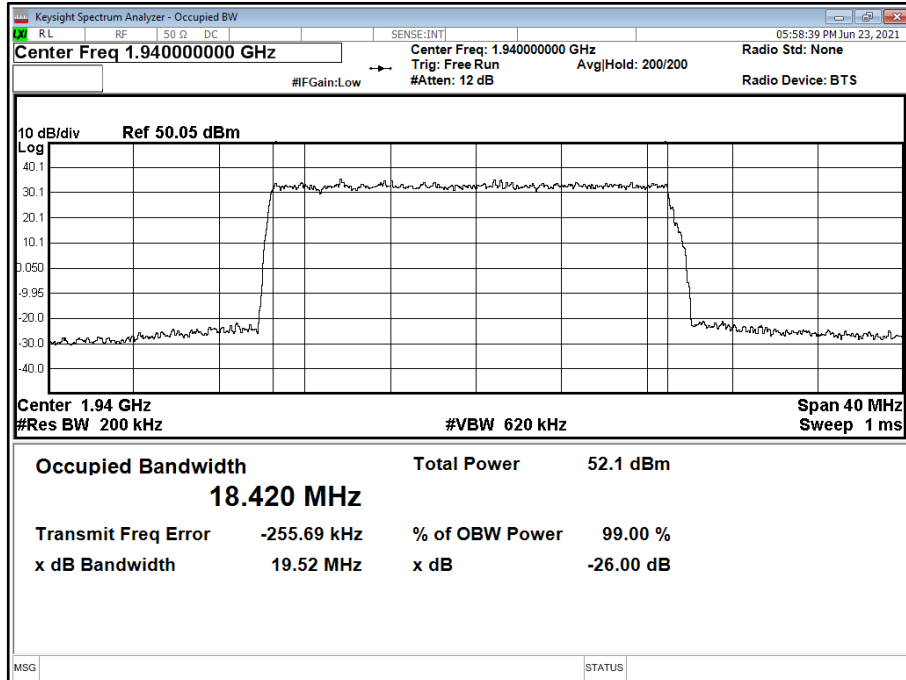

Antenna A - LTE / NR Modulation QPSK - LTE / NR Carrier Bandwidth ESS 10/90 20.0 MHz 15 kHz SCS - Channel Position M

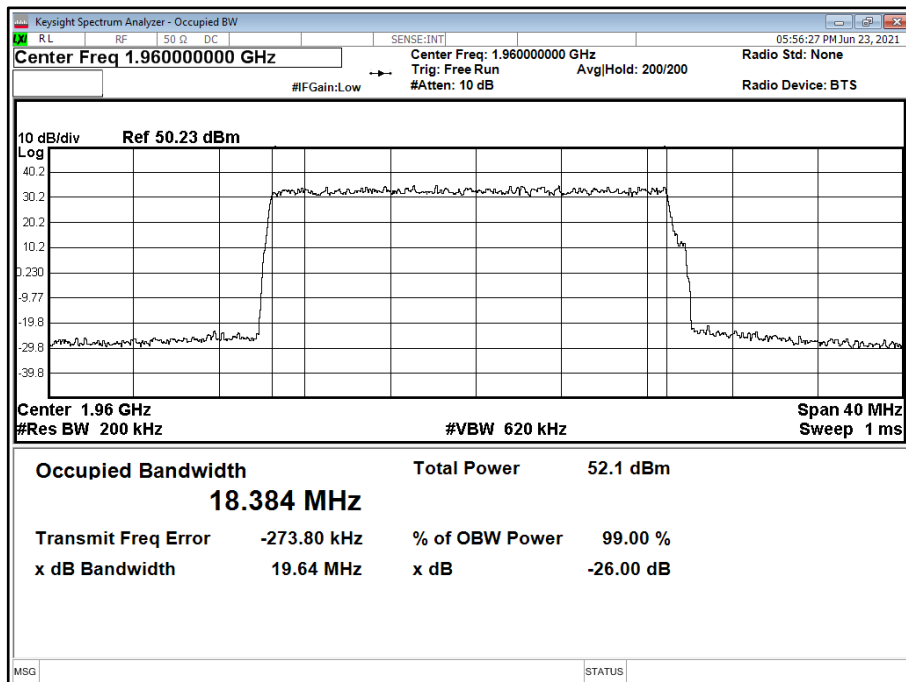



Antenna A - LTE / NR Modulation QPSK - LTE / NR Carrier Bandwidth ESS 10/90 20.0 MHz 15 kHz SCS - Channel Position T

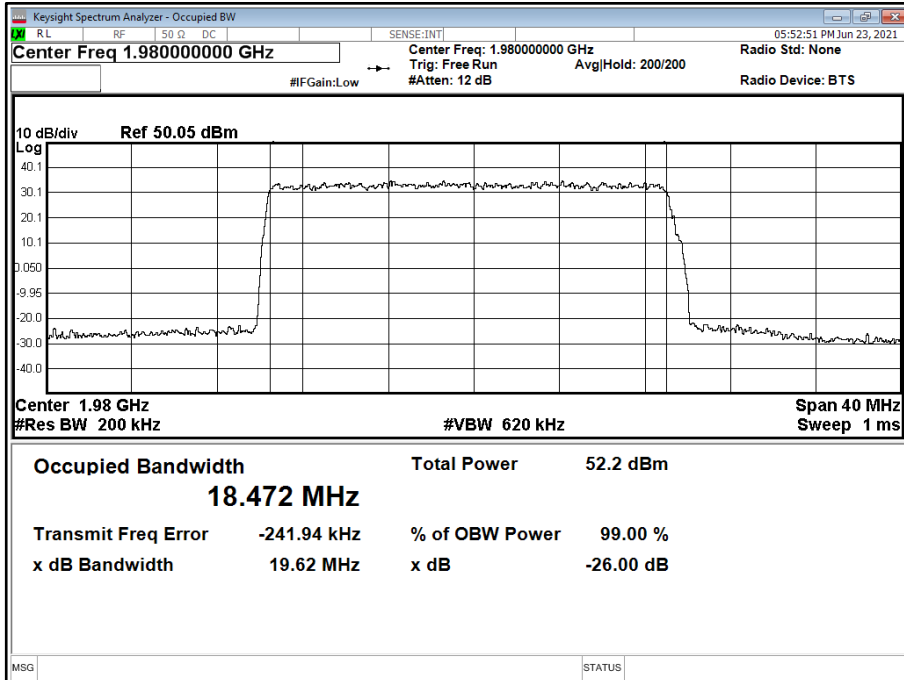

Antenna A - LTE / NR Modulation QPSK - LTE / NR Carrier Bandwidth ESS 40/60 10.0 MHz 15 kHz SCS - Channel Position B

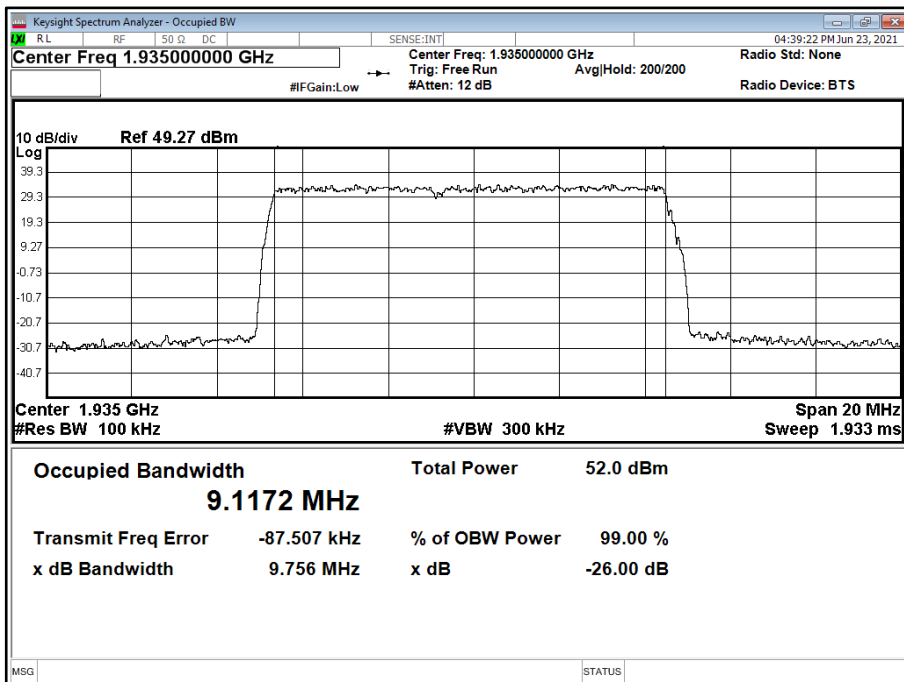



Antenna A - LTE / NR Modulation QPSK - LTE / NR Carrier Bandwidth ESS 40/60 10.0 MHz 15 kHz SCS - Channel Position M

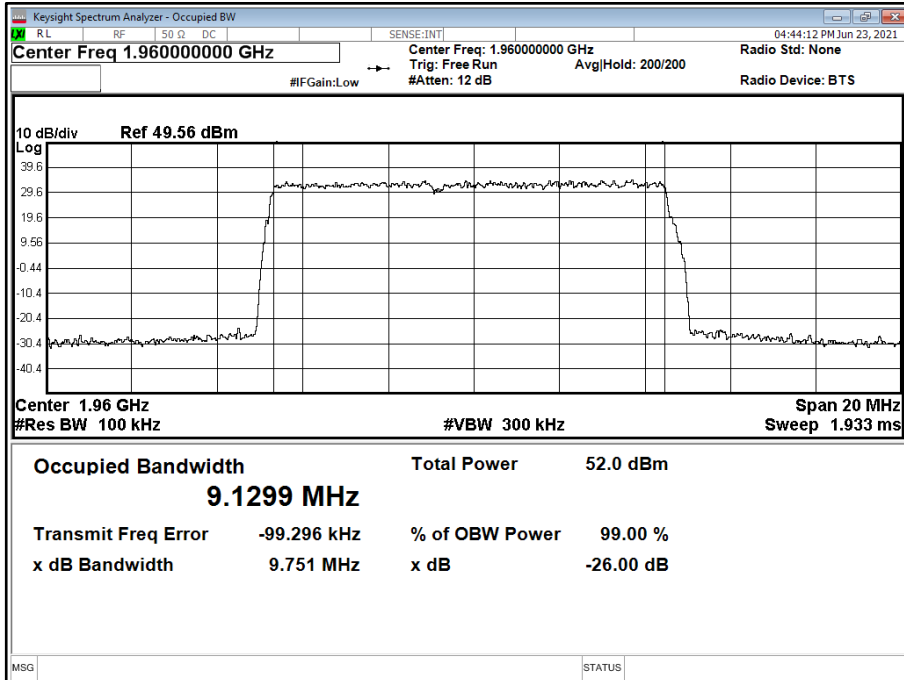

Antenna A - LTE / NR Modulation QPSK - LTE / NR Carrier Bandwidth ESS 40/60 10.0 MHz 15 kHz SCS - Channel Position T

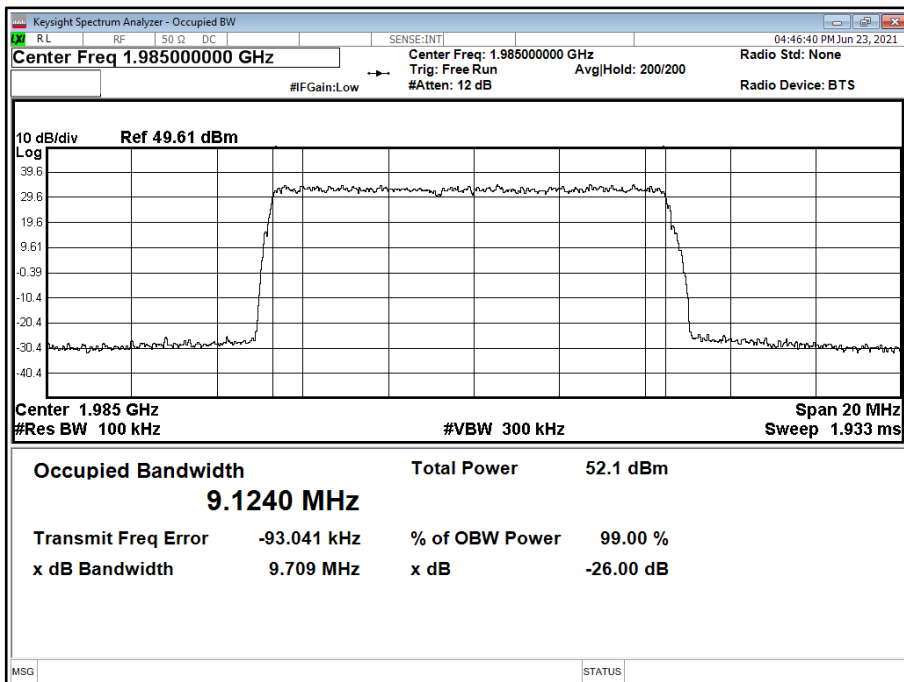



Antenna A - LTE / NR Modulation QPSK - LTE / NR Carrier Bandwidth ESS 40/60 20.0 MHz 15 kHz SCS - Channel Position B

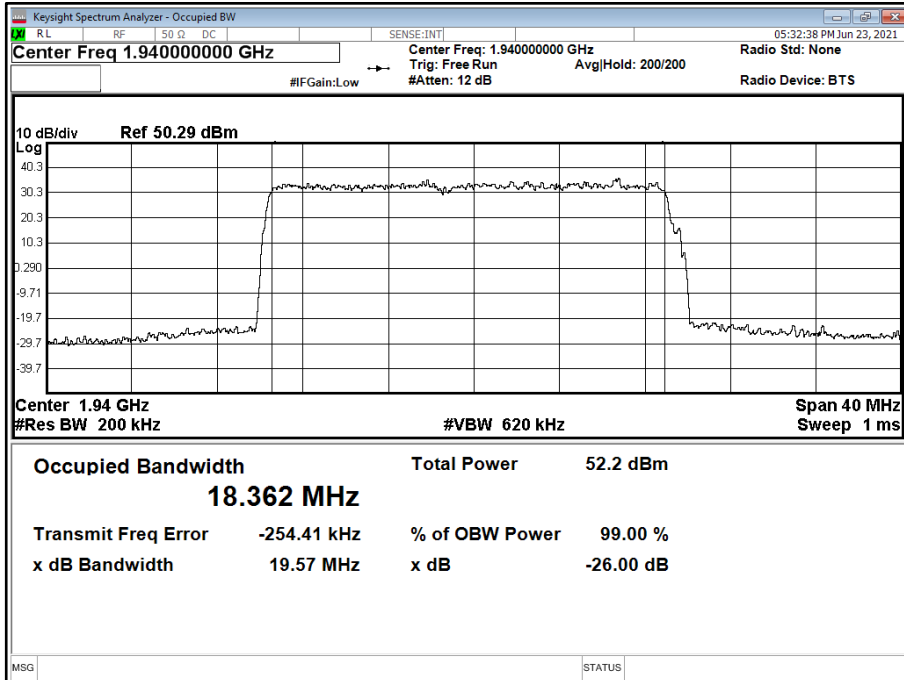

Antenna A - LTE / NR Modulation QPSK - LTE / NR Carrier Bandwidth ESS 40/60 20.0 MHz 15 kHz SCS - Channel Position M

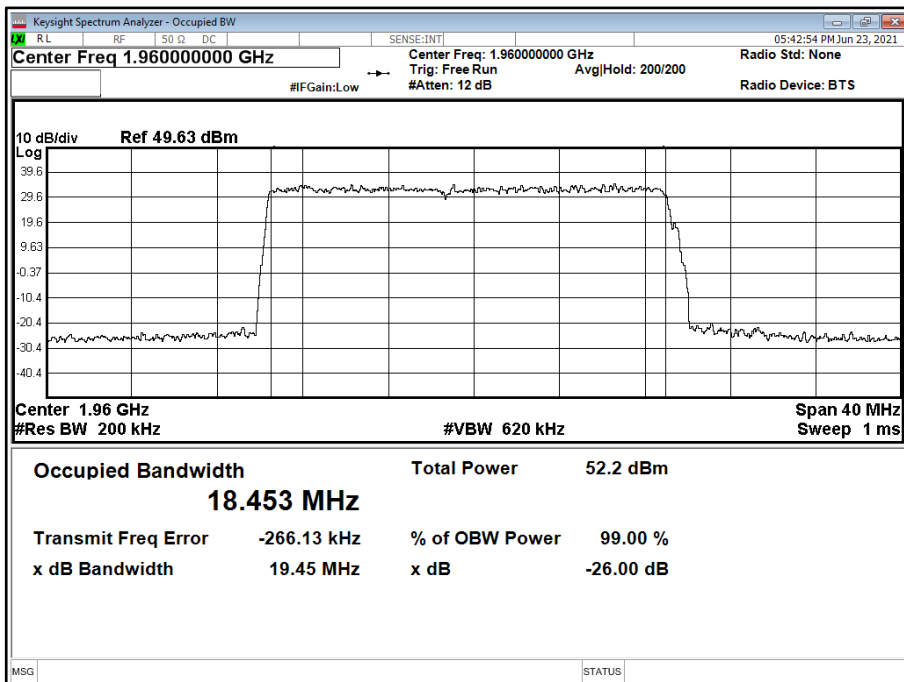



Antenna A - LTE / NR Modulation QPSK - LTE / NR Carrier Bandwidth ESS 40/60 20.0 MHz 15 kHz SCS - Channel Position T

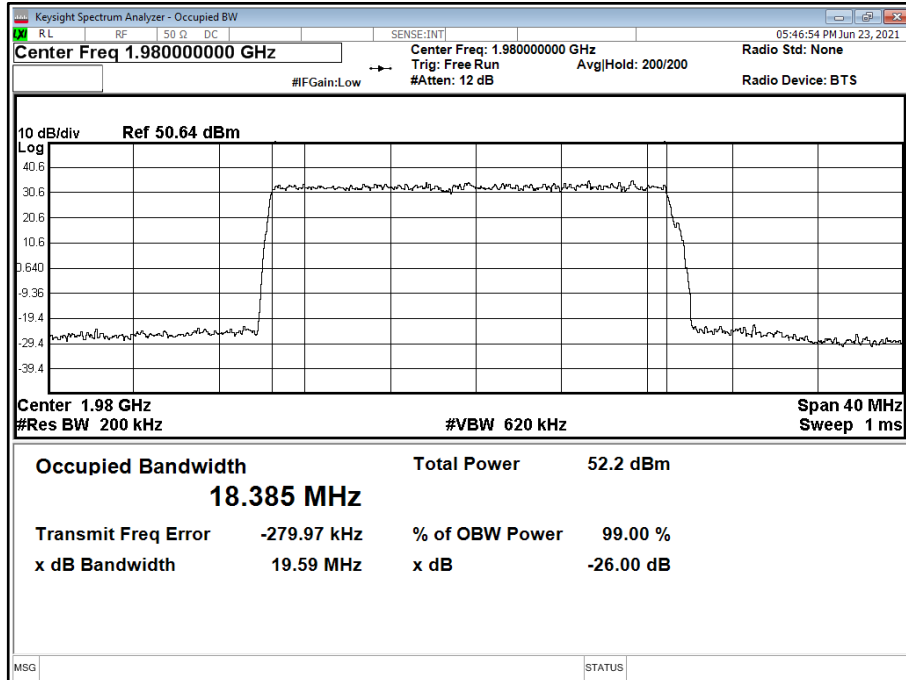

Antenna A - LTE / NR Modulation QPSK - LTE / NR Carrier Bandwidth ESS 90/10 10.0 MHz 15 kHz SCS - Channel Position B

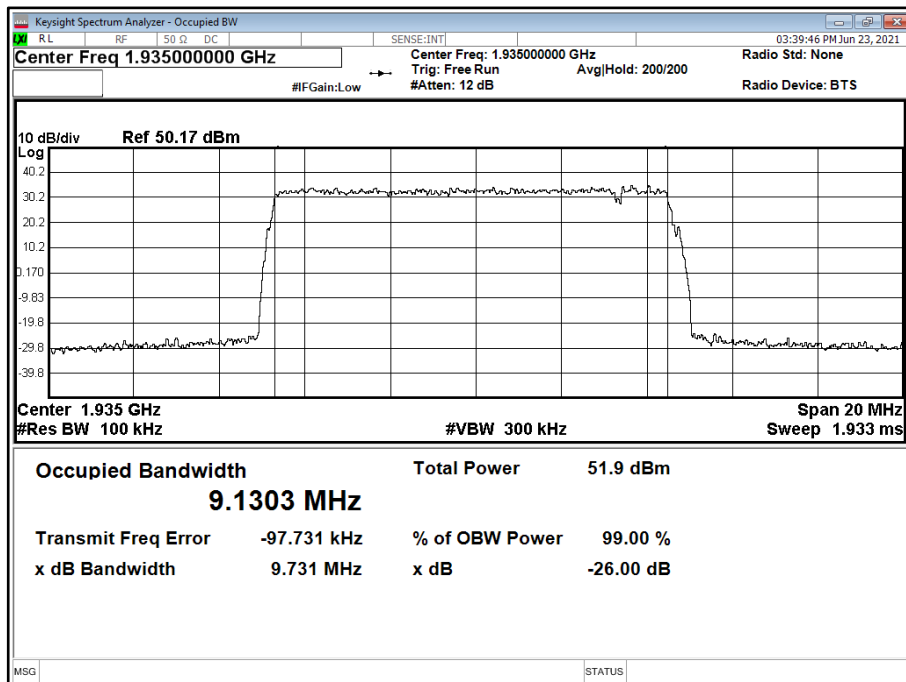



Antenna A - LTE / NR Modulation QPSK - LTE / NR Carrier Bandwidth ESS 90/10 10.0 MHz 15 kHz SCS - Channel Position M

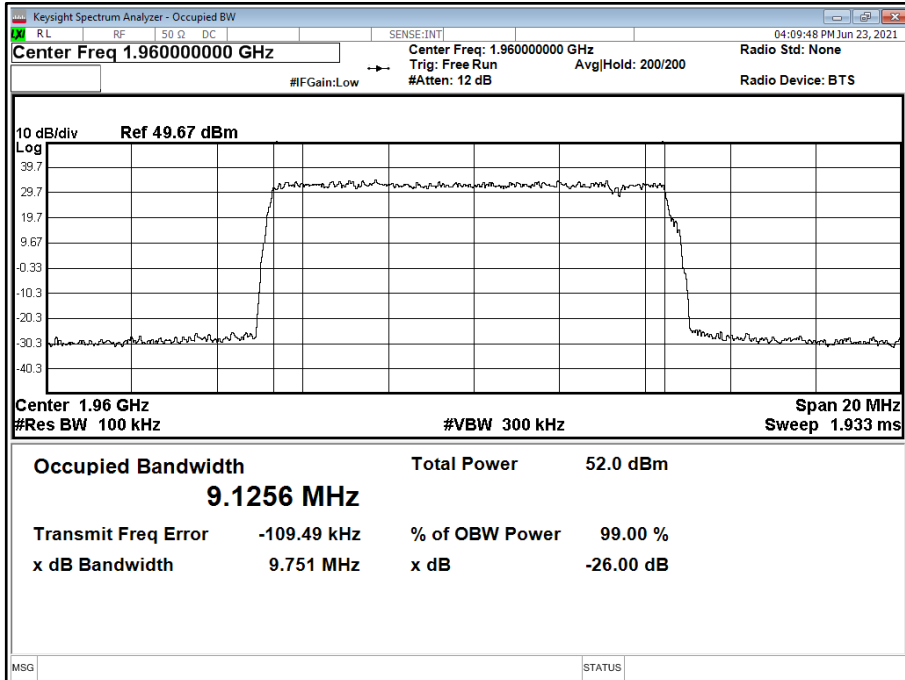

Antenna A - LTE / NR Modulation QPSK - LTE / NR Carrier Bandwidth ESS 90/10 10.0 MHz 15 kHz SCS - Channel Position T

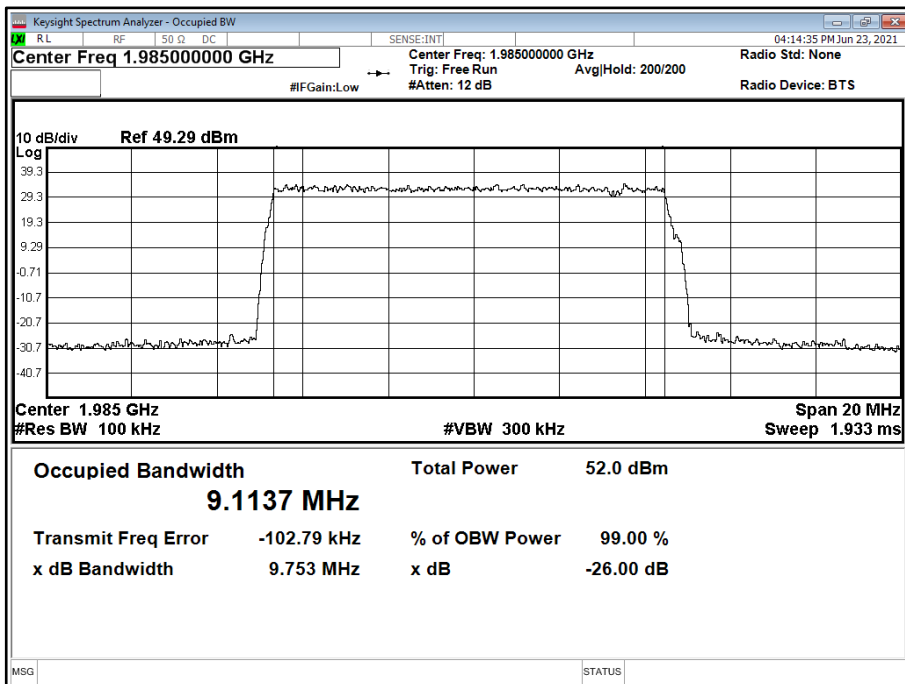



Antenna A - LTE / NR Modulation QPSK - LTE / NR Carrier Bandwidth ESS 90/10 20.0 MHz 15 kHz SCS - Channel Position B

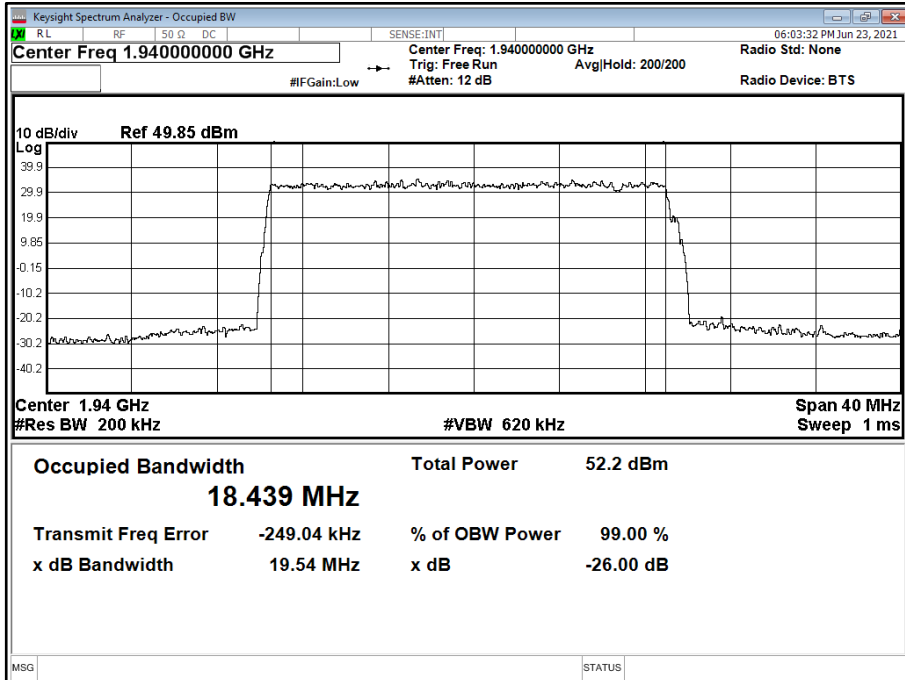

Antenna A - LTE / NR Modulation QPSK - LTE / NR Carrier Bandwidth ESS 90/10 20.0 MHz 15 kHz SCS - Channel Position M

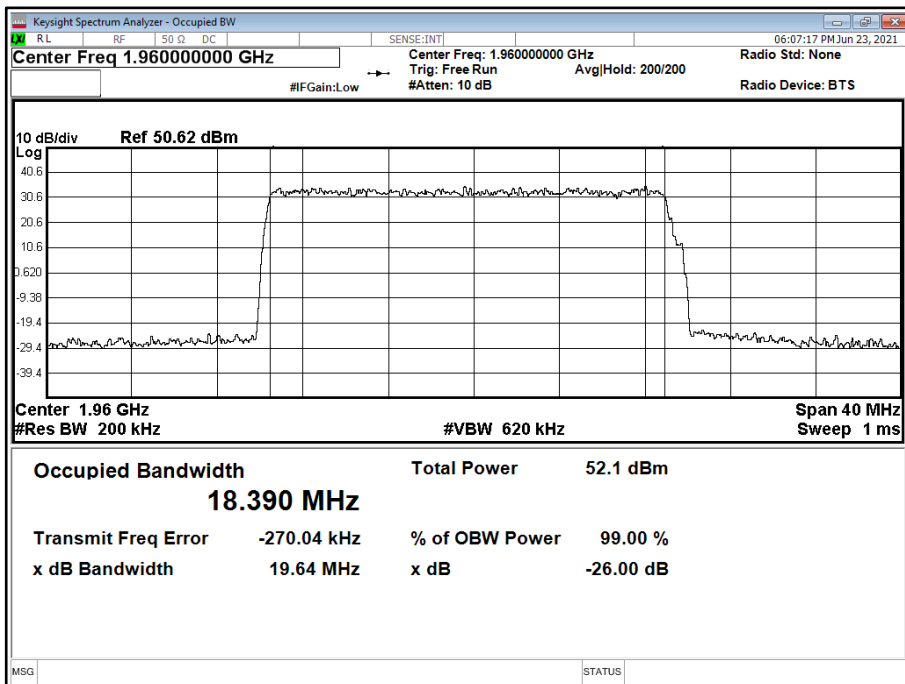



Antenna A - LTE / NR Modulation QPSK - LTE / NR Carrier Bandwidth ESS 90/10 20.0 MHz 15 kHz SCS - Channel Position T

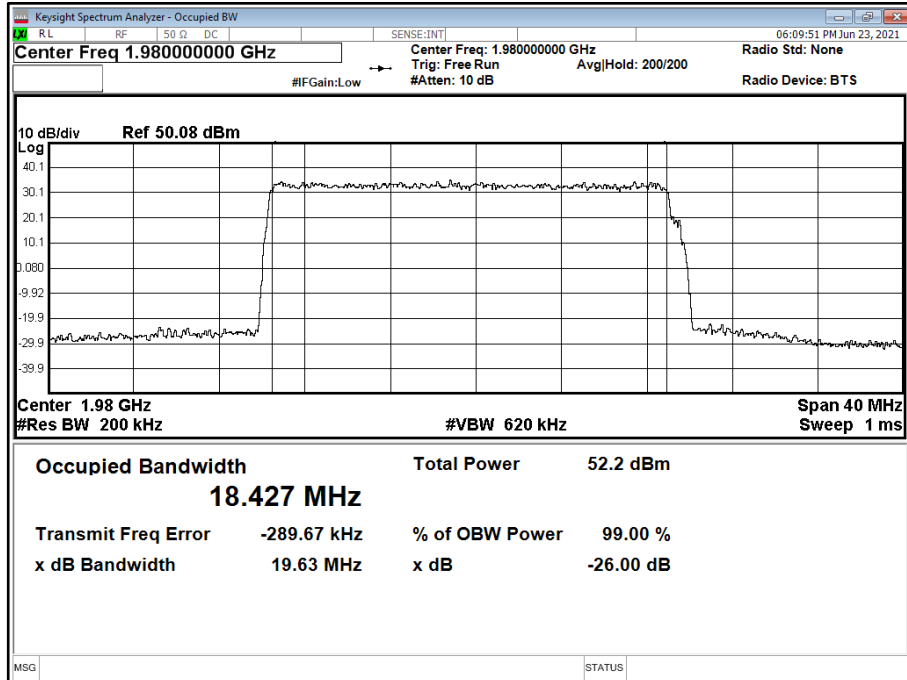

Configuration 2

Maximum Output Power 46.00 dBm

Antenna	LTE / NR Modulation	LTE / NR Carrier Bandwidth	Result (MHz)					
			Channel Position B		Channel Position M		Channel Position T	
			Occupied Bandwidth	-26 dB Bandwidth	Occupied Bandwidth	-26 dB Bandwidth	Occupied Bandwidth	-26 dB Bandwidth
A	QPSK	ESS 10/90 10.0 MHz 15 kHz SCS	29004.08	29912.07	-	-	28994.08	29944.94
A	QPSK	ESS 40/60 10.0 MHz 15 kHz SCS	28994.26	29896.02	-	-	29026.45	29911.16
A	QPSK	ESS 90/10 10.0 MHz 15 kHz SCS	29024.97	29950.33	-	-	29031.32	29908.35



Antenna A - LTE / NR Modulation QPSK - LTE / NR Carrier Bandwidth ESS 10/90 10.0 MHz 15 kHz SCS - Channel Position B

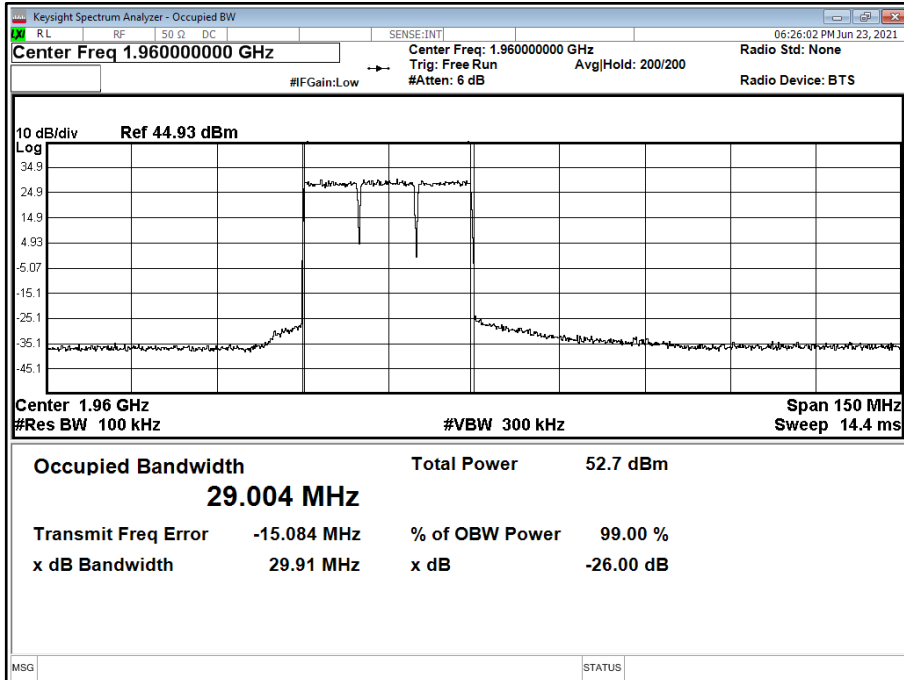

Antenna A - LTE / NR Modulation QPSK - LTE / NR Carrier Bandwidth ESS 10/90 10.0 MHz 15 kHz SCS - Channel Position T

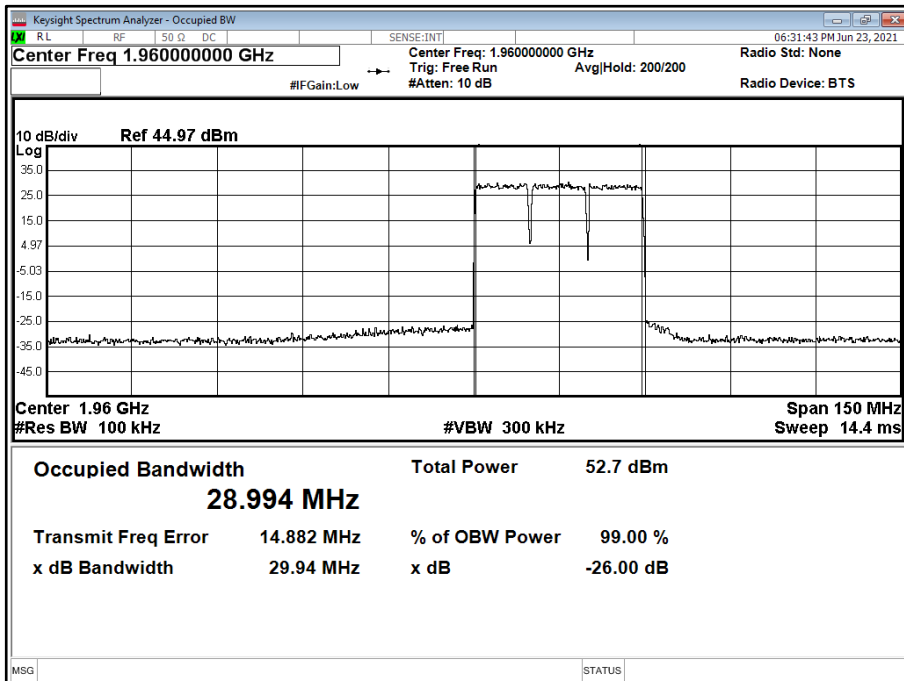



Antenna A - LTE / NR Modulation QPSK - LTE / NR Carrier Bandwidth ESS 40/60 10.0 MHz 15 kHz SCS - Channel Position B

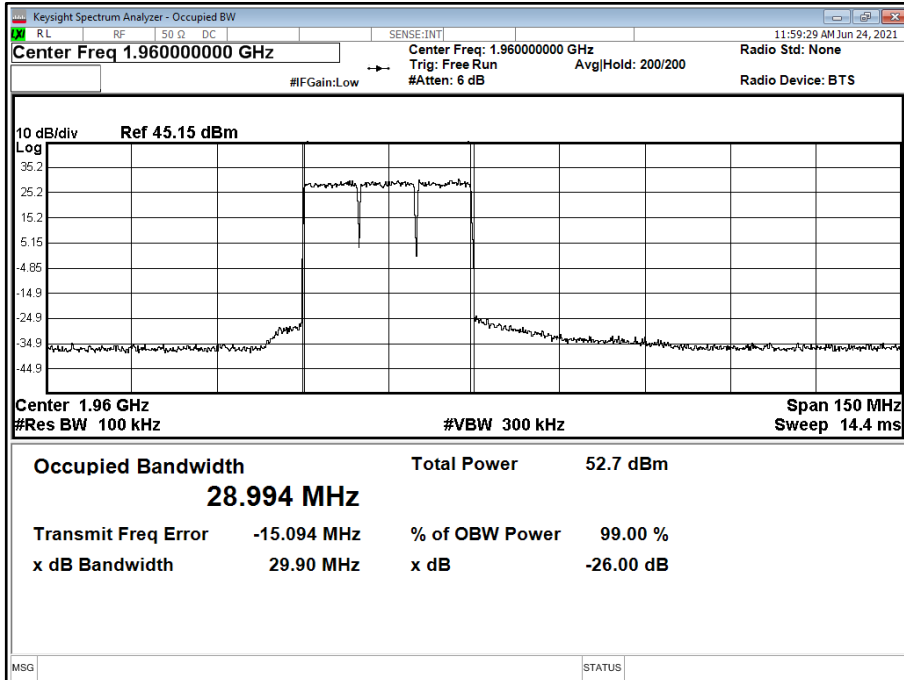

Antenna A - LTE / NR Modulation QPSK - LTE / NR Carrier Bandwidth ESS 40/60 10.0 MHz 15 kHz SCS - Channel Position T

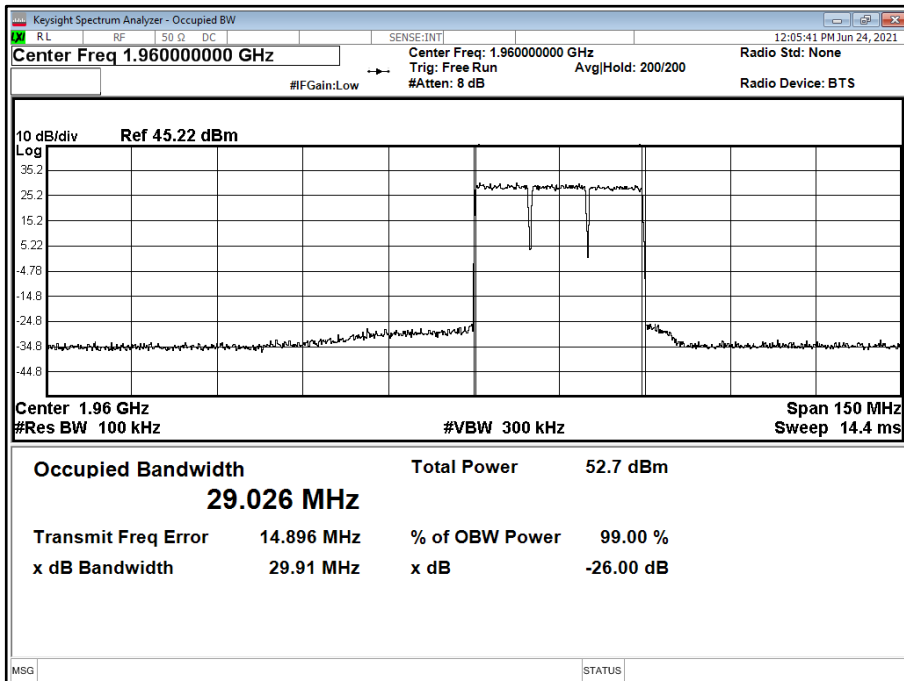



Antenna A - LTE / NR Modulation QPSK - LTE / NR Carrier Bandwidth ESS 90/10 10.0 MHz 15 kHz SCS - Channel Position B

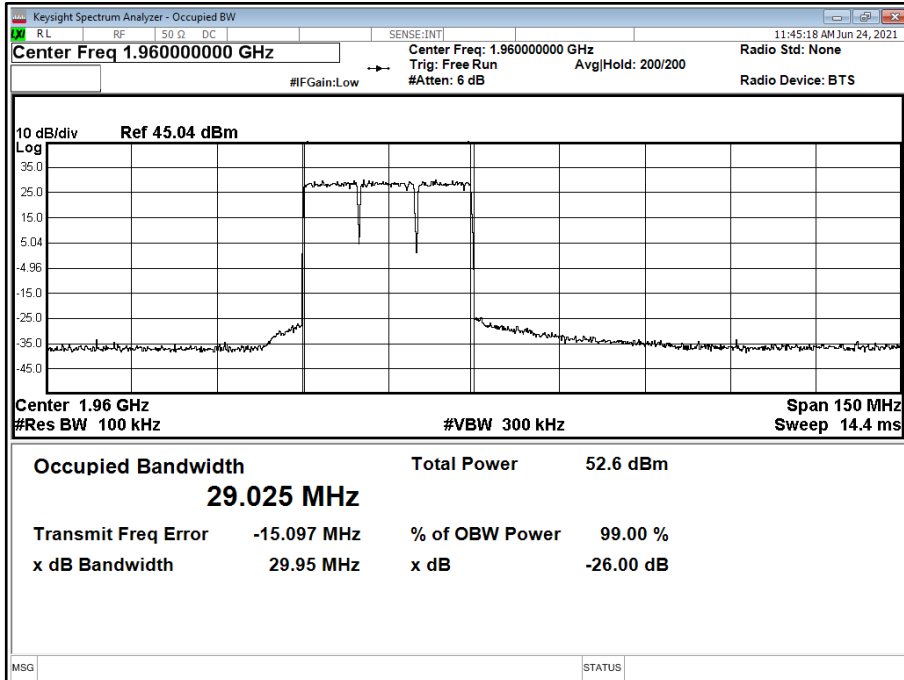

Antenna A - LTE / NR Modulation QPSK - LTE / NR Carrier Bandwidth ESS 90/10 10.0 MHz 15 kHz SCS - Channel Position T

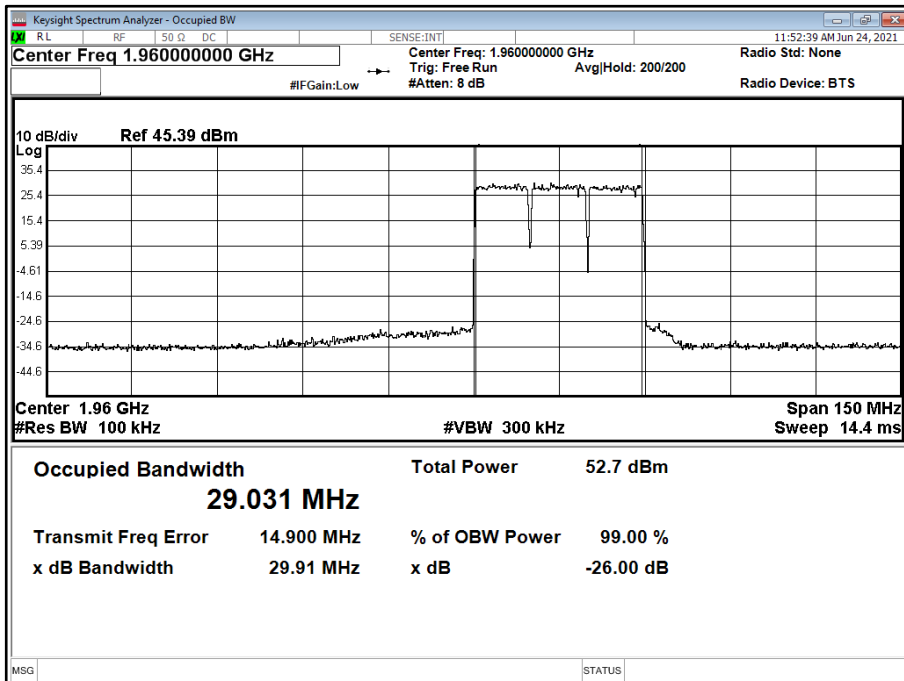



Configuration 3

Maximum Output Power 46.00 dBm

Antenna	NR Modulation	NR Carrier Bandwidth	Result (MHz)					
			Channel Position B		Channel Position M		Channel Position T	
			Occupied Bandwidth	-26 dB Bandwidth	Occupied Bandwidth	-26 dB Bandwidth	Occupied Bandwidth	-26 dB Bandwidth
A	QPSK	10.0 MHz 15 kHz SCS	9286.66	9743.04	9284.95	9765.54	9282.02	9736.85
A	QPSK	20.0 MHz 15 kHz SCS	18922.45	19705.71	18908.78	19684.66	18926.83	19751.59

Antenna A - NR Modulation QPSK - NR Carrier Bandwidth 10.0 MHz 15 kHz SCS - Channel Position B

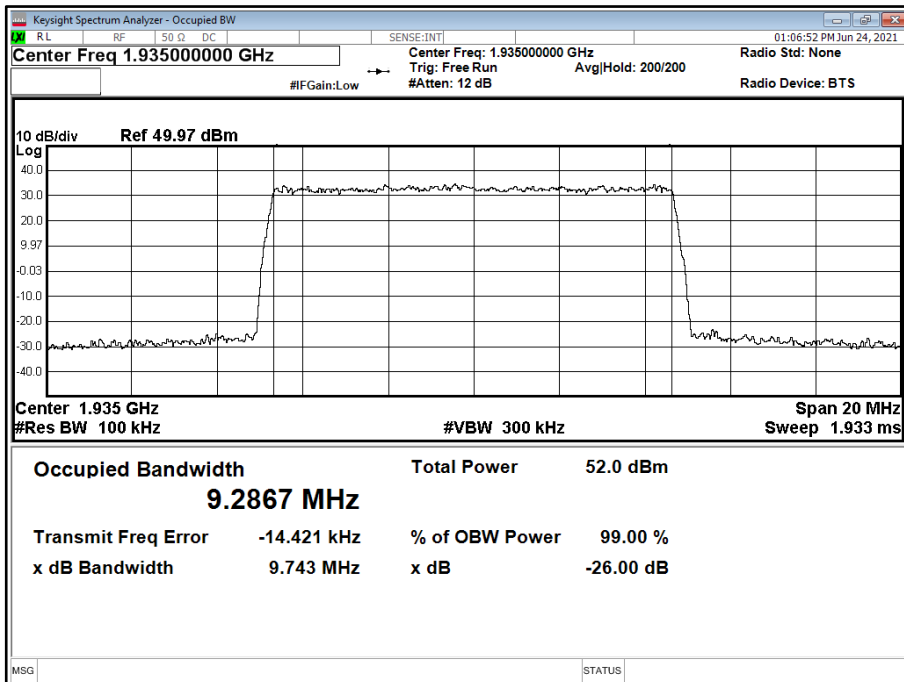



Antenna A - NR Modulation QPSK - NR Carrier Bandwidth 10.0 MHz 15 kHz SCS - Channel Position M

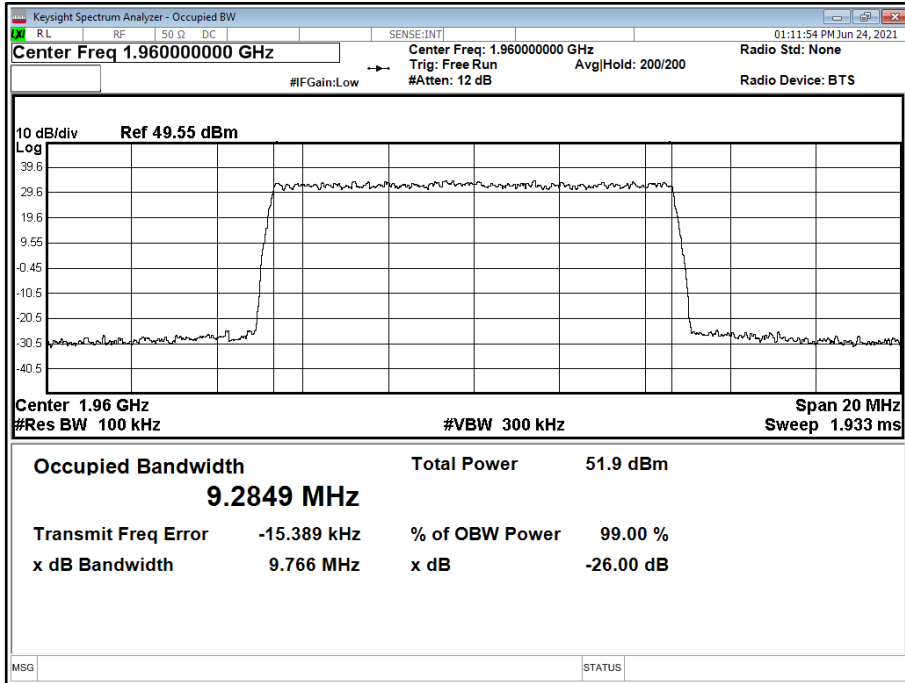

Antenna A - NR Modulation QPSK - NR Carrier Bandwidth 10.0 MHz 15 kHz SCS - Channel Position T

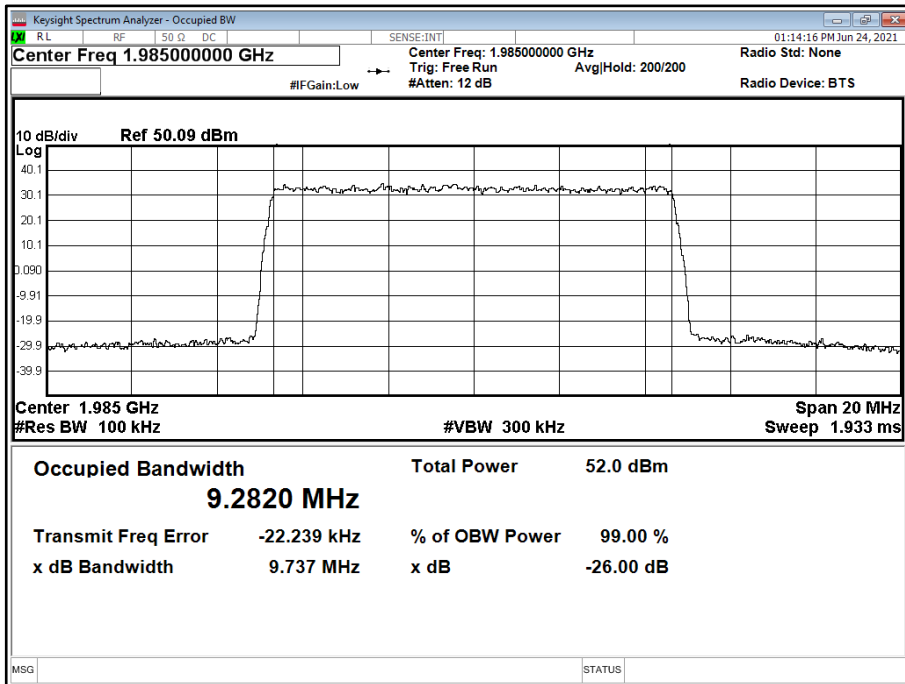



Antenna A - NR Modulation QPSK - NR Carrier Bandwidth 20.0 MHz 15 kHz SCS - Channel Position B

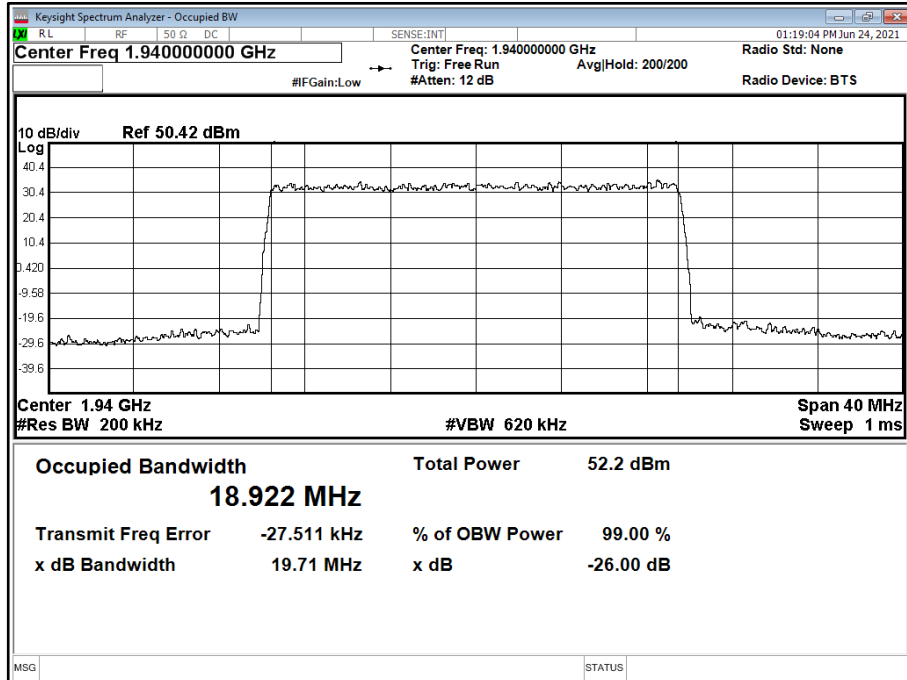

Antenna A - NR Modulation QPSK - NR Carrier Bandwidth 20.0 MHz 15 kHz SCS - Channel Position M

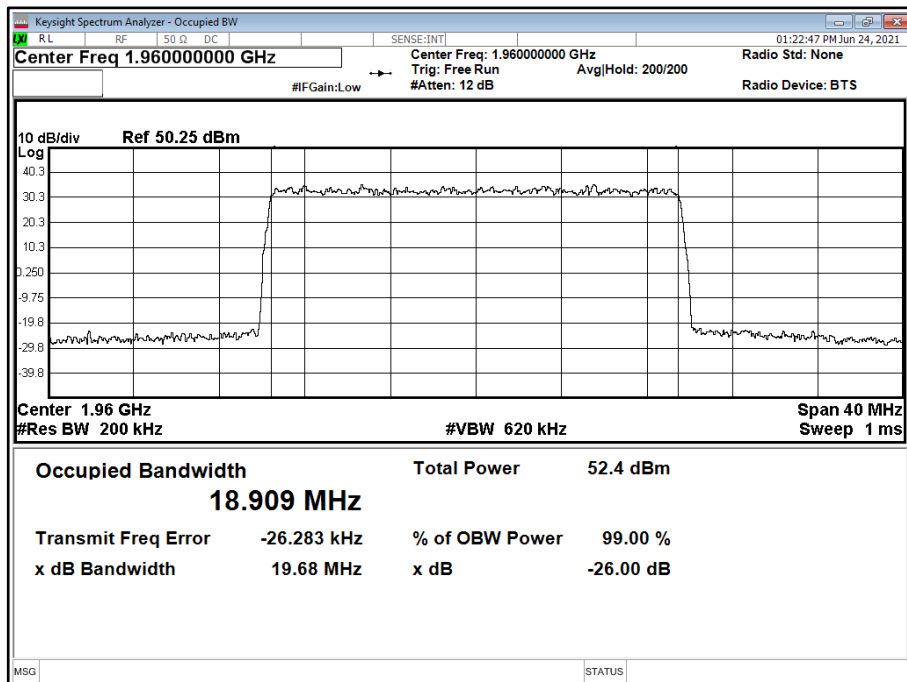



Antenna A - NR Modulation QPSK - NR Carrier Bandwidth 20.0 MHz 15 kHz SCS - Channel Position T

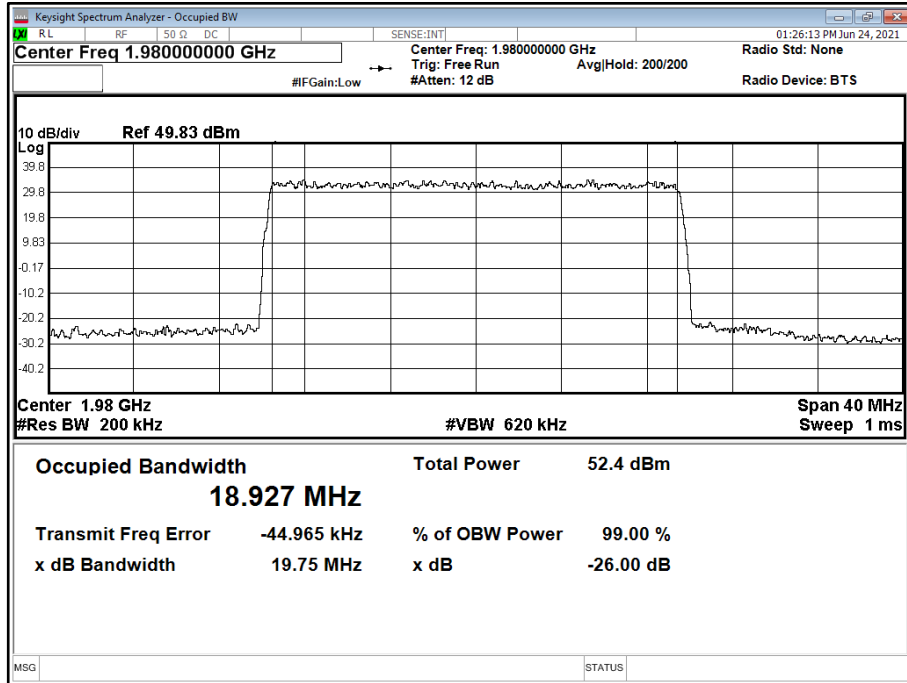

Configuration 4

Maximum Output Power 46.00 dBm

Antenna	NR Modulation	NR Carrier Bandwidth	Result (MHz)					
			Channel Position B		Channel Position M		Channel Position T	
			Occupied Bandwidth	-26 dB Bandwidth	Occupied Bandwidth	-26 dB Bandwidth	Occupied Bandwidth	-26 dB Bandwidth
A	QPSK	10.0 MHz 15 kHz SCS	29229.16	29975.25	-	-	29129.55	29953.57



Antenna A - NR Modulation QPSK - NR Carrier Bandwidth 10.0 MHz 15 kHz SCS - Channel Position B

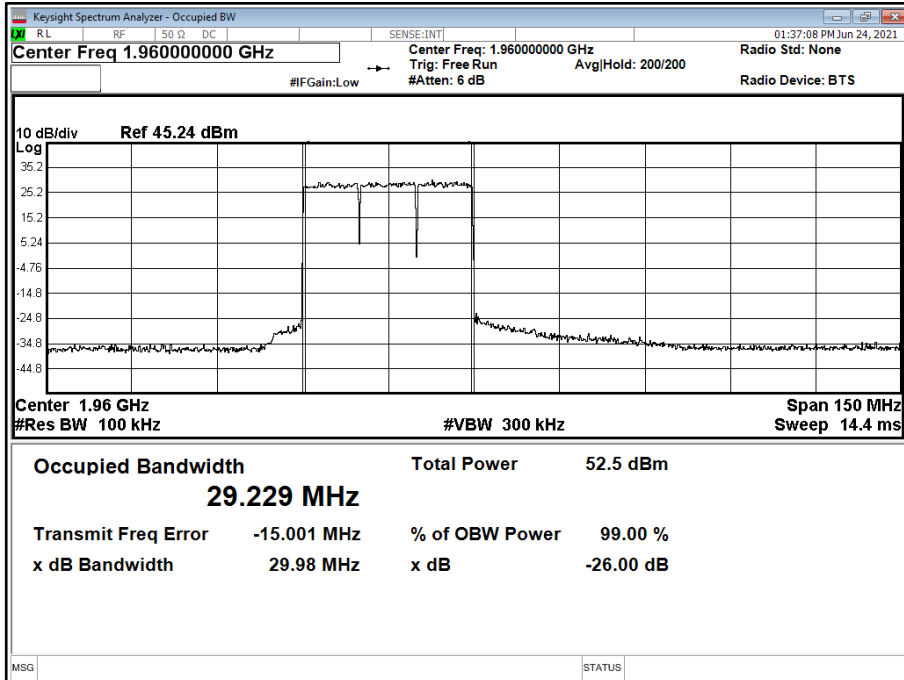

Antenna A - NR Modulation QPSK - NR Carrier Bandwidth 10.0 MHz 15 kHz SCS - Channel Position T

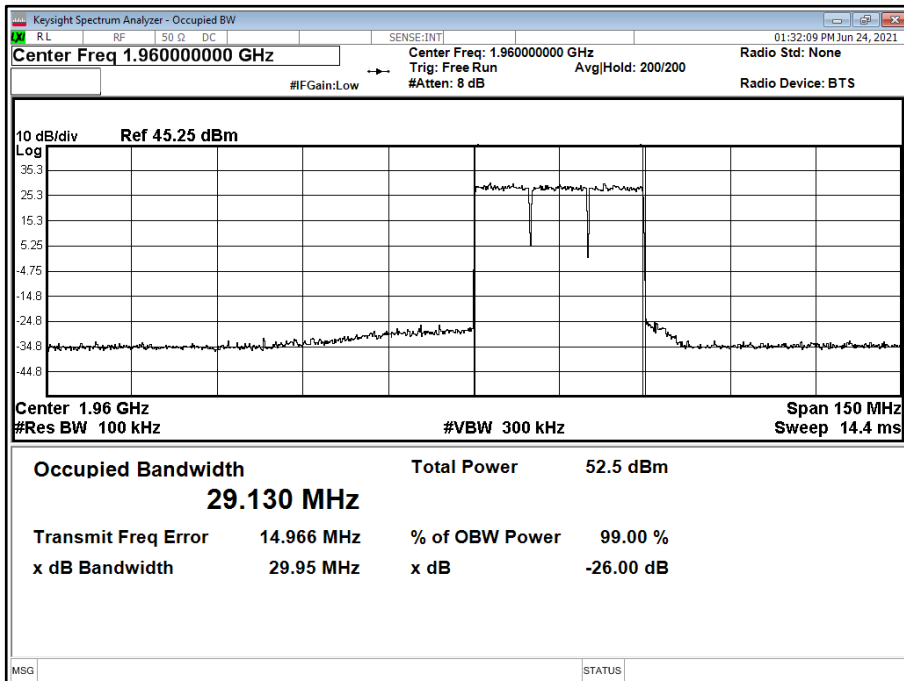



2.3 BAND EDGE

2.3.1 Specification Reference

FCC CFR 47 Part 24, Clause 24.238 (b)
 FCC CFR 47 Part 2, Clause 2.1051
 ISED RSS-133, Clause 6.5

2.3.2 Date of Test and Modification State

23 and 24 June 2021 - Modification State 0

2.3.3 Test Equipment Used

The major items of test equipment used for the above tests are identified in Section 3.1.

2.3.4 Environmental Conditions

Ambient Temperature 22.2 - 24.2°C
 Relative Humidity 43.9 - 45.6%

2.3.5 Test Method

All measurements were made in accordance with FCC KDB 971168 D01, Clause 6.0.

Band Edge measurements were used an Integration Bandwidth of at least 1% of the measured 26dB Bandwidth.

Each antenna port has been declared as being equivalent, therefore measurements were made on one antenna port only. To account for this, the limit was tightened by $10 * \text{Log}(N)$, where N is equal to the number of MIMO antenna ports.

For 4 ports, the limit was calculated as being $-13 \text{ dBm} - 10 * \text{Log}(4) = -19 \text{ dBm}$.

2.3.6 Test Results

Configuration 1

Maximum Output Power 46.00 dBm

Antenna	LTE / NR Modulation	LTE / NR Carrier Bandwidth	Band Edge (MHz)	
			Channel Position B	Channel Position T
A	QPSK	ESS 10/90 10.0 MHz 15 kHz SCS	1,935.0	1,985.0
A	QPSK	ESS 10/90 20.0 MHz 15 kHz SCS	1,940.0	1,980.0
A	QPSK	ESS 40/60 10.0 MHz 15 kHz SCS	1,935.0	1,985.0
A	QPSK	ESS 40/60 20.0 MHz 15 kHz SCS	1,940.0	1,980.0
A	QPSK	ESS 90/10 10.0 MHz 15 kHz SCS	1,935.0	1,985.0
A	QPSK	ESS 90/10 20.0 MHz 15 kHz SCS	1,940.0	1,980.0



Antenna A - LTE / NR Modulation QPSK - LTE / NR Carrier Bandwidth ESS 10/90 10.0 MHz 15 kHz SCS - Channel Position B

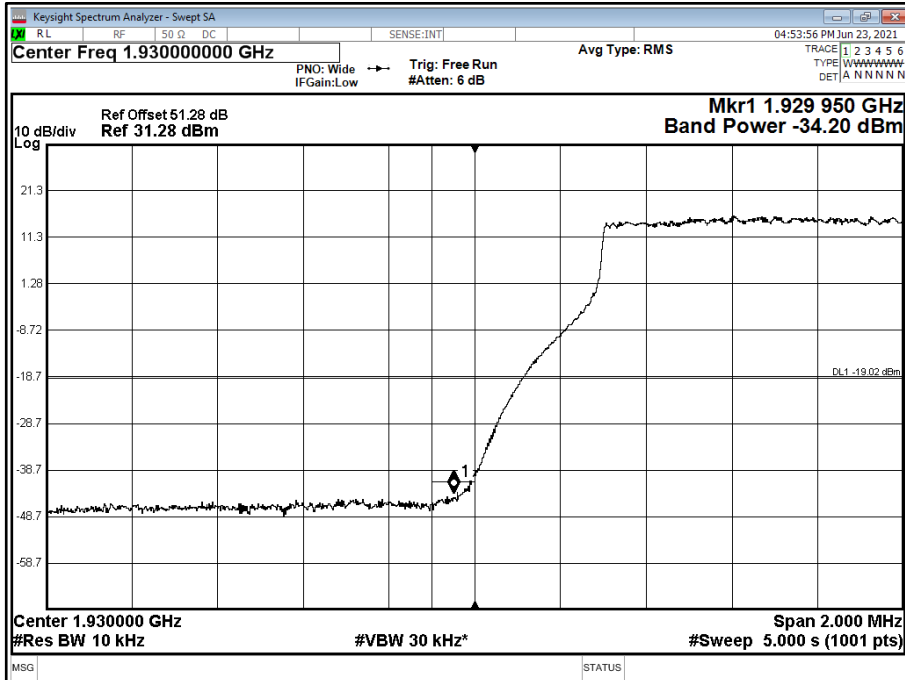

Antenna A - LTE / NR Modulation QPSK - LTE / NR Carrier Bandwidth ESS 10/90 10.0 MHz 15 kHz SCS - Channel Position T

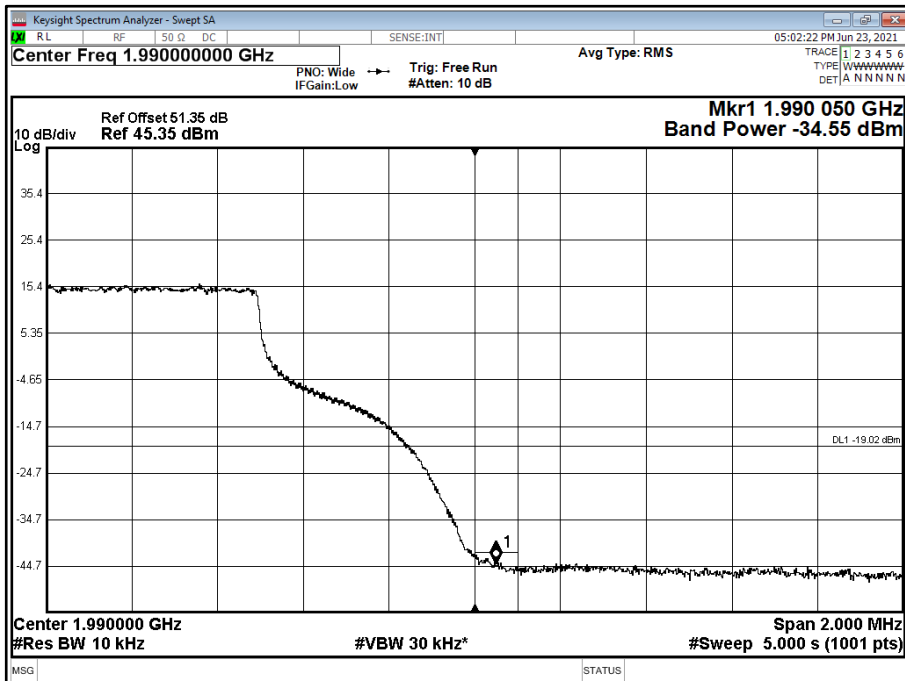



Antenna A - LTE / NR Modulation QPSK - LTE / NR Carrier Bandwidth ESS 10/90 20.0 MHz 15 kHz SCS - Channel Position B

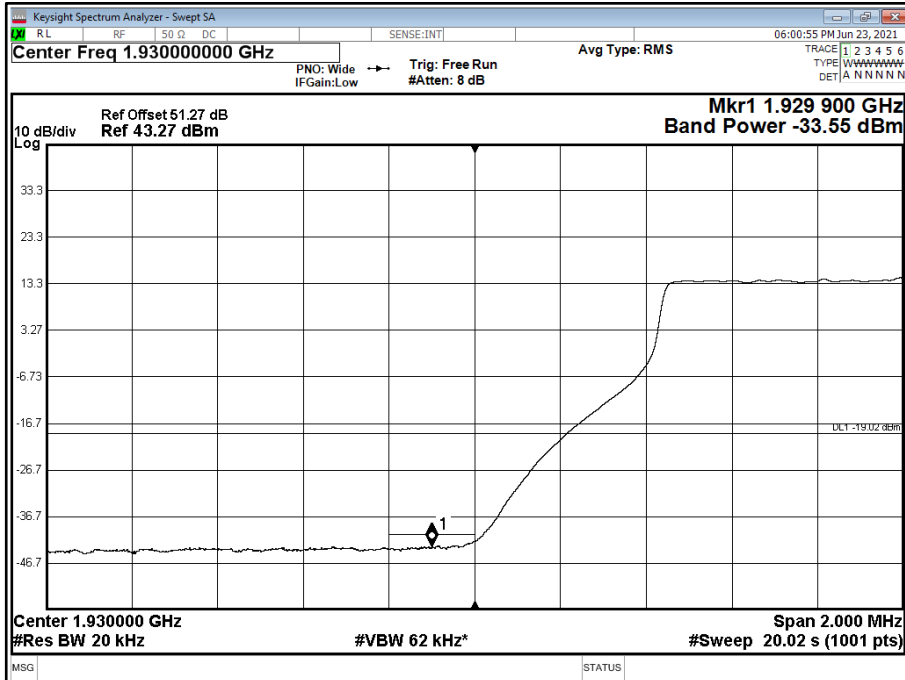

Antenna A - LTE / NR Modulation QPSK - LTE / NR Carrier Bandwidth ESS 10/90 20.0 MHz 15 kHz SCS - Channel Position T

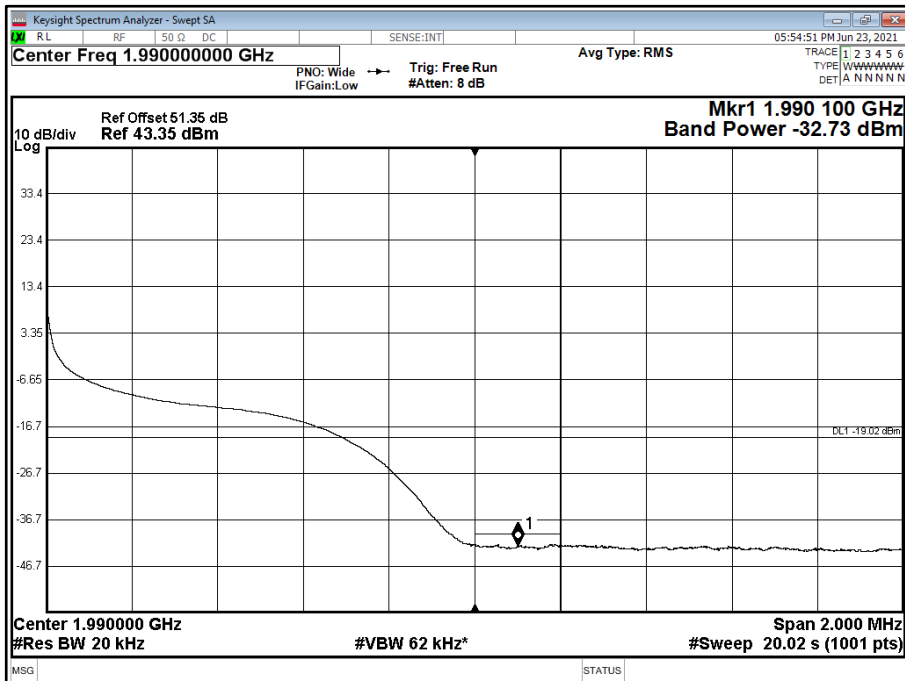



Antenna A - LTE / NR Modulation QPSK - LTE / NR Carrier Bandwidth ESS 40/60 10.0 MHz 15 kHz SCS - Channel Position B

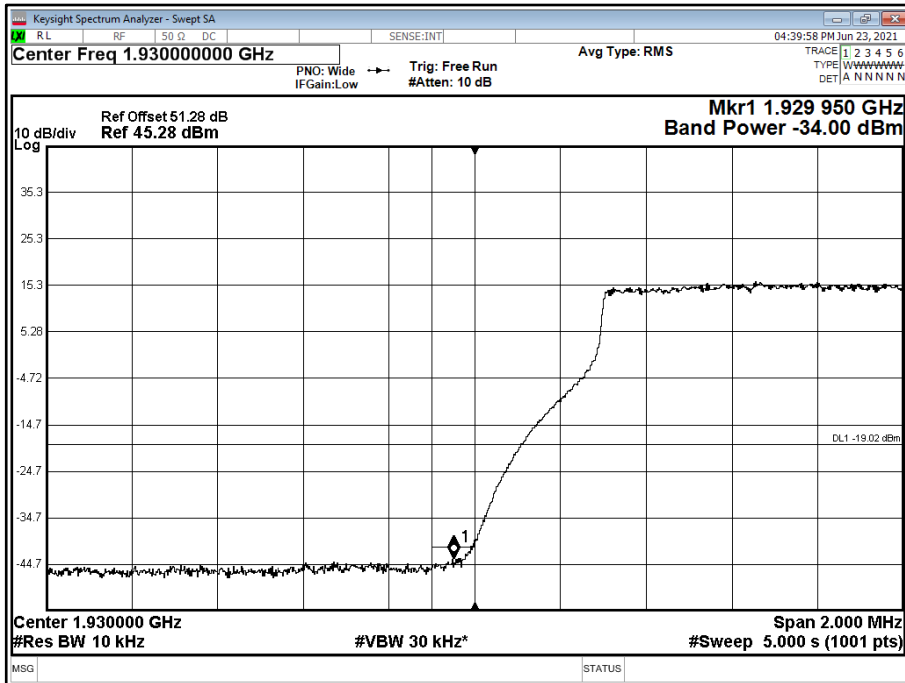

Antenna A - LTE / NR Modulation QPSK - LTE / NR Carrier Bandwidth ESS 40/60 10.0 MHz 15 kHz SCS - Channel Position T

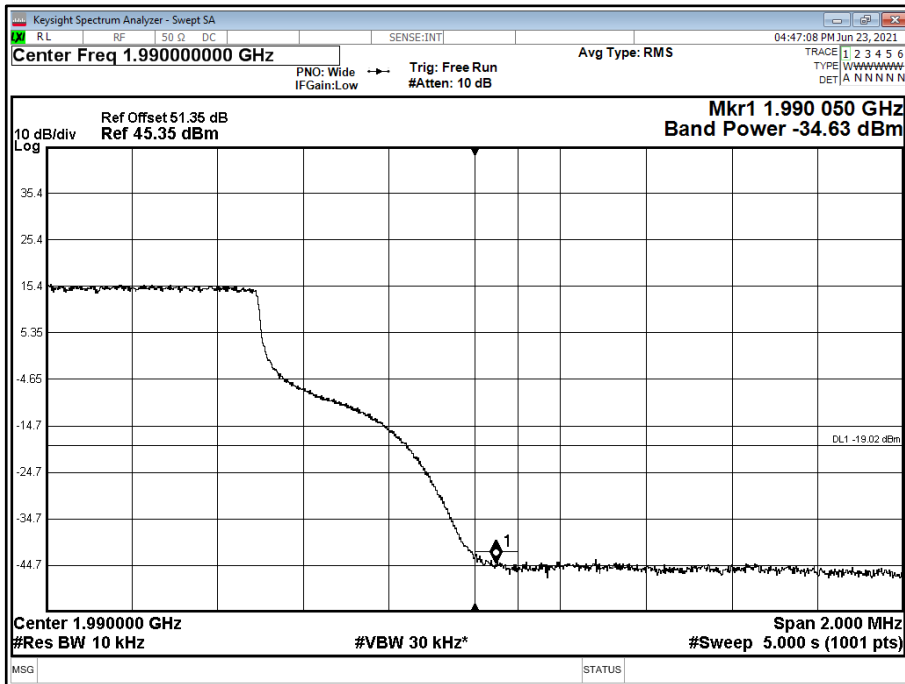



Antenna A - LTE / NR Modulation QPSK - LTE / NR Carrier Bandwidth ESS 40/60 20.0 MHz 15 kHz SCS - Channel Position B

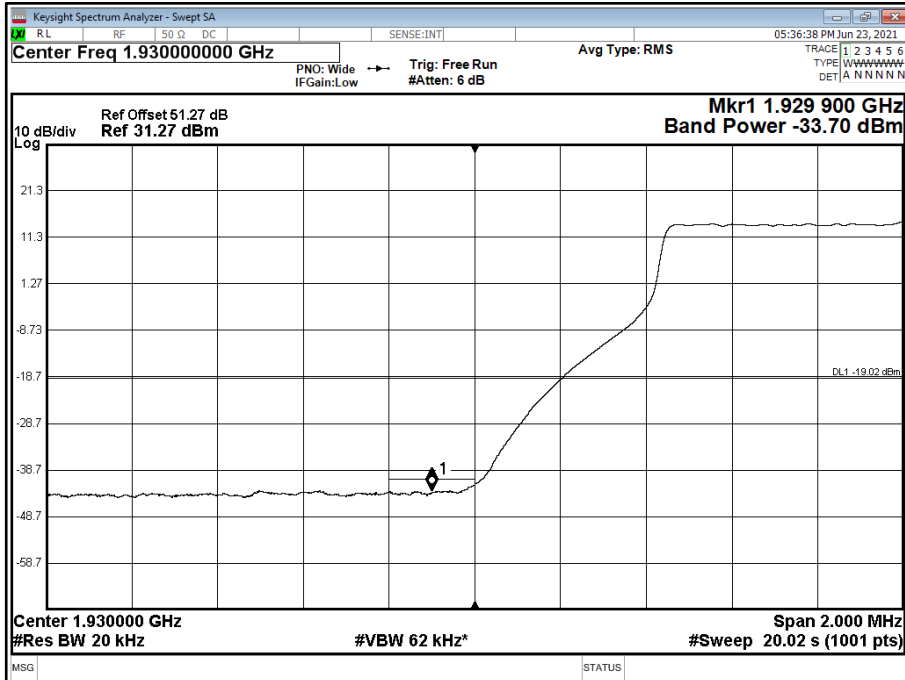

Antenna A - LTE / NR Modulation QPSK - LTE / NR Carrier Bandwidth ESS 40/60 20.0 MHz 15 kHz SCS - Channel Position T

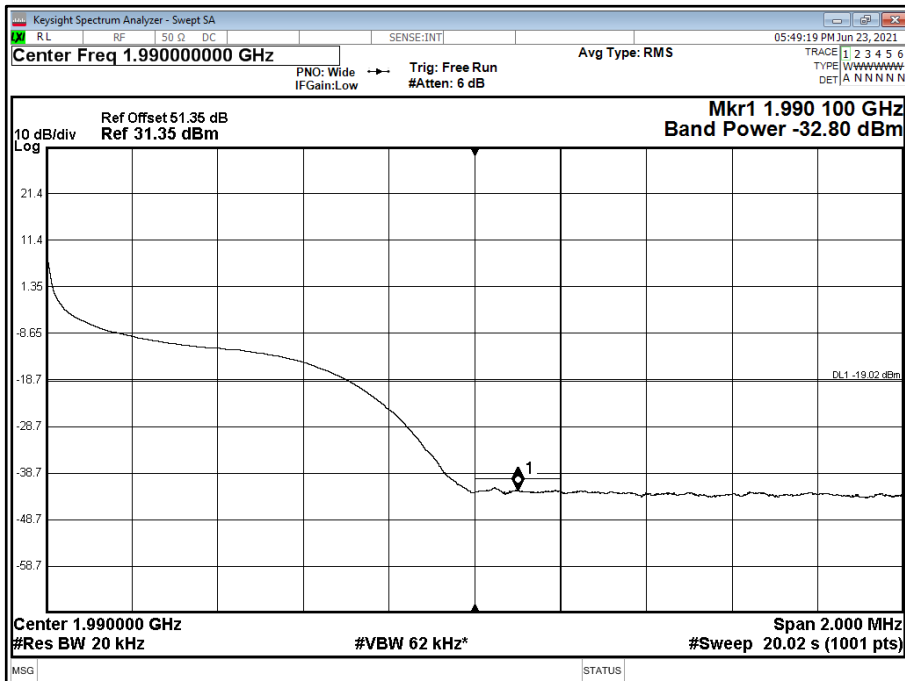



Antenna A - LTE / NR Modulation QPSK - LTE / NR Carrier Bandwidth ESS 90/10 10.0 MHz 15 kHz SCS - Channel Position B

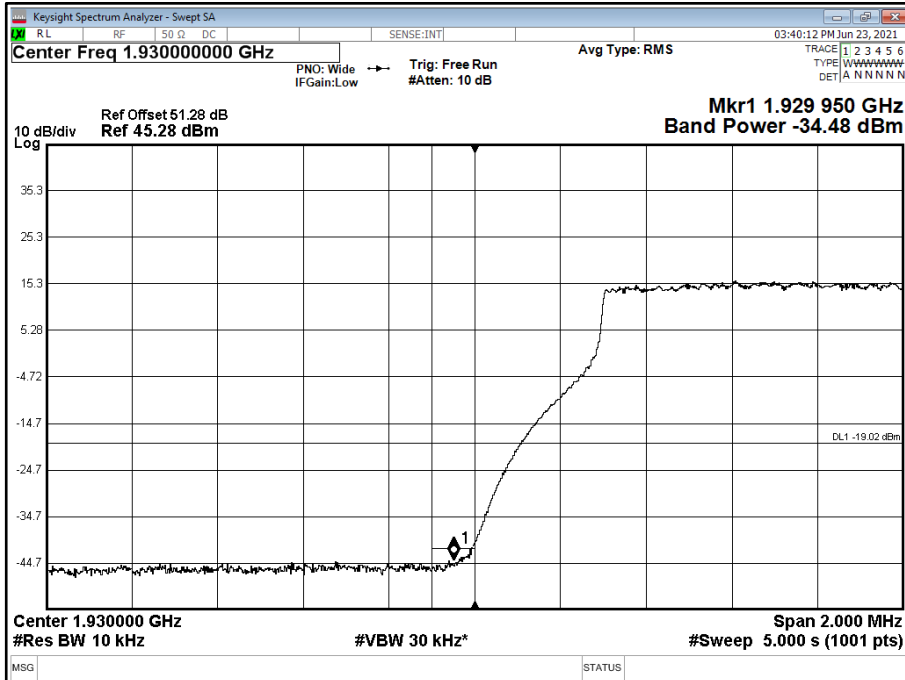

Antenna A - LTE / NR Modulation QPSK - LTE / NR Carrier Bandwidth ESS 90/10 10.0 MHz 15 kHz SCS - Channel Position T

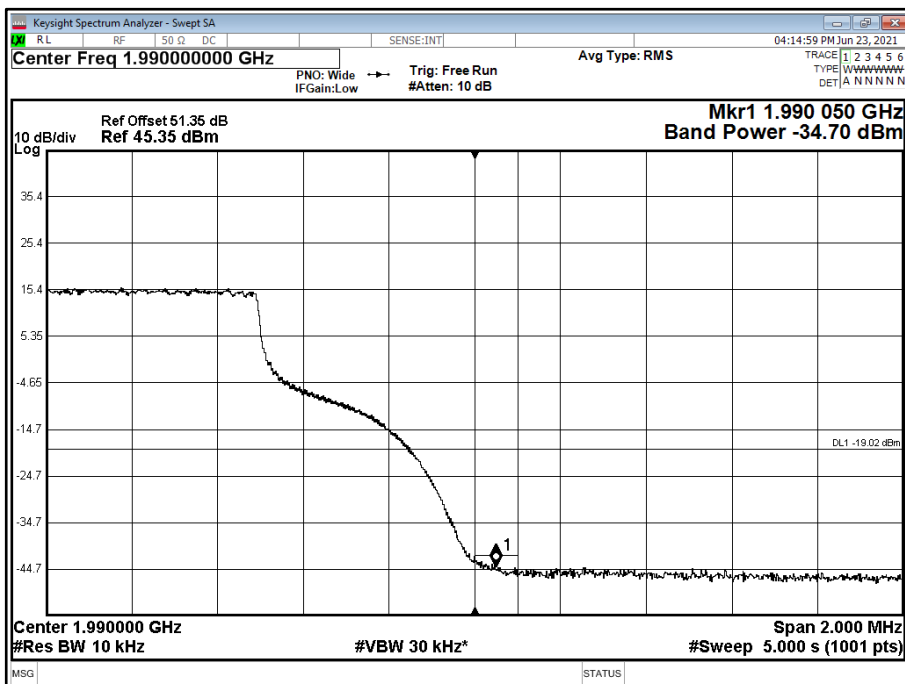



Antenna A - LTE / NR Modulation QPSK - LTE / NR Carrier Bandwidth ESS 90/10 20.0 MHz 15 kHz SCS - Channel Position B

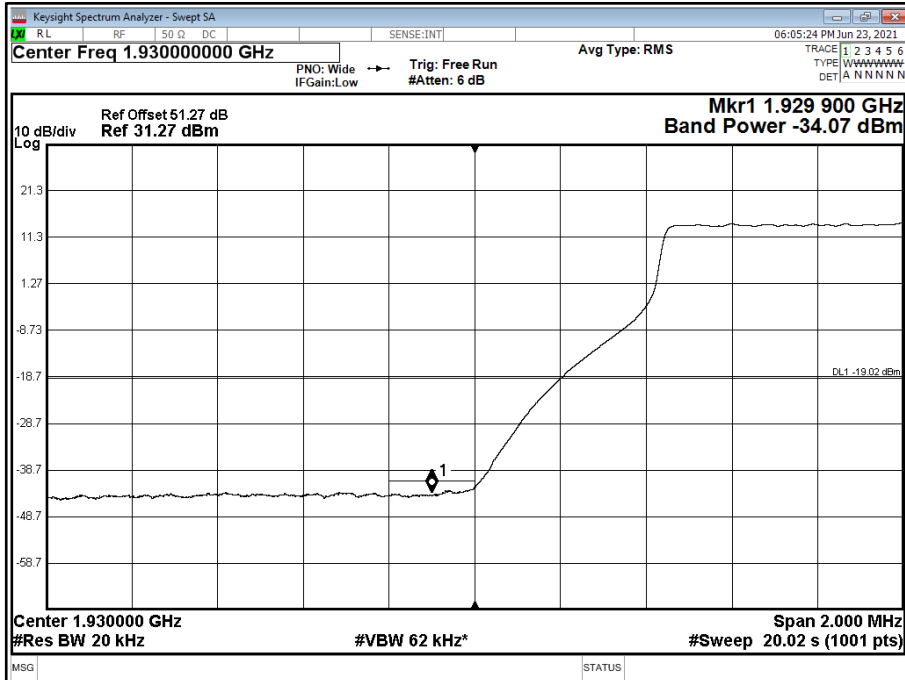

Antenna A - LTE / NR Modulation QPSK - LTE / NR Carrier Bandwidth ESS 90/10 20.0 MHz 15 kHz SCS - Channel Position T

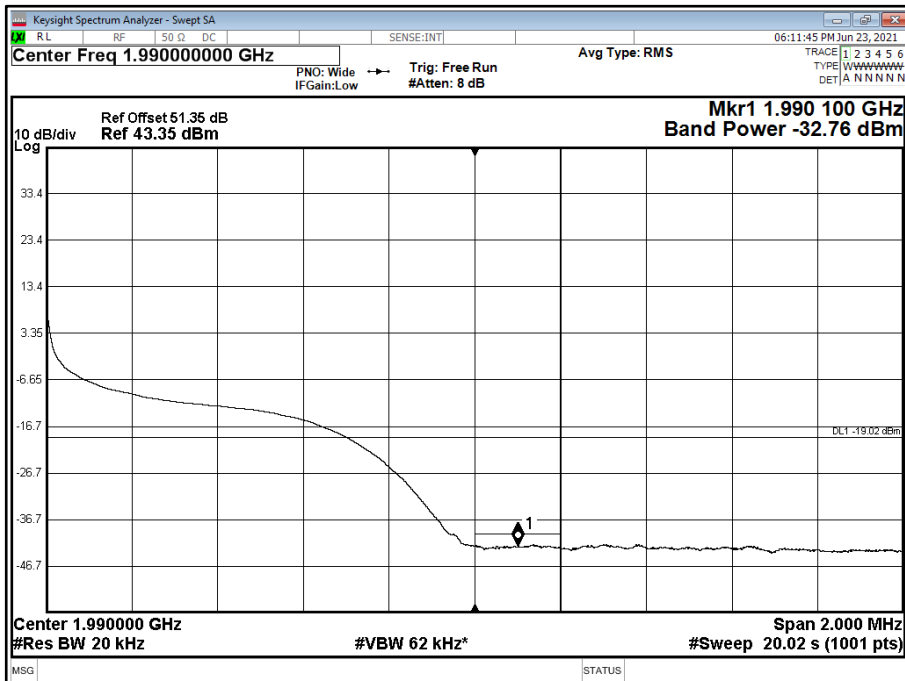



Configuration 2

Maximum Output Power 46.00 dBm

Antenna	LTE / NR Modulation	LTE / NR Carrier Bandwidth	Band Edge (MHz)	
			Channel Position B	Channel Position T
A	QPSK	ESS 10/90 10.0 MHz 15 kHz SCS	1935 + 1945 + 1985	1935 + 1945 + 1985
A	QPSK	ESS 40/60 10.0 MHz 15 kHz SCS	1935 + 1945 + 1985	1935 + 1945 + 1985
A	QPSK	ESS 90/10 10.0 MHz 15 kHz SCS	1935 + 1945 + 1985	1935 + 1945 + 1985

Antenna A - LTE / NR Modulation QPSK - LTE / NR Carrier Bandwidth ESS 10/90 10.0 MHz 15 kHz SCS - Channel Position B

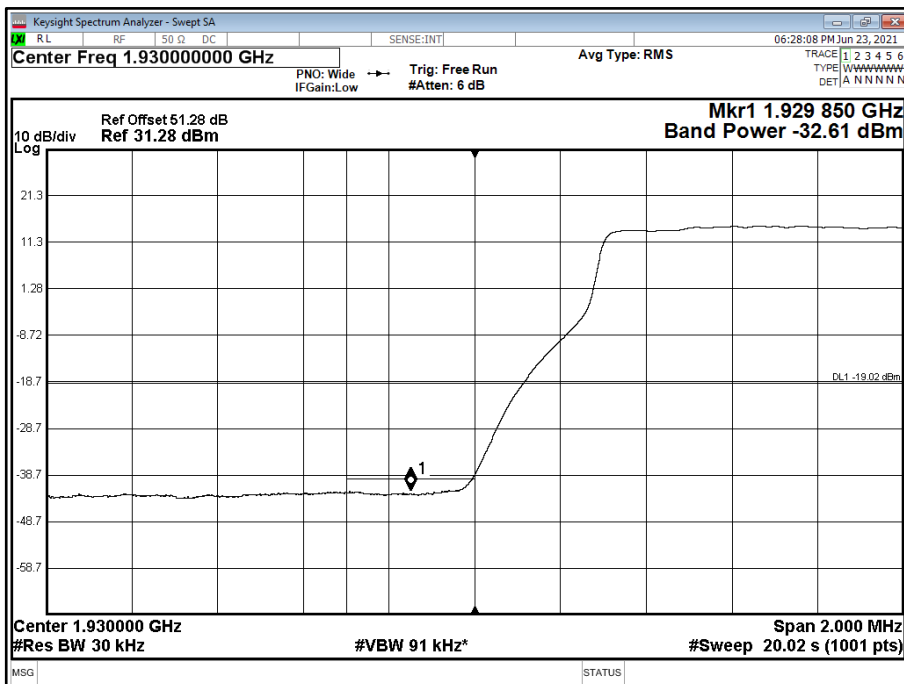



Antenna A - LTE / NR Modulation QPSK - LTE / NR Carrier Bandwidth ESS 10/90 10.0 MHz 15 kHz SCS - Channel Position T

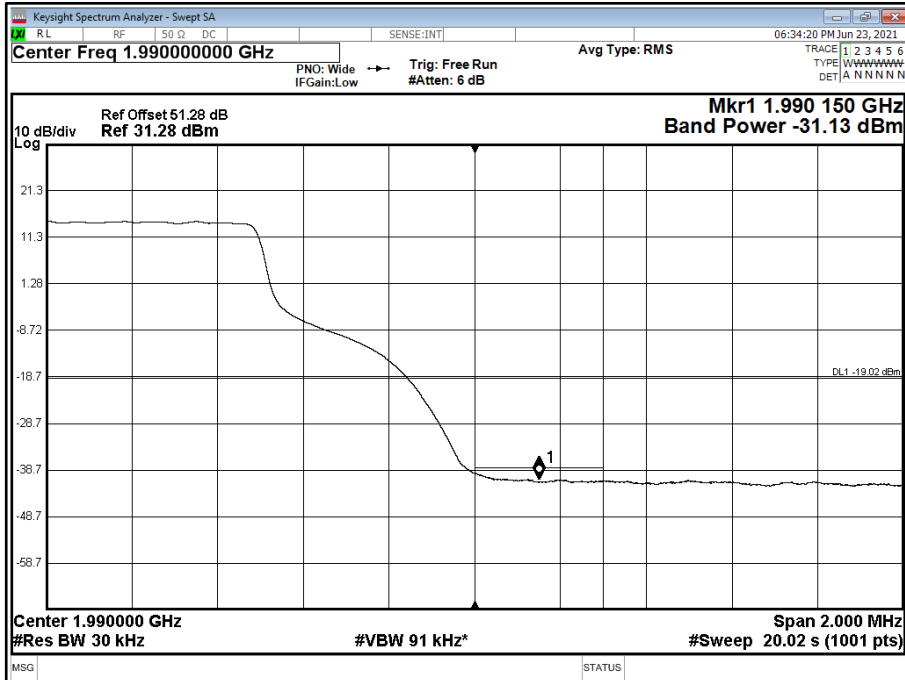

Antenna A - LTE / NR Modulation QPSK - LTE / NR Carrier Bandwidth ESS 40/60 10.0 MHz 15 kHz SCS - Channel Position B

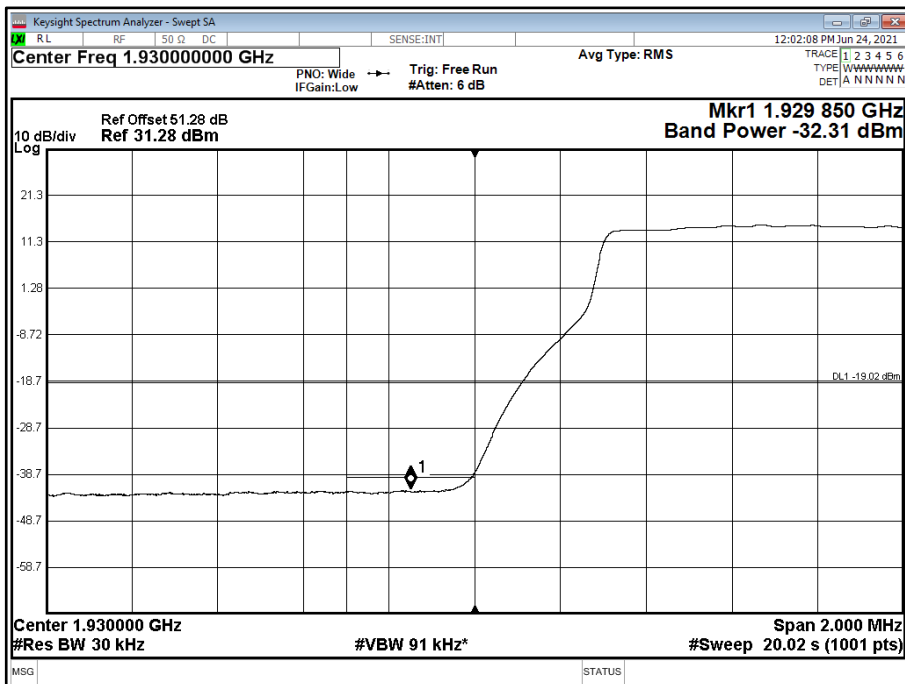



Antenna A - LTE / NR Modulation QPSK - LTE / NR Carrier Bandwidth ESS 40/60 10.0 MHz 15 kHz SCS - Channel Position T

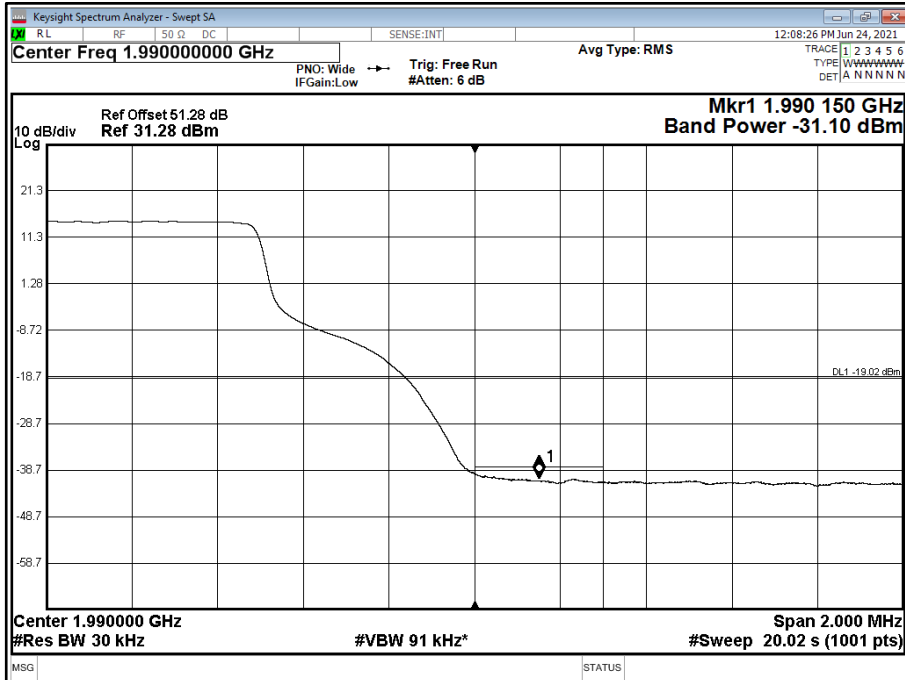

Antenna A - LTE / NR Modulation QPSK - LTE / NR Carrier Bandwidth ESS 90/10 10.0 MHz 15 kHz SCS - Channel Position B

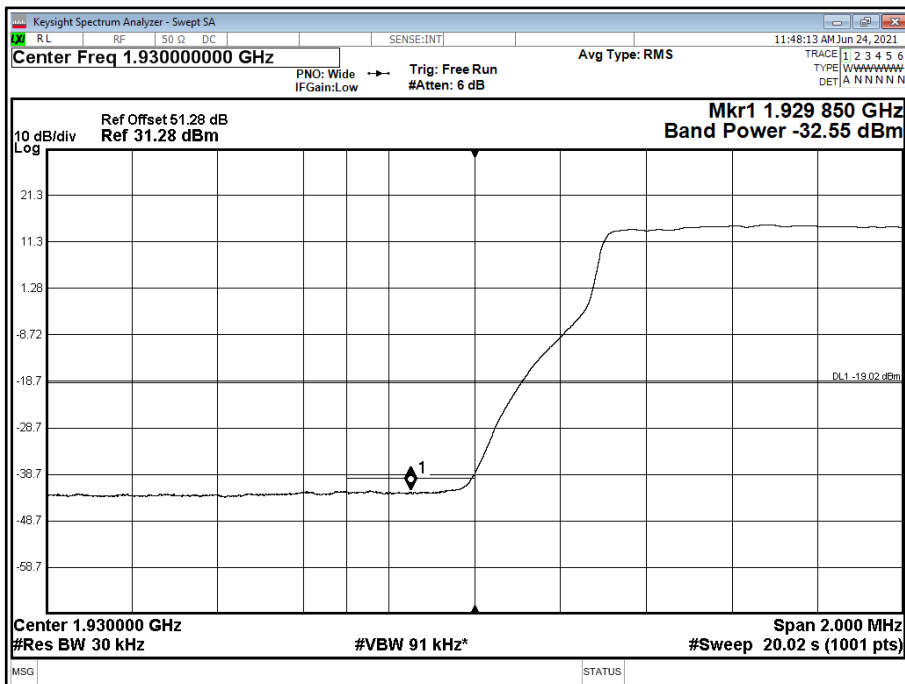



Antenna A - LTE / NR Modulation QPSK - LTE / NR Carrier Bandwidth ESS 90/10 10.0 MHz 15 kHz SCS - Channel Position T

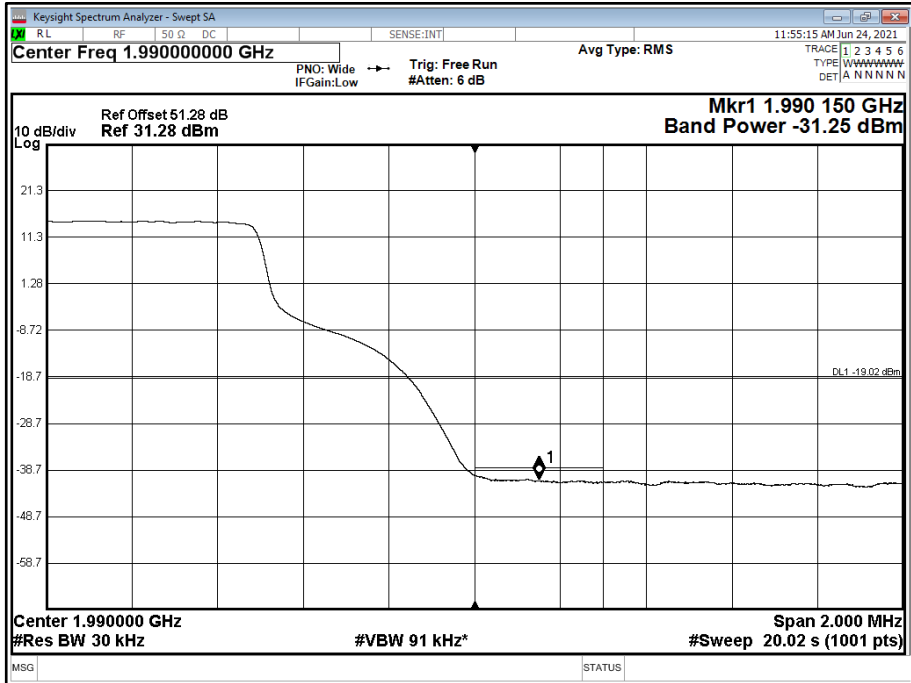

Configuration 3

Maximum Output Power 46.00 dBm

Antenna	NR Modulation	NR Carrier Bandwidth	Band Edge (MHz)	
			Channel Position B	Channel Position T
A	QPSK	10.0 MHz 15 kHz SCS	1,935.0	1,985.0
A	QPSK	20.0 MHz 15 kHz SCS	1,940.0	1,980.0



Antenna A - NR Modulation QPSK - NR Carrier Bandwidth 10.0 MHz 15 kHz SCS - Channel Position B

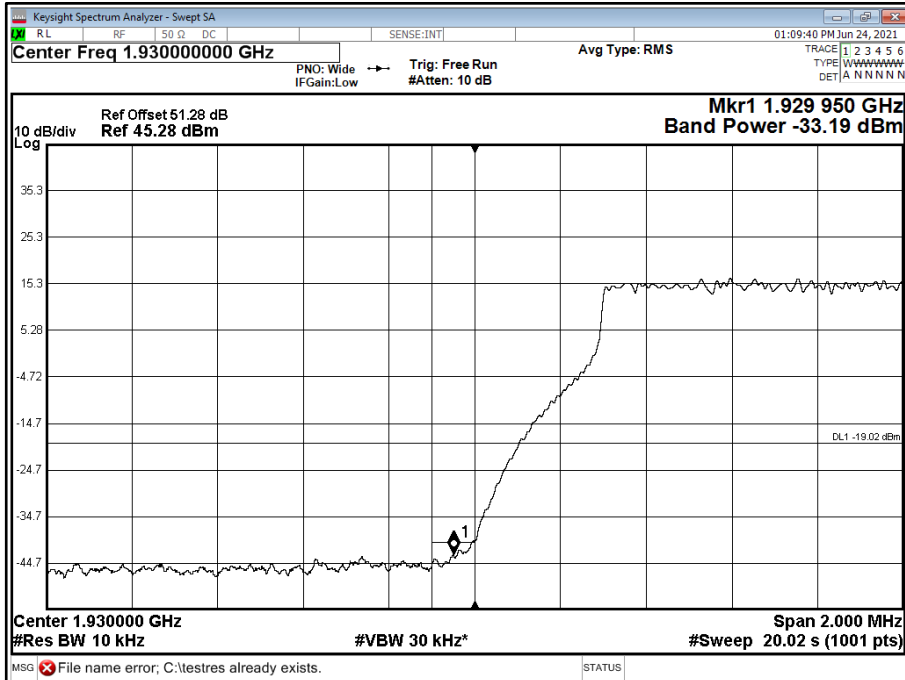

Antenna A - NR Modulation QPSK - NR Carrier Bandwidth 10.0 MHz 15 kHz SCS - Channel Position T

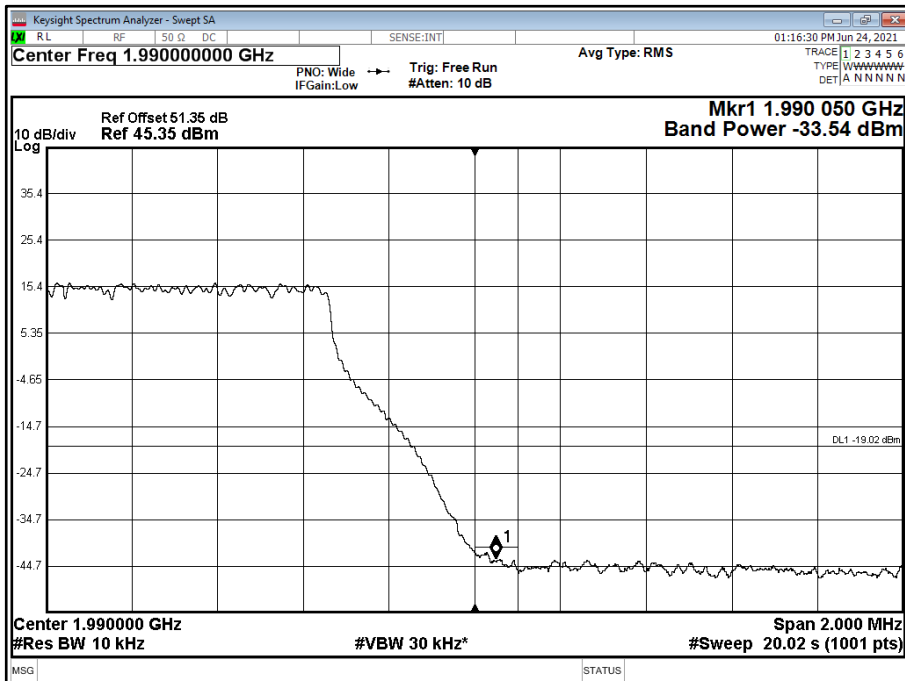



Antenna A - NR Modulation QPSK - NR Carrier Bandwidth 20.0 MHz 15 kHz SCS - Channel Position B

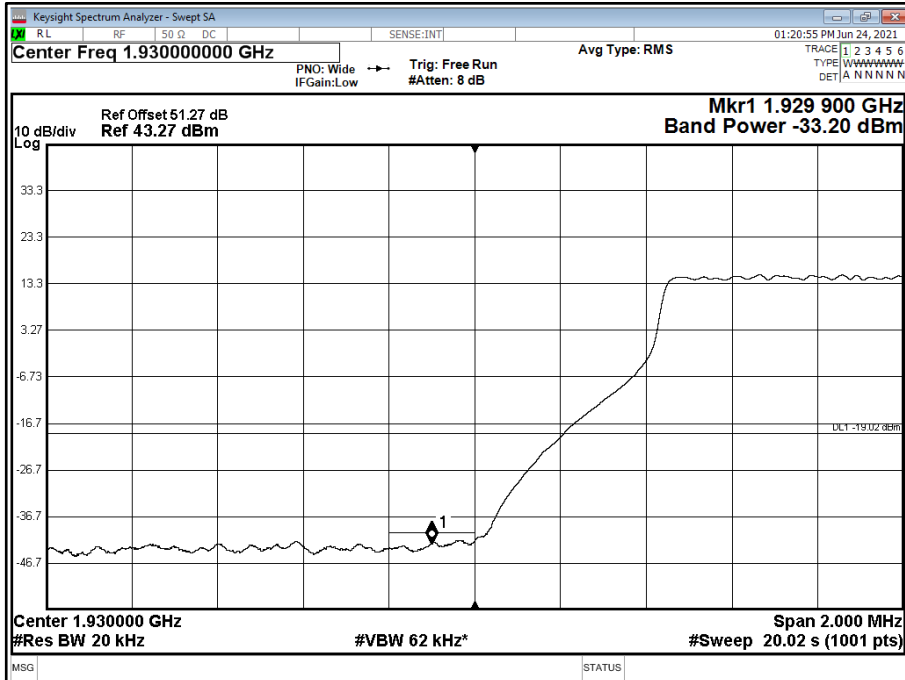

Antenna A - NR Modulation QPSK - NR Carrier Bandwidth 20.0 MHz 15 kHz SCS - Channel Position T

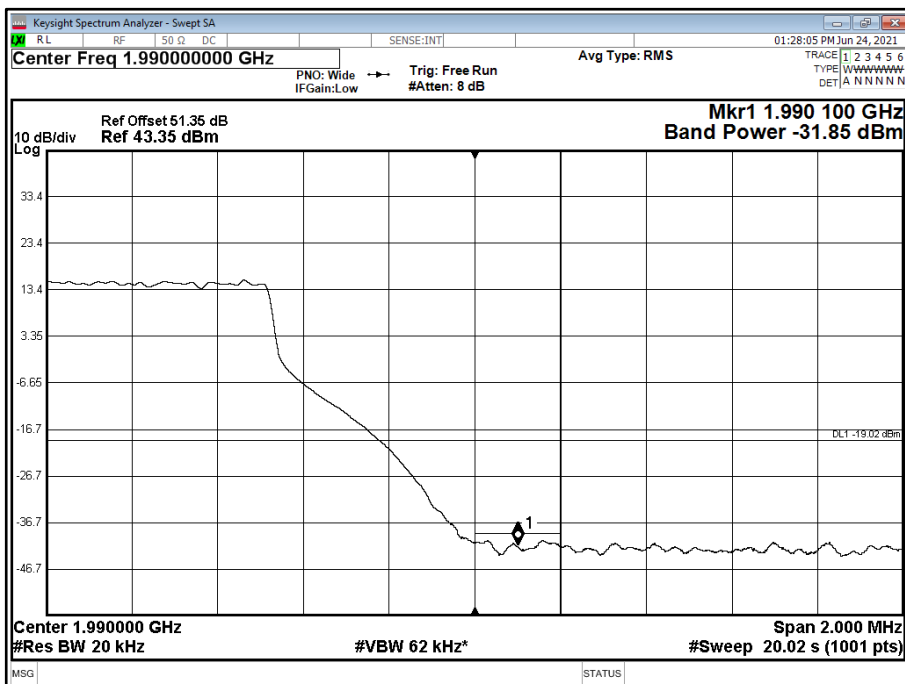



Configuration 4

Maximum Output Power 46.00 dBm

Antenna	NR Modulation	NR Carrier Bandwidth	Band Edge (MHz)	
			Channel Position B	Channel Position T
A	QPSK	10.0 MHz 15 kHz SCS	1935 + 1945 + 1985	1935 + 1945 + 1985

Antenna A - NR Modulation QPSK - NR Carrier Bandwidth 10.0 MHz 15 kHz SCS - Channel Position B

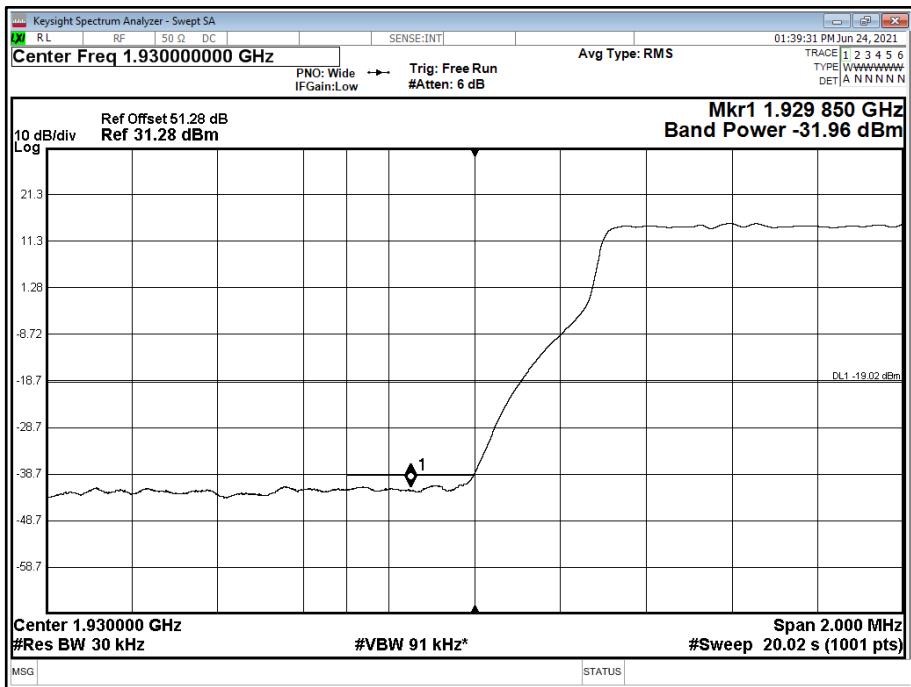



Antenna A - NR Modulation QPSK - NR Carrier Bandwidth 10.0 MHz 15 kHz SCS - Channel Position T

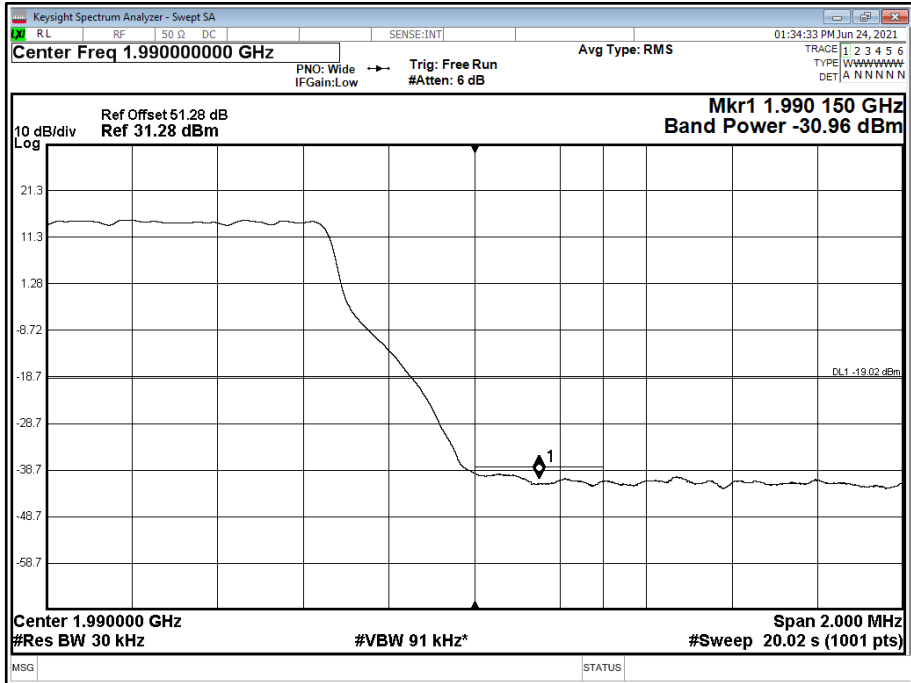

Limit	-19 dBm
-------	---------



2.4 TRANSMITTER SPURIOUS EMISSIONS

2.4.1 Specification Reference

FCC CFR 47 Part 24, Clause 24.238 (a)
FCC CFR 47 Part 2, Clause 2.1051
ISED RSS-GEN, Clause 6.13
Industry Canada RSS-133, Clause 6.5

2.4.2 Date of Test and Modification State

24 June 2021 - Modification State 0

2.4.3 Test Equipment Used

The major items of test equipment used for the above tests are identified in Section 3.1.

2.4.4 Environmental Conditions

Ambient Temperature	22.2°C
Relative Humidity	43.9%

2.4.5 Test Method

All measurements were made in accordance with FCC KDB 971168 D01, Clause 6.1.

Each antenna port has been declared as being equivalent, therefore measurements were made on one antenna port only. To account for this, the limit was tightened by $10 * \text{Log}(N)$, where N is equal to the number of MIMO antenna ports.

For 4 ports, the limit was calculated as being $-13 \text{ dBm} - 10 * \text{Log}(4) = -19 \text{ dBm}$.

2.4.6 Test Results

Configuration 1

Maximum Output Power 46.00 dBm



Antenna A - LTE / NR Modulation QPSK - LTE / NR Carrier Bandwidth ESS 10/90 10.0 MHz 15 kHz SCS - Channel Position B - Band 1 - Range 0.009 to 3500 MHz

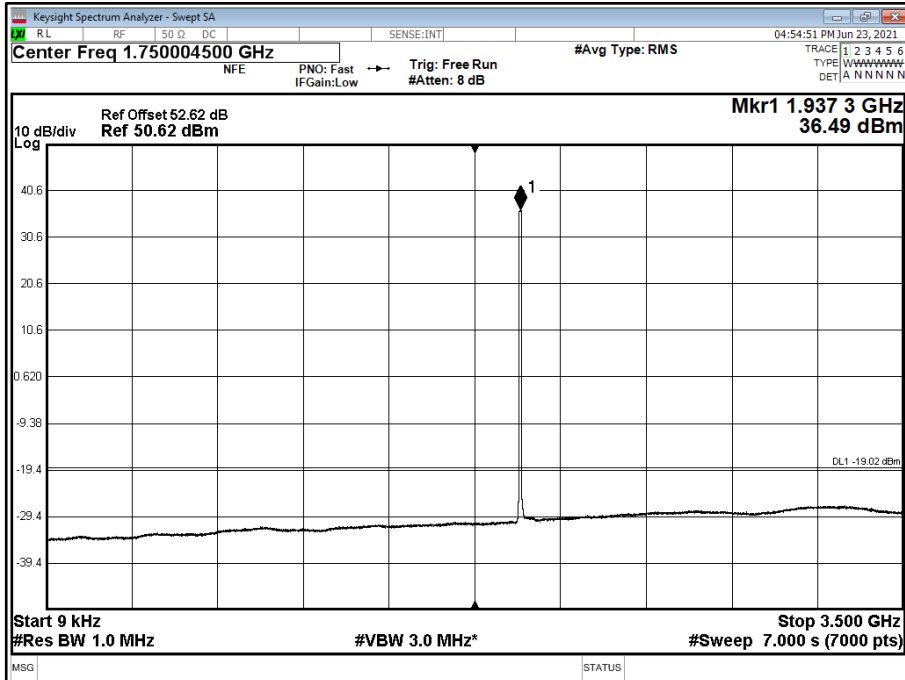

Antenna A - LTE / NR Modulation QPSK - LTE / NR Carrier Bandwidth ESS 10/90 10.0 MHz 15 kHz SCS - Channel Position M - Band 1 - Range 0.009 to 3500 MHz

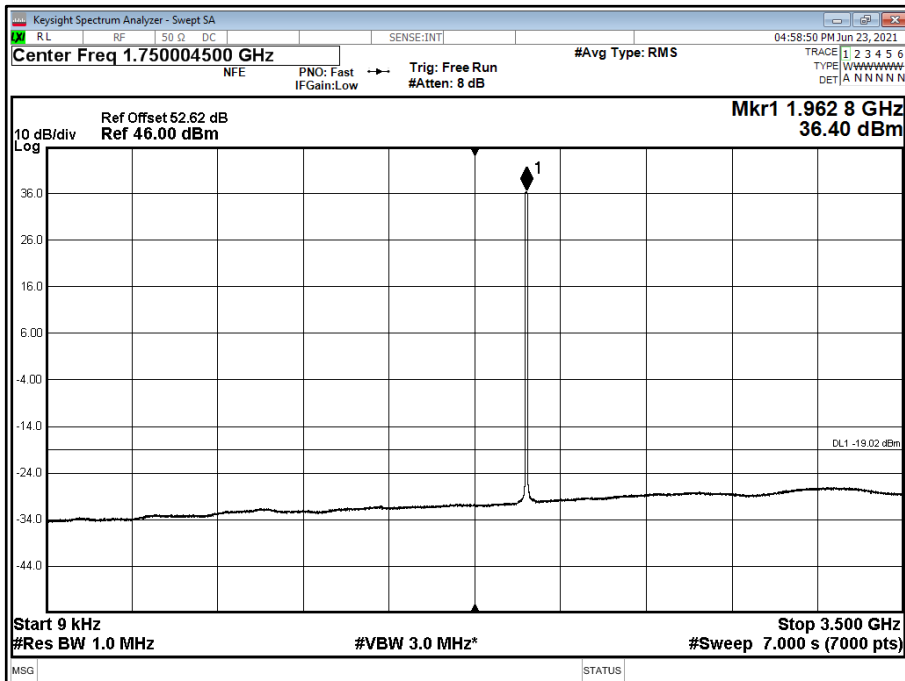



Antenna A - LTE / NR Modulation QPSK - LTE / NR Carrier Bandwidth ESS 10/90 10.0 MHz 15 kHz SCS - Channel Position T - Band 1 - Range 0.009 to 3500 MHz

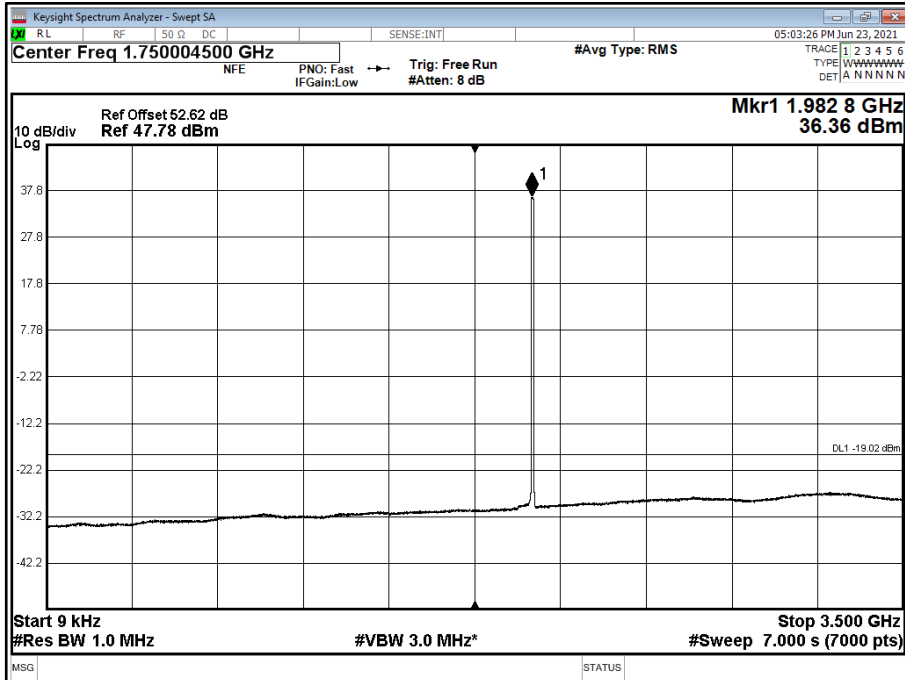

Antenna A - LTE / NR Modulation QPSK - LTE / NR Carrier Bandwidth ESS 10/90 20.0 MHz 15 kHz SCS - Channel Position B - Band 1 - Range 0.009 to 3500 MHz

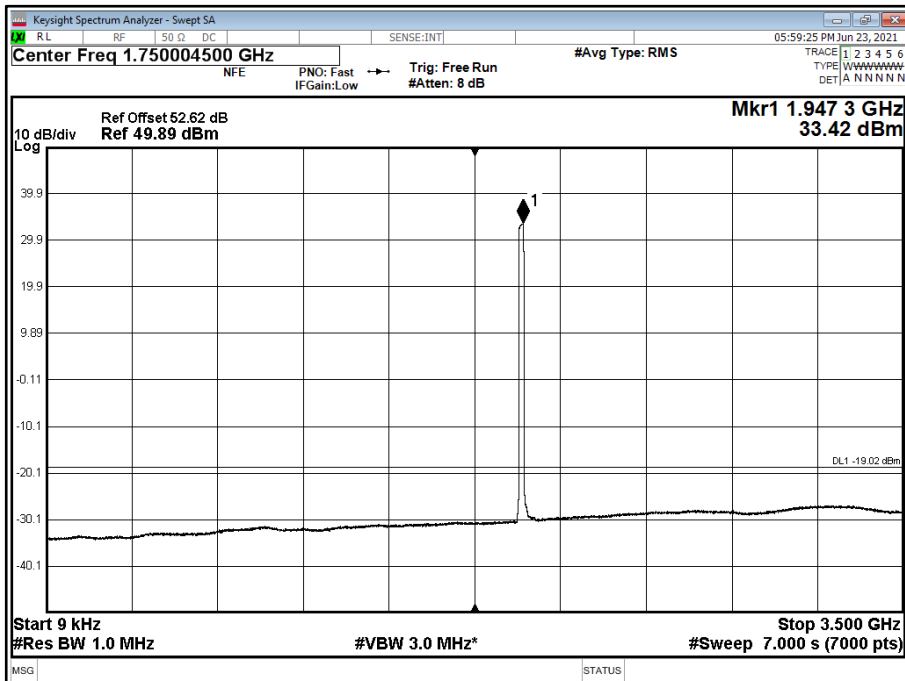



Antenna A - LTE / NR Modulation QPSK - LTE / NR Carrier Bandwidth ESS 10/90 20.0 MHz 15 kHz SCS - Channel Position M - Band 1 - Range 0.009 to 3500 MHz

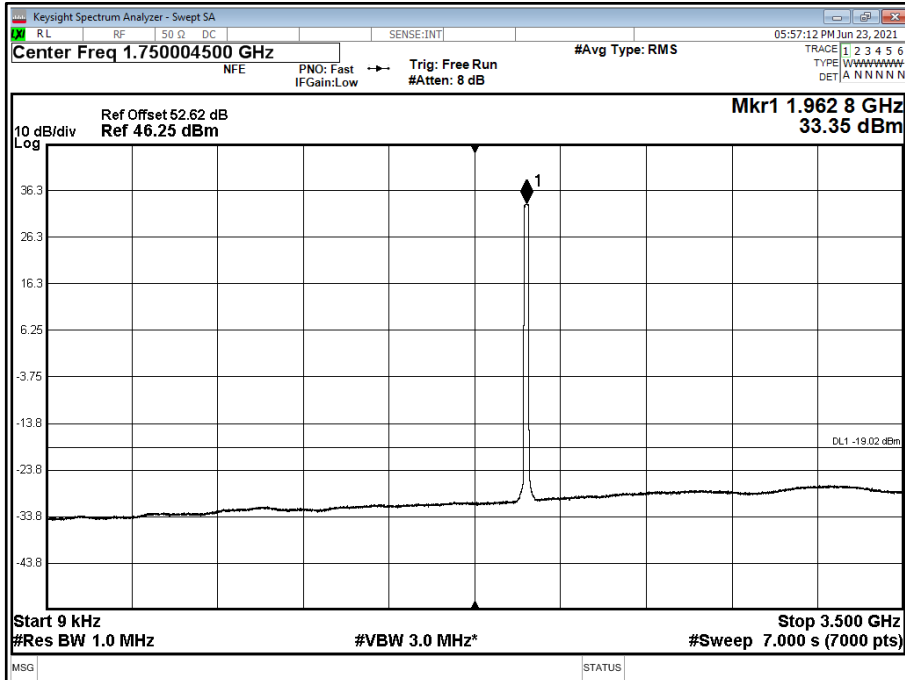

Antenna A - LTE / NR Modulation QPSK - LTE / NR Carrier Bandwidth ESS 10/90 20.0 MHz 15 kHz SCS - Channel Position T - Band 1 - Range 0.009 to 3500 MHz

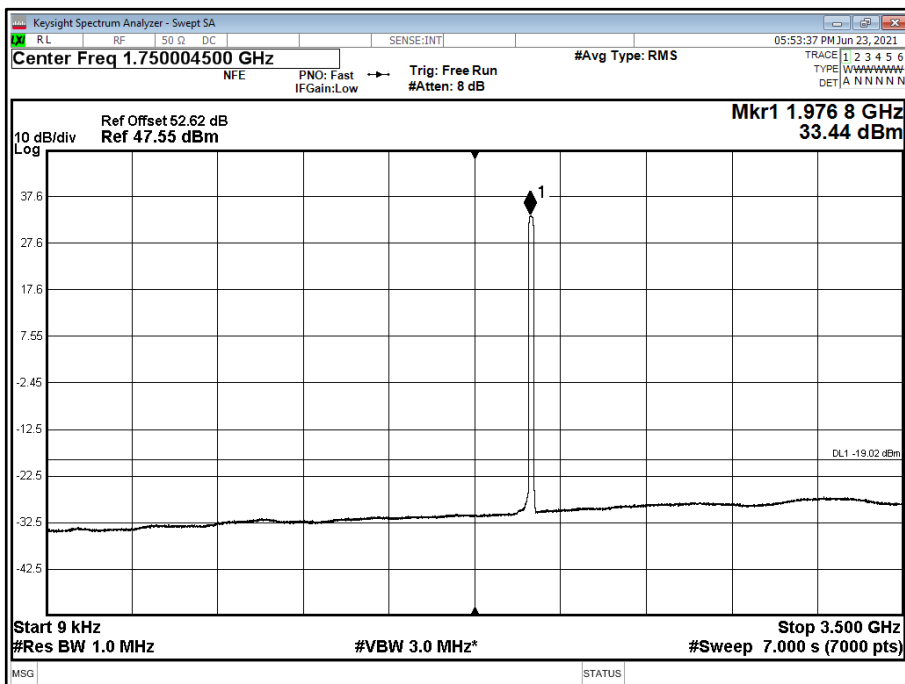



Antenna A - LTE / NR Modulation QPSK - LTE / NR Carrier Bandwidth ESS 10/90 10.0 MHz 15 kHz SCS - Channel Position B - Band 2 - Range 3500 to 8000 MHz

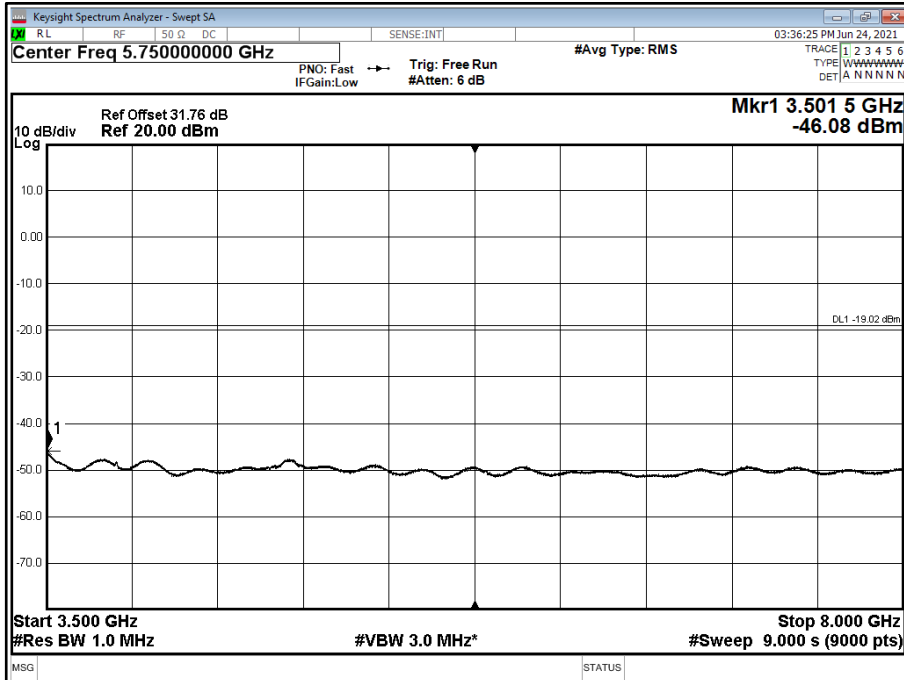

Antenna A - LTE / NR Modulation QPSK - LTE / NR Carrier Bandwidth ESS 10/90 10.0 MHz 15 kHz SCS - Channel Position M - Band 2 - Range 3500 to 8000 MHz

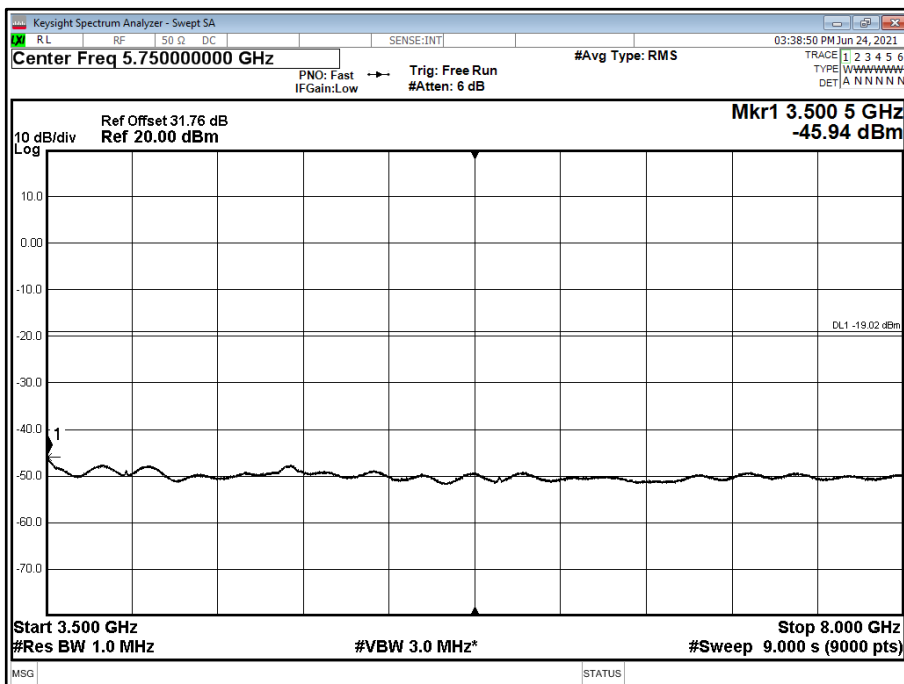



Antenna A - LTE / NR Modulation QPSK - LTE / NR Carrier Bandwidth ESS 10/90 10.0 MHz 15 kHz SCS - Channel Position T - Band 2 - Range 3500 to 8000 MHz

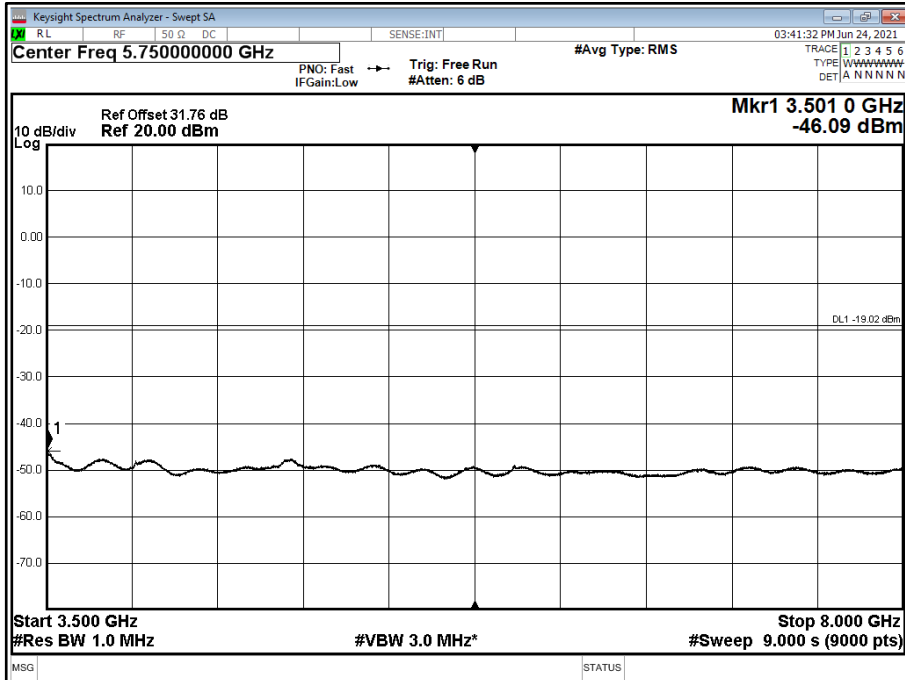

Antenna A - LTE / NR Modulation QPSK - LTE / NR Carrier Bandwidth ESS 10/90 20.0 MHz 15 kHz SCS - Channel Position B - Band 2 - Range 3500 to 8000 MHz

