

Project No: TM-2403000244P  
Report No.: TMWK2403000716KR

Page 1 / 37  
Rev. 03

# FCC/IC RADIO TEST REPORT

**Test Standard** : FCC Part 15.231+ IC RSS-210 Issue 11  
**FCC ID** : T4522055  
**IC** : 6450A-22055  
**Product name** : HOOK 434 4x4  
**Model No.** : 22055  
**Trade name** : LID Technologies  
**Operation Freq.** : TX: 433.92MHz  
RX: 125kHz  
**Test Result** : Pass  
**Statements of Conformity** : Determination of compliance is based on the results of the compliance measurement, not taking into account measurement instrumentation uncertainty.

The test Result was tested by Compliance Certification Services Inc. The test data, data evaluation, test procedures, and equipment configurations shown in this report were given in ANSI C63.10: 2013 and compliance standards.

The test results of this report relate only to the tested sample (EUT) identified in this report.

The test report of full or partial shall not copy. Without written approval of Compliance Certification Services Inc. (Wugu Laboratory)

Approved by:



---

Shawn Wu  
Supervisor

Unless otherwise stated the results shown in this test report refer only to the sample(s) tested and such sample(s) are retained for 90 days only.  
除非另有說明，此報告結果僅對測試之樣品負責，同時此樣品僅保留90天。本報告未經本公司書面許可，不可部份複製。

This document is issued by the Company subject to its General Conditions of Service printed overleaf, available on request or accessible at <http://www.sgs.com.tw/Terms-and-Conditions> and, for electronic format documents, subject to Terms and Conditions for Electronic Documents at <http://www.sgs.com.tw/Terms-and-Conditions>. Attention is drawn to the limitation of liability, indemnification and jurisdiction issues defined therein. Any holder of this document is advised that information contained hereon reflects the Company's findings at the time of its intervention only and within the limits of client's instruction, if any. The Company's sole responsibility is to its Client and this document does not exonerate parties to a transaction from exercising all their rights and obligations under the transaction documents. This document cannot be reproduced, except in full, without prior written approval of the Company. Any unauthorized alteration, forgery or falsification of the content or appearance of this document is unlawful and offenders may be prosecuted to the fullest extent of the law.

### Revision History

Rev.	Issue Date	Revisions	Effect Page	Revised By
00	September 25, 2024	Initial Issue	ALL	Allison Chen
01	October 14, 2024	See the following Note Rev.(01)	P.5, 17, 22, 30-31, 34	Allison Chen
02	October 30, 2024	See the following Note Rev.(02)	P.28-29	Allison Chen
03	November 18, 2024	See the following Note Rev.(03)	P.1, A-2	Allison Chen

**Note:**

**Rev.(01)**

1. Modify modulation type in section 1.2, test result in section 4.2.4 and 4.5.4.
2. Modify field strength remark and radiated emission setting in section 4.3.4 and 4.4.4.
3. Modify IC standard version.

**Rev.(02)**

1. Modify radiated emission setting in section 4.4.4.

**Rev.(03)**

1. Modify laboratory name and conducted setup photo.

## Table of contents

<b>1.</b>	<b>GENERAL INFORMATION .....</b>	<b>4</b>
1.1	<b>EUT INFORMATION .....</b>	4
1.2	<b>EUT CHANNEL INFORMATION .....</b>	5
1.3	<b>ANTENNA INFORMATION .....</b>	5
1.4	<b>MEASUREMENT UNCERTAINTY .....</b>	6
1.5	<b>FACILITIES AND TEST LOCATION .....</b>	7
1.6	<b>INSTRUMENT CALIBRATION .....</b>	8
1.7	<b>SUPPORT AND EUT ACCESSORIES EQUIPMENT .....</b>	9
1.8	<b>TEST SETUP DIAGRAM.....</b>	9
1.9	<b>TEST PROGRAM.....</b>	9
1.10	<b>TEST METHODOLOGY AND APPLIED STANDARDS .....</b>	9
<b>2.</b>	<b>TEST SUMMARY .....</b>	<b>10</b>
<b>3.</b>	<b>DESCRIPTION OF TEST MODES .....</b>	<b>11</b>
3.1	<b>THE WORST MODE OF OPERATING CONDITION .....</b>	11
3.2	<b>THE WORST MODE OF MEASUREMENT .....</b>	11
3.3	<b>FCC PART 15.205 RESTRICTED BANDS OF OPERATIONS.....</b>	12
3.4	<b>EUT DUTY CYCLE.....</b>	14
<b>4.</b>	<b>TEST RESULT .....</b>	<b>15</b>
4.1	<b>AC POWER LINE CONDUCTED EMISSION .....</b>	15
4.2	<b>EMISSION BANDWIDTH .....</b>	16
4.3	<b>FIELD STRENGTH OF FUNDAMENTAL.....</b>	18
4.4	<b>RADIATION UNWANTED EMISSION .....</b>	23
4.5	<b>OPERATION RESTRICTION .....</b>	32
4.6	<b>ANTENNA REQUIREMENT .....</b>	37
<b>APPENDIX 1 – PHOTOGRAPHS OF EUT</b>		

## 1. GENERAL INFORMATION

### 1.1 EUT INFORMATION

Applicant	LID Technologies S.A.S. 3 rue GIOTTO Parc Technologique du canal, Ramonville-Saint-Agne, France 31520
Manufacturer	LID Technologies S.A.S. 3 rue GIOTTO Parc Technologique du canal, Ramonville-Saint-Agne, France 31520
Factory	SVI Public Company Limited 141-142 Moo 5 Bangkadi Industrial Park, Tiwanon Road Bangkadi, Muang, Pathumthani 12000 Thailand
Equipment	HOOK 434 4x4
Model Name	22055
Model Discrepancy	N/A
Received Date	March 14, 2024
Date of Test	March 20~October 09, 2024
Periodic operation	<input type="checkbox"/> (1) A manually operated transmitter shall employ a switch that will automatically deactivate the transmitter within not more than 5 seconds of being released. <input type="checkbox"/> (2) A transmitter activated automatically shall cease transmission within 5 seconds after activation <input type="checkbox"/> (3) Periodic transmissions at regular predetermined intervals are not permitted. <input checked="" type="checkbox"/> (4) Periodic transmissions (lower field strength): each transmission is not greater than 1 sec and the silent period between transmissions is at least 30 times the duration of the transmission but in no case less than 10 sec.
Power Operation	Power from Battery: DC 3V
Operation Frequency	TX: 433.92MHz RX: 125kHz
H/W Version	322-093-1090-B0
S/W Version	B14127810138
EUT Serial Number	00039
PMN	22055

**Remark:**

- For more details, please refer to the User's manual of the EUT.
- Disclaimer: Antenna information is provided by the applicant, test results of this report are applicable to the sample EUT received.

## 1.2 EUT CHANNEL INFORMATION

Frequency Range	TX: 433.92MHz RX: 125kHz
Modulation Type	TX: FSK RX: ASK

**Remark:**

Refer as ANSI 63.10:2013 clause 5.6.1 Table 4 for test channels

Number of frequencies to be tested		
Frequency range in which device operates	Number of frequencies	Location in frequency range of operation
<input checked="" type="checkbox"/> 1 MHz or less	1	Middle
<input type="checkbox"/> 1 MHz to 10 MHz	2	1 near top and 1 near bottom
<input type="checkbox"/> More than 10 MHz	3	1 near top, 1 near middle, and 1 near bottom

## 1.3 ANTENNA INFORMATION

Antenna Type	<input type="checkbox"/> PIFA <input type="checkbox"/> PCB <input type="checkbox"/> Dipole <input type="checkbox"/> Coils <input checked="" type="checkbox"/> Other: Loop
Antenna Gain	Gain: -13.51 dBi
Brand / Model	Brand: OMON, Model: 06-030-0003-A2
Antenna Connector	N/A

**Notes:**

1.The antenna(s) of the EUT are permanently attached and there are no provisions for connection to an external antenna. So the EUT complies with the requirements of §15.203 & RSS-Gen 6.8.

## 1.4 MEASUREMENT UNCERTAINTY

PARAMETER	UNCERTAINTY
AC Powerline Conducted Emission	±2.21dB
Channel Bandwidth	±2.79dB
Radiated Emission_9kHz-30MHz	± 3.492 dB
Radiated Emission_30MHz-200MHz	± 3.62 dB
Radiated Emission_200MHz-1GHz	± 3.899 dB
Radiated Emission_1GHz-6GHz	± 5.063 dB

**Remark:**

- 1.This uncertainty represents an expanded uncertainty expressed at approximately the 95% confidence level using a coverage factor of k=2
2. ISO/IEC 17025 requires that an estimate of the measurement uncertainties associated with the emissions test results be included in the report.

## 1.5 FACILITIES AND TEST LOCATION

All measurement facilities used to collect the measurement data are located at No.11, Wugong 6th Rd., Wugu Dist., New Taipei City, Taiwan.

CAB identifier: TW1309

Test site	Test Engineer	Remark
AC Conduction Room	N/A	Not applicable, because EUT doesn't connect to AC Main Source direct.
Radiation	Tony Chao	-
RF Conducted	Jerry Chang	-

**Remark:** The lab has been recognized as the FCC accredited lab. under the KDB 974614 D01 and is listed in the FCC public Access Link (PAL) database, FCC Registration No. :444940, the FCC Designation No.:TW1309

## 1.6 INSTRUMENT CALIBRATION

966A_Radiated 433/315MHz					
Name of Equipment	Manufacturer	Model	Serial Number	Calibration Date	Calibration Due
PXA Signal Analyzer	Keysight Technologies	N9010A	MY52220817	2024-03-15	2025-03-14
Thermo-Hygro Meter	WISEWIND	1206	D07	2023-12-08	2024-12-07
Loop Antenna	COM-POWER	AL-130	121051	2023-05-23	2024-05-22
Bi-Log Antenna	Sunol Sciences	JB3	A030105	2023-08-08	2024-08-07
Preamplifier	EMEC	EM330	060609	2024-02-21	2025-02-20
Cable	Huber+Suhner	104PEA	20995+21000+182330	2024-02-21	2025-02-20
Horn Antenna	ETC	MCTD 1209	DRH13M02003	2023-12-28	2024-12-27
Preamplifier	HP	8449B	3008A00965	2023-12-22	2024-12-21
Cable	EMCI	EMC101G	221213+221011+221012	2023-10-17	2024-10-16
Turn Table	CCS	CC-T-1F	N/A	N.C.R	N.C.R
Controller	CCS	CC-C-1F	N/A	N.C.R	N.C.R
Antenna Tower	CCS	CC-A-1F	N/A	N.C.R	N.C.R
Site Validation	CCS	966A	N/A	2023-07-10	2024-07-09
<b>Software</b>	e3 V9-210616c				

Conducted FCC 15 231 433M					
Name of Equipment	Manufacturer	Model	Serial Number	Calibration Date	Calibration Due
EXA Signal Analyzer	Keysight	N9010B	MY55460167	2024-01-03	2025-01-02
DC Power Source	GWINSTEK	GPC-3030D	8070184	2023-10-02	2024-10-01
				2024-09-20	2025-09-19
<b>Software</b>	N/A				

**Remark:**

1. Each piece of equipment is scheduled for calibration once a year.
2. N.C.R. = No Calibration Required.



## 1.7 SUPPORT AND EUT ACCESSORIES EQUIPMENT

Support Unit List						Remark
Name of Equipment	Manufacturer	Model	Serial Number	Calibration Date	Calibration Due	
NB(D)	Lenovo	ThinkPad X260	N/A	N/A	N/A	1
Adapter	Lenovo	ADLX45DLC3A	N/A	N/A	N/A	2
Programming Tool Unit (PTU)	N/A	N/A	N/A	N/A	N/A	A

Conducted_433M						Remark
Name of Equipment	Manufacturer	Model	Serial Number	Calibration Date	Calibration Due	
NB(E)	Lenovo	X260	N/A	N/A	N/A	-
Programming Tool Unit (PTU)	N/A	N/A	N/A	N/A	N/A	A

## 1.8 TEST SETUP DIAGRAM

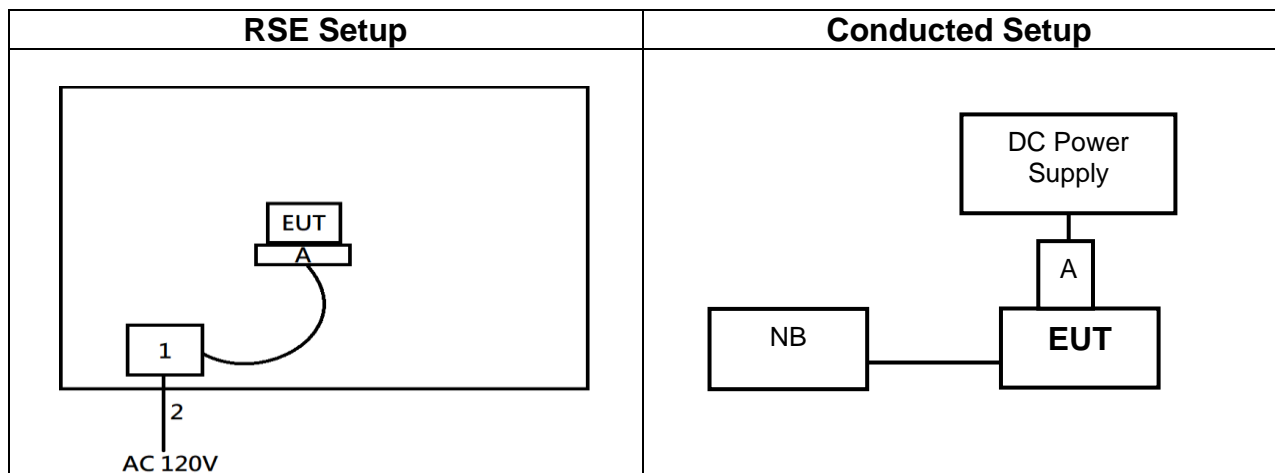

## 1.9 TEST PROGRAM

This EUT uses "WUS\_TRUCK\_4x4\_CW\_434.exe v1" software to set the frequency, modulation, and power to allow the sample to continuously transmit.

## 1.10 TEST METHODOLOGY AND APPLIED STANDARDS

The test methodology, setups and results comply with all requirements in accordance with ANSI C63.10:2013, FCC 15.231, IC RSS-210, IC RSS-Gen Rules.

## 2. TEST SUMMARY

FCC Standard Sec.	IC Standard Sec.	Chapter	Test Item	Result
15.207	RSS-GEN Sec. 8.8	4.1	AC Power-line Conducted Emission	Not applicable
15.231(c)	RSS-210 A.1.3	4.2	Emission Bandwidth	Pass
15.231(e)	RSS-210 A.1.4	4.3	Fundamental Emission	Pass
15.209(b)	RSS-GEN Sec. 8.9	4.4	Transmitter Radiated Emission	Pass
15.231(e), 15.231(a)	RSS-210 A.1.5, A.1.2	4.5	Operation Restriction	Pass
15.203	RSS-GEN Sec. 6.8	4.6	Antenna Requirement	Pass

### 3. DESCRIPTION OF TEST MODES

#### 3.1 THE WORST MODE OF OPERATING CONDITION

Operation mode	TX: 433.92MHz
RF Field strength	<b>TX 433.92MHz</b> <u>Peak: 86.17 dBuV/m</u> <u>Average: 64.76 dBuV/m</u>

Remark: Field strength performed Average level at 3m.

#### 3.2 THE WORST MODE OF MEASUREMENT

Radiated Emission Measurement Above 1G	
Test Condition	Radiated Emission Above 1G
Power supply Mode	Mode 1: EUT power by Battery
Worst Mode	<input checked="" type="checkbox"/> Mode 1 <input type="checkbox"/> Mode 2 <input type="checkbox"/> Mode 3 <input type="checkbox"/> Mode 4
Worst Position	<input type="checkbox"/> Placed in fixed position. <input checked="" type="checkbox"/> Placed in fixed position at X-Plane (E2-Plane) <input type="checkbox"/> Placed in fixed position at Y-Plane (E1-Plane) <input type="checkbox"/> Placed in fixed position at Z-Plane (H-Plane)

Radiated Emission Measurement Below 1G	
Test Condition	Radiated Emission Below 1G
Power supply Mode	Mode 1: EUT power by Battery
Worst Mode	<input checked="" type="checkbox"/> Mode 1 <input type="checkbox"/> Mode 2 <input type="checkbox"/> Mode 3 <input type="checkbox"/> Mode 4

Remark:

1. The worst mode was record in this test report.
2. EUT pre-scanned in three axis ,X,Y, Z and two polarity, for radiated measurement. The worst case(X-Plane) were recorded in this report

### 3.3 FCC PART 15.205 RESTRICTED BANDS OF OPERATIONS

According to FCC 15.231(b), 15.231(e),

(b) In addition to the provisions of §15.205, the field strength of emissions from intentional radiators operated under this section shall not exceed the following:

Fundamental frequency (MHz)	Field strength of fundamental (microvolts/meter)	Field strength of spurious emissions (microvolts/meter)
40.66-40.70	2,250	225
70-130	1,250	125
130-174	<sup>1</sup> 1,250 to 3,750	<sup>1</sup> 125 to 375
174-260	3,750	375
260-470	<sup>1</sup> 3,750 to 12,500	<sup>1</sup> 375 to 1,250
Above 470	12,500	1,250

<sup>1</sup>Linear interpolations.

(1) The above field strength limits are specified at a distance of 3 meters. The tighter limits apply at the band edges.

(2) Intentional radiators operating under the provisions of this section shall demonstrate compliance with the limits on the field strength of emissions, as shown in the above table, based on the average value of the measured emissions. As an alternative, compliance with the limits in the above table may be based on the use of measurement instrumentation with a CISPR quasi-peak detector. The specific method of measurement employed shall be specified in the application for equipment authorization. If average emission measurements are employed, the provisions in §15.35 for averaging pulsed emissions and for limiting peak emissions apply. Further, compliance with the provisions of §15.205 shall be demonstrated using the measurement instrumentation specified in that section.

(3) The limits on the field strength of the spurious emissions in the above table are based on the fundamental frequency of the intentional radiator. Spurious emissions shall be attenuated to the average (or, alternatively, CISPR quasi-peak) limits shown in this table or to the general limits shown in §15.209, whichever limit permits a higher field strength.

(e) Intentional radiators may operate at a periodic rate exceeding that specified in paragraph (a) of this section and may be employed for any type of operation, including operation prohibited in paragraph (a) of this section, provided the intentional radiator complies with the provisions of paragraphs (b) through (d) of this section, except the field strength table in paragraph (b) of this section is replaced by the following:

<b>Fundamental frequency (MHz)</b>	<b>Field strength of fundamental (microvolts/meter)</b>	<b>Field strength of spurious emissions (microvolts/meter)</b>
40.66-40.70	1,000	100
70-130	500	50
130-174	500 to 1,500 <sup>1</sup>	50 to 150 <sup>1</sup>
174-260	1,500	150
260-470	1,500 to 5,000 <sup>1</sup>	150 to 500 <sup>1</sup>
Above 470	5,000	500

<sup>1</sup>Linear interpolations.

In addition, devices operated under the provisions of this paragraph shall be provided with a means for automatically limiting operation so that the duration of each transmission shall not be greater than one second and the silent period between transmissions shall be at least 30 times the duration of the transmission but in no case less than 10 seconds.

### 3.4 EUT DUTY CYCLE

**Temperature:** 20.1~25.5°C      **Test Date:** March 20~October 09, 2024  
**Humidity:** 40~66% RH      **Tested by:** Jerry Chang

Duty Cycle			
TX ON (ms)	TX All(ms)	Duty Cycle (%)	Duty Factor(dB)
8.50	100.00	8.50%	<u>-21.41</u>

#### DUTY CYCLE

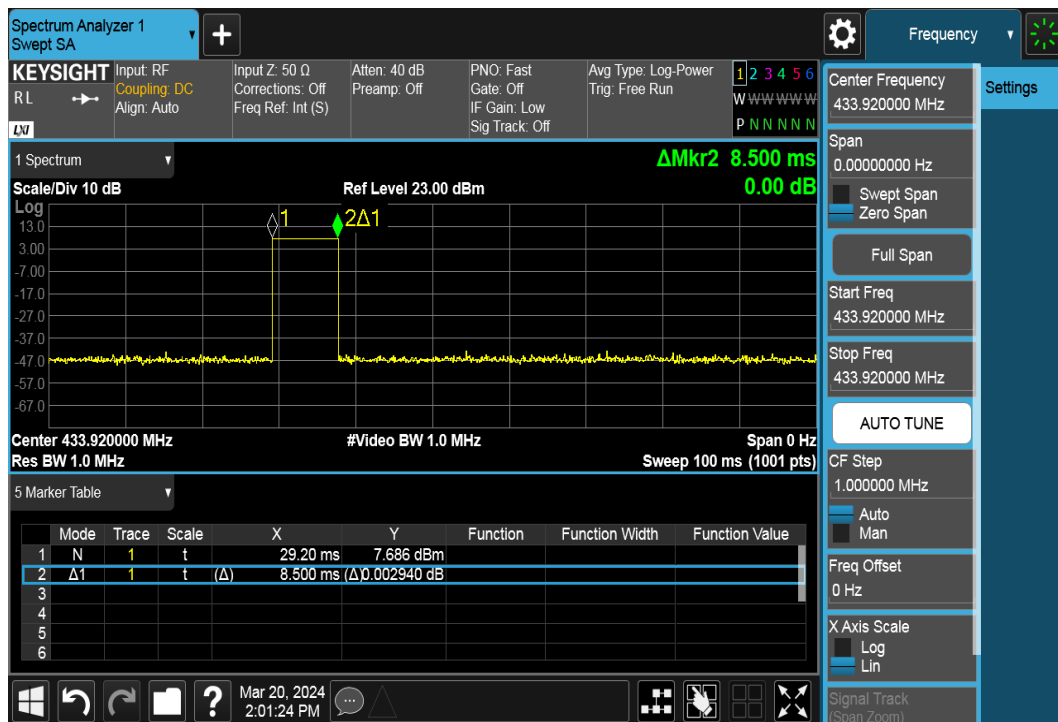

**Notes:**

1. The transmitter duty cycle was measured using a spectrum analyser in the time domain and calculated by  $20 \log(\text{Time(on)} / \text{Time(all)})$
2. The EUT transmits for a Time(on) of 100 milliseconds.

$20 \log(\text{Time(on)} / \text{Time(all)})$   
 $20 \log(0.085) = -21.41 \text{ dB}$

## 4. TEST RESULT

### 4.1 AC POWER LINE CONDUCTED EMISSION

#### 4.1.1 Test Limit

According to §15.207(a), RSS-Gen Sec.8.8,

Frequency Range (MHz)	Limits(dBμV)	
	Quasi-peak	Average
0.15 to 0.50	66 to 56*	56 to 46*
0.50 to 5	56	46
5 to 30	60	50

\* Decreases with the logarithm of the frequency.

#### 4.1.2 Test Procedure

Test method Refer as ANSI 63.10:2013 clause 6.2,

1. The EUT was placed on a table, which is 0.8m above ground plane.
2. Maximum procedure was performed on the six highest emissions to ensure EUT compliance.
3. Repeat above procedures until all frequency measured were complete

#### 4.1.3 Test Setup

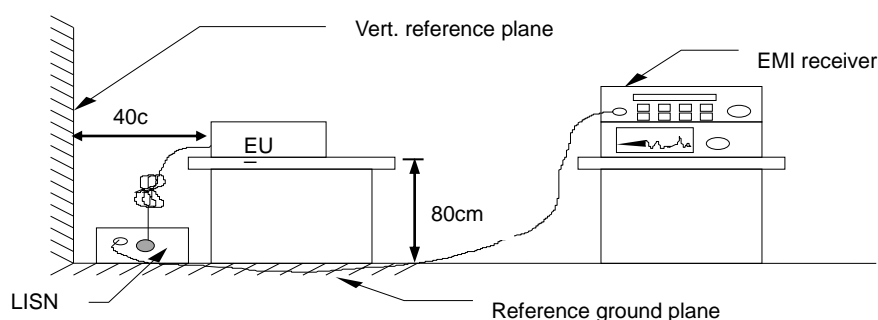

#### 4.1.4 Test Result

Not applicable, because EUT doesn't connect to AC Main Source direct.

## 4.2 EMISSION BANDWIDTH

### 4.2.1 Test Limit

According to §15.231(c), RSS-210 A.1.3,

Limit	<input checked="" type="checkbox"/> 70 MHz – 900 MHz : $F_c * 0.25 \%$ <input type="checkbox"/> Above 900 MHz : $F_c * 0.5 \%$
-------	---

### 4.2.2 Test Procedure

Test method Refer as ANSI 63.10:2013 clause 6.9.2,

SA set RBW = 1% ~ 5% OBW, VBW = three times the RBW and Detector = Peak, Trace mode = Max hold, Sweep = Auto. Measure the maximum width of the emission that is constrained by the frequencies associated with the Occupied Bandwidth (99%) and 20dB Bandwidth.

### 4.2.3 Test Setup

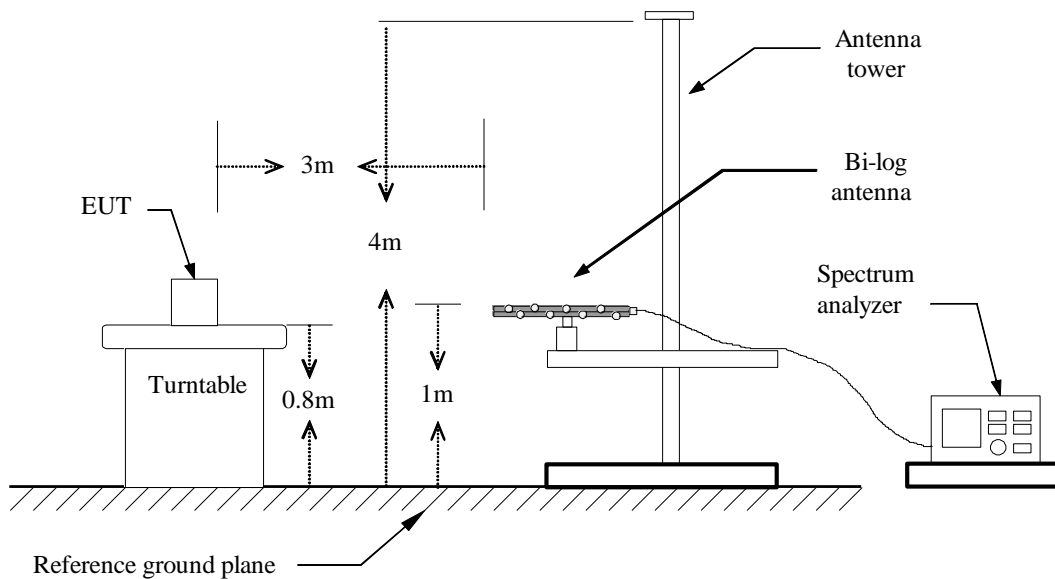



## 4.2.4 Test Result

**Temperature:** 20.1~25.5°C      **Test Date:** March 20~October 09, 2024  
**Humidity:** 40~66% RH      **Tested by:** Jerry Chang

Spectrum Bandwidth				
Frequency (MHz)	20dB Bandwidth (KHz)	20dB Bandwidth Limits (MHz)	99% Occupied BW (KHz)	99% Bandwidth Limits (MHz)
433.92	50.60	1.0848	50.205	1.0848

## Test Data

### 20dB Bandwidth and 99% Occupied BW

#### 433.92MHz

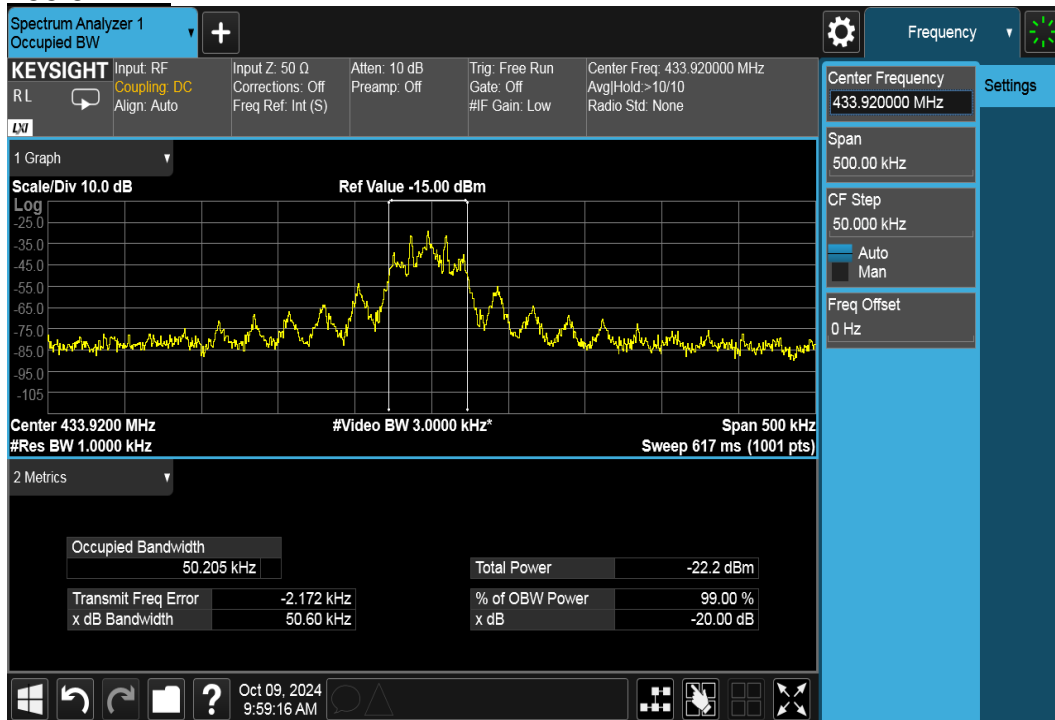

### 4.3 FIELD STRENGTH OF FUNDAMENTAL

#### 4.3.1 Test Limit

According to §15.231(e)

Fundamental frequency (MHz)	Field strength of fundamental (microvolts/meter)	Field strength of spurious emissions (microvolts/meter)
40.66-40.70	1,000	100
70-130	500	50
130-174	500 to 1,500 <sup>1</sup>	50 to 150 <sup>1</sup>
174-260	1,500	150
260-470	1,500 to 5,000 <sup>1</sup>	150 to 500 <sup>1</sup>
Above 470	5,000	500

\* Linear interpolation with frequency, f, in MHz:  
 For 130-174 MHz: Field Strength (µV/m) = (22.73 x f)-2454.55  
 For 260-470 MHz: Field Strength (µV/m) = (16.67 x f)-2833.33

According to RSS-210 A.1.4

Fundamental Frequency (MHz), Excluding Restricted Frequency Bands Specified in RSS-Gen	Field Strength of the Fundamental Emissions (µV/m at 3 m)
70-130	500
130-174	500 to 1,500*
174-260 (Note 1)	1,500
260-470 (Note 1)	1,500 to 5,000*
Above 470	5,000

\* Linear interpolation with frequency, f, in MHz:  
 For 130-174 MHz: Field Strength (µV/m) = (22.73 x f)-2454.55  
 For 260-470 MHz: Field Strength (µV/m) = (16.67 x f)-2833.33

**Note 1:** Frequency bands 225-328.6 MHz and 335.4-399.9 MHz are designated for the exclusive use of the Government of Canada. Manufacturers should be aware of possible harmful interference and degradation of their licence-exempt radio equipment in these frequency bands.

#### 4.3.2 Test Procedure

Test method Refer as ANSI 63.10:2013 clause 4.1.4 and clause 6.5

clause 4.1.4	<input checked="" type="checkbox"/> 4.1.4.2.2: Measurement Peak value. <input type="checkbox"/> 4.1.4.2.3: Duty cycle ≥ 100%. <input checked="" type="checkbox"/> 4.1.4.2.4: Measurement Average value.
--------------	---

### 4.3.3 Test Setup

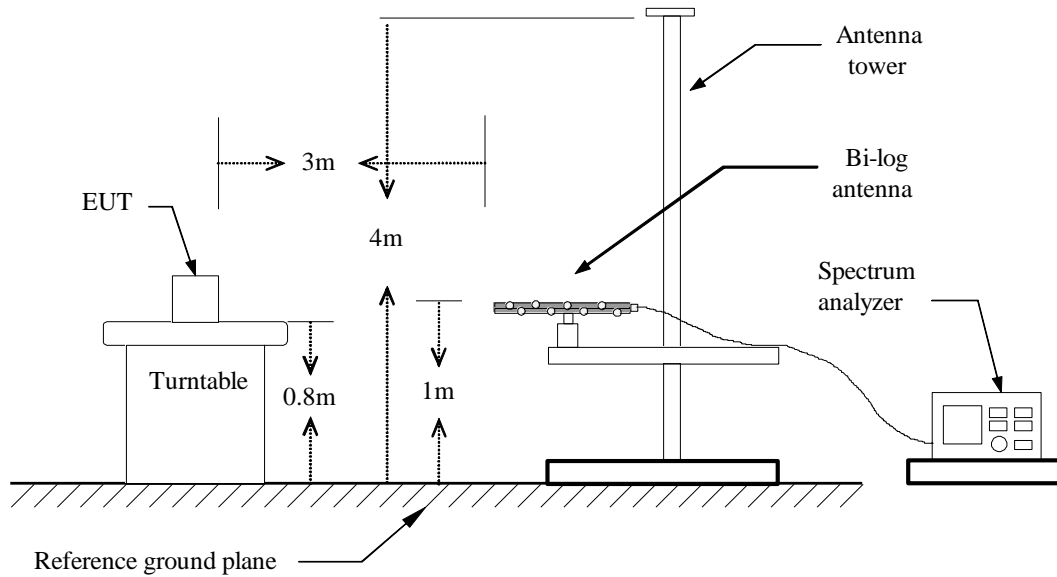

### 4.3.4 Test Result

Field Strength					
Frequency (MHz)	Fundamental (dBuV/m) at 3m	Limit (dBuV/m) at 3m	Margin (dB)	Axis/Pol.	Remark
433.920	64.76	72.87	-8.11	X/H	AVG

**Remark:**

1. Fundamental measured method setting on spectrum, RBW=100 kHz, VBW=100kHz and Detector=Peak.
2. Average result = Peak result + Duty factor = 86.17 dBuV/m – 21.41 = 64.76 dBuV/m
3. 260MHz ~ 470MHz limit is  $16.67 * (\text{Frequency, MHz}) - 2833.3333$   
 Limit =  $16.67 * (433.92 \text{ MHz}) - 2833.3333$   
 = 4400.1131 (uV/m)  
 dBuV/m =  $20 \text{ Log} (4400.1131 \text{ uV/m}) = 72.87 \text{ dBuV/m}$

## Test Data

Test Mode:	TX-433.92MHz	Temp/Hum	24.6(°C)/ 57%RH
Test Item	Fundamental	Test Date	March 22, 2024
Axis/Polarize	X-Plane / Ver.	Test Engineer	Tony Chao
Detector	Peak & Average		

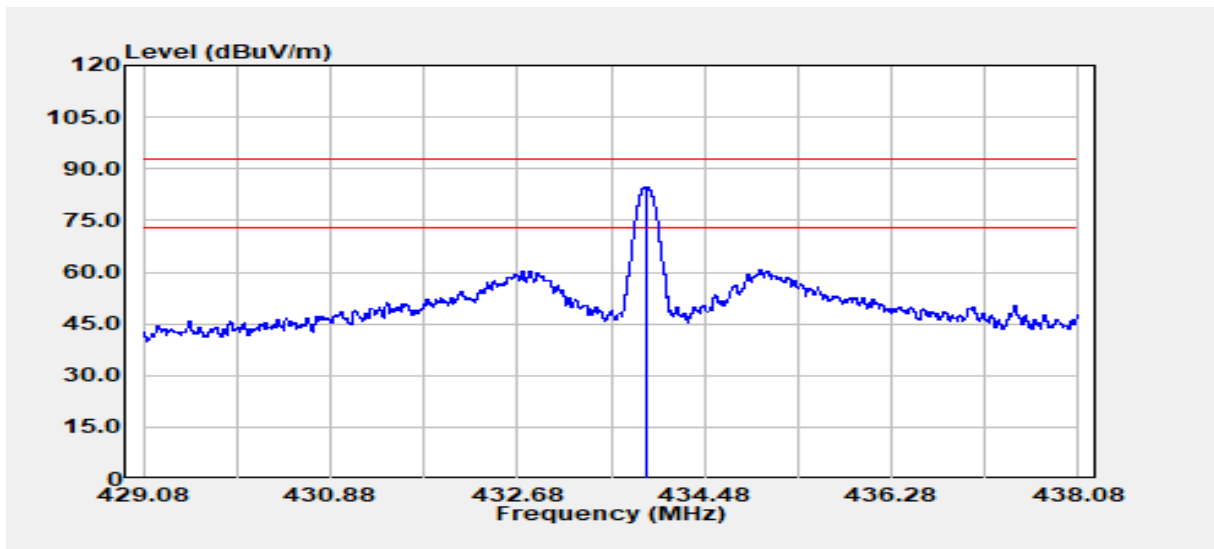

No	Frequency (MHz)	Detector Mode (PK/QP/AV)	Spectrum Reading Level (dBuV)	Factor (dB)	Actual FS (dBuV/m)	Limit @3m (dBuV/m)	Margin (dB)
1	433.92	Peak	89.41	-4.74	84.67	92.87	-8.20
2	433.92	Average	-	-21.41	63.26	72.87	-9.61

Note:

Average result = Peak result + Duty factor = 84.67 – 21.41 = 63.26 (dBuV/m)

Test Mode:	TX-433.92MHz	Temp/Hum	24.6(°C)/ 57%RH
Test Item	Fundamental	Test Date	March 22, 2024
Axis/Polarize	X-Plane / Hor.	Test Engineer	Tony Chao
Detector	Peak & Average		

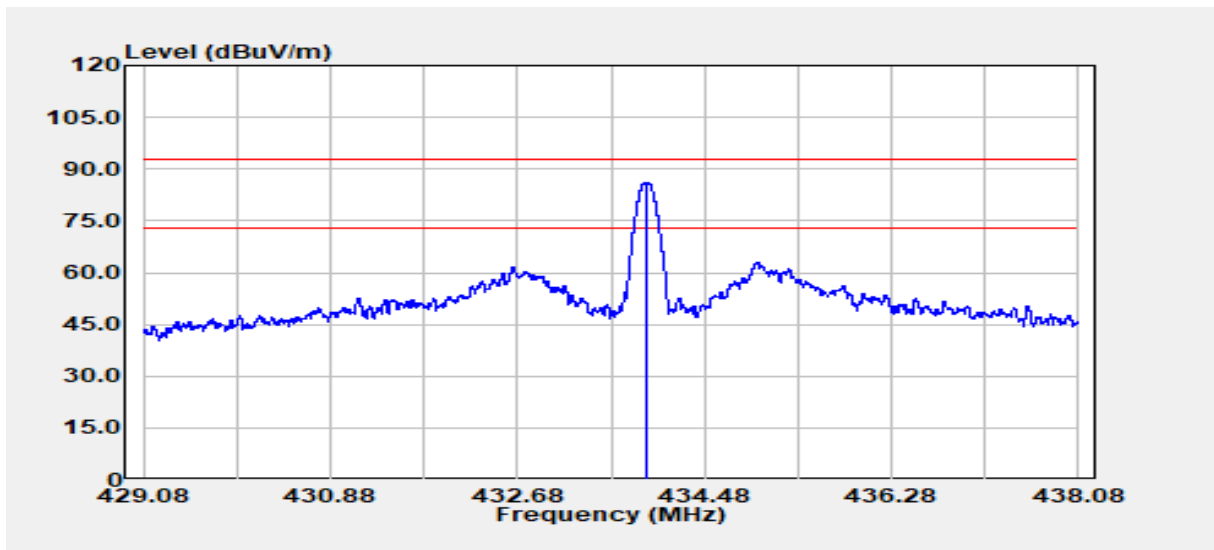

No	Frequency (MHz)	Detector Mode (PK/QP/AV)	Spectrum Reading Level (dBuV)	Factor (dB)	Actual FS (dBuV/m)	Limit @3m (dBuV/m)	Margin (dB)
1	433.92	Peak	90.91	-4.74	86.17	92.87	-6.70
2	433.92	Average	--	-21.41	64.76	72.87	-8.11

Note:

Average result = Peak result + Duty factor = 86.17 – 21.41 = 64.76 (dBuV/m)

## 4.4 RADIATION UNWANTED EMISSION

### 4.4.1 Test Limit

According to §15.231(e) and §15.209, §15.205

Unwanted emissions limit follow the table or the FCC Part 15.209, whichever limit permits higher field strength.

According to §15.231(e)

Fundamental frequency (MHz)	Field strength of fundamental (microvolts/meter)	Field strength of spurious emissions (microvolts/meter)
40.66-40.70	1,000	100
70-130	500	50
130-174	500 to 1,500 <sup>1</sup>	50 to 150 <sup>1</sup>
174-260	1,500	150
260-470	1,500 to 5,000 <sup>1</sup>	150 to 500 <sup>1</sup>
Above 470	5,000	500

\* Linear interpolation with frequency, f, in MHz:

For 130-174 MHz: Field Strength ( $\mu\text{V}/\text{m}$ ) =  $(22.73 \times f) - 2454.55$

For 260-470 MHz: Field Strength ( $\mu\text{V}/\text{m}$ ) =  $(16.67 \times f) - 2833.33$

According to RSS-210 A1.4 and RSS-GEN Sec. 8.9

Unwanted emissions shall comply with the general field strength limits specified in RSS-Gen or 10 times below the fundamental emissions field strength limit in table as below, whichever is less stringent.

According to RSS-210 A.1.4

Table A2— Permissible Field Strength Limits for Momentarily Operated Devices	
Fundamental Frequency (MHz), Excluding Restricted Frequency Bands Specified in RSS-Gen	Field Strength of the Fundamental Emissions ( $\mu\text{V}/\text{m}$ at 3 m)
70-130	500
130-174	500 to 1,500*
174-260 (Note 1)	1,500
260-470 (Note 1)	1,500 to 5,000*
Above 470	5,000

\* Linear interpolation with frequency, f, in MHz:

For 130-174 MHz: Field Strength ( $\mu\text{V}/\text{m}$ ) =  $(22.73 \times f) - 2454.55$

For 260-470 MHz: Field Strength ( $\mu\text{V}/\text{m}$ ) =  $(16.67 \times f) - 2833.33$

**Below 30MHz**

Frequency (MHz)	Field Strength				
	( $\mu\text{V/m}$ )	(dB $\mu\text{V/m}$ )	Measurement Distance (meter)	(dB $\mu\text{V/m}$ )	Measurement Distance (meter)
0.009 - 0.490	2400/F(kHz)	48.52 – 13.80	300	128.52–104.84	3
0.490 - 1.705	24000/F(kHz)	33.80 – 22.97	30	73.80– 62.97	3
1.705 – 30.0	30	29.54	30	69.54	3

**Above 30MHz**

Frequency (MHz)	Field Strength		Measurement Distance (meter)
	( $\mu\text{V/m}$ )	(dB $\mu\text{V/m}$ )	
30-88	100	40.0	3
88-216	150	43.5	3
216-960	200	46.0	3
Above 960	500	54.0	3



### 4.4.2 Test Procedure

Test method Refer as ANSI 63.10:2013

<input checked="" type="checkbox"/> Unwanted Emission	<input checked="" type="checkbox"/> clause 4.1.4.2.2: Measurement Peak value. <input type="checkbox"/> clause 4.1.4.2.3: Duty cycle $\geq$ 100%. <input checked="" type="checkbox"/> clause 4.1.4.2.4: Measurement Average value.
---	---

<input checked="" type="checkbox"/> Radiated Emission	<input checked="" type="checkbox"/> clause 6.4: below 30 MHz and test distance is 3m. <input checked="" type="checkbox"/> clause 6.5: below 30 MHz -1 GHz and test distance is 3m. <input checked="" type="checkbox"/> clause 6.6: Above 30 MHz and test distance is 3m.
---	--

1. The EUT is placed on a turntable, which is 0.8m for test below 1GHz and 1.5m for test above 1GHz, above ground plane.
2. The turntable shall be rotated for 360 degrees to determine the position of maximum emission level.
3. EUT is set 3m away from the receiving antenna, which is varied from 1m to 4m to find out the highest emissions.
4. Maximum procedure was performed on the six highest emissions to ensure EUT compliance.
5. And also, each emission was to be maximized by changing the polarization of receiving antenna both horizontal and vertical.
6. Set the spectrum analyzer in the following setting as:

Below 1GHz:

RBW=100kHz / VBW=300kHz / Sweep=AUTO

Above 1GHz:

(a)PEAK: RBW=1MHz / VBW=3MHz / Sweep=AUTO

(b)AVERAGE: RBW=1MHz,

7. Repeat above procedures until the measurements for all frequencies are complete.

Remark.

1. Although these tests were performed other than open area test site, adequate comparison measurements were confirmed against 30 m open area test site. Therefore sufficient tests were made to demonstrate that the alternative site produces results that correlate with the ones of tests made in an open field based on KDB 414788.
2. No emission found between lowest internal used/generated frequency to 30MHz (9kHz~30MHz).

## 4.4.3 Test Setup

### 9kHz ~ 30MHz

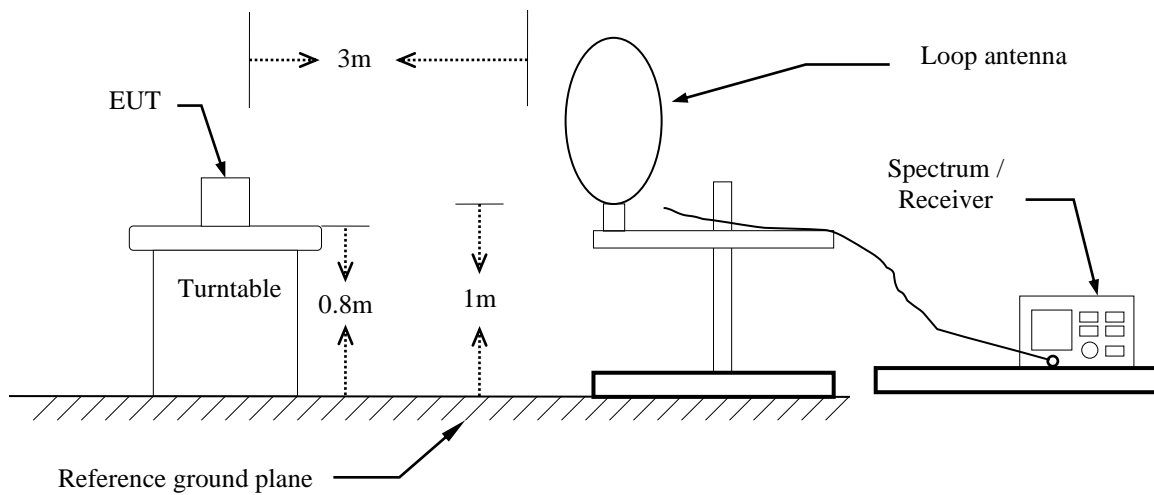

### 30MHz ~ 1 GHz

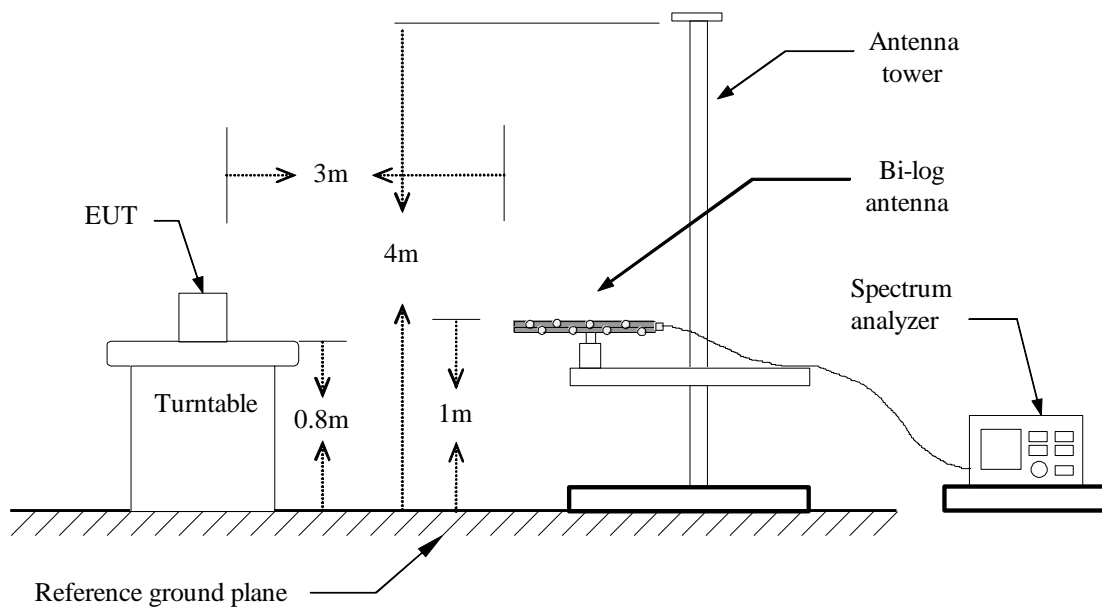

## Above 1 GHz

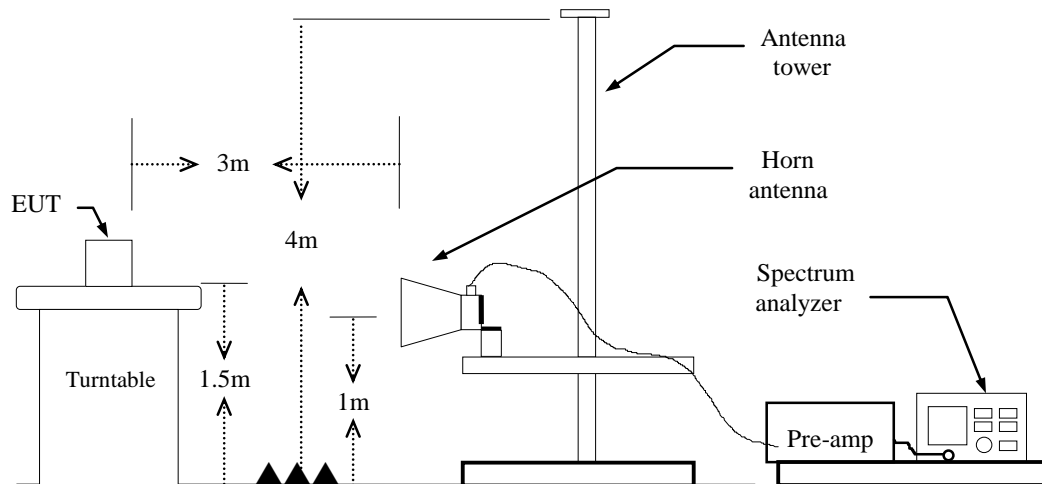

### 4.4.4 Test Result

Pass.

## Below 1GHz

Project No	:TM-2403000244P	Test Date	:2024-03-22
Operation Band	:433 MHz	Temp./Humi.	:24.6/57
Frequency	:433.92 MHz	Antenna Pol.	:VERTICAL
Operation Mode	:TX	Engineer	:Tony.Chao
EUT Pol	:E2	Test Chamber	: 966A
Setting	:default		

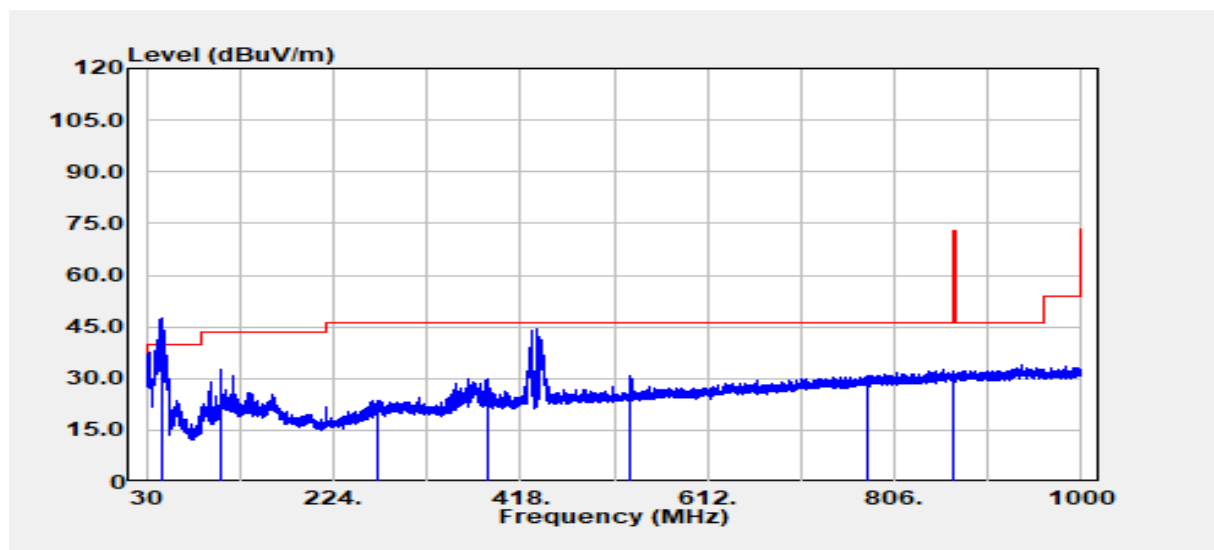

Freq. MHz	Detector Mode PK/QP/AV	Spectrum Read Level dBuV	Factor dB	Actual FS dBuV/m	Limit dBuV/m	Margin dB
45.04	QP	51.66	-12.89	38.77	40.00	-1.23
108.09	Peak	43.24	-10.83	32.41	43.50	-11.09
269.23	Peak	32.71	-9.08	23.63	46.00	-22.37
383.69	Peak	36.35	-6.48	29.88	46.00	-16.12
531.13	Peak	33.82	-2.96	30.87	46.00	-15.13
778.48	Peak	29.30	1.35	30.65	46.00	-15.35
867.84	Peak	29.95	2.54	32.49	72.87	-40.37

Project No	:TM-2403000244P	Test Date	:2024-03-22
Operation Band	:433 MHz	Temp./Humi.	:24.6/57
Frequency	:433.92 MHz	Antenna Pol.	:HORIZONTAL
Operation Mode	:TX	Engineer	:Tony.Chao
EUT Pol	:E2	Test Chamber	: 966A
Setting	:default		

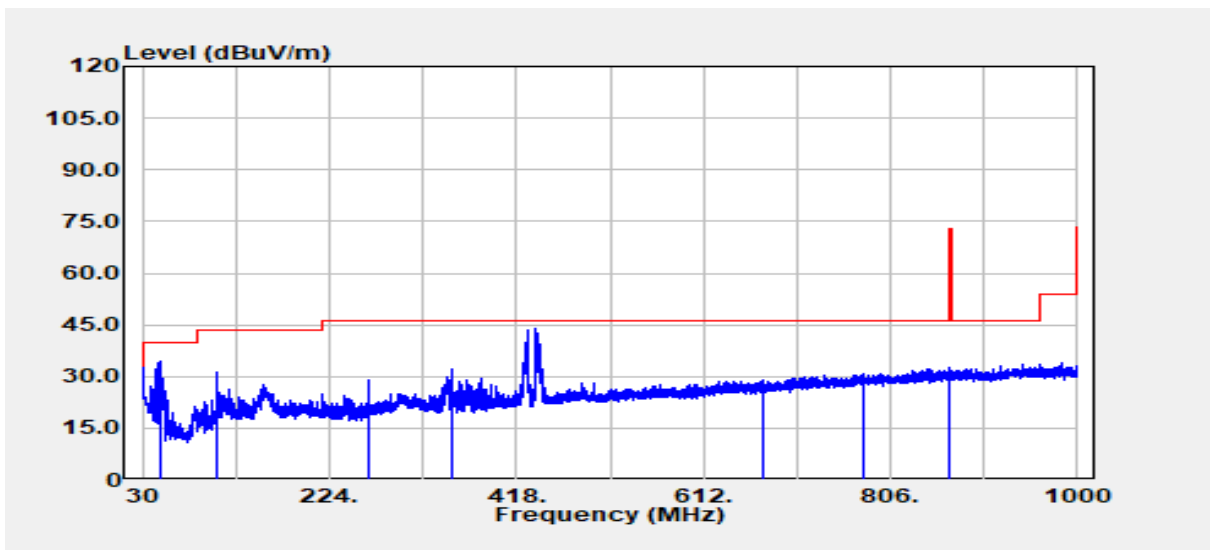

Freq. MHz	Detector Mode PK/QP/AV	Spectrum Read Level dBuV	Factor dB	Actual FS dBuV/m	Limit dBuV/m	Margin dB
48.07	Peak	48.68	-14.26	34.42	40.00	-5.58
107.72	Peak	41.95	-10.85	31.10	43.50	-12.40
264.01	Peak	38.64	-9.56	29.08	46.00	-16.92
350.46	Peak	39.39	-7.41	31.98	46.00	-14.02
672.75	Peak	29.41	-0.61	28.80	46.00	-17.20
777.99	Peak	29.43	1.33	30.76	46.00	-15.24
867.84	Peak	30.07	2.54	32.61	72.87	-40.26

## Above 1GHz

Project No	:TM-2403000244P	Test Date	:2024-03-22
Operation Band	:433 MHz	Temp./Humi.	:24.6/57
Frequency	:433.92 MHz	Antenna Pol.	:VERTICAL
Operation Mode	:TX	Engineer	:Tony.Chao
EUT Pol	:E2	Test Chamber	: 966A
Setting	:default		

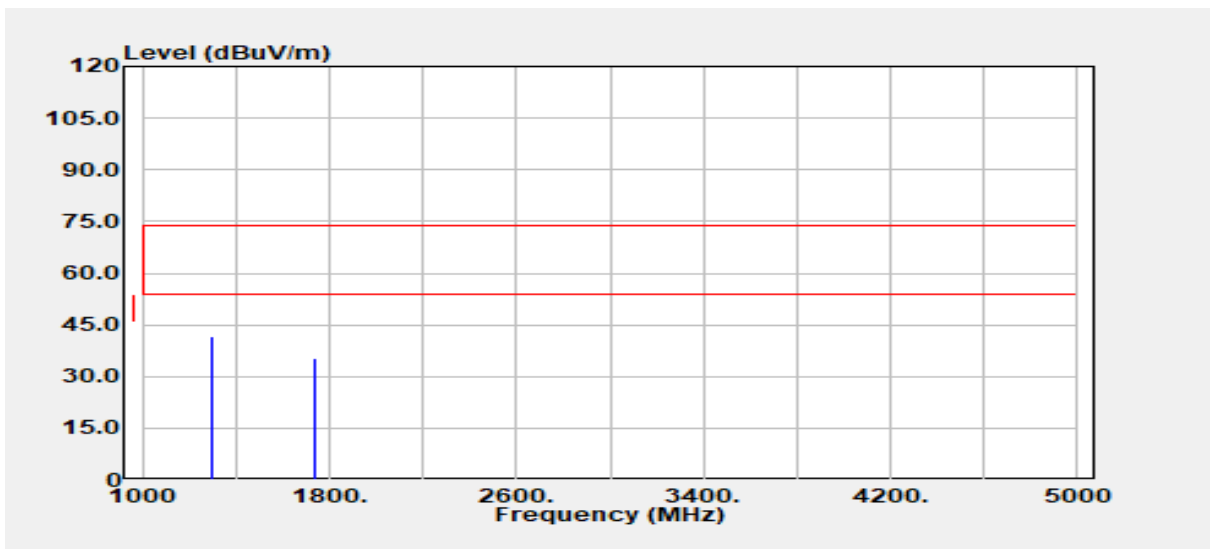

Freq. MHz	Detector Mode PK/QP/AV	Spectrum Read Level dB $\mu$ V	Factor dB	Actual FS dB $\mu$ V/m	Limit dB $\mu$ V/m	Margin dB
1301.76	Peak	49.28	-7.48	41.79	74.00	-32.21
1301.76	Average	--	-21.41	20.38	54.00	-33.62
1735.68	Peak	41.69	-6.34	35.36	74.00	-38.64
1735.68	Average	--	-21.41	13.95	54.00	-40.05

Project No	:TM-2403000244P	Test Date	:2024-03-22
Operation Band	:433 MHz	Temp./Humi.	:24.6/57
Frequency	:433.92 MHz	Antenna Pol.	:HORIZONTAL
Operation Mode	:TX	Engineer	:Tony.Chao
EUT Pol	:E2	Test Chamber	: 966A
Setting	:default		

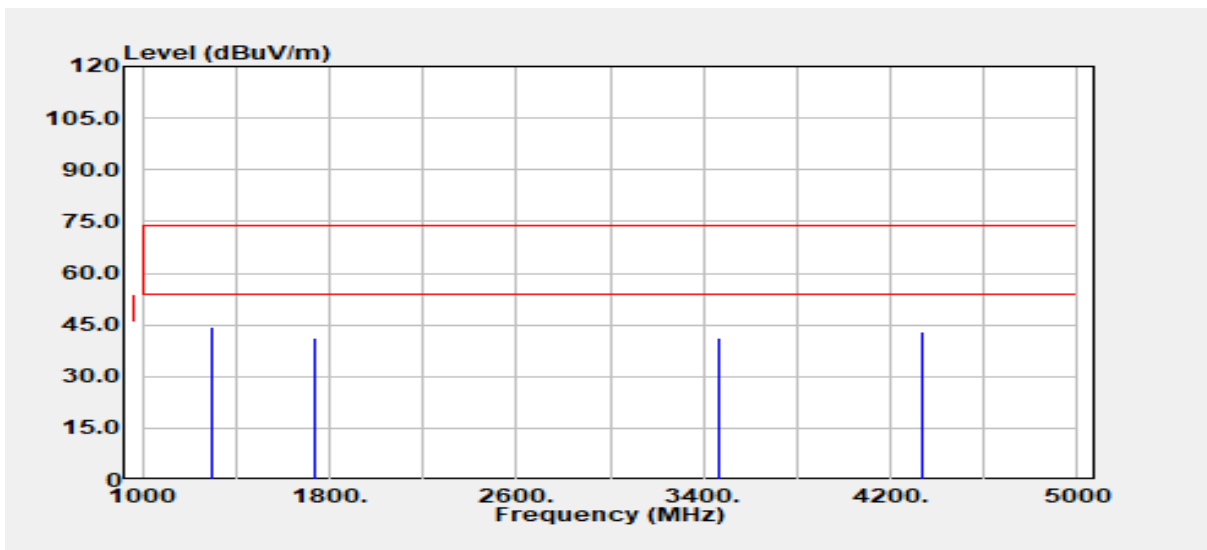

Freq. MHz	Detector Mode PK/QP/AV	Spectrum Read Level dB $\mu$ V	Factor dB	Actual FS dB $\mu$ V/m	Limit dB $\mu$ V/m	Margin dB
1301.76	Peak	51.90	-7.48	44.42	74.00	-29.58
1301.76	Average	--	-21.41	23.01	54.00	-30.99
1735.68	Peak	47.50	-6.34	41.17	74.00	-32.83
1735.68	Average	--	-21.41	19.76	54.00	-34.24
3471.36	Peak	42.00	-0.69	41.31	74.00	-32.69
3471.36	Average	--	-21.41	19.90	54.00	-34.10
4339.20	Peak	41.45	1.69	43.14	74.00	-30.86
4339.20	Average	--	-21.41	21.73	54.00	-32.27

**Remark:**

1. Measuring frequencies from 1 GHz to the 10th harmonic of highest fundamental frequency.
2. For above 1GHz, the EUT peak value was under average limit, therefore the Average value compliance with the average limit.

## 4.5 OPERATION RESTRICTION

### 4.5.1 Test Limit

According to §15.231(e)

In addition, devices operated under the provisions of this paragraph shall be provided with a means for automatically limiting operation so that the duration of each transmission shall not be greater than one second and the silent period between transmissions shall be at least 30 times the duration of the transmission but in no case less than 10 seconds.

According to §15.231(a)(3)

Periodic transmissions at regular predetermined intervals are not permitted. However, polling or supervision transmissions, including data, to determine system integrity of transmitters used in security or safety applications are allowed if the total duration of transmissions does not exceed more than two seconds per hour for each transmitter. There is no limit on the number of individual transmissions, provided the total transmission time does not exceed two seconds per hour.

According to RSS-210 A.1.5(b)

In addition, devices operated under the provisions of this section shall be capable of automatically limiting their operation so that the duration of each transmission is not greater than 1 second and the silent period between transmissions is at least 30 times the duration of the transmission, but not less than 10 seconds under any circumstances. However, devices that are designed for limited use for the purpose of initial programming, reprogramming or installing, and not for regular operations, may operate for up to 5 seconds provided such devices are used only occasionally in connection with each unit being programmed or installed.

According to RSS-210 A.1.2(c)

Periodic transmissions at regular, predetermined intervals are not allowed, except as specified in section A.1.5. Nonetheless, polling or supervision transmissions that determine system integrity of transmitters used in security or safety applications are permitted as long as the total duration of transmission does not exceed 2 seconds per hour for each transmitter.



## 4.5.2 Test Procedure

Test method Refer as ANSI 63.10:2013 clause 7.4

Set the RBW=1MHz, VBW=1MHz, Detector = Peak, Trace mode = Max hold, Sweep = 1s. Measure

## 4.5.3 Test Setup

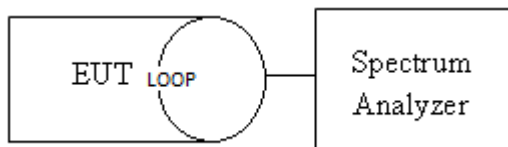

#### 4.5.4 Test Result

**Temperature:** 20.1~25.5°C      **Test Date:** March 20~October 09, 2024  
**Humidity:** 40~66% RH      **Tested by:** Jerry Chang  
**Test Mode:** Normal

Transmissions Time				
Pulse On Time (ms)	Pulse Number	Total Pulse On Time (ms)	Transmission off time (ms)	Result
8.5	3	25.5	127400	Pass

**Temperature:** 22.2°C      **Test Date:** May 31, 2024  
**Humidity:** 62% RH      **Tested by:** Jerry Chang  
**Test Mode:** Alarm mode

Transmissions Time					
Freq. (MHz)	Frame Time (ms)	Numbers of Frames Per Burst	Numbers of bursts per hour	Transmissions Time in One Hour (s)	Max. Transmissions Time Limit (s)
433.92	8.45	3	32	0.81	2
<b>Result</b>	<b>PASS</b>				

## Test Data

### Duty Cycle

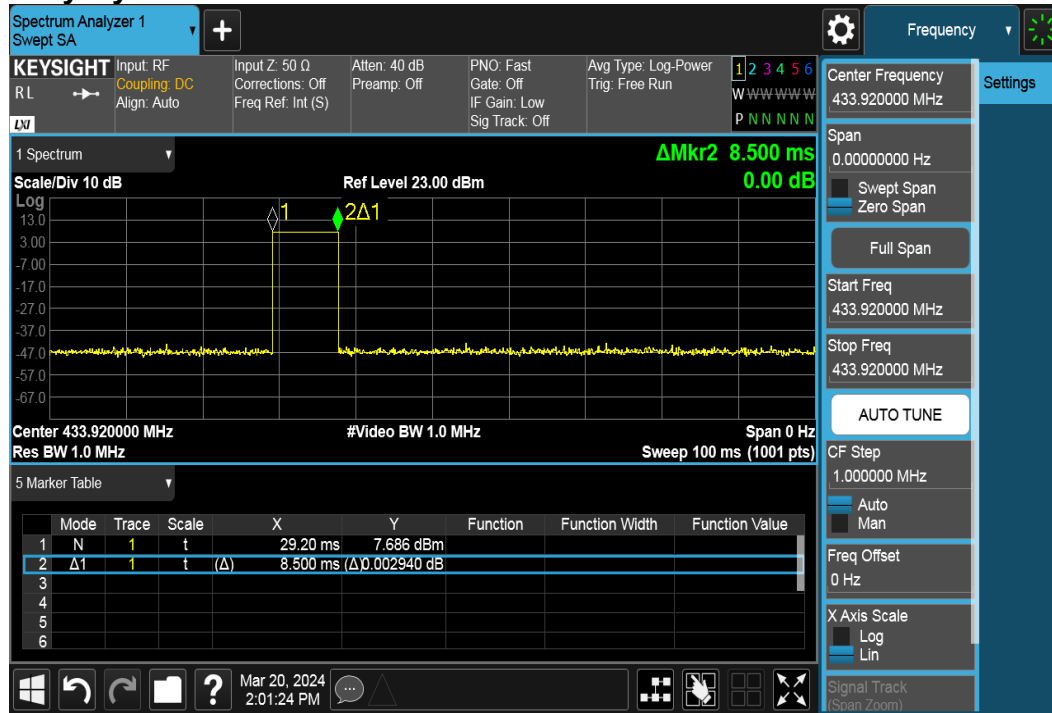

## Transmission time burst

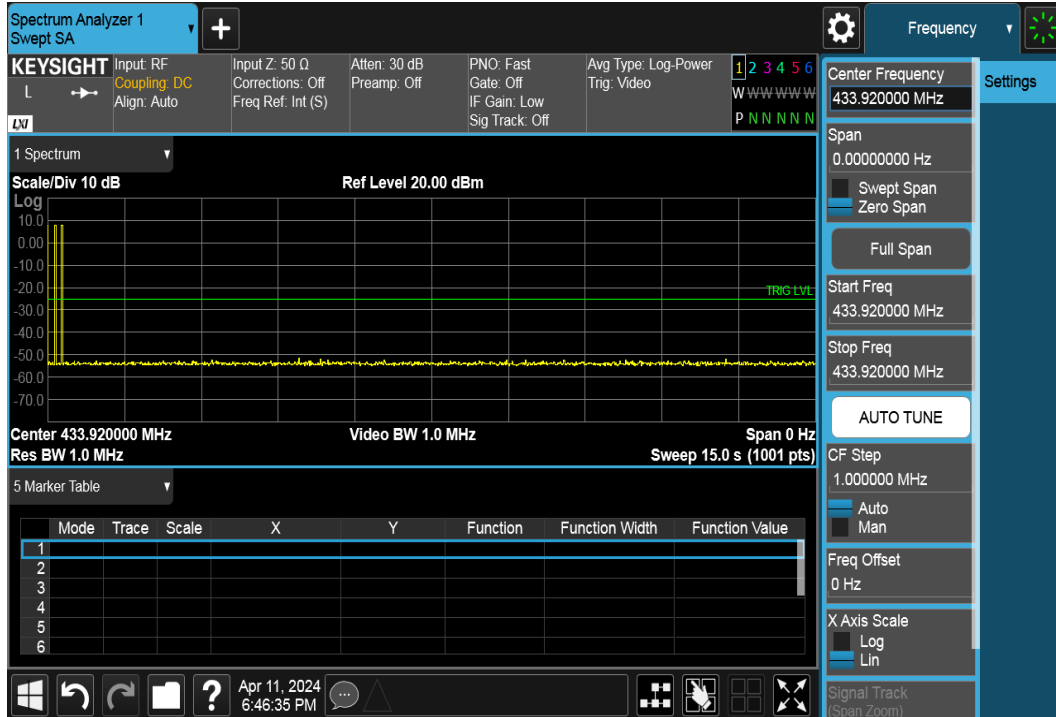

## Transmission off time

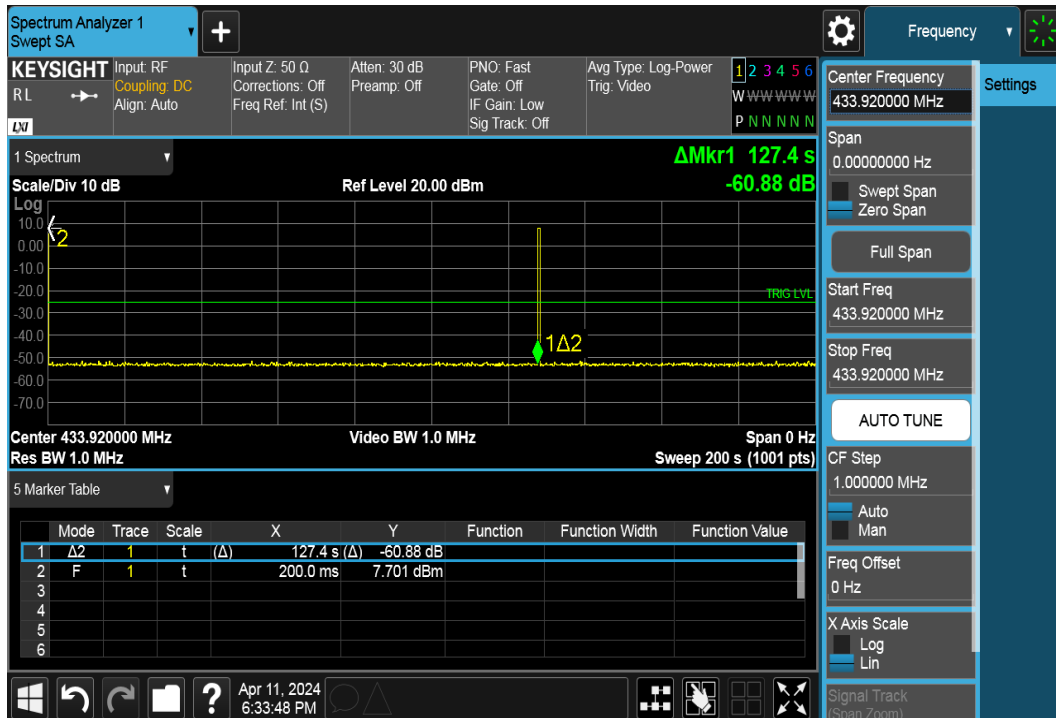

## 4.6 ANTENNA REQUIREMENT

### § 15.203 Antenna requirement.

An intentional radiator shall be designed to ensure that no antenna other than that furnished by the responsible party shall be used with the device. The use of a permanently attached antenna or of an antenna that uses a unique coupling to the intentional radiator shall be considered sufficient to comply with the provisions of this section. The manufacturer may design the unit so that a broken antenna can be replaced by the user, but the use of a standard antenna jack or electrical connector is prohibited. This requirement does not apply to carrier current devices or to devices operated under the provisions of §15.211, §15.213, §15.217, §15.219, or §15.221. Further, this requirement does not apply to intentional radiators that must be professionally installed, such as perimeter protection systems and some field disturbance sensors, or to other intentional radiators which, in accordance with §15.31(d), must be measured at the installation site. However, the installer shall be responsible for ensuring that the proper antenna is employed so that the limits in this part are not exceeded.

<b>Antenna Type</b>	<input type="checkbox"/> PIFA <input type="checkbox"/> PCB <input type="checkbox"/> Dipole <input type="checkbox"/> Coils <input checked="" type="checkbox"/> Other: Loop
<b>Antenna Gain</b>	Gain: -13.51 dBi

Remark:

1.The antenna(s) of the EUT are permanently attached and there are no provisions for connection to an external antenna. So the EUT complies with the requirements of §15.203 and RSS-Gen 6.8.

**- End of Test Report -**