

Antenna Specification

Specifications Summary

| ITEM | SPEC. | |
|------------------|---------------|----------|
| | 2.4GHz | |
| Center Frequency | 2402 MHz | 0.04 dBi |
| | 2442 MHz | 0.38 dBi |
| | 2484 MHz | 0.89 dBi |
| MAX. GAIN | 0.89 dBi | |
| Impedance | 50Ω | |

| ITEM | SPEC. | |
|------------------|--------------|----------|
| Model Name | 5 GHz | |
| Center Frequency | 5150 MHz | 1.97 dBi |
| | 5300 MHz | 3.96 dBi |
| | 5500 MHz | 3.30 dBi |
| | 5800 MHz | 2.86 dBi |
| MAX. GAIN | 3.96 dBi | |
| Impedance | 50Ω | |

Antenna Photo & Length

天线类型/ ANT Type: PCB
 天线型号/ ANT Model: BT/Wi-Fi ANT

制造商/ Manufacturer: YEALINK(XIAMEN) NETWORK TECHNOLOGY CO.,LTD.
 No.666 Hu'an Rd. Huli District Xiamen City, Fujian, P.R. China

天线尺寸/ANT Size

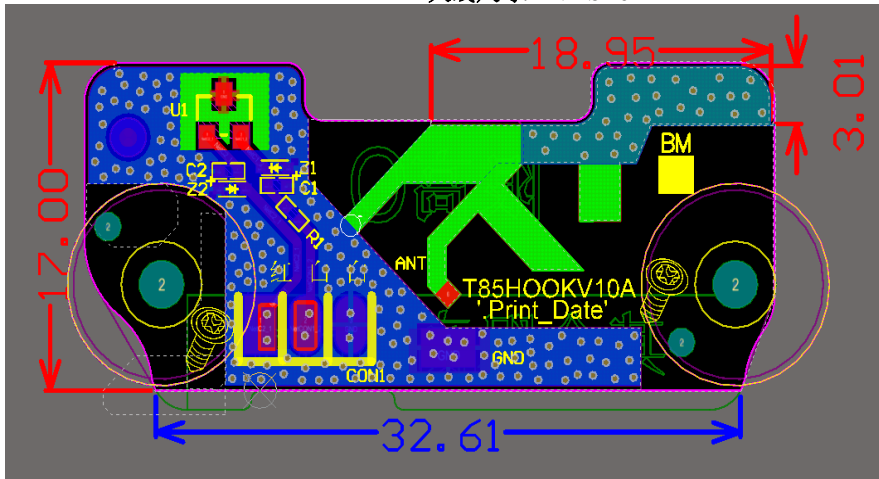

2402MHz

3D Antenna pattern

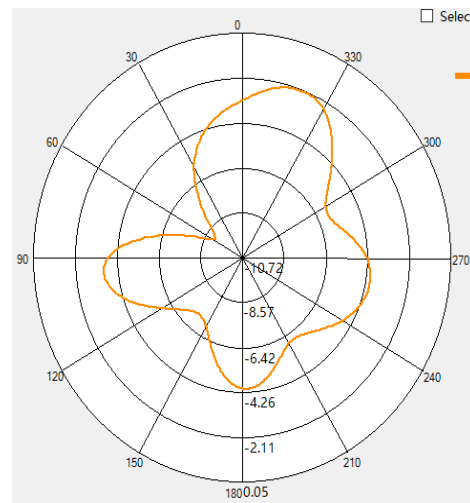
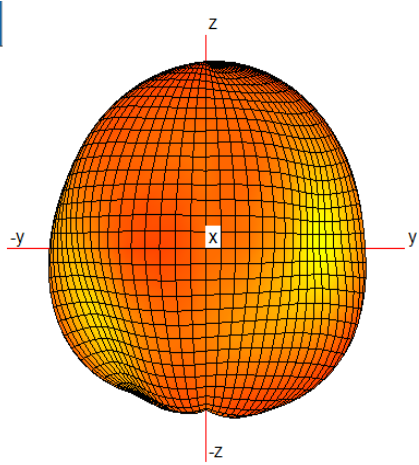

2D Antenna pattern (X->Y;X->Z;Y->Z)

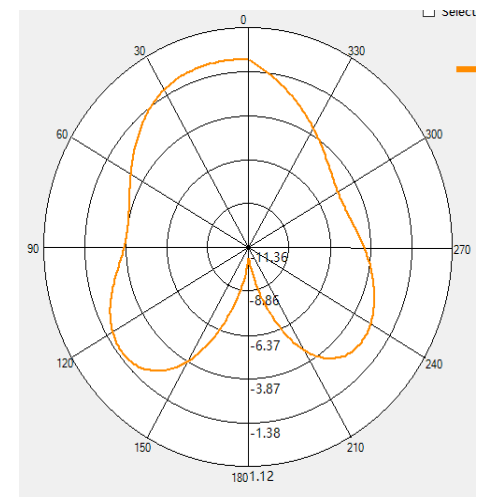
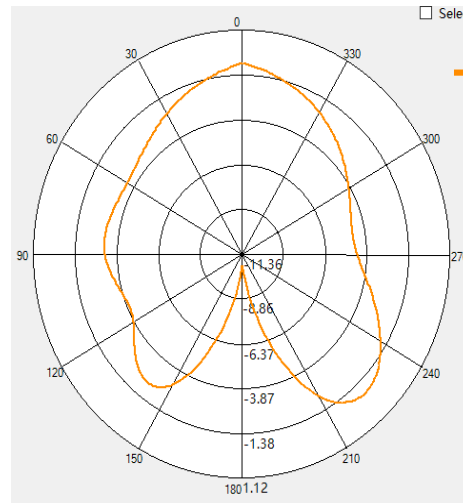

2442MHz

3D Antenna pattern

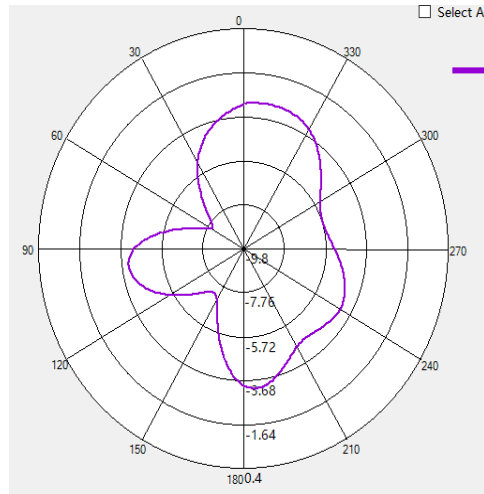
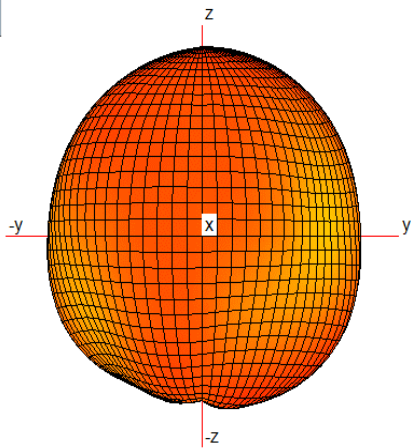

2D Antenna pattern (X->Y;X->Z;Y->Z)

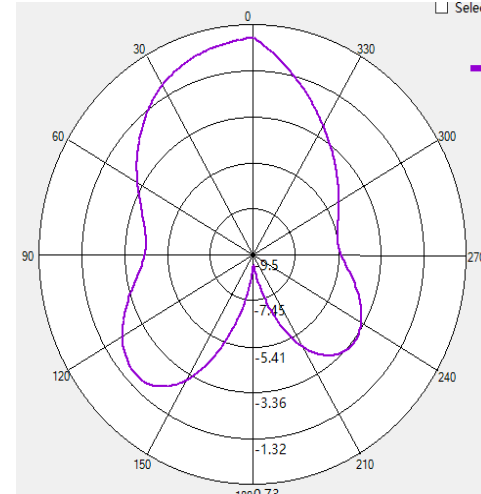

2484MHz

3D Antenna pattern

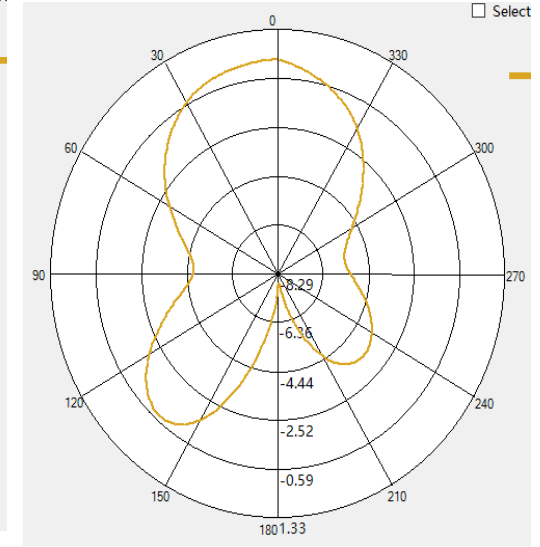
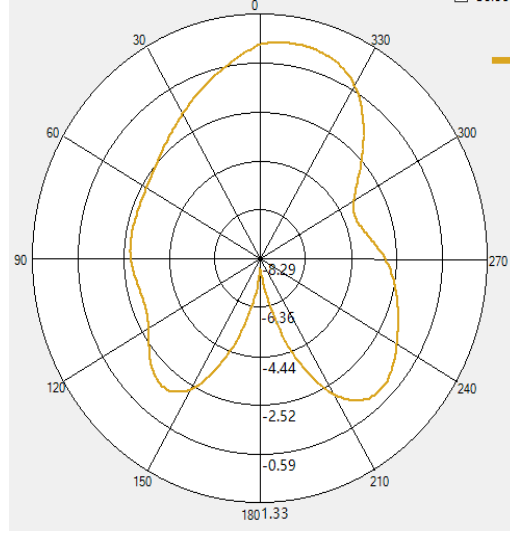
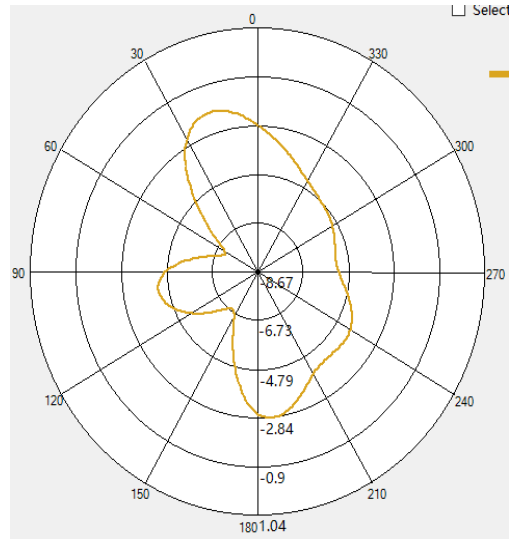
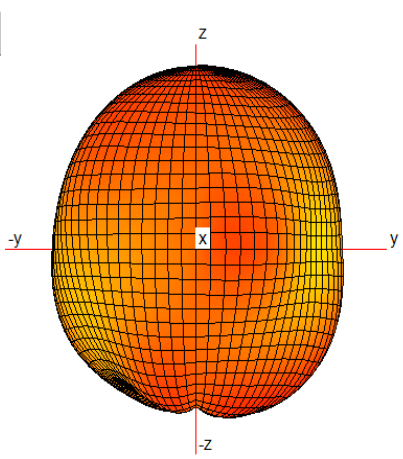

| Point Values | Minimum Gain (dBi) | Maximum Gain (dBi) | Average Gain (dBi) |
|-----------------|--------------------|--------------------|--------------------|
| Frequency (MHz) | | | |
| 2402 | -10.6976 | 0.03928 | -3.66230 |
| 2442 | -09.0681 | 0.37718 | -3.43554 |
| 2484 | -07.8574 | 0.89360 | -2.97618 |

5150MHz

3D Antenna pattern

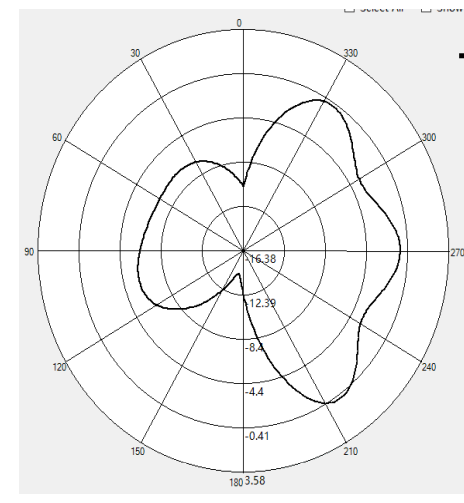
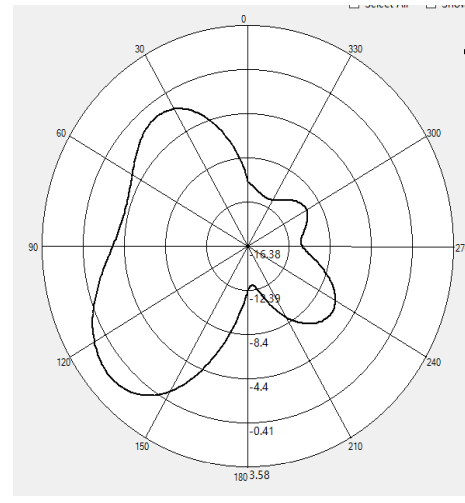
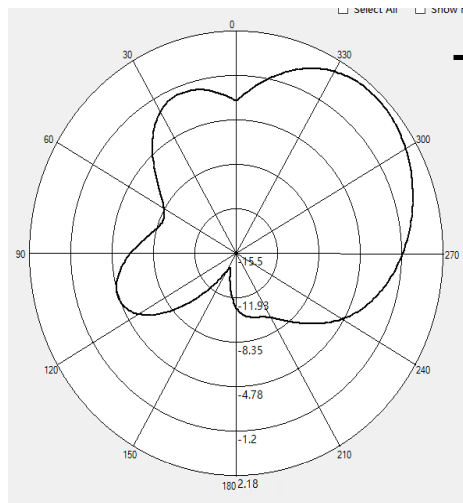
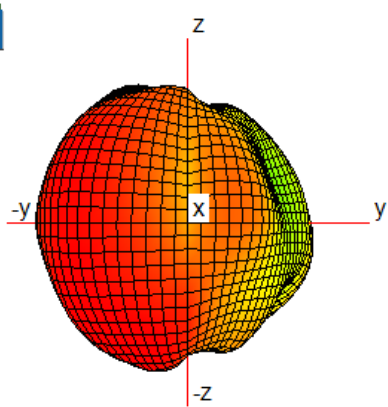

5300MHz

3D Antenna pattern

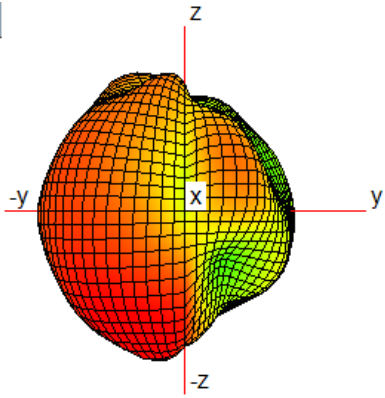

2D Antenna pattern (X->Y;X->Z;Y->Z)

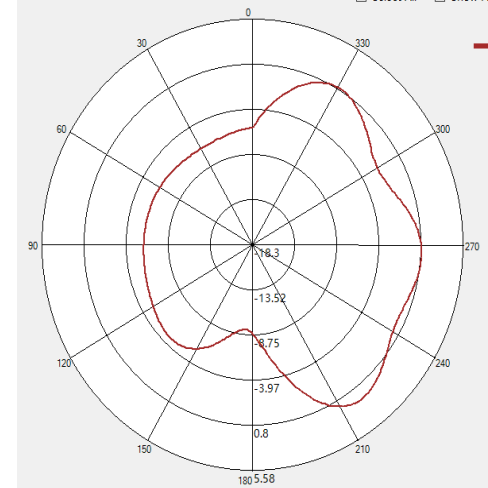
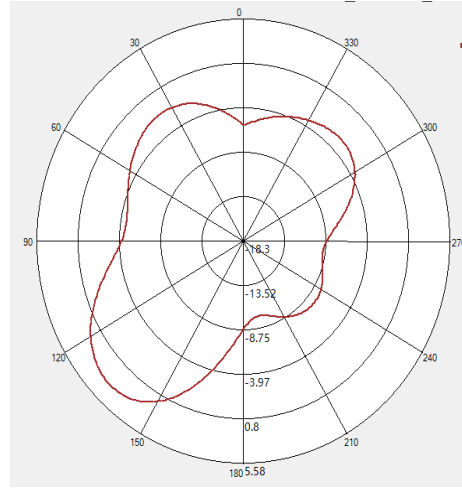
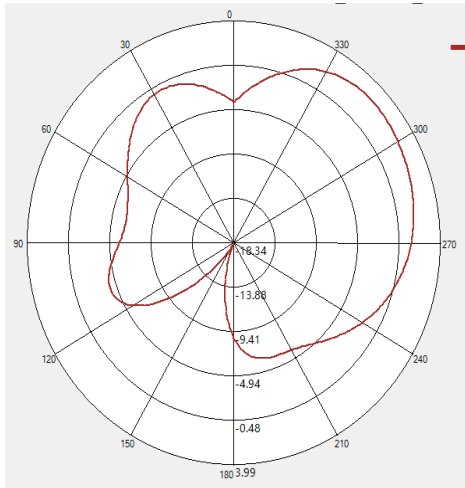

5500MHz

3D Antenna pattern

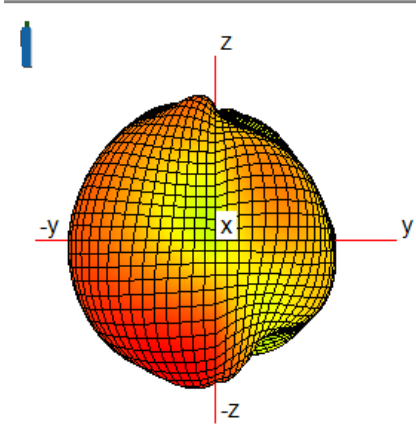

2D Antenna pattern (X->Y;X->Z;Y->Z)

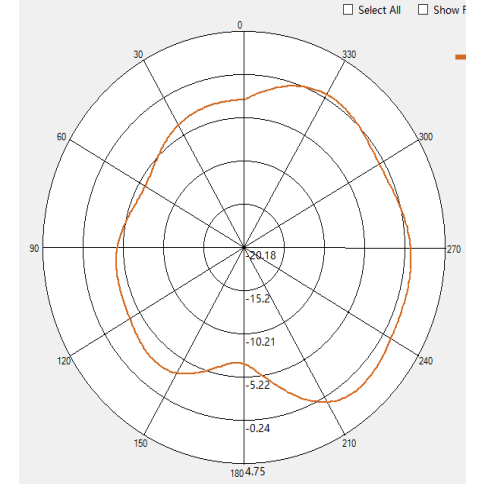
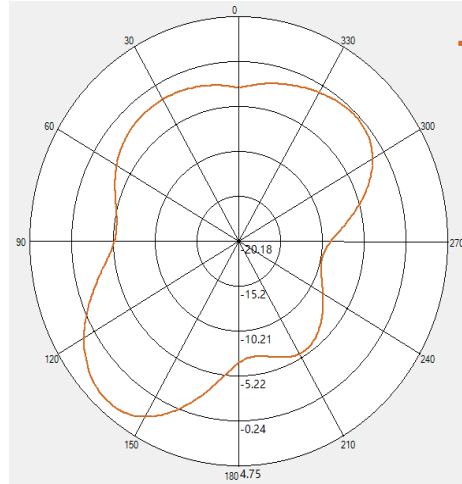
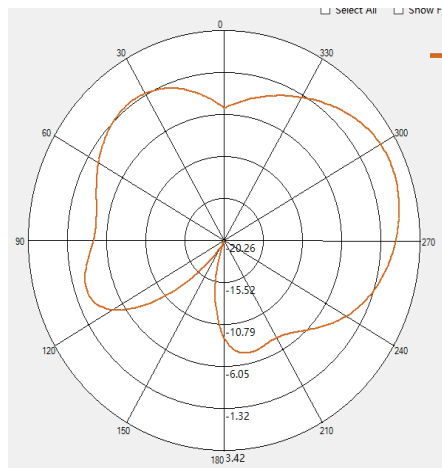

5800MHz

3D Antenna pattern

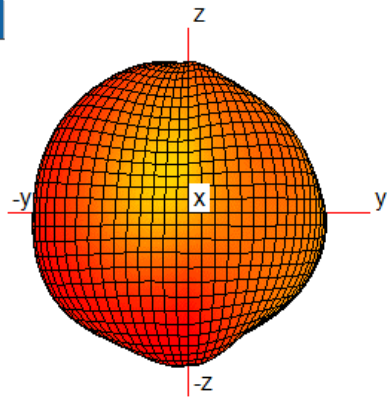

2D Antenna pattern (X->Y; X->Z; Y->Z)

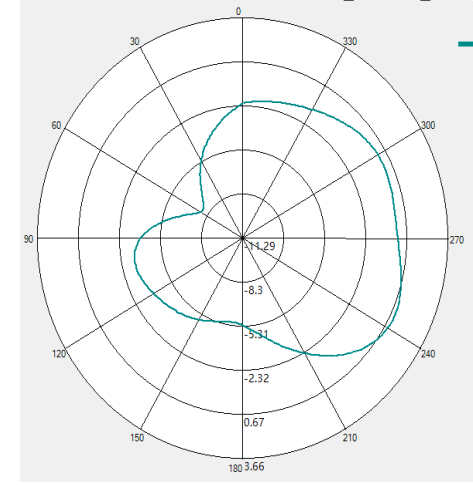
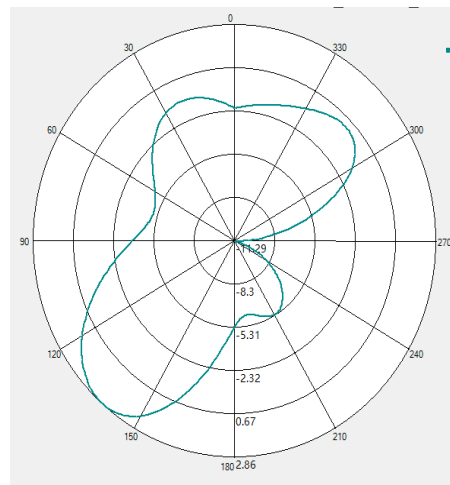
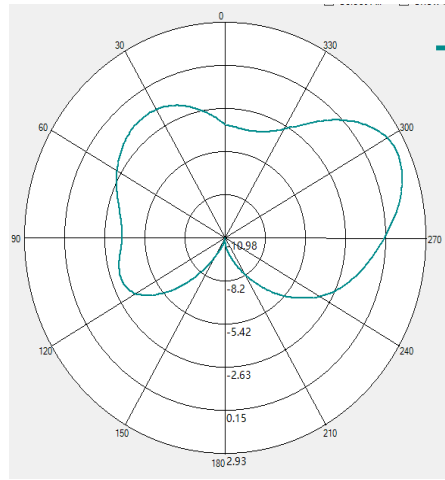

| Point Values | Minimum Gain (dBi) | Maximum Gain (dBi) | Average Gain (dBi) |
|-----------------|--------------------|--------------------|--------------------|
| Frequency (MHz) | | | |
| 5150 | -15.3788 | 1.97151 | -3.13465 |
| 5300 | -18.2960 | 3.96338 | -1.71562 |
| 5500 | -20.1817 | 3.29880 | -1.79793 |
| 5800 | -10.6593 | 2.86024 | -1.94548 |