

FCC Test Report

Report No.: RF130709C02E

FCC ID: RYK-WPEA252NI

Test Model: WPEA-252NI

Received Date: Jul. 09, 2013

Test Date: Jul. 11 ~ Jul. 12, 2013
Apr. 21 ~ Apr. 24, 2015

Issued Date: Apr. 28, 2015

Applicant: SparkLAN Communications, Inc.

Address: 8F., No. 257, Sec. 2, Tiding Blvd., Neihu District, Taipei City 11493, Taiwan (R.O.C.)

Issued By: Bureau Veritas Consumer Products Services (H.K.) Ltd., Taoyuan Branch

Lab Address: No. 47-2, 14th Ling, Chia Pau Vil., Lin Kou Dist., New Taipei City, Taiwan

Test Location: No. 19, Hwa Ya 2nd Rd., Wen Hwa Vil., Kwei Shan Dist., Taoyuan City 33383, TAIWAN (R.O.C.)



This report is for your exclusive use. Any copying or replication of this report to or for any other person or entity, or use of our name or trademark, is permitted only with our prior written permission. This report sets forth our findings solely with respect to the test samples identified herein. The results set forth in this report are not indicative or representative of the quality or characteristics of the lot from which a test sample was taken or any similar or identical product unless specifically and expressly noted. Our report includes all of the tests requested by you and the results thereof based upon the information that you provided to us. You have 60 days from date of issuance of this report to notify us of any material error or omission caused by our negligence, provided, however, that such notice shall be in writing and shall specifically address the issue you wish to raise. A failure to raise such issue within the prescribed time shall constitute your unqualified acceptance of the completeness of this report, the tests conducted and the correctness of the report contents. Unless specific mention, the uncertainty of measurement has been explicitly taken into account to declare the compliance or non-compliance to the specification. The report must not be used by the client to claim product certification, approval, or endorsement by TAF or any government agencies.

Table of Contents

Release Control Record	4
1 Certificate of Conformity	5
2 Summary of Test Results	6
2.1 Measurement Uncertainty.....	6
2.2 Modification Record.....	6
3 General Information	7
3.1 General Description of EUT.....	7
3.2 Description of Test Modes.....	8
3.2.1 Test Mode Applicability and Tested Channel Detail.....	10
3.3 Duty Cycle of Test Signal.....	12
3.4 Description of Support Units.....	14
3.4.1 Configuration of System under Test.....	14
3.5 General Description of Applied Standard.....	14
4 Test Types and Results	15
4.1 Radiated Emission and Bandedge Measurement.....	15
4.1.1 Limits of Radiated Emission and Bandedge Measurement.....	15
4.1.2 Test Instruments.....	16
4.1.3 Test Procedure.....	18
4.1.4 Deviation from Test Standard.....	18
4.1.5 Test Setup.....	19
4.1.6 EUT Operating Conditions.....	19
4.1.7 Test Results.....	20
4.2 Conducted Emission Measurement.....	56
4.2.1 Limits of Conducted Emission Measurement.....	56
4.2.2 Test Instruments.....	56
4.2.3 Test Procedure.....	57
4.2.4 Deviation from Test Standard.....	57
4.2.5 Test Setup.....	57
4.2.6 EUT Operating Conditions.....	57
4.2.7 Test Results.....	58
4.3 Transmit Power Measurement.....	64
4.3.1 Limits of Transmit Power Measurement.....	64
4.3.2 Test Setup.....	64
4.3.3 Test Instruments.....	65
4.3.4 Test Procedure.....	65
4.3.5 Deviation from Test Standard.....	65
4.3.6 EUT Operating Conditions.....	65
4.3.7 Test Result.....	66
4.4 Peak Power Spectral Density Measurement.....	72
4.4.1 Limits of Peak Power Spectral Density Measurement.....	72
4.4.2 Test Setup.....	72
4.4.3 Test Instruments.....	72
4.4.4 Test Procedure.....	72
4.4.5 Deviation from Test Standard.....	73
4.4.6 EUT Operating Condition.....	73
4.4.7 Test Results.....	74
4.5 Frequency Stability.....	79
4.5.1 Limits of Frequency Stability Measurement.....	79
4.5.2 Test Setup.....	79
4.5.3 Test Instruments.....	79
4.5.4 Test Procedure.....	79
4.5.5 Deviation from Test Standard.....	79
4.5.6 EUT Operating Condition.....	79



4.5.7 Test Results	80
4.6 6dB Bandwidth Measurement.....	81
4.6.1 Limits of 6dB Bandwidth Measurement.....	81
4.6.2 Test Setup.....	81
4.6.3 Test Instruments	81
4.6.4 Test Procedure	81
4.6.5 Deviation from Test Standard	81
4.6.6 EUT Operating Condition	81
4.6.7 Test Results	82
5 Pictures of Test Arrangements.....	84
Appendix – Information on the Testing Laboratories	85



A D T

Release Control Record

Issue No.	Description	Date Issued
RF130709C02E	Original release.	Apr. 28, 2015

1 Certificate of Conformity

Product: 802.11abgn Mini PCIe module

Brand: SparkLAN

Test Model: WPEA-252NI

Sample Status: Engineering sample

Applicant: SparkLAN Communications, Inc.

Test Date: Jul. 11 ~ Jul. 12, 2013
Apr. 21 ~ Apr. 24, 2015

Standard: 47 CFR FCC Part 15, Subpart E (Section 15.407)
ANSI C63.10:2009

The above equipment has been tested by **Bureau Veritas Consumer Products Services (H.K.) Ltd., Taoyuan Branch**, and found compliance with the requirement of the above standards. The test record, data evaluation & Equipment Under Test (EUT) configurations represented herein are true and accurate accounts of the measurements of the sample's EMC characteristics under the Conditions specified in this report.

Prepared by :  _____, **Date:** _____ Apr. 28, 2015
Pettie Chen / Senior Specialist

Approved by :  _____, **Date:** _____ Apr. 28, 2015
Ken Liu / Senior Manager

2 Summary of Test Results

47 CFR FCC Part 15, Subpart E (SECTION 15.407)			
FCC Clause	Test Item	Result	Remarks
15.407(b)(6)	AC Power Conducted Emissions	PASS	Meet the requirement of limit. Minimum passing margin is -15.22dB at 0.29844MHz.
15.407(b)(1/2/3/4/6)	Radiated Emissions & Band Edge Measurement	PASS	Meet the requirement of limit. Minimum passing margin is -1.5dB at 5350.00 & 5470.00MHz.
15.407(a)(1/2/3)	Max Average Transmit Power	PASS	Meet the requirement of limit.
15.407(a)(1/2/3)	Peak Power Spectral Density	PASS	Meet the requirement of limit.
15.407(e)	6dB bandwidth	PASS	Meet the requirement of limit. (U-NII-3 Band only)
15.407(g)	Frequency Stability	PASS	Meet the requirement of limit.
15.203	Antenna Requirement	PASS	Antenna connector is RP-SMA Plug not a standard connector.

2.1 Measurement Uncertainty

Where relevant, the following measurement uncertainty levels have been estimated for tests performed on the EUT as specified in CISPR 16-4-2:

Measurement	Frequency	Expanded Uncertainty (k=2) (\pm)
Conducted Emissions at mains ports	150kHz ~ 30MHz	2.44 dB
Radiated Emissions up to 1 GHz	30MHz ~ 200MHz	3.34 dB
	200MHz ~ 1000MHz	3.35 dB
For 5180 ~ 5240MHz, 5260 ~ 5320MHz, 5500 ~ 5700MHz Band		
Radiated Emissions above 1 GHz	1GHz ~ 18GHz	2.26 dB
	18GHz ~ 40GHz	1.94 dB
For 5745 ~ 5825MHz Band		
Radiated Emissions above 1 GHz	1GHz ~ 18GHz	2.29 dB
	18GHz ~ 40GHz	2.29 dB

2.2 Modification Record

There were no modifications required for compliance.

3 General Information

3.1 General Description of EUT

Product	802.11abgn Mini PCIe module
Brand	SparkLAN
Test Model	WPEA-252NI
Status of EUT	Engineering sample
Power Supply Rating	3Vdc from host equipment
Modulation Type	64QAM, 16QAM, QPSK, BPSK
Modulation Technology	OFDM
Transfer Rate	802.11a: 54.0/ 48.0/ 36.0/ 24.0/ 18.0/ 12.0/ 9.0/ 6.0Mbps 802.11n: up to 300.0Mbps
Operating Frequency	5180 ~ 5240MHz, 5260 ~ 5320MHz, 5500 ~ 5700MHz & 5745 ~ 5825MHz
Number of Channel	5180 ~ 5240MHz: 4 for 802.11a, 802.11n (HT20) 2 for 802.11n (HT40) 5260 ~ 5320MHz: 4 for 802.11a, 802.11n (HT20) 2 for 802.11n (HT40) 5500 ~ 5700MHz: 11 for 802.11a, 802.11n (HT20) 5 for 802.11n (HT40) 5745 ~ 5825MHz: 5 for 802.11a, 802.11n (HT20) 2 for 802.11n (HT40)
Output Power	5180 ~ 5240MHz: 30.660mW 5260 ~ 5320MHz: 30.876mW 5500 ~ 5700MHz: 30.045mW 5745 ~ 5825MHz: 28.798mW
Antenna Type	Dipole antenna with 5dBi gain
Antenna Connector	RP-SMA Plug
Accessory Device	NA
Data Cable Supplied	NA

Note:

1. This report is issued as a supplementary report to BV ADT report no. RF130709C02-1. The difference compared with original report is updating standard to new rule version, therefore all test items except AC Power Conducted Emissions and the Radiated Emissions (Frequency range below 1GHz) of 5745 ~ 5825MHz were re-tested in this report and the other tests data was kept in this report.
2. The EUT incorporates a MIMO function. Physically, the EUT provides two completed transmitters and two receivers. The EUT has diversity function for 802.11a/b/g. The chain 0 and chain 1 of 802.11a/b/g have been pre-tested, and the chain 0 was the worst for final test.

MODULATION MODE	TX FUNCTION
802.11b	1TX
802.11g	1TX
802.11a	1TX
802.11n (HT20)	2TX
802.11n (HT40)	2TX

3. The EUT uses the following support unit.

PRODUCT	BRAND	MODEL	SPEC.
Dipole Antenna	LTC	GEC6200	2.4G & 5G (dual band)
RF cable	NA	NA	0.15m shielded cable without core

4. The above EUT information is declared by manufacturer and for more detailed features description, please refer to the manufacturer's specifications or user's manual.

3.2 Description of Test Modes

FOR 5180 ~ 5240MHz

4 channels are provided for 802.11a, 802.11n (HT20), 802.11ac (VHT20):

Channel	Frequency	Channel	Frequency
36	5180 MHz	44	5220 MHz
40	5200 MHz	48	5240 MHz

2 channels are provided for 802.11n (HT40), 802.11ac (40MHz):

Channel	Frequency	Channel	Frequency
38	5190 MHz	46	5230 MHz

1 channel is provided for 802.11ac (VHT80):

Channel	Frequency
42	5210MHz

FOR 5260 ~ 5320MHz

4 channels are provided for 802.11a, 802.11n (HT20), 802.11ac (VHT20):

Channel	Frequency	Channel	Frequency
52	5260 MHz	60	5300 MHz
56	5280 MHz	64	5320 MHz

2 channels are provided for 802.11n (HT40), 802.11ac (VHT40):

Channel	Frequency	Channel	Frequency
54	5270 MHz	62	5310 MHz

1 channel is provided for 802.11ac (VHT80):

Channel	Frequency
58	5290MHz

FOR 5500 ~ 5700MHz

11 channels are provided for 802.11a, 802.11n (HT20), 802.11ac (VHT20):

Channel	Frequency	Channel	Frequency
100	5500 MHz	124	5620 MHz
104	5520 MHz	128	5640 MHz
108	5540 MHz	132	5660 MHz
112	5560 MHz	136	5680 MHz
116	5580 MHz	140	5700 MHz
120	5600 MHz		

5 channels are provided for 802.11n (HT40), 802.11ac (VHT40):

Channel	Frequency	Channel	Frequency
102	5510 MHz	126	5630 MHz
110	5550 MHz	134	5670 MHz
118	5590 MHz		

2 channels are provided for 802.11ac (VHT80):

Channel	Frequency	Channel	Frequency
106	5530MHz	122	5610 MHz

FOR 5745 ~ 5825MHz:

5 channels are provided for 802.11a, 802.11n (HT20), 802.11ac (VHT20):

Channel	Frequency	Channel	Frequency
149	5745MHz	161	5805MHz
153	5765MHz	165	5825MHz
157	5785MHz		

2 channels are provided for 802.11n (HT40), 802.11ac (VHT40):

Channel	Frequency	Channel	Frequency
151	5755MHz	159	5795MHz

1 channel is provided for 802.11ac (VHT80):

Channel	Frequency
155	5775MHz

3.2.1 Test Mode Applicability and Tested Channel Detail

EUT CONFIGURE MODE	APPLICABLE TO				DESCRIPTION
	RE≥1G	RE<1G	PLC	APCM	
-	√	√	√	√	-

Where **RE≥1G**: Radiated Emission above 1GHz **RE<1G**: Radiated Emission below 1GHz
PLC: Power Line Conducted Emission **APCM**: Antenna Port Conducted Measurement

NOTE:

1. The EUT had been pre-tested on the positioned of each 3 axis. The worst case was found when positioned on **Z-plane**.

Radiated Emission Test (Above 1GHz):

- Pre-Scan has been conducted to determine the worst-case mode from all possible combinations between available modulations, data rates and antenna ports (if EUT with antenna diversity architecture).
- Following channel(s) was (were) selected for the final test as listed below.

EUT CONFIGURE MODE	MODE	FREQ. BAND (MHz)	AVAILABLE CHANNEL	TESTED CHANNEL	MODULATION TECHNOLOGY	MODULATION TYPE	DATA RATE (Mbps)
-	802.11a	5180-5240	36 to 48	36, 40, 48	OFDM	BPSK	6.0
-	802.11n (HT20)		36 to 48	36, 40, 48	OFDM	BPSK	7.2
-	802.11n (HT40)		38 to 46	38, 46	OFDM	BPSK	15.0
-	802.11a	5260-5320	52 to 64	52, 60, 64	OFDM	BPSK	6.0
-	802.11n (HT20)		52 to 64	52, 60, 64	OFDM	BPSK	7.2
-	802.11n (HT40)		54 to 62	54, 62	OFDM	BPSK	15.0
-	802.11a	5500-5700	100 to 140	100, 116, 140	OFDM	BPSK	6.0
-	802.11n (HT20)		100 to 140	100, 116, 140	OFDM	BPSK	7.2
-	802.11n (HT40)		102 to 134	102, 110, 134	OFDM	BPSK	15.0
-	802.11a	5745-5825	149 to 165	149, 157, 165	OFDM	BPSK	6.0
-	802.11n (HT20)		149 to 165	149, 157, 165	OFDM	BPSK	7.2
-	802.11n (HT40)		151 to 159	151, 159	OFDM	BPSK	15.0

Radiated Emission Test (Below 1GHz):

- Pre-Scan has been conducted to determine the worst-case mode from all possible combinations between available modulations, data rates and antenna ports (if EUT with antenna diversity architecture).
- Following channel(s) was (were) selected for the final test as listed below.

EUT CONFIGURE MODE	MODE	FREQ. BAND (MHz)	AVAILABLE CHANNEL	TESTED CHANNEL	MODULATION TECHNOLOGY	MODULATION TYPE	DATA RATE (Mbps)
-	802.11n (HT20)	5180-5320	36 to 64	60	OFDM	BPSK	7.2
-	802.11n (HT20)	5500-5700	100 to 140	140	OFDM	BPSK	7.2
-	802.11n (HT20)	5745-5825	149 to 165	149	OFDM	BPSK	7.2

Power Line Conducted Emission Test:

- Pre-Scan has been conducted to determine the worst-case mode from all possible combinations between available modulations, data rates and antenna ports (if EUT with antenna diversity architecture).
- Following channel(s) was (were) selected for the final test as listed below.

EUT CONFIGURE MODE	MODE	FREQ. BAND (MHz)	AVAILABLE CHANNEL	TESTED CHANNEL	MODULATION TECHNOLOGY	MODULATION TYPE	DATA RATE (Mbps)
-	802.11n (HT20)	5180-5320	36 to 64	60	OFDM	BPSK	7.2
-	802.11n (HT20)	5500-5700	100 to 140	140	OFDM	BPSK	7.2
-	802.11n (HT20)	5745-5825	149 to 165	149	OFDM	BPSK	7.2

Antenna Port Conducted Measurement:

- This item includes all test value of each mode, but only includes spectrum plot of worst value of each mode.
- Pre-Scan has been conducted to determine the worst-case mode from all possible combinations between available modulations, data rates and antenna ports (if EUT with antenna diversity architecture).
- Following channel(s) was (were) selected for the final test as listed below.

EUT CONFIGURE MODE	MODE	FREQ. BAND (MHz)	AVAILABLE CHANNEL	TESTED CHANNEL	MODULATION TECHNOLOGY	MODULATION TYPE	DATA RATE (Mbps)
-	802.11a	5180-5240	36 to 48	36, 40, 48	OFDM	BPSK	6.0
-	802.11n (HT20)		36 to 48	36, 40, 48	OFDM	BPSK	7.2
-	802.11n (HT40)		38 to 46	38, 46	OFDM	BPSK	15.0
-	802.11a	5260-5320	52 to 64	52, 60, 64	OFDM	BPSK	6.0
-	802.11n (HT20)		52 to 64	52, 60, 64	OFDM	BPSK	7.2
-	802.11n (HT40)		54 to 62	54, 62	OFDM	BPSK	15.0
-	802.11a	5500-5700	100 to 140	100, 116, 140	OFDM	BPSK	6.0
-	802.11n (HT20)		100 to 140	100, 116, 140	OFDM	BPSK	7.2
-	802.11n (HT40)		102 to 134	102, 110, 134	OFDM	BPSK	15.0
-	802.11a	5745-5825	149 to 165	149, 157, 165	OFDM	BPSK	6.0
-	802.11n (HT20)		149 to 165	149, 157, 165	OFDM	BPSK	7.2
-	802.11n (HT40)		151 to 159	151, 159	OFDM	BPSK	15.0

Test Condition:

APPLICABLE TO	ENVIRONMENTAL CONDITIONS	INPUT POWER	TESTED BY
RE \geq 1G	25deg. C, 65%RH	120Vac, 60Hz	Ted Chang
RE $<$ 1G	25deg. C, 65%RH	120Vac, 60Hz	Ted Chang
PLC	22deg. C, 65%RH	120Vac, 60Hz	Brad Tung
APCM	25deg. C, 65%RH	120Vac, 60Hz	Nick Chen

3.3 Duty Cycle of Test Signal

For 5180 ~ 5240MHz, 5260 ~ 5320MHz, 5500 ~ 5700MHz MHz
 Duty cycle of test signal is > 98 %, duty factor is not required.

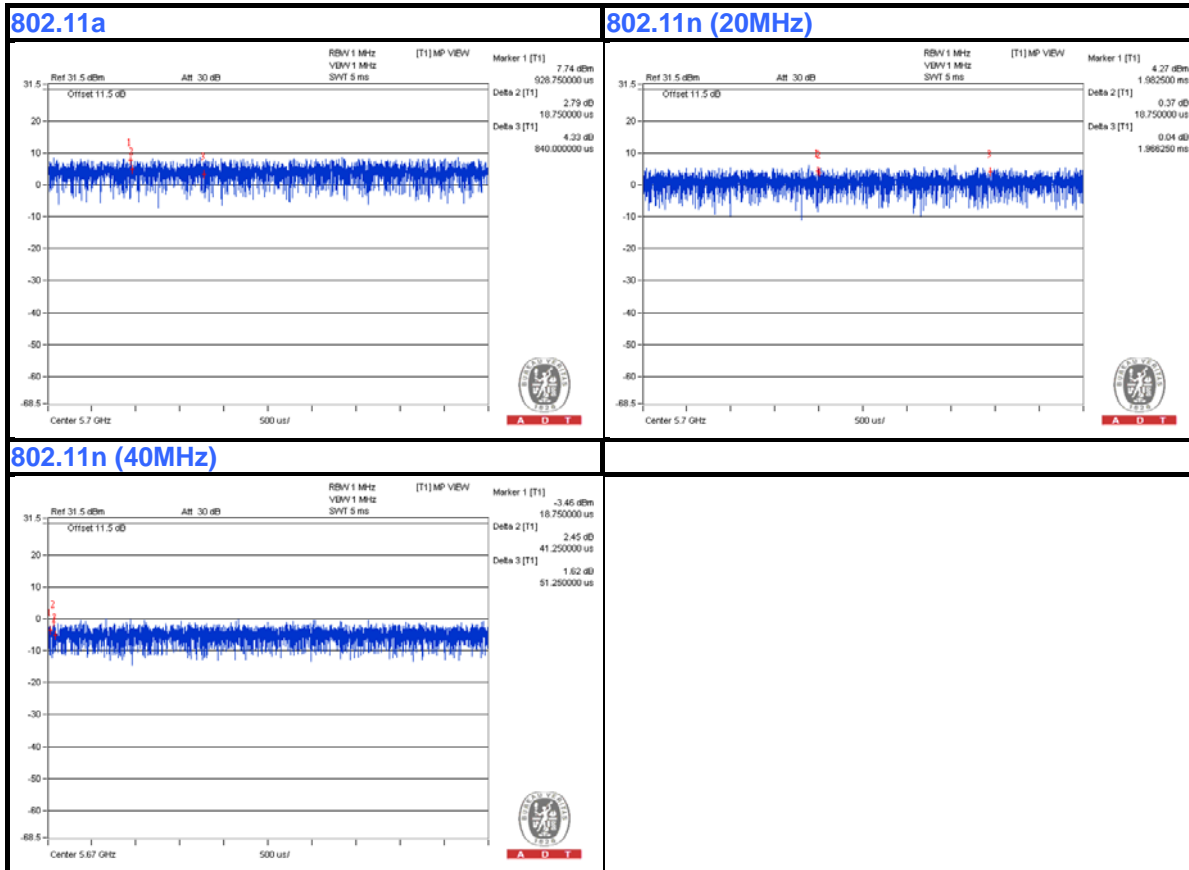

For 5745 ~ 5825MHz

Duty cycle of test signal is < 98 %, duty factor is required

802.11a: Duty cycle = $1.352/1.417 = 0.954$, Duty factor = $10 * \log(1/0.954) = 0.20$

802.11n (HT20): Duty cycle = $1.26/1.325 = 0.951$, Duty factor = $10 * \log(1/0.951) = 0.22$

802.11n (HT40): Duty cycle = $0.619/0.667 = 0.928$, Duty factor = $10 * \log(1/0.928) = 0.32$

802.11a

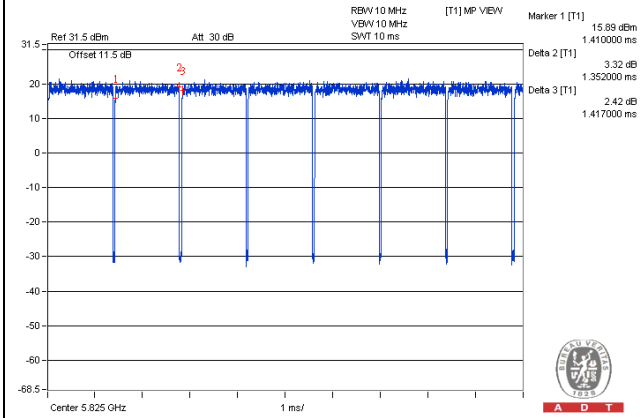

802.11n (HT20)

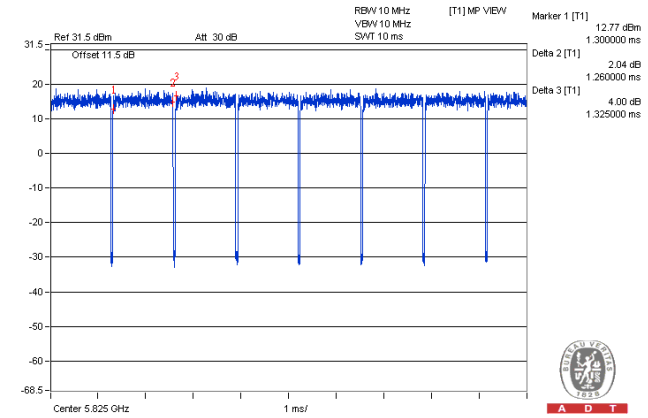

802.11n (HT40)

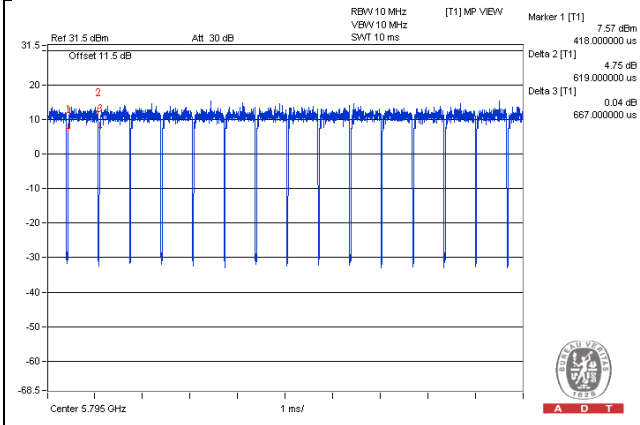

3.4 Description of Support Units

The EUT has been tested as an independent unit together with other necessary accessories or support units. The following support units or accessories were used to form a representative test configuration during the tests.

ID	Product	Brand	Model No.	Serial No.	FCC ID	Remarks
A.	Notebook	DELL	D531	CN-0XM006-48643-81 U-2610	QDS-BRCM1020	-
B.	Convertible Board	NA	NA	NA	NA	-

Note:

1. All power cords of the above support units are non-shielded (1.8m).
2. Item 1 acted as a communication partner to transfer data.
3. Item 2 was provided by the manufacturer.

3.4.1 Configuration of System under Test

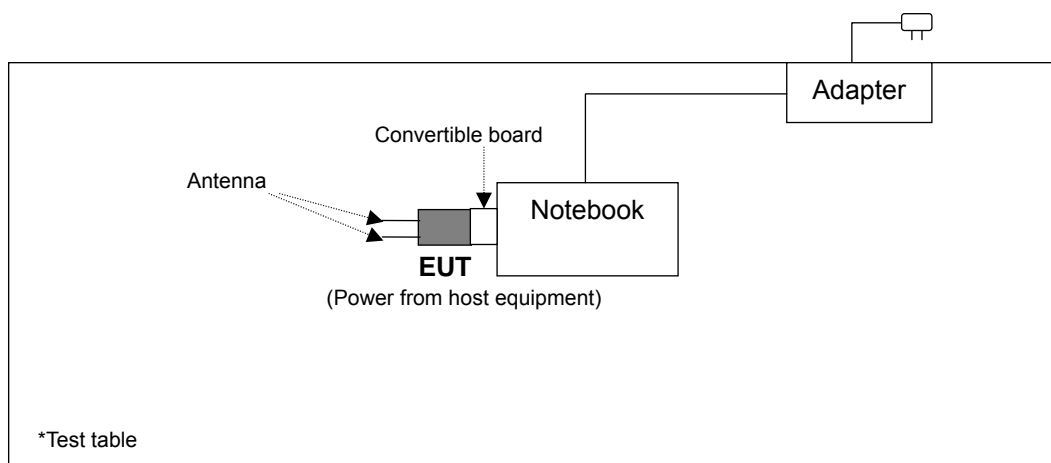

3.5 General Description of Applied Standard

The EUT is a RF Product. According to the specifications of the manufacturer, it must comply with the requirements of the following standards:

- FCC Part 15, Subpart E (15.407)**
- 789033 D02 General UNII Test Procedure New Rules v01**
- 662911 D01 Multiple Transmitter Output v02r01**
- ANSI C63.10-2009

All test items have been performed and recorded as per the above standards.

NOTE: The EUT is also considered as a kind of computer peripheral, because the connection to computer is necessary for typical use. It has been verified to comply with the requirements of FCC Part 15, Subpart B, Class B (DoC). The test report has been issued separately.

4 Test Types and Results

4.1 Radiated Emission and Bandedge Measurement

4.1.1 Limits of Radiated Emission and Bandedge Measurement

Radiated emissions which fall in the restricted bands must comply with the radiated emission limits specified as below table.

Frequencies (MHz)	Field Strength (microvolts/meter)	Measurement Distance (meters)
0.009 ~ 0.490	2400/F(kHz)	300
0.490 ~ 1.705	24000/F(kHz)	30
1.705 ~ 30.0	30	30
30 ~ 88	100	3
88 ~ 216	150	3
216 ~ 960	200	3
Above 960	500	3

NOTE:

1. The lower limit shall apply at the transition frequencies.
2. Emission level (dBuV/m) = 20 log Emission level (uV/m).
3. For frequencies above 1000MHz, the field strength limits are based on average detector, however, the peak field strength of any emission shall not exceed the maximum permitted average limits, specified above by more than 20dB under any Condition of modulation.

LIMITS OF UNWANTED EMISSION OUT OF THE RESTRICTED BANDS

APPLICABLE TO	LIMIT	
789033 D02 General UNII Test Procedure New Rules v01	FIELD STRENGTH AT 3m	
	PK:74 (dBuV/m)	AV:54 (dBuV/m)
APPLICABLE TO	EIRP LIMIT	EQUIVALENT FIELD STRENGTH AT 3m
15.407(b)(1)	PK:-27 (dBm/MHz)	PK:68.2(dBuV/m)
15.407(b)(2)		
15.407(b)(3)		
15.407(b)(4)	PK:-27 (dBm/MHz) ^{*1} PK:-17 (dBm/MHz) ^{*2}	PK: 68.2(dBuV/m) ^{*1} PK:78.2 (dBuV/m) ^{*2}

NOTE: ^{*1} beyond 10MHz of the band edge ^{*2} within 10 MHz of band edge

The following formula is used to convert the equipment isotropic radiated power (eirp) to field strength:

$$E = \frac{1000000\sqrt{30P}}{3} \mu\text{V/m, where P is the eirp (Watts).}$$

4.1.2 Test Instruments

For Tested Date: Jul. 11 ~ Jul. 12, 2013

DESCRIPTION & MANUFACTURER	MODEL NO.	SERIAL NO.	DATE OF CALIBRATION	DUE DATE OF CALIBRATION
Test Receiver ROHDE & SCHWARZ	ESIB7	100212	Aug. 06, 2012	Aug. 05, 2013
Spectrum Analyzer ROHDE & SCHWARZ	FSP40	100039	Jan. 31, 2013	Jan. 30, 2014
BILOG Antenna SCHWARZBECK	VULB9168	9168-160	Mar. 20, 2013	Mar. 19, 2014
HORN Antenna SCHWARZBECK	9120D	209	Sep. 03, 2012	Sep. 02, 2013
HORN Antenna SCHWARZBECK	BBHA 9120D	9120D-404	Dec. 22, 2012	Dec. 21, 2013
Preamplifier Agilent	8447D	2944A10633	Oct. 25, 2012	Oct. 24, 2013
Preamplifier Agilent	8449B	3008A01964	Oct. 25, 2012	Oct. 24, 2013
RF signal cable HUBER+SUHNNER	SUCOFLEX 104	250723/4	Aug. 28, 2012	Aug. 27, 2013
RF signal cable HUBER+SUHNNER	SUCOFLEX 106	12738/6+309224/ 4	Aug. 28, 2012	Aug. 27, 2013
Software BV ADT	ADT_Radiated_ V7.6.15.9.4	NA	NA	NA
Antenna Tower inn-co GmbH	MA 4000	013303	NA	NA
Antenna Tower Controller inn-co GmbH	CO2000	017303	NA	NA
Turn Table BV ADT	TT100	TT93021703	NA	NA
Turn Table Controller BV ADT	SC100	SC93021703	NA	NA
26GHz ~ 40GHz Amplifier	EM26400	815221	Oct. 25, 2012	Oct. 24, 2013
High Speed Peak Power Meter	ML2495A	0824012	Aug. 22, 2012	Aug. 21, 2013
Power Sensor	MA2411B	0738171	Jul. 30, 2012	Jul. 29, 2013
WIT Standard Temperature And Humidity Chamber	TH-4S-C	W981030	Jun. 10, 2013	Jun. 09, 2014

- NOTE:** 1. The calibration interval of the above test instruments is 12 months and the calibrations are traceable to NML/ROC and NIST/USA.
2. The test was performed in HwaYa Chamber 3.
3. The horn antenna and HP preamplifier (model: 8449B) are used only for the measurement of emission frequency above 1GHz if tested.
4. The FCC Site Registration No. is 988962.
5. The IC Site Registration No. is IC 7450F-3.



For Tested Date: Apr. 21 ~ Apr. 24, 2015

DESCRIPTION & MANUFACTURER	MODEL NO.	SERIAL NO.	DATE OF CALIBRATION	DUE DATE OF CALIBRATION
Test Receiver ROHDE & SCHWARZ	ESCI	100424	Oct. 06, 2014	Oct. 05, 2015
Spectrum Analyzer ROHDE & SCHWARZ	FSP40	100040	Jul. 25, 2014	Jul. 24, 2015
BILOG Antenna SCHWARZBECK	VULB9168	9168-155	Feb. 06, 2015	Feb. 05, 2016
HORN Antenna SCHWARZBECK	BBHA 9120D	9120D-1170	Feb. 05, 2015	Feb. 04, 2016
HORN Antenna SCHWARZBECK	BBHA 9170	BBHA9170241	Feb. 09, 2015	Feb. 08, 2016
Preamplifier Agilent	8449B	3008A01960	Aug. 09, 2014	Aug. 08, 2015
Preamplifier Agilent	8447D	2944A10631	Aug. 09, 2014	Aug. 08, 2015
RF signal cable HUBER+SUHNNER	SUCOFLEX 104	309220/4	Aug. 09, 2014	Aug. 08, 2015
RF signal cable HUBER+SUHNNER	SUCOFLEX 104	250724/4	Aug. 09, 2014	Aug. 08, 2015
RF signal cable HUBER+SUHNNER	SUCOFLEX 104	295012/4	Aug. 09, 2014	Aug. 08, 2015
Software BV ADT	ADT_Radiated_ V7.6.15.9.4	NA	NA	NA
Antenna Tower inn-co GmbH	MA 4000	010303	NA	NA
Antenna Tower Controller BV ADT	AT100	AT93021703	NA	NA
Turn Table BV ADT	TT100.	TT93021703	NA	NA
Turn Table Controller BV ADT	SC100.	SC93021703	NA	NA
26GHz ~ 40GHz Amplifier	EM26400	815221	Oct. 18, 2014	Oct. 17, 2015
High Speed Peak Power Meter	ML2495A	0824011	Jul. 26, 2014	Jul. 25, 2015
Power Sensor	MA2411B	0738171	Jul. 26, 2014	Jul. 25, 2015
WIT Standard Temperature And Humidity Chamber	TH-4S-C	W981030	Jun. 09, 2014	Jun. 08, 2015

- NOTE:**
1. The calibration interval of the above test instruments is 12 months and the calibrations are traceable to NML/ROC and NIST/USA.
 2. The test was performed in HwaYa Chamber 4.
 4. The horn antenna and HP preamplifier (model: 8449B) are used only for the measurement of emission frequency above 1GHz if tested.
 5. The FCC Site Registration No. is 460141.
 6. The IC Site Registration No. is IC7450F-4.

4.1.3 Test Procedure

- a. The EUT was placed on the top of a rotating table 0.8 meters above the ground at 3 meter chamber room for test. The table was rotated 360 degrees to determine the position of the highest radiation.
- b. The EUT was set 3 meters away from the interference-receiving antenna, which was mounted on the top of a variable-height antenna tower.
- c. The height of antenna is varied from one meter to four meters above the ground to determine the maximum value of the field strength. Both horizontal and vertical polarizations of the antenna are set to make the measurement.
- d. For each suspected emission, the EUT was arranged to its worst case and then the antenna was tuned to heights from 1 meter to 4 meters and the rotatable table was turned from 0 degrees to 360 degrees to find the maximum reading.
- e. The test-receiver system was set to quasi-peak detect function and specified bandwidth with maximum hold mode when the test frequency is below 1 GHz.
- f. The test-receiver system was set to peak and average detect function and specified bandwidth with maximum hold mode when the test frequency is above 1 GHz. If the peak reading value also meets average limit, measurement with the average detector is unnecessary.

Note:

1. The resolution bandwidth and video bandwidth of test receiver/spectrum analyzer is 120kHz for Quasi-peak detection (QP) at frequency below 1GHz.
2. The resolution bandwidth of test receiver/spectrum analyzer is 1 MHz and the video bandwidth is 3 MHz for Peak detection (PK) at frequency above 1GHz.
3. The resolution bandwidth of test receiver/spectrum analyzer is 1MHz and the video bandwidth is 3MHz for RMS Average (Duty cycle < 98%) for Average detection (AV) at frequency above 1GHz, then the measurement results was added to a correction factor ($10 \log(1/\text{duty cycle})$).
4. The resolution bandwidth of test receiver/spectrum analyzer is 1MHz and the video bandwidth is 10Hz (Duty cycle $\geq 98\%$) for Average detection (AV) at frequency above 1GHz.
5. All modes of operation were investigated and the worst-case emissions are reported.

4.1.4 Deviation from Test Standard

No deviation.

4.1.5 Test Setup

<Frequency Range below 1GHz>

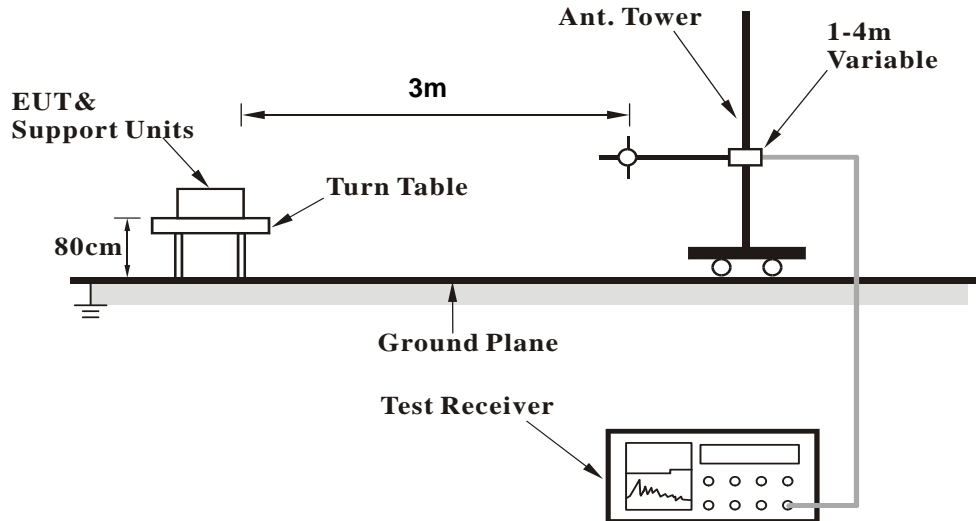

<Frequency Range above 1GHz>

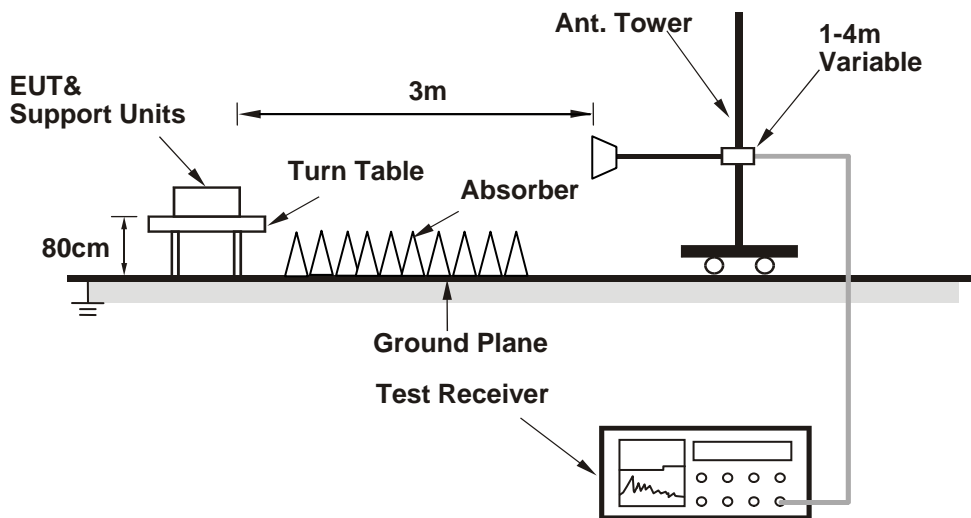

For the actual test configuration, please refer to the attached file (Test Setup Photo).

4.1.6 EUT Operating Conditions

- Plugged the EUT into a notebook through a convertible board and placed on a test table.
- The notebook ran a test program (provided by manufacturer) to enable EUT under transmission condition continuously at specific channel frequency.

4.1.7 Test Results
ABOVE 1GHz DATA :
802.11a

EUT TEST CONDITION		MEASUREMENT DETAIL	
CHANNEL	Channel 36	FREQUENCY RANGE	1 ~ 40GHz
INPUT POWER (SYSTEM)	120Vac, 60 Hz	DETECTOR FUNCTION	Peak (PK) Average (AV)
ENVIRONMENTAL CONDITIONS	24deg. C, 65%RH	TESTED BY	Ted Chang

ANTENNA POLARITY & TEST DISTANCE: HORIZONTAL AT 3 M

NO.	FREQ. (MHz)	EMISSION LEVEL (dBuV/m)	LIMIT (dBuV/m)	MARGIN (dB)	ANTENNA HEIGHT (m)	TABLE ANGLE (Degree)	RAW VALUE (dBuV)	CORRECTION FACTOR (dB/m)
1	5150.00	59.0 PK	74.0	-15.0	1.27 H	190	55.20	3.80
2	5150.00	43.2 AV	54.0	-10.8	1.27 H	190	39.40	3.80
3	*5180.00	99.6 PK			1.21 H	192	61.80	37.80
4	*5180.00	89.0 AV			1.21 H	192	51.20	37.80
5	#10360.00	56.6 PK	74.0	-17.4	1.00 H	200	42.10	14.50
6	#10360.00	42.6 AV	54.0	-11.4	1.00 H	200	28.10	14.50

ANTENNA POLARITY & TEST DISTANCE: VERTICAL AT 3 M

NO.	FREQ. (MHz)	EMISSION LEVEL (dBuV/m)	LIMIT (dBuV/m)	MARGIN (dB)	ANTENNA HEIGHT (m)	TABLE ANGLE (Degree)	RAW VALUE (dBuV)	CORRECTION FACTOR (dB/m)
1	5150.00	60.0 PK	74.0	-14.0	1.00 V	25	56.20	3.80
2	5150.00	44.8 AV	54.0	-9.2	1.00 V	25	41.00	3.80
3	*5180.00	110.9 PK			1.00 V	27	73.10	37.80
4	*5180.00	100.3 AV			1.00 V	27	62.50	37.80
5	#10360.00	57.9 PK	74.0	-16.1	1.00 V	50	43.40	14.50
6	#10360.00	44.2 AV	54.0	-9.8	1.00 V	50	29.70	14.50

REMARKS:

1. Emission Level(dBuV/m) = Raw Value(dBuV) + Correction Factor(dB/m)
2. Correction Factor(dB/m) = Antenna Factor(dB/m) + Cable Factor(dB)
3. The other emission levels were very low against the limit.
4. Margin value = Emission Level – Limit value
5. " * ": Fundamental frequency.
6. " # ": The radiated frequency is out of the restricted band.

EUT TEST CONDITION		MEASUREMENT DETAIL	
CHANNEL	Channel 40	FREQUENCY RANGE	1 ~ 40GHz
INPUT POWER (SYSTEM)	120Vac, 60 Hz	DETECTOR FUNCTION	Peak (PK) Average (AV)
ENVIRONMENTAL CONDITIONS	24deg. C, 65%RH	TESTED BY	Ted Chang

ANTENNA POLARITY & TEST DISTANCE: HORIZONTAL AT 3 M								
NO.	FREQ. (MHz)	EMISSION LEVEL (dBuV/m)	LIMIT (dBuV/m)	MARGIN (dB)	ANTENNA HEIGHT (m)	TABLE ANGLE (Degree)	RAW VALUE (dBuV)	CORRECTION FACTOR (dB/m)
1	*5200.00	99.0 PK			1.19 H	190	61.20	37.80
2	*5200.00	88.8 AV			1.19 H	190	51.00	37.80
3	#10400.00	57.0 PK	74.0	-17.0	1.00 H	205	42.30	14.70
4	#10400.00	43.2 AV	54.0	-10.8	1.00 H	205	28.50	14.70
ANTENNA POLARITY & TEST DISTANCE: VERTICAL AT 3 M								
NO.	FREQ. (MHz)	EMISSION LEVEL (dBuV/m)	LIMIT (dBuV/m)	MARGIN (dB)	ANTENNA HEIGHT (m)	TABLE ANGLE (Degree)	RAW VALUE (dBuV)	CORRECTION FACTOR (dB/m)
1	*5200.00	110.9 PK			1.00 V	30	73.10	37.80
2	*5200.00	100.2 AV			1.00 V	30	62.40	37.80
3	#10400.00	58.2 PK	74.0	-15.8	1.00 V	58	43.50	14.70
4	#10400.00	44.8 AV	54.0	-9.2	1.00 V	58	30.10	14.70

REMARKS:

1. Emission Level(dBuV/m) = Raw Value(dBuV) + Correction Factor(dB/m)
2. Correction Factor(dB/m) = Antenna Factor(dB/m) + Cable Factor(dB)
3. The other emission levels were very low against the limit.
4. Margin value = Emission Level – Limit value
5. " * ": Fundamental frequency.
6. " # ": The radiated frequency is out of the restricted band.

EUT TEST CONDITION		MEASUREMENT DETAIL	
CHANNEL	Channel 48	FREQUENCY RANGE	1 ~ 40GHz
INPUT POWER (SYSTEM)	120Vac, 60 Hz	DETECTOR FUNCTION	Peak (PK) Average (AV)
ENVIRONMENTAL CONDITIONS	24deg. C, 65%RH	TESTED BY	Ted Chang

ANTENNA POLARITY & TEST DISTANCE: HORIZONTAL AT 3 M								
NO.	FREQ. (MHz)	EMISSION LEVEL (dBuV/m)	LIMIT (dBuV/m)	MARGIN (dB)	ANTENNA HEIGHT (m)	TABLE ANGLE (Degree)	RAW VALUE (dBuV)	CORRECTION FACTOR (dB/m)
1	*5240.00	100.0 PK			1.40 H	219	62.20	37.80
2	*5240.00	89.1 AV			1.40 H	219	51.30	37.80
3	5350.00	58.4 PK	74.0	-15.6	1.38 H	217	54.10	4.30
4	5350.00	42.8 AV	54.0	-11.2	1.38 H	217	38.50	4.30
5	#10480.00	56.6 PK	74.0	-17.4	1.00 H	201	41.60	15.00
6	#10480.00	42.8 AV	54.0	-11.2	1.00 H	201	27.80	15.00

ANTENNA POLARITY & TEST DISTANCE: VERTICAL AT 3 M								
NO.	FREQ. (MHz)	EMISSION LEVEL (dBuV/m)	LIMIT (dBuV/m)	MARGIN (dB)	ANTENNA HEIGHT (m)	TABLE ANGLE (Degree)	RAW VALUE (dBuV)	CORRECTION FACTOR (dB/m)
1	*5240.00	111.2 PK			1.00 V	148	73.40	37.80
2	*5240.00	100.5 AV			1.00 V	148	62.70	37.80
3	5350.00	59.5 PK	74.0	-14.5	1.00 V	143	55.20	4.30
4	5350.00	43.5 AV	54.0	-10.5	1.00 V	143	39.20	4.30
5	#10480.00	58.1 PK	74.0	-15.9	1.00 V	56	43.10	15.00
6	#10480.00	44.0 AV	54.0	-10.0	1.00 V	56	29.00	15.00

REMARKS:

1. Emission Level(dBuV/m) = Raw Value(dBuV) + Correction Factor(dB/m)
2. Correction Factor(dB/m) = Antenna Factor(dB/m) + Cable Factor(dB)
3. The other emission levels were very low against the limit.
4. Margin value = Emission Level – Limit value
5. " * ": Fundamental frequency.
6. " # ": The radiated frequency is out of the restricted band.

EUT TEST CONDITION		MEASUREMENT DETAIL	
CHANNEL	Channel 52	FREQUENCY RANGE	1 ~ 40GHz
INPUT POWER (SYSTEM)	120Vac, 60 Hz	DETECTOR FUNCTION	Peak (PK) Average (AV)
ENVIRONMENTAL CONDITIONS	25deg. C, 71%RH	TESTED BY	Ted Chang

ANTENNA POLARITY & TEST DISTANCE: HORIZONTAL AT 3 M								
NO.	FREQ. (MHz)	EMISSION LEVEL (dBuV/m)	LIMIT (dBuV/m)	MARGIN (dB)	ANTENNA HEIGHT (m)	TABLE ANGLE (Degree)	RAW VALUE (dBuV)	CORRECTION FACTOR (dB/m)
1	5150.00	58.3 PK	74.0	-15.7	1.26 H	219	54.50	3.80
2	5150.00	42.2 AV	54.0	-11.8	1.26 H	219	38.40	3.80
3	*5260.00	100.5 PK			1.24 H	211	62.60	37.90
4	*5260.00	89.6 AV			1.24 H	211	51.70	37.90
5	#10520.00	57.1 PK	74.0	-16.9	1.00 H	205	42.10	15.00
6	#10520.00	42.9 AV	54.0	-11.1	1.00 H	205	27.90	15.00

ANTENNA POLARITY & TEST DISTANCE: VERTICAL AT 3 M								
NO.	FREQ. (MHz)	EMISSION LEVEL (dBuV/m)	LIMIT (dBuV/m)	MARGIN (dB)	ANTENNA HEIGHT (m)	TABLE ANGLE (Degree)	RAW VALUE (dBuV)	CORRECTION FACTOR (dB/m)
1	5150.00	59.4 PK	74.0	-14.6	1.00 V	172	55.60	3.80
2	5150.00	43.9 AV	54.0	-10.1	1.00 V	172	40.10	3.80
3	*5260.00	111.7 PK			1.00 V	176	73.80	37.90
4	*5260.00	100.8 AV			1.00 V	176	62.90	37.90
5	#10520.00	58.3 PK	74.0	-15.7	1.00 V	52	43.30	15.00
6	#10520.00	44.5 AV	54.0	-9.5	1.00 V	52	29.50	15.00

REMARKS:

1. Emission Level(dBuV/m) = Raw Value(dBuV) + Correction Factor(dB/m)
2. Correction Factor(dB/m) = Antenna Factor(dB/m) + Cable Factor(dB)
3. The other emission levels were very low against the limit.
4. Margin value = Emission Level – Limit value
5. " * ": Fundamental frequency.
6. " # ": The radiated frequency is out of the restricted band.

EUT TEST CONDITION		MEASUREMENT DETAIL	
CHANNEL	Channel 60	FREQUENCY RANGE	1 ~ 40GHz
INPUT POWER (SYSTEM)	120Vac, 60 Hz	DETECTOR FUNCTION	Peak (PK) Average (AV)
ENVIRONMENTAL CONDITIONS	24deg. C, 65%RH	TESTED BY	Ted Chang

ANTENNA POLARITY & TEST DISTANCE: HORIZONTAL AT 3 M								
NO.	FREQ. (MHz)	EMISSION LEVEL (dBuV/m)	LIMIT (dBuV/m)	MARGIN (dB)	ANTENNA HEIGHT (m)	TABLE ANGLE (Degree)	RAW VALUE (dBuV)	CORRECTION FACTOR (dB/m)
1	*5300.00	101.0 PK			1.00 H	218	63.10	37.90
2	*5300.00	89.6 AV			1.00 H	218	51.70	37.90
3	10600.00	57.7 PK	74.0	-16.3	1.00 H	208	42.50	15.20
4	10600.00	43.5 AV	54.0	-10.5	1.00 H	208	28.30	15.20
ANTENNA POLARITY & TEST DISTANCE: VERTICAL AT 3 M								
NO.	FREQ. (MHz)	EMISSION LEVEL (dBuV/m)	LIMIT (dBuV/m)	MARGIN (dB)	ANTENNA HEIGHT (m)	TABLE ANGLE (Degree)	RAW VALUE (dBuV)	CORRECTION FACTOR (dB/m)
1	*5300.00	111.7 PK			1.00 V	146	73.80	37.90
2	*5300.00	101.0 AV			1.00 V	146	63.10	37.90
3	10600.00	58.9 PK	74.0	-15.1	1.00 V	50	43.70	15.20
4	10600.00	45.0 AV	54.0	-9.0	1.00 V	50	29.80	15.20

REMARKS:

1. Emission Level(dBuV/m) = Raw Value(dBuV) + Correction Factor(dB/m)
2. Correction Factor(dB/m) = Antenna Factor(dB/m) + Cable Factor(dB)
3. The other emission levels were very low against the limit.
4. Margin value = Emission Level – Limit value
5. " * ": Fundamental frequency.

EUT TEST CONDITION		MEASUREMENT DETAIL	
CHANNEL	Channel 64	FREQUENCY RANGE	1 ~ 40GHz
INPUT POWER (SYSTEM)	120Vac, 60 Hz	DETECTOR FUNCTION	Peak (PK) Average (AV)
ENVIRONMENTAL CONDITIONS	25deg. C, 71%RH	TESTED BY	Ted Chang

ANTENNA POLARITY & TEST DISTANCE: HORIZONTAL AT 3 M								
NO.	FREQ. (MHz)	EMISSION LEVEL (dBuV/m)	LIMIT (dBuV/m)	MARGIN (dB)	ANTENNA HEIGHT (m)	TABLE ANGLE (Degree)	RAW VALUE (dBuV)	CORRECTION FACTOR (dB/m)
1	*5320.00	101.3 PK			1.00 H	211	63.30	38.00
2	*5320.00	90.6 AV			1.00 H	211	52.60	38.00
3	5350.00	60.4 PK	74.0	-13.6	1.00 H	210	56.10	4.30
4	5350.00	44.5 AV	54.0	-9.5	1.00 H	210	40.20	4.30
5	10640.00	57.2 PK	74.0	-16.8	1.00 H	200	41.90	15.30
6	10640.00	43.2 AV	54.0	-10.8	1.00 H	200	27.90	15.30

ANTENNA POLARITY & TEST DISTANCE: VERTICAL AT 3 M								
NO.	FREQ. (MHz)	EMISSION LEVEL (dBuV/m)	LIMIT (dBuV/m)	MARGIN (dB)	ANTENNA HEIGHT (m)	TABLE ANGLE (Degree)	RAW VALUE (dBuV)	CORRECTION FACTOR (dB/m)
1	*5320.00	110.9 PK			1.00 V	150	72.90	38.00
2	*5320.00	100.8 AV			1.00 V	150	62.80	38.00
3	5350.00	62.2 PK	74.0	-11.8	1.00 V	151	57.90	4.30
4	5350.00	46.0 AV	54.0	-8.0	1.00 V	151	41.70	4.30
5	10640.00	58.4 PK	74.0	-15.6	1.00 V	51	43.10	15.30
6	10640.00	44.8 AV	54.0	-9.2	1.00 V	51	29.50	15.30

REMARKS:

1. Emission Level(dBuV/m) = Raw Value(dBuV) + Correction Factor(dB/m)
2. Correction Factor(dB/m) = Antenna Factor(dB/m) + Cable Factor(dB)
3. The other emission levels were very low against the limit.
4. Margin value = Emission Level – Limit value
5. " * ": Fundamental frequency.

EUT TEST CONDITION		MEASUREMENT DETAIL	
CHANNEL	Channel 100	FREQUENCY RANGE	1 ~ 40GHz
INPUT POWER (SYSTEM)	120Vac, 60 Hz	DETECTOR FUNCTION	Peak (PK) Average (AV)
ENVIRONMENTAL CONDITIONS	25deg. C, 71%RH	TESTED BY	Ted Chang

ANTENNA POLARITY & TEST DISTANCE: HORIZONTAL AT 3 M								
NO.	FREQ. (MHz)	EMISSION LEVEL (dBuV/m)	LIMIT (dBuV/m)	MARGIN (dB)	ANTENNA HEIGHT (m)	TABLE ANGLE (Degree)	RAW VALUE (dBuV)	CORRECTION FACTOR (dB/m)
1	5460.00	57.5 PK	74.0	-16.5	1.02 H	176	53.00	4.50
2	5460.00	43.9 AV	54.0	-10.1	1.02 H	176	39.40	4.50
3	#5470.00	60.5 PK	74.0	-13.5	1.02 H	176	56.10	4.40
4	#5470.00	46.5 AV	54.0	-7.5	1.02 H	176	42.10	4.40
5	*5500.00	100.3 PK			1.02 H	178	62.00	38.30
6	*5500.00	89.1 AV			1.02 H	178	50.80	38.30
7	11000.00	57.6 PK	74.0	-16.4	1.00 H	208	41.60	16.00
8	11000.00	42.5 AV	54.0	-11.5	1.00 H	208	26.50	16.00
ANTENNA POLARITY & TEST DISTANCE: VERTICAL AT 3 M								
NO.	FREQ. (MHz)	EMISSION LEVEL (dBuV/m)	LIMIT (dBuV/m)	MARGIN (dB)	ANTENNA HEIGHT (m)	TABLE ANGLE (Degree)	RAW VALUE (dBuV)	CORRECTION FACTOR (dB/m)
1	5460.00	58.7 PK	74.0	-15.3	1.08 V	138	54.20	4.50
2	5460.00	45.4 AV	54.0	-8.6	1.08 V	138	40.90	4.50
3	#5470.00	61.4 PK	74.0	-12.6	1.08 V	138	57.00	4.40
4	#5470.00	47.0 AV	54.0	-7.0	1.08 V	138	42.60	4.40
5	*5500.00	111.8 PK			1.06 V	138	73.50	38.30
6	*5500.00	100.8 AV			1.06 V	138	62.50	38.30
7	11000.00	58.8 PK	74.0	-15.2	1.00 V	210	42.80	16.00
8	11000.00	44.1 AV	54.0	-9.9	1.00 V	210	28.10	16.00

REMARKS:

1. Emission Level(dBuV/m) = Raw Value(dBuV) + Correction Factor(dB/m)
2. Correction Factor(dB/m) = Antenna Factor(dB/m) + Cable Factor(dB)
3. The other emission levels were very low against the limit.
4. Margin value = Emission Level – Limit value
5. " * ": Fundamental frequency.
6. " # ": The radiated frequency is out of the restricted band.

EUT TEST CONDITION		MEASUREMENT DETAIL	
CHANNEL	Channel 116	FREQUENCY RANGE	1 ~ 40GHz
INPUT POWER (SYSTEM)	120Vac, 60 Hz	DETECTOR FUNCTION	Peak (PK) Average (AV)
ENVIRONMENTAL CONDITIONS	25deg. C, 71%RH	TESTED BY	Ted Chang

ANTENNA POLARITY & TEST DISTANCE: HORIZONTAL AT 3 M								
NO.	FREQ. (MHz)	EMISSION LEVEL (dBuV/m)	LIMIT (dBuV/m)	MARGIN (dB)	ANTENNA HEIGHT (m)	TABLE ANGLE (Degree)	RAW VALUE (dBuV)	CORRECTION FACTOR (dB/m)
1	*5580.00	100.8 PK			1.00 H	197	62.40	38.40
2	*5580.00	89.6 AV			1.00 H	197	51.20	38.40
3	11160.00	58.2 PK	74.0	-15.8	1.00 H	201	42.20	16.00
4	11160.00	43.1 AV	54.0	-10.9	1.00 H	201	27.10	16.00

ANTENNA POLARITY & TEST DISTANCE: VERTICAL AT 3 M								
NO.	FREQ. (MHz)	EMISSION LEVEL (dBuV/m)	LIMIT (dBuV/m)	MARGIN (dB)	ANTENNA HEIGHT (m)	TABLE ANGLE (Degree)	RAW VALUE (dBuV)	CORRECTION FACTOR (dB/m)
1	*5580.00	111.8 PK			1.12 V	177	73.40	38.40
2	*5580.00	100.8 AV			1.12 V	177	62.40	38.40
3	11160.00	59.3 PK	74.0	-14.7	1.00 V	214	43.30	16.00
4	11160.00	44.7 AV	54.0	-9.3	1.00 V	214	28.70	16.00

REMARKS:

1. Emission Level(dBuV/m) = Raw Value(dBuV) + Correction Factor(dB/m)
2. Correction Factor(dB/m) = Antenna Factor(dB/m) + Cable Factor(dB)
3. The other emission levels were very low against the limit.
4. Margin value = Emission Level – Limit value
5. " * ": Fundamental frequency.

EUT TEST CONDITION		MEASUREMENT DETAIL	
CHANNEL	Channel 140	FREQUENCY RANGE	1 ~ 40GHz
INPUT POWER (SYSTEM)	120Vac, 60 Hz	DETECTOR FUNCTION	Peak (PK) Average (AV)
ENVIRONMENTAL CONDITIONS	25deg. C, 65%RH	TESTED BY	Ted Chang

ANTENNA POLARITY & TEST DISTANCE: HORIZONTAL AT 3 M

NO.	FREQ. (MHz)	EMISSION LEVEL (dBuV/m)	LIMIT (dBuV/m)	MARGIN (dB)	ANTENNA HEIGHT (m)	TABLE ANGLE (Degree)	RAW VALUE (dBuV)	CORRECTION FACTOR (dB/m)
1	*5700.00	102.9 PK			1.13 H	196	64.30	38.60
2	*5700.00	91.6 AV			1.13 H	196	53.00	38.60
3	#5725.00	57.0 PK	74.0	-17.0	1.10 H	186	52.20	4.80
4	#5725.00	46.0 AV	54.0	-8.0	1.10 H	186	41.20	4.80
5	11400.00	61.8 PK	74.0	-12.2	1.54 H	118	45.90	15.90
6	11400.00	46.7 AV	54.0	-7.3	1.54 H	118	30.80	15.90

ANTENNA POLARITY & TEST DISTANCE: VERTICAL AT 3 M

NO.	FREQ. (MHz)	EMISSION LEVEL (dBuV/m)	LIMIT (dBuV/m)	MARGIN (dB)	ANTENNA HEIGHT (m)	TABLE ANGLE (Degree)	RAW VALUE (dBuV)	CORRECTION FACTOR (dB/m)
1	*5700.00	110.9 PK			1.00 V	181	72.30	38.60
2	*5700.00	100.1 AV			1.00 V	181	61.50	38.60
3	#5725.00	64.8 PK	74.0	-9.2	1.00 V	181	60.00	4.80
4	#5725.00	50.0 AV	54.0	-4.0	1.00 V	181	45.20	4.80
5	11400.00	62.9 PK	74.0	-11.1	1.54 V	187	47.00	15.90
6	11400.00	48.7 AV	54.0	-5.3	1.54 V	187	32.80	15.90

REMARKS:

1. Emission Level(dBuV/m) = Raw Value(dBuV) + Correction Factor(dB/m)
2. Correction Factor(dB/m) = Antenna Factor(dB/m) + Cable Factor(dB)
3. The other emission levels were very low against the limit.
4. Margin value = Emission Level – Limit value
5. " * ": Fundamental frequency.
6. " # ": The radiated frequency is out of the restricted band.

EUT TEST CONDITION		MEASUREMENT DETAIL	
CHANNEL	Channel 149	FREQUENCY RANGE	1 ~ 40GHz
INPUT POWER (SYSTEM)	120Vac, 60 Hz	DETECTOR FUNCTION	Peak (PK) Average (AV)
ENVIRONMENTAL CONDITIONS	25deg. C, 65%RH	TESTED BY	Chris Lin

ANTENNA POLARITY & TEST DISTANCE: HORIZONTAL AT 3 M

NO.	FREQ. (MHz)	EMISSION LEVEL (dBuV/m)	LIMIT (dBuV/m)	MARGIN (dB)	ANTENNA HEIGHT (m)	TABLE ANGLE (Degree)	RAW VALUE (dBuV)	CORRECTION FACTOR (dB/m)
1	#5714.00	57.3 PK	74.0	-16.7	1.08 H	350	51.00	6.30
2	#5714.00	44.0 AV	54.0	-10.0	1.08 H	350	37.70	6.30
3	#5722.00	57.6 PK	78.2	-20.6	1.10 H	330	51.30	6.30
4	#5725.00	52.3 PK	78.2	-25.9	1.04 H	324	46.00	6.30
5	*5745.00	97.3 PK			1.50 H	99	57.00	40.30
6	*5745.00	86.5 AV			1.50 H	99	46.20	40.30
7	11490.00	58.2 PK	74.0	-15.8	1.55 H	223	41.00	17.20
8	11490.00	45.0 AV	54.0	-9.0	1.55 H	223	27.80	17.20

ANTENNA POLARITY & TEST DISTANCE: VERTICAL AT 3 M

NO.	FREQ. (MHz)	EMISSION LEVEL (dBuV/m)	LIMIT (dBuV/m)	MARGIN (dB)	ANTENNA HEIGHT (m)	TABLE ANGLE (Degree)	RAW VALUE (dBuV)	CORRECTION FACTOR (dB/m)
1	#5714.00	60.0 PK	74.0	-14.0	1.02 V	330	53.70	6.30
2	#5714.00	46.6 AV	54.0	-7.4	1.02 V	330	40.30	6.30
3	#5722.00	68.3 PK	78.2	-9.9	1.08 V	340	62.00	6.30
4	#5725.00	61.8 PK	78.2	-16.4	1.08 V	325	55.50	6.30
5	*5745.00	109.8 PK			1.00 V	335	69.50	40.30
6	*5745.00	99.2 AV			1.00 V	335	58.90	40.30
7	11490.00	59.1 PK	74.0	-14.9	1.18 V	54	41.90	17.20
8	11490.00	45.1 AV	54.0	-8.9	1.18 V	54	27.90	17.20

REMARKS:

1. Emission Level(dBuV/m) = Raw Value(dBuV) + Correction Factor(dB/m)
2. Correction Factor(dB/m) = Antenna Factor(dB/m) + Cable Factor(dB)
3. The other emission levels were very low against the limit.
4. Margin value = Emission Level – Limit value
5. " * ": Fundamental frequency.
6. " # ": The radiated frequency is out of the restricted band.

EUT TEST CONDITION		MEASUREMENT DETAIL	
CHANNEL	Channel 157	FREQUENCY RANGE	1 ~ 40GHz
INPUT POWER (SYSTEM)	120Vac, 60 Hz	DETECTOR FUNCTION	Peak (PK) Average (AV)
ENVIRONMENTAL CONDITIONS	25deg. C, 65%RH	TESTED BY	Chris Lin

ANTENNA POLARITY & TEST DISTANCE: HORIZONTAL AT 3 M

NO.	FREQ. (MHz)	EMISSION LEVEL (dBuV/m)	LIMIT (dBuV/m)	MARGIN (dB)	ANTENNA HEIGHT (m)	TABLE ANGLE (Degree)	RAW VALUE (dBuV)	CORRECTION FACTOR (dB/m)
1	*5785.00	97.9 PK			1.00 H	326	57.50	40.40
2	*5785.00	87.3 AV			1.00 H	326	46.90	40.40
3	11570.00	57.6 PK	74.0	-16.4	1.56 H	98	40.30	17.30
4	11570.00	44.7 AV	54.0	-9.3	1.56 H	98	27.40	17.30

ANTENNA POLARITY & TEST DISTANCE: VERTICAL AT 3 M

NO.	FREQ. (MHz)	EMISSION LEVEL (dBuV/m)	LIMIT (dBuV/m)	MARGIN (dB)	ANTENNA HEIGHT (m)	TABLE ANGLE (Degree)	RAW VALUE (dBuV)	CORRECTION FACTOR (dB/m)
1	*5785.00	108.9 PK			1.00 V	19	68.50	40.40
2	*5785.00	98.6 AV			1.00 V	19	58.20	40.40
3	11570.00	59.2 PK	74.0	-14.8	1.55 V	223	41.90	17.30
4	11570.00	45.2 AV	54.0	-8.8	1.55 V	223	27.90	17.30

REMARKS:

1. Emission Level(dBuV/m) = Raw Value(dBuV) + Correction Factor(dB/m)
2. Correction Factor(dB/m) = Antenna Factor(dB/m) + Cable Factor(dB)
3. The other emission levels were very low against the limit.
4. Margin value = Emission Level – Limit value
5. " * ": Fundamental frequency.
6. " # ": The radiated frequency is out of the restricted band.



EUT TEST CONDITION		MEASUREMENT DETAIL	
CHANNEL	Channel 165	FREQUENCY RANGE	1 ~ 40GHz
INPUT POWER (SYSTEM)	120Vac, 60 Hz	DETECTOR FUNCTION	Peak (PK) Average (AV)
ENVIRONMENTAL CONDITIONS	25deg. C, 65%RH	TESTED BY	Chris Lin

ANTENNA POLARITY & TEST DISTANCE: HORIZONTAL AT 3 M

NO.	FREQ. (MHz)	EMISSION LEVEL (dBuV/m)	LIMIT (dBuV/m)	MARGIN (dB)	ANTENNA HEIGHT (m)	TABLE ANGLE (Degree)	RAW VALUE (dBuV)	CORRECTION FACTOR (dB/m)
1	*5825.00	97.6 PK			1.00 H	322	57.10	40.50
2	*5825.00	87.9 AV			1.00 H	322	47.40	40.50
3	#5850.00	43.6 PK	78.2	-34.6	1.11 H	304	37.00	6.60
4	#5853.00	56.7 PK	78.2	-21.5	1.08 H	74	50.10	6.60
5	#5861.00	57.2 PK	74.0	-16.8	1.02 H	333	50.60	6.60
6	#5861.00	44.0 AV	54.0	-10.0	1.02 H	333	37.40	6.60
7	11650.00	57.9 PK	74.0	-16.1	1.55 H	201	40.20	17.70
8	11650.00	45.6 AV	54.0	-8.4	1.55 H	201	27.90	17.70

ANTENNA POLARITY & TEST DISTANCE: VERTICAL AT 3 M

NO.	FREQ. (MHz)	EMISSION LEVEL (dBuV/m)	LIMIT (dBuV/m)	MARGIN (dB)	ANTENNA HEIGHT (m)	TABLE ANGLE (Degree)	RAW VALUE (dBuV)	CORRECTION FACTOR (dB/m)
1	*5825.00	109.4 PK			1.03 V	0	68.90	40.50
2	*5825.00	98.7 AV			1.03 V	0	58.20	40.50
3	#5850.00	52.5 PK	78.2	-25.7	1.55 V	230	45.90	6.60
4	#5853.00	59.4 PK	78.2	-18.8	1.10 V	16	52.80	6.60
5	#5861.00	57.9 PK	74.0	-16.1	1.10 V	10	51.30	6.60
6	#5861.00	45.6 AV	54.0	-8.4	1.10 V	10	39.00	6.60
7	11650.00	58.9 PK	74.0	-15.1	1.55 V	203	41.20	17.70
8	11650.00	45.2 AV	54.0	-8.8	1.55 V	203	27.50	17.70

REMARKS:

1. Emission Level(dBuV/m) = Raw Value(dBuV) + Correction Factor(dB/m)
2. Correction Factor(dB/m) = Antenna Factor(dB/m) + Cable Factor(dB)
3. The other emission levels were very low against the limit.
4. Margin value = Emission Level – Limit value
5. " * ": Fundamental frequency.
6. " # ": The radiated frequency is out of the restricted band.

802.11n (HT20)

EUT TEST CONDITION		MEASUREMENT DETAIL	
CHANNEL	Channel 36	FREQUENCY RANGE	1 ~ 40GHz
INPUT POWER (SYSTEM)	120Vac, 60 Hz	DETECTOR FUNCTION	Peak (PK) Average (AV)
ENVIRONMENTAL CONDITIONS	25deg. C, 65%RH	TESTED BY	Ted Chang

ANTENNA POLARITY & TEST DISTANCE: HORIZONTAL AT 3 M

NO.	FREQ. (MHz)	EMISSION LEVEL (dBuV/m)	LIMIT (dBuV/m)	MARGIN (dB)	ANTENNA HEIGHT (m)	TABLE ANGLE (Degree)	RAW VALUE (dBuV)	CORRECTION FACTOR (dB/m)
1	5150.00	59.4 PK	74.0	-14.6	1.02 H	147	55.60	3.80
2	5150.00	44.0 AV	54.0	-10.0	1.02 H	147	40.20	3.80
3	*5180.00	98.0 PK			1.00 H	160	60.20	37.80
4	*5180.00	87.7 AV			1.00 H	160	49.90	37.80
5	#10360.00	59.4 PK	74.0	-14.6	1.62 H	188	44.90	14.50
6	#10360.00	46.0 AV	54.0	-8.0	1.62 H	188	31.50	14.50

ANTENNA POLARITY & TEST DISTANCE: VERTICAL AT 3 M

NO.	FREQ. (MHz)	EMISSION LEVEL (dBuV/m)	LIMIT (dBuV/m)	MARGIN (dB)	ANTENNA HEIGHT (m)	TABLE ANGLE (Degree)	RAW VALUE (dBuV)	CORRECTION FACTOR (dB/m)
1	5150.00	57.9 PK	74.0	-16.1	1.13 V	170	54.10	3.80
2	5150.00	43.2 AV	54.0	-10.8	1.13 V	170	39.40	3.80
3	*5180.00	111.5 PK			1.13 V	174	73.70	37.80
4	*5180.00	101.2 AV			1.13 V	174	63.40	37.80
5	#10360.00	63.4 PK	74.0	-10.6	1.04 V	184	48.90	14.50
6	#10360.00	47.4 AV	54.0	-6.6	1.04 V	184	32.90	14.50

REMARKS:

1. Emission Level(dBuV/m) = Raw Value(dBuV) + Correction Factor(dB/m)
2. Correction Factor(dB/m) = Antenna Factor(dB/m) + Cable Factor(dB)
3. The other emission levels were very low against the limit.
4. Margin value = Emission Level – Limit value
5. " * ": Fundamental frequency.
6. " # ": The radiated frequency is out of the restricted band.

EUT TEST CONDITION		MEASUREMENT DETAIL	
CHANNEL	Channel 40	FREQUENCY RANGE	1 ~ 40GHz
INPUT POWER (SYSTEM)	120Vac, 60 Hz	DETECTOR FUNCTION	Peak (PK) Average (AV)
ENVIRONMENTAL CONDITIONS	25deg. C, 65%RH	TESTED BY	Ted Chang

ANTENNA POLARITY & TEST DISTANCE: HORIZONTAL AT 3 M								
NO.	FREQ. (MHz)	EMISSION LEVEL (dBuV/m)	LIMIT (dBuV/m)	MARGIN (dB)	ANTENNA HEIGHT (m)	TABLE ANGLE (Degree)	RAW VALUE (dBuV)	CORRECTION FACTOR (dB/m)
1	*5200.00	99.6 PK			1.24 H	290	61.80	37.80
2	*5200.00	89.1 AV			1.24 H	290	51.30	37.80
3	#10400.00	59.3 PK	74.0	-14.7	1.62 H	307	44.60	14.70
4	#10400.00	45.6 AV	54.0	-8.4	1.62 H	307	30.90	14.70

ANTENNA POLARITY & TEST DISTANCE: VERTICAL AT 3 M								
NO.	FREQ. (MHz)	EMISSION LEVEL (dBuV/m)	LIMIT (dBuV/m)	MARGIN (dB)	ANTENNA HEIGHT (m)	TABLE ANGLE (Degree)	RAW VALUE (dBuV)	CORRECTION FACTOR (dB/m)
1	*5200.00	111.9 PK			1.00 V	0	74.10	37.80
2	*5200.00	102.0 AV			1.00 V	0	64.20	37.80
3	#10400.00	63.5 PK	74.0	-10.5	1.49 V	301	48.80	14.70
4	#10400.00	47.6 AV	54.0	-6.4	1.49 V	301	32.90	14.70

REMARKS:

1. Emission Level(dBuV/m) = Raw Value(dBuV) + Correction Factor(dB/m)
2. Correction Factor(dB/m) = Antenna Factor(dB/m) + Cable Factor(dB)
3. The other emission levels were very low against the limit.
4. Margin value = Emission Level – Limit value
5. " * ": Fundamental frequency.
6. " # ": The radiated frequency is out of the restricted band.

EUT TEST CONDITION		MEASUREMENT DETAIL	
CHANNEL	Channel 48	FREQUENCY RANGE	1 ~ 40GHz
INPUT POWER (SYSTEM)	120Vac, 60 Hz	DETECTOR FUNCTION	Peak (PK) Average (AV)
ENVIRONMENTAL CONDITIONS	25deg. C, 65%RH	TESTED BY	Ted Chang

ANTENNA POLARITY & TEST DISTANCE: HORIZONTAL AT 3 M

NO.	FREQ. (MHz)	EMISSION LEVEL (dBuV/m)	LIMIT (dBuV/m)	MARGIN (dB)	ANTENNA HEIGHT (m)	TABLE ANGLE (Degree)	RAW VALUE (dBuV)	CORRECTION FACTOR (dB/m)
1	*5240.00	98.4 PK			1.00 H	126	60.60	37.80
2	*5240.00	88.2 AV			1.00 H	126	50.40	37.80
3	5350.00	59.5 PK	74.0	-14.5	1.00 H	130	55.20	4.30
4	5350.00	47.0 AV	54.0	-7.0	1.00 H	130	42.70	4.30
5	#10480.00	60.8 PK	74.0	-13.2	1.59 H	354	45.80	15.00
6	#10480.00	46.5 AV	54.0	-7.5	1.59 H	354	31.50	15.00

ANTENNA POLARITY & TEST DISTANCE: VERTICAL AT 3 M

NO.	FREQ. (MHz)	EMISSION LEVEL (dBuV/m)	LIMIT (dBuV/m)	MARGIN (dB)	ANTENNA HEIGHT (m)	TABLE ANGLE (Degree)	RAW VALUE (dBuV)	CORRECTION FACTOR (dB/m)
1	*5240.00	111.7 PK			1.00 V	2	73.90	37.80
2	*5240.00	101.5 AV			1.00 V	2	63.70	37.80
3	5350.00	61.0 PK	74.0	-13.0	1.07 V	154	56.70	4.30
4	5350.00	47.9 AV	54.0	-6.1	1.07 V	154	43.60	4.30
5	#10480.00	63.2 PK	74.0	-10.8	1.95 V	182	48.20	15.00
6	#10480.00	47.7 AV	54.0	-6.3	1.95 V	182	32.70	15.00

REMARKS:

1. Emission Level(dBuV/m) = Raw Value(dBuV) + Correction Factor(dB/m)
2. Correction Factor(dB/m) = Antenna Factor(dB/m) + Cable Factor(dB)
3. The other emission levels were very low against the limit.
4. Margin value = Emission Level – Limit value
5. " * ": Fundamental frequency.
6. " # ": The radiated frequency is out of the restricted band.

EUT TEST CONDITION		MEASUREMENT DETAIL	
CHANNEL	Channel 52	FREQUENCY RANGE	1 ~ 40GHz
INPUT POWER (SYSTEM)	120Vac, 60 Hz	DETECTOR FUNCTION	Peak (PK) Average (AV)
ENVIRONMENTAL CONDITIONS	25deg. C, 65%RH	TESTED BY	Ted Chang

ANTENNA POLARITY & TEST DISTANCE: HORIZONTAL AT 3 M

NO.	FREQ. (MHz)	EMISSION LEVEL (dBuV/m)	LIMIT (dBuV/m)	MARGIN (dB)	ANTENNA HEIGHT (m)	TABLE ANGLE (Degree)	RAW VALUE (dBuV)	CORRECTION FACTOR (dB/m)
1	5150.00	58.6 PK	74.0	-15.4	1.06 H	320	54.80	3.80
2	5150.00	46.0 AV	54.0	-8.0	1.06 H	320	42.20	3.80
3	*5260.00	98.8 PK			1.00 H	217	60.90	37.90
4	*5260.00	88.1 AV			1.00 H	217	50.20	37.90
5	#10520.00	59.9 PK	74.0	-14.1	1.93 H	187	44.90	15.00
6	#10520.00	46.8 AV	54.0	-7.2	1.93 H	187	31.80	15.00

ANTENNA POLARITY & TEST DISTANCE: VERTICAL AT 3 M

NO.	FREQ. (MHz)	EMISSION LEVEL (dBuV/m)	LIMIT (dBuV/m)	MARGIN (dB)	ANTENNA HEIGHT (m)	TABLE ANGLE (Degree)	RAW VALUE (dBuV)	CORRECTION FACTOR (dB/m)
1	5150.00	61.3 PK	74.0	-12.7	1.00 V	184	57.50	3.80
2	5150.00	47.4 AV	54.0	-6.6	1.00 V	184	43.60	3.80
3	*5260.00	112.6 PK			1.00 V	174	74.70	37.90
4	*5260.00	102.7 AV			1.00 V	174	64.80	37.90
5	#10520.00	64.8 PK	74.0	-9.2	1.84 V	269	49.80	15.00
6	#10520.00	48.0 AV	54.0	-6.0	1.84 V	269	33.00	15.00

REMARKS:

1. Emission Level(dBuV/m) = Raw Value(dBuV) + Correction Factor(dB/m)
2. Correction Factor(dB/m) = Antenna Factor(dB/m) + Cable Factor(dB)
3. The other emission levels were very low against the limit.
4. Margin value = Emission Level – Limit value
5. " * ": Fundamental frequency.
6. " # ": The radiated frequency is out of the restricted band.

EUT TEST CONDITION		MEASUREMENT DETAIL	
CHANNEL	Channel 60	FREQUENCY RANGE	1 ~ 40GHz
INPUT POWER (SYSTEM)	120Vac, 60 Hz	DETECTOR FUNCTION	Peak (PK) Average (AV)
ENVIRONMENTAL CONDITIONS	25deg. C, 65%RH	TESTED BY	Ted Chang

ANTENNA POLARITY & TEST DISTANCE: HORIZONTAL AT 3 M								
NO.	FREQ. (MHz)	EMISSION LEVEL (dBuV/m)	LIMIT (dBuV/m)	MARGIN (dB)	ANTENNA HEIGHT (m)	TABLE ANGLE (Degree)	RAW VALUE (dBuV)	CORRECTION FACTOR (dB/m)
1	*5300.00	98.6 PK			1.00 H	217	60.70	37.90
2	*5300.00	88.7 AV			1.00 H	217	50.80	37.90
3	10600.00	60.7 PK	74.0	-13.3	1.61 H	204	45.50	15.20
4	10600.00	46.7 AV	54.0	-7.3	1.61 H	204	31.50	15.20
ANTENNA POLARITY & TEST DISTANCE: VERTICAL AT 3 M								
NO.	FREQ. (MHz)	EMISSION LEVEL (dBuV/m)	LIMIT (dBuV/m)	MARGIN (dB)	ANTENNA HEIGHT (m)	TABLE ANGLE (Degree)	RAW VALUE (dBuV)	CORRECTION FACTOR (dB/m)
1	*5300.00	111.9 PK			1.00 V	0	74.00	37.90
2	*5300.00	101.8 AV			1.00 V	0	63.90	37.90
3	10600.00	65.0 PK	74.0	-9.0	1.63 V	204	49.80	15.20
4	10600.00	49.1 AV	54.0	-4.9	1.63 V	204	33.90	15.20

REMARKS:

1. Emission Level(dBuV/m) = Raw Value(dBuV) + Correction Factor(dB/m)
2. Correction Factor(dB/m) = Antenna Factor(dB/m) + Cable Factor(dB)
3. The other emission levels were very low against the limit.
4. Margin value = Emission Level – Limit value
5. " * ": Fundamental frequency.

EUT TEST CONDITION		MEASUREMENT DETAIL	
CHANNEL	Channel 64	FREQUENCY RANGE	1 ~ 40GHz
INPUT POWER (SYSTEM)	120Vac, 60 Hz	DETECTOR FUNCTION	Peak (PK) Average (AV)
ENVIRONMENTAL CONDITIONS	25deg. C, 65%RH	TESTED BY	Ted Chang

ANTENNA POLARITY & TEST DISTANCE: HORIZONTAL AT 3 M

NO.	FREQ. (MHz)	EMISSION LEVEL (dBuV/m)	LIMIT (dBuV/m)	MARGIN (dB)	ANTENNA HEIGHT (m)	TABLE ANGLE (Degree)	RAW VALUE (dBuV)	CORRECTION FACTOR (dB/m)
1	*5320.00	98.1 PK			1.23 H	217	60.10	38.00
2	*5320.00	87.6 AV			1.23 H	217	49.60	38.00
3	5350.00	59.0 PK	74.0	-15.0	1.03 H	62	54.70	4.30
4	5350.00	45.9 AV	54.0	-8.1	1.03 H	62	41.60	4.30
5	10640.00	61.1 PK	74.0	-12.9	1.25 H	254	45.80	15.30
6	10640.00	46.8 AV	54.0	-7.2	1.25 H	254	31.50	15.30

ANTENNA POLARITY & TEST DISTANCE: VERTICAL AT 3 M

NO.	FREQ. (MHz)	EMISSION LEVEL (dBuV/m)	LIMIT (dBuV/m)	MARGIN (dB)	ANTENNA HEIGHT (m)	TABLE ANGLE (Degree)	RAW VALUE (dBuV)	CORRECTION FACTOR (dB/m)
1	*5320.00	112.5 PK			1.00 V	174	74.50	38.00
2	*5320.00	101.8 AV			1.00 V	174	63.80	38.00
3	5350.00	57.1 PK	74.0	-16.9	1.10 V	0	52.80	4.30
4	5350.00	48.1 AV	54.0	-5.9	1.10 V	0	43.80	4.30
5	10640.00	64.8 PK	74.0	-9.2	1.22 V	248	49.50	15.30
6	10640.00	48.3 AV	54.0	-5.7	1.22 V	248	33.00	15.30

REMARKS:

1. Emission Level(dBuV/m) = Raw Value(dBuV) + Correction Factor(dB/m)
2. Correction Factor(dB/m) = Antenna Factor(dB/m) + Cable Factor(dB)
3. The other emission levels were very low against the limit.
4. Margin value = Emission Level – Limit value
5. " * ": Fundamental frequency.

EUT TEST CONDITION		MEASUREMENT DETAIL	
CHANNEL	Channel 100	FREQUENCY RANGE	1 ~ 40GHz
INPUT POWER (SYSTEM)	120Vac, 60 Hz	DETECTOR FUNCTION	Peak (PK) Average (AV)
ENVIRONMENTAL CONDITIONS	25deg. C, 65%RH	TESTED BY	Ted Chang

ANTENNA POLARITY & TEST DISTANCE: HORIZONTAL AT 3 M

NO.	FREQ. (MHz)	EMISSION LEVEL (dBuV/m)	LIMIT (dBuV/m)	MARGIN (dB)	ANTENNA HEIGHT (m)	TABLE ANGLE (Degree)	RAW VALUE (dBuV)	CORRECTION FACTOR (dB/m)
1	5460.00	55.7 PK	74.0	-18.3	1.24 H	221	51.20	4.50
2	5460.00	42.7 AV	54.0	-11.3	1.24 H	221	38.20	4.50
3	#5470.00	57.9 PK	74.0	-16.1	1.32 H	251	53.50	4.40
4	#5470.00	43.8 AV	54.0	-10.2	1.32 H	251	39.40	4.40
5	*5500.00	97.6 PK			1.00 H	215	59.30	38.30
6	*5500.00	87.3 AV			1.00 H	215	49.00	38.30
7	11000.00	60.8 PK	74.0	-13.2	1.24 H	259	44.80	16.00
8	11000.00	46.8 AV	54.0	-7.2	1.24 H	259	30.80	16.00

ANTENNA POLARITY & TEST DISTANCE: VERTICAL AT 3 M

NO.	FREQ. (MHz)	EMISSION LEVEL (dBuV/m)	LIMIT (dBuV/m)	MARGIN (dB)	ANTENNA HEIGHT (m)	TABLE ANGLE (Degree)	RAW VALUE (dBuV)	CORRECTION FACTOR (dB/m)
1	5460.00	54.4 PK	74.0	-19.6	1.00 V	2	49.90	4.50
2	5460.00	42.7 AV	54.0	-11.3	1.00 V	2	38.20	4.50
3	#5470.00	59.8 PK	74.0	-14.2	1.00 V	8	55.40	4.40
4	#5470.00	46.4 AV	54.0	-7.6	1.00 V	8	42.00	4.40
5	*5500.00	112.0 PK			1.11 V	179	73.70	38.30
6	*5500.00	101.7 AV			1.11 V	179	63.40	38.30
7	11000.00	65.2 PK	74.0	-8.8	1.69 V	321	49.20	16.00
8	11000.00	49.7 AV	54.0	-4.3	1.69 V	321	33.70	16.00

REMARKS:

1. Emission Level(dBuV/m) = Raw Value(dBuV) + Correction Factor(dB/m)
2. Correction Factor(dB/m) = Antenna Factor(dB/m) + Cable Factor(dB)
3. The other emission levels were very low against the limit.
4. Margin value = Emission Level – Limit value
5. " * ": Fundamental frequency.
6. " # ": The radiated frequency is out of the restricted band.

EUT TEST CONDITION		MEASUREMENT DETAIL	
CHANNEL	Channel 116	FREQUENCY RANGE	1 ~ 40GHz
INPUT POWER (SYSTEM)	120Vac, 60 Hz	DETECTOR FUNCTION	Peak (PK) Average (AV)
ENVIRONMENTAL CONDITIONS	25deg. C, 65%RH	TESTED BY	Ted Chang

ANTENNA POLARITY & TEST DISTANCE: HORIZONTAL AT 3 M								
NO.	FREQ. (MHz)	EMISSION LEVEL (dBuV/m)	LIMIT (dBuV/m)	MARGIN (dB)	ANTENNA HEIGHT (m)	TABLE ANGLE (Degree)	RAW VALUE (dBuV)	CORRECTION FACTOR (dB/m)
1	*5580.00	98.7 PK			1.00 H	163	60.30	38.40
2	*5580.00	88.5 AV			1.00 H	163	50.10	38.40
3	11160.00	61.4 PK	74.0	-12.6	1.00 H	61	45.40	16.00
4	11160.00	47.5 AV	54.0	-6.5	1.00 H	61	31.50	16.00

ANTENNA POLARITY & TEST DISTANCE: VERTICAL AT 3 M								
NO.	FREQ. (MHz)	EMISSION LEVEL (dBuV/m)	LIMIT (dBuV/m)	MARGIN (dB)	ANTENNA HEIGHT (m)	TABLE ANGLE (Degree)	RAW VALUE (dBuV)	CORRECTION FACTOR (dB/m)
1	*5580.00	112.3 PK			1.46 V	349	73.90	38.40
2	*5580.00	102.2 AV			1.46 V	349	63.80	38.40
3	11160.00	64.5 PK	74.0	-9.5	1.00 V	214	48.50	16.00
4	11160.00	48.9 AV	54.0	-5.1	1.00 V	214	32.90	16.00

REMARKS:

1. Emission Level(dBuV/m) = Raw Value(dBuV) + Correction Factor(dB/m)
2. Correction Factor(dB/m) = Antenna Factor(dB/m) + Cable Factor(dB)
3. The other emission levels were very low against the limit.
4. Margin value = Emission Level – Limit value
5. " * ": Fundamental frequency.



EUT TEST CONDITION		MEASUREMENT DETAIL	
CHANNEL	Channel 140	FREQUENCY RANGE	1 ~ 40GHz
INPUT POWER (SYSTEM)	120Vac, 60 Hz	DETECTOR FUNCTION	Peak (PK) Average (AV)
ENVIRONMENTAL CONDITIONS	25deg. C, 65%RH	TESTED BY	Ted Chang

ANTENNA POLARITY & TEST DISTANCE: HORIZONTAL AT 3 M

NO.	FREQ. (MHz)	EMISSION LEVEL (dBuV/m)	LIMIT (dBuV/m)	MARGIN (dB)	ANTENNA HEIGHT (m)	TABLE ANGLE (Degree)	RAW VALUE (dBuV)	CORRECTION FACTOR (dB/m)
1	*5700.00	98.1 PK			1.00 H	174	59.50	38.60
2	*5700.00	87.8 AV			1.00 H	174	49.20	38.60
3	#5725.00	59.6 PK	74.0	-14.4	1.54 H	255	54.80	4.80
4	#5725.00	47.4 AV	54.0	-6.6	1.54 H	255	42.60	4.80
5	11400.00	61.0 PK	74.0	-13.0	1.62 H	51	45.10	15.90
6	11400.00	47.4 AV	54.0	-6.6	1.62 H	51	31.50	15.90

ANTENNA POLARITY & TEST DISTANCE: VERTICAL AT 3 M

NO.	FREQ. (MHz)	EMISSION LEVEL (dBuV/m)	LIMIT (dBuV/m)	MARGIN (dB)	ANTENNA HEIGHT (m)	TABLE ANGLE (Degree)	RAW VALUE (dBuV)	CORRECTION FACTOR (dB/m)
1	*5700.00	112.1 PK			1.00 V	182	73.50	38.60
2	*5700.00	102.1 AV			1.00 V	182	63.50	38.60
3	#5725.00	67.1 PK	74.0	-6.9	1.24 V	158	62.30	4.80
4	#5725.00	51.1 AV	54.0	-2.9	1.24 V	158	46.30	4.80
5	11400.00	64.2 PK	74.0	-9.8	1.57 V	64	48.30	15.90
6	11400.00	49.7 AV	54.0	-4.3	1.57 V	64	33.80	15.90

REMARKS:

1. Emission Level(dBuV/m) = Raw Value(dBuV) + Correction Factor(dB/m)
2. Correction Factor(dB/m) = Antenna Factor(dB/m) + Cable Factor(dB)
3. The other emission levels were very low against the limit.
4. Margin value = Emission Level – Limit value
5. " * ": Fundamental frequency.
6. " # ": The radiated frequency is out of the restricted band.

EUT TEST CONDITION		MEASUREMENT DETAIL	
CHANNEL	Channel 149	FREQUENCY RANGE	1 ~ 40GHz
INPUT POWER (SYSTEM)	120Vac, 60 Hz	DETECTOR FUNCTION	Peak (PK) Average (AV)
ENVIRONMENTAL CONDITIONS	25deg. C, 65%RH	TESTED BY	Chris Lin

ANTENNA POLARITY & TEST DISTANCE: HORIZONTAL AT 3 M

NO.	FREQ. (MHz)	EMISSION LEVEL (dBuV/m)	LIMIT (dBuV/m)	MARGIN (dB)	ANTENNA HEIGHT (m)	TABLE ANGLE (Degree)	RAW VALUE (dBuV)	CORRECTION FACTOR (dB/m)
1	#5714.00	57.9 PK	74.0	-16.1	1.55 H	120	51.60	6.30
2	#5714.00	44.2 AV	54.0	-9.8	1.55 H	120	37.90	6.30
3	#5722.00	58.2 PK	78.2	-20.0	1.05 H	130	51.90	6.30
4	#5725.00	53.2 PK	78.2	-25.0	1.19 H	134	46.90	6.30
5	*5745.00	97.2 PK			1.00 H	110	56.90	40.30
6	*5745.00	87.4 AV			1.00 H	110	47.10	40.30
7	11490.00	58.2 PK	74.0	-15.8	1.39 H	87	41.00	17.20
8	11490.00	45.0 AV	54.0	-9.0	1.39 H	87	27.80	17.20

ANTENNA POLARITY & TEST DISTANCE: VERTICAL AT 3 M

NO.	FREQ. (MHz)	EMISSION LEVEL (dBuV/m)	LIMIT (dBuV/m)	MARGIN (dB)	ANTENNA HEIGHT (m)	TABLE ANGLE (Degree)	RAW VALUE (dBuV)	CORRECTION FACTOR (dB/m)
1	#5714.00	58.9 PK	74.0	-15.1	1.30 V	335	52.60	6.30
2	#5714.00	46.8 AV	54.0	-7.2	1.30 V	335	40.50	6.30
3	#5722.00	65.3 PK	78.2	-12.9	1.30 V	320	59.00	6.30
4	#5725.00	61.0 PK	78.2	-17.2	1.17 V	318	54.70	6.30
5	*5745.00	109.2 PK			1.25 V	332	68.90	40.30
6	*5745.00	100.2 AV			1.25 V	332	59.90	40.30
7	11490.00	58.7 PK	74.0	-15.3	1.55 V	223	41.50	17.20
8	11490.00	45.1 AV	54.0	-8.9	1.55 V	223	27.90	17.20

REMARKS:

1. Emission Level(dBuV/m) = Raw Value(dBuV) + Correction Factor(dB/m)
2. Correction Factor(dB/m) = Antenna Factor(dB/m) + Cable Factor(dB)
3. The other emission levels were very low against the limit.
4. Margin value = Emission Level – Limit value
5. " * ": Fundamental frequency.
6. " # ": The radiated frequency is out of the restricted band.

EUT TEST CONDITION		MEASUREMENT DETAIL	
CHANNEL	Channel 157	FREQUENCY RANGE	1 ~ 40GHz
INPUT POWER (SYSTEM)	120Vac, 60 Hz	DETECTOR FUNCTION	Peak (PK) Average (AV)
ENVIRONMENTAL CONDITIONS	25deg. C, 65%RH	TESTED BY	Chris Lin

ANTENNA POLARITY & TEST DISTANCE: HORIZONTAL AT 3 M

NO.	FREQ. (MHz)	EMISSION LEVEL (dBuV/m)	LIMIT (dBuV/m)	MARGIN (dB)	ANTENNA HEIGHT (m)	TABLE ANGLE (Degree)	RAW VALUE (dBuV)	CORRECTION FACTOR (dB/m)
1	*5785.00	96.8 PK			1.00 H	330	56.40	40.40
2	*5785.00	86.5 AV			1.00 H	330	46.10	40.40
3	11570.00	57.8 PK	74.0	-16.2	1.36 H	98	40.50	17.30
4	11570.00	45.2 AV	54.0	-8.8	1.36 H	98	27.90	17.30

ANTENNA POLARITY & TEST DISTANCE: VERTICAL AT 3 M

NO.	FREQ. (MHz)	EMISSION LEVEL (dBuV/m)	LIMIT (dBuV/m)	MARGIN (dB)	ANTENNA HEIGHT (m)	TABLE ANGLE (Degree)	RAW VALUE (dBuV)	CORRECTION FACTOR (dB/m)
1	*5785.00	109.2 PK			1.00 V	153	68.80	40.40
2	*5785.00	99.4 AV			1.00 V	153	59.00	40.40
3	11570.00	58.9 PK	74.0	-15.1	1.56 V	302	41.60	17.30
4	11570.00	45.2 AV	54.0	-8.8	1.56 V	302	27.90	17.30

REMARKS:

1. Emission Level(dBuV/m) = Raw Value(dBuV) + Correction Factor(dB/m)
2. Correction Factor(dB/m) = Antenna Factor(dB/m) + Cable Factor(dB)
3. The other emission levels were very low against the limit.
4. Margin value = Emission Level – Limit value
5. " * ": Fundamental frequency.
6. " # ": The radiated frequency is out of the restricted band.



EUT TEST CONDITION		MEASUREMENT DETAIL	
CHANNEL	Channel 165	FREQUENCY RANGE	1 ~ 40GHz
INPUT POWER (SYSTEM)	120Vac, 60 Hz	DETECTOR FUNCTION	Peak (PK) Average (AV)
ENVIRONMENTAL CONDITIONS	25deg. C, 65%RH	TESTED BY	Chris Lin

ANTENNA POLARITY & TEST DISTANCE: HORIZONTAL AT 3 M

NO.	FREQ. (MHz)	EMISSION LEVEL (dBuV/m)	LIMIT (dBuV/m)	MARGIN (dB)	ANTENNA HEIGHT (m)	TABLE ANGLE (Degree)	RAW VALUE (dBuV)	CORRECTION FACTOR (dB/m)
1	*5825.00	96.6 PK			1.00 H	322	56.10	40.50
2	*5825.00	87.0 AV			1.00 H	322	46.50	40.50
3	#5850.00	46.5 PK	78.2	-31.7	1.18 H	317	39.90	6.60
4	#5853.00	57.0 PK	78.2	-21.2	1.11 H	340	50.40	6.60
5	#5861.00	57.3 PK	74.0	-16.7	1.01 H	330	50.70	6.60
6	#5861.00	45.6 AV	54.0	-8.4	1.01 H	330	39.00	6.60
7	11650.00	58.2 PK	74.0	-15.8	1.56 H	20	40.50	17.70
8	11650.00	45.3 AV	54.0	-8.7	1.56 H	20	27.60	17.70

ANTENNA POLARITY & TEST DISTANCE: VERTICAL AT 3 M

NO.	FREQ. (MHz)	EMISSION LEVEL (dBuV/m)	LIMIT (dBuV/m)	MARGIN (dB)	ANTENNA HEIGHT (m)	TABLE ANGLE (Degree)	RAW VALUE (dBuV)	CORRECTION FACTOR (dB/m)
1	*5825.00	109.7 PK			1.30 V	46	69.20	40.50
2	*5825.00	99.0 AV			1.30 V	46	58.50	40.50
3	#5850.00	53.5 PK	78.2	-24.7	1.50 V	60	46.90	6.60
4	#5853.00	59.1 PK	78.2	-19.1	1.17 V	51	52.50	6.60
5	#5861.00	59.6 PK	74.0	-14.4	1.35 V	50	53.00	6.60
6	#5861.00	47.1 AV	54.0	-6.9	1.35 V	50	40.50	6.60
7	11650.00	59.2 PK	74.0	-14.8	1.36 V	98	41.50	17.70
8	11650.00	45.7 AV	54.0	-8.3	1.36 V	98	28.00	17.70

REMARKS:

1. Emission Level(dBuV/m) = Raw Value(dBuV) + Correction Factor(dB/m)
2. Correction Factor(dB/m) = Antenna Factor(dB/m) + Cable Factor(dB)
3. The other emission levels were very low against the limit.
4. Margin value = Emission Level – Limit value
5. " * ": Fundamental frequency.
6. " # ": The radiated frequency is out of the restricted band.

802.11n (HT40)

EUT TEST CONDITION		MEASUREMENT DETAIL	
CHANNEL	Channel 38	FREQUENCY RANGE	1 ~ 40GHz
INPUT POWER (SYSTEM)	120Vac, 60 Hz	DETECTOR FUNCTION	Peak (PK) Average (AV)
ENVIRONMENTAL CONDITIONS	25deg. C, 65%RH	TESTED BY	Ted Chang

ANTENNA POLARITY & TEST DISTANCE: HORIZONTAL AT 3 M

NO.	FREQ. (MHz)	EMISSION LEVEL (dBuV/m)	LIMIT (dBuV/m)	MARGIN (dB)	ANTENNA HEIGHT (m)	TABLE ANGLE (Degree)	RAW VALUE (dBuV)	CORRECTION FACTOR (dB/m)
1	5150.00	66.0 PK	74.0	-8.0	1.32 H	158	62.20	3.80
2	5150.00	48.7 AV	54.0	-5.3	1.32 H	158	44.90	3.80
3	*5190.00	94.3 PK			1.00 H	127	56.50	37.80
4	*5190.00	83.9 AV			1.00 H	127	46.10	37.80
5	#10380.00	60.2 PK	74.0	-13.8	1.90 H	100	45.50	14.70
6	#10380.00	46.2 AV	54.0	-7.8	1.90 H	100	31.50	14.70

ANTENNA POLARITY & TEST DISTANCE: VERTICAL AT 3 M

NO.	FREQ. (MHz)	EMISSION LEVEL (dBuV/m)	LIMIT (dBuV/m)	MARGIN (dB)	ANTENNA HEIGHT (m)	TABLE ANGLE (Degree)	RAW VALUE (dBuV)	CORRECTION FACTOR (dB/m)
1	5150.00	70.2 PK	74.0	-3.8	1.00 V	178	66.40	3.80
2	5150.00	51.2 AV	54.0	-2.8	1.00 V	178	47.40	3.80
3	*5190.00	96.8 PK			1.00 V	147	59.00	37.80
4	*5190.00	96.6 AV			1.00 V	147	58.80	37.80
5	#10380.00	62.3 PK	74.0	-11.7	1.54 V	187	47.60	14.70
6	#10380.00	47.9 AV	54.0	-6.1	1.54 V	187	33.20	14.70

REMARKS:

1. Emission Level(dBuV/m) = Raw Value(dBuV) + Correction Factor(dB/m)
2. Correction Factor(dB/m) = Antenna Factor(dB/m) + Cable Factor(dB)
3. The other emission levels were very low against the limit.
4. Margin value = Emission Level – Limit value
5. " * ": Fundamental frequency.
6. " # ": The radiated frequency is out of the restricted band.

EUT TEST CONDITION		MEASUREMENT DETAIL	
CHANNEL	Channel 46	FREQUENCY RANGE	1 ~ 40GHz
INPUT POWER (SYSTEM)	120Vac, 60 Hz	DETECTOR FUNCTION	Peak (PK) Average (AV)
ENVIRONMENTAL CONDITIONS	25deg. C, 65%RH	TESTED BY	Ted Chang

ANTENNA POLARITY & TEST DISTANCE: HORIZONTAL AT 3 M

NO.	FREQ. (MHz)	EMISSION LEVEL (dBuV/m)	LIMIT (dBuV/m)	MARGIN (dB)	ANTENNA HEIGHT (m)	TABLE ANGLE (Degree)	RAW VALUE (dBuV)	CORRECTION FACTOR (dB/m)
1	*5230.00	59.3 PK			1.34 H	162	55.30	4.00
2	*5230.00	49.2 AV			1.34 H	162	45.20	4.00
3	5350.00	57.5 PK	74.0	-16.5	1.69 H	162	53.20	4.30
4	5350.00	45.0 AV	54.0	-9.0	1.69 H	162	40.70	4.30
5	#10460.00	60.7 PK	74.0	-13.3	1.08 H	210	45.80	14.90
6	#10460.00	45.8 AV	54.0	-8.2	1.08 H	210	30.90	14.90

ANTENNA POLARITY & TEST DISTANCE: VERTICAL AT 3 M

NO.	FREQ. (MHz)	EMISSION LEVEL (dBuV/m)	LIMIT (dBuV/m)	MARGIN (dB)	ANTENNA HEIGHT (m)	TABLE ANGLE (Degree)	RAW VALUE (dBuV)	CORRECTION FACTOR (dB/m)
1	*5230.00	107.4 PK			1.00 V	175	69.60	37.80
2	*5230.00	97.5 AV			1.00 V	175	59.70	37.80
3	5350.00	60.8 PK	74.0	-13.2	1.25 V	160	56.50	4.30
4	5350.00	47.0 AV	54.0	-7.0	1.25 V	160	42.70	4.30
5	#10460.00	62.5 PK	74.0	-11.5	1.00 V	247	47.60	14.90
6	#10460.00	48.1 AV	54.0	-5.9	1.00 V	247	33.20	14.90

REMARKS:

1. Emission Level(dBuV/m) = Raw Value(dBuV) + Correction Factor(dB/m)
2. Correction Factor(dB/m) = Antenna Factor(dB/m) + Cable Factor(dB)
3. The other emission levels were very low against the limit.
4. Margin value = Emission Level – Limit value
5. " * ": Fundamental frequency.
6. " # ": The radiated frequency is out of the restricted band.

EUT TEST CONDITION		MEASUREMENT DETAIL	
CHANNEL	Channel 54	FREQUENCY RANGE	1 ~ 40GHz
INPUT POWER (SYSTEM)	120Vac, 60 Hz	DETECTOR FUNCTION	Peak (PK) Average (AV)
ENVIRONMENTAL CONDITIONS	25deg. C, 65%RH	TESTED BY	Ted Chang

ANTENNA POLARITY & TEST DISTANCE: HORIZONTAL AT 3 M

NO.	FREQ. (MHz)	EMISSION LEVEL (dBuV/m)	LIMIT (dBuV/m)	MARGIN (dB)	ANTENNA HEIGHT (m)	TABLE ANGLE (Degree)	RAW VALUE (dBuV)	CORRECTION FACTOR (dB/m)
1	5150.00	57.5 PK	74.0	-16.5	1.00 H	214	53.70	3.80
2	5150.00	45.3 AV	54.0	-8.7	1.00 H	214	41.50	3.80
3	*5270.00	94.8 PK			1.64 H	221	56.90	37.90
4	*5270.00	84.5 AV			1.64 H	221	46.60	37.90
5	#10540.00	60.2 PK	74.0	-13.8	1.54 H	118	45.20	15.00
6	#10540.00	45.6 AV	54.0	-8.4	1.54 H	118	30.60	15.00

ANTENNA POLARITY & TEST DISTANCE: VERTICAL AT 3 M

NO.	FREQ. (MHz)	EMISSION LEVEL (dBuV/m)	LIMIT (dBuV/m)	MARGIN (dB)	ANTENNA HEIGHT (m)	TABLE ANGLE (Degree)	RAW VALUE (dBuV)	CORRECTION FACTOR (dB/m)
1	5150.00	57.0 PK	74.0	-17.0	1.00 V	214	53.20	3.80
2	5150.00	46.5 AV	54.0	-7.5	1.00 V	214	42.70	3.80
3	*5270.00	108.4 PK			1.00 V	179	70.50	37.90
4	*5270.00	97.6 AV			1.00 V	179	59.70	37.90
5	#10540.00	63.5 PK	74.0	-10.5	1.35 V	184	48.50	15.00
6	#10540.00	47.5 AV	54.0	-6.5	1.35 V	184	32.50	15.00

REMARKS:

1. Emission Level(dBuV/m) = Raw Value(dBuV) + Correction Factor(dB/m)
2. Correction Factor(dB/m) = Antenna Factor(dB/m) + Cable Factor(dB)
3. The other emission levels were very low against the limit.
4. Margin value = Emission Level – Limit value
5. " * ": Fundamental frequency.
6. " # ": The radiated frequency is out of the restricted band.

EUT TEST CONDITION		MEASUREMENT DETAIL	
CHANNEL	Channel 62	FREQUENCY RANGE	1 ~ 40GHz
INPUT POWER (SYSTEM)	120Vac, 60 Hz	DETECTOR FUNCTION	Peak (PK) Average (AV)
ENVIRONMENTAL CONDITIONS	25deg. C, 65%RH	TESTED BY	Ted Chang

ANTENNA POLARITY & TEST DISTANCE: HORIZONTAL AT 3 M

NO.	FREQ. (MHz)	EMISSION LEVEL (dBuV/m)	LIMIT (dBuV/m)	MARGIN (dB)	ANTENNA HEIGHT (m)	TABLE ANGLE (Degree)	RAW VALUE (dBuV)	CORRECTION FACTOR (dB/m)
1	*5310.00	95.0 PK			1.35 H	215	57.10	37.90
2	*5310.00	84.7 AV			1.35 H	215	46.80	37.90
3	5350.00	66.9 PK	74.0	-7.1	1.22 H	140	62.60	4.30
4	5350.00	51.9 AV	54.0	-2.1	1.22 H	140	47.60	4.30
5	10620.00	60.8 PK	74.0	-13.2	1.89 H	360	45.50	15.30
6	10620.00	45.8 AV	54.0	-8.2	1.89 H	360	30.50	15.30

ANTENNA POLARITY & TEST DISTANCE: VERTICAL AT 3 M

NO.	FREQ. (MHz)	EMISSION LEVEL (dBuV/m)	LIMIT (dBuV/m)	MARGIN (dB)	ANTENNA HEIGHT (m)	TABLE ANGLE (Degree)	RAW VALUE (dBuV)	CORRECTION FACTOR (dB/m)
1	*5310.00	105.5 PK			1.11 V	13	67.60	37.90
2	*5310.00	95.7 AV			1.11 V	13	57.80	37.90
3	5350.00	68.5 PK	74.0	-5.5	1.10 V	143	64.20	4.30
4	5350.00	52.5 AV	54.0	-1.5	1.10 V	143	48.20	4.30
5	10620.00	64.0 PK	74.0	-10.0	1.59 V	351	48.70	15.30
6	10620.00	48.9 AV	54.0	-5.1	1.59 V	351	33.60	15.30

REMARKS:

1. Emission Level(dBuV/m) = Raw Value(dBuV) + Correction Factor(dB/m)
2. Correction Factor(dB/m) = Antenna Factor(dB/m) + Cable Factor(dB)
3. The other emission levels were very low against the limit.
4. Margin value = Emission Level – Limit value
5. " * ": Fundamental frequency.

EUT TEST CONDITION		MEASUREMENT DETAIL	
CHANNEL	Channel 102	FREQUENCY RANGE	1 ~ 40GHz
INPUT POWER (SYSTEM)	120Vac, 60 Hz	DETECTOR FUNCTION	Peak (PK) Average (AV)
ENVIRONMENTAL CONDITIONS	25deg. C, 65%RH	TESTED BY	Ted Chang

ANTENNA POLARITY & TEST DISTANCE: HORIZONTAL AT 3 M

NO.	FREQ. (MHz)	EMISSION LEVEL (dBuV/m)	LIMIT (dBuV/m)	MARGIN (dB)	ANTENNA HEIGHT (m)	TABLE ANGLE (Degree)	RAW VALUE (dBuV)	CORRECTION FACTOR (dB/m)
1	5460.00	55.7 PK	74.0	-18.3	1.00 H	154	51.20	4.50
2	5460.00	41.9 AV	54.0	-12.1	1.00 H	154	37.40	4.50
3	#5470.00	58.1 PK	74.0	-15.9	1.04 H	154	53.70	4.40
4	#5470.00	44.7 AV	54.0	-9.3	1.04 H	154	40.30	4.40
5	*5510.00	94.8 PK			1.00 H	221	56.50	38.30
6	*5510.00	84.1 AV			1.00 H	221	45.80	38.30
7	11020.00	61.6 PK	74.0	-12.4	1.04 H	184	45.60	16.00
8	11020.00	46.5 AV	54.0	-7.5	1.04 H	184	30.50	16.00

ANTENNA POLARITY & TEST DISTANCE: VERTICAL AT 3 M

NO.	FREQ. (MHz)	EMISSION LEVEL (dBuV/m)	LIMIT (dBuV/m)	MARGIN (dB)	ANTENNA HEIGHT (m)	TABLE ANGLE (Degree)	RAW VALUE (dBuV)	CORRECTION FACTOR (dB/m)
1	5460.00	58.9 PK	74.0	-15.1	1.15 V	29	54.40	4.50
2	5460.00	42.5 AV	54.0	-11.5	1.15 V	29	38.00	4.50
3	#5470.00	69.9 PK	74.0	-4.1	1.15 V	29	65.50	4.40
4	#5470.00	52.5 AV	54.0	-1.5	1.15 V	29	48.10	4.40
5	*5510.00	108.7 PK			1.05 V	347	70.40	38.30
6	*5510.00	98.1 AV			1.05 V	347	59.80	38.30
7	11020.00	64.2 PK	74.0	-9.8	1.59 V	235	48.20	16.00
8	11020.00	48.7 AV	54.0	-5.3	1.59 V	235	32.70	16.00

REMARKS:

1. Emission Level(dBuV/m) = Raw Value(dBuV) + Correction Factor(dB/m)
2. Correction Factor(dB/m) = Antenna Factor(dB/m) + Cable Factor(dB)
3. The other emission levels were very low against the limit.
4. Margin value = Emission Level – Limit value
5. " * ": Fundamental frequency.
6. " # ": The radiated frequency is out of the restricted band.

EUT TEST CONDITION		MEASUREMENT DETAIL	
CHANNEL	Channel 110	FREQUENCY RANGE	1 ~ 40GHz
INPUT POWER (SYSTEM)	120Vac, 60 Hz	DETECTOR FUNCTION	Peak (PK) Average (AV)
ENVIRONMENTAL CONDITIONS	25deg. C, 65%RH	TESTED BY	Ted Chang

ANTENNA POLARITY & TEST DISTANCE: HORIZONTAL AT 3 M								
NO.	FREQ. (MHz)	EMISSION LEVEL (dBuV/m)	LIMIT (dBuV/m)	MARGIN (dB)	ANTENNA HEIGHT (m)	TABLE ANGLE (Degree)	RAW VALUE (dBuV)	CORRECTION FACTOR (dB/m)
1	*5550.00	94.7 PK			1.00 H	223	56.30	38.40
2	*5550.00	84.0 AV			1.00 H	223	45.60	38.40
3	11100.00	64.6 PK	74.0	-9.4	1.47 H	258	48.60	16.00
4	11100.00	46.5 AV	54.0	-7.5	1.47 H	258	30.50	16.00
ANTENNA POLARITY & TEST DISTANCE: VERTICAL AT 3 M								
NO.	FREQ. (MHz)	EMISSION LEVEL (dBuV/m)	LIMIT (dBuV/m)	MARGIN (dB)	ANTENNA HEIGHT (m)	TABLE ANGLE (Degree)	RAW VALUE (dBuV)	CORRECTION FACTOR (dB/m)
1	*5550.00	108.1 PK			1.33 V	174	69.70	38.40
2	*5550.00	97.7 AV			1.33 V	174	59.30	38.40
3	11100.00	63.8 PK	74.0	-10.2	1.53 V	214	47.80	16.00
4	11100.00	49.6 AV	54.0	-4.4	1.53 V	214	33.60	16.00

REMARKS:

1. Emission Level(dBuV/m) = Raw Value(dBuV) + Correction Factor(dB/m)
2. Correction Factor(dB/m) = Antenna Factor(dB/m) + Cable Factor(dB)
3. The other emission levels were very low against the limit.
4. Margin value = Emission Level – Limit value
5. " * ": Fundamental frequency.

EUT TEST CONDITION		MEASUREMENT DETAIL	
CHANNEL	Channel 134	FREQUENCY RANGE	1 ~ 40GHz
INPUT POWER (SYSTEM)	120Vac, 60 Hz	DETECTOR FUNCTION	Peak (PK) Average (AV)
ENVIRONMENTAL CONDITIONS	25deg. C, 65%RH	TESTED BY	Ted Chang

ANTENNA POLARITY & TEST DISTANCE: HORIZONTAL AT 3 M

NO.	FREQ. (MHz)	EMISSION LEVEL (dBuV/m)	LIMIT (dBuV/m)	MARGIN (dB)	ANTENNA HEIGHT (m)	TABLE ANGLE (Degree)	RAW VALUE (dBuV)	CORRECTION FACTOR (dB/m)
1	*5670.00	93.9 PK			1.00 H	147	55.30	38.60
2	*5670.00	83.8 AV			1.00 H	147	45.20	38.60
3	#5725.00	57.3 PK	74.0	-16.7	1.04 H	154	18.60	38.70
4	#5725.00	44.3 AV	54.0	-9.7	1.04 H	154	5.60	38.70
5	11340.00	62.3 PK	74.0	-11.7	1.00 H	241	46.50	15.80
6	11340.00	47.3 AV	54.0	-6.7	1.00 H	241	31.50	15.80

ANTENNA POLARITY & TEST DISTANCE: VERTICAL AT 3 M

NO.	FREQ. (MHz)	EMISSION LEVEL (dBuV/m)	LIMIT (dBuV/m)	MARGIN (dB)	ANTENNA HEIGHT (m)	TABLE ANGLE (Degree)	RAW VALUE (dBuV)	CORRECTION FACTOR (dB/m)
1	*5670.00	107.7 PK			1.21 V	350	69.10	38.60
2	*5670.00	97.2 AV			1.21 V	350	58.60	38.60
3	#5725.00	60.1 PK	74.0	-13.9	1.09 V	309	55.30	4.80
4	#5725.00	46.4 AV	54.0	-7.6	1.09 V	309	41.60	4.80
5	11340.00	63.6 PK	74.0	-10.4	1.00 V	125	47.80	15.80
6	11340.00	49.2 AV	54.0	-4.8	1.00 V	125	33.40	15.80

REMARKS:

1. Emission Level(dBuV/m) = Raw Value(dBuV) + Correction Factor(dB/m)
2. Correction Factor(dB/m) = Antenna Factor(dB/m) + Cable Factor(dB)
3. The other emission levels were very low against the limit.
4. Margin value = Emission Level – Limit value
5. " * ": Fundamental frequency.
6. " # ": The radiated frequency is out of the restricted band.

EUT TEST CONDITION		MEASUREMENT DETAIL	
CHANNEL	Channel 151	FREQUENCY RANGE	1 ~ 40GHz
INPUT POWER (SYSTEM)	120Vac, 60 Hz	DETECTOR FUNCTION	Peak (PK) Average (AV)
ENVIRONMENTAL CONDITIONS	25deg. C, 65%RH	TESTED BY	Chris Lin

ANTENNA POLARITY & TEST DISTANCE: HORIZONTAL AT 3 M

NO.	FREQ. (MHz)	EMISSION LEVEL (dBuV/m)	LIMIT (dBuV/m)	MARGIN (dB)	ANTENNA HEIGHT (m)	TABLE ANGLE (Degree)	RAW VALUE (dBuV)	CORRECTION FACTOR (dB/m)
1	#5714.00	48.2 PK	74.0	-25.8	1.25 H	78	41.90	6.30
2	#5714.00	45.3 AV	54.0	-8.7	1.25 H	78	39.00	6.30
3	#5722.00	59.3 PK	78.2	-18.9	1.55 H	201	53.00	6.30
4	#5725.00	50.9 PK	78.2	-27.3	1.30 H	98	44.60	6.30
5	*5755.00	91.2 PK			1.19 H	324	50.90	40.30
6	*5755.00	81.1 AV			1.19 H	324	40.80	40.30
7	11510.00	57.3 PK	74.0	-16.7	1.39 H	87	40.20	17.10
8	11510.00	44.5 AV	54.0	-9.5	1.39 H	87	27.40	17.10

ANTENNA POLARITY & TEST DISTANCE: VERTICAL AT 3 M

NO.	FREQ. (MHz)	EMISSION LEVEL (dBuV/m)	LIMIT (dBuV/m)	MARGIN (dB)	ANTENNA HEIGHT (m)	TABLE ANGLE (Degree)	RAW VALUE (dBuV)	CORRECTION FACTOR (dB/m)
1	#5714.00	64.2 PK	74.0	-9.8	1.10 V	45	57.90	6.30
2	#5714.00	49.3 AV	54.0	-4.7	1.10 V	45	43.00	6.30
3	#5722.00	71.6 PK	78.2	-6.6	1.10 V	49	65.30	6.30
4	#5725.00	61.2 PK	78.2	-17.0	1.33 V	105	54.90	6.30
5	*5755.00	105.4 PK			1.01 V	39	65.10	40.30
6	*5755.00	96.1 AV			1.01 V	39	55.80	40.30
7	11510.00	60.0 PK	74.0	-14.0	1.36 V	97	42.90	17.10
8	11510.00	45.1 AV	54.0	-8.9	1.36 V	97	28.00	17.10

REMARKS:

1. Emission Level(dBuV/m) = Raw Value(dBuV) + Correction Factor(dB/m)
2. Correction Factor(dB/m) = Antenna Factor(dB/m) + Cable Factor(dB)
3. The other emission levels were very low against the limit.
4. Margin value = Emission Level – Limit value
5. " * ": Fundamental frequency.
6. " # ": The radiated frequency is out of the restricted band.



EUT TEST CONDITION		MEASUREMENT DETAIL	
CHANNEL	Channel 159	FREQUENCY RANGE	1 ~ 40GHz
INPUT POWER (SYSTEM)	120Vac, 60 Hz	DETECTOR FUNCTION	Peak (PK) Average (AV)
ENVIRONMENTAL CONDITIONS	25deg. C, 65%RH	TESTED BY	Chris Lin

ANTENNA POLARITY & TEST DISTANCE: HORIZONTAL AT 3 M

NO.	FREQ. (MHz)	EMISSION LEVEL (dBuV/m)	LIMIT (dBuV/m)	MARGIN (dB)	ANTENNA HEIGHT (m)	TABLE ANGLE (Degree)	RAW VALUE (dBuV)	CORRECTION FACTOR (dB/m)
1	*5795.00	93.1 PK			1.00 H	321	52.70	40.40
2	*5795.00	82.7 AV			1.00 H	321	42.30	40.40
3	#5850.00	43.5 PK	78.2	-34.7	1.39 H	229	36.90	6.60
4	#5853.00	47.8 PK	78.2	-30.4	1.08 H	74	41.20	6.60
5	#5861.00	57.2 PK	74.0	-16.8	1.10 H	330	50.60	6.60
6	#5861.00	44.5 AV	54.0	-9.5	1.10 H	330	37.90	6.60
7	11590.00	58.7 PK	74.0	-15.3	1.32 H	85	41.50	17.20
8	11590.00	44.2 AV	54.0	-9.8	1.32 H	85	27.00	17.20

ANTENNA POLARITY & TEST DISTANCE: VERTICAL AT 3 M

NO.	FREQ. (MHz)	EMISSION LEVEL (dBuV/m)	LIMIT (dBuV/m)	MARGIN (dB)	ANTENNA HEIGHT (m)	TABLE ANGLE (Degree)	RAW VALUE (dBuV)	CORRECTION FACTOR (dB/m)
1	*5795.00	106.2 PK			1.30 V	330	65.80	40.40
2	*5795.00	95.4 AV			1.30 V	330	55.00	40.40
3	#5850.00	53.5 PK	78.2	-24.7	1.28 V	310	46.90	6.60
4	#5853.00	47.3 PK	78.2	-30.9	1.20 V	310	40.70	6.60
5	#5861.00	58.5 PK	74.0	-15.5	1.35 V	320	51.90	6.60
6	#5861.00	46.5 AV	54.0	-7.5	1.35 V	320	39.90	6.60
7	11590.00	58.2 PK	74.0	-15.8	1.33 V	54	41.00	17.20
8	11590.00	44.6 AV	54.0	-9.4	1.33 V	54	27.40	17.20

REMARKS:

1. Emission Level(dBuV/m) = Raw Value(dBuV) + Correction Factor(dB/m)
2. Correction Factor(dB/m) = Antenna Factor(dB/m) + Cable Factor(dB)
3. The other emission levels were very low against the limit.
4. Margin value = Emission Level – Limit value
5. " * ": Fundamental frequency.
6. " # ": The radiated frequency is out of the restricted band.

BELOW 1GHz WORST-CASE DATA :
802.11n (HT20)

EUT TEST CONDITION		MEASUREMENT DETAIL	
CHANNEL	Channel 60	FREQUENCY RANGE	Below 1000MHz
INPUT POWER (SYSTEM)	120Vac, 60 Hz	DETECTOR FUNCTION	Quasi-Peak
ENVIRONMENTAL CONDITIONS	25deg. C, 65%RH	TESTED BY	Ted Chang

ANTENNA POLARITY & TEST DISTANCE: HORIZONTAL AT 3 M

NO.	FREQ. (MHz)	EMISSION LEVEL (dBuV/m)	LIMIT (dBuV/m)	MARGIN (dB)	ANTENNA HEIGHT (m)	TABLE ANGLE (Degree)	RAW VALUE (dBuV)	CORRECTION FACTOR (dB/m)
1	57.12	26.1 QP	40.0	-13.9	1.24 H	305	40.70	-14.60
2	99.89	30.1 QP	43.5	-13.4	1.00 H	208	48.50	-18.40
3	199.05	38.0 QP	43.5	-5.5	1.24 H	29	54.60	-16.60
4	265.16	40.3 QP	46.0	-5.7	1.00 H	96	53.80	-13.50
5	500.42	26.9 QP	46.0	-19.1	1.50 H	231	35.20	-8.30
6	599.58	32.1 QP	46.0	-13.9	1.00 H	119	38.30	-6.20

ANTENNA POLARITY & TEST DISTANCE: VERTICAL AT 3 M

NO.	FREQ. (MHz)	EMISSION LEVEL (dBuV/m)	LIMIT (dBuV/m)	MARGIN (dB)	ANTENNA HEIGHT (m)	TABLE ANGLE (Degree)	RAW VALUE (dBuV)	CORRECTION FACTOR (dB/m)
1	57.12	28.0 QP	40.0	-12.0	1.00 V	352	42.60	-14.60
2	99.89	31.8 QP	43.5	-11.7	1.99 V	145	50.20	-18.40
3	199.05	28.6 QP	43.5	-14.9	1.00 V	318	45.20	-16.60
4	298.21	27.2 QP	46.0	-18.8	1.50 V	125	39.50	-12.30
5	498.47	36.8 QP	46.0	-9.2	1.00 V	127	45.10	-8.30
6	599.58	28.6 QP	46.0	-17.4	1.24 V	249	34.80	-6.20

REMARKS:

1. Emission Level(dBuV/m) = Raw Value(dBuV) + Correction Factor(dB/m)
2. Correction Factor(dB/m) = Antenna Factor(dB/m) + Cable Factor(dB)
3. The other emission levels were very low against the limit.
4. Margin value = Emission Level – Limit value

EUT TEST CONDITION		MEASUREMENT DETAIL	
CHANNEL	Channel 140	FREQUENCY RANGE	Below 1000MHz
INPUT POWER (SYSTEM)	120Vac, 60 Hz	DETECTOR FUNCTION	Quasi-Peak
ENVIRONMENTAL CONDITIONS	25deg. C, 65%RH	TESTED BY	Ted Chang

ANTENNA POLARITY & TEST DISTANCE: HORIZONTAL AT 3 M								
NO.	FREQ. (MHz)	EMISSION LEVEL (dBuV/m)	LIMIT (dBuV/m)	MARGIN (dB)	ANTENNA HEIGHT (m)	TABLE ANGLE (Degree)	RAW VALUE (dBuV)	CORRECTION FACTOR (dB/m)
1	57.12	26.7 QP	40.0	-13.3	1.00 H	18	41.30	-14.60
2	97.95	29.5 QP	43.5	-14.0	1.99 H	212	48.30	-18.80
3	166.00	35.4 QP	43.5	-8.1	1.00 H	54	49.70	-14.30
4	199.05	38.0 QP	43.5	-5.5	1.24 H	27	54.60	-16.60
5	265.16	40.7 QP	46.0	-5.3	1.50 H	96	54.20	-13.50
6	498.47	28.5 QP	46.0	-17.5	1.00 H	229	36.80	-8.30
ANTENNA POLARITY & TEST DISTANCE: VERTICAL AT 3 M								
NO.	FREQ. (MHz)	EMISSION LEVEL (dBuV/m)	LIMIT (dBuV/m)	MARGIN (dB)	ANTENNA HEIGHT (m)	TABLE ANGLE (Degree)	RAW VALUE (dBuV)	CORRECTION FACTOR (dB/m)
1	99.89	31.5 QP	43.5	-12.0	1.99 V	174	49.90	-18.40
2	199.05	28.2 QP	43.5	-15.3	1.00 V	311	44.80	-16.60
3	265.16	27.4 QP	46.0	-18.6	1.24 V	6	40.90	-13.50
4	500.42	37.3 QP	46.0	-8.7	1.24 V	124	45.60	-8.30
5	599.58	28.5 QP	46.0	-17.5	1.00 V	126	34.70	-6.20
6	809.56	26.1 QP	46.0	-19.9	1.00 V	319	28.20	-2.10

REMARKS:

1. Emission Level(dBuV/m) = Raw Value(dBuV) + Correction Factor(dB/m)
2. Correction Factor(dB/m) = Antenna Factor(dB/m) + Cable Factor(dB)
3. The other emission levels were very low against the limit.
4. Margin value = Emission Level – Limit value



EUT TEST CONDITION		MEASUREMENT DETAIL	
CHANNEL	Channel 149	FREQUENCY RANGE	Below 1000MHz
INPUT POWER (SYSTEM)	120Vac, 60 Hz	DETECTOR FUNCTION	Quasi-Peak
ENVIRONMENTAL CONDITIONS	25deg. C, 65%RH	TESTED BY	Ted Chang

ANTENNA POLARITY & TEST DISTANCE: HORIZONTAL AT 3 M								
NO.	FREQ. (MHz)	EMISSION LEVEL (dBuV/m)	LIMIT (dBuV/m)	MARGIN (dB)	ANTENNA HEIGHT (m)	TABLE ANGLE (Degree)	RAW VALUE (dBuV)	CORRECTION FACTOR (dB/m)
1	99.89	29.5 QP	43.5	-14.0	1.24 H	211	47.90	-18.40
2	166.00	35.2 QP	43.5	-8.3	1.00 H	68	49.50	-14.30
3	199.05	37.7 QP	43.5	-5.8	1.50 H	39	54.30	-16.60
4	265.16	40.0 QP	46.0	-6.0	1.50 H	110	53.50	-13.50
5	500.42	27.6 QP	46.0	-18.4	1.00 H	234	35.90	-8.30
6	599.58	33.4 QP	46.0	-12.6	1.00 H	117	39.60	-6.20

ANTENNA POLARITY & TEST DISTANCE: VERTICAL AT 3 M								
NO.	FREQ. (MHz)	EMISSION LEVEL (dBuV/m)	LIMIT (dBuV/m)	MARGIN (dB)	ANTENNA HEIGHT (m)	TABLE ANGLE (Degree)	RAW VALUE (dBuV)	CORRECTION FACTOR (dB/m)
1	99.89	31.6 QP	43.5	-11.9	1.50 V	157	50.00	-18.40
2	199.05	28.5 QP	43.5	-15.0	1.24 V	348	45.10	-16.60
3	265.16	27.5 QP	46.0	-18.5	1.00 V	13	41.00	-13.50
4	498.47	36.8 QP	46.0	-9.2	1.99 V	125	45.10	-8.30
5	599.58	26.7 QP	46.0	-19.3	1.00 V	115	32.90	-6.20
6	794.01	26.5 QP	46.0	-19.5	1.00 V	306	28.90	-2.40

REMARKS:

1. Emission Level(dBuV/m) = Raw Value(dBuV) + Correction Factor(dB/m)
2. Correction Factor(dB/m) = Antenna Factor(dB/m) + Cable Factor(dB)
3. The other emission levels were very low against the limit.
4. Margin value = Emission Level – Limit value

4.2 Conducted Emission Measurement

4.2.1 Limits of Conducted Emission Measurement

Frequency (MHz)	Conducted Limit (dBuV)	
	Quasi-peak	Average
0.15 - 0.5	66 - 56	56 - 46
0.50 - 5.0	56	46
5.0 - 30.0	60	50

Note: 1. The lower limit shall apply at the transition frequencies.

2. The limit decreases in line with the logarithm of the frequency in the range of 0.15 to 0.50MHz.

4.2.2 Test Instruments

For Tested Date: Jul. 11 ~ Jul. 12, 2013

Description & Manufacturer	Model No.	Serial No.	Date Of Calibration	Due Date Of Calibration
Test Receiver ROHDE & SCHWARZ	ESCS30	100288	Nov. 09, 2012	Nov. 08, 2013
RF signal cable Woken	5D-FB	Cable-HYCO2-01	Dec. 28, 2012	Dec. 27, 2013
LISN ROHDE & SCHWARZ (EUT)	ESH2-Z5	100100	Dec. 21, 2012	Dec. 20, 2013
LISN ROHDE & SCHWARZ (Peripheral)	ESH3-Z5	100312	Jul. 02, 2013	Jul. 01, 2014
Software ADT	BV ADT_Cond_ V7.3.7.3	NA	NA	NA

NOTE: 1. The calibration interval of the above test instruments is 12 months and the calibrations are traceable to NML/ROC and NIST/USA.

2. The test was performed in HwaYa Shielded Room 1.

3. The VCCI Site Registration No. is C-2040.

4.2.3 Test Procedure

- a. The EUT was placed 0.4 meters from the conducting wall of the shielded room with EUT being connected to the power mains through a line impedance stabilization network (LISN). Other support units were connected to the power mains through another LISN. The two LISNs provide 50 ohm/ 50uH of coupling impedance for the measuring instrument.
- b. Both lines of the power mains connected to the EUT were checked for maximum conducted interference.
- c. The frequency range from 150kHz to 30MHz was searched. Emission levels under (Limit - 20dB) was not recorded.

NOTE: The resolution bandwidth and video bandwidth of test receiver is 9kHz for quasi-peak detection (QP) and average detection (AV) at frequency 0.15MHz-30MHz.

4.2.4 Deviation from Test Standard

No deviation.

4.2.5 Test Setup

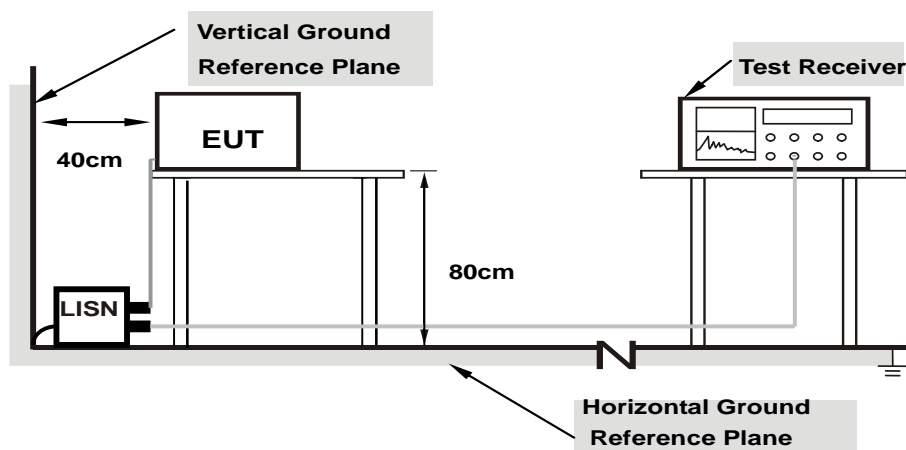

- Note:**
- 1.Support units were connected to second LISN.
 - 2.Both of LISNs (AMN) are 80 cm from EUT and at least 80 from other units and other metal planes

For the actual test configuration, please refer to the attached file (Test Setup Photo).

4.2.6 EUT Operating Conditions

Same as 4.1.6.

4.2.7 Test Results

802.11n (HT20)

PHASE	Line 1	6dB BANDWIDTH	9kHz
CHANNEL	Channel 60		

No	Freq. [MHz]	Corr. Factor (dB)	Reading Value [dB (uV)]		Emission Level [dB (uV)]		Limit [dB (uV)]		Margin (dB)	
			Q.P.	AV.	Q.P.	AV.	Q.P.	AV.	Q.P.	AV.
1	0.16172	0.17	36.01	19.26	36.18	19.43	65.38	55.38	-29.19	-35.94
2	0.29844	0.19	38.44	26.53	38.63	26.72	60.29	50.29	-21.66	-23.57
3	0.83750	0.25	30.94	26.26	31.19	26.51	56.00	46.00	-24.81	-19.49
4	3.41797	0.34	26.24	14.15	26.58	14.49	56.00	46.00	-29.42	-31.51
5	15.94141	0.55	25.62	20.38	26.17	20.93	60.00	50.00	-33.83	-29.07
6	23.23047	0.61	23.11	17.85	23.72	18.46	60.00	50.00	-36.28	-31.54

REMARKS:

1. Q.P. and AV. are abbreviations of quasi-peak and average individually.
2. The emission levels of other frequencies were very low against the limit.
3. Margin value = Emission level - Limit value
4. Correction factor = Insertion loss + Cable loss
5. Emission Level = Correction Factor + Reading Value

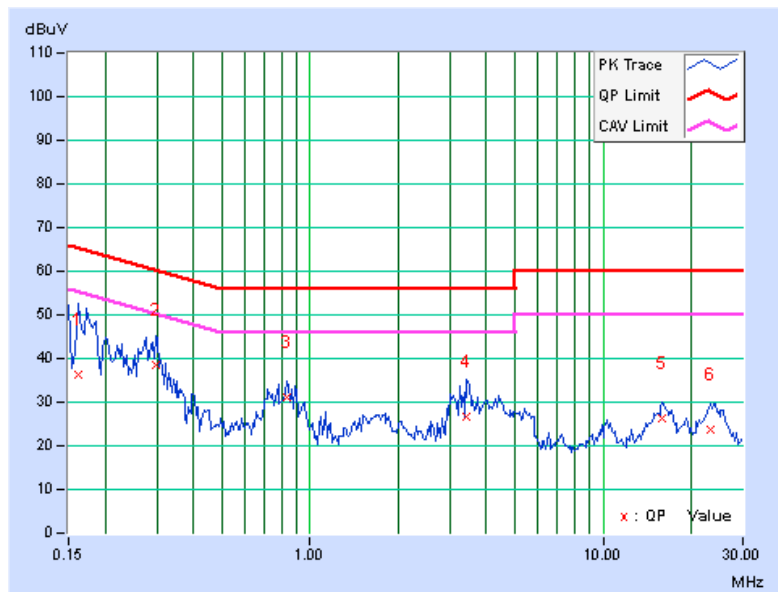

PHASE	Line 2	6dB BANDWIDTH	9kHz
CHANNEL	Channel 60		

No	Freq. [MHz]	Corr. Factor (dB)	Reading Value [dB (uV)]		Emission Level [dB (uV)]		Limit [dB (uV)]		Margin (dB)	
			Q.P.	AV.	Q.P.	AV.	Q.P.	AV.	Q.P.	AV.
1	0.18125	0.18	43.45	28.77	43.63	28.95	64.43	54.43	-20.80	-25.48
2	0.27500	0.21	35.35	24.53	35.56	24.74	60.97	50.97	-25.41	-26.23
3	0.30625	0.22	39.47	31.35	39.69	31.57	60.07	50.07	-20.38	-18.50
4	0.83359	0.24	29.44	23.84	29.68	24.08	56.00	46.00	-26.32	-21.92
5	3.45313	0.36	25.50	13.88	25.86	14.24	56.00	46.00	-30.14	-31.76
6	16.12500	0.63	25.84	20.68	26.47	21.31	60.00	50.00	-33.53	-28.69

REMARKS:

1. Q.P. and AV. are abbreviations of quasi-peak and average individually.
2. The emission levels of other frequencies were very low against the limit.
3. Margin value = Emission level - Limit value
4. Correction factor = Insertion loss + Cable loss
5. Emission Level = Correction Factor + Reading Value

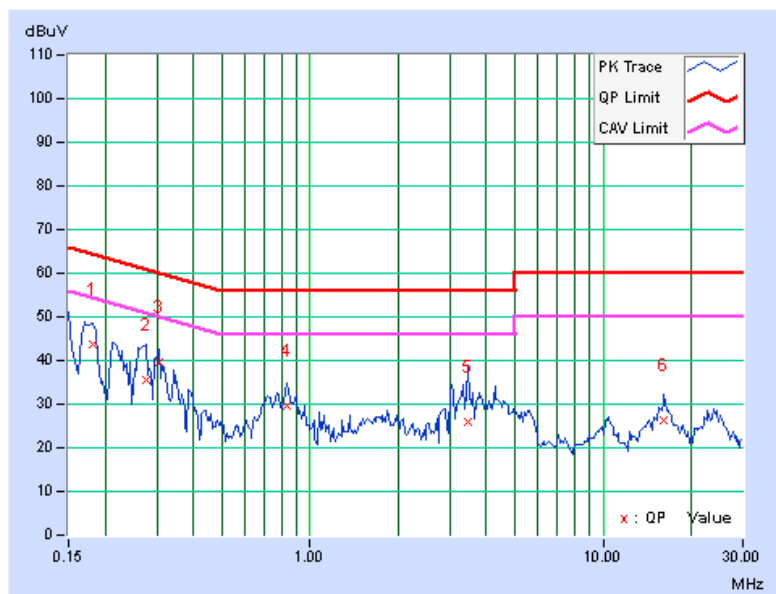

PHASE	Line 1	6dB BANDWIDTH	9kHz
CHANNEL	Channel 140		

No	Freq. [MHz]	Corr. Factor (dB)	Reading Value [dB (uV)]		Emission Level [dB (uV)]		Limit [dB (uV)]		Margin (dB)	
			Q.P.	AV.	Q.P.	AV.	Q.P.	AV.	Q.P.	AV.
1	0.18125	0.17	42.76	29.88	42.93	30.05	64.43	54.43	-21.50	-24.38
2	0.29844	0.19	40.98	30.90	41.17	31.09	60.29	50.29	-19.12	-19.20
3	0.83359	0.25	30.17	24.74	30.42	24.99	56.00	46.00	-25.58	-21.01
4	3.43359	0.34	24.01	11.79	24.35	12.13	56.00	46.00	-31.65	-33.87
5	4.47266	0.37	24.49	13.42	24.86	13.79	56.00	46.00	-31.14	-32.21
6	16.25391	0.56	25.03	19.44	25.59	20.00	60.00	50.00	-34.41	-30.00

REMARKS:

1. Q.P. and AV. are abbreviations of quasi-peak and average individually.
2. The emission levels of other frequencies were very low against the limit.
3. Margin value = Emission level - Limit value
4. Correction factor = Insertion loss + Cable loss
5. Emission Level = Correction Factor + Reading Value

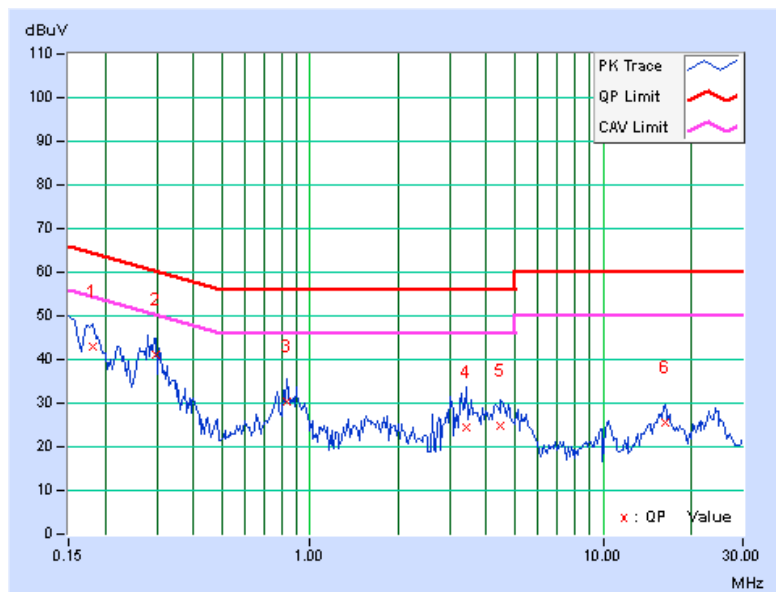

PHASE	Line 2	6dB BANDWIDTH	9kHz
CHANNEL	Channel 140		

No	Freq. [MHz]	Corr. Factor (dB)	Reading Value [dB (uV)]		Emission Level [dB (uV)]		Limit [dB (uV)]		Margin (dB)	
			Q.P.	AV.	Q.P.	AV.	Q.P.	AV.	Q.P.	AV.
1	0.16172	0.18	42.16	23.14	42.34	23.32	65.38	55.38	-23.03	-32.05
2	0.29844	0.21	40.18	31.05	40.39	31.26	60.29	50.29	-19.89	-19.02
3	0.83359	0.24	31.01	25.15	31.25	25.39	56.00	46.00	-24.75	-20.61
4	3.33984	0.35	24.51	12.26	24.86	12.61	56.00	46.00	-31.14	-33.39
5	4.40234	0.40	24.53	13.44	24.93	13.84	56.00	46.00	-31.07	-32.16
6	15.66406	0.62	25.31	20.36	25.93	20.98	60.00	50.00	-34.07	-29.02

REMARKS:

1. Q.P. and AV. are abbreviations of quasi-peak and average individually.
2. The emission levels of other frequencies were very low against the limit.
3. Margin value = Emission level - Limit value
4. Correction factor = Insertion loss + Cable loss
5. Emission Level = Correction Factor + Reading Value

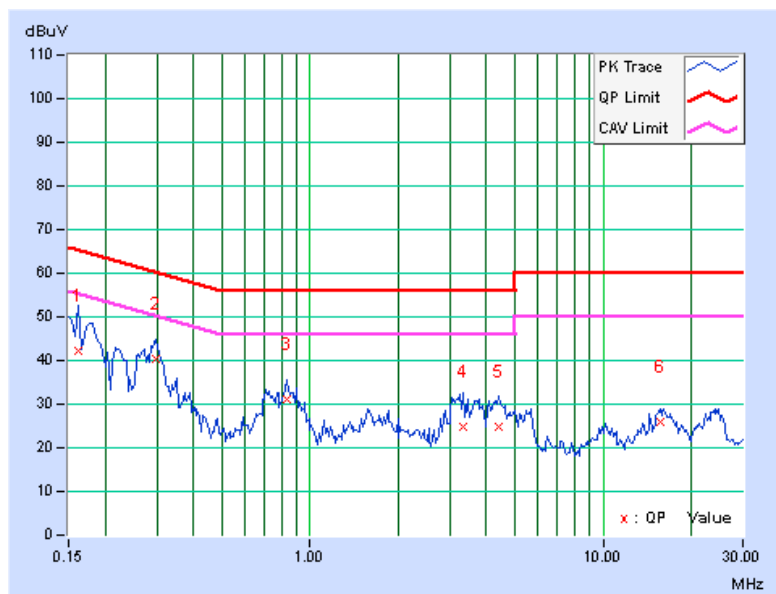

PHASE	Line 1	6dB BANDWIDTH	9kHz
CHANNEL	Channel 149		

No	Freq. [MHz]	Corr. Factor (dB)	Reading Value [dB (uV)]		Emission Level [dB (uV)]		Limit [dB (uV)]		Margin (dB)	
			Q.P.	AV.	Q.P.	AV.	Q.P.	AV.	Q.P.	AV.
			1	0.16562	0.17	43.89	35.01	44.06	35.18	65.18
2	0.29844	0.19	41.76	34.26	41.95	34.45	60.29	50.29	-18.34	-15.84
3	0.83359	0.25	32.31	26.35	32.56	26.60	56.00	46.00	-23.44	-19.40
4	3.48828	0.35	19.13	10.25	19.48	10.60	56.00	46.00	-36.52	-35.40
5	4.25781	0.37	23.22	11.89	23.59	12.26	56.00	46.00	-32.41	-33.74
6	24.55859	0.60	21.39	15.62	21.99	16.22	60.00	50.00	-38.01	-33.78

REMARKS:

1. Q.P. and AV. are abbreviations of quasi-peak and average individually.
2. The emission levels of other frequencies were very low against the limit.
3. Margin value = Emission level - Limit value
4. Correction factor = Insertion loss + Cable loss
5. Emission Level = Correction Factor + Reading Value

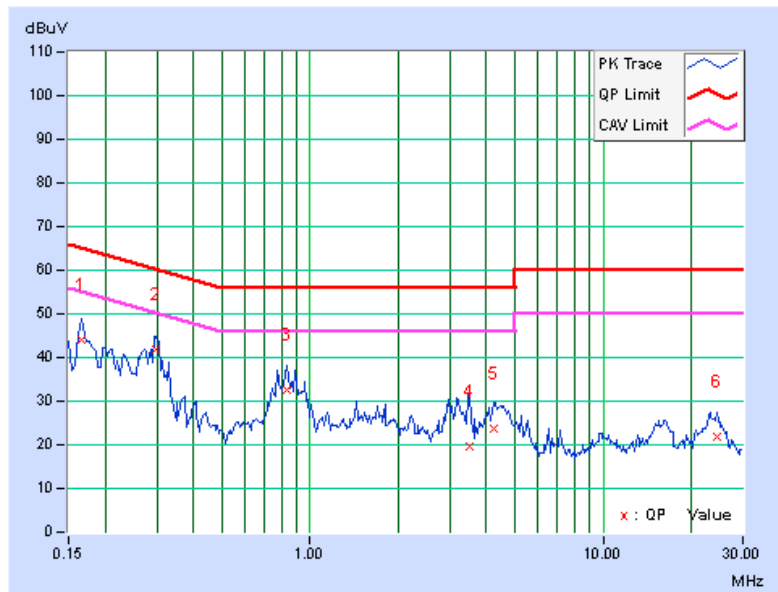

PHASE	Line 2	6dB BANDWIDTH	9kHz
CHANNEL	Channel 149		

No	Freq. [MHz]	Corr. Factor (dB)	Reading Value [dB (uV)]		Emission Level [dB (uV)]		Limit [dB (uV)]		Margin (dB)	
			Q.P.	AV.	Q.P.	AV.	Q.P.	AV.	Q.P.	AV.
1	0.16562	0.18	44.29	35.23	44.47	35.41	65.18	55.18	-20.70	-19.76
2	0.29844	0.21	42.11	34.85	42.32	35.06	60.29	50.29	-17.96	-15.22
3	0.83359	0.24	33.41	27.54	33.65	27.78	56.00	46.00	-22.35	-18.22
4	3.14844	0.34	20.85	8.26	21.19	8.60	56.00	46.00	-34.81	-37.40
5	4.28125	0.39	23.37	12.33	23.76	12.72	56.00	46.00	-32.24	-33.28
6	23.40234	0.70	21.13	15.61	21.83	16.31	60.00	50.00	-38.17	-33.69

REMARKS:

1. Q.P. and AV. are abbreviations of quasi-peak and average individually.
2. The emission levels of other frequencies were very low against the limit.
3. Margin value = Emission level - Limit value
4. Correction factor = Insertion loss + Cable loss
5. Emission Level = Correction Factor + Reading Value

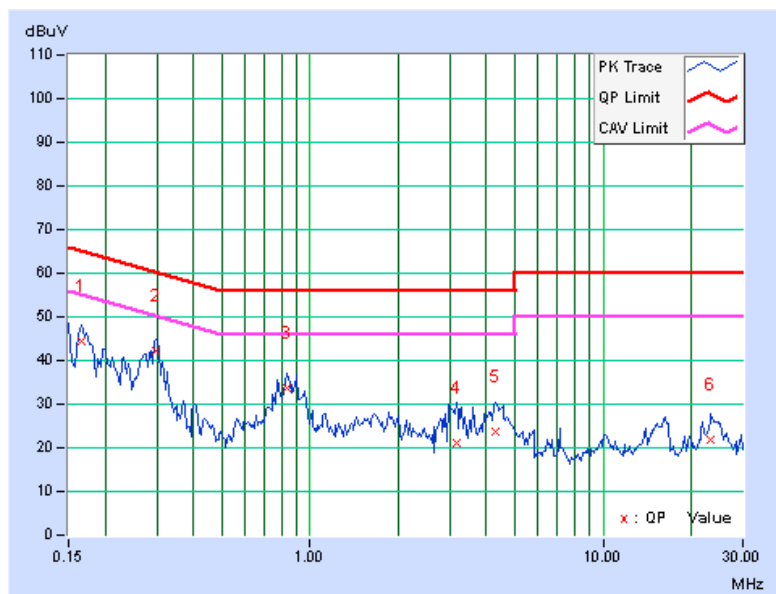

4.3 Transmit Power Measurement

4.3.1 Limits of Transmit Power Measurement

Operation Band	EUT Category		LIMIT
U-NII-1		Outdoor Access Point	1 Watt (30 dBm) (Max. e.i.r.p \leq 125mW(21 dBm) at any elevation angle above 30 degrees as measured from the horizon)
		Fixed point-to-point Access Point	1 Watt (30 dBm)
	√	Indoor Access Point	1 Watt (30 dBm)
		Mobile and Portable client device	250mW (24 dBm)
U-NII-2A		√	250mW (24 dBm) or 11 dBm+10 log B*
U-NII-2C		√	250mW (24 dBm) or 11 dBm+10 log B*
U-NII-3		√	1 Watt (30 dBm)

*B is the 26 dB emission bandwidth in megahertz

Per KDB 662911 Method of conducted output power measurement on IEEE 802.11 devices,

Array Gain = 0 dB (i.e., no array gain) for $N_{ANT} \leq 4$;

Array Gain = 0 dB (i.e., no array gain) for channel widths ≥ 40 MHz for any N_{ANT} ;

Array Gain = $5 \log(N_{ANT}/N_{SS})$ dB or 3 dB, whichever is less for 20-MHz channel widths with $N_{ANT} \geq 5$.

For power measurements on all other devices: Array Gain = $10 \log(N_{ANT}/N_{SS})$ dB.

4.3.2 Test Setup

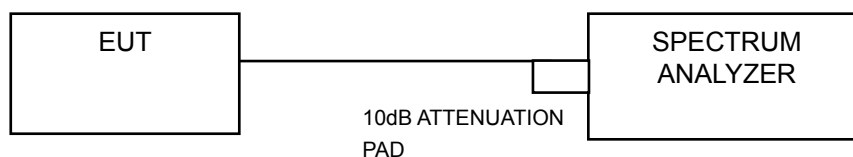
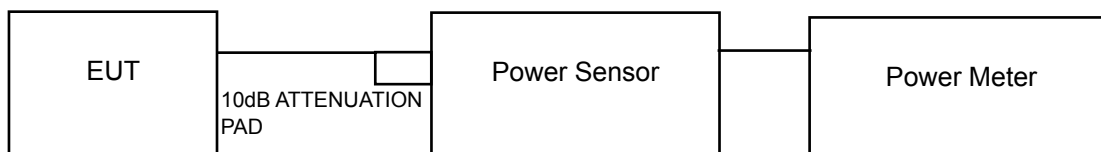

4.3.3 Test Instruments

Refer to section 4.1.2 to get information of above instrument.

4.3.4 Test Procedure

FOR AVERAGE POWER MEASUREMENT

Method PM is used to perform output power measurement, trigger and gating function of wide band power meter is enabled to measure max output power of TX on burst. Duty factor is not added to measured value.

4.3.5 Deviation from Test Standard

No deviation.

4.3.6 EUT Operating Conditions

The software provided by client to enable the EUT under transmission Condition continuously at lowest, middle and highest channel frequencies individually.

4.3.7 Test Result

POWER OUTPUT:

802.11a

Channel	Frequency (MHz)	Maximum Conducted Power (mW)	Maximum Conducted Power (dBm)	Power Limit (dBm)	Pass / Fail
36	5180	25.003	13.98	30	Pass
40	5200	22.131	13.45	30	Pass
48	5240	23.768	13.76	30	Pass
52	5260	23.227	13.66	24	Pass
60	5300	24.774	13.94	24	Pass
64	5320	24.266	13.85	24	Pass
100	5500	24.604	13.91	24	Pass
116	5580	22.387	13.50	24	Pass
140	5700	24.547	13.90	24	Pass
149	5745	24.491	13.89	30	Pass
157	5785	23.878	13.78	30	Pass
165	5825	23.550	13.72	30	Pass

NOTE:

For U-NII-2A, U-NII-2C Band:

1. $11\text{dBm} + 10\log(22.18) = 24.46\text{ dBm} > 24\text{dBm}$.
2. $11\text{dBm} + 10\log(21.81) = 24.39\text{ dBm} > 24\text{dBm}$.
3. $11\text{dBm} + 10\log(21.33) = 24.29\text{ dBm} > 24\text{dBm}$.
4. $11\text{dBm} + 10\log(21.69) = 24.36\text{ dBm} > 24\text{dBm}$.
5. $11\text{dBm} + 10\log(22.27) = 24.48\text{ dBm} > 24\text{dBm}$.
6. $11\text{dBm} + 10\log(20.76) = 24.17\text{ dBm} > 24\text{dBm}$.

802.11n (HT20)

Channel	Frequency (MHz)	Maximum Conducted Power (dBm)		Maximum Conducted Power (mW)	Maximum Conducted Power (dBm)	Power Limit (dBm)	Pass / Fail
		Chain 0	Chain 1				
36	5180	11.21	11.82	28.418	14.54	30	Pass
40	5200	11.80	11.91	30.660	14.87	30	Pass
48	5240	11.53	12.00	30.072	14.78	30	Pass
52	5260	11.77	11.74	29.959	14.77	24	Pass
60	5300	11.80	11.97	30.876	14.90	24	Pass
64	5320	11.83	11.88	30.658	14.87	24	Pass
100	5500	11.53	11.83	29.464	14.69	24	Pass
116	5580	11.47	11.94	29.659	14.72	24	Pass
140	5700	11.62	11.91	30.045	14.78	24	Pass
149	5745	11.41	11.75	28.798	14.59	30	Pass
157	5785	10.11	11.82	25.462	14.06	30	Pass
165	5825	11.32	11.36	27.229	14.35	30	Pass

NOTE:

For U-NII-2A, U-NII-2C Band:

Chain 0

1. $11\text{dBm} + 10\log(21.88) = 24.40\text{ dBm} > 24\text{dBm}.$
2. $11\text{dBm} + 10\log(22.44) = 24.51\text{ dBm} > 24\text{dBm}.$
3. $11\text{dBm} + 10\log(21.84) = 24.39\text{ dBm} > 24\text{dBm}.$
4. $11\text{dBm} + 10\log(22.45) = 24.51\text{ dBm} > 24\text{dBm}.$
5. $11\text{dBm} + 10\log(21.62) = 24.35\text{ dBm} > 24\text{dBm}.$
6. $11\text{dBm} + 10\log(21.83) = 24.39\text{ dBm} > 24\text{dBm}.$

Chain 1

1. $11\text{dBm} + 10\log(21.99) = 24.42\text{ dBm} > 24\text{dBm}.$
2. $11\text{dBm} + 10\log(22.62) = 24.54\text{ dBm} > 24\text{dBm}.$
3. $11\text{dBm} + 10\log(21.48) = 24.32\text{ dBm} > 24\text{dBm}.$
4. $11\text{dBm} + 10\log(22.22) = 24.47\text{ dBm} > 24\text{dBm}.$
5. $11\text{dBm} + 10\log(21.54) = 24.33\text{ dBm} > 24\text{dBm}.$
6. $11\text{dBm} + 10\log(21.36) = 24.30\text{ dBm} > 24\text{dBm}.$

802.11n (HT40)

Channel	Frequency (MHz)	Maximum Conducted Power (dBm)		Maximum Conducted Power (mW)	Maximum Conducted Power (dBm)	Power Limit (dBm)	Pass / Fail
		Chain 0	Chain 1				
38	5190	10.43	10.65	22.655	13.55	30	Pass
46	5230	10.64	10.82	23.666	13.74	30	Pass
54	5270	10.71	10.55	23.126	13.64	24	Pass
62	5310	10.69	10.59	23.177	13.65	24	Pass
102	5510	10.35	10.29	21.530	13.33	24	Pass
110	5550	10.46	11.00	23.706	13.75	24	Pass
134	5670	10.20	10.90	22.774	13.57	24	Pass
151	5755	10.68	11.36	25.372	14.04	30	Pass
159	5795	10.13	11.79	25.405	14.05	30	Pass

NOTE:
For U-NII-2A, U-NII-2C Band:
Chain 0

1. $11\text{dBm} + 10\log(49.84) = 27.98\text{ dBm} > 24\text{dBm}$.
2. $11\text{dBm} + 10\log(49.54) = 27.95\text{ dBm} > 24\text{dBm}$.
3. $11\text{dBm} + 10\log(49.10) = 27.91\text{ dBm} > 24\text{dBm}$.
4. $11\text{dBm} + 10\log(49.88) = 27.98\text{ dBm} > 24\text{dBm}$.
5. $11\text{dBm} + 10\log(48.21) = 27.83\text{ dBm} > 24\text{dBm}$.

Chain 1

1. $11\text{dBm} + 10\log(47.29) = 27.75\text{ dBm} > 24\text{dBm}$.
2. $11\text{dBm} + 10\log(48.11) = 27.82\text{ dBm} > 24\text{dBm}$.
3. $11\text{dBm} + 10\log(47.38) = 27.76\text{ dBm} > 24\text{dBm}$.
4. $11\text{dBm} + 10\log(48.07) = 27.82\text{ dBm} > 24\text{dBm}$.
5. $11\text{dBm} + 10\log(48.07) = 27.82\text{ dBm} > 24\text{dBm}$.

26dB BANDWIDTH:
802.11a

Channel	Frequency (MHz)	26dBc Bandwidth (MHz)	Pass / Fail
36	5180	21.67	Pass
40	5200	21.24	Pass
48	5240	21.52	Pass
52	5260	22.18	Pass
60	5300	21.81	Pass
64	5320	21.33	Pass
100	5500	21.69	Pass
116	5580	22.27	Pass
140	5700	20.76	Pass

802.11n (HT20)

Channel	Frequency (MHz)	26dBc Bandwidth (MHz)		Pass / Fail
		Chain 0	Chain 1	
36	5180	21.77	21.87	Pass
40	5200	21.84	21.36	Pass
48	5240	21.86	21.26	Pass
52	5260	21.88	21.99	Pass
60	5300	22.44	22.62	Pass
64	5320	21.84	21.48	Pass
100	5500	22.45	22.22	Pass
116	5580	21.62	21.54	Pass
140	5700	21.83	21.36	Pass

802.11n (HT40)

Channel	Frequency (MHz)	26dBc Bandwidth (MHz)		Pass / Fail
		Chain 0	Chain 1	
38	5190	47.83	47.97	Pass
46	5230	47.96	47.99	Pass
54	5270	49.84	47.29	Pass
62	5310	49.54	48.11	Pass
102	5510	49.10	47.38	Pass
110	5550	49.88	48.07	Pass
134	5670	48.21	48.07	Pass

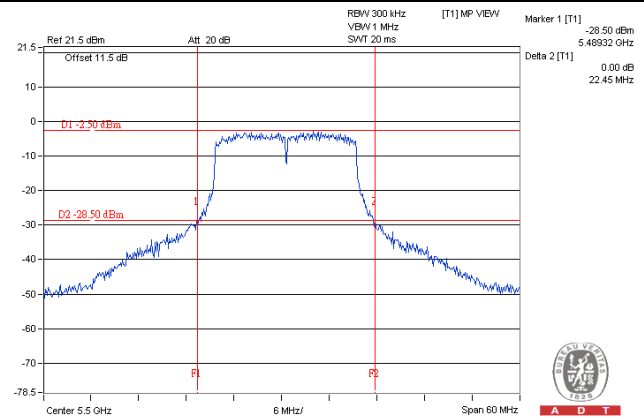
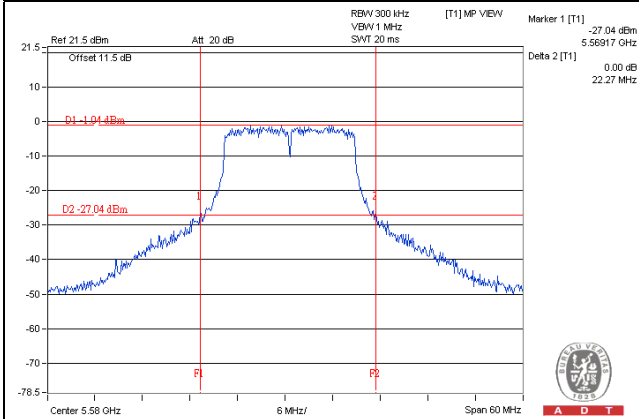
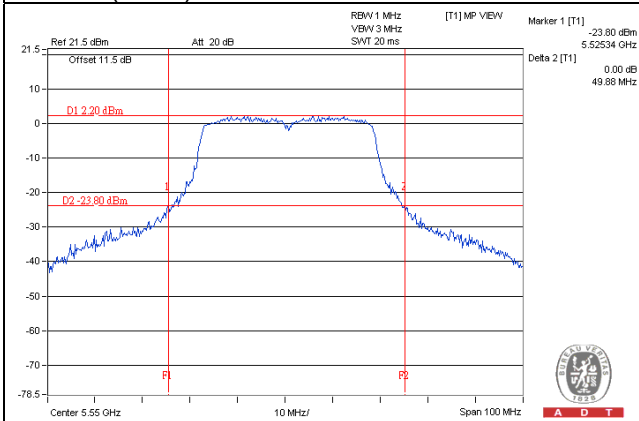
Spectrum Plot of Worst Value**802.11a****802.11n (HT20)****802.11n (HT40)**

EUT MAXIMUM CONDUCTED POWER
802.11a

Frequency Band (MHz)	Max. Power	
	Output Power (mW)	Output Power (dBm)
5250~5350	24.774	13.94
5470~5725	24.604	13.91

NOTE: Manufacturer provides Transmit Power Control description to meet this requirement.

802.11n (HT20)

Frequency Band (MHz)	Max. Power	
	Output Power (mW)	Output Power (dBm)
5250~5350	30.876	14.90
5470~5725	30.045	14.78

NOTE: Manufacturer provides Transmit Power Control description to meet this requirement.

802.11n (HT40)

Frequency Band (MHz)	Max. Power	
	Output Power (mW)	Output Power (dBm)
5250~5350	23.177	13.65
5470~5725	23.706	13.75

NOTE: Manufacturer provides Transmit Power Control description to meet this requirement.

4.4 Peak Power Spectral Density Measurement

4.4.1 Limits of Peak Power Spectral Density Measurement

Operation Band	EUT Category		LIMIT
U-NII-1		Outdoor Access Point	17dBm/ MHz
		Fixed point-to-point Access Point	
	√	Indoor Access Point	
		Mobile and Portable client device	11dBm/ MHz
U-NII-2A		√	11dBm/ MHz
U-NII-2C		√	11dBm/ MHz
U-NII-3		√	30dBm/ 500kHz

4.4.2 Test Setup

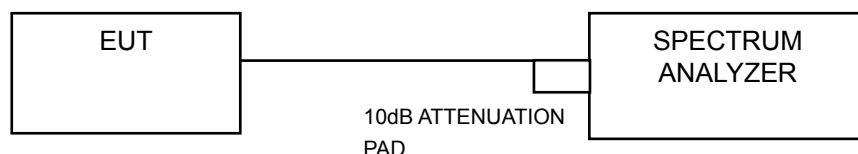

4.4.3 Test Instruments

Refer to section 4.1.2 to get information of above instrument.

4.4.4 Test Procedure

For U-NII-1, U-NII-2A, U-NII-2C band:

Using method SA-1

- 1) Set span to encompass the entire emission bandwidth (EBW) of the signal.
- 2) Set RBW = 30 kHz, Set VBW ≥ 1 MHz, Detector = RMS
- 3) Set Channel power measure = 1MHz
- 4) Sweep time = auto, trigger set to “free run”.
- 5) Trace average at least 100 traces in power averaging mode.
- 6) Record the max value

For U-NII-3 band:

- 1) Set span to encompass the entire emission bandwidth (EBW) of the signal.
- 2) Set RBW = 500 kHz, Set VBW ≥ 3 RBW, Detector = RMS
- 3) Sweep time = auto, trigger set to “free run”.
- 4) Trace average at least 100 traces in power averaging mode.
- 5) Record the max value and add 10 log (1/duty cycle)
- 6) Scale the observed power level to an equivalent value in 500 kHz by adjusting (reducing) the measured power by a bandwidth correction factor (BWCF) where $BWCF = 10\log(500\text{ kHz}/300\text{kHz})$

4.4.5 Deviation from Test Standard

No deviation.

4.4.6 EUT Operating Condition

Same as Item 4.3.6.

4.4.7 Test Results

For U-NII-1, U-NII-2A, U-NII-2C Band

802.11a

Channel	Frequency (MHz)	PSD (dBm)	Maximum Limit (dBm)	Pass / Fail
36	5180	1.45	17	Pass
40	5200	0.93	17	Pass
48	5240	1.36	17	Pass
52	5260	1.14	11	Pass
60	5300	1.22	11	Pass
64	5320	0.96	11	Pass
100	5500	1.02	11	Pass
116	5580	0.65	11	Pass
140	5700	1.23	11	Pass

802.11n (HT20)

Channel	Frequency (MHz)	PSD (dBm)		Total Power Density (dBm)	Maximum Limit (dBm)	Pass / Fail
		Chain 0	Chain 1			
36	5180	-1.79	-0.46	1.94	14.99	Pass
40	5200	-1.67	-0.64	1.89	14.99	Pass
48	5240	-1.28	-1.38	1.68	14.99	Pass
52	5260	-1.77	-1.61	1.32	8.99	Pass
60	5300	-1.63	-1.59	1.40	8.99	Pass
64	5320	-0.82	-1.02	2.09	8.99	Pass
100	5500	-1.15	-1.85	1.52	8.99	Pass
116	5580	-1.47	-1.32	1.62	8.99	Pass
140	5700	-1.03	-1.20	1.90	8.99	Pass

NOTE: 1. Method 1 of power density measurement of KDB 662911 is using for calculating total power density. Total power density is summing entire spectra across corresponding frequency bins on the various outputs by computer.

2. For 5180~5240MHz:

Directional gain = 5dBi + 10log(2) = 8.01dBi > 6dBi, so the power density limit shall be reduced to 17-(8.01-6) = 14.99dBm.

For 5260~5700MHz:

Directional gain = 5dBi + 10log(2) = 8.01dBi > 6dBi, so the power density limit shall be reduced to 11-(8.01-6) = 8.99dBm.

802.11n (HT40)

Channel	Frequency (MHz)	PSD (dBm)		Total Power Density (dBm)	Maximum Limit (dBm)	Pass / Fail
		Chain 0	Chain 1			
38	5190	-5.68	-5.35	-2.50	14.99	Pass
46	5230	-4.52	-5.46	-1.95	14.99	Pass
54	5270	-4.38	-5.47	-1.88	8.99	Pass
62	5310	-5.71	-5.77	-2.73	8.99	Pass
102	5510	-5.85	-5.95	-2.89	8.99	Pass
110	5550	-5.71	-5.91	-2.80	8.99	Pass
134	5670	-5.93	-5.68	-2.79	8.99	Pass

NOTE: 1. Method 1 of power density measurement of KDB 662911 is using for calculating total power density. Total power density is summing entire spectra across corresponding frequency bins on the various outputs by computer.

2. For 5180~5240MHz:

Directional gain = 5dBi + 10log(2) = 8.01dBi > 6dBi, so the power density limit shall be reduced to 17-(8.01-6) = 14.99dBm.

For 5260~5700MHz:

Directional gain = 5dBi + 10log(2) = 8.01dBi > 6dBi, so the power density limit shall be reduced to 11-(8.01-6) = 8.99dBm.

Spectrum Plot of Worst Value

802.11a

802.11n (HT20)

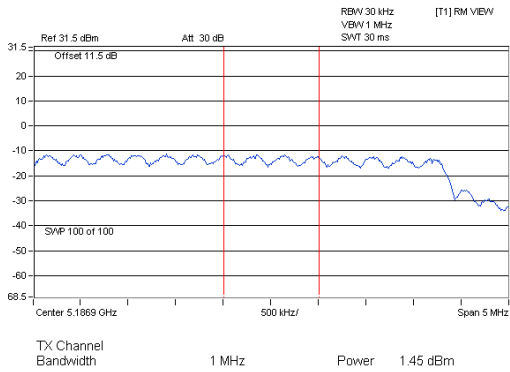

A D T

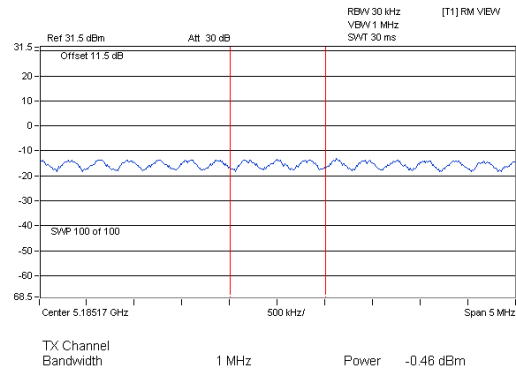

A D T

802.11n (HT40)

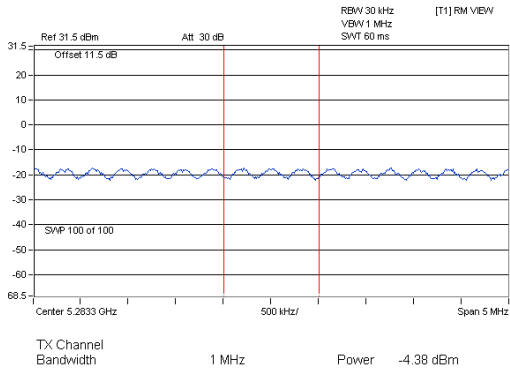

A D T

For U-NII-3 Band

802.11a

Channel	Freq. (MHz)	PSD (dBm/300kHz)	PSD (dBm/500kHz)	Duty Factor	Total PSD (dBm/500kHz)	Limit (dBm/500kHz)	Pass / Fail
149	5745	-6.36	-4.14	0.20	-3.94	30	Pass
157	5785	-6.22	-4.00	0.20	-3.80	30	Pass
165	5825	-6.27	-4.05	0.20	-3.85	30	Pass

802.11n (HT20)

TX chain	Chan.	Freq. (MHz)	PSD (dBm /300kHz)	PSD (dBm /500kHz)	10 log (N=2) dB	Duty Factor	Total PSD (dBm /500kHz)	Limit (dBm /500kHz)	Pass /Fail
0	149	5745	-9.97	-7.75	3.01	0.22	-4.52	27.99	Pass
	157	5785	-10.75	-8.53	3.01	0.22	-5.30	27.99	Pass
	165	5825	-9.39	-7.17	3.01	0.22	-3.94	27.99	Pass
1	149	5745	-8.95	-6.73	3.01	0.22	-3.50	27.99	Pass
	157	5785	-8.99	-6.77	3.01	0.22	-3.54	27.99	Pass
	165	5825	-8.82	-6.60	3.01	0.22	-3.37	27.99	Pass

*Directional gain = 5dBi + 10log(2) = 8.01dBi > 6dBi, so the power density limit shall be reduced to 30-(8.01-6) = 27.99dBm.

802.11n (HT40)

TX chain	Chan.	Freq. (MHz)	PSD (dBm /300kHz)	PSD (dBm /500kHz)	10 log (N=2) dB	Duty Factor	Total PSD (dBm /500kHz)	Limit (dBm /500kHz)	Pass /Fail
0	151	5755	-13.73	-11.51	3.01	0.32	-8.18	27.99	Pass
	159	5795	-14.27	-12.05	3.01	0.32	-8.72	27.99	Pass
1	151	5755	-12.55	-10.33	3.01	0.32	-7.00	27.99	Pass
	159	5795	-12.02	-9.80	3.01	0.32	-6.47	27.99	Pass

*Directional gain = 5dBi + 10log(2) = 8.01dBi > 6dBi, so the power density limit shall be reduced to 30-(8.01-6) = 27.99dBm.

Spectrum Plot of Worst Value

802.11a

802.11n (HT20)

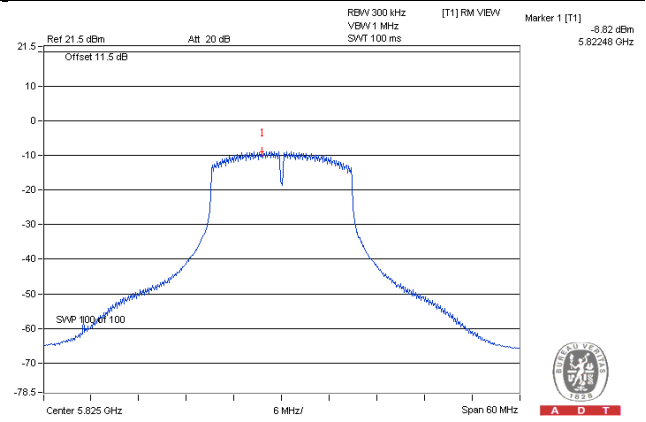
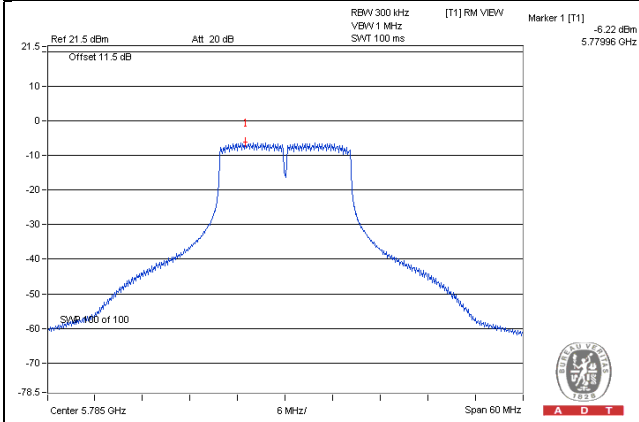

802.11n (HT40)

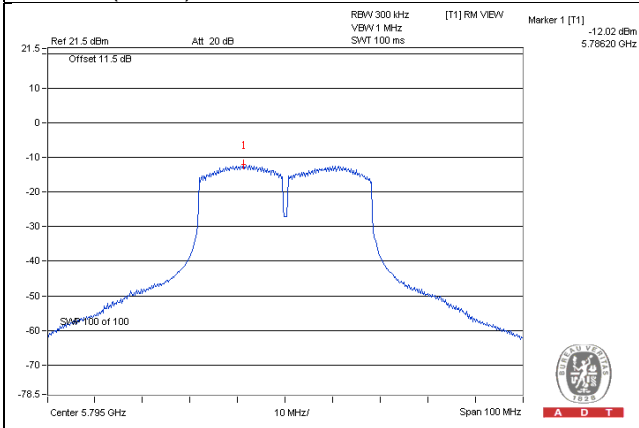

4.5 Frequency Stability

4.5.1 Limits of Frequency Stability Measurement

The frequency of the carrier signal shall be maintained within band of operation

4.5.2 Test Setup

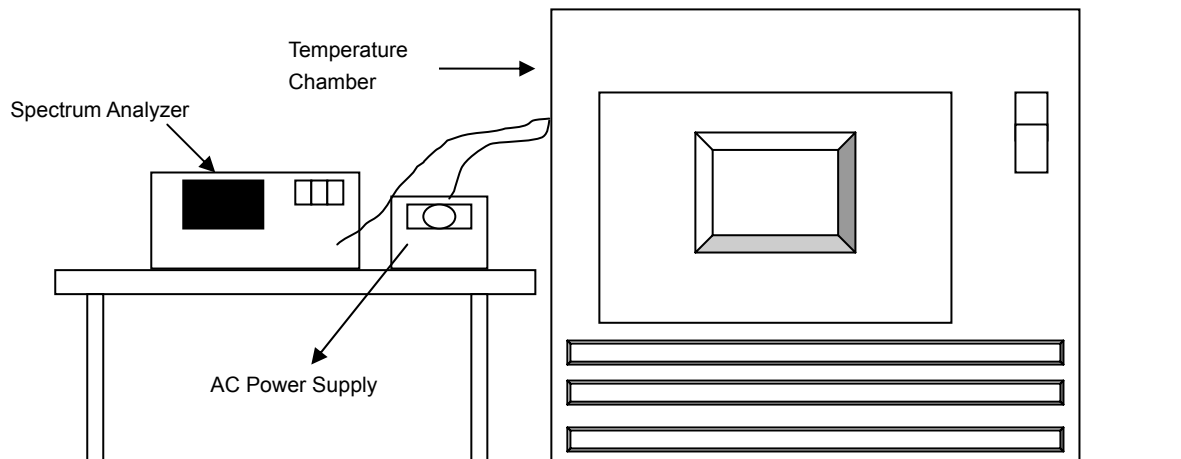

4.5.3 Test Instruments

Refer to section 4.1.2 to get information of above instrument.

4.5.4 Test Procedure

- The EUT was placed inside the environmental test chamber and powered by nominal AC voltage.
- Turn the EUT on and couple its output to a spectrum analyzer.
- Turn the EUT off and set the chamber to the highest temperature specified.
- Allow sufficient time (approximately 30 min) for the temperature of the chamber to stabilize, turn the EUT on and measure the operating frequency after 2, 5, and 10 minutes.
- Repeat step 2 and 3 with the temperature chamber set to the lowest temperature.
- The test chamber was allowed to stabilize at +20 degree C for a minimum of 30 minutes. The supply voltage was then adjusted on the EUT from 85% to 115% and the frequency record.

4.5.5 Deviation from Test Standard

No deviation.

4.5.6 EUT Operating Condition

Set the EUT transmit at un-modulation mode to test frequency stability.

4.5.7 Test Results

FREQUENCY STABILITY VERSUS TEMP.									
OPERATING FREQUENCY: 5320MHz									
TEMP. (°C)	POWER SUPPLY (Vac)	0 MINUTE		2 MINUTE		5 MINUTE		10 MINUTE	
		Measured Frequency (MHz)	Frequency Drift (%)	Measured Frequency (MHz)	Frequency Drift (%)	Measured Frequency (MHz)	Frequency Drift (%)	Measured Frequency (MHz)	Frequency Drift (%)
50	120	5320.0212	0.00040	5320.0244	0.00046	5320.0250	0.00047	5320.0247	0.00046
40	120	5320.0209	0.00039	5320.0174	0.00033	5320.0170	0.00032	5320.0216	0.00041
30	120	5320.0129	0.00024	5320.0130	0.00024	5320.0195	0.00037	5320.0131	0.00025
20	120	5320.0166	0.00031	5320.0109	0.00020	5320.0162	0.00030	5320.0167	0.00031
10	120	5319.9763	-0.00045	5319.9752	-0.00047	5319.9786	-0.00040	5319.9753	-0.00046
0	120	5320.0072	0.00014	5320.0168	0.00032	5320.0076	0.00014	5320.0122	0.00023
-10	120	5320.0127	0.00024	5320.0100	0.00019	5320.0089	0.00017	5320.0145	0.00027
-20	120	5319.9751	-0.00047	5319.9779	-0.00042	5319.9796	-0.00038	5319.9777	-0.00042
-30	120	5320.0168	0.00032	5320.0131	0.00025	5320.0091	0.00017	5320.0150	0.00028

FREQUENCY STABILITY VERSUS TEMP.									
OPERATING FREQUENCY: 5320MHz									
TEMP. (°C)	POWER SUPPLY (Vac)	0 MINUTE		2 MINUTE		5 MINUTE		10 MINUTE	
		Measured Frequency (MHz)	Frequency Drift (%)	Measured Frequency (MHz)	Frequency Drift (%)	Measured Frequency (MHz)	Frequency Drift (%)	Measured Frequency (MHz)	Frequency Drift (%)
20	138	5320.0171	0.00032	5320.0115	0.00022	5320.0152	0.00029	5320.0165	0.00031
	120	5320.0166	0.00031	5320.0109	0.00020	5320.0162	0.00030	5320.0167	0.00031
	102	5320.0171	0.00032	5320.0119	0.00022	5320.016	0.00030	5320.0171	0.00032

4.6 6dB Bandwidth Measurement

4.6.1 Limits of 6dB Bandwidth Measurement

The minimum of 6dB Bandwidth Measurement is 0.5MHz.

4.6.2 Test Setup

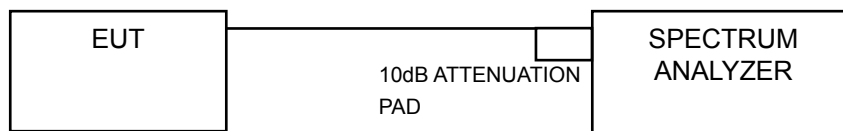

4.6.3 Test Instruments

Refer to section 4.1.2 to get information of above instrument.

4.6.4 Test Procedure

MEASUREMENT PROCEDURE REF

- a. Set resolution bandwidth (RBW) = 100kHz
- b. Set the video bandwidth (VBW) $\geq 3 \times$ RBW, Detector = Peak.
- c. Trace mode = max hold.
- d. Sweep = auto couple.
- e. Measure the maximum width of the emission that is constrained by the frequencies associated with the two amplitude points (upper and lower) that are attenuated by 6 dB relative to the maximum level measured in the fundamental emission

4.6.5 Deviation from Test Standard

No deviation.

4.6.6 EUT Operating Condition

The software provided by client to enable the EUT under transmission Condition continuously at lowest, middle and highest channel frequencies individually.

4.6.7 Test Results

802.11a

Channel	Frequency (MHz)	6dB Bandwidth (MHz)	Minimum Limit (MHz)	Pass / Fail
149	5745	16.37	0.5	Pass
157	5785	16.38	0.5	Pass
165	5825	16.38	0.5	Pass

802.11n (HT20)

Channel	Frequency (MHz)	6dB Bandwidth (MHz)		Minimum Limit (MHz)	Pass / Fail
		Chain 0	Chain 1		
149	5745	17.35	16.33	0.5	Pass
157	5785	17.32	17.61	0.5	Pass
165	5825	17.35	15.18	0.5	Pass

802.11n (HT40)

Channel	Frequency (MHz)	6dB Bandwidth (MHz)		Minimum Limit (MHz)	Pass / Fail
		Chain 0	Chain 1		
151	5755	36.14	36.15	0.5	Pass
159	5795	36.19	35.61	0.5	Pass

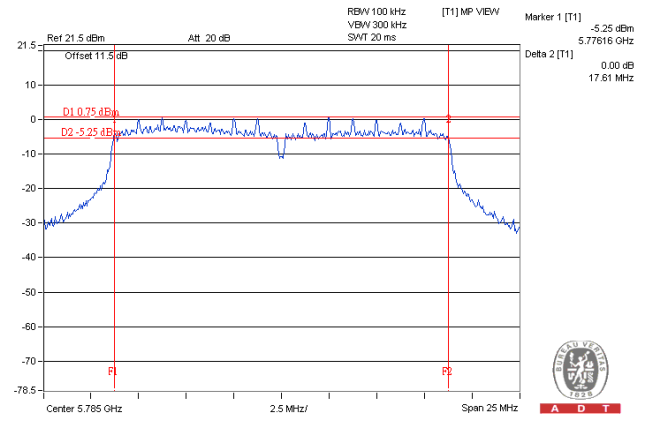
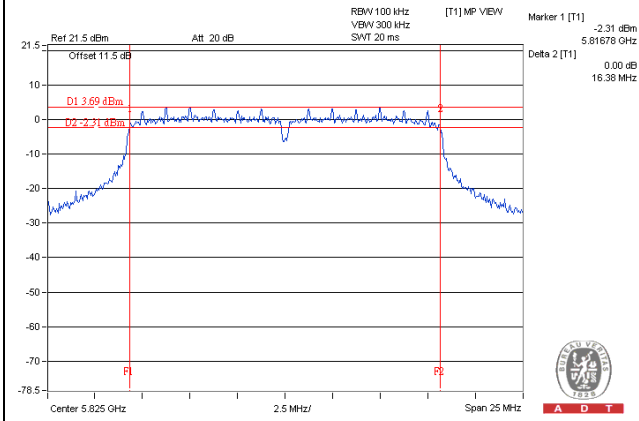
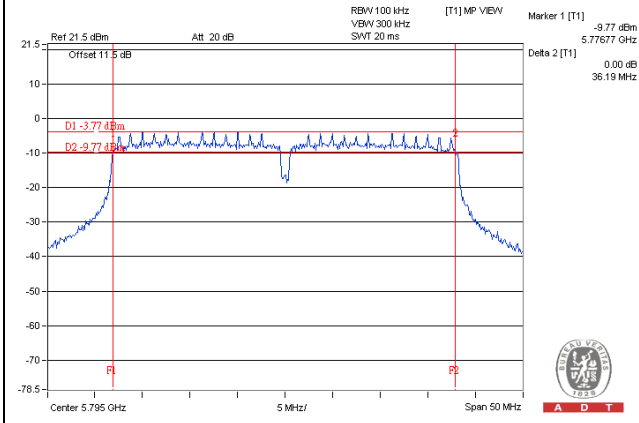
Spectrum Plot of Worst Value**802.11a****802.11n (HT20)****802.11n (HT40)**

5 Pictures of Test Arrangements

Please refer to the attached file (Test Setup Photo).

Appendix – Information on the Testing Laboratories

We, Bureau Veritas Consumer Products Services (H.K.) Ltd., Taoyuan Branch, were founded in 1988 to provide our best service in EMC, Radio, Telecom and Safety consultation. Our laboratories are accredited and approved according to ISO/IEC 17025.

If you have any comments, please feel free to contact us at the following:

Linko EMC/RF Lab

Tel: 886-2-26052180

Fax: 886-2-26051924

Hsin Chu EMC/RF Lab/Telecom Lab

Tel: 886-3-5935343

Fax: 886-3-5935342

Hwa Ya EMC/RF/Safety

Tel: 886-3-3183232

Fax: 886-3-3270892

Email: service.adt@tw.bureauveritas.com

Web Site: www.bureauveritas-adt.com

The address and road map of all our labs can be found in our web site also.

--- END ---