

PHANTOM 3 Professional

User Manual V1.0

2015.03

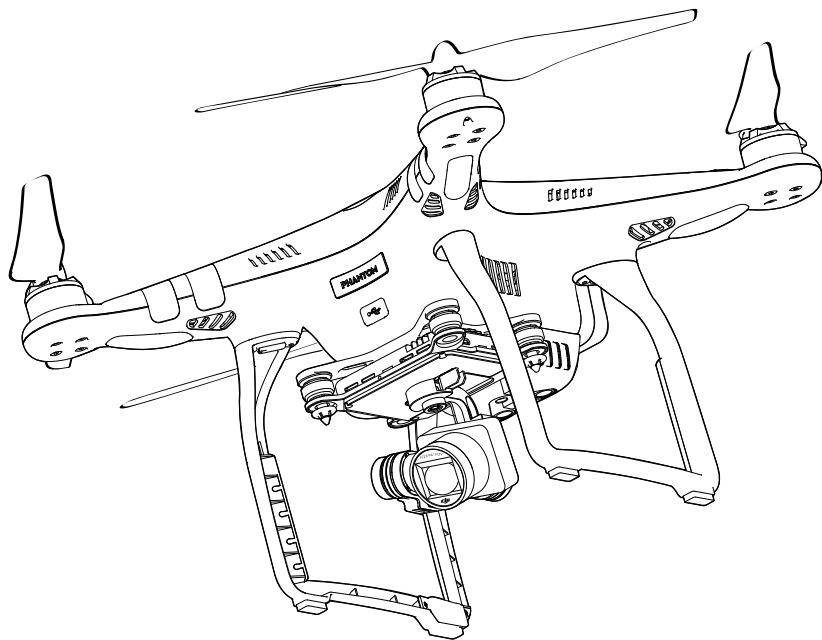

Using this manual

Legends

 Warning

 Important

 Hints and Tips

 Reference

Read Before the First Flight

Read the follow documents before using the Phantom 3 Professional for the first time.

1. *Disclaimer*
2. *Phantom 3 Professional Quick Start Guide*
3. *Phantom 3 Professional User Manual*
4. *In the Box*
5. *Safety Guidelines*
6. *Intelligent Flight Battery Safety Guidelines*

It is recommended to watch all the tutorial videos on DJI official website and read the Disclaimer before your first flight. Prepare for your first flight by using the Phantom 3 Professional Quick Start Guide. Refer to the user manual for more detailed information.

Video Tutorials

Please watch the tutorial video below to learn how to use Phantom 3 Professional safely:

<http://www.dji.com/product/phantom-3-professional/video>



Download the DJI Pilot app

Download and install the DJI Pilot app before use. Scan the QR code below to download.

For Android version of the DJI Pilot app is compatible with Android 4.1.2 or later.

For iOS version of the DJI Pilot app is compatible with iOS 8.0 or later.



Contents

Using this manual

Legends	2
Before Flight	2
Watch the video tutorials	2
Download the DJI Pilot app	2

Product Profile

Introduction	6
Feature Highlights	6
Assemble the Aircraft	7
Aircraft Diagram	8
Remote Controller Diagram	9

Aircraft

Flight Controller	12
Flight Mode	12
Flight Status Indicator	12
Return to Home (RTH)	13
Smart RTH	13
Low Battery RTH	14
Failsafe RTH	15
Dynamic Home Point	15
Vision Positioning System	16
Flight Recorder	17
Attaching and Detaching the Propellers	17
DJI Intelligent Flight Battery	18

Remote Control

Remote Controller Profile	24
Remote Controller Operations	24
Remote Controller Status LED	29
Linking the Remote Controller	29
Remote Controller Compliance Version	30

Camera and Gimbal

Camera Profile	32
Gimbal	33

DJI Pilot App

Camera	36
Map	40
Academy	40
User Center	40

Flight

Flight Environment Requirements	42
Flight Limits and Flight Restriction Area	42
Preflight Checklist	46
Calibrating the Compass	46
Auto Take-off and Auto Landing	47
Flight Test	48
Starting/Stopping the Motors	48

Troubleshooting (FAQ)

Appendix

Specifications	53
Intelligent Orientation Control (IOC)	56
FCC Compliance	57

Product Profile

This chapter introduces the Phantom 3 Professional and lists the components on the aircraft and remote controllers.

Product Profile

Introduction

The Phantom 3 Professional is a brand new quadcopter capable of capturing HD video and transmitting an HD video signal out of the box. The built-in camera has an integrated gimbal to maximize stability and weight efficiency while minimizing space. Even when no GPS signal is available, Vision Positioning system provides hovering precision.

Feature Highlights

Camera and Gimbal: The Phantom 3 Professional camera shoots, of course, 4K video and it is capable of capturing 12 megapixel stills.

HD Video Downlink: Low latency, HD downlink powered by an enhanced version of the DJI Lightbridge system.

DJI Intelligent Flight Battery: 4480 mAh DJI Intelligent Flight Battery employs new battery cells and a battery management system.

Flight Controller: The next generation flight controller system provides a more reliable flight experience. A new flight recorder stores the flight data from each flight, and Vision Positioning enhances hovering precision when flying indoors and no GPS is available.

Assemble the Aircraft

Removing Gimbal Clamp

Remove the gimbal clamp in the direction as shown below:

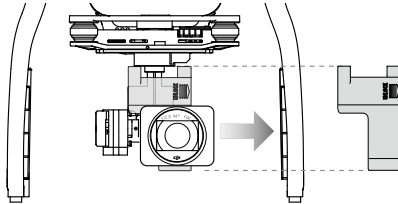

Attaching Propellers

Attach the propellers with the black nut onto motors with the black axis and spin counter-clockwise to secure. Attach propellers with grey nut onto motors without a grey axis and spin clockwise to secure.

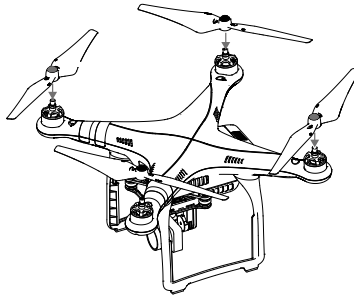

 Place all propellers onto the correct motor and tighten by hand to secure its position.

Preparing Remote Controller

Tilt the Mobile Device Holder to the desired position then adjust the antennas.

1. Press the button on the side of the Mobile Device Holder to release the clamp, adjust the clamp to fit the size of the mobile device.
2. Connect the mobile device to the remote controller with a USB cable.
3. Plug one end of the cable into the mobile device, and the other end into the USB port on the back of the remote controller.

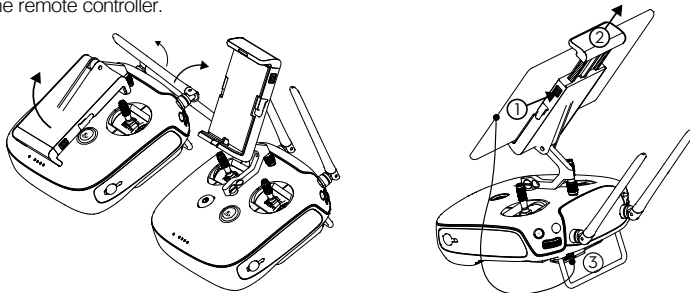

Aircraft Diagram

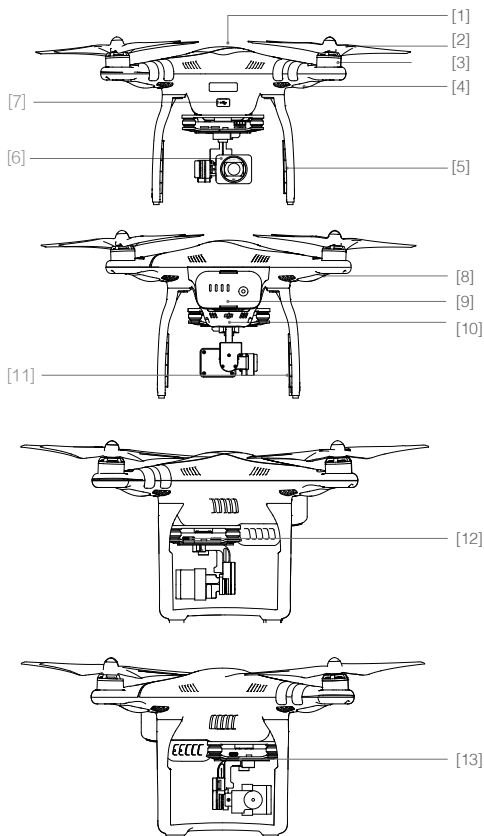

- [1] GPS
- [2] Propeller
- [3] Motor
- [4] Front LED
- [5] Landing gear
- [6] Gimbal and Camera
- [7] Aircraft Micro-USB Port
- [8] Aircraft Status Indicator
- [9] Intelligent Flight Battery
- [10] Vision Positioning Sensors
- [11] Antennas
- [12] Camera Micro-SD Card Slot
- [13] Camera Micro-USB Port

Remote Controller Diagram

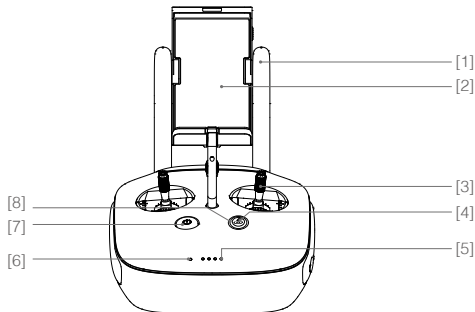

- [1] Antennas
Relays aircraft control and video signal.
- [2] Mobile Device Holder
Mounting place for your mobile device.
- [3] Control Stick
Controls aircraft orientation.
- [4] Return Home (RTH) Button
Press and hold the button to initiate Return to Home (RTH).

[5] Battery Level LEDs

Displays the battery level of the remote controller.

[6] Status LED

Displays the remote controller's system status.

[7] Power Button

Used to power on or power off the remote controller.

[8] RTH LED

Circular LED around the RTH button displays RTH status.

[9] Camera Settings Dial

Turn the dial to adjust camera settings. Only functions when the remote controller is connected to a mobile device running the DJI Pilot app.

[10] Playback Button

Playback the captured images or videos.

[11] Shutter Button

Press to take a photo. If in burst mode, the set number of photos will be taken with one press.

[12] Flight Mode Switch

Switch between P, A and F mode.

[13] Video Recording Button

Press to start recording video. Press again to stop recording.

[14] Gimbal Dial

Use this dial to control the tilt of the gimbal.

[17] Back Right Button

Customizable button in DJI Pilot app.

[18] Back Left Button

Customizable button in DJI Pilot app.

[19] Power Port

Connect to a power source to charge the battery of the remote controller.

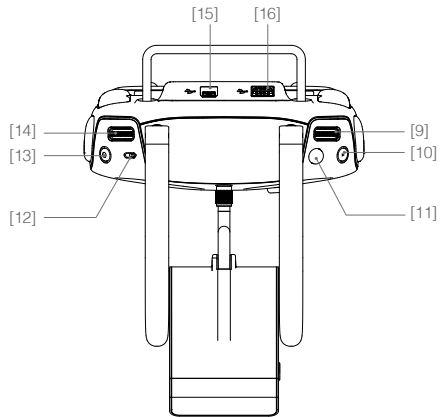
**[15] Micro-USB Port**

Connect to a SD card reader to upgrade the firmware.

[16] USB Port

Connect to mobile device or to a USB thumb drive for firmware upgrade.

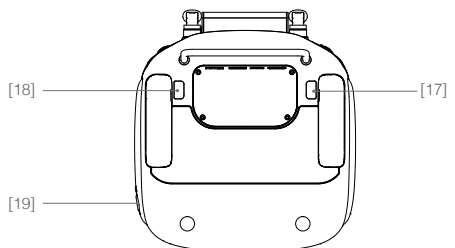

Aircraft

This chapter introduces the features of the flight controller, Vision Positioning System and the Intelligent Flight Battery.

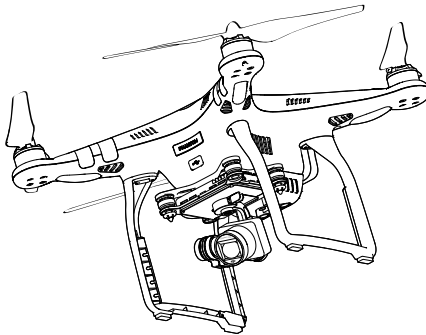

Aircraft

Flight Controller

The Phantom 3 Professional flight controller is based on DJI flight controller with several enhancements such as new flight mode. Three safe modes are available: Failsafe, Return Home and Dynamic Home Point. These features ensure the safe return of your aircraft if the control signal is lost. The flight controller can store crucial flight data to the on-board storage device for each flight.

Flight Mode

Three flight modes are available. The details of each flight mode are found in the section below:

P mode (Positioning) : P mode works best when GPS signal is strong. There are three different states of P mode, which will be automatically selected by the Phantom 3 Professional depending on signal strength of GPS and Vision Positioning sensors :

P-GPS: GPS and Vision Positioning both are available, and the aircraft is using GPS for positioning.

P-OPTI: Vision Positioning is available but the GPS signal is not. Aircraft is using only Vision Positioning for hovering

P-ATTI: Neither GPS or Vision Positioning available, aircraft is using only its barometer for positioning, so only altitude is controlled.

A mode (Attitude): GPS and Vision Positioning System is not used for stabilization. The aircraft only uses its barometer to stabilize. The aircraft can automatically return home if remote control signal is lost if the Home Point is recorded successfully.

F mode (Function): Intelligent Orientation Control (IOC) is activated in this mode. For more information about IOC, refer to the IOC section in the Appendix.



Use the Flight Controller mode switch to change the flight mode of the aircraft, refer to the "Flight Mode Switch" on P24 for more information.

Flight Status Indicator

The Phantom 3 Professional comes with the Front LED and Aircraft Status Indicator. The positions of these LEDs are shown in the figure below:

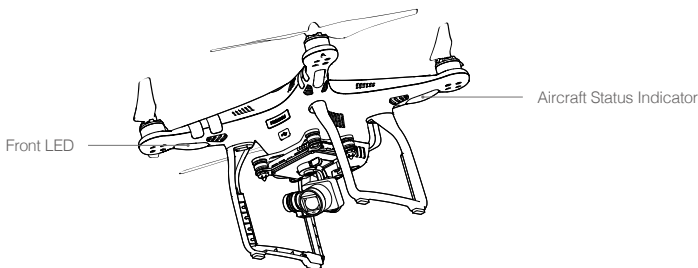

The Front shows the orientation of the aircraft. The Front LED displays solid red. Aircraft Status Indicator shows the system status of the flight controller. Refer to the table below for more information about the Aircraft Status Indicator:

Aircraft Status Indicator Description

Normal

 Red, Green and Yellow Flash Alternately

Power on and self-check

 Green and Yellow Flash Alternately

Aircraft warming up

 Green Flashes Slowly

Safe to Fly (P mode with GPS and Vision Positioning)

 X2 Green Flashes Twice

Safe to Fly (P mode with Vision Positioning but without GPS)

 Yellow Flashes Slowly

Safe to Fly (A mode but No GPS and Vision Positioning)

Warning

 Fast Yellow Flashing

Remote Controller Signal Lost

 Slow Red Flashing

Low Battery Warning

 Fast Red Flashing

Critical Low Battery Warning

 Red Flashing Alternately

IMU Error

 — Solid Red



Critical Error

 Red and Yellow Flash Alternately

Compass Calibration Required

Return to Home (RTH)

The Return to Home (RTH) brings the aircraft back to the last recorded Home Point. There are three cases that will trigger RTH procedure; they are Smart RTH, Low Battery RTH and Failsafe RTH. The remaining part of this section will describe these three cases in details.

	GPS	Description
Home Point		The Home Point is the location at which your aircraft takes off when the GPS signal is strong. You can view the GPS signal strength through the GPS icon (). Aircraft status indicator will blink rapidly when home point is recorded.

Smart RTH

Use the RTH button on the remote controller (refer to “RTH button” on P28 for more information) or tap the RTH button in the DJI Pilot app when GPS is available to start Smart RTH. The aircraft returns to the latest recorded Home Point, you may control the aircraft's orientation to avoid collision during the Smart RTH. Press and hold the Smart RTH button once to start the process, press the Smart RTH button again to exit Smart RTH and regain the control.

Low Battery RTH

The low battery level failsafe is triggered when the DJI Intelligent Flight Battery is depleted to a point that may affect the safe return of the aircraft. Users are advised to return home or land the aircraft immediately when these warnings are prompted. DJI Pilot app will advise user to return the aircraft to the Home Point when low battery warning is triggered. Aircraft will automatically return to the Home Point if no action is taken after 10 seconds countdown. User can cancel the RTH by pressing once on the RTH button. The thresholds for these warnings are automatically determined based on the current aircraft altitude and its distance from the Home Point.

Aircraft will land automatically if the current battery level can only support the aircraft to land from the current altitude. User can use the remote controller to control the aircraft's orientation during the landing process.

The Battery Level Indicator is displayed in the DJI Pilot app, and is described below

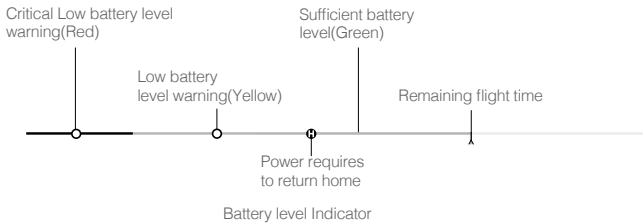

Battery Level Warning	Remark	Aircraft Status Indicator	DJI Pilot app	Flight Instructions
Low battery level warning	The battery power is low. Please land the aircraft.	Aircraft status indicator blinks RED slowly.	Tap "Go-home" to have the aircraft return to the Home point and land automatically, or "Cancel" to resume normal flight. If no action is taken, the aircraft will automatically go home and land after 10 seconds. Remote controller will sound an alarm.	Fly the aircraft back and land it as soon as possible, then stop the motors and replace the battery.
Critical Low battery level warning	The aircraft must land immediately.	Aircraft status indicator blinks RED quickly.	The DJI Pilot app screen will flash red and aircraft starts to descend. Remote controller will sound an alarm.	The aircraft will begin to descend and land automatically.
Estimated remaining flight time	Estimated remaining flight based on current battery level.	N/A	N/A	N/A



- When the critical battery level warning activates and the aircraft is descending to land automatically, you may push the throttle upward to hover the aircraft and navigate it to a more appropriate location for landing.
- Color zones and markers on the battery level indicator reflect estimated remaining flight time and are adjusted automatically, according to the aircraft's current status.

Failsafe RTH

Failsafe RTH is activated automatically if remote controller signal (including video relay signal) is lost for more than 3 seconds provided that Home Point has been successfully recorded and compass is working normally. Return home process may be interrupted and the operator can regain control over the aircraft if a remote controller signal is resumed.

Failsafe Illustration

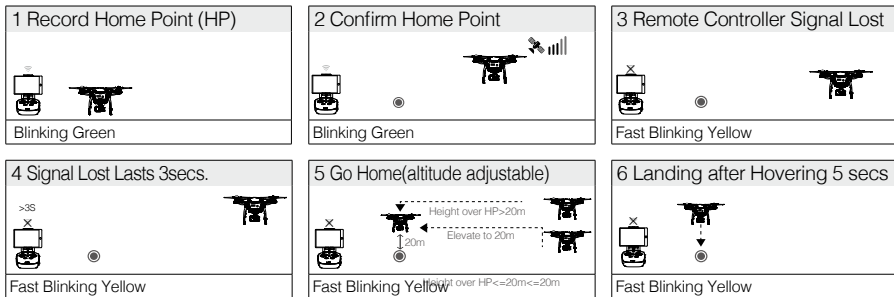

Aircraft cannot avoid obstruction during the Failsafe RTH, therefore it is important to set an suitable Failsafe altitude before each flight. Launch the DJI Pilot app and enter "Camera" view and select "MODE" to set the Failsafe altitude.

Aircraft will stop ascending and return to the Home Point immediately if throttle stick is moved during the Failsafe RTH procedure

Dynamic Home Point

Dynamic home point is useful in situations when you are in motion and require a Home Point that is different from the takeoff point. You may only use the Dynamic Home Point feature on the GPS-enabled mobile device.

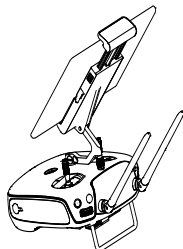

Ensure the space above the GPS module is not obstructed when using Dynamic Home Point.

There are two options for Dynamic Home Point.

1. Set the aircraft current coordinate as the new Home Point.
2. Set the mobile device's coordinate as the new Home Point.

Setting Up Dynamic Home Point

Follow the steps below to setup Dynamic Home Point:

1. Connect to the mobile device and launch the DJI Pilot app and go to the "Camera" page.
2. Tap "📍" and select "📍", to set the mobile device's coordinates as the new Home Point.
3. Tap "📍" and select "📍", to set the aircraft's coordinates as the new Home Point.
4. The aircraft status indicator blinks green to show Home Point is set successfully.

Vision Positioning System

DJI Vision Positioning is a positioning system that uses ultrasonic and image data to help the aircraft identify its current position. With the help of Vision Positioning, your Phantom 3 Professional can hover in place more precisely and fly indoors or in other environments where there is no GPS signal available. The main components of DJI Vision Positioning are located on the bottom of your Phantom 3 Professional, including [1] one monocular camera and [2] two sonar sensors.

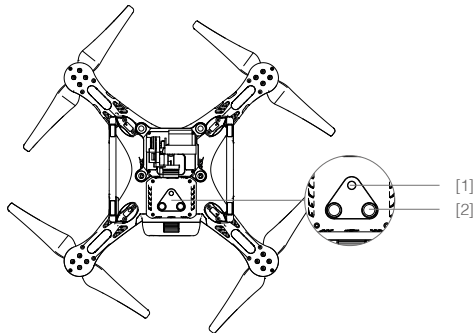

Using Vision Positioning

Vision Positioning is activated automatically when the Phantom 3 Professional is powered on. No manual action is required. Vision Positioning is typically used in the indoor environment where no GPS is available. By using the sensors on the Vision Positioning system, Phantom 3 Professional can perform precision hovering even when no GPS is available.

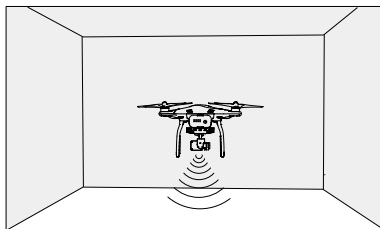



Follow the steps below to use Vision Positioning:

1. Toggle the switch to "P" mode.
2. Place the aircraft on a flat surface. Notice that the Vision Positioning system cannot work properly on surfaces without pattern variations.
3. Power on the aircraft. The aircraft status indicator will flash twice in green light, which indicates the Vision Positioning system is ready. Gently push the throttle up to lift off, and the aircraft will hover in place.

 The performance of your Vision Positioning System is subject to the surface you are flying over. The ultrasonic waves may not be able to accurately measure the distance over sound absorbing materials, and the camera may not function correctly in suboptimal environments. The aircraft will switch from "P" mode to "A" mode automatically if both GPS and Vision Positioning System are not available. So operate the aircraft cautiously when in any of the following situations:

- Flying over monochrome surfaces (e.g. pure black, pure white, pure red, pure green).
- Flying over a highly reflective surfaces.
- Flying at high speeds(over 8 m/s at 2 meters or over 4 m/s at 1 meter).
- Flying over water or transparent surfaces.
- Flying over moving surfaces or objects.
- Flying in an area where the lighting changes frequently or drastically.
- Flying over extremely dark (lux < 10) or bright (lux > 100,000) surfaces.
- Flying over surfaces that can absorb sound waves (e.g. thick carpet).
- Flying over surfaces without clear patterns or texture.
- Flying over surfaces with identical repeating patterns or textures (e.g. tiles with same design).
- Flying over inclined surfaces that will deflect sound waves away from the aircraft.

-
-  • Keep the sensors clean at all times. Dirt or other debris may adversely affect the effectiveness of the sensors.
- The effective hovering altitudes of the aircraft is from 0 to 3 meters.
 - Vision Positioning system may not function properly when the aircraft is flying over water.
 - Vision Positioning system may not be able to recognize pattern on the ground in low light conditions (less than 100 lux).
 - Do not use other ultrasonic devices with frequency of 40 KHz when Vision Positioning system is in operation.
 - Vision Positioning system may not be able to stabilize the aircraft when flying close to the ground (below 0.5 meters) in fast speed.

-
-  Keep the animals away from the aircraft when Vision Positioning system is activated. The sonar sensor emits high frequency sound that is only audible to some animals.
-





Flight Recorder

Flight data is automatically recorded to the SD card. This includes flight telemetry, aircraft status information, and other parameters. Access these data from the DJI Pilot app through the Aircraft Micro-USB Port.

Attaching and Detaching the Propellers

Use only DJI approved propellers with your Phantom 3 Professional. The grey or black nut on the propeller indicates the rotation direction of the propeller and where it should be attached. To attach

the propellers properly, match the nut with the axis on the motors of your Phantom 3 Professional.

Propellers	Grey cap	Black cap
Figure		
Attach On	Motors with a grey axis	Motors with a black axis
Legends	 Lock : Turn the propellers in the indicated direction to mount and tighten  Unlock : Turn the propellers in the indicated direction to loosen and remove	

Attaching the Propellers

1. Attach the propellers with a grey nut onto a motor with the grey axis and spin the propellers clockwise to secure them in place. Attach the propellers with a black nut onto a motor with the black axis and spin the propellers counter clockwise to secure its position. Be sure to completely tighten each propeller by hand before flight.

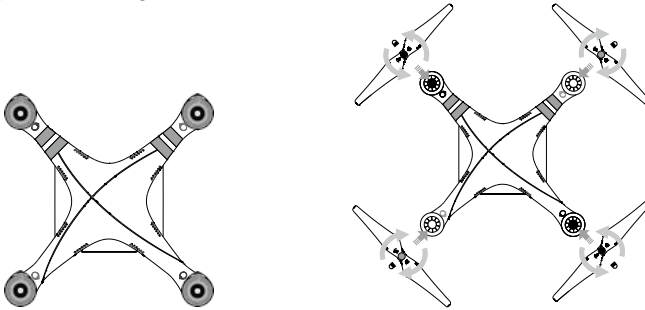

- ⚠ • Ensure propellers are attached to its corresponding motors, otherwise the aircraft cannot take off.
- Wear gloves when handling propellers.
- Manually tighten each of the propellers on the corresponding motors to ensure it is attached firmly.

Detaching the Propellers

Hold the motor still. Then spin the propeller in the unlock direction indicated on the propeller itself.

- ⚠ • Check that the propellers and motors are installed correctly and firmly before every flight.
- Ensure that all propellers are in good condition before each flight. DO NOT use aged, chipped, or broken propellers.
- To avoid injury, STAND CLEAR of and DO NOT touch propellers or motors when they are spinning.
- ONLY use original DJI propellers for a better and safer flight experience.

DJI Intelligent Flight Battery

The DJI Intelligent Flight Battery has a capacity of 4480 mAh, voltage of 15.2 V, and smart charge-discharge functionality. It can only be charged with an appropriate DJI approved charger.

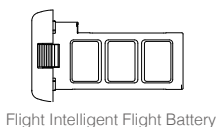

Flight Intelligent Flight Battery

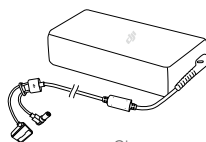

Charger

⚠ Battery must be fully charged before using it for the first time. Refer to "Charging the Intelligent Flight Battery" for more information .

💡 Be aware that the output power of the supplied Phantom 3 Professional charger is 100W.

DJI Intelligent Flight Battery Functions

1. Battery Level Display: LEDs display the current battery level.
2. Battery Life Display: LEDs display the current battery power cycle.
3. Auto-discharging Function: The battery automatically discharges to below 65% of total power when it is idle for more than 10 days to prevent swelling. It takes around 2 days to discharge the battery to 65%. It is normal to feel moderate heat emitting from the battery during the discharge process. Discharge thresholds can be set in the DJI Pilot app.
4. Balanced Charging: Automatically balances the voltage of each battery cell when charging.
5. Over charge Protection: Charging automatically stops when the battery is fully charged.
6. Temperature Detection: The battery will only charge when the temperature is between 0°C(32°F) and 40°C (104°F).
7. Over Current Protection: Battery stops charging when high amperage (more than 8 A) is detected.
8. Over Discharge Protection: Discharging automatically stops when the battery voltage reaches 12 V to prevent over-discharge damage
9. Short Circuit Protection: Automatically cuts the power supply when a short circuit is detected.
10. Battery Cell Damages Protection: DJI Pilot app shows warning message when damaged battery cell is detected.
11. Battery Error History Browse the battery error history from the DJI Pilot app.
12. Sleep Mode: Sleep mode is entered after 20 minutes of inactivity to save power.
13. Communication: Battery voltage, capacity, current, and other relevant information is provided to the aircraft's to the main controller.

⚠ Refer to *Disclaimer* and *Intelligent Flight Battery Safety Guidelines* before use. Users take full responsibility for all operations and usage.

Using the Battery

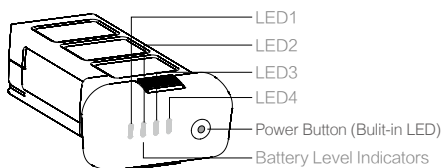

Powering ON/OFF

Powering On: Press the Power Button once, then press again and hold for 2 seconds to power on. The Power LED will turn red and the Battery Level Indicators will display the current battery level.

Powering Off: Press the Power Button once, then press again and hold for 2 seconds to power off.

Low Temperature Notice:

1. Battery capacity is significantly reduced when flying in low temperature environment ($< 0^{\circ}\text{C}$).
2. It is not recommended to use the battery in extremely low temperature ($< -10^{\circ}\text{C}$) environment. Battery voltage should reach to the appropriate level when using in the environment where temperature range between minus 10°C to 5°C .
3. Stop flying when DJI Pilot app displays "Low Battery Level Warning" in low temperature environment.
4. Place the battery indoors to warm up the battery before using it in the low temperature environment.
5. To ensure the performance of the battery, keep the battery body temperature above 20°C .





































 In cold environments, insert the battery into the battery compartment and allow the aircraft to warm up for approximately 1-2 minutes before taking off.

Checking the battery level

The Battery Level Indicators display how much remaining power the battery has. When the battery is powered off, press the Power Button once. The Battery Level Indicators will light up to display the current battery level. See below for details.

 The Battery Level Indicators will also show the current battery level during charging and discharging. The indicators are defined below.

 : LED is on.  : LED is flashing.
 : LED is off.

Battery Level				
LED1	LED2	LED3	LED4	Battery Level
				87.5%~100%
				75%~87.5%
				62.5%~75%
				50%~62.5%
				37.5%~50%
				25%~37.5%
				12.5%~25%
				0%~12.5%
				=0%

Battery life

The battery life indicates how many more times the battery can be discharged and recharged before it must be replaced. When the battery is powered off, press and hold the Power Button for 5 seconds to check the battery life. The Battery Level Indicators will light up and/or blink as described below for 2 seconds: