



FCC RF Test Report

APPLICANT : ZTE CORPORATION
EQUIPMENT : CDMA/LTE Multi-mode Digital Mobile Phone
BRAND NAME : ZTE
MODEL NAME : ZTE N9520
FCC ID : SRQ-ZTEN9520
STANDARD : FCC 47 CFR Part 2, 22(H), 24(E)
CLASSIFICATION : PCS Licensed Transmitter Held to Ear (PCE)

The product was received on Sep. 14, 2013 and testing was completed on Oct. 15, 2013. We, SPORTON INTERNATIONAL (KUNSHAN) INC., would like to declare that the tested sample has been evaluated in accordance with the procedures given in ANSI / TIA / EIA-603-C-2004 and shown to be compliant with the applicable technical standards.

The test results in this report apply exclusively to the tested model / sample. Without written approval of SPORTON INTERNATIONAL (KUNSHAN) INC., the test report shall not be reproduced except in full.

Reviewed by: Joseph Lin / Supervisor

Approved by: Jones Tsai / Manager



SPORTON INTERNATIONAL (KUNSHAN) INC.
No. 3-2, PingXiang Road, Kunshan, Jiangsu Province, P.R.C.



TABLE OF CONTENTS

REVISION HISTORY.....	3
SUMMARY OF TEST RESULT	4
1 GENERAL DESCRIPTION	5
1.1 Applicant.....	5
1.2 Manufacturer	5
1.3 Feature of Equipment Under Test.....	5
1.4 Product Specification of Equipment Under Test	5
1.5 Modification of EUT	6
1.6 Maximum ERP/EIRP Power, Frequency Tolerance, and Emission Designator	6
1.7 Testing Site	6
1.8 Applied Standards	7
2 TEST CONFIGURATION OF EQUIPMENT UNDER TEST.....	8
2.1 Test Mode.....	8
2.2 Connection Diagram of Test System	9
2.3 Support Unit used in test configuration and system.....	9
2.4 Measurement Results Explanation Example	9
3 TEST RESULT.....	10
3.1 Conducted Output Power Measurement.....	10
3.2 Peak-to-Average Ratio	12
3.3 Effective Radiated Power and Effective Isotropic Radiated Power Measurement	15
3.4 99% Occupied Bandwidth and 26dB Bandwidth Measurement.....	18
3.5 Band Edge Measurement.....	26
3.6 Conducted Spurious Emission Measurement.....	31
3.7 Field Strength of Spurious Radiation Measurement	37
3.8 Frequency Stability Measurement.....	43
4 LIST OF MEASURING EQUIPMENT	47
5 UNCERTAINTY OF EVALUATION.....	49
APPENDIX A. SETUP PHOTOGRAPHS	



SUMMARY OF TEST RESULT

Report Section	FCC Rule	Description	Limit	Result	Remark
3.1	§2.1046	Conducted Output Power	N/A	PASS	-
3.2	§24.232(d)	Peak-to-Average Ratio	< 13 dB	PASS	-
3.3	§22.913(a)(2)	Effective Radiated Power	< 7 Watts	PASS	-
3.3	§24.232(c)	Equivalent Isotropic Radiated Power	< 2 Watts	PASS	-
3.4	§2.1049 §22.917(a) §24.238(b)	Occupied Bandwidth	N/A	PASS	-
3.5	§2.1051 §22.917(a) §24.238(a)	Band Edge Measurement	< 43+10log ₁₀ (P[Watts])	PASS	-
3.6	§2.1051 §22.917(a) §24.238(a)	Conducted Spurious Emission	< 43+10log ₁₀ (P[Watts])	PASS	-
3.7	§2.1053 §22.917(a) §24.238(a)	Field Strength of Spurious Radiation	< 43+10log ₁₀ (P[Watts])	PASS	Under limit 35.66 dB at 2510.000 MHz
3.8	§2.1055 §22.355 §24.235	Frequency Stability for Temperature & Voltage	< 2.5 ppm	PASS	-



1 General Description

1.1 Applicant

ZTE CORPORATION

ZTE Plaza, Keji Road South, Hi-Tech Industrial Park, Nanshan District, Shenzhen, Guangdong, 518057, P.R.China

1.2 Manufacturer

ZTE CORPORATION

ZTE Plaza, Keji Road South, Hi-Tech Industrial Park, Nanshan District, Shenzhen, Guangdong, 518057, P.R.China

1.3 Feature of Equipment Under Test

Product Feature	
Equipment	CDMA/LTE Multi-mode Digital Mobile Phone
Brand Name	ZTE
Model Name	ZTE N9520
FCC ID	SRQ-ZTEN9520
EUT supports Radios application	CDMA/EV-DO/LTE/WLAN 2.4GHz 802.11bgn HT20/ Bluetooth v3.0 + EDR/Bluetooth v4.0
HW Version	cyyB
SW Version	N9520V1.0.0B02
EUT Stage	Identical Prototype

Remark: The above EUT's information was declared by manufacturer. Please refer to the specifications or user's manual for more detailed description.

1.4 Product Specification of Equipment Under Test

Product Specification subjective to this standard	
Tx Frequency	CDMA2000 BC0: 824.70 MHz ~ 848.31 MHz CDMA2000 BC1: 1851.25 MHz ~ 1908.75 MHz
Rx Frequency	CDMA2000 BC0: 869.70 MHz ~ 893.31 MHz CDMA2000 BC1: 1931.25 MHz ~ 1988.75 MHz
Maximum Output Power to Antenna	CDMA2000 BC0 : 24.36 dBm CDMA2000 BC1 : 24.19 dBm
Antenna Type	PIFA Antenna
Type of Modulation	CDMA2000 1xRTT: QPSK CDMA2000 1xEV-DO : QPSK/8PSK



1.5 Modification of EUT

No modifications are made to the EUT during all test items.

1.6 Maximum ERP/EIRP Power, Frequency Tolerance, and Emission Designator

FCC Rule	System	Type of Modulation	Maximum ERP/EIRP (W)	Frequency Tolerance (ppm)	Emission Designator
Part 22	CDMA2000 BC0 1xRTT	QPSK	0.16	0.03 ppm	1M28F9W
Part 24	CDMA2000 BC1 1xRTT	QPSK	0.19	0.02 ppm	1M28F9W

1.7 Testing Site

Test Site	SPORTON INTERNATIONAL (KUNSHAN) INC.		
Test Site Location	No. 3-2, PingXiang Road, Kunshan, Jiangsu Province, P.R.C. TEL: +86-0512-5790-0158 FAX: +86-0512-5790-0958		
Test Site No.	Sporton Site No.		FCC Registration No.
	TH01-KS	OTA01-KS	149928

Test Site	SPORTON INTERNATIONAL (SHENZHEN) INC.		
Test Site Location	No. 3 Building, the third floor of south, Shahe River west, Fengzeyuan warehouse, Nanshan District, Shenzhen, Guangdong, P.R.C. TEL: +86-755- 3320-2398		
Test Site No.	Sporton Site No.		FCC Registration No.
	03CH01-SZ		831040



1.8 Applied Standards

According to the specifications of the manufacturer, the EUT must comply with the requirements of the following standards:

- ♦ FCC 47 CFR Part 2, 22(H), 24(E)
- ♦ ANSI / TIA / EIA-603-C-2004
- ♦ FCC KDB 971168 D01 Power Meas. License Digital Systems v02r01

Remark:

1. All test items were verified and recorded according to the standards and without any deviation during the test.
2. This EUT has also been tested and complied with the requirements of FCC Part 15, Subpart B, recorded in a separate test report.

2 Test Configuration of Equipment Under Test

2.1 Test Mode

During all testing, EUT is in link mode with base station emulator at maximum power level. The spurious emission measurements were carried out in semi-anechoic chamber with 3-meter test range, and EUT is rotated on three test planes to find out the worst emission (Z Plane).

Frequency range investigated for radiated emission is as follows:

1. 30 MHz to 9000 MHz for CDMA2000 BC0.
2. 30 MHz to 19000 MHz for CDMA2000 BC1.

Test Modes		
Band	Radiated TCs	Conducted TCs
CDMA2000 BC0	■ 1xRTT Link Mode	■ 1xRTT Link Mode
CDMA2000 BC1	■ 1xRTT Link Mode	■ 1xRTT Link Mode

Note: The maximum RF output power levels are 1xRTT RC1+SO55 mode for CDMA2000 BC0 on QPSK Link and 1xRTT RC1+SO55 mode for CDMA2000 BC1 on QPSK Link; only these modes were used for all tests.

The conducted power table is as follows:

Conducted Power (*Unit: dBm)						
Band	CDMA2000 BC0			CDMA2000 BC1		
Channel	1013	384	777	25	600	1175
Frequency	824.7	836.52	848.31	1851.25	1880	1908.75
1xRTT RC1 SO55	24.25	24.36	24.23	24.08	24.19	24.16
1xRTT RC3 SO55	24.20	24.33	24.19	23.96	24.10	24.12
1xRTT RC3 SO32(+ F-SCH)	24.11	24.30	24.08	23.96	24.07	24.10
1xRTT RC3 SO32(+SCH)	24.09	24.25	24.07	23.95	24.09	24.10
1xEV-DO RTAP 153.6kbps	24.01	24.26	24.03	23.94	24.06	24.08
1xEV-DO RETAP 4096Bits	24.10	24.27	24.12	23.97	24.03	24.07

2.2 Connection Diagram of Test System

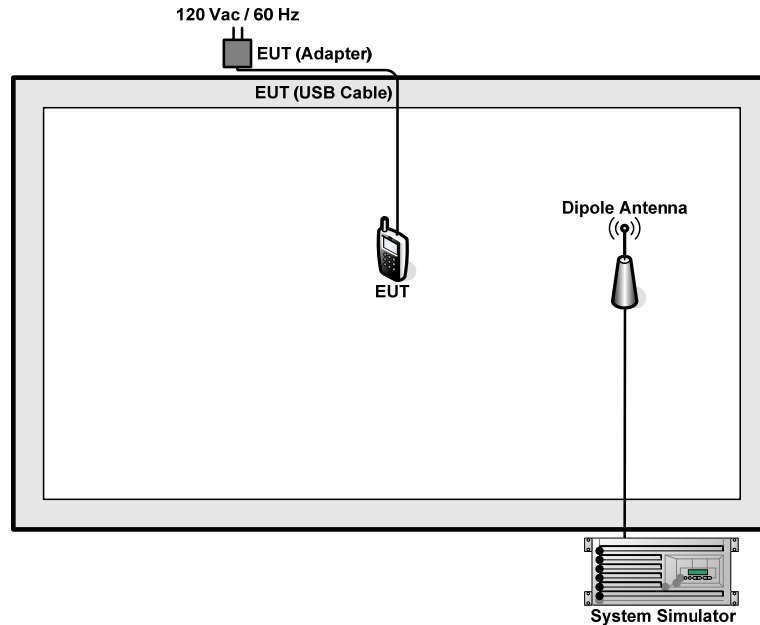

2.3 Support Unit used in test configuration and system

Item	Equipment	Trade Name	Model No.	FCC ID	Data Cable	Power Cord
1.	System Simulator	R&S	CMU 200	N/A	N/A	Unshielded, 1.8 m
2.	System Simulator	Agilent	E5515C	N/A	N/A	Unshielded, 1.8 m
3.	DC Power Supply	GWINSTEK	GPS-3030D	N/A	N/A	Unshielded, 1.8 m

2.4 Measurement Results Explanation Example

For all conducted test items:

The offset level is set in the spectrum analyzer to compensate the RF cable loss and attenuator factor between EUT conducted output port and spectrum analyzer. With the offset compensation, the spectrum analyzer reading level is exactly the EUT RF output level.

The spectrum analyzer offset is derived from RF cable loss and attenuator factor.

$Offset = RF\ cable\ loss + attenuator\ factor.$

Following shows an offset computation example with cable loss 5.2 dB and 10dB attenuator.

Example :

$$Offset(dB) = RF\ cable\ loss(dB) + attenuator\ factor(dB).$$

$$= 5.2 + 10 = 15.2 (dB)$$

3 Test Result

3.1 Conducted Output Power Measurement

3.1.1 Description of the Conducted Output Power Measurement

A base station simulator was used to establish communication with the EUT. Its parameters were set to transmit the maximum power on the EUT. The measured power in the radio frequency on the transmitter output terminals shall be reported.

3.1.2 Measuring Instruments

See list of measuring instruments of this test report.

3.1.3 Test Procedures

1. The transmitter output port was connected to base station.
2. Set EUT at maximum power through base station.
3. Select lowest, middle, and highest channels for each band and different modulation.
4. Measure the maximum burst average power for CDMA and maximum average power for other modulation signal.

3.1.4 Test Setup

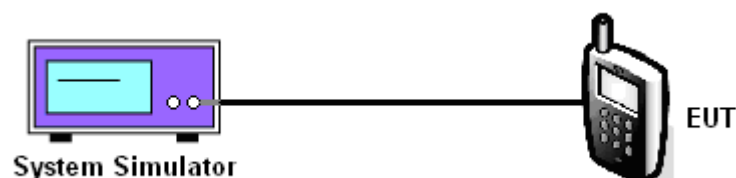

3.1.5 Test Result of Conducted Output Power

CDMA2000 BC0			
Test Mode	CDMA 2000 1xRTT		
Test Status	RC1+SO55		
Channel	1013 (Low)	384 (Mid)	777 (High)
Frequency (MHz)	824.7	836.52	848.31
Conducted Power (dBm)	24.25	24.36	24.23
Conducted Power (Watts)	0.27	0.27	0.26

CDMA2000 BC1			
Test Mode	CDMA 2000 1xRTT		
Test Status	RC1+SO55		
Channel	25 (Low)	600 (Mid)	1175 (High)
Frequency (MHz)	1851.25	1880	1908.75
Conducted Power (dBm)	24.08	24.19	24.16
Conducted Power (Watts)	0.26	0.26	0.26

Note: Maximum average power for CDMA2000.

3.2 Peak-to-Average Ratio

3.2.1 Description of the PAR Measurement

The peak-to-average ratio (PAR) of the transmission may not exceed 13 dB.

3.2.2 Measuring Instruments

See list of measuring instruments of this test report.

3.2.3 Test Procedures

1. The EUT was connected to Spectrum Analyzer and System Simulator via power divider.
2. Set the CCDF (Complementary Cumulative Distribution Function) option in spectrum analyzer.
3. The highest RF powers were measured and recorded the maximum PAPR level associated with a probability of 0.1 %.
4. Record the deviation as Peak to Average Ratio.

3.2.4 Test Setup

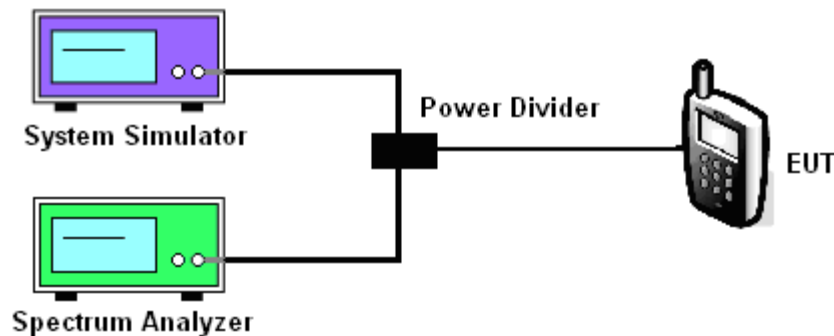

3.2.5 Test Result of Peak-to-Average Ratio

CDMA2000 BC1			
Modes	CDMA 2000 1xRTT		
Channel	25 (Low)	600 (Mid)	1175 (High)
Frequency (MHz)	1851.25	1880	1908.75
Peak-to-Average Ratio (dB)	3.84	4.00	3.68



3.2.6 Test Result (Plots) of Peak-to-Average Ratio

Band :	CDMA2000 BC1	Test Mode :	1xRTT_RC1+SO55 Link (QPSK)
--------	--------------	-------------	----------------------------

Peak-to-Average Ratio on Channel 25 (1851.25 MHz)

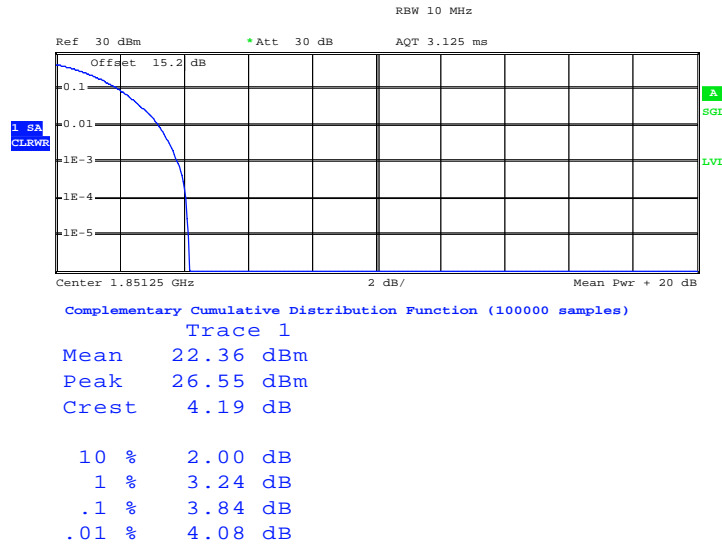

I

Peak-to-Average Ratio on Channel 600 (1880 MHz)

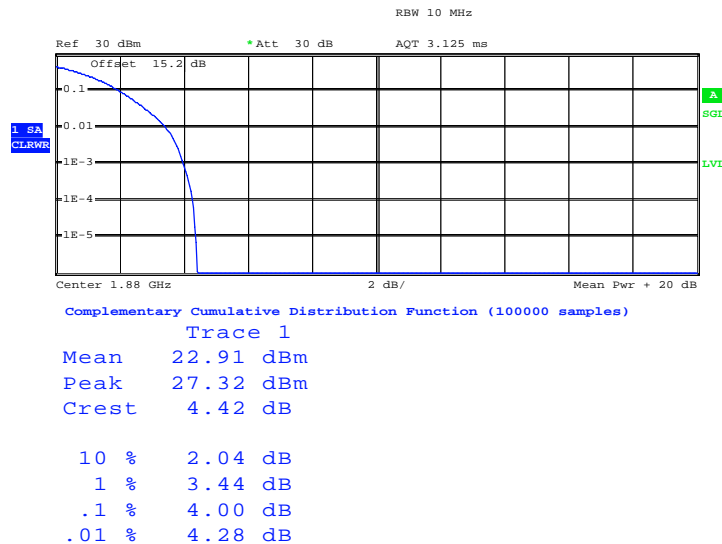

I



Peak-to-Average Ratio on Channel 1175 (1908.75 MHz)

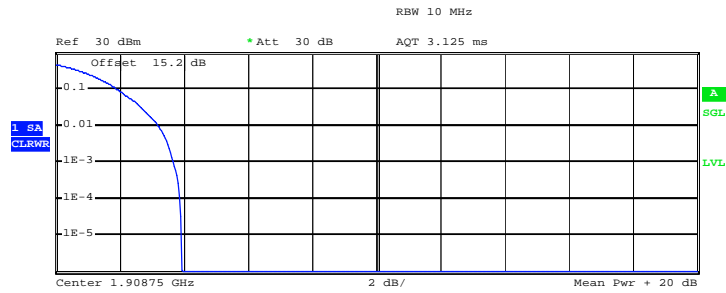

Complementary Cumulative Distribution Function (100000 samples)

Trace 1
Mean 22.55 dBm
Peak 26.47 dBm
Crest 3.93 dB

10 %	1.96 dB
1 %	3.24 dB
.1 %	3.68 dB
.01 %	3.88 dB

3.3 Effective Radiated Power and Effective Isotropic Radiated Power Measurement

3.3.1 Description of the ERP/EIRP Measurement

The substitution method, in ANSI / TIA / EIA-603-C-2004, was used for ERP/EIRP measurement, and the spectrum analyzer configuration follows KDB 971168 D01 Power Meas. License Digital Systems v02r01. The ERP of mobile transmitters must not exceed 7 Watts and the EIRP of mobile transmitters are limited to 2 Watts.

3.3.2 Measuring Instruments

See list of measuring instruments of this test report.

3.3.3 Test Procedures

1. The EUT was placed on a turntable with 1.5 meter height in a fully anechoic chamber.
2. The EUT was set at 3 meters from the receiving antenna, which was mounted on the antenna tower.
3. CDMA2000 operating modes: Set RBW= 100 kHz, VBW= 300 kHz, RMS detector over frame, and use channel power option with bandwidth=5MHz, per KDB 971168 D01.
4. The table was rotated 360 degrees to determine the position of the highest radiated power.
5. The height of the receiving antenna is adjusted to look for the maximum ERP/EIRP.
6. Taking the record of maximum ERP/EIRP.
7. A dipole antenna was substituted in place of the EUT and was driven by a signal generator.
8. The conducted power at the terminal of the dipole antenna is measured.
9. Repeat step 3 to step 5 to get the maximum ERP/EIRP of the substitution antenna.
10. $ERP/EIRP = P_s + E_t - E_s + G_s = P_s + R_t - R_s + G_s$

P_s (dBm) : Input power to substitution antenna.

G_s (dBi or dBd) : Substitution antenna Gain.

$E_t = R_t + AF$

$E_s = R_s + AF$

AF (dB/m) : Receive antenna factor

R_t : The highest received signal in spectrum analyzer for EUT.

R_s : The highest received signal in spectrum analyzer for substitution antenna.

3.3.4 Test Setup

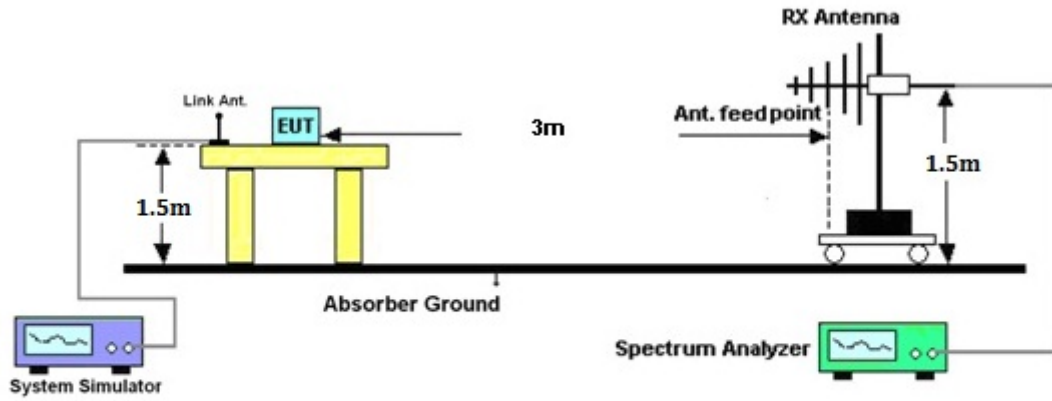

3.3.5 Test Result of ERP

CDMA2000 BC0 1xRTT_RC1+SO55 Radiated Power ERP						
Horizontal Polarization						
Frequency (MHz)	Rt (dBm)	Rs (dBm)	Ps (dBm)	Gs (dBd)	ERP (dBm)	ERP (W)
824.70	-26.98	-48.12	0.00	-1.08	20.06	0.10
836.52	-25.43	-48.28	0.00	-0.93	21.92	0.16
848.31	-25.96	-48.35	0.00	-0.76	21.63	0.15
Vertical Polarization						
Frequency (MHz)	Rt (dBm)	Rs (dBm)	Ps (dBm)	Gs (dBd)	ERP (dBm)	ERP (W)
824.70	-32.79	-47.97	0.00	-1.08	14.10	0.03
836.52	-31.40	-48.01	0.00	-0.93	15.68	0.04
848.31	-31.76	-48.05	0.00	-0.76	15.53	0.04

3.3.6 Test Result of EIRP

CDMA2000 BC1 1xRTT_RC1+SO55 Radiated Power EIRP						
Horizontal Polarization						
Frequency (MHz)	Rt (dBm)	Rs (dBm)	Ps (dBm)	Gs (dBi)	EIRP (dBm)	EIRP (W)
1851.25	-33.75	-51.88	0.00	1.96	20.09	0.10
1880.00	-33.55	-52.99	0.00	2.00	21.44	0.14
1908.75	-33.71	-54.28	0.00	1.98	22.55	0.18
Vertical Polarization						
Frequency (MHz)	Rt (dBm)	Rs (dBm)	Ps (dBm)	Gs (dBi)	EIRP (dBm)	EIRP (W)
1851.25	-33.63	-52.13	0.00	1.96	20.46	0.11
1880.00	-33.41	-53.17	0.00	2.00	21.76	0.15
1908.75	-33.28	-54.13	0.00	1.98	22.83	0.19

3.4 99% Occupied Bandwidth and 26dB Bandwidth Measurement

3.4.1 Description of 99% Occupied Bandwidth and 26dB Bandwidth Measurement

The 99% occupied bandwidth is the width of a frequency band such that, below the lower and above the upper frequency limits, the mean powers emitted are each equal to a specified percentage 0.5% of the total mean transmitted power.

The emission bandwidth is defined as the width of the signal between two points, located at the 2 sides of the carrier frequency, outside of which all emissions are attenuated at least 26 dB below the transmitter power.

3.4.2 Measuring Instruments

See list of measuring instruments of this test report.

3.4.3 Test Procedures

1. The EUT was connected to Spectrum Analyzer and Base Station via power divider.
2. The RF output of EUT was connected to the spectrum analyzer by RF cable and attenuator. The path loss was compensated to the results for each measurement.
3. The 99% occupied bandwidth were measured, set RBW= 1% of span, VBW= 3*RBW, sample detector, trace maximum hold.
4. The 26dB bandwidth were measured, set RBW= 1% of EBW, VBW= 3*RBW, peak detector, trace maximum hold.

3.4.4 Test Setup

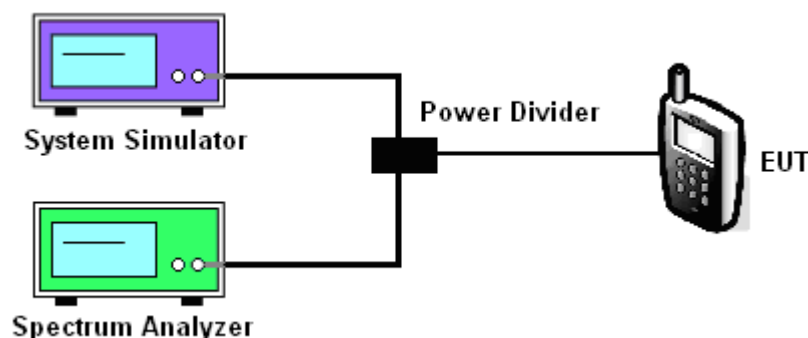



3.4.5 Test Result of 99% Occupied Bandwidth and 26dB Bandwidth

CDMA2000 BC0			
Test Mode	CDMA 2000 1xRTT		
Test Status	RC1+SO55		
Channel	1013 (Low)	384 (Mid)	777 (High)
Frequency (MHz)	824.70	836.52	848.31
99% OBW (MHz)	1.276	1.272	1.272
26dB BW (MHz)	1.424	1.440	1.428

CDMA2000 BC1			
Test Mode	CDMA 2000 1xRTT		
Test Status	RC1+SO55		
Channel	25 (Low)	600 (Mid)	1175 (High)
Frequency (MHz)	1851.25	1880.00	1908.75
99% OBW (MHz)	1.276	1.276	1.272
26dB BW (MHz)	1.420	1.416	1.424



3.4.6 Test Result (Plots) of Occupied Bandwidth and 26dB Bandwidth

Band :	CDMA2000 BC0	Test Mode :	1xRTT_RC1+SO55 Link (QPSK)
--------	--------------	-------------	----------------------------

99% Occupied Bandwidth Plot on Channel 1013 (824.7 MHz)

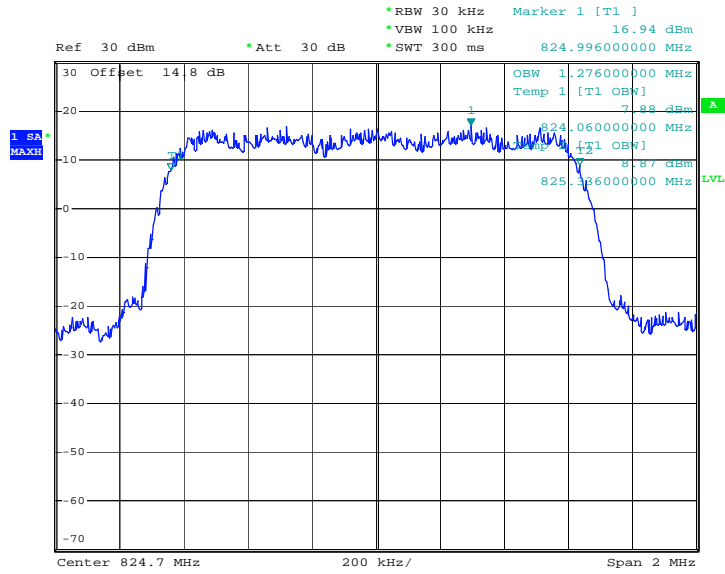

26dB Bandwidth Plot on Channel 1013 (824.7 MHz)

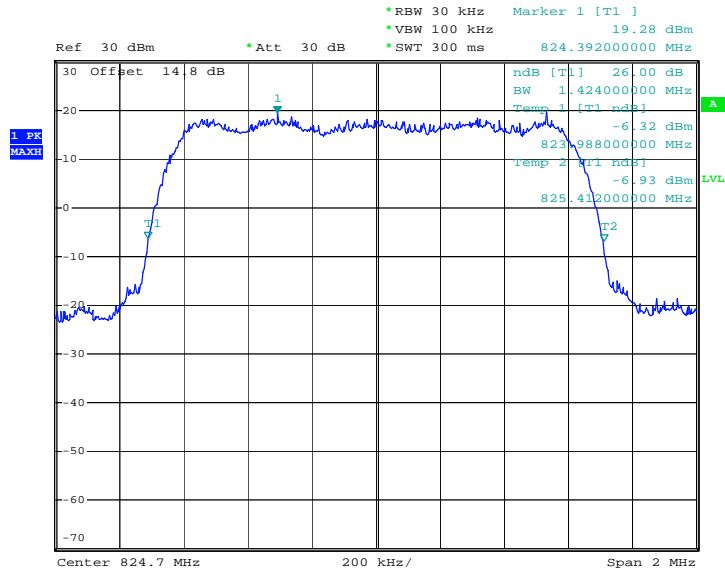

Date : 24.SEP.2013 19:43:07



99% Occupied Bandwidth Plot on Channel 384 (836.52 MHz)

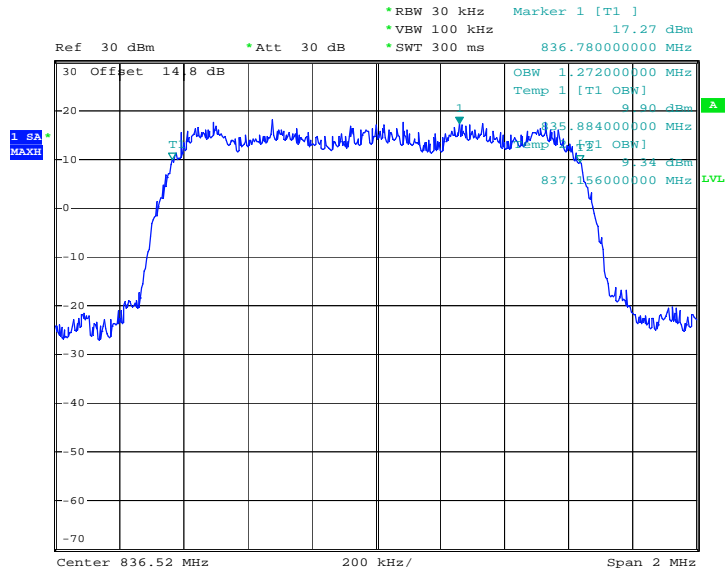

26dB Bandwidth Plot on Channel 384 (836.52 MHz)

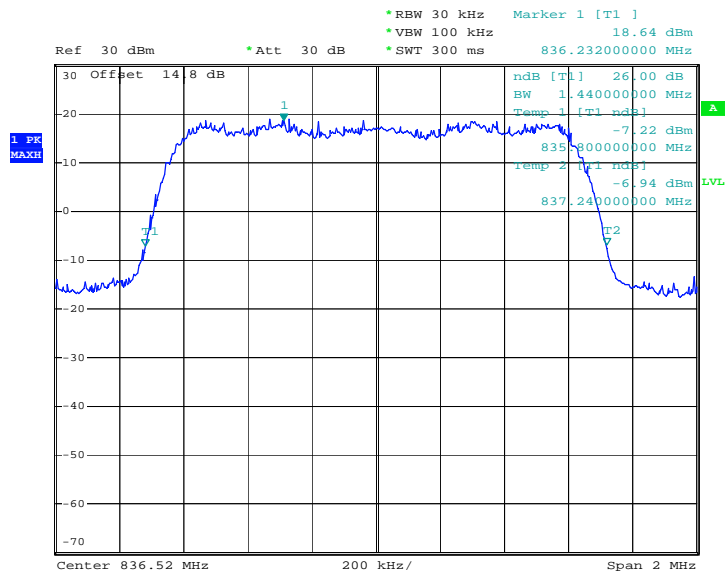



99% Occupied Bandwidth Plot on Channel 777 (848.31 MHz)

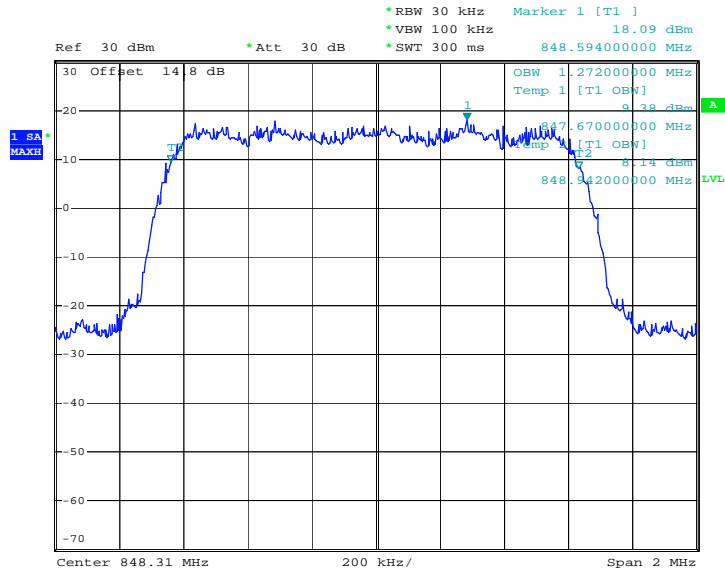

26dB Bandwidth Plot on Channel 777 (848.31 MHz)

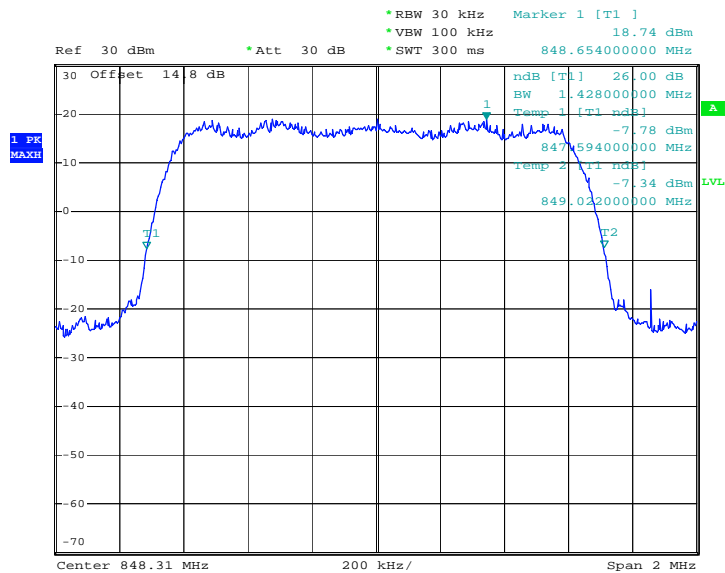

Date: 24.SEP.2013 19:43:40



Band :	CDMA2000 BC1	Test Mode :	1xRTT_RC1+S055 Link (QPSK)
--------	--------------	-------------	----------------------------

99% Occupied Bandwidth Plot on Channel 25 (1851.25 MHz)

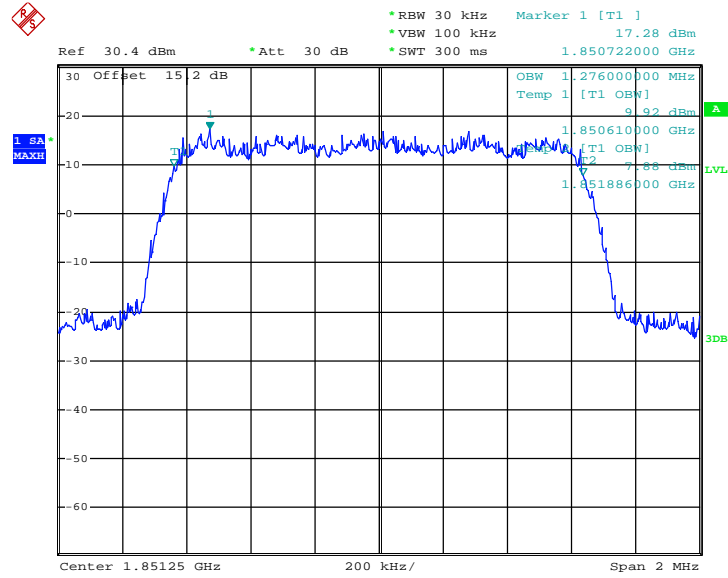

26dB Bandwidth Plot on Channel 25 (1851.25 MHz)

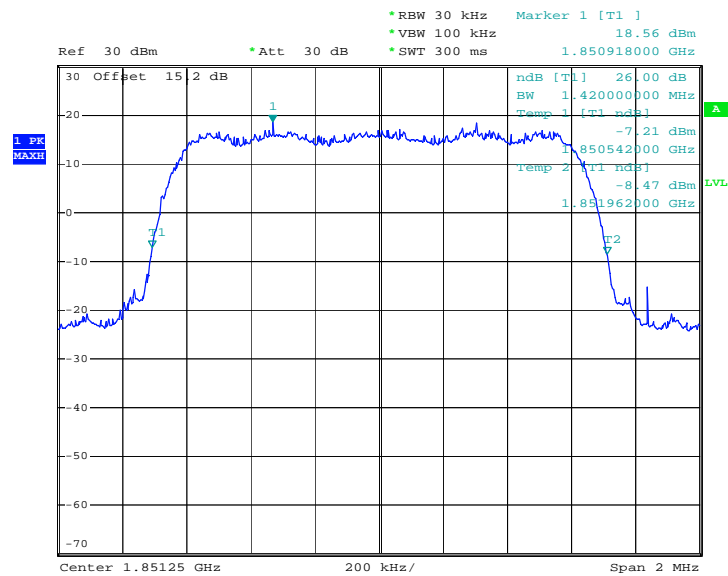



99% Occupied Bandwidth Plot on Channel 600 (1880.0 MHz)

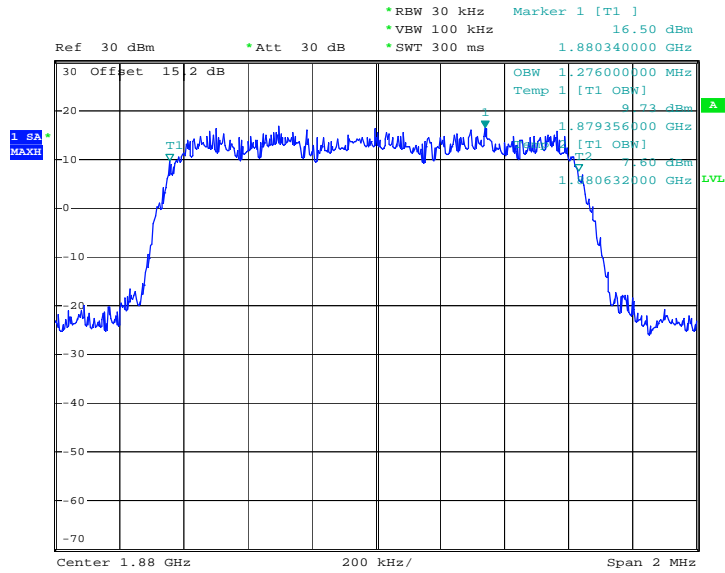

26dB Bandwidth Plot on Channel 600 (1880.0 MHz)

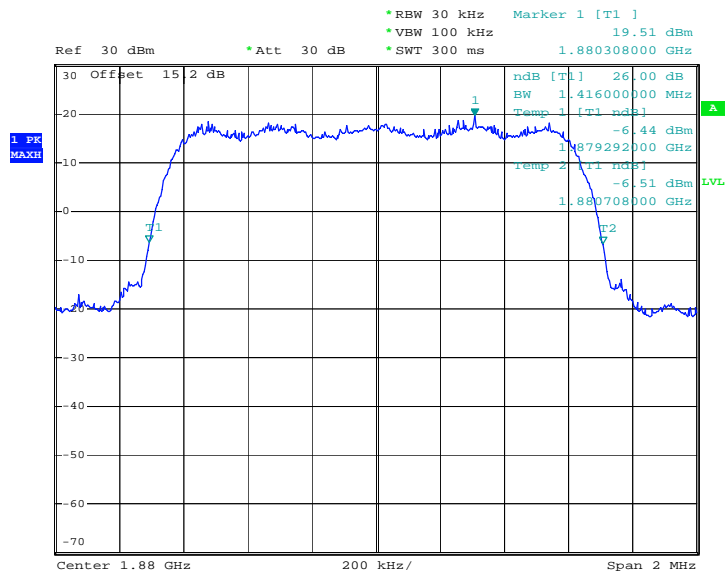



99% Occupied Bandwidth Plot on Channel 1175 (1908.75 MHz)

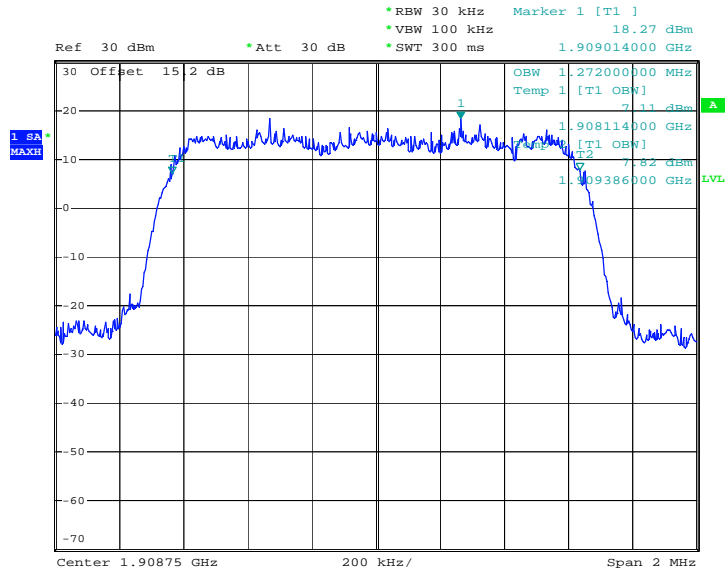

26dB Bandwidth Plot on Channel 1175 (1908.75 MHz)

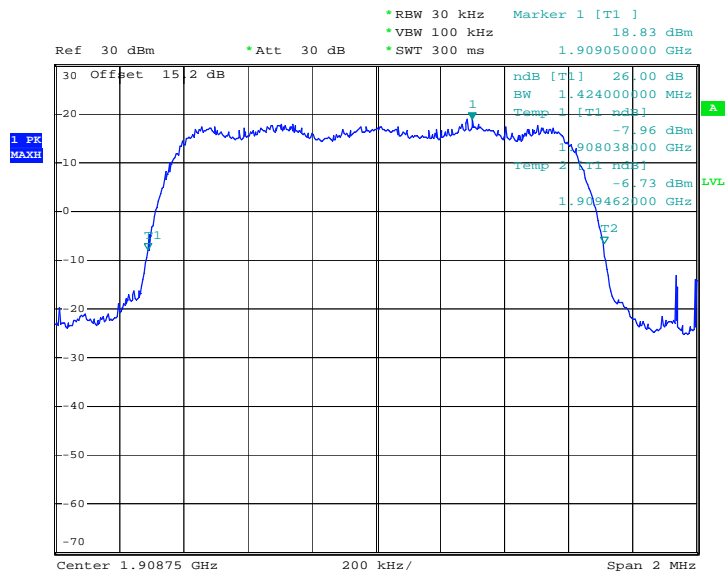

3.5 Band Edge Measurement

3.5.1 Description of Band Edge Measurement

The power of any emission outside of the authorized operating frequency ranges must be lower than the transmitter power (P) by a factor of at least $43 + 10 \log (P)$ dB.

3.5.2 Measuring Instruments

See list of measuring instruments of this test report.

3.5.3 Test Procedures

1. The EUT was connected to Spectrum Analyzer and Base Station via power divider.
2. The RF output of EUT was connected to the spectrum analyzer by RF cable and attenuator. The path loss was compensated to the results for each measurement.
3. The band edges of low and high channels for the highest RF powers were measured. Setting RBW as roughly $BW/100$.
4. The RBW was replaced by 10 kHz, slightly smaller than the value in (3), due to the spectrum analyzer limitation to set the exact value. A worst case correction factor of $10 \cdot \log (1\% \text{ emission-BW/measurement RBW})$ was compensated.
5. The RF fundamental frequency should be excluded against the limit line in the operating frequency band.
6. The limit line is derived from $43 + 10\log(P)$ dB below the transmitter power P(Watts)

$$= P(W) - [43 + 10\log(P)] \text{ (dB)}$$

$$= [30 + 10\log(P)] \text{ (dBm)} - [43 + 10\log(P)] \text{ (dB)}$$

$$= -13\text{dBm}.$$

3.5.4 Test Setup

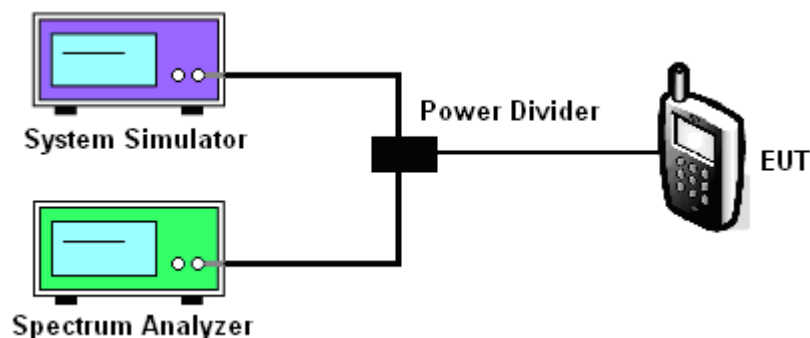



3.5.5 Test Result (Plots) of Conducted Band Edge

Band :	CDMA2000 BC0	Test Mode :	1xRTT_RC1+SO55 Link (QPSK)
Correction Factor :	1.58dB	Maximum 26dB Bandwidth :	1.440MHz
Band Edge :	-19.07dBm	Measurement Value :	-20.65dBm

Lower Band Edge Plot on Channel 1013 (824.7 MHz)

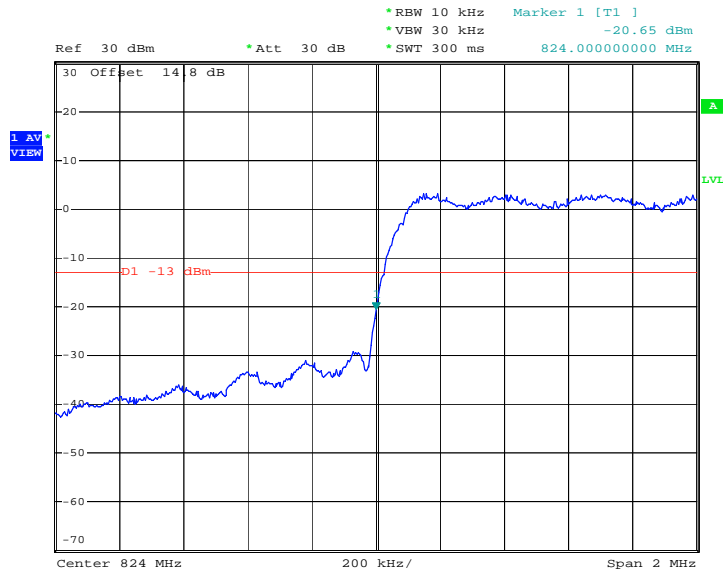

1. Correction Factor(dB)= 10log(1% Emission BW/RBW)
2. Band Edge= Measurement Value + Correction Factor(dB)



Band :	CDMA2000 BC0	Test Mode :	1xRTT_RC1+SO55 Link (QPSK)
Correction Factor :	1.58dB	Maximum 26dB Bandwidth :	1.440MHz
Band Edge :	-14.75dBm	Measurement Value :	-16.33dBm

Higher Band Edge Plot on Channel 777 (848.31 MHz)

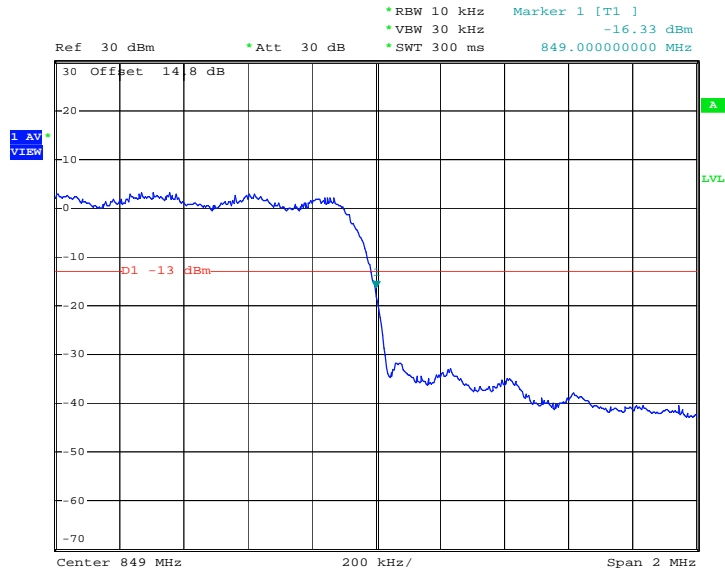

1. Correction Factor(dB)= $10\log(1\% \text{ Emission BW/RBW})$
2. Band Edge= Measurement Value + Correction Factor(dB)



Band :	CDMA2000 BC1	Test Mode :	1xRTT_RC1+SO55 Link (QPSK)
Correction Factor :	1.54dB	Maximum 26dB Bandwidth:	1.424MHz
Band Edge :	-34.00dBm	Measurement Value :	-35.54dBm

Lower Band Edge Plot on Channel 25 (1851.25 MHz)

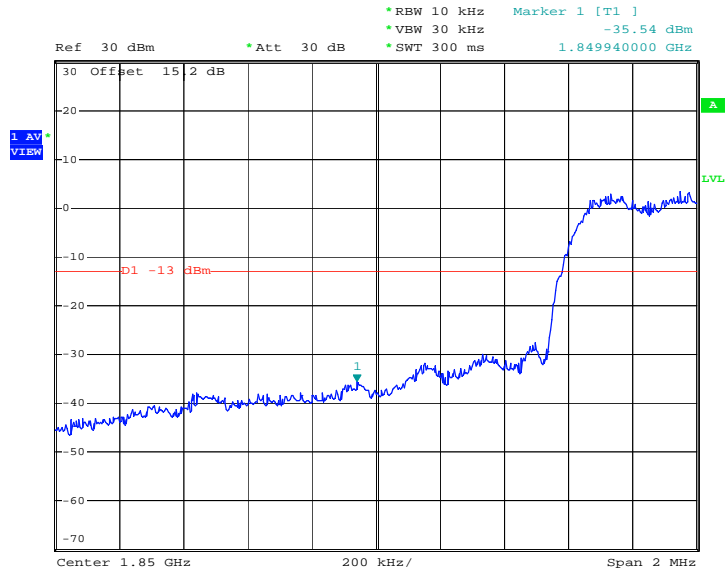

1. Correction Factor(dB)= 10log(1% Emission BW/RBW)
2. Band Edge= Measurement Value + Correction Factor(dB)



Band :	CDMA2000 BC1	Test Mode :	1xRTT_RC1+SO55 Link (QPSK)
Correction Factor :	1.54dB	Maximum 26dB Bandwidth:	1.424MHz
Band Edge :	-35.95dBm	Measurement Value :	-37.49dBm

Higher Band Edge Plot on Channel 1175 (1908.75 MHz)



1. Correction Factor(dB)= 10log(1% Emission BW/RBW)
2. Band Edge= Measurement Value + Correction Factor(dB)

3.6 Conducted Spurious Emission Measurement

3.6.1 Description of Conducted Emission Measurement

The power of any emission outside of the authorized operating frequency ranges must be lower than the transmitter power (P) by a factor of at least $43 + 10 \log (P)$ dB.

It is measured by means of a calibrated spectrum analyzer and scanned from 30 MHz up to a frequency including its 10th harmonic.

3.6.2 Measuring Instruments

See list of measuring instruments of this test report.

3.6.3 Test Procedures

1. The EUT was connected to spectrum analyzer and base station via power divider.
2. The RF output of EUT was connected to the spectrum analyzer by RF cable and attenuator. The path loss was compensated to the results for each measurement.
3. The middle channel for the highest RF power within the transmitting frequency was measured.
4. The conducted spurious emission for the whole frequency range was taken.
5. The RF fundamental frequency should be excluded against the limit line in the operating frequency band.
6. The limit line is derived from $43 + 10\log(P)$ dB below the transmitter power P(Watts)

$$= P(W) - [43 + 10\log(P)] \text{ (dB)}$$

$$= [30 + 10\log(P)] \text{ (dBm)} - [43 + 10\log(P)] \text{ (dB)}$$

$$= -13\text{dBm}.$$

3.6.4 Test Setup

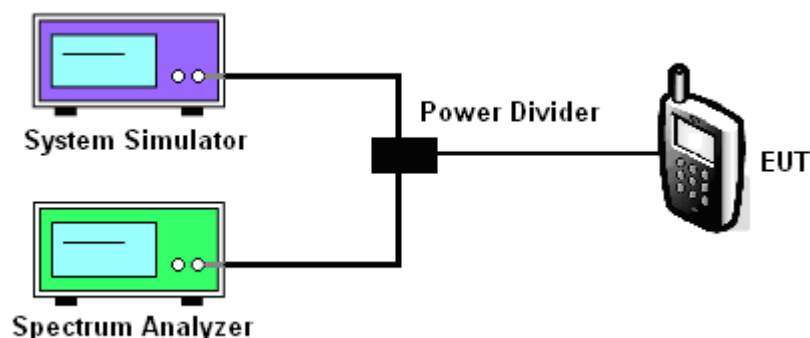



3.6.5 Test Result (Plots) of Conducted Spurious Emission

Band :	CDMA2000 BC0	Channel	384
Test Mode :	1xRTT_RC1+SO55 Link (QPSK)	Frequency :	836.52 MHz

Conducted Spurious Emission Plot between 30MHz ~ 1GHz

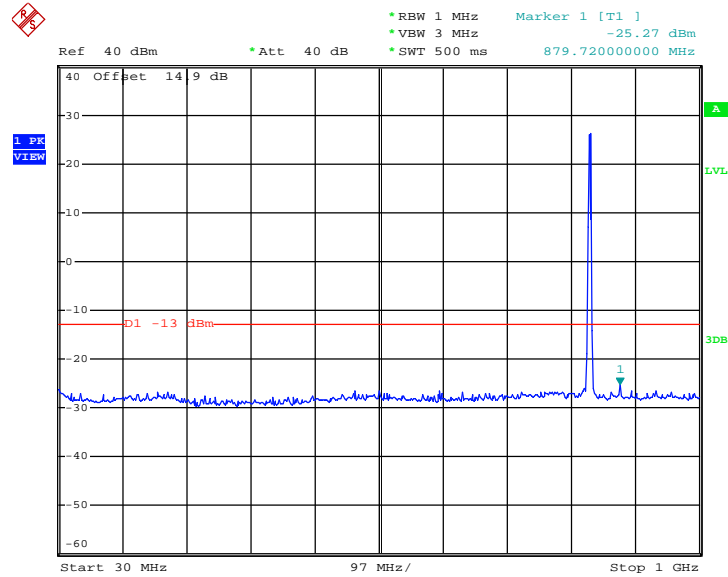

Conducted Spurious Emission Plot between 1GHz ~ 3GHz

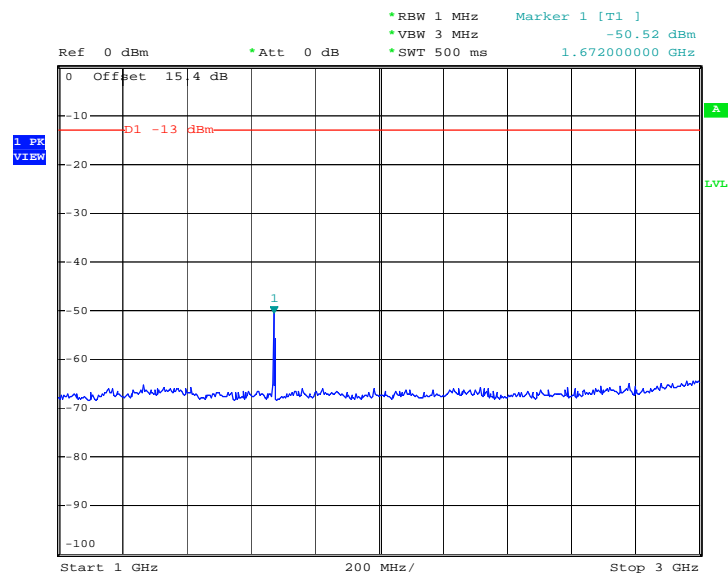



Conducted Spurious Emission Plot between 3GHz ~ 7GHz

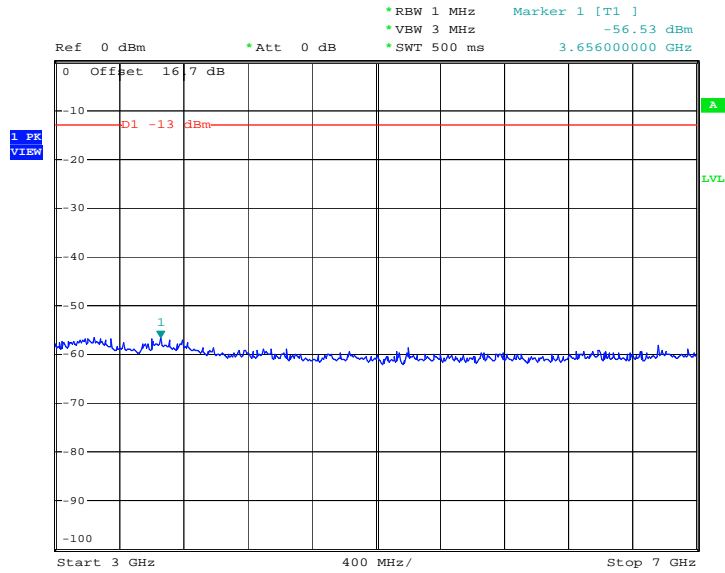

Conducted Spurious Emission Plot between 7GHz ~ 9GHz

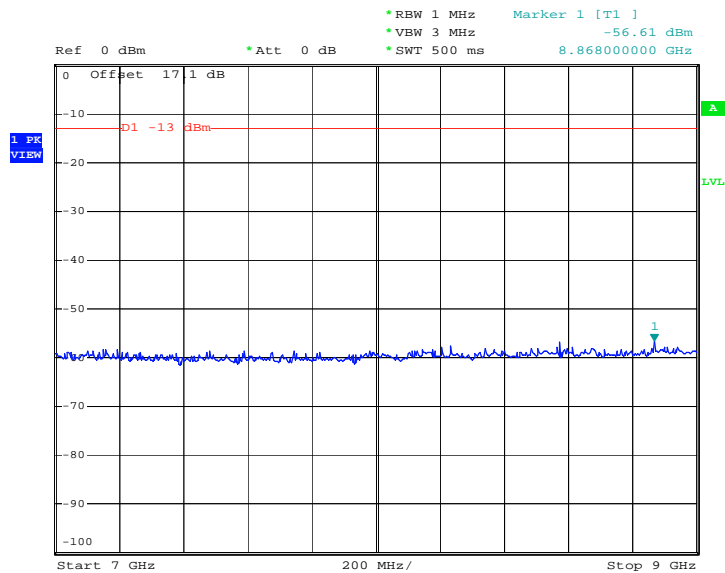



Band :	CDMA2000 BC1	Channel	600
Test Mode :	1xRTT_RC1+SO55 Link (QPSK)	Frequency :	1880.0 MHz

Conducted Spurious Emission Plot between 30MHz ~ 1GHz

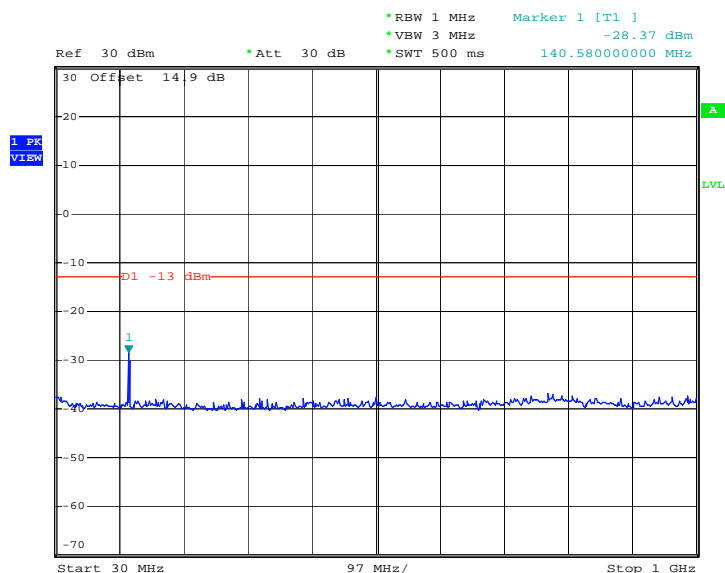

Conducted Spurious Emission Plot between 1GHz ~ 3GHz

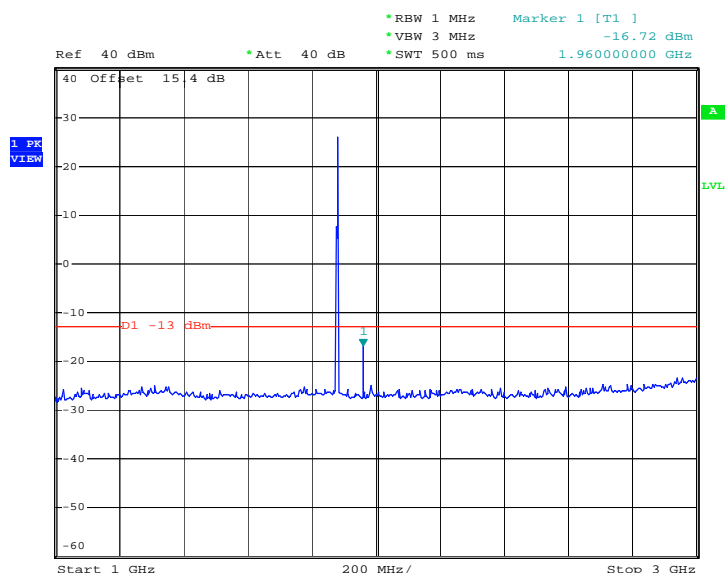



Conducted Spurious Emission Plot between 3GHz ~ 7GHz

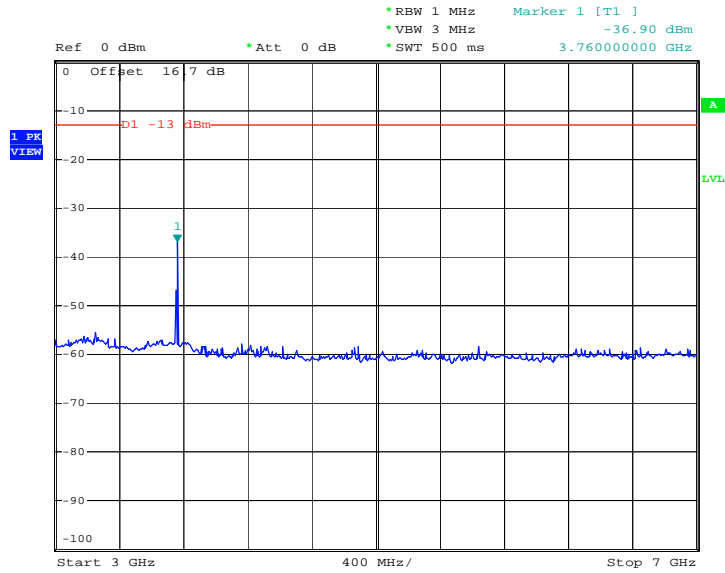

Conducted Spurious Emission Plot between 7GHz ~ 13.6GHz

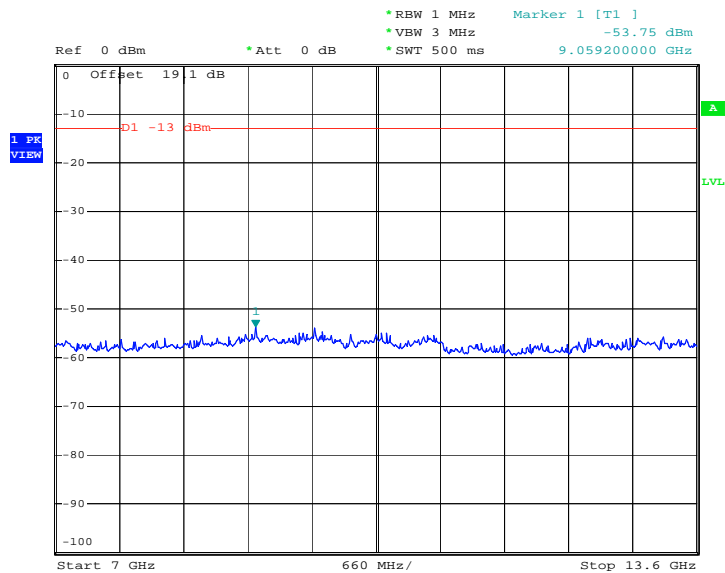



Conducted Spurious Emission Plot between 13.6GHz ~ 19.1GHz

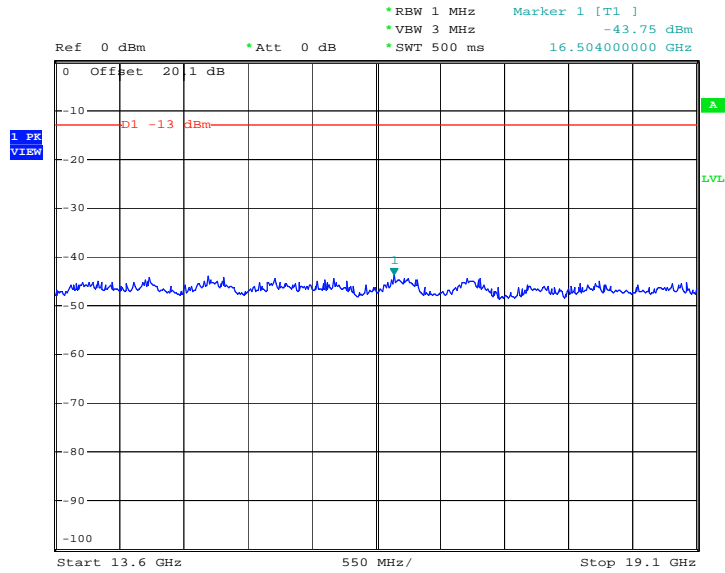

3.7 Field Strength of Spurious Radiation Measurement

3.7.1 Description of Field Strength of Spurious Radiated Measurement

The power of any emission outside of the authorized operating frequency ranges must be attenuated below the transmitter power (P) by a factor of at least $43+10\log_{10}(P[\text{Watts}])$ dB. The spectrum is scanned from 30 MHz up to a frequency including its 10th harmonic.

3.7.2 Measuring Instruments

See list of measuring instruments of this test report.

3.7.3 Test Procedures

1. The EUT was placed on a rotatable wooden table with 0.8 meter above ground.
2. The EUT was set 3 meters from the receiving antenna, which was mounted on the antenna tower.
3. The table was rotated 360 degrees to determine the position of the highest spurious emission.
4. The height of the receiving antenna is varied between one meter and four meters to search the maximum spurious emission for both horizontal and vertical polarizations.
5. Make the measurement with the spectrum analyzer's RBW = 1MHz, VBW = 3MHz, taking the record of maximum spurious emission.
6. A horn antenna was substituted in place of the EUT and was driven by a signal generator.
7. Tune the output power of signal generator to the same emission level with EUT maximum spurious emission.
8. Taking the record of output power at antenna port.
9. Repeat step 7 to step 8 for another polarization.
10. $\text{EIRP (dBm)} = \text{S.G. Power} - \text{Tx Cable Loss} + \text{Tx Antenna Gain}$
11. $\text{ERP (dBm)} = \text{EIRP} - 2.15$
12. The RF fundamental frequency should be excluded against the limit line in the operating frequency band.
13. The limit line is derived from $43 + 10\log(P)$ dB below the transmitter power P(Watts)
 $= P(\text{W}) - [43 + 10\log(P)] (\text{dB})$
 $= [30 + 10\log(P)] (\text{dBm}) - [43 + 10\log(P)] (\text{dB})$
 $= -13\text{dBm}.$

3.7.4 Test Setup

For radiated emissions from 30MHz to 1GHz

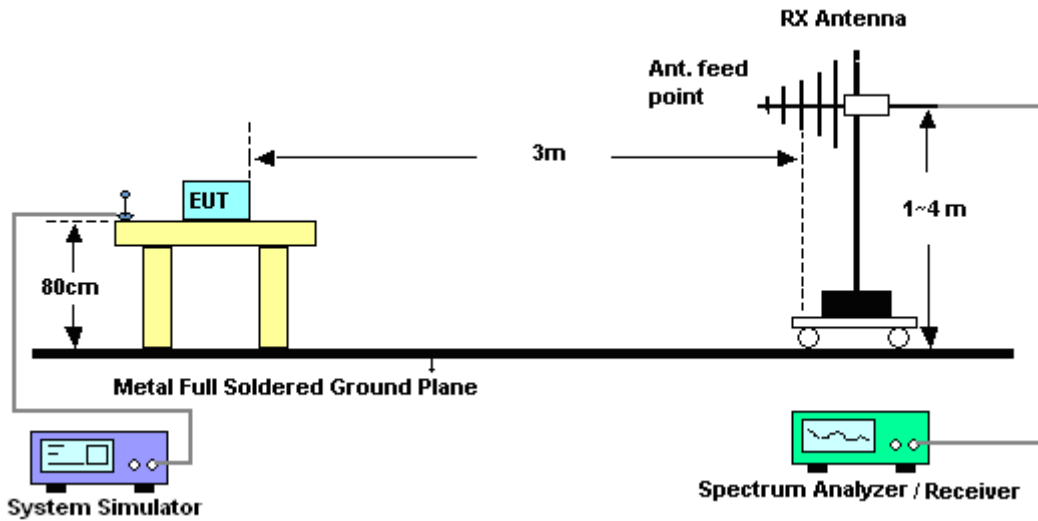

For radiated emissions above 1GHz

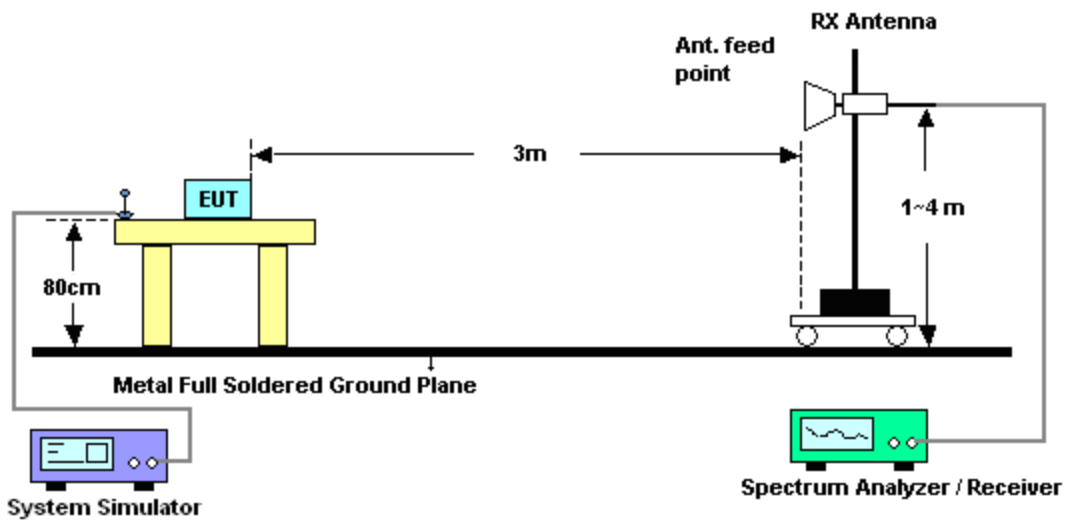



3.7.5 Test Result of Field Strength of Spurious Radiated

Band :	CDMA2000 BC0	Temperature :	23~25°C
Test Mode :	1xRTT_RC1+SO55 Link (QPSK)	Relative Humidity :	48~52%
Test Engineer :	Gavin Zhang	Polarization :	Horizontal
Remark :	Spurious emissions within 30-1000MHz were found more than 20dB below limit line.		

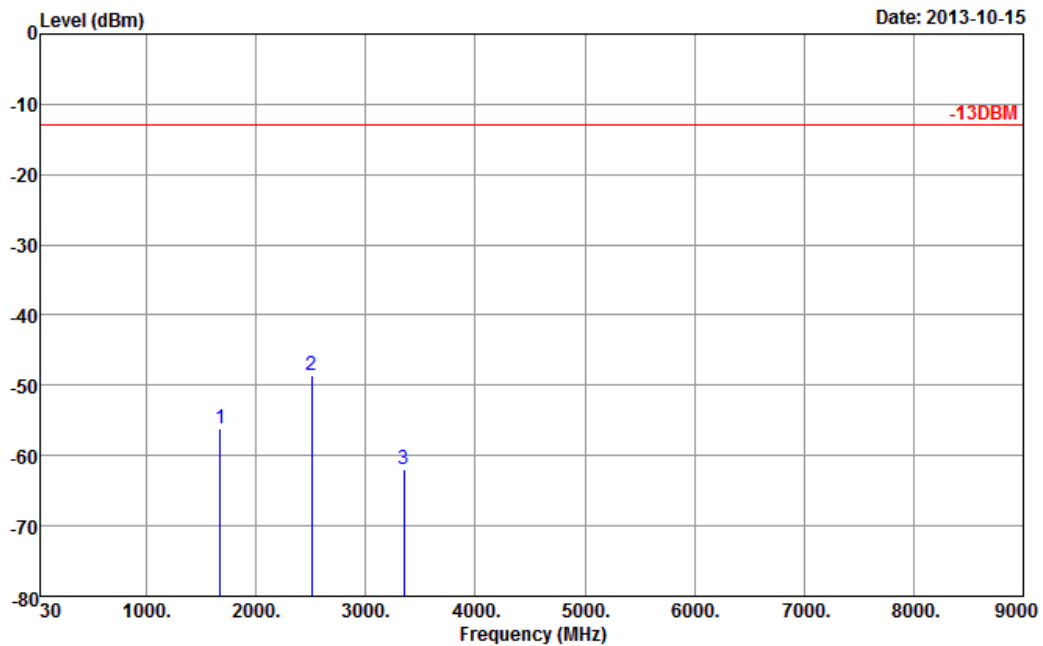

Site : 03CH01-SZ
 Condition : -13DBM HF EIRP H_130101 HORIZONTAL

Plane : Z

Frequency (MHz)	ERP (dBm)	Limit (dBm)	Over Limit (dB)	SPA Reading (dBm)	S.G. Power (dBm)	TX Cable loss (dB)	TX Antenna Gain (dBi)	Polarization (H/V)	Result
1672	-56.12	-13	-43.12	-69.04	-59.09	0.88	6.00	H	Pass
2510	-48.66	-13	-35.66	-70.31	-51.27	1.08	5.84	H	Pass
3346	-61.89	-13	-48.89	-72.49	-66.26	1.14	7.66	H	Pass



Band :	CDMA2000 BC0	Temperature :	23~25°C
Test Mode :	1xRTT_RC1+SO55 Link (QPSK)	Relative Humidity :	48~52%
Test Engineer :	Gavin Zhang	Polarization :	Vertical
Remark :	Spurious emissions within 30-1000MHz were found more than 20dB below limit line.		

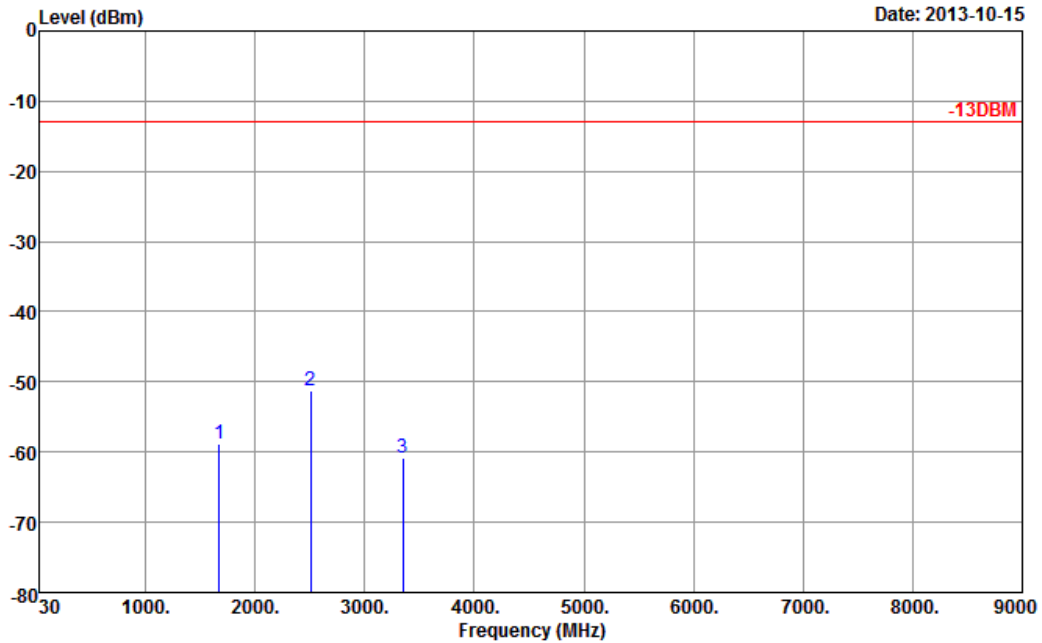

Site : 03CH01-SZ
 Condition : -13DBM HF EIRP V 130101 VERTICAL

Plane : Z

Frequency (MHz)	ERP (dBm)	Limit (dBm)	Over Limit (dB)	SPA Reading (dBm)	S.G. Power (dBm)	TX Cable loss (dB)	TX Antenna Gain (dBi)	Polarization (H/V)	Result
1672	-58.75	-13	-45.75	-69.38	-61.72	0.88	6.00	V	Pass
2510	-51.17	-13	-38.17	-70.51	-53.78	1.08	5.84	V	Pass
3346	-60.93	-13	-47.93	-72.76	-65.30	1.14	7.66	V	Pass



Band :	CDMA2000 BC1	Temperature :	23~25°C
Test Mode :	1xRTT_RC1+SO55 Link (QPSK)	Relative Humidity :	48~52%
Test Engineer :	Gavin Zhang	Polarization :	Horizontal
Remark :	Spurious emissions within 30-1000MHz were found more than 20dB below limit line.		

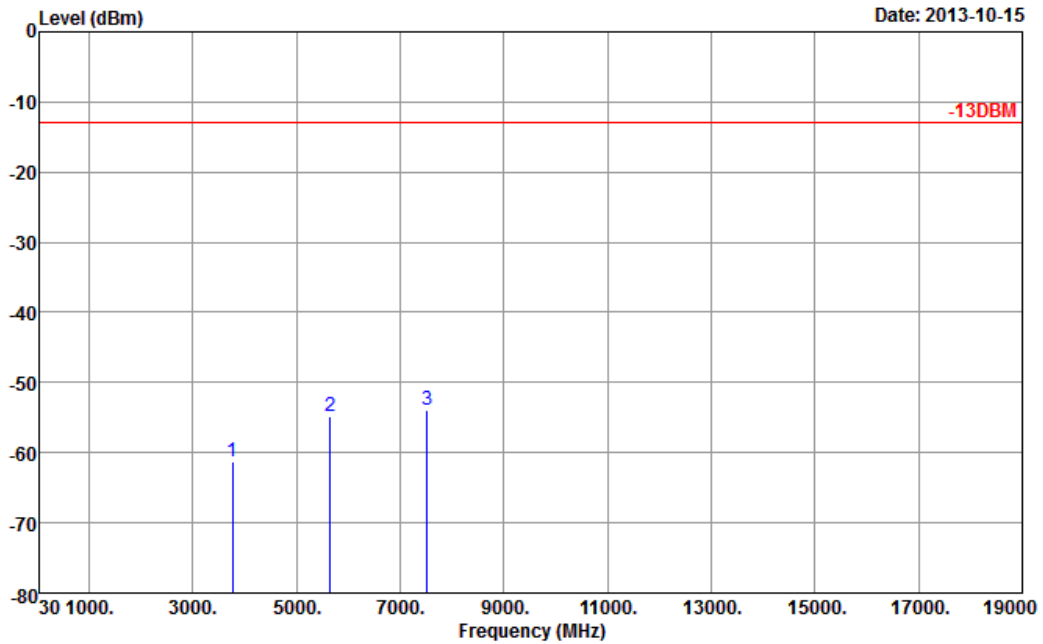

Site : 03CH01-SZ
 Condition : -13DBM HF_EIRP_H_130101 HORIZONTAL

Plane : Z

Frequency (MHz)	EIRP (dBm)	Limit (dBm)	Over Limit (dB)	SPA Reading (dBm)	S.G. Power (dBm)	TX Cable loss (dB)	TX Antenna Gain (dBi)	Polarization (H/V)	Result
3760	-61.32	-13	-48.32	-73.47	-68.06	1.28	8.02	H	Pass
5640	-54.91	-13	-41.91	-72.90	-63.33	1.58	10.00	H	Pass
7520	-53.82	-13	-40.82	-75.76	-64.14	1.78	12.10	H	Pass



Band :	CDMA2000 BC1	Temperature :	23~25°C
Test Mode :	1xRTT_RC1+SO55 Link (QPSK)	Relative Humidity :	48~52%
Test Engineer :	Gavin Zhang	Polarization :	Vertical
Remark :	Spurious emissions within 30-1000MHz were found more than 20dB below limit line.		

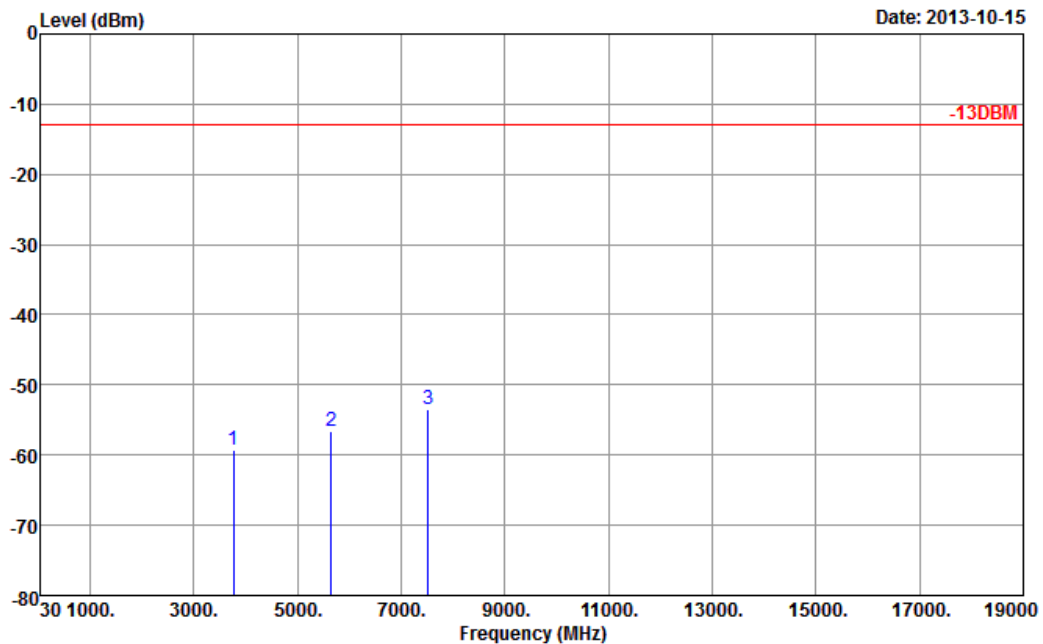

Site : 03CH01-SZ
 Condition : -13DBM HF_EIRP_V_130101 VERTICAL

Plane : Z

Frequency (MHz)	EIRP (dBm)	Limit (dBm)	Over Limit (dB)	SPA Reading (dBm)	S.G. Power (dBm)	TX Cable loss (dB)	TX Antenna Gain (dBi)	Polarization (H/V)	Result
3760	-59.20	-13	-46.20	-74.23	-65.94	1.28	8.02	V	Pass
5640	-56.67	-13	-43.67	-73.75	-65.09	1.58	10	V	Pass
7520	-53.43	-13	-40.43	-75.68	-63.75	1.78	12.1	V	Pass

3.8 Frequency Stability Measurement

3.8.1 Description of Frequency Stability Measurement

The frequency stability shall be measured by variation of ambient temperature and variation of primary supply voltage to ensure that the fundamental emission stays within the authorized frequency block. The frequency stability of the transmitter shall be maintained within $\pm 0.00025\%$ ($\pm 2.5\text{ppm}$) of the center frequency.

3.8.2 Measuring Instruments

See list of measuring instruments of this test report.

3.8.3 Test Procedures for Temperature Variation

1. The EUT was set up in the thermal chamber and connected with the base station.
2. With power OFF, the temperature was decreased to -30°C and the EUT was stabilized before testing. Power was applied and the maximum change in frequency was recorded within one minute.
3. With power OFF, the temperature was raised in 10°C step up to 50°C . The EUT was stabilized at each step for at least half an hour. Power was applied and the maximum frequency change was recorded within one minute.

3.8.4 Test Procedures for Voltage Variation

1. The EUT was placed in a temperature chamber at $25\pm 5^{\circ}\text{C}$ and connected with the base station.
2. The power supply voltage to the EUT was varied from BEP to 115% of the nominal value measured at the input to the EUT.
3. The variation in frequency was measured for the worst case.

3.8.5 Test Setup

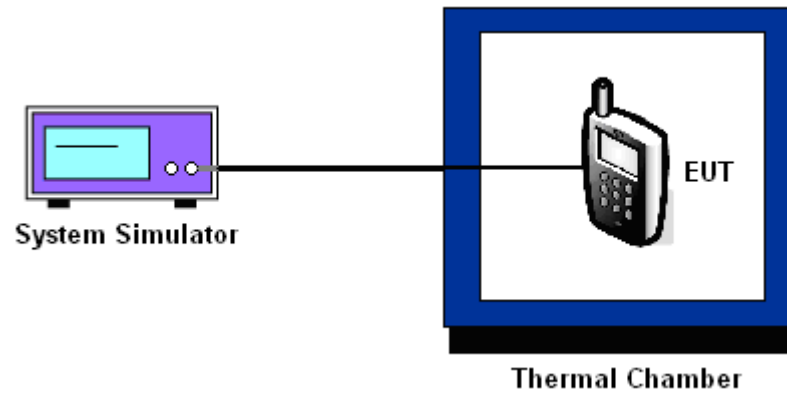



3.8.6 Test Result of Temperature Variation

Band :	CDMA2000 BC0 1xRTT_RC1+SO55	Channel :	384
Limit (ppm) :	2.5	Frequency :	836.52 MHz

Temperature (°C)	Freq. Dev. (Hz)	Deviation (ppm)	Result
-30	28	+0.03	PASS
-20	-26	-0.03	
-10	18	+0.02	
0	17	+0.02	
10	-15	-0.02	
20	13	+0.02	
30	10	+0.01	
40	-11	-0.01	
50	19	+0.02	

Band :	CDMA2000 BC1 1xRTT_RC1+SO55	Channel :	600
Limit (ppm) :	2.5	Frequency :	1880.0 MHz

Temperature (°C)	Freq. Dev. (Hz)	Deviation (ppm)	Result
-30	35	+0.02	PASS
-20	-27	-0.01	
-10	-18	-0.01	
0	12	+0.01	
10	10	+0.01	
20	11	+0.01	
30	-12	-0.01	
40	13	+0.01	
50	18	+0.01	

3.8.7 Test Result of Voltage Variation

Band & Channel	Mode	Voltage (Volt)	Freq. Dev. (Hz)	Deviation (ppm)	Limit (ppm)	Result
CDMA2000 BC0 CH384	1xRTT RC1+SO55	3.8	28	+0.03	2.5	PASS
		BEP	-26	-0.03		
		4.2	24	+0.03		
CDMA2000 BC1 CH600	1xRTT RC1+SO55	3.8	17	+0.01	2.5	PASS
		BEP	19	+0.01		
		4.2	11	+0.01		

Note :

1. Normal Voltage = 3.8V.
2. Battery End Point (BEP) = 3.6 V.



4 List of Measuring Equipment

Instrument	Manufacturer	Model No.	Serial No.	Characteristics	Calibration Date	Test Date	Due Date	Remark
Spectrum Analyzer	R&S	FSP40	100319	9kHz~40GHz	Dec. 29, 2012	Sep. 24, 2013	Dec. 28, 2013	Conducted (TH01-KS)
Pulse Power Sensor	Anritsu	MA2411B	0917070	N/A	Feb. 28, 2013	Sep. 24, 2013	Feb. 27, 2014	Conducted (TH01-KS)
Power Meter	Anritsu	ML2495A	1005002	N/A	Feb. 28, 2013	Sep. 24, 2013	Feb. 27, 2014	Conducted (TH01-KS)
Thermal Chamber	Ten Billion	TTC-B3S	TBN-960502	N/A	Dec. 29, 2012	Sep. 24, 2013	Dec. 28, 2013	Conducted (TH01-KS)
Spectrum Analyzer	Agilent Technologies	N9038A	MY52260185	20Hz~26.5GHz	Apr. 04, 2013	Oct. 15, 2013	Apr. 03, 2014	Radiation (03CH01-SZ)
Double Ridge Horn Antenna	ETS Lindgren	3117	00119436	1GHz~18GHz	Oct. 11, 2013	Oct. 15, 2013	Oct. 10, 2014	Radiation (03CH01-SZ)
Bilog Antenna	SCHAFFNER	CBL6112B	2614	30MHz~2GHz	Nov. 03, 2012	Oct. 15, 2013	Nov. 02, 2013	Radiation (03CH01-SZ)
Amplifier	ADVANTEST	BB525C	E9007003	9kHz-3000MHz GAIN 30db	Mar. 28, 2013	Oct. 15, 2013	Mar. 27, 2014	Radiation (03CH01-SZ)
Amplifier	Yiai	AV3860B	04030	2GHz~26.5GHz	Mar. 28, 2013	Oct. 15, 2013	Mar. 27, 2014	Radiation (03CH01-SZ)
Turn Table	EM Electronic	EM 1000	N/A	0 ~ 360 degree	N/A	Oct. 15, 2013	N/A	Radiation (03CH01-SZ)
Antenna Mast	EM Electronic	EM 1000	N/A	1 m - 4 m	N/A	Oct. 15, 2013	N/A	Radiation (03CH01-SZ)
Spectrum Analyzer	R&S	FSP 7	100819	9kHz~7GHz	May 23, 2013	Oct. 15, 2013	May 22, 2014	ERP/EIRP (OTA01-KS)
Switch Control Manframe	Agilent	3499A	MY42005452	N/A	N/A	Oct. 15, 2013	N/A	ERP/EIRP (OTA01-KS)
Dual 1-to-6(4) MW MUX	Agilent	N2276A	MY42000841	N/A	N/A	Oct. 15, 2013	N/A	ERP/EIRP (OTA01-KS)
Microwave Switch	Agilent	44476A	MY42002573	N/A	N/A	Oct. 15, 2013	N/A	ERP/EIRP (OTA01-KS)
Microwave Switch	Agilent	44476A	MY42002586	N/A	N/A	Oct. 15, 2013	N/A	ERP/EIRP (OTA01-KS)
Diagonal Dual Polarized Horn	ETS-Lindgren	3164-04	00066993	700MHz~6GHz	N/A	Oct. 15, 2013	N/A	ERP/EIRP (OTA01-KS)
Multi-Devices Controller	ETS-Lindgren	2090-OPT1	00066604	N/A	N/A	Oct. 15, 2013	N/A	ERP/EIRP (OTA01-KS)
Conical Log Spiral (Small)	ETS-Lindgren	3102	00066951	1~10GHz	N/A	Oct. 15, 2013	N/A	ERP/EIRP (OTA01-KS)
Turn Table	ETS-Lindgren	2088	N/A	Resolution : 0.1degree	N/A	Oct. 15, 2013	N/A	ERP/EIRP (OTA01-KS)
Limiting Amplifier	ETS-lindgren	109643	920326	10M~2.5GHz	N/A	Oct. 15, 2013	N/A	ERP/EIRP (OTA01-KS)
EMQuest	ETS-Lindgren	EMQ-100	1125	N/A	N/A	Oct. 15, 2013	N/A	ERP/EIRP (OTA01-KS)
Medium Duty Holder	ETS-Lindgren	2015	N/A	N/A	N/A	Oct. 15, 2013	N/A	ERP/EIRP (OTA01-KS)





5 Uncertainty of Evaluation

Uncertainty of Radiated Emission Measurement (30 MHz ~ 1000 MHz)

Measuring Uncertainty for a Level of Confidence of 95% ($U = 2Uc(y)$)	2.54
---	------

Uncertainty of Radiated Emission Measurement (1 GHz ~ 40 GHz)

Measuring Uncertainty for a Level of Confidence of 95% ($U = 2Uc(y)$)	4.72
---	------