

TOSHIBA Pocket PC (RG4-J01)

User Manual Version 1.0

Contents

| | |
|--|-----------|
| NETWORK SERVICES | 5 |
| TOSHIBA CORPORATION | 6 |
| LICENSES TBD | 10 |
| DECLARATION OF CONFORMITY | 12 |
| CARE AND MAINTENANCE TBD | 12 |
| CARE AND MAINTENANCE | 12 |
| USING THE USB HOST CABLE TBD | 13 |
| RESTARTING YOUR TOSHIBA PHONE | 13 |
| RESETTING YOUR TOSHIBA PHONE | 13 |
| INITIALISING YOUR TOSHIBA PHONE | 14 |
| BACKUP YOUR DATA | 14 |
| SAFETY INSTRUCTIONS | 14 |
| WIRELESS LAN SECURITY | 14 |
| BLUETOOTH SECURITY | 14 |
| FCC NOTICE | 15 |
| INFORMATION TO USER | 15 |
| GETTING STARTED TBD | 16 |
| TODAY SCREEN | 19 |
| START MENU | 20 |
| INSTALLING THE SIM CARD, BATTERY AND MINI SD CARD | 25 |
| PULL OUT / PUT IN THE STYLUS | 27 |
| USING THE STYLUS | 27 |
| CHARGING THE BATTERY | 28 |
| SWITCHING THE POWER ON AND OFF | 29 |
| SYNCHRONIZING | 30 |
| CALL FUNCTIONS | 32 |
| MAKING A CALL | 32 |
| RECEIVING A CALL | 34 |
| IN-CALL OPTIONS | 34 |
| SPECIAL DIALING REQUIREMENTS | 36 |
| VIDEO TELEPHONY | 37 |
| MESSAGING | 38 |
| MESSAGING OPTIONS | 38 |
| TEXT (SMS) MESSAGING | 39 |
| E-MAIL | 41 |
| MMS MESSAGING | 46 |
| WINDOWS LIVE MESSENGER | 49 |
| TEXT INPUT | 50 |
| INPUT METHODS | 50 |
| BLOCK RECOGNIZER | 50 |
| KEYBOARD | 51 |
| LETTER RECOGNIZER | 51 |
| TRANSCRIBER | 52 |
| SEARCHING | 57 |
| SETTINGS | 58 |
| REASSIGNING BUTTON FUNCTIONS | 58 |
| INPUT METHOD SETTING | 59 |
| SECURITY SETTINGS | 59 |
| CUSTOMIZING YOUR START MENU | 61 |
| OWNER INFORMATION | 61 |
| PHONE SETTINGS | 61 |
| SOUNDS AND NOTIFICATIONS | 63 |
| CUSTOMIZING YOUR TODAY SCREEN | 64 |
| VIDEO CALL SETTINGS | 65 |
| VIEWING THE ABOUT DETAILS | 65 |
| BACKLIGHT SETTING | 66 |
| CERTIFICATES | 66 |
| CLOCK & ALARM SETTINGS | 67 |

| | | | |
|--|-----------|---|------------|
| CUSTOMER FEEDBACK | 67 | INTERNET SHARING | 95 |
| ENCRYPTION | 68 | JAVA | 95 |
| ERROR REPORTING | 68 | MESSAGING..... | 97 |
| EXTERNAL GPS SETTING..... | 69 | NOTES | 97 |
| MASTER CLEAR | 69 | OPERA BROWSER | 97 |
| MANAGING MEMORY | 69 | PHONE..... | 98 |
| CHANGING POWER MANAGEMENT SETTINGS | 70 | PICSEL VIEWER | 98 |
| CHANGING REGIONAL SETTINGS..... | 70 | PICTURES & VIDEOS | 98 |
| REMOVING PROGRAMS..... | 70 | SEARCH | 100 |
| SCREEN ADJUSTING | 71 | SIM MANAGER | 100 |
| ADJUSTING THE SCROLL SPEED..... | 71 | SIM TOOLKIT..... | 101 |
| WINDOWS UPDATE | 72 | TASKS | 101 |
| SIMLOCK SETTINGS | 72 | WINDOWS LIVE MESSENGER..... | 102 |
| CONNECTIVITY | 72 | WINDOWS LIVE..... | 102 |
| MANUAL SET UP OF YOUR DATA CONNECTIONS | | WINDOWS MEDIA PLAYER..... | 103 |
| | 72 | WINDOWS UPDATE..... | 107 |
| CONNECTING TO THE INTERNET | 72 | TELEPORT..... | 107 |
| BLUETOOTH..... | 76 | TIPTALK..... | 109 |
| BEAMS | 78 | GOLDKEY | 112 |
| WIRELESS MANAGER | 80 | ZOOM | 112 |
| USB TO PC | 80 | SPECIFICATION | 114 |
| USB MASS STORAGE..... | 81 | TROUBLESHOOTING | 117 |
| APPLICATIONS AND MULTIMEDIA | 82 | HEALTH AND SAFETY | 119 |
| GAMES..... | 83 | GENERAL | 119 |
| OFFICE MOBILE | 83 | OPERATING ENVIRONMENT | 120 |
| ACTIVESYNC | 84 | ELECTRONIC DEVICES | 121 |
| CALCULATOR | 84 | BATTERY SAFETY | 121 |
| CALENDAR..... | 85 | AC ADAPTER AND CABLE SAFETY..... | 122 |
| CAMERA..... | 87 | EMERGENCY CALLS..... | 123 |
| CONTACTS..... | 89 | FCC RF EXPOSURE INFORMATION | 123 |
| FILE EXPLORER..... | 92 | BODY-WARM OPERATION..... | 124 |
| FINGER LAUNCHER..... | 93 | EUROPEAN RF EXPOSURE INFORMATION | 124 |
| HELP | 93 | PURCHASE RECORDS | 126 |
| INTERNET EXPLORER..... | 93 | | |

MENU TREE.....127

Network services

To use your Toshiba phone you must have service from a wireless service provider. Many of the features in your Toshiba phone depend on features in the wireless network to function. These Network Services may not be available on all networks or you may have to make specific arrangements with your service provider before you can utilise Network Services. Your service provider may need to give you additional instructions for their use and explain what charges will apply. Some networks may have limitations that affect how you can use Network Services. For instance, some networks may not support all language-dependent characters and services.

This phone is a 3GPP GSM Release 99 terminal supporting GPRS service, and is designed to support also Release 97 GPRS networks. However, there may be some compatibility issues when used in some Release 97 GPRS networks. For more information, contact your service provider.

The availability of particular products may vary by region. Please check with the dealer nearest to you.

Toshiba Corporation

IMPORTANT NOTE: PLEASE READ BEFORE USING YOUR MOBILE PHONE BY ATTEMPTING TO USE ANY SOFTWARE ON THE SUPPLIED PHONE CONSTITUTES YOUR ACCEPTANCE OF THESE EULA TERMS. IF YOU REJECT OR DO NOT AGREE WITH ALL THE TERMS OF THIS EULA, PLEASE DO NOT ATTEMPT TO ACCESS OR USE THE SUPPLIED SOFTWARE.

End User License Agreement

This End User License Agreement ("EULA") is a legal agreement between you (as the user) and TOSHIBA CORPORATION ("Toshiba") with regard to the copyrighted software installed in a Toshiba 3G mobile phone supplied to you (the "Phone"). Use or employment of any software installed in the Phone and related documentations (the "Software") will constitute your acceptance of these terms, unless separate terms are provided by the Software supplier on the Phone, in which case certain additional or different terms may apply. If you do not agree with the terms of this EULA, do not use or employ the Software.

- 1. License Grant.** Toshiba grants to you a personal, non-transferable and non-exclusive right to use the Software as set out in this EULA. Modifying, adapting, translating, renting, copying, making available, transferring or assigning all or part of the Software, or any rights granted hereunder, to any other persons and removing any proprietary notices, labels or marks from the Software is strictly prohibited, except as expressly permitted in this EULA. Furthermore, you hereby agree not to create derivative works based on the Software.
- 2. Copyright.** The Software is licensed, not sold. You acknowledge that no title to the intellectual property in the Software is or will be transferred to you. You further acknowledge that title and full ownership rights to the Software will remain the exclusive property of Toshiba, Toshiba's affiliates, and/or their suppliers, and you will not acquire any rights to the Software, except as expressly set out in this EULA. You may keep a backup copy of the Software only so far as necessary for its lawful use. All copies of the Software must contain the same proprietary notices as contained in the Software and are subject to the terms of this EULA. All rights not expressly granted under this EULA are

reserved to Toshiba, Toshiba's affiliates and/or their suppliers.

3. **Reverse Engineering.** You agree that you will not attempt, and if you are a business organisation, you will use your best efforts to prevent your employees, workers and contractors from attempting to reverse engineer, decompile, modify, translate or disassemble the Software in whole or in part except to the extent that such actions cannot be excluded by mandatory applicable law and only if those actions are taken in accordance with such applicable law. Any failure to comply with the above or any other terms and conditions contained herein will result in the automatic termination of this license and the reversion of the rights granted hereunder to Toshiba.

4. **LIMITED WARRANTY.** Only during the warranty period for the Phone, Toshiba, Toshiba's affiliate, its suppliers or its authorized service company will repair or replace, at Toshiba's sole discretion, defective Software unless such defect results from acts or incidences beyond the reasonable control of Toshiba. EXCEPT AS PROVIDED IN THIS EULA: (A) TOSHIBA, TOSHIBA'S AFFILIATES, AND THEIR SUPPLIERS DISCLAIM ALL

WARRANTIES, CONDITIONS OR OTHER TERMS (WHETHER EXPRESS OR IMPLIED), INCLUDING BUT NOT LIMITED TO WARRANTIES, CONDITIONS AND TERMS OF SATISFACTORY QUALITY, MERCHANTABILITY, FITNESS FOR A PARTICULAR PURPOSE AND NONINFRINGEMENT OF THIRD-PARTY RIGHTS; AND (B) THE ENTIRE RISK AS TO THE QUALITY AND PERFORMANCE OF THE SOFTWARE IS WITH YOU. YOU ACCEPT THAT SOFTWARE MAY NOT MEET YOUR REQUIREMENTS AND NO WARRANTY CAN BE GIVEN THAT OPERATION OF THE SOFTWARE WILL BE UNINTERRUPTED OR ERROR-FREE.

5. **LIMITATION OF LIABILITY.** TO THE FULLEST EXTENT LEGALLY PERMITTED, IN NO EVENT SHALL TOSHIBA, TOSHIBA'S AFFILIATES OR THEIR SUPPLIERS BE LIABLE TO YOU FOR ANY DAMAGES FOR (A) LOST BUSINESS OR REVENUE, BUSINESS INTERRUPTION, LOSS OF BUSINESS DATA; OR (B) CONSEQUENTIAL, SPECIAL, INCIDENTAL OR INDIRECT DAMAGES OF ANY KIND (WHETHER UNDER CONTRACT, TORT OR OTHERWISE)

ARISING OUT OF: (I) THE USE OR INABILITY TO USE THE SOFTWARE, EVEN IF TOSHIBA, TOSHIBA'S AFFILIATES OR THEIR SUPPLIER HAS BEEN ADVISED OF THE POSSIBILITY OF SUCH DAMAGES; OR (II) ANY CLAIM BY A THIRD PARTY. SAVE AS SET OUT IN THIS SECTION, TOSHIBA'S ENTIRE LIABILITY UNDER THIS EULA SHALL NOT EXCEED THE PRICE PAID FOR THE SOFTWARE, IF ANY. THE ABOVE DISCLAIMER AND LIMITATION DOES NOT EXCLUDE OR LIMIT (A) LIABILITY FOR DEATH OR PERSONAL INJURY CAUSED BY NEGLIGENCE; OR (B) ANY MANDATORY LEGAL RIGHT OR LIABILITY TO THE EXTENT THAT IT CANNOT BE LAWFULLY EXCLUDED OR LIMITED UNDER APPLICABLE LAW. PLEASE MAKE AND RETAIN A COPY OF ALL DATA YOU HAVE INSERTED INTO YOUR PRODUCT, FOR EXAMPLE NAMES, ADDRESSES, PHONE NUMBERS, PICTURES, RINGTONES ETC, BEFORE SUBMITTING YOUR PRODUCT FOR A WARRANTY SERVICE, AS SUCH DATA MAY BE DELETED OR ERASED AS PART OF THE REPAIR OR SERVICE PROCESS.

6. **Laws.** This EULA will be governed by the laws of England and Wales. All disputes arising out of this EULA shall be subject to the exclusive jurisdiction of the English Courts.
7. **Export Laws.** Any use, duplication or employment of the Software involves products and/or technical data that may be controlled under the export laws of applicable countries or region and may be subject to the approval of the applicable governmental authorities prior to export. Any export, directly or indirectly, in contravention of the export laws of applicable countries or region is prohibited.
8. **Third Party Beneficiary.** You agree that certain suppliers of the Software to Toshiba have a right as a third party beneficiary to enforce the terms of this EULA against you as a user.
9. **Transfers.** The Software may be transferred only as installed on the Phone to a lawful third party user, where that party accepts the terms of this EULA which will continue to apply.
10. IF YOU ARE DEALING AS A CONSUMER IN THE UK & THE SOFTWARE QUALIFIES AS 'GOODS', YOUR STATUTORY RIGHTS UNDER APPLICABLE LAW ARE NOT AFFECTED.

EU Warranty

Your Toshiba phone contains no user serviceable parts. For further information on service please contact your retailer or service provider.

Licenses TBD

Licensed by QUALCOMM Incorporated under one or more of the following United States Patents and/or their counterparts in other nations:

4,901,307 5,504,773 5,109,390 5,535,239
5,267,262 5,600,754 5,416,797 5,778,338
5,490,165 5,101,501 5,511,073 5,267,261
5,568,483 5,414,796 5,659,569 5,056,109
5,506,865 5,228,054 5,544,196 5,337,338
5,657,420 5,710,784

Microsoft, MS-DOS, Windows, Windows NT, Windows Server, Windows Mobile, ActiveSync, Excel, Internet Explorer, MSN, Outlook, PowerPoint, and Word are either registered trademarks or trademarks of Microsoft Corporation in the United States and/or other countries.

XT9 is trademark of Tegic Communications, Inc. Tegic Communications, an AOL Company.



Java™ and all Java-based marks are trademarks or registered trademarks of Sun Microsystems, Inc.



Bluetooth™ is a trademark of Bluetooth SIG, Inc.USA.



This miniSDTM logo is a Trademark.



Wi-Fi CERTIFIED is a Certification Mark of the Wi-Fi Alliance



Picxel, Picxel Powered, Picxel Viewer, Picxel File Viewer, Picxel Document Viewer , Picxel PDF Viewer and the Picxel cube logo are trademarks or registered trademarks of Picxel Technologies and/or its affiliates.



ArcSoft and the ArcSoft logo are registered

trademarks of ArcSoft, Inc. in the United States, P. R. China, EU, and Japan.



Opera is a trademark or registered trademark of Opera Software ASA.
Read more about Opera at <http://www.opera.com/>.



Declaration of conformity



Care and Maintenance TBD

Care and maintenance

You can greatly enhance the life span of your Toshiba phone, and the parts and accessories, by following the suggestions below.



TIP: Maintaining your Toshiba phone, and the parts and accessories, in a good condition will help you fulfil the warranty obligations

- Keep your Toshiba phone and all the parts and accessories out of the reach of small children or pets.
- Keep your Toshiba phone dry, as moisture of

any kind can contain minerals that will corrode the electronic circuits. The manufacturer's warranty may become invalid if our phone or battery were to get wet due to misuse.

- Do not use or store your Toshiba phone in dusty or dirty locations as the moving parts of the phone can be damaged.
- Do not use or store your Toshiba phone in hot areas. High temperatures will shorten the life span of the phone, damage the battery or warp/melt internal circuits.
- Do not store your Toshiba phone in cold areas. A big difference between room temperature and the temperature in the phone can cause condensation to form inside the phone, causing damage to the electronic circuits.
- Do not keep your Toshiba phone in, or near, heat sources such as a radiator or microwave oven - this can cause the battery inside the phone to overheat and explode.
- Do not open your Toshiba phone unless absolutely necessary.
- Do not mishandle or abuse your Toshiba phone. Dropping the phone, knocking or shaking it can damage the internal circuits.
- Do not use harsh chemicals, strong detergents,

or cleaning solvents to clean your Toshiba phone. Use a soft, clean, dry, lint-free cloth to clean the phone.

- Do not use water to clean the Touch screen.
- Keep the Touch screen and tip of the Stylus clean for avoiding permanent damage.
- Do not tap with strong power on Touch screen, it may cause permanent damage to Touch screen.
- Do not apply paint or other such substances to your Toshiba phone.
- If your Toshiba phone, or any of the accessories, are not working as they should, please consult your dealer who can provide you with the expert assistance you require.
- Do not use excessive volume levels when using headphones.
- If your Toshiba phone has a flash unit, do not operate the flash too close to a person's eyes - this may cause damage to their eyes.
- Interference may affect the performance of your Toshiba phone. This is normal and the phone should operate as usual once you move away from the source of the interference.
- Do not attempt to disassemble your Toshiba phone. Only Toshiba authorised personnel should service the phone.

Using the USB Host cable TBD

When use USB host cable, can provide maximum ???mA. When your Toshiba phone's battery over the supplied current, stop to supply.

When your Toshiba phone's battery less than ??%, can not use USB Host cable without battery recharging.

Restarting your Toshiba phone

If you have any problem as deadlock or freeze, press and hold the **Power key**.



If you restart your Toshiba phone while a program is running, data that you have not saved will be lost.

Resetting your Toshiba phone

After you tried restarting your Toshiba phone, if it still deadlock or freeze, press the **Reset button**. Even it still deadlock or freeze, remove the battery

(refer **Getting Started** section for instructions) and re-insert the battery turn your Toshiba phone on (refer **Getting Started** section for instructions).



If you reset your Toshiba phone, the data that you have saved might be lost.

Initialising your Toshiba phone

You should only use this procedure as a last resort. If you are experiencing a problem with an application, it is most likely a result of a conflict between installed programs. We recommend uninstalling the most recently added program first.

Also verify that the program is designed to be run on your Toshiba phone by comparing the requirements to the information provided with your phone - select **Start > Settings > About** to view this information.

To initialise your phone, refer to **Master clear** setting section.

Backup your Data

We recommend that you are advised to frequently back up all your data before initialising your Toshiba

phone.

Safety instructions

Wireless LAN security

It is possible for an outside party to easily gain unlawful access to your Toshiba phone via Wireless LAN if the security function is not used.

Without this security, your Toshiba phone carries the risk of unlawful access, wiretapping, and loss or destruction of data.

You should set up your Toshiba phone to use the authentication and encryption features (WEP, WPA) in order to prevent such access.

When using a public Wireless LAN access point, your Toshiba phone should be protected from unlawful access by the Windows firewall of Windows Security Centre and the anti-virus software within the firewall feature.

Bluetooth security

Although your Toshiba phone has security features compliant with the Bluetooth standard specification, this security might not work properly when using your Toshiba phone in a non-secure environment.

Please take care when using the Bluetooth feature.

FCC notice

This device complies with Part 15 of the FCC rules. Operation is subject to the following two conditions: (1) This device may not cause harmful interference, and (2) This device must accept any interference received, including interference that may cause undesired operation.

Changes or modifications not expressly approved by the party responsible for compliance could void the user's authority to operate the equipment.

Information to user

This equipment has been tested and found to comply with the limits of a Class B digital device, pursuant to Part 15 of the FCC Rules. These limits are designed to provide reasonable protection against harmful interference in a residential installation. This equipment generates, uses and can radiate radio frequency energy and, if not installed and used in accordance with the instructions, may cause harmful interference to radio communications. However, there is no guarantee that interference will not occur in a

particular installation; if this equipment does cause

harmful interference to radio or television reception, which can be determined by turning the equipment off and on, the user is encouraged to try to correct the interference by one or more of the following measures:

1. Reorient/relocate the receiving aerial.
2. Increase the separation between the equipment and receiver.
3. Connect the equipment into an outlet on a circuit different from the outlet the receiver is currently connected.
4. Consult the dealer or an experienced radio/TV technician for help.



WARNING: Changes or modifications not expressly approved by the manufacturer responsible for compliance could void the user's authority to operate the equipment.

Getting started TBD

Unpacking

Please ensure that the contents of your sales pack include:

- Your Toshiba phone
- Stylus
- AC adapter
- AC cable
- Battery pack
- USB Client cable
- USB Host cable
- Earphones
- User guide
- CD

Phone layout and functions

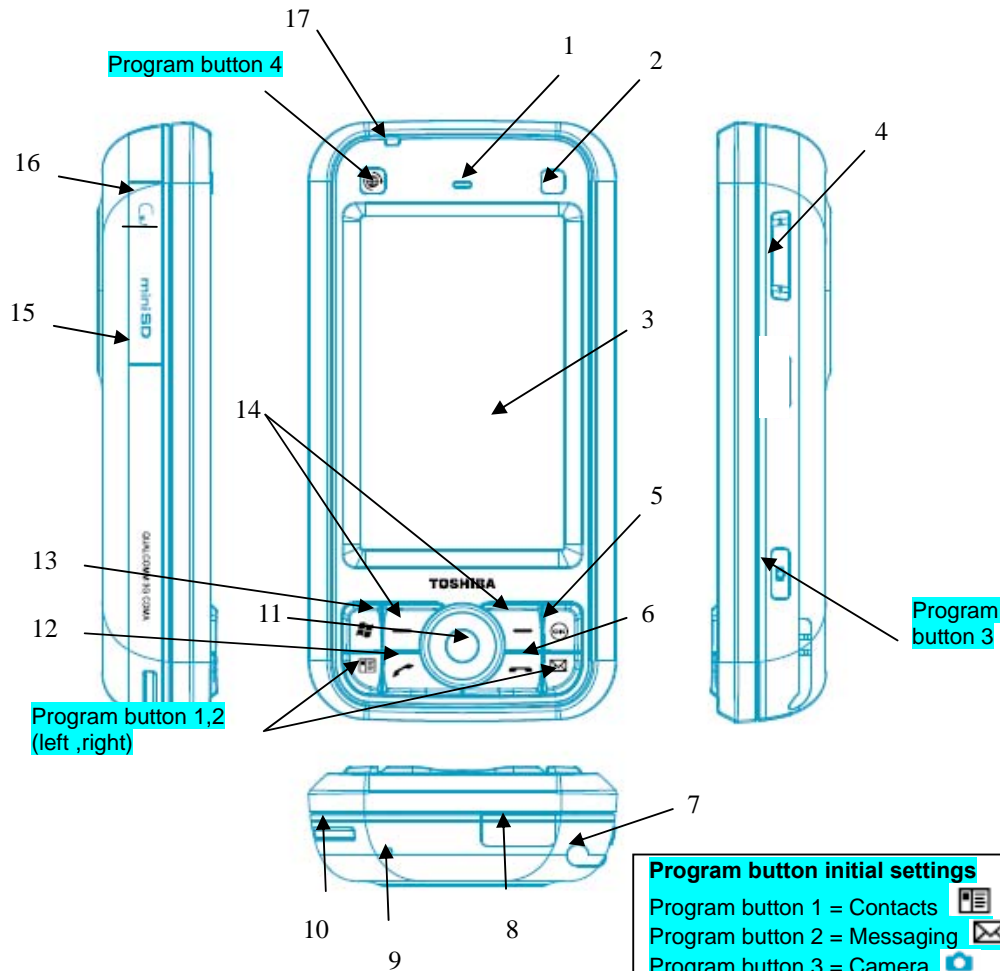

1. **Earpiece**
2. **Front camera**
3. **Touch screen**
4. **Side key** - adjusts the volume.
5.  **key** - confirm your data entries, or exit the program in use.
6. **End key** - ends calls/operations and returns to Today screen.
7. **Stylus**
8. **Cable and phone charging connector**
9. **Microphone**
10. **Handstrap hole**
11. **Navigation key/Action key** - moves the cursor up, down, left or right, confirms operations and accesses shortcuts. The **Action** key is used to open the selected operation.
12. **Send key** - launches the phone pad mode. makes and answers calls.
13. **Start key** - open the start menu.
14. **Right and Left Softkey** - performs operations indicated on the main display.
15. **miniSD card slot**
16. **Headset connector**
17. **Power LED** - bi-colour LED Power indicator, battery charging status.

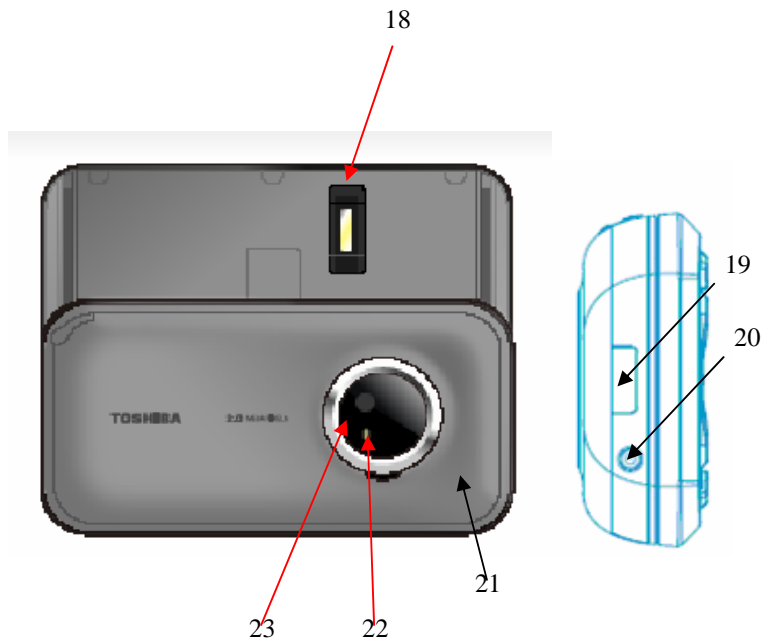

- 18. **Fingerprint sensor**
- 19. **Cover lock button** - locks and unlocks battery cover.
- 20. **Power key** - press and hold to turns power on/off. Press to enter to suspend mode / wakeup from suspend mode.
- 21. **Battery cover**
- 22. **Flash light**
- 23. **Rear camera**
- 24. **Right and Left Softkey** - performs operations indicated on the main display.
- 25. **Keyboard** - enters phone numbers and characters.
- 26. **Fn key** – press this key and press the overlaid key to select overlay function.
- 27. **Start key/Wireless LAN (Overlay function)**
- 28.  **key/Bluetooth (Overlay function)**
- 29. **Reset button**

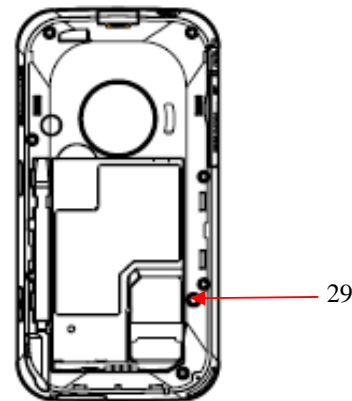

Today screen

You can access the **Today** screen from any menu by pressing the **End** key. Important information such as date, time, status indicators, appointments and profile are displayed on the **Today** screen. You can open a program directly by selecting the relevant icon and pressing the **Action** key.

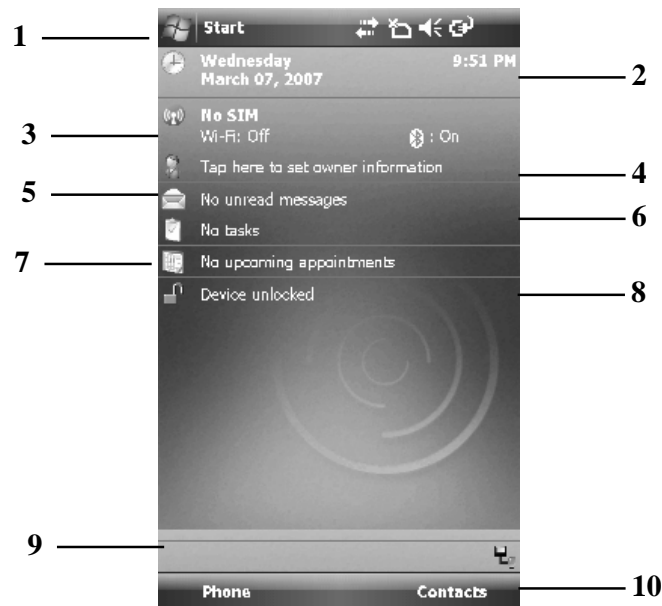

NOTE: Access the **Settings > Personal > Today** menu to change the **Today** screen layout.

1. Title bar
2. Displays the time and date.
3. Displays the name of your wireless service provider.
4. Owner information
5. Tap to read new text messages.
6. Display tasks.
7. Displays appointments.
8. Display Device lock status
9. Displays the connection status indicators.
10. Command bar. The name of this button is dynamic and depends on previous activity on the phone.

Start Menu



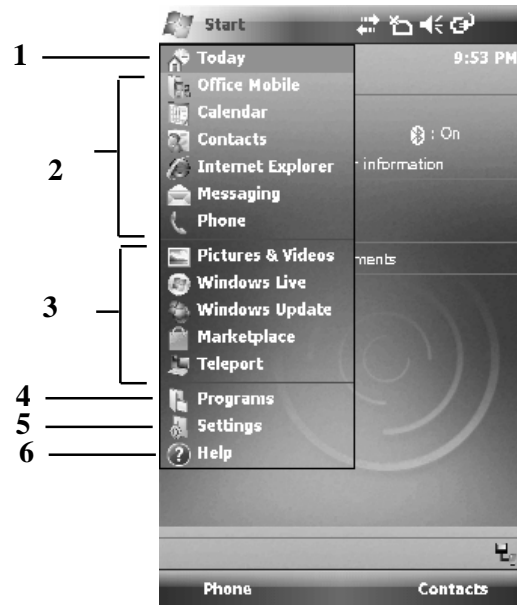













1. From the **Today** screen, tap **Start**.
2. Tap a program with the stylus.



































1. Today
2. Pinned applications.
3. Most Recent Program (Maximum 10 items)
4. Programs.
5. Settings
6. Help.





 **NOTE:** The Pinned applications and Help can be selected from a list of items in the menu Control Panel application.
For more information please refer to the **Settings** section.

Display indicators

| Slot | Type | Icon | Description |
|------|--------------------|--|----------------------------------|
| 1 | Notification icons |  | Missed call |
| | |  | New Voice mail(s) (*1) |
| | |  | New Voice mail(s) (*1) |
| | |  | voice mail at line1 |
| | |  | Voice mail at line2 |
| | |  | Voice mail at both lines |
| | |  | New e-mail(s) or text message(s) |
| | |  | New instant message(s) |
| | |  | Incoming beam |
| | |  | New OTA(OTA: Over The Air) |
| | |  | Bluetooth |
| | |  | SIM Error |
| | |  | Sync error |
| | |  | W-Fi data call TBD |
| 2 | Roaming icons |  | Roaming |
| | |  | GPRS in range |
| | |  | GPRS Roaming |

| Slot | Type | Icon | Description |
|------|-------------------|--|-------------------------------|
| | |  | CDMA in range (Not supported) |
| | |  | EDGE in range |
| | |  | EDGE Roaming |
| | |  | 3G in range |
| | |  | 3G Roaming |
| | Alarm icon |  | Pending Alarm |
| | Speakerphone icon |  | Speakerphone is on |
| | Caution |  | Duplication of notifications |
| 3 | Data icons |  | Data call Off |
| | |  | Data call connected |
| | |  | GPRS in progress |
| | |  | ActiveSync over GPRS in use |
| | |  | 3G in progress |
| | |  | ActiveSync over 3G in use |
| | |  | EDGE connected |

| Slot | Type | Icon | Description |
|------|-----------------------|--|-------------------------------|
| | |  | ActiveSync over EDGE in use |
| | |  | Wi-Fi on |
| | |  | ActiveSync over Wi-Fi in use |
| | |  | ActiveSync in progress |
| 4 | Signal strength icons |  | Signal strength |
| | |  | Voice/ Video Call in progress |
| | |  | Data call in progress |
| | |  | Radio off |
| | |  | Radio no service |
| | |  | Radio connected |
| | |  | Radio lost signal |
| | |  | Dialling |
| | |  | Call on hold |
| | |  | No SIM card installed |
| | |  | Call forwarded |
| 5 | Volume icons |  | Vibrate |
| | |  | Ringer Off |

| Slot | Type | Icon | Description |
|------|-----------------------------|--|------------------|
| | |  | Ringer on |
| 6 | Mini time | - | - |
| | Battery strength icons (*2) |  | Battery level |
| | |  | Battery alert |
| | |  | Battery charging |
| | |  | Low battery |

*1: Missed Call Notification icon is depended on the Network Provider.

1st "New voicemail" is displayed when the network supports the voicemail Mailbox status in SMS.

The other case displays 2nd "New voicemail". (TBD)

*2: When "Mini time" is displayed in title bar, the "Battery strength" icon is displayed in Slot1

Installing the SIM card, battery and miniSD card



IMPORTANT: The SIM card is easily damaged into by scratching and bending, so take care with handling it.

- Press the **Cover Lock** button (1) down, lift the battery cover (2) upwards and remove the battery from the battery compartment.



- With the gold connectors facing downwards, align the bevelled corner of the SIM card with the bevelled corner in the SIM card holder. Push down lightly and slide the SIM card (3)

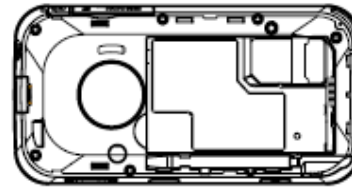

- Insert the battery into the battery compartment with the gold connectors facing downwards. Gently push down to snap into place.



- Gently click battery cover (2) into position.

- Open the memory card slot cover. Slide the miniSD card into the miniSD slot (5).



- To remove, press miniSD card inwards (5). The miniSD card will pop out (6). Close the memory card slot cover.

Pull out / put in the stylus

Pull out the stylus from stylus slot (7).
Put in the stylus to stylus slot (7).



Using the stylus

The stylus is used for menu selection or data input on the Touch screen of your Toshiba phone.

- **Tap** : Touch the screen once with the stylus to open items and select options.
- **Drag** : Hold the stylus on the screen and drag it across to select text and images. Drag in a list to select multiple items.
- **Tap and hold** : Tap and hold the stylus on an item to

see a list of actions available for that item.
On the pop-up menu that appears, tap the action you want to perform.



WARNING: When you operate the touch screen of your Toshiba phone, use the bundled stylus. If the tip of the stylus is damaged, do not use it. If you operate the Touch screen with a damaged stylus, a ballpoint pen or other sharply peaked pen, the Touch screen may be damaged. When the stylus is damaged, please purchase a new one.

Charging the battery

You need to fully charge the battery before you can switch your Toshiba phone on for the first time. The battery will only achieve optimum performance after two or three complete charges.

You can charge your battery in the following two ways:

1. Plug the AC adapter into an AC outlet and connect to the charger connector on your Toshiba phone. When the battery is fully charged, unplug the AC adapter from the AC outlet and disconnect it from the phone charger connector by gripping tightly and pulling gently.

Or

2. .Connect your Toshiba phone to a PC with the USB cable. Ensure that your Toshiba phone is on before connecting it to your PC.



TIP: To check your battery status, refer to **Changing power management settings** section.

Low battery indicator

When the battery charge level is running low, a warning tone sounds and the Battery Low message is displayed repeatedly. If the battery charge level runs too low for normal operation, your Toshiba phone will automatically switch off.

Battery information

Battery performance depends on many factors, such as your Service Provider's network configuration, signal strength, the temperature of the environment in which you operate your Toshiba phone, the features and/or settings you select and use, items attached to your phone's connecting ports, and your voice, data, and other program usage patterns.



It is recommended that you save your memory data to a PC or storage card. The manufacturer is not responsible for data lost or altered due to battery discharge.

Optimizing the power performance

Refer to **Changing power management** settings and **Backlight** setting sections.

Managing a low battery

When the low battery warning is displayed, do the following:

1. Save your current data.
2. Charge the battery as soon as possible.
3. Turn your Toshiba phone off.



There is a danger of explosion if the battery is incorrectly replaced. To reduce risk of fire or burns, do not disassemble, crush, puncture, short external contacts, expose to temperature above 60°C (140°F), or dispose of battery in fire or water. Replace only with specified batteries according to the local regulations.

Switching the power on and off

To switch your Toshiba phone on:

1. Press and hold down the **Power** key. The standby screen is displayed.
2. If a PIN or security code is requested, enter the code.

To switch your Toshiba phone off, press and hold down the **Power** key.



NOTE: The PIN code activates the services in your Toshiba phone and should be provided in the documentation supplied by your service provider.

Synchronizing

ActiveSync allows you to create a synchronization relationship between your Toshiba phone and PC, and between your Toshiba phone and your Exchange server. This means that the shared data is always consistent. If you make a change, it is automatically made to the corresponding information on the other computer. This is an effective way of keeping your data up-to-date. You can connect to your PC using the USB cable or Bluetooth connection. You can also use ActiveSync to connect your Toshiba phone to other resources through your PC. However, you cannot synchronize remotely to a PC using a modem or network connection. The synchronization relationship is created to manage the data that is copied between your Toshiba phone and PC.

You can connect to your Exchange server using a cellular connection, or you can connect your Toshiba phone to your PC as a way of connecting back to the Internet.

Installing and setting up ActiveSync

You can either install ActiveSync from your

Windows Mobile Getting Started CD or you can download a copy of ActiveSync HomePage. Once the software has been installed and your Toshiba phone is connected to your PC, via the USB cable, the ActiveSync Setup Wizard is started. Simply follow the onscreen instructions.



NOTE: If you have a PC which is already fully synchronized with your Exchange server, you should synchronize your Toshiba phone to your PC rather than synchronizing your Toshiba phone with the Exchange server. Data will be downloaded via your PC, saving you the charges for traffic volume. In addition, synchronizing via your mobile phone network will take longer than it would with your local PC.

If you are not synchronizing directly with a Microsoft Exchange server, do not select the option to synchronize directly with a server. The alternative is to synchronize your Toshiba phone with your PC. You cannot do both at the same time.

Changing ActiveSync settings

Once you have set up synchronization using the ActiveSync Setup Wizard on the PC, you can change your synchronization settings at a later stage:

- If you want to change ActiveSync settings for synchronizing with a PC, use ActiveSync on the PC. For more information, see "Changing the amount of information synchronized" in ActiveSync Help on the PC.
- If you want to change ActiveSync settings for synchronizing with an Exchange server, use ActiveSync on your Toshiba phone, as described in "Change settings for an information type."

 **NOTE:** Disconnect your Toshiba phone from your PC before changing the synchronization settings.

Starting/stopping synchronization

1. On the **Today** screen, tap **Start > Programs ActiveSync**.

2. To start synchronization, tap **Sync**.
3. To stop synchronizing, tap **Stop**.

Synchronizing Media

Your Toshiba phone can synchronize media from your PC, such as music and video files. This is described in detail in **Applications & Multimedia**.

 **NOTE:** You can only start/stop synchronization if your Toshiba phone already has a synchronized relationship with a PC or Exchange server.

Call functions

Making a call

You can make calls from the **Today** screen, **Phone** screen, **Contacts**, **SIM contacts** or **Call history** menus, or via speed dial.

Before making a call, ensure that your Toshiba phone is switched on, that there is a valid SIM card installed, and that the signal is sufficiently strong. To make a call, enter the phone number from the **Today** screen using the numeric keypad, or press the **Send** key and scroll down the list to the required number.

Press the **Send** key to dial.

Making an emergency call

You can make calls to emergency service numbers under almost any circumstances, even if you have locked your Toshiba phone or if you have not enabled your SIM.

Making a call by entering a contact name

1. From the **Today** screen, enter the initial letters of the contact name.
2. A list of contacts matching your keystrokes is displayed. Select the relevant contact and press the **Send** key once or the **Action** key twice.

Making a call from an open contact

1. From the **Today** screen, tap **Contacts**.
2. Select the contact and relevant phone number.
3. Press the **Send** or **Action** key

Making a call from Contacts

1. From the **Today** screen, tap **Contacts**.
2. Select the contact, and press the **Send** key.



TIP: If you have a long list of contacts, you can use a shortcut to find the contact you want: enter the first few letters of the contact's name.

The phone searches through the contact list and displays the name.

To call the contact, press the **Send** key.

Assigning the number

You can assign a work phone number (w), mobile phone number (m) and a home phone number (h) to a contact. The mobile phone number is dialed by default, unless you expand the list and scroll down to the phone number required.

Making a call from Call History

Call History displays calls you have made, received, and missed recently.

1. From the **Phone** screen, tap **Call History**.
2. Select the relevant name or phone number.
3. Press the **Send** key or tap **Call**.

Making a call using a recently dialed phone number

1. From the **Today** screen, press the **Send** key.
2. Select the relevant name or phone number tapping the up/down arrow.
3. Press the **Send** key or tap **Talk**.

Dialling the last number called

From the **Today** screen, press the **Send** key twice.

Creating a speed dial

You can create a speed dial for a phone number. ~~e-mail address or web page address~~ that is stored in your Contacts directory.

To create a speed dial entry:

1. From the **Today** screen, tap **Contacts**.
2. Select the contact.
3. Select the phone number, ~~e-mail address, text message, or web page address~~.
4. Tap **Menu > Add to Speed Dial**.
5. In **Location**, select the speed dial number.
6. Tap **ok**. The speed dial entry is created.



NOTE: The digit 0 is reserved to bring up the + symbol in international dial strings when you press and hold 0. The digit 1 is reserved for calling your voice mail box as a speed dial option.



NOTE: You can create a speed dial for phone numbers only with Pocket PC.

Voice mail speed dial

The voice mail speed dial is normally pre-configured. If it is not pre-configured, you can save your voice mail number by tapping **Phone > Speed Dial > Voice mail** and create a speed dial entry, as explained above. Contact your Service Provider to access the voice mail number.

Using a speed dial

From the **Today** screen, press and hold the speed dial number you want to call. If the speed dial contains two digits, press the first digit, then press and hold the second digit. Your Toshiba phone dials the phone number, ~~displays the new e-mail message, or opens the desired web page.~~

Editing a speed dial

1. From the **Today** screen, tap **Phone > Speed Dial**.
2. Scroll to the relevant speed dial, tap **Menu > Edit**.
3. Make the necessary changes and tap **ok**.

Deleting a speed dial

1. From the **Today** screen, tap **Phone > Speed Dial**.
2. Scroll to the relevant speed dial and tap **Menu > Delete**.

Receiving a call

Answering or ignoring a call

- To answer an incoming call, press the **Send** key or tap **Answer**.
- To ignore an incoming the call, press the **End** key or tap **Ignore**.



NOTE: If you choose to ignore a call, the caller will be connected to your voice mail, provided you have subscribed to this service.

In-call options

Answering or postponing a second call

To answer or postpone a second call, you need to first enable the call waiting option by doing the following:

1. From the **Today** screen, tap **Start > Settings > Phone > Service tab > Call Waiting**
2. Tap **Get Settings....** A tick is placed in the box.
3. Tap **ok**.

Once the call waiting option has been enabled on your Toshiba phone and the settings have automatically been sent and accepted by your Service Provider, you will receive an audible and visual notification on your Toshiba phone if another call comes in during your current call.

- To put the first call on hold and answer the second call, press the **Send** key. To switch between calls, tap **Swap**.
- To avoid answering the call, tap **Ignore**. The second call will either be disconnected or diverted to voice mail, if you have subscribed to this service.

Making a second call while already in a call

1. Whilst in a call, tap **Hold** to place the call on hold.
2. Dial the second number and press the **Send** key. Your first call will remain on hold.
3. To swap between the two calls, tap **Swap**.

Joining two or more calls together in a conference call

1. With two calls active on your Toshiba phone, one active and the other on hold, tap **Menu > Conference**. The two calls will be joined together and each party will be able to hear the other.

Adding an additional party to the call

1. To add another party to the conference call, dial another person, again tapping **Menu > Conference**.

Having a private conversation with a party

1. To do this you will need to split the conference call up. With the conference call running, tap **Menu > Private**.
2. Select the party with whom you wish to have the private conversation and press the **Action** key.



NOTE: The conference call feature depends on your Network Provider supporting it. Please check with your Network Provider to ensure you can use this feature.

Placing a call on speakerphone

1. Whilst in a call, tap **Menu > Speakerphone On**. The

speakerphone is activated.

2. To switch the speakerphone off, tap **Menu > Speakerphone Off**.

 **NOTE:** The speakerphone mode will not be automatically enabled in your next call, even if you left the function switched on in the previous call.

Placing a call on hands free mode

When the hands free equipment is attached the phone, hands free mode option will be enabled.

Special dialing requirements

Inserting a manual pause in a dialing sequence

Calls to certain networks may require a pause between the dialled digits. To do this:

1. From the **Today** screen, tap **Contacts**.
2. Select the contact number in which you want to insert a pause and tap **Menu > Edit**.
3. Place the cursor where you want to insert the pause.
4. Tap **w**. The letter **w** is displayed where the manual pause will occur in the dialing sequence.

5. Tap **ok**.

Inserting an automatic pause in a dialing sequence

Some international calls may require a pause in the dialling sequence.

1. From the **Today** screen, tap **Contacts**.
2. Select the contact number in which you want to insert a pause and tap **Menu > Edit**.
3. Place the cursor where you want to insert the pause.
4. Tap **p**. The letter **p** appears where the automatic pause will occur in the dialling sequence.
5. Tap **ok**.

Inserting an international country code

To make an international call, you must include a country code at the beginning of the dialing sequence.

To enter the country code, press and hold **0** to create **+** sign and then enter the rest of the phone number.

 **NOTE:** Similarly, you can insert a **+** sign when saving a contact's phone number or dial it directly

from the keypad.

Video telephony

Video calls allow you to enjoy live 'face-to-face' conversations with friends, family and colleagues.

Making a video call

Before making a video call, you must confirm that the person you are video calling also has a video enabled phone. To make a video call:

1. From the **Today** screen, tap **Phone**.
2. Enter the phone number.
3. Tap **Video**. The video call is made.

Answering or ignoring a video call

- To answer an incoming call with video enabled, tap **Answer**.
- To answer an incoming call with video blocked, press the **Send** key. An image will be sent according to the current Video Call Settings (refer to the Settings section for further information).
- To ignore an incoming the call, press the **End** key or tap **Ignore**.



NOTE: Video call and Wireless LAN (Wi-Fi) do not work simultaneously.

- 1 .You can't receive the video call while Wi-Fi on.
Incoming video call is treated as a missed call.
2. You cannot turn on Wi-Fi while video calling.

Messaging

This chapter describes how you can create, send, receive, organise, delete and store the following message types on your Toshiba phone:

- Text (SMS, Short Message Service) message
- Outlook email
- Multimedia message (MMS)

You can also use the instant messaging application, Windows Live Messenger, from your Toshiba phone. This application enables online over-the-air chat, as well as providing access to your MSN Hotmail email account.

Messaging Options

You can customize the settings of your accounts, message, address and storage by tapping **Messaging > Menu > Options**

- **Accounts** tab: Tap account to change setting of each account. For example, tap text messages to change Request delivery notification and Use Unicode when

necessary. Tap New account to set up a new account.

Creating and adding a signature to **an email the message**

For each account in Messaging, you can specify a signature to be automatically inserted into messages that you send.

- ~~1. From the **Today** screen, tap **Start > Messaging** and tap an account.~~
- ~~2. Tap **Menu > Options...** and **Signatures** in the **Account** tab.~~
- ~~3. Tap to **Select the account for which you are creating the signature.**~~
4. Tap the box in **Use signature with this account.**
5. To insert a signature in every message you send, tap the box in **Use when replying and forwarding.** Otherwise, a signature is inserted in new messages only.
6. Tap the **Signature** box, enter your signature.
7. Tap **OK.**

Check Display account picker when opening Messaging if you would like to select the messaging account when you open Messaging (???? I am not

sure)

- **Message** tab: Set up the following messaging features ; when replying to e-mail, include body, keep copies of sent items in sent folder, and the display after deleting or moving a message feature.
- **Address** tab: Select whether to get E-mails from all the contacts with E-mail from all the contacts with E-mail addresses; alternatively, you can verify names by defining their E-mail addresses.
- **Storage** tab: Check the memory space of your phone, storage card and attachments, and also it enable you to store attachments on storage card and specify how you want to empty your deleted items.

Text (SMS) messaging

Creating a Text (SMS) message

Text messaging, or the Short Message Service (SMS), allows you to exchange text messages with other phones. For details on text messages, contact your Service Provider. Your Toshiba phone supports the sending of more than the standard 160-character

limit. If you enter more than 160 characters, the message is split into linking SMS messages. You can send multiple linked SMS messages at one time.

To create and send a Text message:

1. From the **Today** screen, tap **Start > Messaging > Text message > Menu > New**.
2. Tap an existing contact by tapping **Menu > Add Recipient**.



TIP: To enter phone numbers quickly from your contact list, simply press the **Action** key while the cursor is in the **To:** field.

Alternatively, enter the mobile phone number of the recipient/s in the **To:** field. Use a semicolon to separate multiple recipients.

3. After you have selected your recipient/s, scroll down to the message area and enter your message.
4. Tap **Send**. The Text message is sent.



TIP: To delete cancel a message, tap **Menu > Cancel Message** whilst in the **Text Message** creation screen.

Delivery notification

To request Delivery notification:

1. Tap **Menu > Message Options** whilst in the **Text Message** creation screen.
2. Tap the box in the **Request message delivery notification** field.
3. Tap **OK**. Your request is sent to your Service Provider.

Inserting predefined text into a message

To save time when entering text, you can insert predefined text into a message:

1. ~~From the **Today** screen, tap **Start > Messaging > Text message > Menu > New >** Tap **Menu > My Text** whilst in the **Text Message** creation screen.~~
2. Tap the text you want to insert.

Replying to a message

1. From an open message, tap **Reply**.
If you are replying to a number of recipients, tap **Menu > Reply All**.
2. Enter your message in the message area.

3. Tap **Send**. The Text message/s is sent.

Forwarding a message

1. From an open message, tap **Menu > Reply > Forward**.
2. Tap an existing contact by tapping **Menu > Add Recipient**.



TIP: To enter phone numbers quickly from your contact list, simply press the **Action** key while the cursor is in the **To:** field.

- Alternatively, enter the mobile phone number of the recipient/s in the **To:** field. Use a semicolon to separate multiple recipients.
3. If necessary, enter a message in the message area.
 4. Tap **Send**. The Text message is sent.

Deleting a message

1. From the **Today** screen, tap **Start > Messaging > Text Message**.
2. ~~Open the folder and select Tap the message you~~

want to delete and tap **Delete** ~~Menu~~→**Delete**.

E-mail

Before you can send or receive emails, you need to set up an email account. Your Toshiba phone supports the following types of email accounts (all of which are covered in this section):

- Internet email (POP3/IMAP)
- Exchange server (Outlook)

Setting up an email account automatically

1. From the **Today** screen, tap **Start > Messaging > New Account**.
2. Tap **Enter e-mail address**: field to enter your email address for this account.
3. Tap the box in the **Try to get e-mail server settings from the internet** field.
4. Tap **Next**.
5. If the account is set up successfully, you are prompted to send and receive email. If the account is not set up successfully, you must tap **Next** and set up the account manually, as described in the following section.

Setting up an email account manually

1. Enter a your name (the name you want displayed when you send email) in the **Your name**: field.
2. Enter **Account display name** in the Account display name field and tap **Next**
3. Enter the name of the incoming server in the **Incoming mail**: field, select the **Account type** (POP3 or IMAP4) and tap **Next**
4. Enter a user name in the **User name**: field. This is usually the first part of your email address, which appears before the sign '@' sign
5. Enter a password in the **Password**: field.



TIP: Choose a strong password - strengthen the security of your password by selecting a combination of word and number characters.

- 6, Tap the box in the **Save password** field. if you wish to save your password to your Toshiba phone

This may or may not be required. Contact your Internet Service Provider for more information.



WARNING: If you save your password and then lose your Toshiba phone, you run the risk of someone else being able to access your email account.

7. Tap **Next**.
8. Enter the name of your outgoing email server (SMTP).
9. Tap the box in the **Outgoing mail requires authentication** if the outgoing server requires authentication.
10. Tap the **Advanced Server Setting** to set additional settings if you want.

Tap the box in the **Require SSL connection** if you wish to enable the SSL connection.



IMPORTANT: The SSL connection enables you to receive personal information more securely. Please note that if you select this option and your ISP does not support an SSL connection, you will not be able to connect and receive email.



IMPORTANT: Before you set up your Internet email account, ensure that you have the necessary information, as listed above.

Network Connection field enable you to select the network to which your email server connects.

11. Tap **Done** when you finish **Advanced Server Setting**
12. Enter **Outgoing Settings** field.
13. Tap the box in **Outgoing Server requires authentication** if your outgoing server requires it.



IMPORTANT: If authentication is required, your user name and password (as specified above) will be needed. Contact your Service Provider for more information.

14. Tap the box in **Use the same user name and**

password for sending e-mail when you want.

15. Tap **Next**.
16. Select the frequency to send and receive your e-mail from **Automatic Send/Receive** field
17. **Download messages** field enables you to set download message range from the server..
18. Tap the **Advanced Setting** to set additional settings if you want.

Tap the box in the **Send/receive when I click Send** to set when tapping **send** menu automatically send/receive.

Tap the box in the **Use automatic send/receive schedule when roaming** to synchronize automatically when roaming, which may result in additional changes.

When deleting messages: field enables you to select the deleting option

Tap Done when you finish setting **Advanced Setting**

19. Tap **Next**.

20. Tap the **Message format:** field to select the sending message type (HTML/Plain text).

21. Tap the **Download size limit:** field to select the download size limitation.

22. Tap **Finish**.

Setting up an Outlook email account

An Outlook email account is created and managed by Microsoft's Exchange server. You must have this account set up before continuing with the other steps described in this section.

To send or receive email messages with your exchange server, Tap **Start > Programs > ActiveSync**.

Once the ActiveSync completes successfully, Tap **Start > Messaging > Outlook Email > Menu > Go to > Folders....** The email folders are similar to the Outlook client in a PC.

Viewing your Inbox message list

From the **Today** screen, Tap **Start > Messaging**, and tap an account. The Inbox message list displays your received messages.

Create an email message

1. From the **Today** screen, tap **Start > Messaging**.
2. Tap an email account.
3. Tap **Menu > New**.
4. In the To, Cc, and/or Bcc field, enter the recipient/s email address/es. Insert a semicolon between multiple addresses.
5. Enter a subject in the **Subject** field.
6. Enter a message.
7. Tap **Send**. Email messages are stored in your Outbox and are sent to recipients the next time you synchronize or connect to your email server.



TIP: You can quickly enter email addresses from your contact list. Whilst in the **To** field, press the **Action** key and select a recipient from the list. Select the recipient's email

address. The semicolon separator is automatically inserted if you enter multiple recipients.

To set the priority of the email, Tap **Menu > Message Options**.

To cancel a message, Tap **Menu > Cancel Message**.

Inserting predefined text into an email message

Please refer to the **Text (SMS) messaging** section for details on how to use this facility. It can be used when creating a new message or replying to an email.

Replying to an email message

1. From an open message, tap **Reply** or, if replying to multiple recipients, tap **Menu > Reply > Reply All**.
2. Enter a message in the message area.
3. Tap **Send**.



TIP: If you are replying to an email in the Outlook Email account, you will send less data if you do not edit the original message. This may reduce data transfer costs based on your rate plan.

Sending and receiving email messages

1. From the **Today** screen, tap **Start > Messaging**.
2. Tap the email account that you want to send and receive messages.
3. Tap **Menu > Send/Receive**. Your Toshiba phone connects to your Internet email server and sends and receives your messages.

Downloading a complete email message

1. From the **Today** screen, tap **Start > Messaging** and tap an account.
2. Tap the message to download.

 **NOTE:** To stop this process, tap **Menu > Stop Send/Receive**.

3. Tap **Menu > Download Message**. The complete message is retrieved the next time you synchronize or connect to your email server to send/receive email.

Downloading an email attachment

In an open message with an attachment to download,

tap the attachment. The attachment is downloaded the next time you synchronize or connect to your email server and send/receive email.



NOTE: Alternatively, you can scroll down to the bottom of the email message and select **Get the rest of this message**.

Viewing an attachment

In an open message containing a downloaded attachment, tap the attachment.

Adding a picture to an email message

1. In the message area of an email message, tap **Menu > Insert > Picture**.
2. Tap the picture you want to add.



NOTE: You can only view attachments for file types that are supported by your Toshiba phone.

Switching between email folders and accounts

1. Tap **Start > Messaging > Outlook Email > Menu > Go to > Folders....**

2. Tap the new folder you wish to view.

MMS messaging

The Multimedia Messaging Service (MMS) allows you to exchange multimedia messages containing data such as text, pictures, sounds, animation and video clips. You can send MMS messages to other mobile phones or to email addresses. For details on MMS, and to enable your account for this service, contact your Service Provider.

An MMS can be made of many pages, also known as 'slides'. Each slide can hold an image, a sound and text, but you do not need to set all of these for each message. The maximum amount of content that can be sent in a message is set by your Service Provider.

Creating an MMS

1. From the **Today** screen, tap **Start > Messaging** and tap the **MMS** option.
2. On the MMS main screen, tap **Menu > New** to create a new MMS.
3. Tap a MMS from given templates or tap **Custom** to customize your MMS.
4. Add a recipient.

You can enter a phone number directly into the **To:** field, or you can select a contact from your contact list. ~~To choose a contact tap **Menu > Recipient...**~~
~~> Add~~ by tapping **Menu > Add Recipient** while the cursor is in the **To:** field.

The MMS composer is able to deliver the message to more than one user. When delivering to multiple recipients, input a semicolon between recipients.

Adding a Picture or Video

To add an image to the message:

1. Tap the **Insert Picture/Video** area. The preview of all pictures and videos in the ~~Picture the current-~~ folder is displayed.
2. Tap one of the pictures ~~to add. in the current folder.~~

To launch the camera application, tap **Menu > Capture > Picture** (or **Video**).

3. Once you have selected a picture or video, the ~~main~~ **message creation screen** is displayed.



NOTE: If you add a video to the message, you cannot add any further audio to the slide.

Adding text to the MMS message

Tap the **Insert Text here** area and enter your message. To use predefined text, tap **Menu > Insert Media > My Text**.

Using/creating templates

Tap **Menu > Template > New From Template...** and choose a template to use or create a new one yourself.

~~Selecting a message background colour~~

~~To choose the message background colour, tap **Menu > Options > Background**. A list of colours is displayed.—~~

Selecting a message **background**, **text size**, **colour**, **text background**

To choose the message background colour, tap **Menu > Options > background**, **text size**, **text colours** or **text background** which you want to change. A list of each **colour or size item** is displayed.

Tap the colour or size you want to applyt

Additional items

Just as for email, you may add recipient/s in copy (cc) or blind copy (bcc) to your message. You may also set the priority of the message, a delivery time delay for the sending of the message, an expiry time for the message, and request delivery and read report/s. To set these requirements, go to **Menu > Options > Send Options...** and set all these options as required

Receiving MMS messages

Your Toshiba phone will alert you when a new MMS arrives. Depending on your settings, the MMS contents may download a few moments later when the message will be ready to view in your MMS Inbox. The MMS Inbox functions in an identical way to your email and text message inboxes.

MMS settings

- **New:** create new message.
- **Reply:** replies to all and forwards current message.
- **Mark as read/unread:** marks current item as unread/read.
- **Move:** moves current message into another folder.
- **Go to:** switches to other folder (including Drafts, Outbox, Inbox, Sent Items and Deleted Items) and between Text Message, Outlook Email and MMS.
- **Tools:** the followings can do;
 - sorting the listed messages
 - managing the folder for MMS
 - emptying all the items in the deleted item folder
 - clearing all MMS messages
 - creating a new account for email
 - changing the account option for the text message, email and MMS
- **Download Messages:** if you have chosen only to take notification of MMS messages, and not to download the whole MMS message, you can mark a message for download. The MMS message will be downloaded when you next send or receive a message.
- **Send/Receive:** forces a send/receive of MMS messages that are pending.

Setting up the MMS account

If your Toshiba phone has not been preconfigured, you will need to manually enter the details of the MMS account. This is a two-stage process: in the first stage you must set up the data connection, and in the second stage you must define the address of the MMS server on the Internet.

Setting up a data connection

You will need the name of the MMS APN and any associated username, password, IP address and DNS setting in the connection settings.

Defining the server

1. From the **Today** screen, tap **Start > Messaging**.
2. Highlight the MMS entry, and tap **Menu > Options**.
3. Tap **MMS** in the **Account** tab and tap **New** in the **server** tab.
4. Enter the following details:
 - **Server Name:** enter a name for the server details.
 - **Gateway:** enter the WAP gateway to be used for this connection, as supplied by your Service Provider.
 - **Port number:** enter the port number.

- **Server address:** enter the address of the server, as supplied by your Service Provider.
 - **Connect Via:** point the MMS server towards the correct connection point. If you set up the MMS using the **Secure WAP network** setting, you must select the **Secure WAP network** setting here.
 - **Max sending size:** please contact your Service Provider to obtain this value.
5. Tap **OK**.
 6. Tap **Set As Default** if you want set it as default.
 7. Tap **OK**. Your Toshiba phone is now configured for MMS.

Windows Live Messenger

Windows Live Messenger is the next model of MSN messenger, and provides new messaging service. Windows Live Messenger on your Toshiba phone provides instant access to your contact list, emoticons, and friends. This service is currently free of charge. Windows Live Messenger offers new features to you:

- Easier-to-manage contact list and conversation inbox.
- View and participate in up to 5 active conversations

- at one time.
- No more idle conversation experience: Messenger for mobile can now maintain current conversation history and reestablish an idle conversation in the background.
- Emoticons are now displayed as graphics within display names and conversations.
- Easily change your display name and status, and even set status before you sign in.
- Sort and find contacts more quickly and easily (search, filter by group, and hide offline contacts).
- Call or send e-mail to contacts directly from their contact cards.
- Converse with temporary contacts (new people who don't yet appear on your list of Messenger contacts), and receive the option to add them to your contact list.
- To use it, tap **Start > Programs > Windows Live Messenger**.



NOTE: You need to have either a Microsoft.NET Passport (www.passport.com) or a Hotmail account (www.hotmail.com) to use Windows Live Messenger. In addition, your Toshiba phone must be connected to the Internet.

To obtain a Passport, go to:

<http://www.passport.com>.

To create a Hotmail account, go to:

<http://www.hotmail.com>.

Windows Live Messenger overview

With Windows Live Messenger you can send instant messages to your contacts' mobile device or PC.

To use Windows Live Messenger, you need Microsoft Passport Network credentials. After obtaining the credentials, complete the following tasks:

1. Set up a connection to the Internet with your Toshiba phone.
2. Get a Windows Live ID.
3. Sign in to Windows Live Messenger.

To access Windows Live Messenger:

1. From the **Today** screen, tap **Start > Programs > Windows Live Messenger**.
2. Tap the left or right arrow to select status, and tap **Sign in**.
3. Enter the following instruction on the screen to sign. Microsoft Passport Network credentials or Hotmail account is needed to sign in.



NOTE: Signing in to an account may take several minutes, depending on your connection speed and how busy your mobile network is.

Text input

Input methods

Your Toshiba phone has three text input methods:

- Typing: Using the input panel or the keyboard
- Writing: Using the stylus, write directly on the screen
- Drawing: Using the stylus, draw directly on the screen

Input Panel provides various input methods, including Block Recognizer, Keyboard, Letter Recognizer and Transcriber.

By default, the Input Panel icon appears on the menu bar to indicate which input method is currently selected. Tap the arrow beside you can select other input methods.

Block Recognizer

With **Block Recognizer**, you use a single stroke to

write individual letters, numbers and punctuation, which are then converted into typed text.

To use **Block Recognizer**, Tap the Selector arrow, and tap **Block Recognizer**.

The handwriting area is divided into two designated parts: **abc**, and **123 (both dimmed)**.

Write characters, numbers, symbols, and punctuation in separate area:

- Write in the abc area to enter lowercase letters.
- Write in the 123 area to enter numbers.
- Tap the box in the right corner labeled “@\$\$” to open table of symbols and punctuation.



NOTE: Block Recognizer is available when text entry is possible.



TIP: For help with using **Block Recognizer**, tap “?” in the right corner to see demo.

Keyboard

Switch to on-screen keyboard, and then use stylus to

tap on the smart keyboard to enter characters.



TIP: Tap **áü** to enter miscellaneous vowels or symbols.

To use keyboard option,

1. Tap the selector arrow and tap **Options**.
2. Tap **Keyboard** in the **Input Method** box.
3. Select to;
 - Tap the circle before “**Large keys**” to enlarge the smart keyboard.
 - Check the **Use gestures for the following keys** box to enable gesture command.

Letter Recognizer

With **Letter Recognizer**, you can write individual letters, numbers and punctuation, which are then converted into typed text.

To use **Letter Recognizer**, tap the Selector arrow, and tap **Letter Recognizer**.

The handwriting area is divided into three designated parts: **ABC**, **abc**, and **123 (all dimmed)**.

Write characters, numbers, symbols, and punctuation in separate area:

- Write in the ABC area to enter capital letters.
- Write in the abc area to enter lowercase letters.
- Write in the 123 area to enter numbers.
- Tap the box in the right corner labeled “@\$*” to open table of symbols and punctuation.

 **NOTE: Letter Recognizer** is available when text entry is possible.

 **TIP:** For help with using **Letter Recognizer**, tap “?” in the right corner to see demo.

Transcriber

Transcriber is a handwriting recognition program that allows you to write in cursive, print, or a combination of both. Transcriber works transparently in the background of programs, recognizing words with its integrated dictionary. When transcriber is turned on, it interprets stylus movement anywhere on the screen as handwriting input. For more information about using Transcriber, see **Help** on your device:

- Start a program such as **Word Mobile**.

- Tap the Input Panel icon at the bottom center of the screen and tap the Input Selector arrow. Tap **Transcriber**. The Transcriber introductory screen appears.

To start Transcriber

Because Transcriber works transparently in the background of programs that accept user input, you must have one of these programs open to use Transcriber.

1. Start a program such as Word Mobile.
2. Tap the Input Panel icon at the bottom center of the screen and tap the Input Selector arrow.
3. Tap **Transcriber**.

The Transcriber introductory screen appears.

To use Transcriber keyboard

Transcriber comes with an on-screen keyboard that provides an easy way to add punctuation or a special symbol to existing text.

- From a program, tap  on the Transcriber

toolbar.

The keyboard remains visible until you tap the button again.



TIP: To reposition the keyboard, tap and hold the title bar, and then drag to the desired location.



When no text is selected, you can also open the keyboard by doing the  gesture.



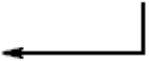
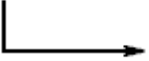

To edit text

1. In a program, draw a line across the text you want to edit.
2. After you lift the stylus from the screen, the line will disappear and the selected text will be highlighted.
3. Do either of the following:
 - Rewrite the text.
 - Use gestures to capitalize letters, insert a space, and so on. For information about using gestures, see “Transcriber Gestures” in this chapter.

To use gesture in Transcriber

Use quick strokes of the stylus to edit your text. Do the Enter, Space, and Tab gestures while writing text to insert returns, spaces, or tabs.

| Do | To |
|---|---|
|  | Insert a paragraph return at the cursor. The horizontal portion of the gesture must be at least two times longer than the vertical portion. |
|  | Insert a space at the cursor. The horizontal portion of the gesture must be at least two times longer than the vertical portion. |
|  | Move the cursor one space back and erase any text. Do the gesture by drawing a line from right to left. |
|  | Open the menu of alternate words if a word is selected or the on-screen Transcriber keyboard if no text is selected. Do the gesture by drawing a line straight down and back up. |

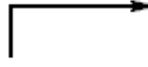
| | |
|---|---|
|  | Change the capitalization of a selected letter, word, or block of text. Do the gesture by drawing a line straight up. |
|  | Undo the last action. Do the gesture by drawing a line straight up and back down. |
|  | Copy the selected text. Do the gesture by drawing a line from left to right and back. |
|  | Cut the selected text. Do the gesture by drawing a line from right to left and back. |
|  | Paste copied or cut text. Do the gesture by drawing a line from the lower left of the screen diagonally up toward the right and back down to the right. |
|  | Insert a tab. The horizontal portion of the gesture must be at least two times longer than the vertical portion. |



TIP: You can also use the Enter, Space, and Backspace buttons on the Transcriber toolbar.

To write with Transcriber

Transcriber allows you to write in cursive, print, or a combination of both.

1. From a program, position the cursor where you want text to appear.
2. Use the stylus to write anywhere on the screen.

The handwriting will be converted to text shortly after you lift the stylus from the screen.

To optimize handwriting recognition for Transcriber

If Transcriber does not recognize your handwriting as accurately or quickly as you'd like, there are some things you can do to optimize handwriting recognition.

- Select the Writing Direction picture that best matches the slant of your handwriting.
- Use Letter Shapes to eliminate letter shapes that

you do not use or to learn methods of writing characters that will make them easier for Transcriber to recognize.

- Try writing in another format. If you have been printing, try writing cursive, or if you have been writing in both cursive and print, try printing alone.
- Adjust the speed at which Transcriber returns text after you write.
- Add a user dictionary that contains special terms you may be using, such as medical or legal terms.

Verify that you are using your Letter Shapes user profile.





 **NOTE:** The next time you write the shorthand text, the appropriate program will open.







To show or hide the Transcriber toolbar

The Transcriber toolbar, which appears at the bottom of the screen when Transcriber is open, provides easy access to several tools, Enter, Space, and Backspace buttons, and Left and Right arrow buttons.

- From a program, tap the **Transcriber** icon at the

bottom of the screen.

| Tap | To |
|--|---|
|  | Open the Options dialog box, where you can set options such as writing direction, text entry, and shorthand. |
|  | Open Letter Shapes , where you can set your personal writing styles to maximize recognition. |
|  | Use the miniature keyboard to quickly enter numbers, punctuation, and other symbols. |
|  | Change the character recognition mode. <ul style="list-style-type: none"> • a mode. This is the default for optimum handwriting recognition. • 123 mode. Numbers and some letters are allowed and the calculator is activated. • A mode. All letters are automatically capitalized. If you are in A or 123 mode, recognition returns automatically to |

| | |
|---|--|
| | the default mode once you lift the stylus. |
|  | Insert a space at the cursor. |
|  | Insert a paragraph return at the cursor. |
|  | Move the cursor one space to the left. |
|  | Move the cursor one space to the right. |
|  | Move the cursor one space back and erase any text. |
|  | Open the Transcriber Help. |

Drawing and Writing on the Screen

Drawing on the Screen

With your Toshiba Phone, you can draw directly on the screen, or write on the screen and save notes in your own handwriting. To do this, you must set the input

mode in Notes to Writing. If you prefer to use handwriting or frequently add drawings to your notes, you may find it helpful to set Writing as the default input mode. If you prefer typed text, set Typing as the default input mode.

To set the input mode for Notes

1. Tap **Start > Programs > Notes**.
2. In the note list, tap **Menu > Options**.
3. In the Default mode box, tap one of the following:
 - **Writing** if you want to draw or enter handwritten text in a note.
 - **Typing** if you want to create a typed note.
4. Tap **OK**.

To handwrite a note

1. Tap **Start > Programs > Notes**.
2. In the note list, tap **New**.
3. Tap **Menu > Draw**, write your text on the screen.
4. When finished, tap **OK** to return to the note list.



NOTE: If a letter crosses three ruled lines, it is treated as a drawing rather than text.

To draw a note

To draw on the screen, use the stylus.

1. Tap **Start > Programs > Notes**.
2. In the note list, tap **New**.
3. Tap **Menu > Draw**, and cross at least three ruled lines.
4. A selection box labeled Drawing appears around your drawing.
5. When finished, tap **OK** to return to the note list.

 **NOTE:** To select a drawing (for example, to copy or delete it), tap and hold the drawing briefly. When you lift the stylus, the drawing is selected.

Searching

You can search for files and other items stored on your device in the My Documents folder or on a storage card.

You can search by file name or by key words located in the item. For example, you can search E-mail messages, notes, appointments, contacts, and tasks as well as in online Help.

To search for a file or an item

- 1 Tap **Start > Programs > Search**.
- 2 In Search for, enter the file name, word, or other information you want.
- 3 If you have searched for an item before, tap the arrow in **Search for** to find it in the searching history.
- 4 In Type, select a data type to help narrow your search area.
- 5 Type **Search**.

In the **Results** list, tap the item you want.

 **NOTE:** The My Documents folder and its subfolders are included in the search area.

 **NOTE:** Results found on a storage card is indicated by an icon.

Settings

Reassigning button functions

There already are programs that assigned to the hardware buttons, however, you may not satisfied with some assignments as you want those often-in-use programs to replace the ones rarely run.

To reassign a button:

1. From the **Today** screen, tap **Start > Settings > Personal** tab > **Buttons**. You see the names of buttons and their current assignments.
2. Tap a button you want to reassign, and then in **Assign a program** selection box, select a program for this button.





NOTE: There is an icon representing the original functions of a button. It helps you identify a button and restore its default at any time.

3. Tap **OK**.

Input method setting

1. From the **Today** screen, tap **Start > Settings > Personal tab > Input**.
2. On the **Input method** tab, tap a desired input method. On the **Word Completion** tab, tap a desired setting for word completion. On the **Options** tab, tap the desired options for writing and recording. These options apply to any program on the device where you can record or write.

 **NOTE:** You can also change input options by tapping the selector arrow and options.

 **NOTE:** you can select enable or disable of XT9 feature by checking on/off the box of **Suggest words when entering text** in the **Word Completion** tab.

Security settings

It is advisable to apply certain security features in the event that your Toshiba phone is lost or stolen. In addition, some security features can be applied to

prevent unauthorised use.

You can apply the following security:

- **Phone lock with a PIN** - prevents unauthorised use of your SIM card in any phone.
- **Device lock with a password** - prevents unauthorised use.

To protect your phone with a PIN

Be sure to make a note of your personal identification number (PIN). When the SIM PIN is disabled, you must provide this PIN to enable the SIM. The PIN is provided with the SIM card.

1. From the **Today** screen, tap **Phone > Menu > Options > Phone** tab.
2. Tap **Require PIN when phone is used**. To change the PIN at any time, tap **Change PIN**.



TIP: Emergency calls can be placed at any time, without requiring a PIN.

To protect your device with a password

You can help keep your data more secure by requiring

a password every time the device is turned on.

1. From the **Today** screen, tap **Start > Settings > Personal tab > Lock**.
2. Tap the **Prompt if device unused for** check box, and in the box to the right, select how long your device must be turned off before a password is required. In the **Password type** box, select the type of password you would like to use. Enter the password and, if necessary, confirm the password. If your device is configured to connect to a network, use a strong password to help protect network security.
3. Tap **OK**. The next time the device is turned on, you will be prompted to enter your password.



NOTE: Each time a wrong password is entered, the time the device takes to respond will get longer and longer until the device appears to be not responding. If you forget your password, you must follow the instructions in your owner's manual to clear memory before you can access your device.

To change your password

1. From the **Today** screen, tap **Start > Settings > Personal tab > Lock**. You will be prompted to enter your current password.
2. In the **Password** box, enter your new password.
3. Tap **OK**.

Enabling Fingerprint

The Fingerprint feature helps provide additional security on your Toshiba phone, by protecting it from unauthorised use.

To enable the Fingerprint feature:

1. From the **Today** screen, tap **Start > Settings > Personal tab > Fingerprint**.
2. Tap the finger you want to enrol from the list, and press the **Action** key.
3. Swipe the finger three times to enrol it to the fingerprint sensor.
4. Click **OK**.

Disabling Fingerprint

1. From the **Today** screen, tap **Start > Settings > Personal tab > Fingerprint**.
2. Tap **Delete** from the menu with focused finger list

- item.
3. Tap **OK**.

Customizing your Start Menu

You can select/deselect items/programs in the combo box to let it appear on/disappear from the Start Menu.

1. From the Today screen, Tap **Start > Settings > Personal tab > Menus**.

 **NOTE:** Only 7 programs are allowed on the Start Menu. If you selected any items in **Programs** category, the icons are disappeared from **Programs**.

Owner information

Entering owner information could allow someone to return your Toshiba phone to you if it becomes lost.

1. From the **Today** screen, tap **Start > Settings > Owner information** on the **Personal** tab.
2. Enter your information on the Identification tab. You can also take important notes on the **Notes** tab, or choose to display them when your device is tuned on. Besides, in Option tab, you can set to display Identification information or Notes when the device is turned on.



TIP: If you have selected to show owner information on the Today screen, just tap the section there to edit.

3. Tap **OK**.

Phone settings

Ring tone Settings

1. From the **Today** screen, tap **Start > Settings > Personal tab > Phone > Phone** tab.



TIP: In **Sounds**, using different ring types, you can change the way you are notified of incoming calls.

2. Tap the Ring type box to find the type (ring, vibration, or combination of both) you preferred.
3. Tap the Ring tone box to select a tune you like. You can tap the control buttons to listen to the sample.

 **TIP:** you can also use custom ***.wav**, ***.mid**, ***.mp3**, or ***.wma** files as ring tones.

Please see **Help** topics on **Change the ring tone & ActiveSync** for detailed instructions.

 **TIP:** In **Keypad**, you can select **Long tones/Short tones/Off** when you tap and hold the buttons on the phone keypad.

Setting call barring

Call barring allows you to screen incoming and outgoing calls.

To set call barring:

1. From the **Today** screen, tap **Start > Settings > Personal** tab > **Phone > Service** tab.
2. Focus on **Call barring** service type, and tap the **Get Settings** button to retrieve settings from network; you can also change them here.

3. Tap **OK**.

Setting call forwarding

1. From the **Today** screen, tap **Start > Settings > Personal** tab > **Phone > Service** tab.
2. Focus on **Call forwarding** service type, and tap the **Get Settings** button to retrieve settings from network; you can also change them here.
3. Tap **OK**.

Setting call waiting

When you are in another call, the call waiting feature will notify you of an incoming call.

To set call waiting:

1. From the **Today** screen, tap **Start > Settings > Personal** tab > **Phone > Service** tab.
2. Focus on **Call waiting** service type, and tap the **Get Settings** button to retrieve settings from network; you can also change them here.
3. Tap **OK**.

Configuring Caller ID

Configuring Caller ID allows selected callers to view your name and phone number information on their

phone when you call them.

To configure Caller ID:

1. From the **Today** screen, tap **Start > Settings > Personal** tab > **Phone > Service** tab.
2. Focus on **Caller ID** service type, and tap the **Get Settings** button to retrieve settings from network; you can also change them here.
3. Tap **OK**.

Voice Mail and Text Messages

1. From the **Today** screen, tap **Start > Settings > Personal** tab > **Phone > Service** tab.
2. Focus on **Voice Mail and Text Messages** service type, and tap the **Get Settings** button to retrieve settings from network; you can also change them here.
3. Tap **OK**.

Fixed Dialing

1. From the **Today** screen, tap **Start > Settings > Personal** tab > **Phone > Service** tab.
2. Focus on **Fixed Dialing** service type, and tap the **Get Settings** button to retrieve settings from network; you can also change them here.
3. Tap **OK**.

Network

You can view available wireless networks, or assign another network to connect if the current one turns unavailable. In addition, you can choose to manually/automatically select the network. For more information on network settings. Please see **Help** topics related.

To change network provider:

1. From the **Today** screen, tap **Start > Settings > Personal** tab > **Phone > Network** tab.
 - **Current network** - By default, your device displays the current network name here; however, you can choose a preferred one.
 - **Network selection** - By default, the **Network selection** box is set to **Automatic**. Tap **Manual** and wait for it to search for all available network providers. Choose one to register.
 - **Set Networks** - Tap one and press **Move up** or **Move down** to arrange the order.
2. Tap **OK**.

Sounds and Notifications

You can set a different sound for different events. The sound can be set the different type every event.



TIP: You can copy sounds to your phone from your PC using ActiveSync. Sound files can be in either midi, wma, mp3, amr or wav file format. For notifications or reminders, use either midi, wma, mp3, amr or wav files.

Specifying the sound for an event

1. From the **Today** screen, tap **Start > Settings > Sounds & Notifications**.
2. On the **Sounds** tab, tap the check box to enable sounds for events and programs, or choose a soft/loud sound for screen taps and hardware button presses.
3. Tap **OK**.

Specifying the notification for an event

1. From the **Today** screen, tap **Start > Settings > Sounds & Notifications**.
2. On the **Notifications** tab, tap one from the various events in the selection box, and then choose a sound for it. In the following check box, select the

way you want this event to be notified (Some may be dimmed according to the event).

3. Tap **OK**.



TIP: Disabling sounds and flash light helps conserve battery power.

Customizing your Today screen

You can customize your Today screen using:

- A picture file (.bmp, .jpg, png or.gif).
- A pre-packaged file that includes a picture, a colour scheme and a new layout (.hme or.cab).



TIP: You can copy an image to your Toshiba phone from your PC using ActiveSync.

1. From the **Today** screen, tap **Start > Settings > Personal** tab > **Today**.
2. On the **Appearance** tab, tap a theme you desire for the Today screen.

Setting a picture as the background

1. Tap the **Use this picture as the background** check

- box. Tap Browse to view the picture files.
2. Tap the file name of the picture you choose.
 3. Tap **OK**.

Setting appointment display in Calendar Options

1. On the **Items** tab, tap **Calendar** then tap the **Options...** button.
2. On the **Options** screen, tap the followings;
 - Tap **Next appointment** to only display the next appointment on schedule.
 - Tap **Upcoming appointments** to display the appointments you have not done yet.
 - Tap the **Display all day events** check box to display all events (Both done or not) today.
3. Tap **OK**.

Setting task display in Tasks Options

1. On the **Items** tab, tap **Tasks** then tap the **Options...** button.
2. On the **Options** screen, tap the followings;
 - Tap the box of **Display number of** to display the task you want to.
 - Tap **Category** to select the task category you want

- to display.
3. Tap **OK**.

Video call settings

To set the video call settings

1. From the **Today** screen, tap **Start > Settings > Personal** tab > **Video Call**.
2. Tap the **Hold** tab to set the icon when holding a video call. You can choose Default Icon or Custom Images from pictures.
3. Tap the **Block Video** tab to set the icon for block video. You can choose Default Icon or Custom Images from pictures.
4. Tap the **Services** tab to access settings for a service, select it from the given list and tap **Get Settings** to set the corresponding item.
5. Tap **OK**.

Viewing the About details

Viewing the OS version

1. From the **Today** screen, tap **Start > Settings > System** tab > **About**.
2. On the **Version** tab, you see information on version, copyright, and hardware.
3. Tap **OK**.

Changing Device ID

1. From the **Today** screen, tap **Start > Settings > System** tab > **About**.
2. On the **Device ID** tab, here it shows you what Device ID is and what it is used for. Note that your Device ID should start with a letter and contains only letters from A to Z, numbers from 0 to 9, underscore, and hyphen.



NOTE: The device name is used to identify your device in following situations:

- Synchronizing with PC
- Connecting to a network
- Restoring information from a backup

3. Tap **OK**.

Backlight setting

If your device supports it, you can set the backlight to dim after a specific amount of time has elapsed.

1. From the **Today** screen, tap **Start > Settings > System** tab > **backlight**.
2. Tap the **Battery power** tab to turn on/off the backlight when using battery power, and specify the time delay.
3. Tap the **External power** tab to turn on/off the backlight when using external power, and specify the time delay.
4. Tap the **Brightness** tab to adjust the brightness level.
5. Tap **OK**.

Certificates

This item displays the name of the certificate issue and the expiration date.

1. From the **Today** screen, tap **Start > Settings > System** tab > **Certificates**. You can see the details every tab.

Clock & alarm settings

Setting the date and time

1. From the **Today** screen, tap **Start > Settings > System** tab > **Clock & Alarm > Time** tab.
2. In **Home**, you set the time zone, current time and date in your homeland.
3. While in **Visiting**, you set the same object of a country you are visiting.
4. Tap **OK**.

 **NOTE:** Synchronization will update the time on your phone with that on a PC.

 **NOTE:** These settings are only lost if you manually reset your Toshiba phone. Your settings are preserved if you power off the phone, or if the battery is fully discharged.

Setting the alarm

1. From the **Today** screen, tap **Start > Settings > System** tab > **Clock & Alarm > Alarms** tab.
2. Tap **Description**; use the Keyboard to define a clock type.

3. Tap the uppercase letters below to arrange the days on which you need the alarm.
4. Tap the time display at the end to set a time for this alarm.
5. Tap the bell icon to select the reminder mode: **Play sound, Flash light, Vibrate**, etc. If you have the **Play sound** check box selected, tap the sound selection box beside to select an alarm ring you like.
6. Tap **OK**.

Customer feedback

You can make Windows Mobile software better by participating in the Customer Experience Improvement Program. If you participate, anonymous information about how you use Windows Mobile software will be sent to Microsoft. This helps identify trend and usage patterns in order to improve the software.

1. From the **Today** screen, tap **Start > Settings > System** tab > **Customer Feedback**.
2. Tap the radio button of **Send Feedback** or **Don't Send Feedback** you wish.
3. Tap **OK**.

 **NOTE:** This feature doesn't collect your name,

address, or any other personally identifiable information. You will not incur any data charges to send the information.

Encryption

This feature allows you to secure sensitive information on your Toshiba phone's removable storage card. The data is only accessible when the card is installed in their particular mobile device. If the card is ever lost or stolen, their information remains secure because no one else can access the card's contents because it is encrypted.

1. From the **Today** screen, tap **Start > Settings > System tab > Encryption**.
2. Tap the box of **Encrypt files placed on storage card** field.
3. Tap **OK**.



WARNING: Anyone in possession of the encryption key can decrypt and access the sensitive information stored on the card.

Error Reporting

Turning Error Reporting on/off

Error Reporting sends data from your Toshiba phone to technical support groups, who use the data to diagnose a program error for a device running Windows Mobile software. A text file is created whenever an error is detected, and can be delivered to support personnel if you choose to send it. If a program error occurs, Error Reporting starts automatically. The information Microsoft receives is used by programming groups at Microsoft. The data is used for quality control and will not be used for tracking individual users, installations or for any marketing purpose.

1. From the **Today** screen, tap **Start > Settings > System tab > Error Reporting**.
2. Tap the radio button to select either **Enable** or **Disable** of error report.
3. Tap **OK**.

External GPS setting

1. From the **Today** screen, tap **Start > Settings > System tab > External GPS**.
2. On the **Programs** tab, you can choose the port that your Toshiba phone will use to obtain GPS data.
3. On the **Hardware** tab, you can specify the hardware port to which your GPS device is connected. Settings include **GPS hardware port:** field and **Baud rate:** field.
4. On the **Access** tab, you can activate Manage GPS automatically (recommended). You are strongly advised to activate this feature; doing so will enable Windows Mobile to manage access to your GPS device, and allows multiple programs to obtain GPS data simultaneously.
5. Tap **OK**.

Master Clear

To hard reset your phone:

1. From the **Today** screen, tap **Start > Settings > System tab > Master Clear**.
2. Enter the reset code in the **Code:** field, ~~and follow~~

~~the on-screen instructions~~ and tap **Reset** to reset your phone.

3. Your phone will restart after it has been reset.



WARNING: After resetting, your Toshiba phone will be resumed to its default factory settings. All the user data and programs on the your Toshiba phone will be formatted. Please enter the confirmation code: 1234 and push reset button, system will auto-reboot to complete the operation.

Managing Memory

Ensuring memory details on your Toshiba phone

To ensure a good performance of your device, it's necessary to maintain a sufficient memory.

To see the memory available:

1. From the **Today** screen, tap **Start > Settings > System tab > Memory**.
2. Tap **Main** tab, you can see the details of Storage and Program.
3. Tap **Storage Card** tab, you can see the memory available on the storage card.

To end a program

You can close programs manually to release more memory.

1. From the **Today** screen, tap **Start > Settings > System** tab > **Memory > Running Program** tab.
2. In the **Running Programs** list, tap the program you want to close, and tap **Stop** or **Stop All** to stop all running programs.



NOTE: if you want to restore a program, focus on a program you want and tap **Activate**.

Changing power management settings

Use Power Management to check the battery status and configure settings that prolong battery life.

1. From the **Today** screen, tap **Start > Settings > Power** on the **system** tab.
2. On the **Battery** tab, display the current battery remaining, and on the **Advanced** tab, adjust the following:

On battery power - Tap the box of **Turn off device if**

not used for: field, select the time period for the phone to be idle before the device turns off.

On external power - Tap the box of **Turn off device if not used for:** field, select the time period for the phone to be idle before the device turns off when using external power.

3. Tap **OK**.

Changing regional settings

Regional settings specify the style in which numbers, currency, dates, and times are displayed.

1. From the **Today** screen, tap **Start > Settings > Regional settings** on the **System** tab, to select your region.
2. To set the details up, tap other tabs (**Number, Currency, Time, and Date**).

Removing Programs

This feature removes additionally installed software

programs.

Removing a program



NOTE: Programs that come with your Toshiba phone cannot be removed.

1. From the **Today** screen, tap **Start > Settings > System** tab > **Remove Programs**.
2. Choose the program to remove in the **Programs in storage memory** list.
3. Tap **Remove**.

Screen Adjusting

To align the screen

1. From the **Today** screen, tap **Start > Settings > System** tab > **Screen**, do the followings:
 - On the **General** tab, you can adjust the screen's orientation and align the screen.
 - On the **ClearType** tab, you can select **Enable ClearType** to smooth the edge of screen fonts for many programs.

- On the **Text Size** tab, you can adjust the text size to see more content or increase the readability in many programs. You can see an example on the **Example** field.
2. Tap **OK**.

To align the screen

1. From the **Today** screen, tap **Start > Settings > System** tab > **Screen**.
2. Tap the radio button of **Orientation** you want to adjust and align the screen's orientation.
3. Tap **OK**.

Adjusting the scroll speed

The scroll speed is about how fast you scroll through items on a list.

To adjust scroll speed:

1. From the **Today** screen, tap **Start > Settings > Personal** tab > **Buttons > Up/Down Control** tab.
 - **Delay before first repeat** - tap and pin the slider, and move it to adjust time it responds scroll.
 - **Repeat rate** - move the slider to adjust the time it takes to scroll one item from another.

2. Tap **OK**.

Windows Update

You can use **Window Update** to update the Microsoft programs on your Toshiba phone.

1. From the **Today** screen, tap **Start > Settings > System tab > Windows Update**.

You can select the check way on your Toshiba phone for important updates or optional updates from the **Menu > Change Schedule**.

SIMLock settings

To activate the SIM Lock

1. From the **Today** screen, tap **Start > Settings > Connections tab > More...> SIMLock**.
2. Check the **Prompt if SIM unused for** box.
3. Enter and confirm a password with 8 digits.
4. Tap **Done**.

 **NOTE:** Please make a note of your password.

 **NOTE:** If you activate the SIMLock, you will only be able to use the SIM card used when you activated SIMLock in your Toshiba phone.

 **NOTE:** To disable this feature, enter your 8 digit password and uncheck the Prompt if SIM unused for box.

Connectivity

Manual set up of your data connections

Connecting to the Internet

Your device is equipped with powerful networking functions that enable you to connect to the Internet through a General Packet Radio Service (GPRS) or Universal Mobile Telecommunications System (UMTS) network. You can set up connections to the Internet or to a corporate network to browse the Internet, and exchange e-mail or instant messages.

Your device has two groups of connection settings: **My ISP** (Internet Service Provider) and **My Work Network**. The My ISP settings are used to connect to the

Internet, while My Work Network settings can be used to connect to any private, corporate network.



NOTE: Before you begin, obtain the following information:

- From your cellular phone service provider: data connectivity plan information, access point name, and PAP/CHAP security settings.
- From your Internet service provider (ISP) or wireless service provider: access point name, user name, and password and other security information.



NOTE: If you connect to the Internet using your Service Provider's data network, the service may be provided through a GPRS connection (fast, but generally billed by volume of data transferred), or through a Circuit Switched connection (slow, but generally billed by amount of time connected). You should check with your Service Provider which connection you will use on their network.

Creating a GPRS connection

GPRS is a packet-based wireless communication

service which allows users to send and receive data, with their mobile phones, in functions such as e-mail and web-browsing. Normally, your Service Providers will charge for this service based on the data traffic volume. But, every network connection is different. You should gather all the relevant data you need from your Service Provider.

To create a GPRS connection:

1. From the **Today** screen, tap **Start > Settings > Connections** tab > **Connections**.
2. Tap **Add a new modem connection** of the group you will connect.
3. Enter a name for the connection.
4. Tap the **Cellular Line (GPRS)** in the **Select a modem:** list, tap **Next**.
5. Enter Access point name and tap **Next**.
6. Enter the following information:
 - User name** - enter your user name for the GPRS network, if required.
 - Password** - enter your password, if required.
 - Primary DNS** - enter the primary Domain Name System (DNS) address, if required.
 - Domain** - enter the domain name, if required.

NOTE: if you need to specify the details, tap

Advances.... And enter the followings information:

Use server-assigned IP address – check the radio button on if you automatically configure IP address.

Use specific IP address – check the radio button on, and enter manually IP address.

Use software compression – check the box on if you use.

Use IP header compression – Check the box on if you use.

Use server-assigned address – check the radio button on if you automatically configure.

Use specific server address – check the radio button on if you manually configure, and enter the **DNS, Alt DNS, WINS, Alt WINS.**

7. Tap **OK** and **Finish**.

Your Toshiba phone uses this connection when you connect to the Internet.

Creating a dial-up connection



NOTE: Every network connection is

different. You should gather all the relevant information you need for this service from your Service Provider.

To create a dial-up connection:

1. From the **Today** screen, tap **Start > Settings > Connections** tab > **Connections**.
2. Tap **Add a new modem connection** of the group you will connect.
3. Enter a name for the connection.
4. Tap the **Cellular Line** in the **Select a modem:** list, tap **Next**.
5. Enter a dialed number and tap **Next**.
6. Enter the relevant information (refer to Creating GPRS connection).
7. Tap **OK** and **Finish**.

Creating a proxy connection

Depending on your Service Provider's configuration, you may need to add a proxy connection to allow your Toshiba phone to access the Internet or WAP services. Every network connection is different and your Service Provider will be able to advise if you need to create a proxy connection. You should gather all the relevant information you need, from your Service Provider,

before creating a proxy connection.

To create a proxy connection:

1. From the **Today** screen, tap **Start > Settings > Connections** tab > **Connections**.
2. Tap **Set up my proxy server** in the **My Work Network**.
3. Check the box of **This network connects to the Internet** on, and enter the **Proxy server**:
4. Tap **OK**.

Creating a VPN connection



IMPORTANT: Please ensure that you have setup a successful GPRS connection before trying to create a VPN connection - the VPN connection uses the GPRS connection to connect to your Work network. You should gather all the relevant information you need before creating a VPN connection.

1. From the **Today** screen, tap **Start > Settings > Connections** tab > **Connections**.
2. Tap **Add a new VPN server connection** in the **My Work Network**.
3. Enter the following information:
Name: - enter a name for the connection.
Host name/ IP: - enter the VPN server name.
VPN type - select the VPN type.

Tap **Next**.



NOTE: If you select IPsec/L2TP in the **VPN type**:, select the **Pre-Shared Key** or **Certificate** of authentication type.

4. Enter the relevant informations (refer to Creating GPRS connection).
5. Tap **OK** and **Finish**.

Using a specific connection to connect to the chosen networks

You must define a specific connection to the chosen networks, to connect your Toshiba phone to the correct access point for a particular data transfer type.

To use a specific connection to connect to chosen networks:

1. From the **Today** screen, tap **Start > Settings > Connections** tab > **Connections**.
2. Tap **Set up my proxy server** in the **My Work Network**, and tap **Advanced...**
3. Tap proxy type you want to change, and enter the relevant information.
4. Tap **OK**.

 **NOTE:** Similarly, select the connection you wish to use for the WAP network.

 **NOTE:** The **Work Network** connection is used if you are planning to use a Virtual Private Network connection.

Bluetooth

Bluetooth has three modes: **Off**, **On** and **Visible**. When Bluetooth is set to **On**, your Toshiba phone will be connected to the devices it is already paired with, but will not be visible to new devices. In **Visible** mode your Toshiba phone will perform in the **On** state, but it will also be visible to new devices within range, and you will also be able to receive data from other devices.

Turning Bluetooth on and off

By default Bluetooth is turned off. If you turn it on, and then turn your Toshiba phone off, Bluetooth will also be turned off. But when you turn on your phone

again, Bluetooth will turn on automatically.

To turn Bluetooth on/off:

1. From the **Today** screen, tap **Start > Settings > Connections** tab > **Bluetooth**.
2. Check the **Turn on Bluetooth** box on the **Mode** tab to activate Bluetooth. Uncheck to deactivate.
3. Check the **Make this device visible to other devices** box if you want your phone to be visible to other devices within range.

Creating a Bluetooth partnership

Before creating a Bluetooth partnership:

- Ensure that your Toshiba phone and the device you are connecting to are within close range.
- Your Toshiba phone has Bluetooth turned **On** and that the device you are connecting to is in **Discoverable** mode.

To create a Bluetooth partnership:

1. From the **Today** screen, tap **Start > Settings > Connections** tab > **Bluetooth > Add new device**. Your Toshiba phone searches for other Bluetooth-enabled devices and displays them in the list.
2. Tap the device and tap **Next**.
3. In **Pass code**, If you want to use a pass code

(recommended for enhanced security), enter an alphanumeric pass code, between 1 and 16 characters in length, and tap **Next**.

Alternatively, leave the pass code blank, and tap **Next**.

4. Enter the same pass code on the partnering device and respond to any prompts.

Ending a Bluetooth partnership

1. From the **Today** screen, tap **Start > Settings > Connections** tab > **Bluetooth > Devices** tab.

2. Tap and hold the Bluetooth partnership you want to end. You can see option menu, and tap **delete** and **OK**.

Making your Toshiba phone visible to other Bluetooth devices

Your Toshiba phone must be set to **Visible** to:

- Receive data
- Allow other Bluetooth devices to detect your Toshiba phone.
- Offer services to other devices, such as Internet Sharing.

To make your Toshiba phone visible to other devices:

1. From the **Today** screen, tap **Start > Settings > Connections** tab > **Bluetooth > Mode** tab.

2. Check the **Make this device visible to other devices** box after check the **Turn on Bluetooth** box.

3. Tap **OK**.

Other Bluetooth-enabled devices can now detect your Toshiba phone.

Accepting a Bluetooth partnership

1. Ensure that Bluetooth is turned on and that your Toshiba phone is visible to other Bluetooth enabled devices.

2. When prompted to accept a Bluetooth partnership with another device, tap **Yes**.

3. If you want to use a pass code (recommended for enhanced security), enter an alphanumeric pass code, between 1 and 16 characters in length in the **Pass code** field, and tap **Next**.

4. Enter the same pass code on the partnering device and respond to any prompts. The Bluetooth partnership is created. You can now

exchange data with the other device.

Setting up an outgoing Bluetooth COM port

Some programs can only establish a connection through a serial (COM) port, even if the device itself is Bluetooth-enabled. To make it possible for such programs to use a Bluetooth connection, you must set up a virtual COM port. Once created, this virtual port can be used like any other COM port. You can use a virtual COM port for programs that, for example, connect to a GPS receiver, or to connect to a Bluetooth-enabled printer.

The New Outgoing Port menu command is available only if one or more Bluetooth-connected devices support serial (COM) connections.

1. Ensure that your Toshiba phone is currently connected to the other device via Bluetooth.
2. From the **Today** screen, tap **Start > Settings > Connections** tab > **Bluetooth > COM Ports** tab > **New Outgoing Port**.
3. Tap the device you want to add, and tap **Next**.
4. Tap a numbered COM port from the list.
5. To use this COM port to communicate only with devices with which your Toshiba phone has a

Bluetooth partnership, check the **Secure Connection** box.

6. Tap **Finish**.

Beams

The term 'beam' is used to describe the short range transfer of data between two devices via a Bluetooth connection.

Beaming an item

To beam Calendar, Contacts, Notes, Tasks, and Pictures & Videos files and data to other devices using Bluetooth:

1. Tap the item you want to beam, such as an appointment in Calendar, a task in Tasks, a contact in Contacts, or a picture in Pictures & Videos.
2. Tap **Menu > Beam Appointment**. If you are beaming a contact, tap **Menu > Send Contact > Beam**.
3. Tap the device to which you want to send the data to send.

Configuring your Toshiba phone to

receive beamed data

1. From the **Today** screen, tap **Start > Settings > Connections** tab > **Beam > Receive incoming Beams** box.
2. Tap **OK**.

Receiving beamed data

For security reasons, your Toshiba phone is set by default not to receive beamed data.

To receive beamed data:

1. Ensure the **Make this device visible to other devices** setting is enabled, and that your Toshiba phone is within range of the device beaming the data.
2. You are notified when data is being received on your Toshiba phone.
3. Once the data has transferred, tap **Yes** to save, or **No** to discard.

Checking for a Wireless LAN signal

Before you start a Wi-Fi connection, you must verify

that your Toshiba phone has access to a Wireless LAN channel signal. You can check the current wireless connection status from the following three screens on your phone.

- **Today** screen: If your Toshiba phone detects a Wireless LAN network connection, the Wireless LAN connection icon is displayed at the top of the **Today** screen.
- **Wireless LAN Main** screen: The current connection status and signal quality for each specific wireless channel is displayed on the **Wireless LAN Manager** screen with the current configuration.
- **Configure Wireless Networks** screen: Displays the wireless networks currently available and allows you to add new ones if available.



NOTE: Wireless LAN (Wi-Fi) is the default wireless channel setting for your Toshiba phone. However, GPRS starts by default if your phone does not detect a Wi-Fi signal.

Connecting to a Wi-Fi network

1. From the **Today** screen, tap **Start > Settings > Connections** tab > **Wireless Manager**. You can see

the current Wi-Fi status displayed in this screen.

2. Highlight **Wi-Fi**, and then tap **Menu > Wi-Fi Settings** to configure wireless networks.
3. When the networks are detected, select a network from the list displayed.

To configure the network adaptor:

1. On the **Wi-Fi** settings screen, tap **Network adaptors** tab.
2. Tap the adaptor in you want to configure.
3. On the IP Address tab, Check **Use server-assigned IP address** or **Use specific IP address**.
4. On the Name servers tab, specify **DNS**, **Alt DNS**, **WINS** and **Alt DNS**.
5. Tap **OK**.



NOTE: Once some networks are detected, it pops up a list from the bottom asking you to select one to connect.

Wireless Manager

The Wireless Manager allows you to easily switch the Bluetooth and Telephony functionality on/off.

To start the Wireless Manager:

- From the **Today** screen, tap **Start > Settings > Connections** tab > **Wireless Manager**.

Active items are coloured white. Inactive items are displayed with a cross.

Turning the telephony element on/off

Switch the telephony radio transmission element of your Toshiba phone off by selecting the Phone icon. When a cross is displayed next to the receiver icon, your phone is in 'flight mode' for the telephony element. You will not be able to make/receive telephone calls or use your data network. You can still use Bluetooth however, if activated.

To turn the telephony element back on, select the option again.

USB to PC

Setting the USB to PC

1. From the **Today** screen, tap **Start > Settings**

- > **Connections** tab.
- 2. Tap **USB to PC**.
- 3. Tap the relevant box to enable advanced network functionality.
- 4. Tap **OK**.

USB mass storage

Change the type of USB connection.

- 1. From the **Today** screen, tap **Start > Settings > > Connections** tab.
- 2. Tap **USB mass storage**.
- 3. Tap the relevant box to enable USB mass storage function.
- 4. Tap **OK**.

Applications and multimedia

Your Toshiba phone is installed with the following applications:

- Games
- Office Mobile
- ActiveSync
- Calculator
- Calendar
- Camera
- Contacts
- File Explorer
- Finger Launcher
- Help
- Internet Explorer
- Internet Sharing
- Java
- Marketplace
- Messaging
- Notes
- Opera Browser
- Phone
- Picstel Viewer
- Pictures & Videos
- Search
- SIM Manager
- Tasks
- SIM Toolkit
- Windows Live Messenger
- Windows Live
- Windows Media Player
- Windows Update
- Teleport
- TIPtalk
- GoldKey
- Zoom

Games

To access the games on your Toshiba phone:

1. From the **Today** screen, tap **Start > Programs > Games**.
2. Select the game to play.

Office Mobile

To access the Office Mobile on your Toshiba phone:

1. From the **Today** screen, tap **Start > Programs > Office Mobile**
2. Tap the selected office applications
 - Word Mobile
 - Excel Mobile
 - PowerPoint

Word Mobile

Word documents created on your PC can be opened and edited on your device. However, Word Mobile does not fully support some features, such as revision marks and password protection.



WARNING: Some data and formatting may be lost when you save the document on your device.

You can open *.psw files in Word Mobile; however, if you edit a file, you will need to save it in *.doc, *.rtf, *.txt, or *.dot format

Excel Mobile

Excel workbooks created on your PC can be opened and edited on your device. However, Excel Mobile does not fully support some features, such as formulas and cell comments.



WARNING: Some data and formatting may be lost when you save the workbook on your device. Note the following regarding these Excel Mobile formatting considerations:

PowerPoint Mobile

With PowerPoint Mobile, you can open and view slide show presentations created on your PC. Whether the presentation is opened from an e-mail message, downloaded from a file share or the Internet, copied to the device via a storage card, or obtained by synchronizing with your PC, slide shows created in

*.ppt and *.pps format with PowerPoint '97 and later can be viewed on your device.

Many presentation elements built into the slide shows such as slide transitions and animations will play back on the device. If the presentation is set up as a timed slide show, one slide will advance to the next automatically. Links to URLs are also supported.



WARNING: PowerPoint features not supported on the device include:

- Notes: Notes written for slides will not be visible.
- Rearranging or editing slides: PowerPoint Mobile is a viewer only.
- File formats: Files created in *.ppt format earlier than PowerPoint '97 and HTML files in *.htm and *.mht formats are not supported.

ActiveSync

For more information, please refer to the **Synchronizing** section.

Calculator

To access the calculator:

From the **Today** screen, tap **Start > Programs > Calculator**.

Use the Calculator buttons or Input Panel to enter numbers and perform calculations.

| To | Tap |
|--|--|
| Clear the current calculation or the displayed number | C |
| Clear the last digit entered in a multi-digit entry | The Back arrow to the right of the entry box |
| Clear memory | MC |
| Calculate the reciprocal of a number | 1/X |
| Perform operations with percentages | % |
| Calculate the square root of a number | The square root symbol ($\sqrt{\quad}$) |
| Change a number from positive to negative and back | +/- |
| Display the number stored in memory. | MR |
| Add the displayed number to the number to the number already stored in memory. | M + |

Calendar

The Calendar application works like an electronic diary, allowing you to organize your events. Your entries can then be displayed as reminders on your Toshiba phone. Also, if you also use Outlook on your PC, you can synchronize the information between your PC and your phone.

Scheduling an appointment

1. From the **Today** screen, tap **Start > Programs > Calendar > Menu > New Appointment**.
2. Enter information about the appointment.
3. Tap **ok**.



NOTE: All day events do not occupy blocks of time in the Calendar - instead they are displayed as banners at the top of the calendar.

Making a recurring appointment

1. From the **Today** screen, tap **Start > Programs > Calendar**.
2. Tap the appointment to edit.

3. Tap **Menu > Edit**
4. Tap **Occurs** field and select one of the recurrence options.
5. Tap **ok**.

Updating an appointment

1. From the **Today** screen, select **Start > Programs > Calendar**.
2. Tap the appointment to update.
3. Tap **Menu > Edit**.
4. If the appointment is recurring, select **One** to edit only the current occurrence, or tap **All** to edit the series.
5. Make your changes, and tap **ok**.

Deleting an appointment

1. From the **Today** screen, tap **Start > Programs > Calendar**.
2. Tap the appointment to delete in **Agenda** view.
3. Tap **Menu > Delete Appointment**.
4. If the appointment is recurring, select **All** to delete the series, or select **One** to delete only the current occurrence.

 **NOTE:** When you delete a Calendar appointment on your Toshiba phone, it is also deleted on your PC the next time you synchronize. But if the appointment has not been synchronized with a PC, it will only be deleted from your phone.

 **TIP:** To cancel a deletion, select **Back**.

Changing the work week display

1. From the **Today** screen, tap **Start > Programs > Calendar > Menu > Tools > Options** and do one of the following:

on the **General** tab:

To specify the first day of the week, in the **First day of week** field, select **Sunday** or **Monday**.

To specify the number of days you want displayed in a week, in the **Week view** field, select **5-day week**, **6-day week** or **7-day week**.

2. Tap **ok**.

Changing the reminder time

By default, the reminder time is set to 15 minutes prior to an appointment.

1. From the **Today** screen, tap **Start > Programs > Calendar > Menu > Tools > Options > Appointments** tab.
2. Tap **Set reminders for new items** to check and change the time.
3. Tap **ok**.

Viewing today's agenda

1. From the **Today** screen, tap **Start > Programs > Calendar > Menu > Go to Today**.
2. From **Week** or **Month** view, tap **Menu > Go to Today**.

 **TIP:** To view previous or approaching dates, scroll left or right, or select **Menu > Go to Date**.

Viewing your agenda for a specific Date

1. From the **Today** screen, tap **Start > Programs > Calendar > Menu > Go to Date**.
2. Tap the date on the Calendar.

Viewing your schedule for the month

From the **Today** screen, tap **Start > Programs > Calendar > Menu > View > Month**.

Camera

Your Toshiba phone is equipped with a digital camera which can be used to capture photos and video clips.

Capturing a photograph

You can launch the camera application in the following ways:

- Tap **Start > Programs > Camera**.

or

- Press the **Camera** key on the side of your Toshiba phone.

You can also activate Camera from the Today screen, tap **Start > Programs > Pictures & Videos.>Camera**

Taking a picture

Aim the camera at the subject and either:

- Select the **Left Softkey**.
or
- Press the **Camera** key on the side of your Toshiba phone.

Camera settings

You can set the Camera settings from the Menu on the **Right Softkey** or icons on the Camera screen. When using the icon to change, tap the icon that you want to change.

- **Capt. Mode:** sets the camera mode. Select from:
Photo - select from **Single**, **Timer** and **Burst**.

( /  / )

Video - record videos. ()









NOTE: The **Burst** setting allows you to take multiple rapid-fire shots with one touch of the **Left Softkey** or **Camera** key. This is a very useful feature when shooting subjects in motion.

- **Pict. & Videos:** launches the **Pictures & Videos** feature, where you can review the images you have captured.
- **Zoom:** selects different zoom levels. The zoom

level depends on the size of the picture being taken.



- **Landscape**: captures photos or videos in a wide-angle view, in a way that the longer side runs from side to side. ()
- **Portrait**: captures photos or videos in a way that the longer side runs from top to bottom. ()
- **Front camera**: takes photos or videos with the camera lens facing you. ()
- **Rear camera**: takes photos or videos with the outside camera lens. ()
- **Environment**: sets the colour correction of the camera to show the best effect at the current light. You may also choose to manually set up the correction.
- **Effect**: select the photo effect, such as **Normal**, **Black & White**, **Ancient**, **Cool Color** or **Warm Color**.
- **Options...**: sets the following items;
 - General Settings** tab: set **Store Position**, **Spark Frequency**, **Mobile Light off** () and **Preview after capture**.
 - Single** tab: set **Format**, **Picture Quality** and **Resolution** ().
 - Timer** tab: set **Format**, **Picture Quality**, **Resolution** and **Self-timer**.
 - Burst** tab: set **Format**, **Picture Quality** **Resolution**

and **Burst** .

Video tab: set **Format**, **Picture Quality** **Resolution** **Capture Time** and **Audio Capture**.

- **About**: provides information about the camera.
- **Exit**: exits the **Camera** application.

Capturing a video

Your Toshiba phone can also capture videos that you can play back with Windows Media Player Mobile.

Starting the video recorder

1. Press the **Camera** key on the side of your Toshiba phone.
2. Tap **Right Softkey** > **Capt. Mode** > **Video** and press **Left Softkey** to start recording.
3. Press the **Left Softkey** to stop the recording.



IMPORTANT: Before taking the video, ensure that you have adequate free memory to store your video.

Storing pictures and videos

All pictures and video files taken with your Toshiba

phone are saved on the phone memory by default. But, you can set your phone to save pictures and video files to your miniSD card.

To store pictures and videos on your miniSD card:

1. Ensure that a miniSD card has been inserted into your Toshiba phone (refer to the **Getting started** section for installation instructions).
2. From within the **Camera** application, tap **Menu > Options > General Settings** tab.
3. Tap either **Device** or **Storage Card** in the **Store position** field.

Precautions when using the camera

- Fingerprints or grease sticking to the lens may result in problems such as picture blurring. You should wipe the lens clean with a lens tissue.
- Try to maintain a steady hand when capturing pictures. Any movement of your Toshiba phone may lead to picture blurring.
- Avoid aiming the camera at bright light sources as this will affect the quality of the picture.
- Please consider the privacy of others when capturing pictures with your Toshiba phone.

Contacts

You can customize each contact by adding a picture or a ring tone to uniquely identify the person who is calling you.

Creating a new contact

1. From the **Today** screen, tap **Start > Programs > Contacts > New**.
2. Select a contact type **Outlook Contact** or **SIM Contact** and tap.
3. Enter the information for the new contact.
4. Tap **ok**.



Tip:

TIP: If someone who isn't in your list of contacts, calls you or sends you a message, you can create a contact for that person from Call History or from the message by selecting **Menu > Save to Contacts**.

Creating a SIM contact

Contacts can be created and stored on a subscriber identity module (SIM.) If you move the SIM to another phone, your SIM contacts are moved as

well.

1. From the **Today** screen, tap **Start > Programs > Contacts > New**.
2. Tap **SIM Contact**.
3. Enter the contact's information.
4. Tap **ok**.



TIP: To save an existing contact to your SIM, select the contact and tap **Menu > Save to SIM**.



WARNING: The USIM phone book does not support email addresses or additional numbers.

Find a contact

1. From the **Today** screen, select **Start > Programs > Contacts**.
2. Tap the **Enter a name...**
3. Enter the first letter of name for searching the contact.
4. Tap the contact that you search to watch.



NOTE: You can select the searching item between name and company.

To change the searching item

1. From the **Today** screen, select **Start > Programs > Contacts**.
2. Tap **Menu > View By**.
3. Tap **Name** or **Company**.

Viewing and editing a contact

1. From the **Today** screen, select **Start > Programs > Contacts**.
2. Tap the contact.
3. To edit the contact, tap **Menu > Edit**.
4. Edit the contact.
5. Tap **ok**.

To set the Viewing filter

1. From the **Today** screen, select **Start > Programs > Contacts**.
2. Tap **Menu > Filter**.
3. Tap the filter item that you want to set in the list.



NOTE: To show all contact again, tap **All Contacts** in the list

Deleting a contact

1. From the **Today** screen, tap **Start > Programs > Contacts**.
2. Tap the contact.
3. Tap **Menu > Delete Contact**.

Adding a picture to a contact

1. From the **Today** screen, tap **Start > Programs > Contacts**.
2. Tap the contact.
3. Tap **Menu > Edit > Picture** on **Details** tab.
4. Either select the picture you want to add, or tap **Camera** and take a picture.
5. Tap **ok**.

Removing a picture from a contact

1. From the **Today** screen, tap **Start > Programs > Contacts**.
2. Tap the contact.
3. Tap **Menu > Edit > Menu > Remove Picture**.
4. Tap **Yes** on the Confirm screen.

Assigning a ring tone to a contact

To easily identify who is calling you by the ring tone, you can assign a custom ring tone to each contact.

1. From the **Today** screen, tap **Start > Programs > Contacts**.
2. Tap the contact.
3. Tap **Menu > Edit > ring tone** and select the ring tone you want.
4. Tap **ok**.

Sending contact information

Using a text message, you can quickly send someone information about a contact in your contact list.

To send contact information:

1. From the **Today** screen, tap **Start > Programs > Contacts**.
2. Tap the contact.
3. Tap **Menu > Send Contact > Text Message**.
4. Select the contact information that you want to send and Tap **Done**.
5. In the new text message, enter the phone number of the person to whom you are sending the contact

information and tap **Send**.

 **NOTE:** You can send the contact information using BEAM .

Assigning a category to a contact

You can use categories to help organize your contacts.

To assign a category to a contact:

1. From the **Today** screen, tap **Start > Programs > Contacts**.
2. Tap the contact.
3. Tap **Menu > Edit > Categories**.
4. Tap the category that you set.
5. Tap **ok**.

 **NOTE:** Categories are shared between your appointments, contacts, and tasks. A category will remain in the list of shared categories as long as it is assigned to at least one appointment, contact, or task.

File Explorer

Use the File Explorer tool to view and manage files saved in your Toshiba phone, or on the memory card.

1. From the **Today** screen, tap **Start > Programs >**

File Explorer. File Explorer screen is displayed.

2. Tap the folder in which the files are saved.

Menu items on the My Documents Screen

From the **Today** screen, tap **Start > Programs > File Explorer > Menu**.

The following menu items are displayed in the **My Documents** screen:

- **My Document:** display files saved in **My Document**.
- **Open Path:** create anew path to open file.
- **Send...:** sends the selected file via email or MMS.
- **Beam File...:** sends the file to a contact via Bluetooth.
- **Refresh:** refresh the document screen.
- **Show All Files:** show all the stored files.
- **New Folder:** create a new folder.
- **Rename:** rename a file.
- **Delete:** delete the selected file.
- **Edit:** allows you to manage the file list by using **Undo, Cut, Copy, Paste, Paste Shortcut, and Select All**.

To sort files

From the **File Explorer** screen, tap **Sort by** and select a sorting method: **Name, Date, Size** and **Type**.

Finger Launcher

The Finger Launch application helps ensure the security of the data on your Toshiba phone.

To access the Finger Launch application:

1. From the **Today** screen, tap **Start > Programs > Finger Launcher**. The **Fingerprint Launcher** screen is displayed.
2. Tap **Options**.
3. Tap the finger to swipe.
4. Swipe the finger three times to enrol.

Help

From the **Today** screen, tap **Start > Programs > Help**. The Help window consists of a content area and a navigation toolbar. You can use the following function of **Help**.

| Button | Function |
|----------|--|
| Contents | Displays the Help table of contents, which includes both task-based links to Help and a list of links to Help for other installed Windows Mobile-based |

| | |
|---------------|---|
| | applications. |
| Search | Opens the Search dialog box to search for Help content. |
| Back arrow | Displays the previously viewed Help topic. |
| Forward arrow | Displays the next topic in a sequence of previously viewed Help topics. |

Internet Explorer

Open Internet Explorer

From the **Today** screen, tap **Start > Programs > Internet Explorer**.

Go to a link

1. From the **Today** screen, tap **Start > Programs > Internet Explorer**.
2. Tap Favorites, History to view all available links.
3. Tap the link.

Go to a web page

1. From the **Today** screen, tap **Start > Programs Internet Explorer**.
2. Enter the address.
3. Tap **Search** icon.

Changing the Home pages

1. While on a web page, tap **Menu > Tools > Options > General** tab.
2. Select the home you want.
Use Current: use the displayed page as your Home page.
Use Default: use the default Home page.

Changing the text size on web pages

1. While on a web page, tap **Menu > View > Text Size**.
2. Select the size you want.

Accessing a web page from history

1. While on a web page, tap **History**.
2. Tap the web page.

Showing or hiding web page pictures

While on a web page, tap **Menu > View > Show Pictures**.

Viewing a favorite

While on a web page, tap **Favourites**.

Clearing history, cookies, or temporary files

Following frequent use of the Internet, your Toshiba phone may accumulate data that uses up the storage capacity. It is advisable to delete certain files to free up the storage on your phone.

To clear history or temporary files:

1. While on a web page, tap **Menu > Tools > Options > Memory** tab.
2. Tap the **Clear History or Delete Files** to clear or delete.

To clear cookies:

1. While on a web page, tap **Menu > Tools > Options > Security** tab.
2. Tap the **Clear Cookies** to clear.

Changing cookies and security settings

Internet Explorer Mobile supports the protocols used by Secure Sockets Layer (SSL). A connection that uses SSL helps you to send personal information more safely.

Cookies are small files containing information about your identity and preferences so that a page can tailor information to your needs. The page sends the file, and it is stored on your mobile device.

1. While on a web page, tap **Menu > Tools > Options > Security** tab.
2. Tap the check boxes for the options you want, and tap **ok**.

Sending a link via email

1. Go to the web page you want to send.
2. Tap **Menu > Tools > Send Link....**
3. Select **Text Message, MMS** or **New E-mail Account**. A new message is created with the page address inserted in the message body.



WARNING: Only .wav files are supported for online playback.

Internet Sharing

Internet Sharing is a customized tool for connecting to a PC or Network.

1. From the **Today** screen, tap **Start > Programs > Internet Sharing**.
2. Tap the **PC Connection** status.
3. Scroll to the **Network Connection** and tap the **Network Connection** status.
4. Tap **Connect**.

Java

Your Toshiba phone supports Java applications (known as MIDlets) that are written especially for mobile devices. Java applications include games and utilities.

Starting the Java application

From the **Today** screen, tap **Start > Programs > Java**. After a brief pause, main screen is displayed.

The menu provides the following options:

- **Actions**
- **Install**

- **Activate**
- **Pending Install**
- **New Folder**
- **Options**
- **Uninstall All**
- **Certificates**
- **About**
- **Exit**

Installing a Java application

From the **Today** screen, tap **Start > Programs > Java > Menu > Install**.

You must now select where to access the MIDlets from:

- To install from a website tap **Browser**. This will launch Internet Explorer Mobile. Navigate to the website where the Java MIDlet is kept. Select the file. It is loaded into the Java application.
- To install from a specific URL, tap **URL**. If the URL has already been entered, select it and select **Go**. If the URL has not been entered, select **Add**, and enter the URL description followed by the web address.
- To install from your Toshiba phone, select **Local**

Files. All unloaded MIDlets stored in the Mobile Device folder are displayed. Select one from this list to install.

Selecting the Jad or Jar

The details of the MIDlet you are proposing to install are displayed. Select **Continue** to proceed with the installation.

Once the file has downloaded, you will be asked where you wish to store the download. For ease of use, you should choose to save the file in **<root>**, the base folder for your Toshiba phone.

Running a Java MIDlet

Once you have successfully installed the MIDlet, using one of the methods described above, the installed files are displayed on the Java main screen. Scroll down to the desired MIDlet and press the **Action** key to run the Java MIDlet.

Exiting the Java application

From the main Java screen, tap **Menu > Exit**.

Messaging

For more information, please refer to the **Messaging** section.

Notes

Notes is a tool to capture thought, questions, reminders, to-do lists and meeting notes by handwriting, typing or recording the voice.

To set the default input mode

1. From the **Today** screen, tap **Start > Programs > Notes > Menu > Options**.
2. Tap the item that you want to change the default.
Default mode: Writing or Typing
Default template: Blank note, Meeting note, Memo, Phone memo or ToDo.
Save to: Main memory or Storage card
3. Tap **ok**.

To create a note

1. From the Today screen, tap **Start > Programs > Notes > New**

2. Tap the input Method icon on the menu bar.
3. Tap the strings you want to enter or tap **Input sector** arrow to select the Input Method.
4. Tap **ok** after finishing the input.



NOTE: When you want to record a voice, use the Recording toolbar. If this bar is not displayed on the note screen, tap **Menu > View Recording Toolbar**.

Viewing a note

1. From the **Today** screen, tap **Start > Programs > Notes**.
2. Tap the title that you want to view or play.

Opera Browser

The Opera Browser tool helps connect your Toshiba phone to the Internet.

Opening the Opera Browser

1. From the **Today** screen, tap **Start > Programs > Opera Browser**.
2. Scroll to view all available links.

3. Tap the desired link.

Menu items on the Opera Browser

To access the Opera Browser menu items, from the **Today** screen, tap **Start > Programs > Opera Browser > Menu**.

The Opera Browser has the following menu items:

- **Windows**: manages the window.
- **Display**: changes the windows viewer.
- **Tools**: manages bookmarks and displays useful information.
- **Exit**: exits the Opera Browser.

Phone

Phone is the shortcut of **Phone** screen.

For more information of **Phone** screen, please refer to the **Call Fncions** section.

Picisel Viewer

Picisel Viewer is the tool used to view PDFs

Opening Picisel Viewer

1. From the **Today** screen, tap **Start > Programs >**

Picisel Viewer.

2. Tap the file that you want to view.
3. Press the **Action** key.

Menu items on the Picisel Viewer screen

From the **Today** screen, tap **Start > Programs > Picisel Viewer > Menu**.

The Picisel Viewer has the following menu items:

- **Open File**: opens the selected file.
- **Recent**: shows the recent selected file list.
- **Page**: rotates the window, from Portrait to Landscape or vice versa.
- **Settings**: allows you to manage preferences, file types, help and file information.
- **Close**: exits Picisel Viewer.

Pictures & Videos

Your Toshiba phone is equipped with a digital camera which can be used to capture photos and video clips.

For more information about capturing photos and video clips, please refer to the **Camera** section.

Viewing pictures and videos

You can view pictures and videos stored on your Toshiba phone or miniSD card using the **Pictures & Videos** application.

You can also set a picture to be your **Today** screen background, or you can send an image to a contact.

To view pictures and videos, from the **Today** screen, tap **Start > Programs > Pictures & Videos**.

Use the **Navigation** key and press **Action Key** to preview the pictures.

Pictures & Videos functions

From within the **Pictures & Videos** application, **focus on the picture and** tap **Menu** to view the available options:

- **Send:** sends pictures to other recipients via MMS or E-mail.
- **Beam:** transfers pictures to other devices via Bluetooth.
- **Save to Contact:** sets a picture as an icon representing a specified contact, shown within the details of the contact.
- **Delete:** deletes the **tapped selected** picture.
- **Edit:** enables you to move and copy picture and video files between folders.

- **Properties:** **Enables you to rename** and View the detail of the selected picture.

- **Play Slide Show:** view all pictures in the current folder as a slide show.

- **Set as Today Background:** Set the selected picture as Today background.

- **Options:**

- General tab -** set the photo size and rotated degree.

- Slide show tab - Change the slide show setting**

- **Send to your space:** Send the selected picture to your live space.

Finding and listing pictures

From within the **Pictures & Videos** application, tap **My Pictures** and select a folder from the drop-down menu.

Sort pictures and video clips

From within the **Pictures & Videos** application, tap the sort list and select the item you want to sort by.

You can sort by **Name**, **Date** and **Size**.

Opening a picture

From within the **Pictures & Videos** application, tap a picture.

Sending a picture

1. From within the **Pictures & Videos** application, tap **Menu > Send**.
2. Select the sending method.
3. Enter the destination number and tap **Send**. Tap **Menu** for a list of additional options.

When viewing a picture, tap **Menu** to access the following settings:

- **Zoom:** zooms in or out of the selected picture.
- **Play slide show:** view all pictures as a slide show.
- **Set as Today background:** sets the selected picture as wallpaper for the **Today** screen.
- **Beam picture:** sends pictures via Bluetooth.
- **Save:** associate a picture with a phone contact or rename the picture.
- **Edit:** edits pictures.
- **Properties:** displays picture properties, such as file name and size.
- **Options:** set the photo size and rotated degree.
- **Send to your space:** Send the selected picture to your live space.

Search

For more information, please refer to the **Searching** section in the **Text input** capture.

SIM Manager

SIM manager enables you to copy your contacts' information from your Toshiba phone to your SIM card or from your SIM card to your Toshiba phone.



1. From the **Today** screen, tap **Start > Programs > SIM Manager**.
 2. Tap **SIM** or **Phone** that you want to show the Contacts.
 3. The selected Contacts List is displayed. Tap **Menu** to edit the contacts.
- **Delete Selected:** delete the selected contacts data.
 - **Copy to SIM/Phone:** copy the selected contacts data to the other.

- **Select All:** check the boxes of all contacts data.
- **Deselect All:** uncheck the boxes of all contacts data.

SIM Toolkit

When you install the SIM that has some applications, you can select the application to execute from the SIM.

1. From the **Today** screen, tap **Start > Programs > SimTKUI**.
2. The application list is displayed on the screen. Select the application that you want to execute and tap **Select**.

 **NOTE:** SimTKUI icon  is not displayed when the installed SIM doesn't have any applications. The title of this icon (default title: **SIMTKUI**) depends on SIM title.

Tasks

You can set a one-off task or a recurring task. You can also set reminders for your tasks.

Creating a task

1. From the **Today** screen, tap **Start > Programs > Tasks**.
2. Tap the **Tap here to add a new task** field and enter the task.
3. Tap a screen. A new task item is displayed.

A new task sets the following items as a default. If you want to change them, tap the task and tap **Edit**.

Priority: Normal
Status: Not Completed
Starts: None
Due: None
Occurs: Once
Reminder: None
Categories: No categories
Sensitivity: Normal

 **NOTE:** You can synchronize information on your Toshiba phone with your PC. This will keep your task list up to date in both locations.

 **NOTE:** If you create a new task with a reminder on your PC and then synchronize tasks with your Toshiba phone, the reminder is activated at the time it was set on your PC.

Changing the task settings

1. From the **Today** screen, tap **Start > Programs > Tasks** .
2. Tap the task that you want to change and tap **Edit**.
3. Tap the item that you want to change.
4. Tap **ok** after finishing the set.

Deleting a task

1. From the **Today** screen, tap **Start > Programs > Tasks**.
2. Select the task, and tap **Menu > Delete Task** or tap the task and tap **Menu > Delete**.

Marking a task as complete

1. From the **Today** screen, tap **Start > Programs > Tasks**.
2. Select the task, and tap **Complete**.

Changing a completed task to incomplete

1. From the **Today** screen, tap **Start > Programs > Tasks**.

2. Select the task, and tap **Activate**.

Locating a task

1. From the **Today** screen, tap **Start > Programs > Tasks**.
2. In the task list, do one of the following:
To sort the list, tap **Menu > Sort by**, and select a sort option.
To filter the list by category, select **Menu > Filter**, and select the category you want displayed.



NOTE: To filter your task further, select Active Tasks or Completed Tasks

~~Windows Live~~ Messenger

For more information, please refer to the **Messaging** section.

Windows Live

You can use **Window Live** to use the searching service from Microsoft.

1. From the **Today** screen, tap **Start > Programs > Windows Live**.
2. Tap and enter the word for search in the search box and tap search icon or tap **Sign in to Windows Live** to sign in.

Windows Media Player

Overview of Windows Media Player Mobile

You can use **Windows Media 10 Mobile** to play digital audio and video files that are stored on your Toshiba phone or on the Web.

The Windows Media Player Mobile can play the following types of files by default:

- Windows Media Audio (WMA)
- Windows Media Video (WMV)
- Motion Picture Experts Group-2 Audio Layer-3 (MP3).

This includes the following file extensions:

- .asf
- .wma
- .wmv
- .mp3.

Your Toshiba phone can also play back H.263 (.3gp) and .mp4 files.

In addition to Windows Mobile-based Pocket PCs, Windows Media player is available on other operating systems, including Windows Mobile based Smartphones and desktop computers running the Windows or Macintosh operating systems.

Overview of the controls

By default, the following keys are assigned to Windows Media Player Mobile functions:

- **Action** key - plays or pauses a file.
- **Left Navigation** key - skips to a previous file.
- **Right Navigation** key - skips to the next file.
- **Up Navigation** key - increases the volume.
- **Down Navigation** key - decreases the volume.
- **Right Navigation** key (hold) - fast-forward a file.
- **Left Navigation** key (hold) - rewind a file.

Overview of screens and menus

Windows Media Player Mobile has three primary screens:

- **Playback** screen - displays the playback controls (such as Play, Pause, Next, Previous,

and Volume), the star rating of the current file, the album art window, and the video window. You can change the appearance of this screen by selecting a different skin.

- **Now Playing** screen - displays the **Now Playing** playlist, which indicates the file currently playing as well as any files in the queue.
- **Library** screen - enables quick access of audio files, video files, and playlists. It contains categories such as My Music, My Video, My TV, and My Playlists. It also includes a link that lets you switch to the **Now Playing** screen.

Selecting the **Menu** option displays different options depending on the screen you are in.

The Now Playing screen settings

- **Library**: displays the library.
- **Move Up**: moves the selected item up in the playlist order.
- **Move Down**: moves the selected item down in the playlist order.
- **Remove from Playlist**: removes the selected item from the playlist.
- **Shuffle/Repeat > Shuffle**: plays the item in the

Now Playing playlist in a random order.

- **Shuffle/Repeat > Repeat**: plays the item in the **Now Playing** playlist repeatedly.
- **Save Playlist**: saves the playlist.
- **Clear Now Playing**: removes all items from the **Now Playing** playlist.
- **Error Details**: displays error information about the selected item. An exclamation mark is displayed before the item name if error details are available.
- **Properties**: displays information about the selected file.

The Library screen settings

- **Queue Up**: adds the selected item to the end of the current playlist.
- **Delete from Library**: deletes the selected item from the library.
- **Now Playing**: displays the **Now Playing** playlist.
- **Library > library name**: switches between libraries, for example between the **My Device** and **Storage Card** libraries.
- **Update Library**: adds new items to the library by searching your Toshiba phone or storage card.

- **Open File:** allows easy access of files that are not in the library.
- **Open URL:** allows you to play a file on a network, such as the Internet.
- **Properties:** displays information about the selected file.

Overview of licenses and protected files

Protected files are digital media files that are secured with a license to prevent unauthorized distribution or playback.

The license specifies how you can use the file. For example, a license can specify whether you can use the desktop player to synchronize a file to your Toshiba phone or it can specify how many times you can play a file on your Toshiba phone. The terms of the license are specified by the person or company that provided the file.

Licenses are created and managed by a technology called Digital Rights Management (DRM). Because Windows Media player 10.1 Mobile for Pocket PC supports Windows Media DRM 10, you can download and play protected files that you have obtained from compatible online stores, such as MSN Music.

If permitted by the license and your Toshiba phone,

you can play subscription or rental content from some online stores.

For information about compatible online stores and devices, access the PlaysForSure website at: www.playsforsure.com.

When copying a protected file from your computer to your Toshiba phone:

- Always use the desktop version of Windows Media Player 10 to synchronize the file to your phone.
- Always synchronize the file to a storage card on your phone. Do not synchronize to a storage card that is inserted into a storage card reader.



NOTE: View the file properties to determine whether a file is protected.

Playing items on your Toshiba phone

Use the library to find and play songs, videos, and playlists that are stored on your Toshiba phone or storage card.

1. From the **Today** screen, tap **Start > Programs > Windows Media > Menu > Library**.

If necessary, from the **Library** screen, tap **Menu >**

Library, and select the library that you want to use, for example **Storage Card**.

2. Tap a category (for example, **My Music** or **My Playlists**), and select the item that you want to play (such as a song, album, or artist name).

3. Tap **Play**.



NOTE: To play a file stored on your Toshiba phone but not in a library, tap **Menu > Open File**, from the **Library** screen.

Tap the item that you want to play (such as a file or a folder), and tap **Play**.

Playing items on a network

Use the **Open URL** setting to play a song or video that is stored on the Internet or on a network server.

1. If you are not in the **Library** screen, tap **Menu > Library**.

2. Tap **Menu > Open URL**.

3. In the **URL** box, enter a network address.

or

Tap a URL that you have previously used in the **History** box.



NOTE: To play an item on a network, your Toshiba phone must be connected to a network. For more information about connecting your phone to a network, refer to the **Connectivity** section.

Copying files to your Toshiba phone

You can either copy files to your Toshiba phone manually or you can automatically synchronize files between your PC and your Toshiba phone.

Use the Sync feature in the desktop version of Windows Media Player 10 to synchronize digital media files from your computer to your phone.

Using Sync ensures that protected files and album art are copied to your phone correctly.



NOTE: To perform this function, you must have ActiveSync set up.

Changing the Player appearance

You can change the appearance of the Playback screen by choosing a new skin.

1. From the **Today** screen, tap **Start > Programs > Windows Media > Menu > Options > Skins** tab.

2. Press the **Right** or **Left Navigation** key to view the skins. Select the skin you want.
3. Tap **ok**.



NOTE: To download new skins, access the WMplugins.com website at: www.wmplugins.com.

After downloading a skin to your computer, use ActiveSync to copy the .skn and .bmp files to your Toshiba phone. To ensure that the skin is displayed on the **Skins** tab, do not store skin files in the Windows folder on your Toshiba phone.

Troubleshooting

If you encounter any difficulty while using Windows Media Player Mobile, a number of resources are available on the web to help you resolve the issue. For more information, see the Troubleshooting Windows Media Player Mobile page on the Microsoft website at: <http://go.microsoft.com/fwlink/?LinkId=29195> .

Windows Update

For more information, please refer to the **Settings**

section.

Teleport

The Teleport application enables you to use two features: Remote Keypad and Remote Screen.

Remote Keypad

With Remote Keypad you can scroll and type input into a PC application, displayed on a PC screen, using your Toshiba phone.

Remote Screen

With Remote Screen, you can replicate the main display of your Toshiba phone on a PC screen, and operate your Toshiba phone from the PC. Using the PC keyboard and Remote Screen GUI on the PC, actions on the PC are relayed to your Toshiba phone.

Preparing to use Teleport

- Install the Teleport application to a PC.
- Ensure the Teleport application is activated before installing your Toshiba phone.

- The Teleport application supports the following communication options: USB, Bluetooth, and Wi-Fi.
- Establish a connection between your Toshiba phone and the PC before using the Teleport application.
Select either the Remote Keypad or Remote Screen buttons, on the PC.

 **NOTE:** When using Teleport with Wi-Fi, you will need to set **Turn off device if not used for** is **uncheck** from **Start > Settings > System** tab > **Power > Advanced** tab for Wi-Fi not to disconnected.

To start using Teleport

Perform the following steps on your Toshiba phone:

1. From the **Today** screen, tap **Start > Programs > Teleport**.

2. Tap either the **Remote Keypad** or **Remote Screen** option.
3. Select **Connection Method** and tap **Next**.

Teleport Application main screen description

Remote Keypad

Select the Remote Keypad feature to navigate a PC application using the navigation keys on your Toshiba phone.

Remote Screen

Select the Remote Screen feature to input text data into your Toshiba phone using the PC input device.

Connection method

Select the Connection Method to connect your Toshiba phone to the PC. These connection methods are: Bluetooth, USB and Wi-Fi.

- **Network Port:** To set the network port for USB and Wi-Fi, tap **Menu > Network Port**.
- **COM Ports:** To set the COM ports for Bluetooth, tap **Menu > COM Ports**.
- **PIN Code:** To set the Teleport PIN Code, tap **Menu >**

PIN Code, from within the Teleport application.

- **Help:** To view instructions for using Teleport on the phone, tap **Menu > Help**.
- **About:** To view the Teleport version, tap **Menu > About**, from within the Teleport application.
- **Exit:** To quit the Teleport application, tap **Menu > Exit**, from within the Teleport application.

Remote Keypad operations:

Up Navigation key - moves the PC cursor up.

Down Navigation key - moves the PC cursor down.

Left Navigation key - moves the PC cursor to the left.

Right Navigation key - moves the PC cursor to the right.

Action key - works as the PC Enter key.

Back key - hides the Teleport application.

PgUp key - performs a Page Up on the PC.

PgDn key - performs a Page Down on the PC.

Other keys - inputs characters to the PC according to the guidance shown.

TIPTalk

The TIPTalk application enables you to:

- Call an IP phone.
- Use answering machine functions.
- Check the online status of your contacts (Online, Offline, Away, or Busy).
- Notify your contacts of your current online status (Online, Offline, Away, or Busy).
- Send and receive instant messages during a call.



NOTE: When using Teleport with Wi-Fi, you will need to set **Turn off device if not used** for is **unchecked** from **Start > Settings > System** tab > **Power > Advanced** tab for Wi-Fi not to disconnected.



WARNING:

1. TIPTalk does not support Bluetooth headset microphones.
2. If TIPTalk is activated while Windows Media is playing music on the speakerphone, the audio path will be switched. When this happens, both the music and the TIPTalk call will be routed to the normal phone earpiece, and the music will no longer be played on the speakerphone.

Launching TIPTalk

Tap **Start > Programs > TIPtalk**.

A configuration dialog is displayed when you launch TIPtalk for the first time. **Please refer to Configuring TIPtalk section.**

Calling an IP phone

1. From within the TIPtalk application, tap the **Contacts** tab.
2. Select a contact from your contact list.
3. Tap **Call**.

 **To end call, tap Hangup on the screen,.**

Answering a call automatically

To answer a call automatically, you must check the **Automatic answer** box on the **Configuration** screen. This application automatically answers, and redirects the call to the answer message service, ten seconds after the call is received.

Holding a call

From within the TIPtalk application, tap **Menu >**

Voice Service > Hold while in a call.

To continue the call, tap **Menu > Voice Service > Hold** again.

Redialling using outgoing call history

You can store twenty contacts in the outgoing call history contacts at any one time.

To redial using outgoing call history:

1. From within the TIPtalk application, tap **Outgoing Calls** tab.
2. Select an outgoing call history contact.
3. Tap **Call**.

Calling back using incoming call history

You can store twenty contacts in the incoming call history contacts at any one time.

To call back using incoming call history:

1. From within the TIPtalk application, tap **Incoming Calls** tab.
2. Select an incoming call history contact.
3. Tap **Call**.

Muting the microphone

From within the TIPTalk application, tap **Menu > Voice Service > Mute**.

To reactivate the microphone tap **Menu > Voice Service > Mute** again.

Switching to handsfree mode

From within the TIPTalk application, tap **Menu > Voice Service > Handsfree**.

To deactivate the handsfree mode, simply tap **Menu > Voice Service > Handsfree** again.

Adding an entry to your contacts list

1. From within the TIPTalk application, tap **Menu > Edit Contacts > Add Contact**.
2. Enter the contact name.
3. Tap **OK**.

Removing an entry from your contacts list

1. From within the TIPTalk application, tap **Contacts** tab.
2. Select the contact name to remove.
3. Tap **Menu > Edit Contacts > Delete Contact**.
4. Tap **OK**.

Playing back a voicemail

1. From within the TIPTalk application, tap **Incoming Calls** tab.
2. Select an incoming call history entry, marked with a voicemail icon.
3. Tap **Menu > Voice Service > Play Back**.

Instant messaging (IM)

You can send and receive instant messages using the TIPTalk application.

To start instant messaging:

1. Call another TIPTalk user.
2. Tap **Menu > Send Instant Message** once the call has been connected.
3. Enter your message in the second text box.
4. Tap **Send** to send your message. All the messages in the thread are displayed in the first message box.

Changing your current status

From within the TIPTalk application, tap **My Status** box and select your current status (offline, online, busy or away).

Configuring TIPtalk

1. From within the TIPtalk application, tap **Menu > Configuration**.
2. Enter your user name, password, server IP, and server port. In addition, if two or more network adapters are shown, designate a network adapter to use.



NOTE: If you select the **Automatic answer** box, TIPtalk will automatically answer a call. The caller can then leave a voice message.

GoldKey

Your Toshiba phone allows you to lock or unlock your PC remotely, via Bluetooth technology. Using the **GoldKey** application, this security operation is achieved by simply pressing a key on your Toshiba phone, or automatically with the Auto Lock option. There are three types of lock methods:

- Screen Lock
- Screen Saver
- Log Off

Starting GoldKey

You need to run the GoldKey Registration program on your PC to establish a link between the PC and your Toshiba phone.

When running this service program, you must enter:

- Lock type
- Password
- PC name

This information must then be sent to your Toshiba phone. The link between the PC and your Toshiba phone is finalised when the registration information has been received on your Toshiba phone.



- NOTE:** GoldKey has two restrictions:
1. It can only run with the Toshiba BT stack.
 2. It can only be operated by a single user.

Zoom

The Zoom application enables you to magnify or decrease the current window size. You can magnify the window to eight times the standard size.

You can use the Set Zoom Level box to set a specific zoom level in the Viewer or in Edit Mode.

The Zoom application is launched at a default level

of x2 (200%). It can be set to the following levels:

- x2 (200%)
- x4 (400%)
- x8 (800%)

To launch the Zoom application, press and hold the **Up Side** key.

Use the following keys when using the Zoom application:

- Press the **End** key to close the zooming application and return to the **Today** screen.
- Press the **Left Softkey** to zoom-in.
- Press the **Right Softkey** to zoom-out.
- Press the **Up Navigation** key to scroll up the zoomed screen.
- Press the **Down Navigation** key to scroll down the zoomed screen.
- Press the **Right Navigation** key to scroll right in the zoomed screen.
- Press the **Left Navigation** key to scroll left in the zoomed screen.

- Tap and hold the stylus on the zoom application screen to open a pop up menu with the following menu items.

x2

x4

x8

- You can select a menu item X2, X4 or X8 to zoom the screen to 200%, 400% or 800% respectively.
- You can use the horizontal and vertical scroll bars for scrolling.
- You can drag the screen using the stylus to move the focus accordingly.
- In case of interruption due to external applications like phone call, scheduled alarm etc, the zoom application will close automatically.
- When the zoom application is open, you will not be able to operate the currently opened application. i.e., zooming is a view only functionality.

Specification

System Information

Processor

Marvell® PXA270 Processor at ??? MHz

Memory

RAM : 128 MB

ROM : 128 MB

Operating System

Windows Mobile® 6 Professional

UMTS/HSDPA GSM/GPRS/EDGE

Frequency Range

Within 3G (UMTS) 2100

1920 - 2170 MHz

Within GSM 900

880 - 960 MHz

Within DCS 1800

1710 - 1880 MHz

Within PCS 1900

1850 - 1990 MHz

Continuous Talk Time

Within 3G (UMTS) area

Approx. ??? mins

Video Call

Approx. ?? mins

Within GSM area

Approx. ??? mins

Continuous Standby Time

Within 3G (UMTS) area

Approx. ??? hrs

Within GSM area

Approx. ??? hrs

Charging Time

Approx. ??? mins

Dimensions (H × W × D)

Approx. ??mm x ??mm x ??mm

Maximum Output

| | | |
|-----------------------|---------|--------|
| Within 3G (UMTS) 2100 | Class 3 | 0.25 W |
| Within GSM 900 | Class 4 | 2 W |
| Within DCS 1800 | Class 1 | 1 W |
| Within PCS 1900 | Class 1 | 1 W |

Weight

Approx. ???g

AC Adapter

Input Voltage

100 to 240 VAC

Charging Temperature Range

5 to 35 °C

Display

LCD

3.0" TFT LCD with Touch screen

Resolution

480x 800 (??k colours)

Audio/Video Codec

Audio

AMRNB, AAC, AAC+, eAAC+, MP3, WMA

Video

H.263, MPEG4, WMV

Connection

Bluetooth

Bluetooth™ ver 2.0 + EDR (Power Class 2)

GAP (Generic ~~ac~~ Access Profile)

SPP (Serial Port Profile)

HSP (Headset Profile)

~~OPP (Object Push Profile)~~

HFP (Hands Free Profile)

~~GOEP (Generic Object Exchange Profile)~~

PAN ~~P~~ (Personal Area Networking ~~Profile~~)

AVRCP (Audio/Video Remote Control Profile)

A2DP (Advanced Audio Distribution Profile)

Wireless LAN

IEEE 802.11b/g (~~Available ch 1 to 11~~)

WPA, WPA2, WEP, TKIP, AES

Interface

Cable and Phone Charging

mini USB (Host/Client, Full Speed) / Charger

Headset Connector

2.5 mm Stereo headset

Expansion Slot

miniSD

Troubleshooting

Problem

Cannot turn the power on

Cannot charge the battery

Cannot make or receive voice and video calls

Cannot use the Web

Possible Causes and Solutions

- Ensure that the battery is inserted correctly (pg XX).
- Ensure that the battery is charged (pg XX).
- Ensure that the battery is inserted correctly.
- Ensure that the AC adapter and battery pack connectors are clean.
- Check the signal strength indicator. If the display indicates a poor signal adjust your physical location to be clear of obstructions that may block the signal.
- A video call can only be made or received in an area with 3G coverage. Ensure that the sign for indicating you are in an area with 3G coverage appears on the display in standby mode.
- If you enter the PIN code incorrectly three times in a row, the PIN lock will be set, preventing calls being made because access to the SIM card is blocked (pg XX). Enter the PUK code to cancel the PIN lock.
- If the indicator appears on the display, enter your security code to cancel the phone lock.
- Check your subscription status. Contact your service provider.
- The network settings may be incorrect. Check the network settings. For details on network settings, contact your service provider.

Cannot use SMS
and MMS

- Check your subscription status. Contact your service provider.
- Ensure that the service centre number is correct. For details on the service centre number, contact your service provider.

Health and Safety

General

- Always use your Toshiba phone in the intended manner. Incorrect usage may affect performance. Only qualified service personnel should install or repair the phone and its accessories.
- To avoid permanent damage to your Toshiba phone, use only Toshiba approved batteries and accessories.
- The bundled battery and AC adapter is only for use with your Toshiba phone. Do not use this battery or AC adapter with any other device as this may cause permanent damage to the device, battery and AC adapter.
- Before connecting your Toshiba phone to another device, read the supporting documentation to confirm that the other device is compatible.
- When making emergency calls from your Toshiba phone, ensure that the phone is switched on and in service.
- When your Toshiba phone is used for extended periods of time, especially in high temperature conditions, the phone surface could become hot. Please use caution when touching the phone under such conditions.
- When using ear buds or other headphones, be careful not to listen at excessive volumes. Listening to very loud sound levels may lead to hearing loss. Also, listening through the ear buds or headphones for prolonged periods of time, even at normal sound levels, may lead to hearing loss. You should consult your doctor for more information on proper use of ear buds or headphones.
- It is recommended that pregnant and young women take precautions while in a call and keep the phone at a distance from their lower abdomen. For this situation, use of a hands free kit is recommended.
- It is recommended that using bundled stylus to press the **Reset button**.

Operating Environment

- Do not handle your Toshiba phone while driving or when operating machinery. If you must handle the phone while driving, park the vehicle before conversing. If using an integrated hands free device, make sure the phone is securely placed in its holder.
- Switch your Toshiba phone off if you are entering a hospital or health care facilities. Medical equipment may be affected by phone usage. Always follow building regulations governing phone usage.
- Switch your Toshiba phone off when travelling on an aircraft. The phone signal may interfere with the systems in the aircraft. You are legally bound to comply with this recommendation.
- Switch your Toshiba phone off in any facility where posted notices prohibit phone usage.
- Do not use your Toshiba phone when refuelling. You should keep the phone away from fuel and chemicals.
- Switch your Toshiba phone off when blasting is in progress and observe all provided guidelines and regulations.
- Switch your Toshiba phone off in areas with potentially explosive atmospheres. For example, fuel storage areas and spray paint facilities.
- Switch your Toshiba phone off when outdoors during an electrical storm.
- Only qualified personnel should install the device in a vehicle. Faulty installation or service may be dangerous and may invalidate any warranty. For more information, consult your vehicle manufacturer or representative.

Electronic Devices

- If you wear a pacemaker, or are in the company of someone who does, you should be aware that there is a small risk of mobile phone usage interfering with the operation of the pacemaker. You should contact your doctor, or the manufacturer of the pacemaker, for more information.
- Mobile phone usage may interfere with some hearing aids. If this happens you should contact your service provider or doctor.
- Mobile phone usage may interfere with the functionality of inadequately shielded medical devices. Consult a physician or the manufacturer of the device to ensure safe procedures are used.
- Mobile phone usage may interfere with the functionality of any inadequately shielded electronic system in a motor vehicle. Examples include airbags and fuel injection. You should contact the manufacturer of the vehicle to ensure that the electronic system is properly shielded.

Battery safety

Your Toshiba phone is powered by a rechargeable battery. The full performance of a new battery is achieved only after two or three complete charge and discharge cycles. The battery can be charged and discharged hundreds of times but it will eventually wear out. When the talk and standby times are noticeably shorter than normal, it is recommended that you buy a new battery.

- A new battery, or one that has not been used for a long time, could have reduced capacity during initial use.
- The battery can only be charged in temperatures between +5 °C (+41 °F) and +35°C (+95 °F).
- Only use batteries approved by Toshiba and only recharge the battery with the recommended charger supplied by Toshiba.
- When the charger is not in use, disconnect it from the power source.
- Do not leave the battery connected to the charger and power source for longer than necessary as overcharging will shorten the lifespan of the battery.

- Do not short-circuit the battery. Accidental shortcircuiting can occur when a metallic object causes a direct connection between the + and - terminals of the battery.
- Do not leave the battery in areas of extreme cold or heat as this will affect the performance of the battery. Areas of extreme cold include a refrigerator, and areas of extreme heat include a car exposed to direct sunlight.
- Do not dispose of the battery in a fire.
- Do not dispose of the battery in an ordinary bin. The battery contains toxic chemicals and must be disposed appropriately. Contact your local authorities for more information.

AC adapter and cable safety

- Do not use a damaged or worn AC adapter or cable. The use of a damaged or worn AC adapter or cable could result in electric shock, burns or fire. Contact an authorised Toshiba service provider immediately to obtain suitable replacements.
- Do not bend or twist the AC cable.
- Do not pull on the AC cable in order to remove the plug from a socket.
- Do grasp the plug directly when unplugging the AC cable to avoid causing any damage to the cable.
- Do not place heavy objects on the AC adapter or cable.

Emergency calls

Calls cannot be made to emergency services while data communication is being performed within a GSM area. If the system mode is set to UMTS Only or GSM Only, calls cannot be made to emergency services if the selected network is unavailable. Also, calls may not be able to be made to emergency services depending on the network services of some service providers.

IMPORTANT: You can still make calls to emergency services when the SIM card is not inserted, the SIM card is locked, the phone lock is set, Fixed Dialling Numbers is set, Flight Mode is set or Call Barring Service is set.

There is no guarantee that a connection can be established in all countries and areas because operation of your phone differs depending on the wireless network, wireless signal and your setting status. Do not rely solely on your mobile phone when you need to make emergency calls.

- Do not use a damaged or worn AC adapter or

FCC RF exposure information

Your Toshiba phone is a radio transmitter and receiver. It is designed and manufactured not to exceed the emission limits for exposure to radio frequency (RF) energy set by the Federal Communications Commission of the U.S. Government.

The guidelines are based on standards that were developed by independent scientific organisations through periodic and thorough evaluation of scientific studies. The standards include a substantial safety margin designed to assure the safety of all persons, regardless of age and health. The exposure standard for wireless handsets employs a unit of measurement known as the Specific Absorption Rate, or SAR. The SAR limit set by the FCC is 1.6W/kg. The tests are performed in positions and locations (e.g., at the ear and worn on the body) as required by the FCC for each model. The SAR value for this model handset when tested for use at the ear is **X.XXX**W/kg and when worn on the body, as described in this user guide, is **X.XXX**W/kg.

Body-warm operation

This phone was tested for typical body-worn operations with the back of the phone kept at a distance of 1.5cm from the body. To maintain compliance with FCC RF exposure requirements, use accessories that maintain a 1.5cm separation distance between your body and the back of the phone. The use of belt clips, holsters and similar accessories should not contain metallic components. The use of accessories that do not satisfy these requirements may not comply with FCC RF exposure requirements, and should be avoided.

The FCC has granted an Equipment Authorization for this model handset with all reported SAR levels evaluated as in compliance with the FCC RF emission guidelines. SAR information on this model handset is on file with the FCC and can be found under the Display Grant section of <http://www.fcc.gov/oet/fccid> after searching on FCC ID SP2-RG4-J01.

Additional information on Specific Absorption Rates (SAR) can be found on the Cellular Telecommunications & Internet Association (CTIA) website at <http://www.phonefacts.net>.

European RF exposure information

Your Toshiba phone is a radio transmitter and receiver. It is designed not to exceed the limits for exposure to radio waves recommended by international guidelines. These guidelines were developed by the independent scientific organisation ICNIRP and include safety margins designed to assure the protection of all persons, regardless of age and health.

The guidelines use a unit of measurement known as the Specific Absorption Rate, or SAR. The SAR limit for mobile devices is 2 W/kg and the SAR value for this device when tested at the ear was 0.464 W/kg*. As mobile devices offer a range of functions, they can be used in other positions, such as on the body as described in this user's guide**. In this case, the tested SAR value is 0.918 W/kg. As SAR is measured utilising the device's highest transmitting power, the actual SAR of this device while operating is typically below that indicated above. This is due to automatic changes to the power level of the device to ensure it only uses the minimum level required to reach the network.

The World Health Organization has stated that present scientific information does not indicate the need for any special precautions for the use of mobile devices. They state that if you want to reduce your exposure then you can do so by limiting the length of calls or using a 'hands-free' device to keep the mobile phone away from the head and body. Additional Information can be found on the website of the World Health Organization (<http://www.who.int/emf>).

* The tests are carried out in accordance with international guidelines for testing.

** Please see the <FCC RF Exposure Information> section about body worn operations.

The following Information is only for EU-Member States:



The use of the above symbol indicates that this product may not be treated as household waste. By ensuring this product is disposed of correctly, you will help prevent potential negative consequences for the environment and human health, which could otherwise be caused by inappropriate waste handling of this product. For more detailed information about recycling of this product, please contact your local city office, your household waste disposal service or the shop where you purchased the product.

Purchase records

For your future reference, we recommend that you fill in your purchase details in the form below.

Serial Number*:

Dealer Name:

Purchase Date:

* The serial number is printed on the bottom of the battery compartment.

Menu tree

Programs

Games

Office Mobile

1 Excel Mobile

2 PowerPoint

3 Word Mobile

ActiveSync

Calculator

Calendar

Camera

Contacts

File Explorer

FingerLauncher

GoldKey

Help

Internet Explorer

Internet Sharing

Java

Marketplace

Messaging

1 Text Message

2 MMS

3 New E-mail Account

Messenger

Notes

Opera Browser

Phone

PicSel Viewer

Pictures & Videos

Search

SIM Manager

(SIM Toolkit)

Tasks

Teleport

TIPtalk

(SIM Toolkit)

~~Windows Live Messenger~~

Windows Live

Windows Media

~~Windows Update~~

Settings

<Personal>tab

Buttons

Fingerprint

Input

Lock

Menus

Owner Information

Phone

Sounds & Notifications

Today

Video call

<System>tab

About

Backlight

Certificates

Clock & Alarm

Customer Feedback

Encryption

Error Reporting

External GPS

Master Clear

Memory

Power

Regional Settings

Remove Program

Screen

Windows Update

<Connections>tab

Beam

Bluetooth

Connections

SIM Lock

USB mass storage

USB to PC

Wi-Fi

Wireless Manager

Zoom

