

# **BTM-D1A Monitoring Ear Thermometer**

## **Product Instruction Manual**

# 1. Introduction of BTM-D1A - Ear Thermometer

## Key Pads & Functions

### (1) The Receiver

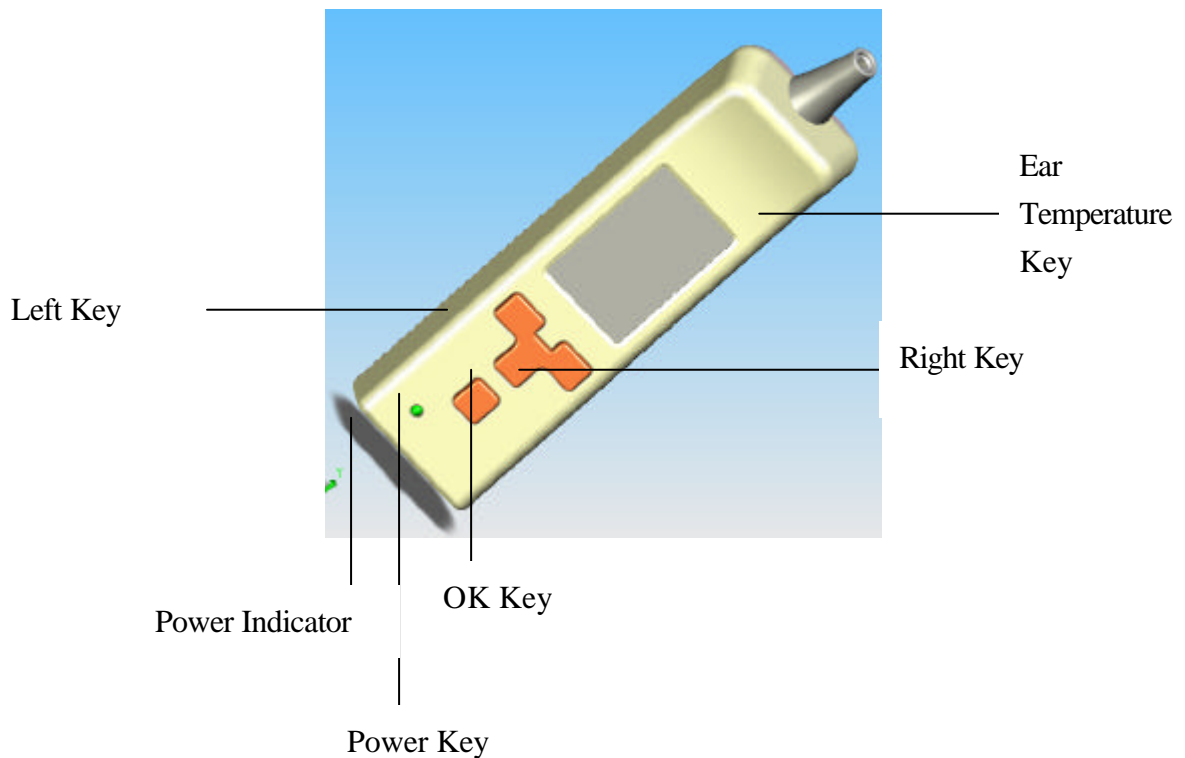

The instruction of the Keys and the Power Indicator:

Ear Temperature Key: for the use of the ear temperature measuring

Ok Key, Left Key, and right Key: for the use of the high/low temperature alarm setting

Power Key: for the use of the lasting armpit temperature measuring

Power Indicator: for the use of the easy identification of the Receiver at dark

Note: This product is designed without a protective covering on the Ear Monitor. Clean with alcohol after each use.

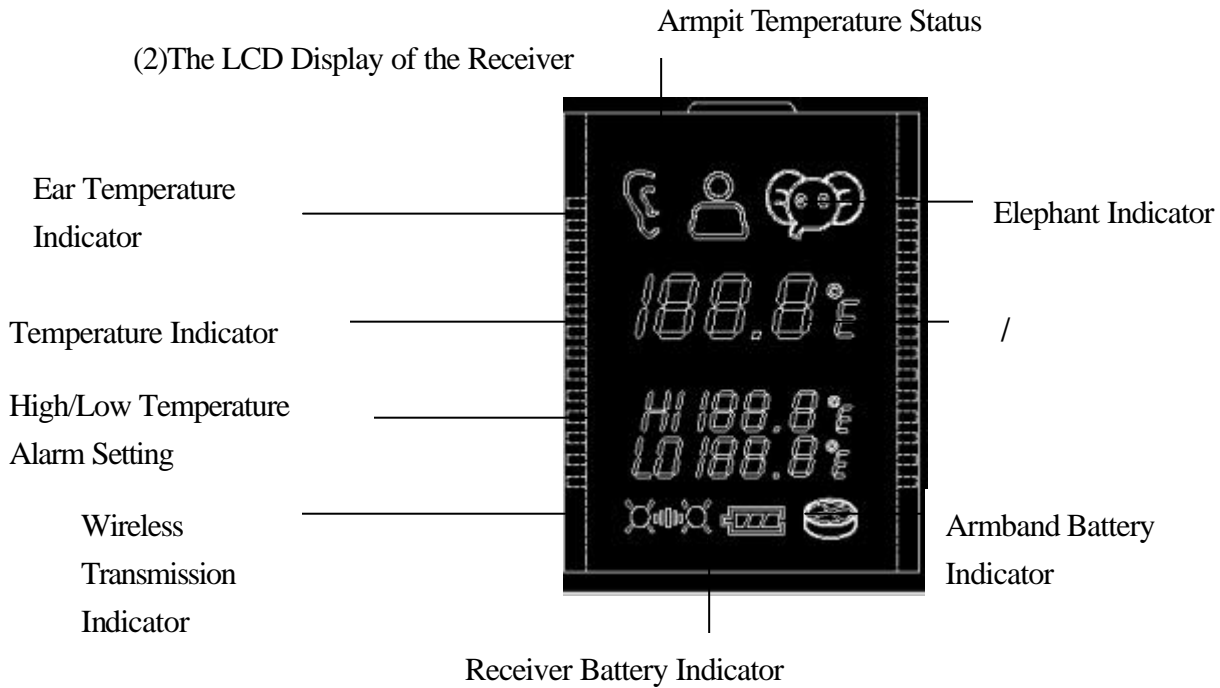

(3) The Armband

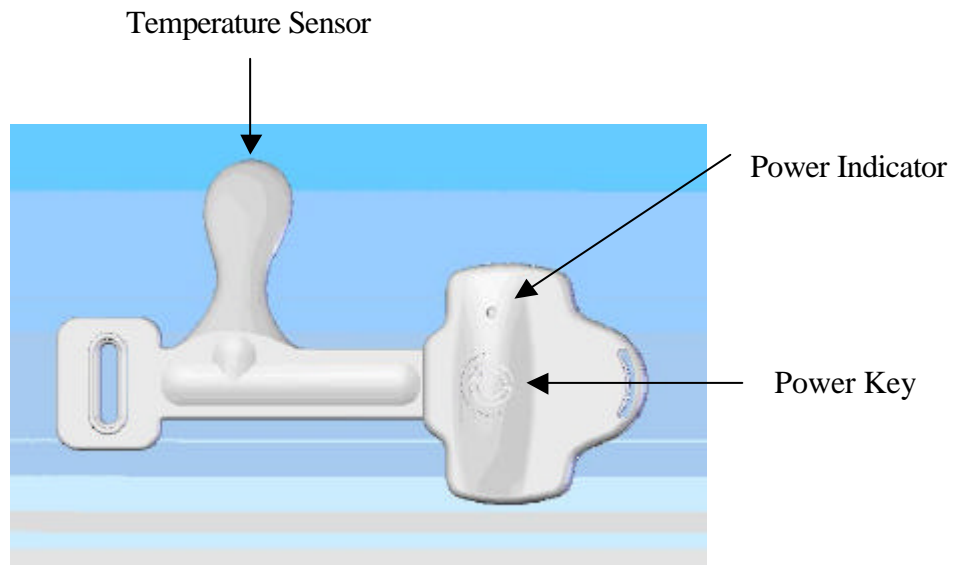

Battery Installation:

Using a coin or screw-driver, turn counter-clockwise to open the battery cover. To close the cover turn clockwise.

Note: This product is made of a silicone gel. Clean the product surface of the Armband using water and a tissue. Do not immerse Armband into water.

## 2. Operating Instructions

### (1) Ear Temperature Measuring:

Step 1. Press "Ear Temperature Key" for 2 seconds until the "Elephant Indicator" and the "Ear Temperature Indicator" begin to flash.

Step 2. When the "Elephant Indicator" stops flashing it has a full power supply. Then, insert the Ear Monitor into the ear of the patient. Press and hold the "Ear Temperature Key" until it beeps once, and then record the ear temperature of the patient which is displayed on the screen.

Step 3. The Receiver will turn off automatically after 15 seconds.

Notes: The Receiver will turn off automatically in 30 seconds without any operation.

### (2) Armpit Temperature Measuring:

#### ① Armpit Temperature Measuring:

Step 1. Press the "Power Key" for 2 seconds until the green light flashes every 4 seconds.

Step 2. Repeat Step 1. The display will show armpit temperature. It also indicates that the wireless transmission is operating.

Step 3. Place Temperature Sensor "face up" and fasten the Armband securely to upper-arm, near the armpit.

Step 4. Record the patient's temperature. Allow 3 to 5 minutes to accurately assess temperature stability. The Display will show the current temperature readings every 12 seconds allowing the operator to accurately determine the average temperature of the patient.

Step 5. To turn the Receiver off, press the "Power Key" for two seconds and wait for one "beep" to turn off Receiver Display screen. Remove Armband from patient's arm and press the "Power Key" and wait until the red light blinks once to indicate that the Armband is turned off.

#### ② Temperature Alarm Setting:

The operator can set both high and low temperature alarm signals. When applicable, the Receiver will exhibit a series of "Beeps" alerting the operator to take appropriate action. The

alarm setting procedures are as follows:

Step1. High temperature setting: Press the “OK Key” for 2 seconds then the Receiver Beeps twice to get into the temperature alarm setting mode. The Display shows “HI” and the Default figures flashing on it.

Step2. Press “Right Key” or “Left Key” to adjust the alarm temperature setting. The temperature is adjusted by 0.5 (or 1 ) a time such as 38.5,39,39.5 and so on, then press “OK Key” to finish setting.

Step3. Low temperature setting: Repeat Step1, press the “OK Key,” when the “HI” and the Default figures flashing on it, to get into the “LO” and the Default figures flashing on the Display.

Step4. Press “Right Key” or “Left Key” to adjust the alarm temperature setting (see Step 2).

Note:

- ◆The Default : The Default figures of the temperature alarm setting are HI :38 and LO :34 ( or HI : 100 and LO : 93 ) and the Receiver will take these figures as the Temperature Alarm Setting without any change in advance. The high temperature alarm ranges from 32 to 42 ( or 96 to 104 ); the low temperature alarm ranges from 32 to 34.5 ( or 89 to 96 ).
- ◆Unintentionally Pressing function : The receiver will return to the temperature monitoring mode and without change any setting if the operations mentioned above are not finished within 10 seconds.
- ◆Priority Alarm processing : The product is designed to process the alarm situation prior to the temperature alarm setting model, or any other operations. Without saving any setting if not pressing the “OK Key.” the operator is better off to operate temperature alarm setting with the full power supply.
- ◆Please re-set the High/Low temperature alarm setting after replacing the batteries, or the Receiver will get the default as the temperature alarm setting.

③ Check the High/Low temperature alarm setting:

The figures of “HI” and “LO” on the LCD Display show the setting of the High/Low temperature alarm set by the operator.

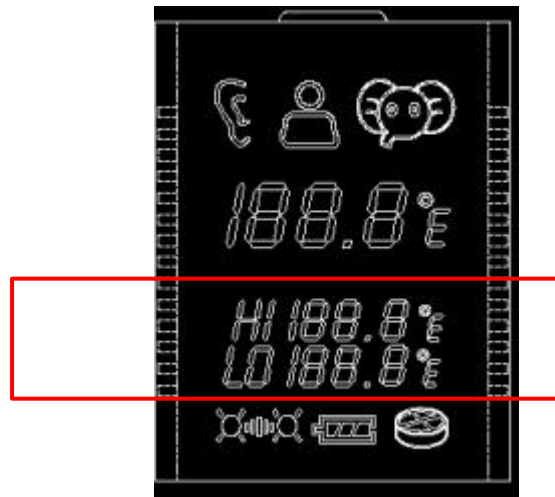

#### ④ Abnormal Temperature Alarm:

◆ **Alarm** : The High/Low Temperature Alarm Setting of the Display will be flashing on the “HI” and “LO” and their related figures when the temperature of a patient out of the temperature alarm setting. That is, the “HI” and the figures are flashing and vice versa. The Receiver will “Beep, Beep, Beep, Beep” every 2 seconds to inform the operator to take adequate actions.

◆ **Lasting alarm** : The Receiver will check every 10 minutes the temperature of a patient if or not out of the temperature alarm setting. The Receiver will keep noticing the operator to take adequate actions via the lasting Beeps if out of the temperature alarm setting. Press any key on the Receiver to stop Beep alarm.

Note :

1. In case that the original temperature of the Receiver lowers the low temperature alarm setting then starts the alarm system, this product, when power on, will trigger the low temperature alarm system after the normal temperature higher than that of the low temperature alarm setting by 0.5 .
2. It may cause low temperature alarm when the Armband got off. Please check immediately the patient and take adequate setting to the armband.

### 3. The Instructions of Indicators

#### Armband Power Indicator

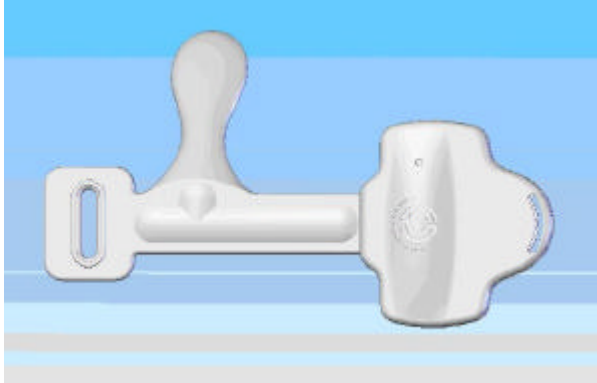

Light	Status	Flashing
Green	Normal	4 seconds each
Orange	Low Volt	4 seconds each
Red	Power Off	One blink then power off

#### Low Battery Alarm

(1) Receiver Battery Indicator:

Power Supply Status	Receiver Battery Indicator	Alarm sounds
Full power supply	Full battery	No sounds
Low power supply	Flashing on the Indicator	Beep twice /10 seconds

(2) Armband Battery Indicator:

Power Supply Status	Armband Battery Indicator	Alarm sounds
Full power supply	Full battery	No sounds
Low power supply	Flashing on the Indicator	Beep twice /10 seconds

**Poor Signal Warning**

1. The Temperature Indicator shows “- - - ” on the LCD Display of the Receiver when failed to receive the signal from the Armband after turning on the Receiver and then it will Beep twice per 10 seconds. Please reset the Receiver to start receiving the signal from the Armband.

Status	Temperature Indicator	Alarm sounds
Poor signal	- - -	Beep twice /10 seconds

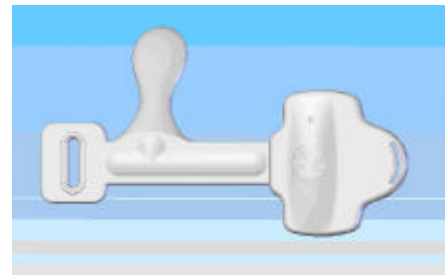
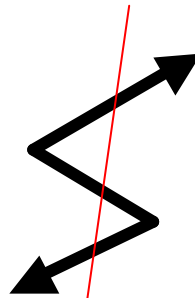

“Beep, Beep” “Beep, Beep” “Beep, Beep” “Beep, Beep”.....

PS. The LCD Display shows “- - - ” on it when Beeping.

**2. Poor Signal Trouble Shooting :**

Please move the Receiver more closed to the Armband then wait for the LCD Display of the Receiver shows that the signal from the Armband is received. If the poor signal status still exists, please reset both the Receiver and the Armband.



## 4. Importance Precautions

1. This product is designed to function properly under the conditions of the surrounding temperature between 15 to 40 °C, and the relative humidity of 95% and lower. Please do not use this product when temperature and humidity is out of the ranges above.
2. The transmission distance of this product can be reached to 30 meters without any obstacle.
3. In case to interfere the precision medical facilities in the hospital, please do not use this product in it.
4. Please follow the manual to carefully operate this product.
5. The main function of this product is to alert the care-taker when the patient under the abnormal temperature. The measurement, however, can sometimes be influenced by the surrounding temperature. ONLY do the readings of this product are for reference, and the medical attention from a qualified physician should be still sought for actual diagnosis.
6. Please pay much attention on the child with using this product. Please also keep out of reach of children and place it on a higher position.

Notice before using :

1. Keep out of using this product after exercising, bathing, having meals, and taking walk within 30 minutes.
2. Make sure the sweat under the armpit of a child is wiped before using this product, especially for the children with sweaty.

## 5. Specifications

Receiver		Armband	
Power supply	Two A4 batteries and up to 80-100 hours of lasting operation	Power supply	One 3Volt lithium button type (CR2032) and up to 72-96 hours of lasting operation
Dimensions ( mm )	156H*42W*39D	Dimensions ( mm )	136H*85W*9.5D
Weight	88g	Weight	25g
Operating temperature	15~40		

Temperature transmission frequency	Every 12 seconds
Valid temperature alarm ranges	HI : 35-42 (96-104 ) LO : 32-34.5 (89-96 )
Transmission frequency	2.4 Ghz
Radio modulation technique	FSK
Transmission distance	20 meters
Armpit temperature precision	±0.1
Ear temperature precision	±0.2

Notice : The changes or modifications not expressly approved by the party Responsible for compliance could void the user' s authority to operate the equipment.

IMPORTANT NOTE: To comply with the FCC RF exposure compliance requirements, no change to the antenna or the device is permitted. Any change to the antenna or the device could result in the device exceeding the RF exposure requirements and void user' s authority to operate the device.

This device complies with Part 15 of the FCC Rules. Operation is subject to the following two conditions: (1) this device may not cause harmful interference, and (2) this device must accept any interference received, including interference that may cause undesired operation.

**General Agent :RIO FLEXON TECHNOLOGY CO., LTD**

15 Fl, No 868-2 Chung-Cheng Rd, Chung Ho, Taipei County

0800 Customer Direct Line : 0800-800306

Fax Number : 02-82218198

E-mail:service@rio-flexon.com.tw

<http://www.rio-flexon.com.tw>

Attached behind the warranty card