



## MEASUREMENT REPORT

### FCC Part 15B

---

**FCC ID:** SFK-WF1801  
**APPLICANT:** CIG Shanghai Co., Ltd.  
**Application Type:** Certification  
**Product:** 2x2 dual band 802.11ac indoor AP  
**Model No.:** WF-180  
**FCC Classification:** FCC Class B Digital Device (JBP)  
**FCC Rule Part(s):** FCC Part 15 Subpart B  
**Test Procedure(s):** ANSI C63.4: 2014  
**Test Date:** November 19 ~ 21, 2014

Reviewed By : Robin Wu  
( Robin Wu )  
Approved By : Marlin Chen  
( Marlin Chen )



The test results relate only to the samples tested.

This equipment has been shown to be capable of compliance with the applicable technical standards as indicated in the measurement report and was tested in accordance with the measurement procedures specified in ANSI C63.4-2014. Test results reported herein relate only to the item(s) tested.

The test report shall not be reproduced except in full without the written approval of MRT Technology (Suzhou) Co., Ltd.

---

### Revision History

Report No.	Version	Description	Issue Date
1507RSU00103	Rev. 01	Initial report	07-20-2015

---

## CONTENTS

Description	Page
<b>§2.1033 General Information .....</b>	<b>4</b>
<b>1. INTRODUCTION .....</b>	<b>5</b>
1.1. Scope .....	5
1.2. MRT Test Location .....	5
<b>2. PRODUCT INFORMATION .....</b>	<b>6</b>
2.1. Equipment Description.....	6
2.2. Description of Available Antennas .....	7
2.3. Device Capabilities .....	7
2.4. Test Configuration .....	8
2.5. Test Software .....	8
2.6. EMI Suppression Device(s)/Modifications .....	8
2.7. Labeling Requirements.....	9
<b>3. DESCRIPTION OF TEST .....</b>	<b>10</b>
3.1. Evaluation Procedure .....	10
3.2. AC Line Conducted Emissions .....	10
3.3. Radiated Emissions.....	11
<b>4. TEST EQUIPMENT CALIBRATION DATE .....</b>	<b>12</b>
<b>5. MEASUREMENT UNCERTAINTY.....</b>	<b>13</b>
<b>6. TEST RESULT .....</b>	<b>14</b>
6.1. Summary .....	14
6.2. Conducted Emission Measurement .....	15
6.2.1. Test Limit .....	15
6.2.2. Test Setup.....	15
6.2.3. Test Result of Conducted Emissions.....	16
6.3. Radiated Emission Measurement .....	18
6.3.1. Test Limit .....	18
6.3.2. Test Setup.....	18
6.3.3. Test Result of Radiated Emissions.....	20
<b>7. CONCLUSION.....</b>	<b>24</b>

## §2.1033 General Information

<b>Applicant:</b>	CIG Shanghai Co., Ltd.
<b>Applicant Address:</b>	F/5, 8 Building No.2388 Chenhang Road, Minhang District, Shanghai
<b>Manufacturer:</b>	CIG Shanghai Co., Ltd.
<b>Manufacturer Address:</b>	F/5, 8 Building No.2388 Chenhang Road, Minhang District, Shanghai
<b>Test Site:</b>	MRT Technology (Suzhou) Co., Ltd
<b>Test Site Address:</b>	D8 Building, Youxin Industrial Park, No.2 Tian'edang Rd., Wuzhong Economic Development Zone, Suzhou, China
<b>MRT FCC Registration No.:</b>	809388
<b>Model No.:</b>	WF-180
<b>FCC ID:</b>	SFK-WF1801
<b>Test Device Serial No.:</b>	N/A <input type="checkbox"/> Production <input checked="" type="checkbox"/> Pre-Production <input type="checkbox"/> Engineering
<b>FCC Classification:</b>	FCC Class B Digital Device (JBP)

### Test Facility / Accreditations

Measurements were performed at MRT Laboratory located in Tian'edang Rd., Suzhou, China.

- MRT facility is a FCC registered (MRT Reg. No. 809388) test facility with the site description report on file and has met all the requirements specified in Section 2.948 of the FCC Rules.
- MRT facility is an IC registered (MRT Reg. No. 11384A-1) test laboratory with the site description on file at Industry Canada.
- MRT facility is a VCCI registered (R-4179, G-814, C-4664, T-2206) test laboratory with the site description on file at VCCI Council.
- MRT Lab is accredited to ISO 17025 by the American Association for Laboratory Accreditation (A2LA) under the American Association for Laboratory Accreditation Program (A2LA Cert. No. 3628.01) in EMC, Telecommunications and Radio testing for FCC, Industry Canada, EU and TELEC Rules.



# 1. INTRODUCTION

## 1.1. Scope

Measurement and determination of electromagnetic emissions (EMC) of radio frequency devices including intentional and/or unintentional radiators for compliance with the technical rules and regulations of the Federal Communications Commission and the Industry Canada Certification and Engineering Bureau.

## 1.2. MRT Test Location

The map below shows the location of the MRT LABORATORY, its proximity to the Taihu Lake. These measurement tests were conducted at the MRT Technology (Suzhou) Co., Ltd. Facility located at D8 Building, Youxin Industrial Park, No.2 Tian'edang Rd., Wuzhong Economic Development Zone, Suzhou, China. The detailed description of the measurement facility was found to be in compliance with the requirements of § 2.948 according to ANSI C63.4-2014 on September 30, 2013.



## 2. PRODUCT INFORMATION

### 2.1. Equipment Description

Product Name	2x2 dual band 802.11ac indoor AP
Model No.	WF-180
Frequency Range	<p><b><u>For 2.4GHz Band:</u></b>        802.11b/g/n:        2412 ~ 2462 MHz</p> <p><b><u>For 5.0GHz Band:</u></b>        For 802.11a/n-HT20/ac-VHT20:        5180~5240MHz, 5745~5825MHz        For 802.11n-HT40/ac-VHT40:        5190~5230MHz, 5755~5795MHz        For 802.11ac-VHT80:        5210MHz, 5775MHz</p>
Type of Modulation	802.11b: DSSS 802.11g/a/n/ac: OFDM
Adapter	M/N: RD1201000-C5-HOG P/N: JQ-HOG2-1210-21R5 Input: 100-240V ~ 50/60Hz 0.6A MAX OUTPUT: 12Vdc, 1A

## 2.2. Description of Available Antennas

Antenna Type	Frequency Band (GHz)	Tx Paths	Max Peak Gain (dBi)	Beam Forming Directional Gain (dBi)	CDD Directional Gain (dBi)	
					For Power	For PSD
PCB Antenna	2.4	2	3	6	3	6
	5	2	3	6	3	6

Note:

1. Transmit at 2.4GHz & 5GHz support two antennas.
2. The EUT supports Beam Forming mode & CDD Mode.

## 2.3. Device Capabilities

This device contains the following capabilities:

2.4GHz & 5GHz (DTS/UNII)

## 2.4. Test Configuration

The 2x2 dual band 802.11ac indoor AP FCC ID: SFK-WF1801 was tested per the guidance FCC Part 15 Subpart B: 2013 and ANSI C63.4: 2014 was used to reference the appropriate EUT setup for radiated spurious emissions testing and AC line conducted testing.

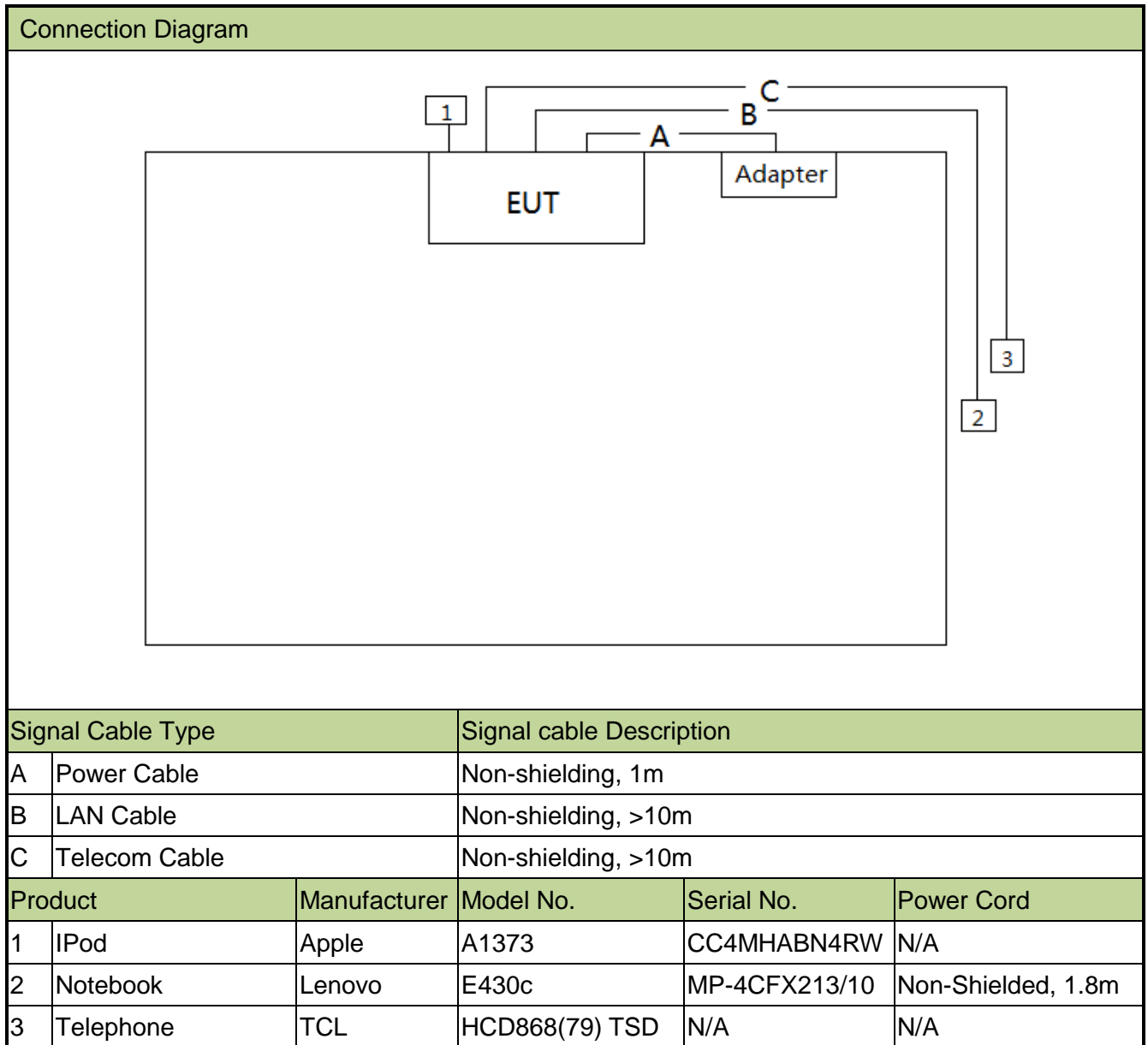

## 2.5. Test Software

Not applicable.

## 2.6. EMI Suppression Device(s)/Modifications

No EMI suppression device(s) were added and/or no modifications were made during testing.



## **2.7. Labeling Requirements**

Per 2.1074 & 15.19; Docket 95-19

The label shall be permanently affixed at a conspicuous location on the device; instruction manual or pamphlet supplied to the user and be readily visible to the purchaser at the time of purchase.

However, when the device is so small wherein placement of the label with specified statement is not practical, only the trade name and FCC ID must be displayed on the device per Section 15.19(a)(5).

Please see attachment for FCC ID label and label location.

### 3. DESCRIPTION OF TEST

#### 3.1. Evaluation Procedure

The measurement procedures described in the American National Standard for Methods of Measurement of Radio-Noise Emission from Low-Voltage Electrical Equipment in the Range of 9kHz to 40GHz (ANSI C63.4-2014) was used in the measurement of the **2x2 dual band 802.11ac indoor AP FCC ID: SFK-WF1801**.

**Deviation from measurement procedure.....None**

#### 3.2. AC Line Conducted Emissions

The line-conducted facility is located inside an 8'x4'x4' shielded enclosure. A 1m x 2m wooden table 80cm high is placed 40cm away from the vertical wall and 80cm away from the sidewall of the shielded room. Two 10kHz-30MHz, 50Ω/50uH Line-Impedance Stabilization Networks (LISNs) are bonded to the shielded room floor. Power to the LISNs is filtered by external high-current high-insertion loss power line filters. These filters attenuate ambient signal noise from entering the measurement lines. These filters are also bonded to the shielded enclosure.

The EUT is powered from one LISN and the support equipment is powered from the second LISN. If the EUT is a DC-powered device, power will be derived from the source power supply it normally will be powered from and this supply line(s) will be connected to the second LISN. All interconnecting cables more than 1 meter were shortened to a 1 meter length by non-inductive bundling (serpentine fashion) and draped over the back edge of the test table. All cables were at least 40cm above the horizontal reference ground-plane. Power cables for support equipment were routed down to the second LISN while ensuring that that cables were not draped over the second LISN.

Sufficient time for the EUT, support equipment, and test equipment was allowed in order for them to warm up to their normal operating condition. The RF output of the LISN was connected to the receiver and exploratory measurements were made to determine the frequencies producing the maximum emission from the EUT. The receiver was scanned from 150 kHz to 30 MHz. The detector function was set to peak mode for exploratory measurements while the bandwidth of the analyzer was set to 9 kHz. The EUT, support equipment, and interconnecting cables were arranged and manipulated to maximize each emission. Each emission was also maximized by varying: power lines, the mode of operation or resolution, clock or data exchange speed, scrolling H pattern to the EUT and/or support equipment whichever determined the worst-case emission. Once the worst case emissions have been identified, the one EUT cable configuration/arrangement and mode of operation that produced these emissions are used for final measurements on the same test site. Line conducted emissions test results are shown in Section 6.2.

### 3.3. Radiated Emissions

The radiated test facilities consisted of an indoor 3 meter semi-anechoic chamber used for final measurements and exploratory measurements, when necessary. The measurement area is contained within the semi-anechoic chamber which is shielded from any ambient interference. For measurements above 1GHz absorbers are arranged on the floor between the turn table and the antenna mast in such a way so as to maximize the reduction of reflections. For measurements below 1GHz, the absorbers are removed. An MF Model 210SS turntable is used for radiated measurement. It is a continuously rotatable, remote controlled, metallic turntable and 2 meters (6.56 ft.) in diameter. The turn table is flush with the raised floor of the chamber in order to maintain its function as a ground plane. An 80cm high PVC support structure is placed on top of the turntable.

For all measurements, the spectrum was scanned through all EUT azimuths and from 1 to 4 meter receive antenna height using a broadband antenna from 30 MHz up to the upper frequency shown in 15.33(b)(1) depending on the highest frequency generated or used in the device or on which the device operates or tunes. For frequencies above 1GHz, linearly polarized double ridge horn antennas were used. For frequencies below 30 MHz, a calibrated loop antenna was used. When exploratory measurements were necessary, they were performed at 1 meter test distance inside the semi-anechoic chamber using broadband antennas, broadband amplifiers, and spectrum analyzers to determine the frequencies and modes producing the maximum emissions. Sufficient time for the EUT, support equipment, and test equipment was allowed in order for them to warm up to their normal operating condition. The test set-up was placed on top of the 0.8 meter high, 1 x 1.5 meter table. The EUT, support equipment, and interconnecting cables were arranged and manipulated to maximize each emission. Appropriate precaution was taken to ensure that all emissions from the EUT were maximized and investigated. The system configuration, mode of operation, if applicable, turntable azimuth, and receive antenna height was noted for each frequency found.

Final measurements were made in the semi-anechoic chamber using calibrated, linearly polarized broadband and horn antennas. The test setup was configured to the setup that produced the worst case emissions. The spectrum analyzer was set to investigate all frequencies required for testing to compare the highest radiated disturbances with respect to the specified limits. The turntable containing the EUT was rotated through 360 degrees and the height of the receive antenna was varied 1 to 4 meters and stopped at the azimuth and height producing the maximum emission. Each emission was maximized by changing the orientation of the EUT through three orthogonal planes and changing the polarity of the receive antenna, whichever produced the worst-case emissions. According to 3dB beam-width of horn antenna, the horn antenna should be always directed to the EUT when rising height.

#### 4. TEST EQUIPMENT CALIBRATION DATE

##### Conducted Emissions

Instrument	Manufacturer	Type No.	Serial No.	Cali. Interval	Cali. Due Date
EMI Test Receiver	R&S	ESR7	101209	1 year	2015/11/08
Two-Line V-Network	R&S	ENV216	101683	1 year	2015/11/08
Two-Line V-Network	R&S	ENV216	101684	1 year	2015/11/08
Temperature/ Meter Humidity	Anymetre	TH101B	SR2-01	1 year	2015/11/15

##### Radiated Emission

Instrument	Manufacturer	Type No.	Serial No.	Cali. Interval	Cali. Due Date
Spectrum Analyzer	Agilent	E4447A	MY45300136	1 year	2015/11/18
EMI Test Receiver	R&S	ESR7	101209	1 year	2015/11/08
Preamplifier	Agilent	83017A	MRTSUE06020	1 year	2015/12/13
Loop Antenna	Schwarzbeck	FMZB1519	1519-041	1 year	2015/11/08
TRILOG Antenna	Schwarzbeck	VULB9162	9162-047	1 year	2015/11/08
Broad-Band Horn Antenna	Schwarzbeck	BBHA9120D	9120D-1167	1 year	2015/11/08
Broadband Horn Antenna	Schwarzbeck	BBHA9170	9170-549	1 year	2014/12/11
Temperature/Humidity Meter	Anymetre	TH101B	AC1-01	1 year	2015/11/15

Software	Version	Function
e3	V8.3.5	EMI Test Software

## 5. MEASUREMENT UNCERTAINTY

Where relevant, the following test uncertainty levels have been estimated for tests performed on the EUT as specified in CISPR 16-4-2. This uncertainty represents an expanded uncertainty expressed at approximately the 95% confidence level using a coverage factor of  $k = 2$ .

AC Conducted Emission Measurement
Measuring Uncertainty for a Level of Confidence of 95% ( $U=2Uc(y)$ ): 150kHz~30MHz: 3.5dB
Radiated Emission Measurement
Measuring Uncertainty for a Level of Confidence of 95% ( $U=2Uc(y)$ ): Horizontal: 30MHz~1GHz: 4.07dB 1GHz~18GHz: 4.16 dB Vertical: 30MHz~1GHz: 4.18 dB 1GHz~18GHz: 4.76 dB

## 6. TEST RESULT

### 6.1. Summary

**Product Name:** 2x2 dual band 802.11ac indoor AP  
**FCC ID:** SFK-WF1801  
**FCC Classification:** FCC Class B Digital Device (JBP)  
**Test Mode:** Communication

FCC Part Section(s)	Test Description	Test Result
15.107	Conducted Emissions	Pass
15.109	Radiated Emissions	Pass

## 6.2. Conducted Emission Measurement

### 6.2.1. Test Limit

FCC Part 15.107 Limits		
Frequency (MHz)	QP (dB $\mu$ V)	AV (dB $\mu$ V)
0.15 - 0.50	66 - 56	56 - 46
0.50 - 5.0	56	46
5.0 - 30	60	50

Note 1: The lower limit shall apply at the transition frequencies.

Note 2: The limit decreases linearly with the logarithm of the frequency in the range 0.15MHz to 0.5MHz.

### 6.2.2. Test Setup

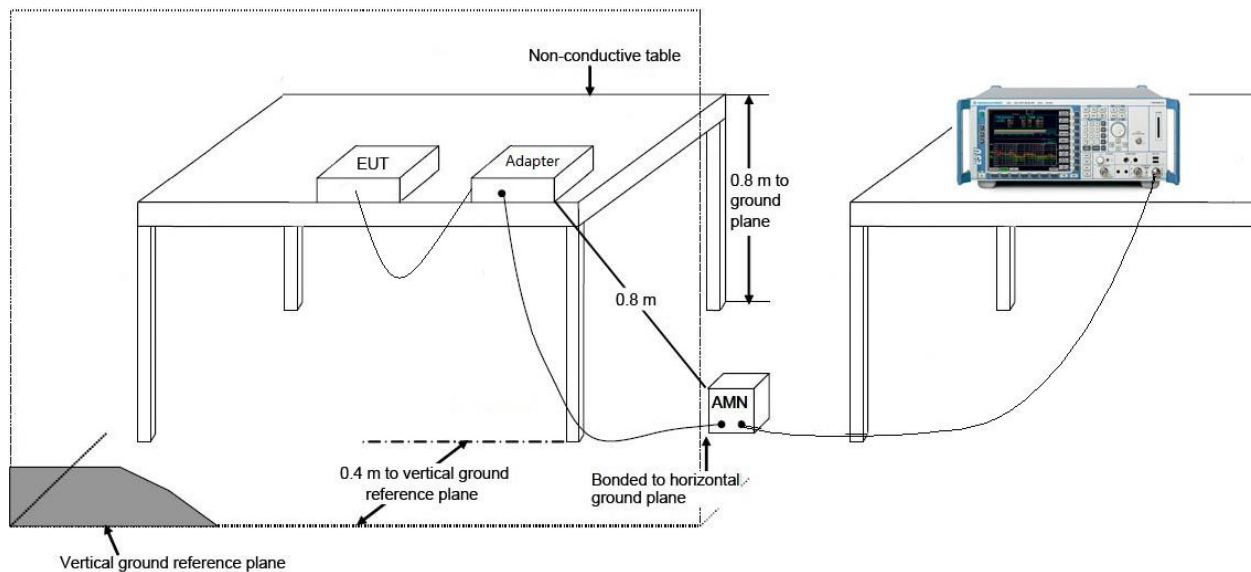

### 6.2.3. Test Result of Conducted Emissions

Site: SR2	Time: 2014/11/23 - 12:18
Limit: FCC_Part15.107_CE_ClassB	Engineer: Roy Cheng
Probe: ENV216_101683_Filter On	Polarity: Line
EUT: 2x2 dual band 802.11ac indoor AP	Power: AC 120V/60Hz
Test Mode: Communication With Notebook	

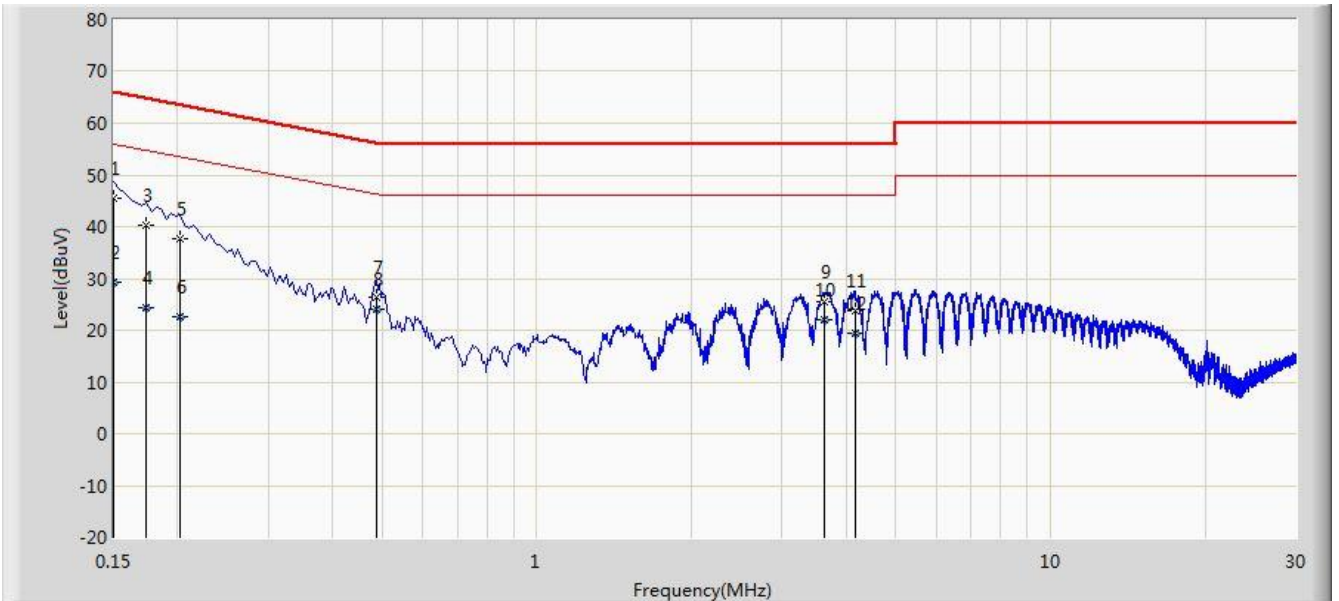

No	Flag	Mark	Frequency (MHz)	Measure Level (dBuV)	Reading Level (dBuV)	Over Limit (dB)	Limit (dBuV)	Factor (dB)	Type
1		*	0.150	45.510	34.342	-20.490	66.000	11.168	QP
2			0.150	29.213	18.045	-26.787	56.000	11.168	AV
3			0.174	40.333	30.265	-24.435	64.767	10.068	QP
4			0.174	24.470	14.402	-30.297	54.767	10.068	AV
5			0.202	37.558	27.566	-25.970	63.528	9.993	QP
6			0.202	22.490	12.498	-31.038	53.528	9.993	AV
7			0.486	26.333	16.178	-29.903	56.236	10.155	QP
8			0.486	24.075	13.920	-22.161	46.236	10.155	AV
9			3.618	25.492	15.571	-30.508	56.000	9.921	QP
10			3.618	21.922	12.002	-24.078	46.000	9.921	AV
11			4.162	23.776	13.802	-32.224	56.000	9.974	QP
12			4.162	19.379	9.405	-26.621	46.000	9.974	AV

Note: Measure Level (dBμV) = Reading Level (dBμV) + Factor (dB)

Factor (dB) = Cable Loss (dB) + LISN Factor (dB).



Site: SR2	Time: 2014/11/23 - 12:29
Limit: FCC_Part15.107_CE_ClassB	Engineer: Roy Cheng
Probe: ENV216_101683_Filter On	Polarity: Neutral
EUT: 2x2 dual band 802.11ac indoor AP	Power: AC 120V/60Hz
Test Mode: Communication With Notebook	

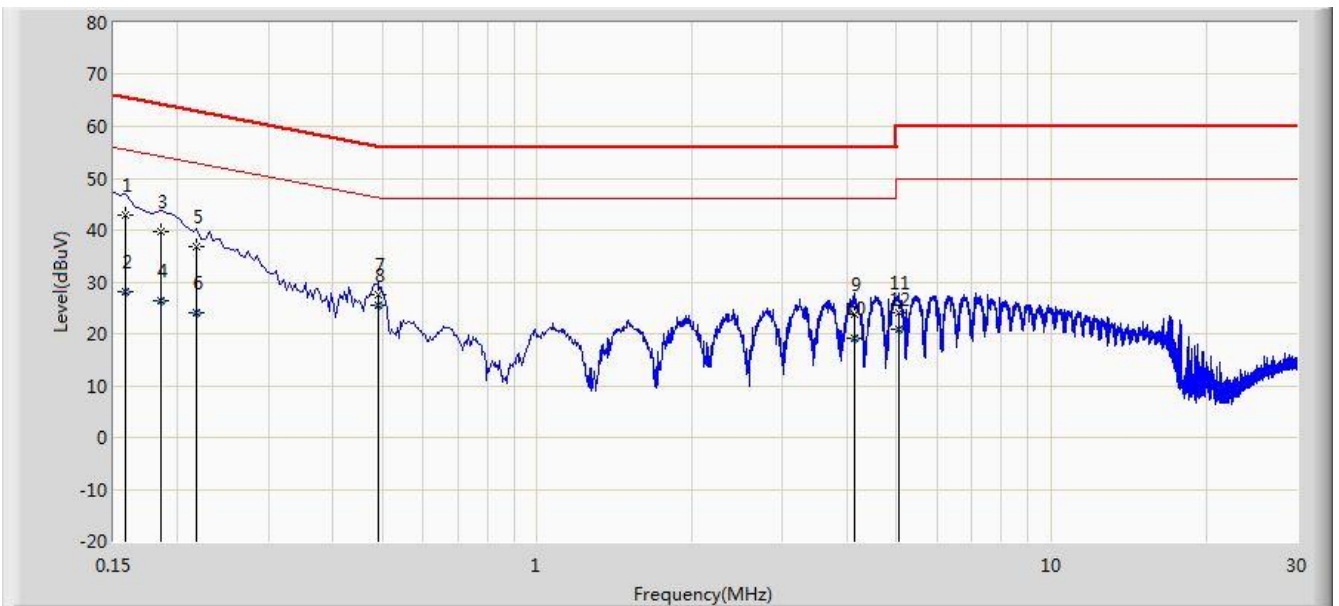

No	Flag	Mark	Frequency (MHz)	Measure Level (dBuV)	Reading Level (dBuV)	Over Limit (dB)	Limit (dBuV)	Factor (dB)	Type
1			0.158	42.932	32.643	-22.636	65.568	10.290	QP
2			0.158	28.155	17.865	-27.414	55.568	10.290	AV
3			0.186	39.762	29.727	-24.451	64.213	10.035	QP
4			0.186	26.357	16.322	-27.857	54.213	10.035	AV
5			0.218	36.754	26.773	-26.141	62.895	9.981	QP
6			0.218	24.046	14.065	-28.848	52.895	9.981	AV
7			0.490	27.605	17.426	-28.563	56.168	10.179	QP
8		*	0.490	25.630	15.451	-20.538	46.168	10.179	AV
9			4.134	23.790	13.810	-32.210	56.000	9.980	QP
10			4.134	19.253	9.273	-26.747	46.000	9.980	AV
11			5.038	24.164	14.117	-35.836	60.000	10.046	QP
12			5.038	20.781	10.735	-29.219	50.000	10.046	AV

Note: Measure Level (dBμV) = Reading Level (dBμV) + Factor (dB)

Factor (dB) = Cable Loss (dB) + LISN Factor (dB).

### 6.3. Radiated Emission Measurement

#### 6.3.1. Test Limit

FCC Part 15.109 Limits		
Frequency (MHz)	Distance (m)	Level (dB $\mu$ V/m)
30 - 88	3	40
88 - 216	3	43.5
216 - 960	3	46
Above 960	3	54

Note 1: The lower limit shall apply at the transition frequency.

Note 2: Distance refers to the distance in meters between the measuring instrument antenna and the closed point of any part of the device or system.

Note 3: E field strength (dB $\mu$ V/m) = 20 log E field strength (uV/m)

#### 6.3.2. Test Setup

30MHz ~ 1GHz Test Setup:

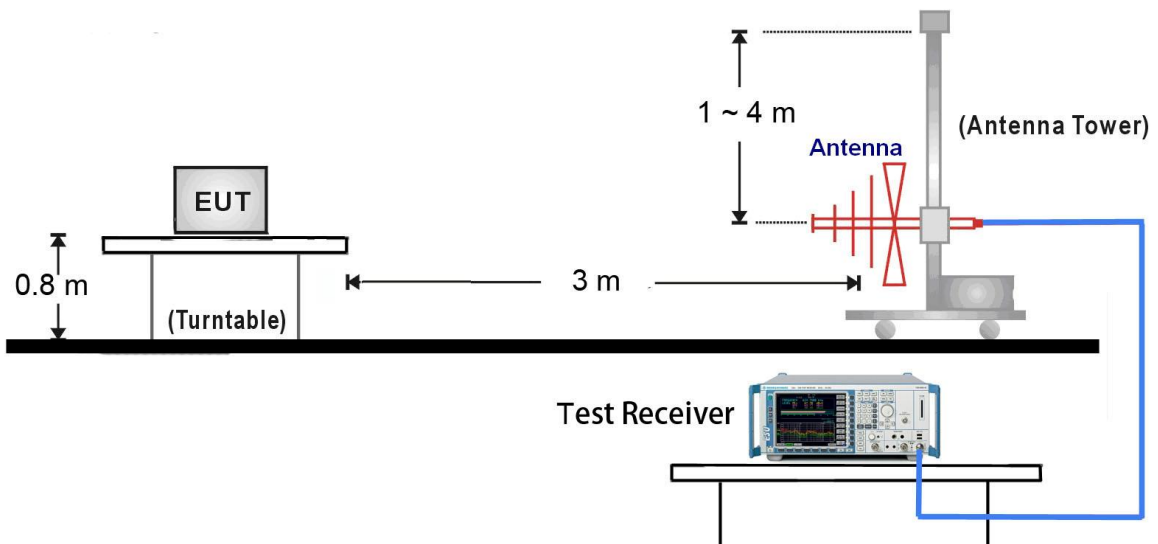

1GHz ~18GHz Test Setup:

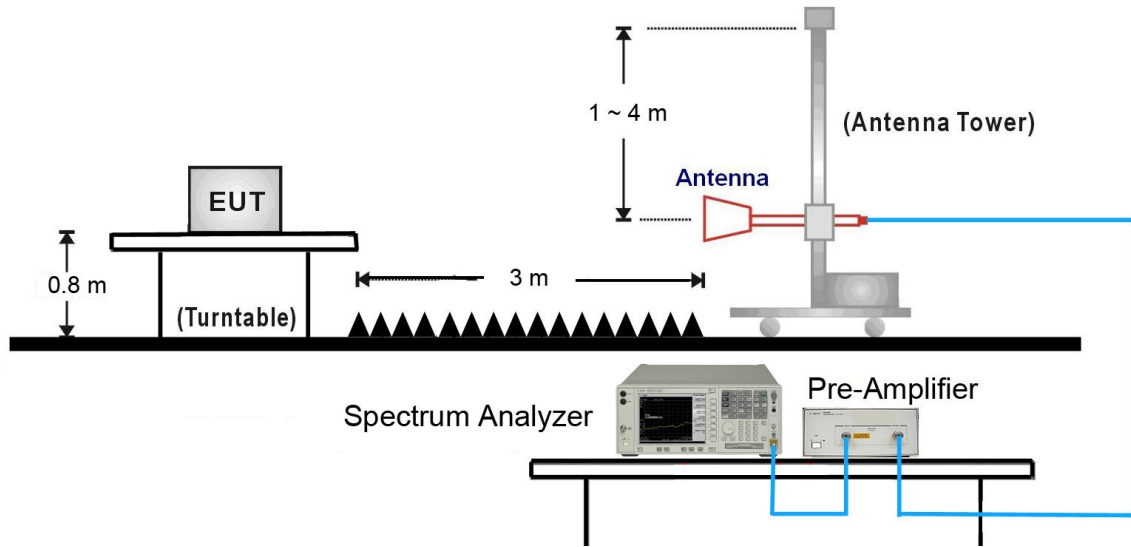

### 6.3.3. Test Result of Radiated Emissions

Site: AC1	Time: 2014/11/23 - 19:12
Limit: FCC_Part15.109_RE(3m)_Class B	Engineer: Milo Li
Probe: VULB9162_0.03-8GHz	Polarity: Horizontal
EUT: 2x2 dual band 802.11ac indoor AP	Power: AC 120V/60Hz
Test Mode: Communication With Notebook	

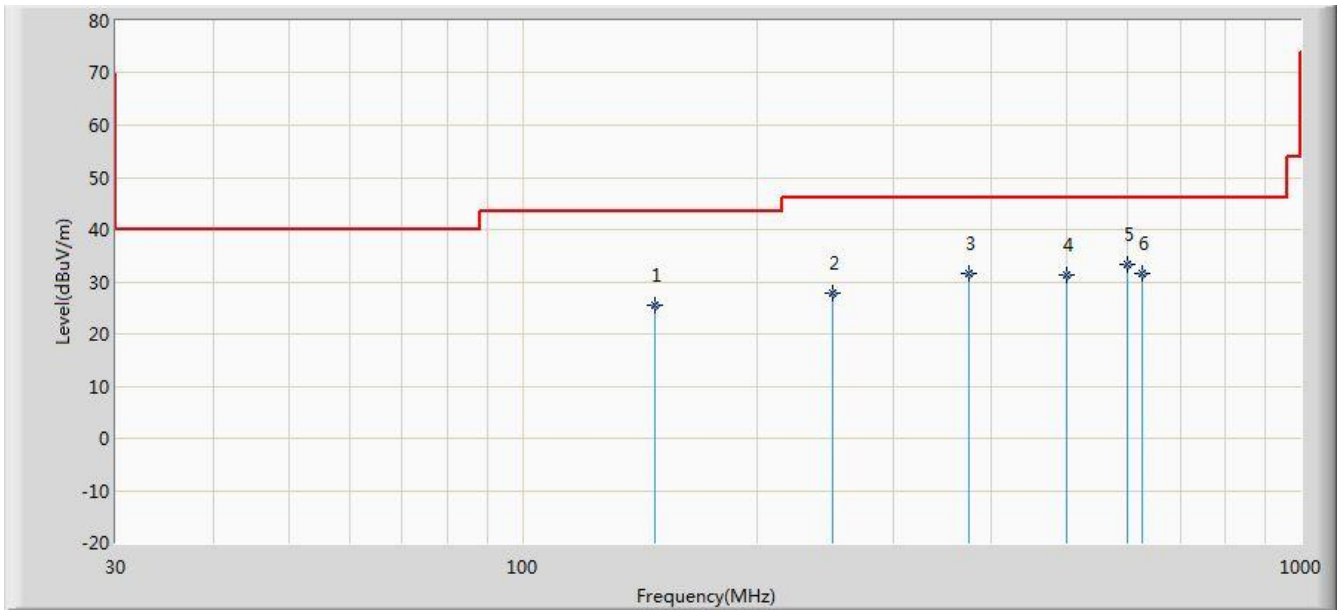

No	Flag	Mark	Frequency (MHz)	Measure Level (dBuV/m)	Reading Level (dBuV)	Over Limit (dB)	Limit (dBuV/m)	Factor (dB)	Type
1			148.154	25.511	11.850	-17.989	43.500	13.661	QP
2			250.190	27.879	14.790	-18.121	46.000	13.089	QP
3			374.904	31.470	14.570	-14.530	46.000	16.900	QP
4			499.985	31.332	11.940	-14.668	46.000	19.392	QP
5		*	599.875	33.219	12.400	-12.781	46.000	20.819	QP
6			625.134	31.583	10.520	-14.417	46.000	21.062	QP

Note: Measure Level (dBuV/m) = Reading Level (dBuV) + Factor (dB)

Factor (dB) = Cable Loss (dB) + Antenna Factor (dB/m).

Site: AC1	Time: 2014/11/23 - 19:12
Limit: FCC_Part15.109_RE(3m)_Class B	Engineer: Milo Li
Probe: VULB9162_0.03-8GHz	Polarity: Vertical
EUT: 2x2 dual band 802.11ac indoor AP	Power: AC 120V/60Hz
Test Mode: Communication With Notebook	

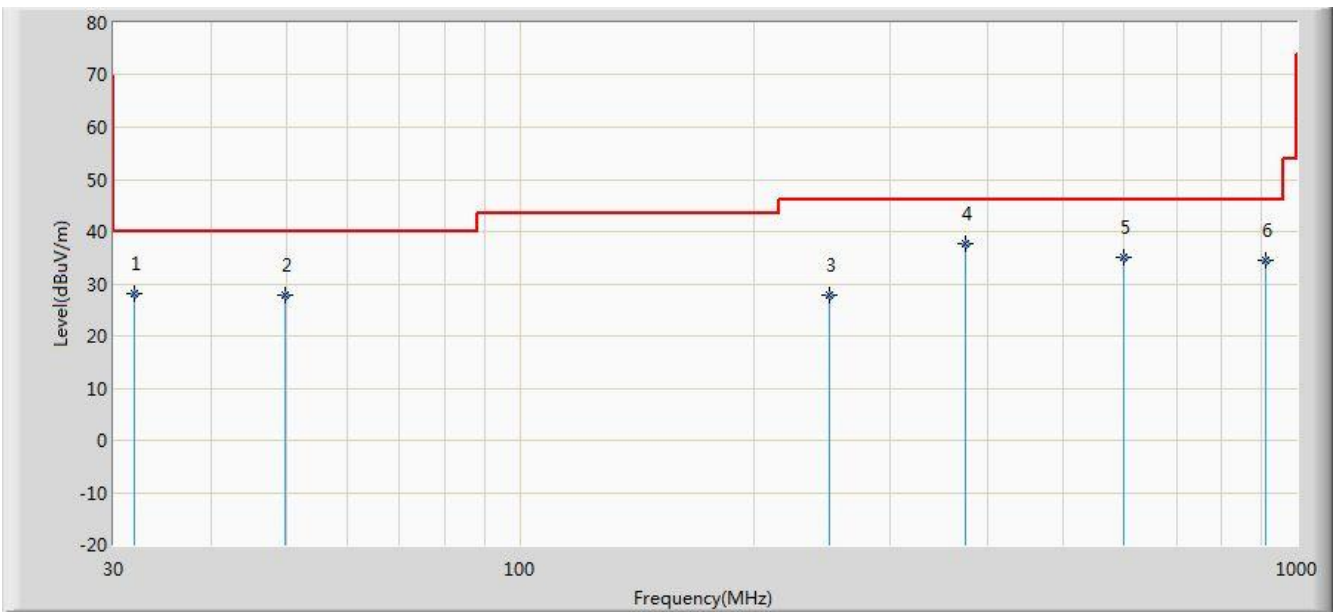

No	Flag	Mark	Frequency (MHz)	Measure Level (dBuV/m)	Reading Level (dBuV)	Over Limit (dB)	Limit (dBuV/m)	Factor (dB)	Type
1			31.940	28.042	8.640	-11.958	40.000	19.402	QP
2			49.889	27.792	19.630	-12.208	40.000	8.162	QP
3			250.190	27.925	14.620	-18.075	46.000	13.305	QP
4		*	374.864	37.626	20.830	-8.374	46.000	16.796	QP
5			599.942	34.979	14.570	-11.021	46.000	20.409	QP
6			911.724	34.432	10.140	-11.568	46.000	24.292	QP

Note: Measure Level (dB $\mu$ V/m) = Reading Level (dB $\mu$ V) + Factor (dB)

Factor (dB) = Cable Loss (dB) + Antenna Factor (dB/m).

Site: AC1	Time: 2014/11/23 - 20:38
Limit: FCC_Part15.109_RE(3m)_Class B	Engineer: Milo Li
Probe: BBHA9120D_1-18GHz	Polarity: Horizontal
EUT: 2x2 dual band 802.11ac indoor AP	Power: AC 120V/60Hz
Test Mode: Communication With Notebook	

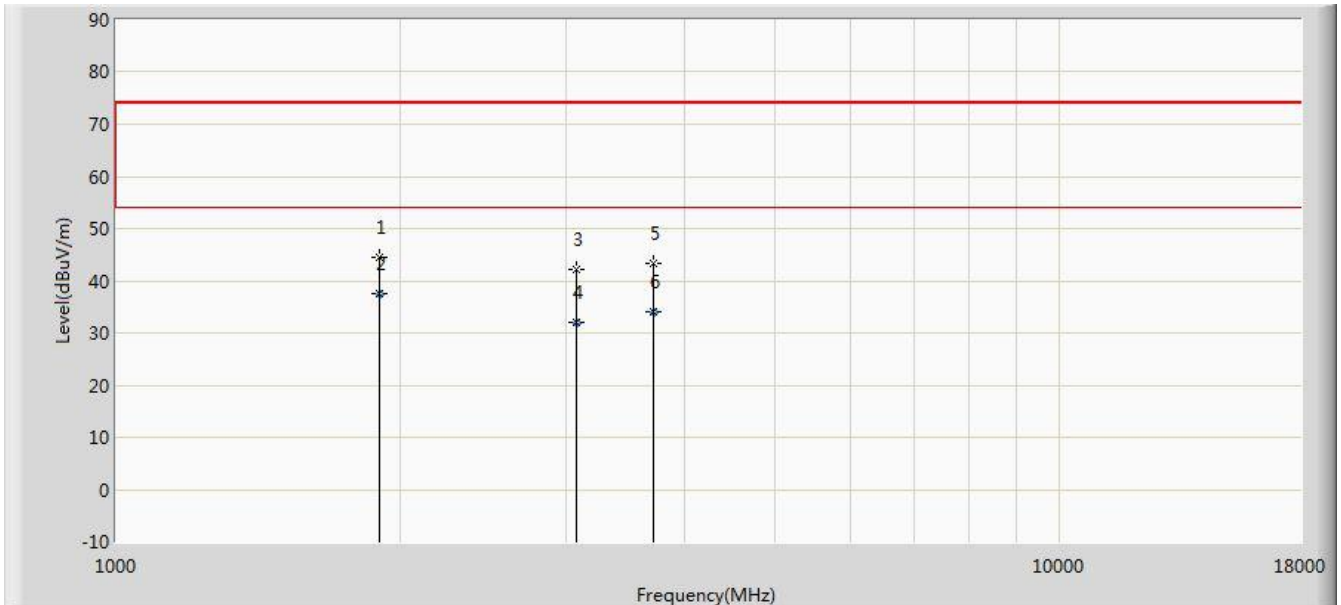

No	Flag	Mark	Frequency (MHz)	Measure Level (dBuV/m)	Reading Level (dBuV)	Over Limit (dB)	Limit (dBuV/m)	Factor (dB)	Type
1			1901.000	44.361	43.737	-29.639	74.000	0.624	PK
2		*	1901.025	37.500	36.875	-16.500	54.000	0.625	AV
3			3074.000	42.037	38.559	-31.963	74.000	3.478	PK
4			3074.020	32.029	28.551	-21.971	54.000	3.478	AV
5			3711.500	43.475	39.429	-30.525	74.000	4.046	PK
6			3711.532	33.978	29.932	-20.022	54.000	4.046	AV

Note: Measure Level (dB $\mu$ V/m) = Reading Level (dB $\mu$ V) + Factor (dB)

Factor (dB) = Cable Loss (dB) + Antenna Factor (dB/m) - Pre\_Amplifier Gain (dB).

Site: AC1	Time: 2014/11/23 - 20:38
Limit: FCC_Part15.109_RE(3m)_Class B	Engineer: Milo Li
Probe: BBHA9120D_1-18GHz	Polarity: Vertical
EUT: 2x2 dual band 802.11ac indoor AP	Power: AC 120V/60Hz
Test Mode: Communication With Notebook	

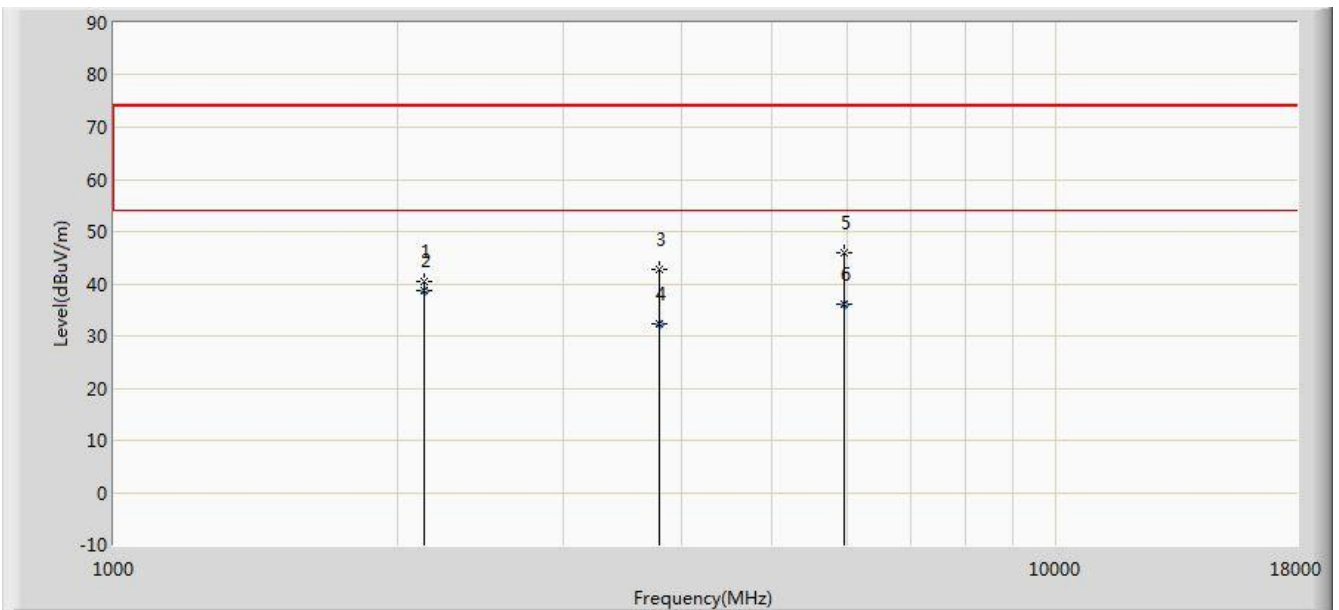

No	Flag	Mark	Frequency (MHz)	Measure Level (dBuV/m)	Reading Level (dBuV)	Over Limit (dB)	Limit (dBuV/m)	Factor (dB)	Type
1			2139.000	40.485	37.992	-33.515	74.000	2.493	PK
2		*	2139.250	38.750	36.254	-15.250	54.000	2.496	AV
3			3788.000	42.667	38.479	-31.333	74.000	4.188	PK
4			3788.054	32.332	28.144	-21.668	54.000	4.188	AV
5			5955.500	45.966	37.659	-28.034	74.000	8.308	PK
6			5955.623	36.055	27.747	-17.945	54.000	8.308	AV

Note: Measure Level (dBuV/m) = Reading Level (dBuV) + Factor (dB)

Factor (dB) = Cable Loss (dB) + Antenna Factor (dB/m) - Pre\_Amplifier Gain (dB).

## 7. CONCLUSION

The data collected relate only the item(s) tested and show that the **2x2 dual band 802.11ac indoor AP FCC ID: SFK-WF1801** has been tested to comply with the requirements specified in §15.107 and §15.109 of the FCC Rules.

\_\_\_\_\_ The End \_\_\_\_\_