



FCC DFS TEST REPORT

FCC ID : S9GT670SN
Equipment : T670sn Access Point
Brand Name : RUCKUS
Model Name : T670sn
Applicant : Ruckus Wireless LLC
350 W. Java Dr., Sunnyvale CA 94089 USA
Manufacturer : Ruckus Wireless LLC
350 W. Java Dr., Sunnyvale CA 94089 USA
Standard : FCC Part 15 Subpart E

The product was received on Sep. 12, 2024 and testing was performed from Sep. 30, 2024 to Oct. 03, 2024. We, Sporton International (USA) Inc., would like to declare that the tested sample has been evaluated in accordance with the procedures given in FCC Part 15 Subpart E and shown compliance with the applicable technical standards.

The test results in this report apply exclusively to the tested model / sample. Without written approval of Sporton International (USA) Inc., the test report shall not be reproduced except in full.

Approved by: Neil Kao

Sporton International (USA) Inc.
1175 Montague Expressway, Milpitas, CA 95035



Table of Contents

History of this test report.....3

Summary of Test Result.....4

1 General Description5

 1.1 Feature of Equipment Under Test5

 1.2 Testing Facility5

 1.3 Modification of EUT6

 1.4 Applied Standards6

 1.5 Support Unit used in test configuration and system6

2 Requirements and Parameters for DFS Test.....7

 2.1 Summary of Dynamic Frequency Selection Test7

 2.2 Applicability of DFS Requirements8

 2.3 DFS Detection Thresholds.....10

 2.4 DFS Response requirement values.....11

 2.5 Short Pulse Radar Test Waveforms12

 2.6 Long Pulse Radar Test Waveform14

 2.7 Frequency Hopping Radar Test Waveform16

3 Calibration Setup and DFS Test Results17

 3.1 Calibration of Radar Waveform17

 3.2 U-NII Detection Bandwidth34

 3.3 Channel Availability Check45

 3.4 In-Service Monitoring: Channel Move Time, Channel Closing Transmission Time and
 Non-Occupancy Period.....51

 3.5 Statistical Performance Check60

4 List of Measuring Equipment.....78

Appendix A. DFS Radar Parameters

Appendix B. Setup Photographs



History of this test report

Report No.	Version	Description	Issue Date
FZ240524001	01	Initial issue of report	Mar. 21, 2025
FZ240524001	02	Revise Summary of Test Result This report is an updated version, replacing the report issued on Mar. 21, 2025.	Mar. 25, 2025



Summary of Test Result

Report Clause	Ref Std. Clause	Test Items	Result (PASS/FAIL)	Remark
3.2	7.8.1	U-NII Detection Bandwidth	Pass	-
3.3	7.8.2	Channel Availability Check Time	Pass	-
3.4	7.8.3	Channel Move Time	Pass	-
		Channel Closing Transmission Time	Pass	-
		Non-Occupancy Period Test	Pass	-
3.5	7.8.4	Statistical Performance Check	Pass	-

Conformity Assessment Condition:

The test results (PASS/FAIL) with all measurement uncertainty excluded are presented against the regulation limits or in accordance with the requirements stipulated by the applicant/manufacturer who shall bear all the risks of non-compliance that may potentially occur if measurement uncertainty is taken into account.

Disclaimer:

The product specifications of the EUT presented in the test report that may affect the test assessments are declared by the manufacturer who shall take full responsibility for the authenticity.



1 General Description

1.1 Feature of Equipment Under Test

Product Feature	
General Specs Wi-Fi 2.4GHz 802.11b/g/n/ac/ax/be, Wi-Fi 5GHz 802.11a/n/ac/ax/be, Wi-Fi 6GHz 802.11a/n/ac/ax/be and GNSS.	
Antenna Type WLAN: <Ant. HDBS >: Sector Antenna <Ant. VDBS >: Sector Antenna <Ant. V6S >: Sector Antenna <Ant. H6S >: Sector Antenna	

Antenna information (Sector Mode)			
5250 MHz ~ 5350 MHz	Peak Gain (dBi)	Horizontal	<Ant. HDBS>: 9.26
		Vertical	<Ant. VDBS>: 9.62
	Peak Gain (dBi)	Vertical	<Ant. V6S>: 7.32
		Horizontal	<Ant. H6S>: 8.58
5470 MHz ~ 5725 MHz	Peak Gain (dBi)	Horizontal	<Ant. HDBS>: 10.52
		Vertical	<Ant. VDBS>: 11.31
	Peak Gain (dBi)	Vertical	<Ant. V6S>: 8.64
		Horizontal	<Ant. H6S>: 9.19

Remark:

1. The EUT's information above is declared by manufacturer. Please refer to Disclaimer in report summary.
2. For other wireless features of this EUT, test report will be issued separately.
3. The main test is on 4x4 Ant. mode and only spot check on 2x2 Ant Mode.

1.2 Testing Facility

Test Site	Sporton International (USA) Inc.
Test Site Location	1175 Montague Expressway, Milpitas, CA 95035 TEL : 408 9043300
Test Site No.	Sporton Site No.
	DFS01-CA



1.3 Modification of EUT

No modifications are made to the EUT during all test items.

1.4 Applied Standards

According to the specifications of the manufacturer, the EUT must comply with the requirements of the following standards:

- ♦ FCC Part 15 Subpart E
- ♦ FCC KDB 905462 D02 UNII DFS Compliance Procedures New Rules v02
- ♦ FCC KDB 905462 D03 UNII Clients Without Radar Detection New Rules v01r02

Remark: All test items were verified and recorded according to the standards and without any deviation during the test.

1.5 Support Unit used in test configuration and system

Item	Equipment	Brand Name	Model Name	FCC ID	HW / FW Version	Power Cord
1.	Notebook	MSI	MS-16J5	PD93165NG	N/A	AC I/P: Unshielded, 1.2 m DC O/P: Shielded, 1.8 m
2.	Notebook	HP ENVY	13-ba1063cl	PD9AX201D2	N/A	AC I/P: Unshielded, 1.2 m DC O/P: Shielded, 1.8 m



2 Requirements and Parameters for DFS Test

2.1 Summary of Dynamic Frequency Selection Test

UNII	Description	Limit
U-NII 2-A 5250-5350 MHz	Channel Availability Check Time	> 60sec
	U-NII Detection Bandwidth	> 100% of the U-NII 99% transmission power bandwidth
	Statistical Performance Check	Type 1,2,3,4 >= 60% Type 1~4 and 5 >= 80% Type 6 >= 70%
	Channel Move Time	< 10 sec
	Channel Closing Transmission Time	< 200 ms + aggregate of 60 ms over remaining 10 s period
	Non-Occupancy Period Test	> 30 minutes
U-NII 2-C 5470-5725 MHz	Channel Availability Check Time	> 60sec
	U-NII Detection Bandwidth	> 100% of the U-NII 99% transmission power bandwidth
	Statistical Performance Check	Type 1,2,3,4 >= 60% Type 1~4 and 5 >= 80% Type 6 >= 70%
	Channel Move Time	< 10 sec
	Channel Closing Transmission Time	< 200 ms + aggregate of 60 ms over remaining 10 s period
	Non-Occupancy Period Test	> 30 minutes



2.2 Applicability of DFS Requirements

EUT is considered as a master device.

Table 1: Applicability of DFS Requirements Prior to Use of a Channel

Requirement	Operational Mode		
	Master	Client Without Radar Detection	Client With Radar Detection
Non-Occupancy Period	Yes	Not required	Yes
DFS Detection Threshold	Yes	Not required	Yes
Channel Availability Check Time	Yes	Not required	Not required
U-NII Detection Bandwidth	Yes	Not required	Yes



Table 2: Applicability of DFS requirements during normal operation

Requirement	Operational Mode		
	Master	Client Without Radar Detection	Client With Radar Detection
DFS Detection Threshold	Yes	Not required	Yes
Channel Closing Transmission Time	Yes	Yes	Yes
Channel Move Time	Yes	Yes	Yes
U-NII Detection Bandwidth	Yes	Not required	Yes
Client Beacon Test	N/A	Yes	Yes

Additional requirements for devices with multiple bandwidth modes	Operational Mode	
	Master or Client With Radar Detection	Client Without Radar Detection
U-NII Detection Bandwidth and Statistical Performance Check	All BW modes must be tested	Not required
Channel Move Time and Channel Closing Transmission Time	Test using widest BW mode available	Test using the widest BW mode available for the link
All other tests	Any single BW mode	Not required

Note

Frequencies selected for statistical performance check (Section 7.8.4) should include several frequencies within the radar detection bandwidth and frequencies near the edge of the radar detection bandwidth. For 802.11 devices it is suggested to select frequencies in each of the bonded 20 MHz channels and the channel center frequency.



2.3 DFS Detection Thresholds

Table 3 below provides the DFS Detection Thresholds for Master Devices as well as Client Devices incorporating In-Service Monitoring.

Table 3: DFS Detection Thresholds for Master Devices

Maximum Transmit Power	Value (see notes 1, 2, and 3)
EIRP ≥ 200 milliwatt	-64 dBm
EIRP < 200 milliwatt and power spectral density < 10 dBm/MHz	-62 dBm
EIRP < 200 milliwatt that do not meet the power spectral density requirement	-64 dBm
<p>Note 1: This is the level at the input of the receiver assuming a 0 dBi receive antenna.</p> <p>Note 2: Throughout these test procedures an additional 1 dB has been added to the amplitude of the test transmission waveforms to account for variations in measurement equipment. This will ensure that the test signal is at or above the detection threshold level to trigger a DFS response.</p> <p>Note 3: EIRP is based on the highest antenna gain. For MIMO devices refer to KDB Publication 662911 D01.</p>	

The radar *Detection Threshold*, lowest antenna gain is the parameter of Interference radar DFS detection threshold, The Interference Detection Threshold is the $-64+7.32 = -56.68\text{dBm}$ in U-NII-2a, $-64+8.6 = -55.36\text{dBm}$ in U-NII-2c.



2.4 DFS Response requirement values

Table 4 provides the response requirements for Master and Client Devices incorporating DFS.

Table 4: DFS Response Requirement Values

Parameter	Value
Non-occupancy period	Minimum 30 minutes
Channel Availability Check Time	60 seconds
Channel Move Time	10 seconds See Note 1.
Channel Closing Transmission Time	200 milliseconds + an aggregate of 60 milliseconds over remaining 10 second period. See Notes 1 and 2.
U-NII Detection Bandwidth	Minimum 100% of the 99% power bandwidth See Note 3.

Note 1: Channel Move Time and the Channel Closing Transmission Time should be performed with Radar Type 0. The measurement timing begins at the end of the Radar Type 0 burst.

Note 2: The Channel Closing Transmission Time is comprised of 200 milliseconds starting at the beginning of the Channel Move Time plus any additional intermittent control signals required to facilitate Channel changes (an aggregate of 60 milliseconds) during the remainder of the 10 second period. The aggregate duration of control signals will not count quiet periods in between transmissions.

Note 3: During the U-NII Detection Bandwidth detection test, radar type 0 is used and for each frequency step the minimum percentage of detection is 90%. Measurements are performed with no data traffic.



2.5 Short Pulse Radar Test Waveforms

Radar Type 0 was used in the evaluation of the Client device for the purpose of measuring the Channel Move Time and the Channel Closing Transmission Time.

Radar Type	Pulse Width (μsec)	PRI (μsec)	Number of Pulses	Minimum Percentage of Successful Detection	Minimum Trials
0	1	1428	18	See Note 1.	See Note 1.
1	1	Test A Test B	Roundup $\left\{ \begin{matrix} \left(\frac{1}{360} \right) \cdot \\ \left(\frac{19 \cdot 10^6}{PRI_{\mu sec}} \right) \end{matrix} \right\}$	60%	30
2	1-5	150-230	23-29	60%	30
3	6-10	200-500	16-18	60%	30
4	11-20	200-500	12-16	60%	30
Aggregate (Radar Types 1-4)				80%	120
Note 1: Short Pulse Radar Type 0 should be used for the detection bandwidth test, channel move time, and channel closing time tests.					

Test A: 15 unique PRI values randomly selected from the list of 23 PRI values in Table 5a

Test B: 15 unique PRI values randomly selected within the range of 518-3066 μsec, with a minimum increment of 1 μsec, excluding PRI values selected in Test A

A minimum of 30 unique waveforms are required for each of the Short Pulse Radar Types 2 through 4. If more than 30 waveforms are used for Short Pulse Radar Types 2 through 4, then each additional waveform must also be unique and not repeated from the previous waveforms.

If more than 30 waveforms are used for Short Pulse Radar Type 1, then each additional waveform is generated with Test B and must also be unique and not repeated from the previous waveforms in Tests A or B.

The aggregate is the average of the percentage of successful detections of short pulse radar types 1-4.



Table 5a - Pulse Repetition Intervals Values for Test A

Pulse Repetition Frequency Number (1 to 23)	Pulse Repetition Frequency (Pulses Per Second)	Pulse Repetition Interval (Microseconds)
1	1930.5	518
2	1858.7	538
3	1792.1	558
4	1730.1	578
5	1672.2	598
6	1618.1	618
7	1567.4	638
8	1519.8	658
9	1474.9	678
10	1432.7	698
11	1392.8	718
12	1355.0	738
13	1319.3	758
14	1285.3	778
15	1253.1	798
16	1222.5	818
17	1193.3	838
18	1165.5	858
19	1139.0	878
20	1113.6	898
21	1089.3	918
22	1066.1	938
23	326.2	3066



2.6 Long Pulse Radar Test Waveform

Radar Type	Pulse Width (μsec)	Chirp Width (MHz)	PRI (μsec)	Number of Pulses per Burst	Number of Bursts	Minimum Percentage of Successful Detection	Minimum Trials
5	50-100	5-20	1000-2000	1-3	8-20	80%	30

The parameters for this waveform are randomly chosen. Thirty unique waveforms are required for the Long Pulse radar test signal. If more than 30 waveforms are used for the Long Pulse radar test signal, then each additional waveform must also be unique and not repeated from the previous waveforms. Each waveform is defined as follows:

Note: The center frequency for each of the 30 trials of the Bin 5 radar shall be randomly selected within 80% of the Occupied Bandwidth.

- (1) The transmission period for the Long Pulse Radar test signal is 12 seconds.
- (2) There are a total of 8 to 20 Bursts in the 12 second period, with the number of Bursts being randomly chosen. This number is Burst_Count.
- (3) Each Burst consists of 1 to 3 pulses, with the number of pulses being randomly chosen. Each Burst within the 12 second sequence may have a different number of pulses.
- (4) The pulse width is between 50 and 100 microseconds, with the pulse width being randomly chosen. Each pulse within a Burst will have the same pulse width. Pulses in different Bursts may have different pulse widths.
- (5) Each pulse has a linear frequency modulated chirp between 5 and 20 MHz, with the chirp width being randomly chosen. Each pulse within a **transmission period** will have the same chirp width. The chirp is centered on the pulse. For example, with a radar frequency of 5300 MHz and a 20 MHz chirped signal, the chirp starts at 5290 MHz and ends at 5310 MHz
- (6) If more than one pulse is present in a Burst, the time between the pulses will be between 1000 and 2000 microseconds, with the time being randomly chosen. If three pulses are present in a Burst, the time between the first and second pulses is chosen independently of the time between the second and third pulses.
- (7) The 12 second transmission period is divided into even intervals. The number of intervals is equal to Burst_Count. Each interval is of length $(12,000,000 / \text{Burst_Count})$ microseconds. Each interval contains one Burst. The start time for the Burst, relative to the beginning of the interval, is between 1 and $[(12,000,000 / \text{Burst_Count}) - (\text{Total Burst Length}) + (\text{One Random PRI Interval})]$ microseconds, with the start time being randomly chosen. The step interval for the start time is 1 microsecond. The start time for each Burst is chosen independently.

A representative example of a Long Pulse radar test waveform:

- (1) The total test signal length is 12 seconds.
- (2) 8 Bursts are randomly generated for the Burst_Count.
- (3) Burst 1 has 2 randomly generated pulses.
- (4) The pulse width (for both pulses) is randomly selected to be 75 microseconds.
- (5) The PRI is randomly selected to be at 1213 microseconds.
- (6) Bursts 2 through 8 are generated using steps 3 – 5.
- (7) Each Burst is contained in even intervals of 1,500,000 microseconds. The starting location for Pulse 1, Burst 1 is randomly generated (1 to 1,500,000 minus the total Burst 1 length + 1 random PRI interval) at the 325,001 microsecond step. Bursts 2 through 8 randomly fall in successive 1,500,000 microsecond intervals (i.e. Burst 2 falls in the 1,500,001 – 3,000,000 microsecond range).

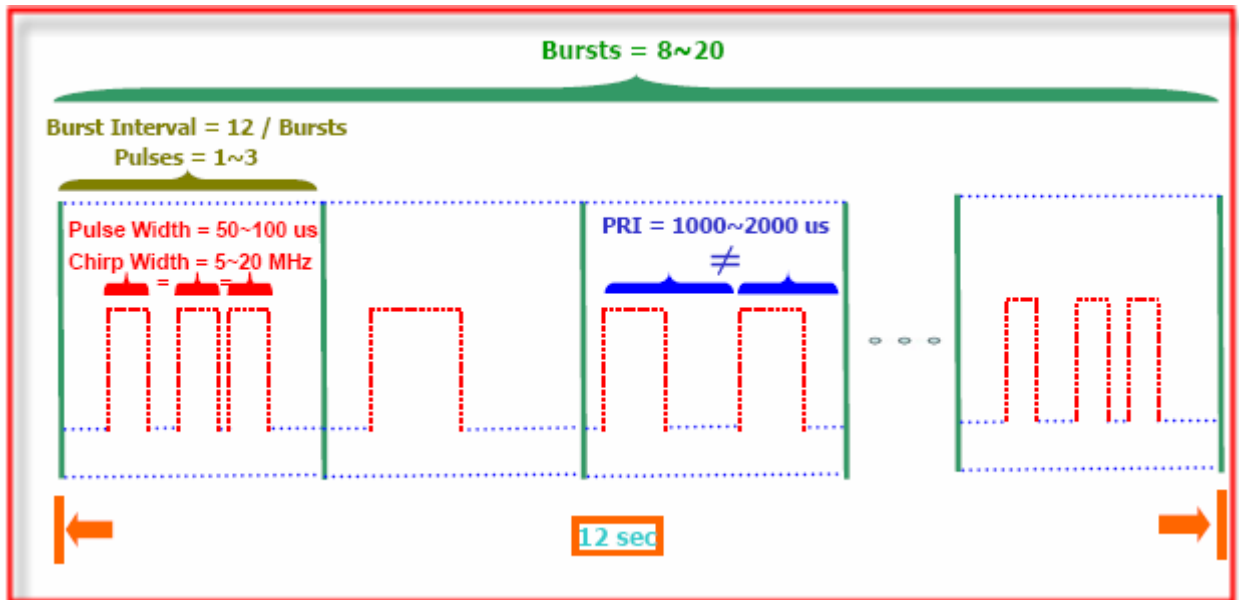

2.7 Frequency Hopping Radar Test Waveform

Radar Type	Pulse Width (μsec)	PRI (μsec)	Pulses per Hop	Hopping Rate (kHz)	Hopping Sequence Length (msec)	Minimum Percentage of Successful Detection	Minimum Trials
6	1	333	9	0.333	300	70%	30

For the Frequency Hopping Radar Type, the same Burst parameters are used for each waveform. The hopping sequence is different for each waveform and a 100-length segment is selected from the hopping sequence defined by the following algorithm:

The first frequency in a hopping sequence is selected randomly from the group of 475 integer frequencies from 5250 – 5724 MHz. Next, the frequency that was just chosen is removed from the group and a frequency is randomly selected from the remaining 474 frequencies in the group. This process continues until all 475 frequencies are chosen for the set. For selection of a random frequency, the frequencies remaining within the group are always treated as equally likely.

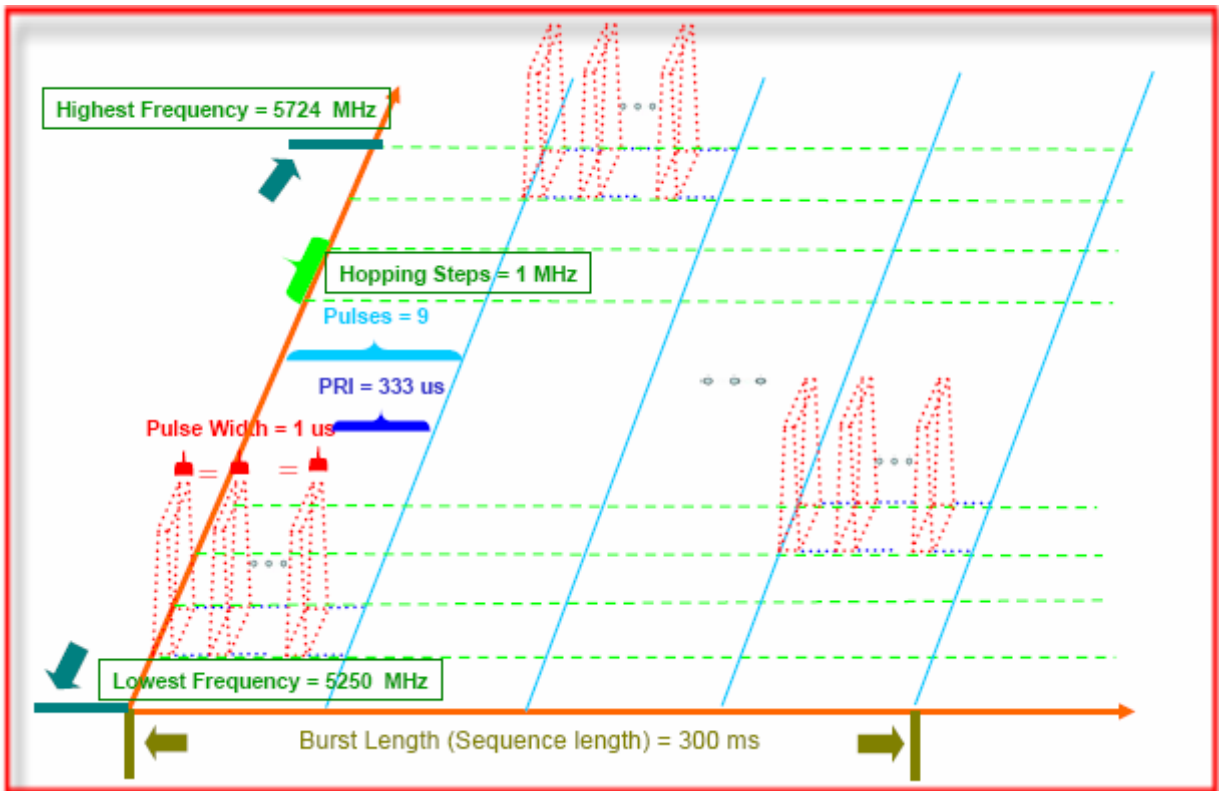

3 Calibration Setup and DFS Test Results

3.1 Calibration of Radar Waveform

3.1.1 Radar Waveform Calibration Procedure

The Interference Radar Detection Threshold Level is -64dBm that had been taken into account the output power range and antenna gain. The following equipment setup was used to calibrate the conducted Radar Waveform. A vector signal generator was utilized to establish the test signal level for radar type 0~6. During this process there were no transmissions by either the Master or Client Device. The spectrum analyzer was switched to the zero span (Time Domain) at the frequency of the Radar Waveform generator. Peak detection was used. The spectrum analyzer resolution bandwidth (RBW) and video bandwidth (VBW) were set to 3 MHz to measure the radar waveform. The vector signal generator amplitude was set so that the power level measured at the spectrum analyzer was -64dBm. Capture the spectrum analyzer plots on radar waveform.

3.1.2 Calibration Setup

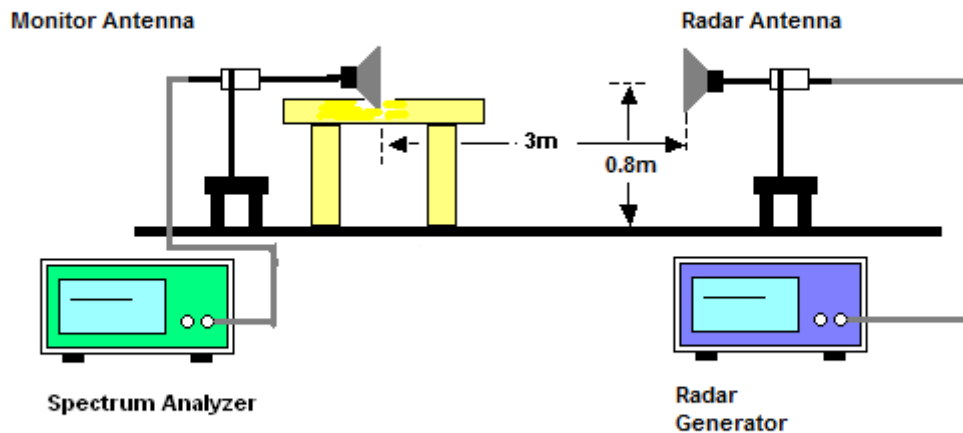

3.1.3 Calibration Deviation

There is no deviation with the original standard.



3.1.4 Radar Waveform Calibration Result

<20MHz / 5300MHz>

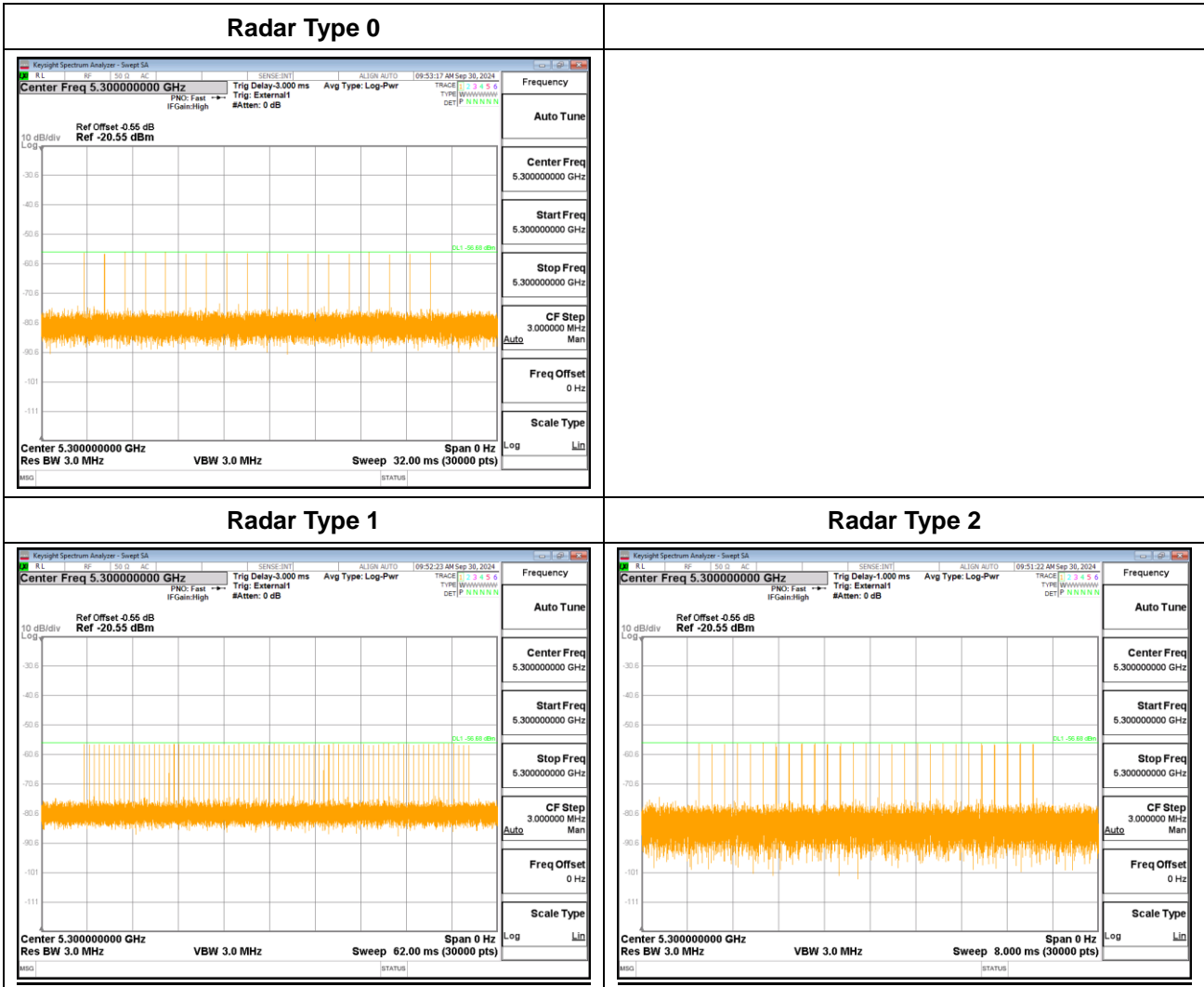



Radars Type 3

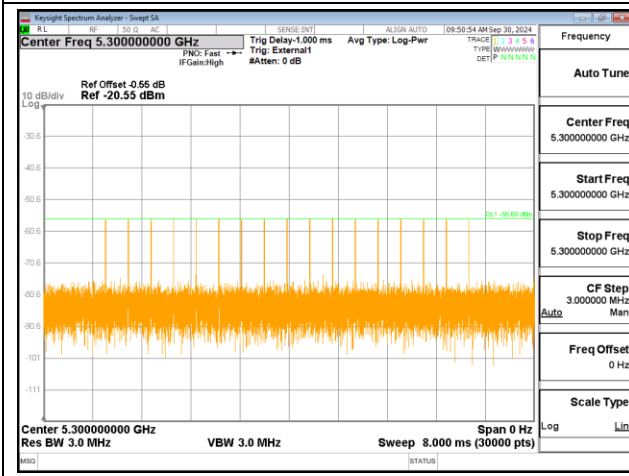

Radars Type 4

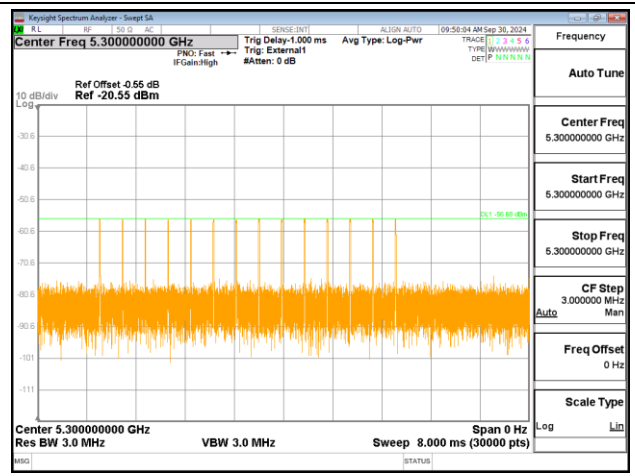

Single Burst of Radar Type 5

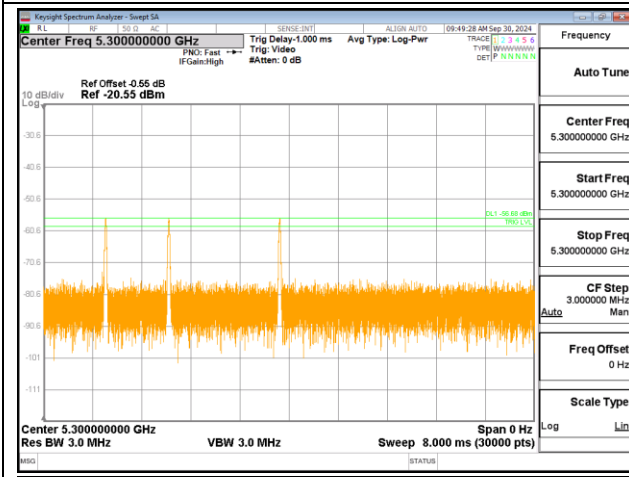

Single Burst of Radar Type 6

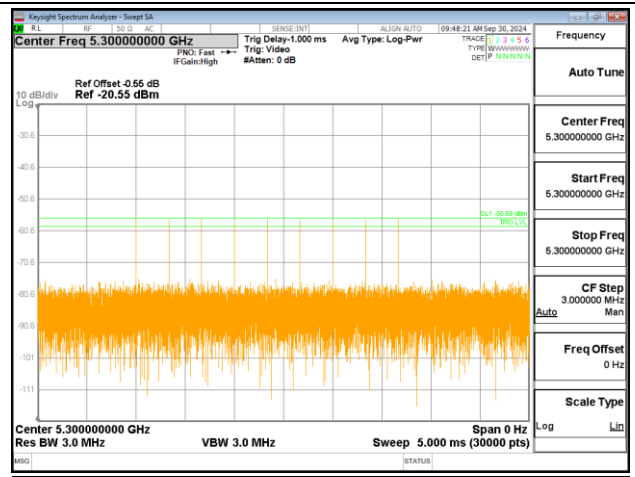



<40MHz / 5310MHz>

Radars Type 0

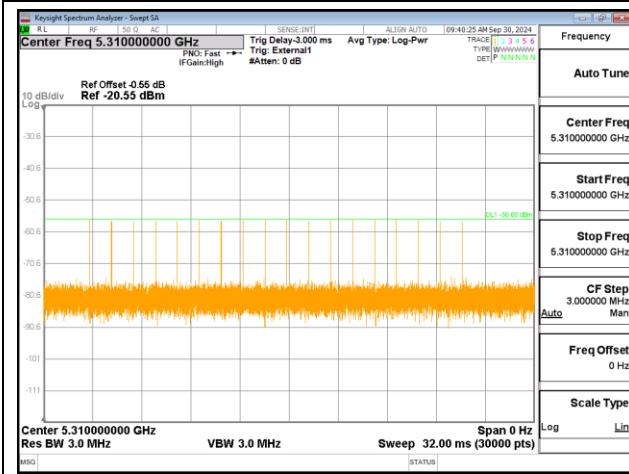

Radars Type 1

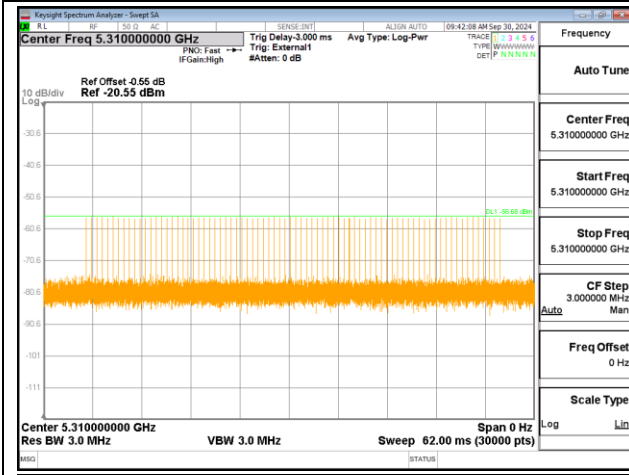

Radars Type 2

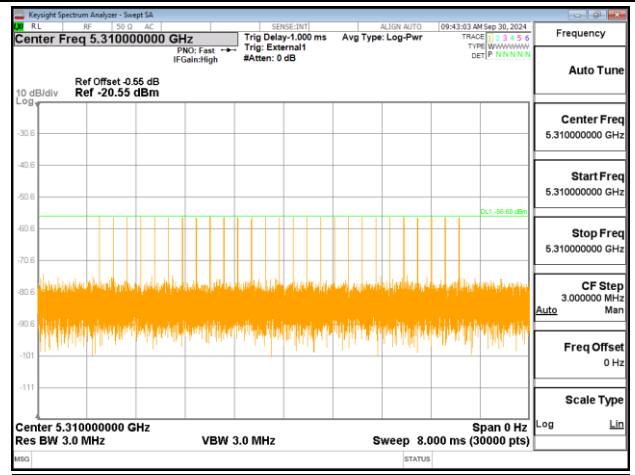



Radars Type 3

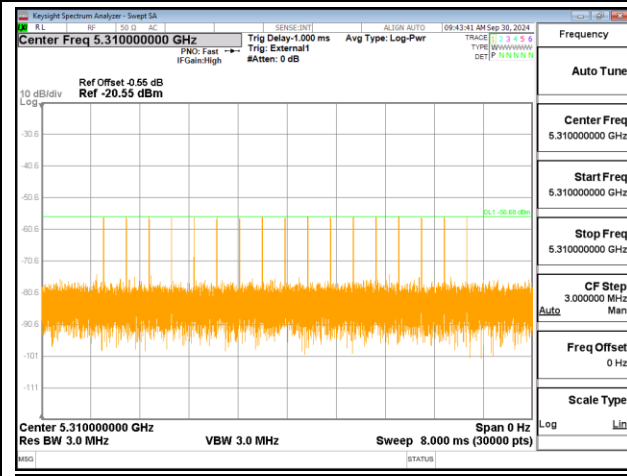

Radars Type 4

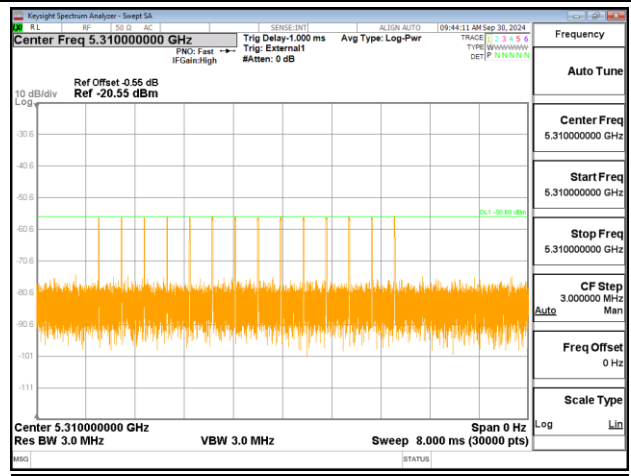

Single Burst of Radar Type 5

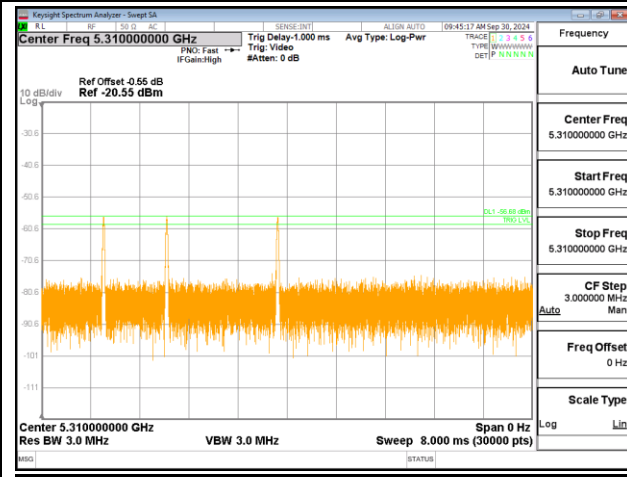

Single Burst of Radar Type 6

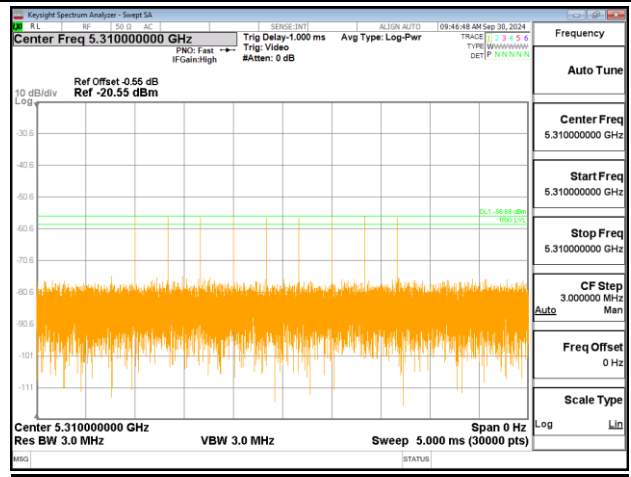



<80MHz / 5290MHz>

Radars Type 0

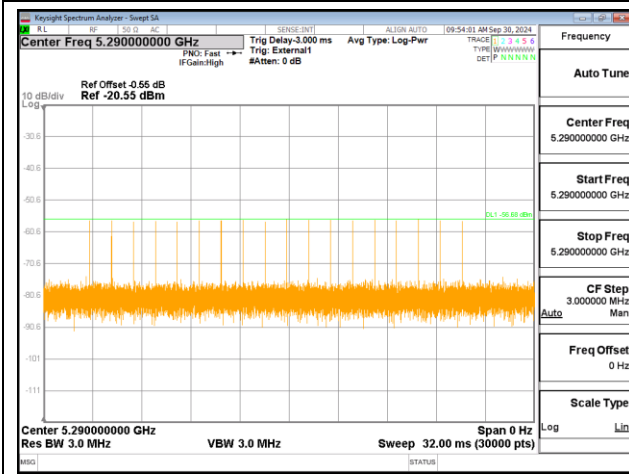

Radars Type 1

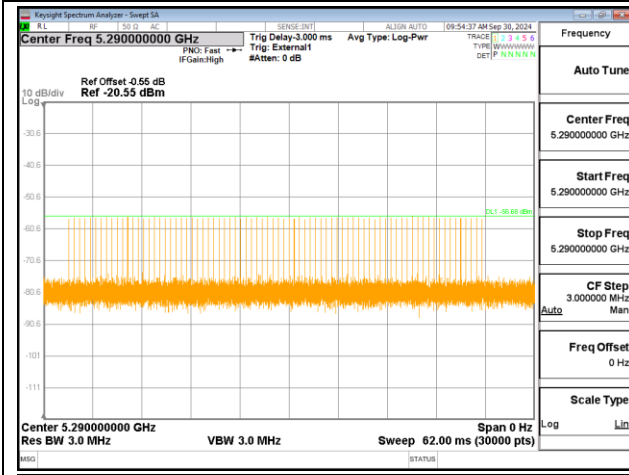

Radars Type 2

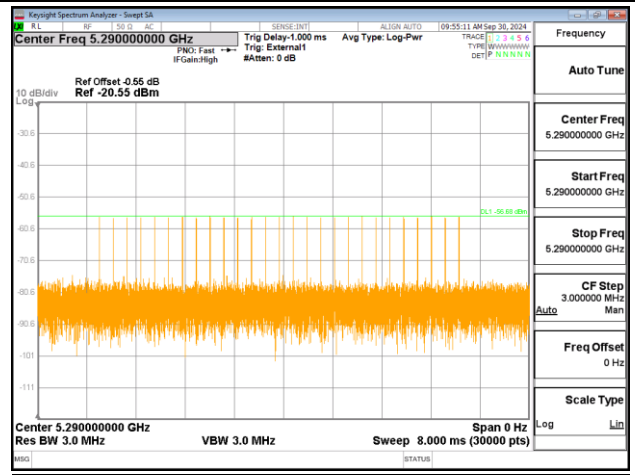



Radars Type 3

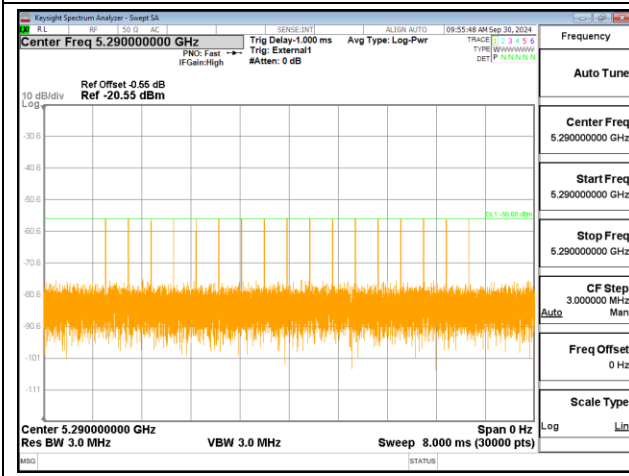

Radars Type 4

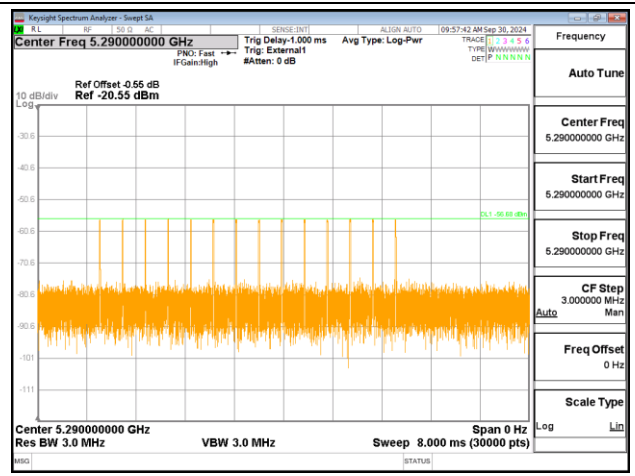

Single Burst of Radar Type 5

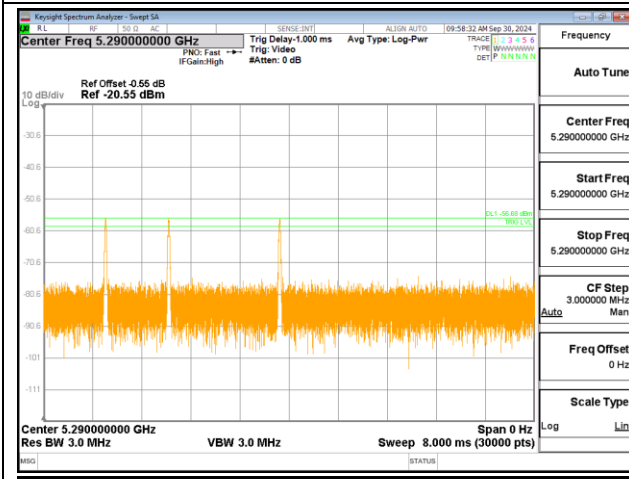

Single Burst of Radar Type 6

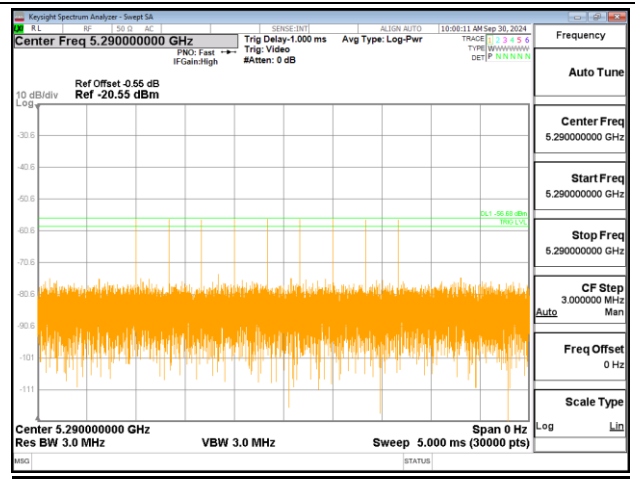



<160MHz / 5250MHz> (Radar injected on 5290MHz)

Radar Type 0

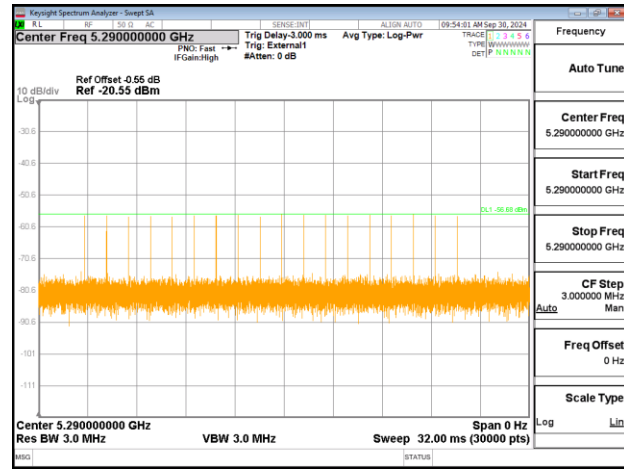

Radar Type 1

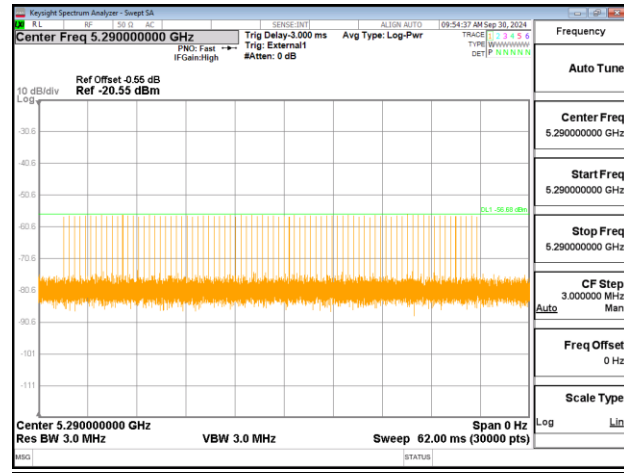

Radar Type 2

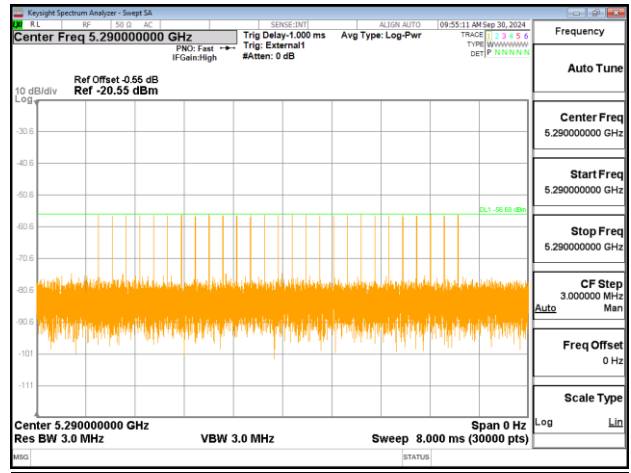



Radars Type 3

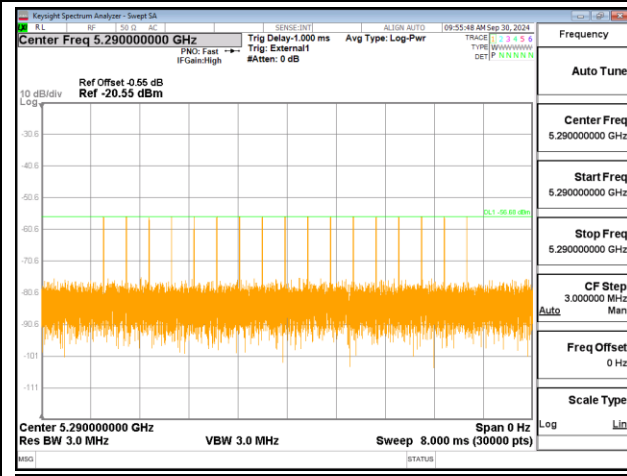

Radars Type 4

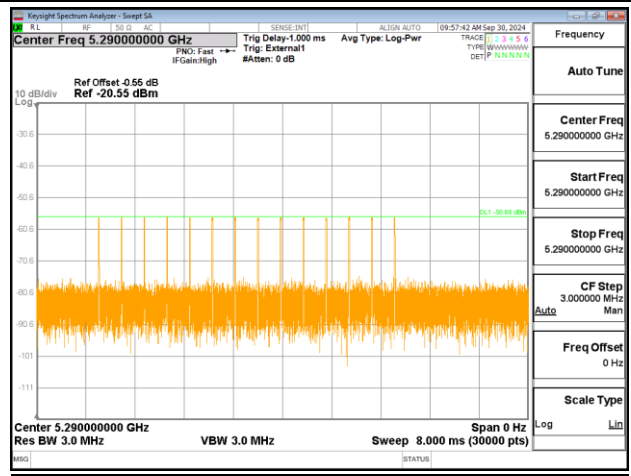

Single Burst of Radar Type 5

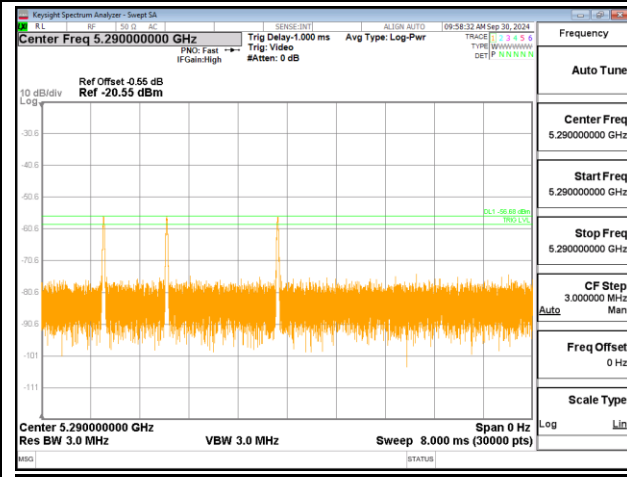

Single Burst of Radar Type 6

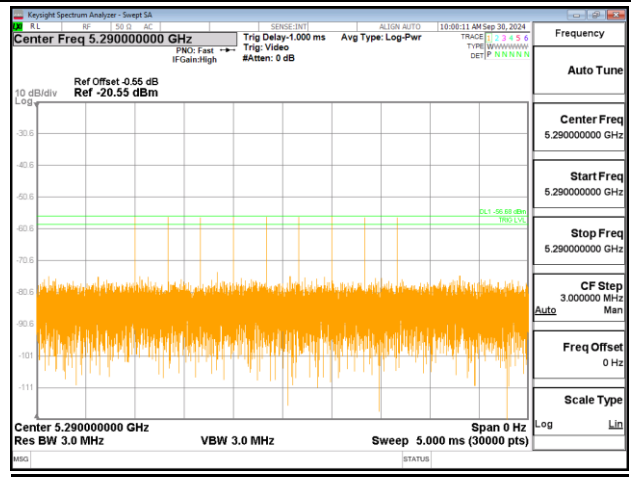



<20MHz / 5500MHz>

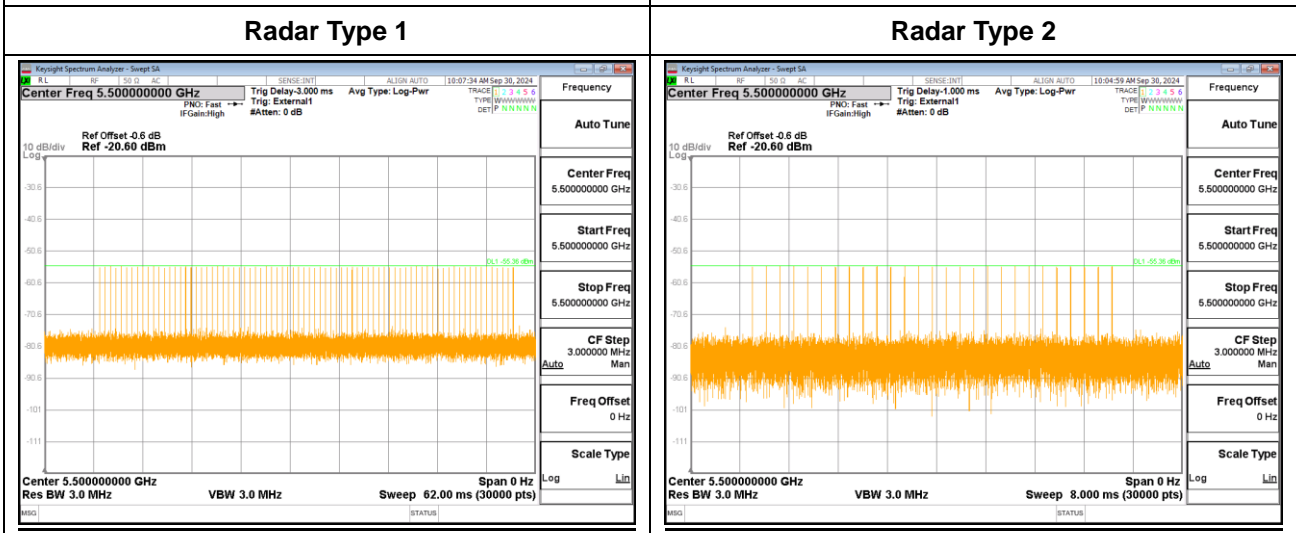
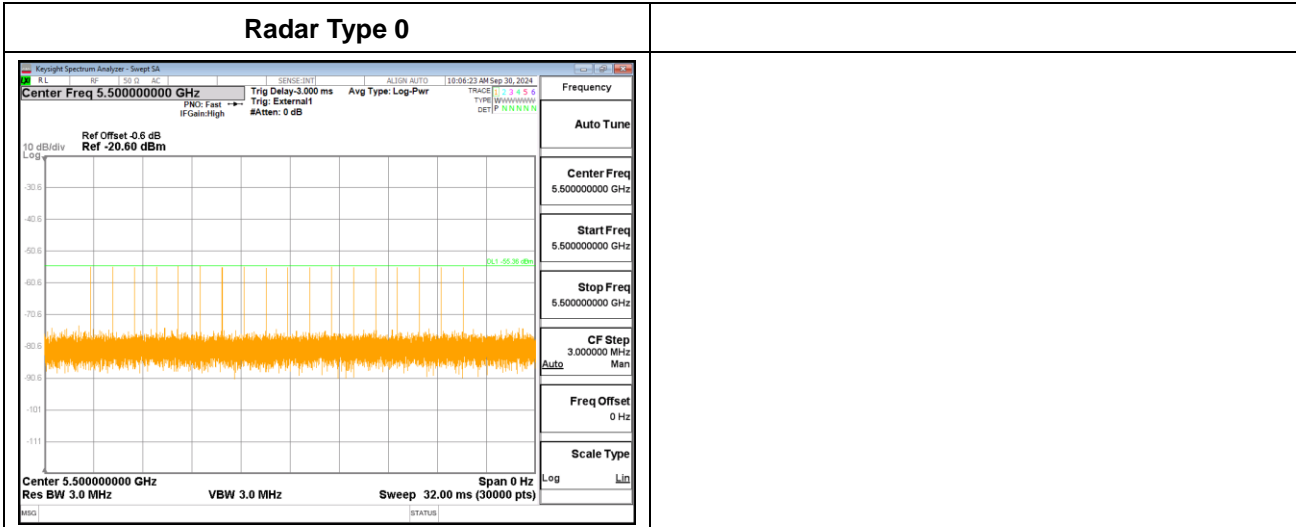



Radars Type 3

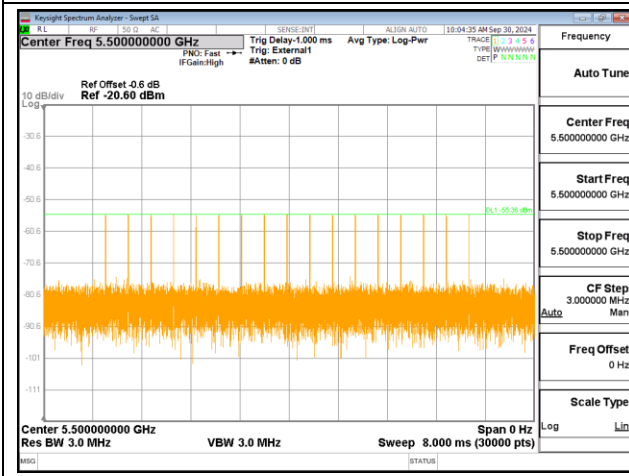

Radars Type 4

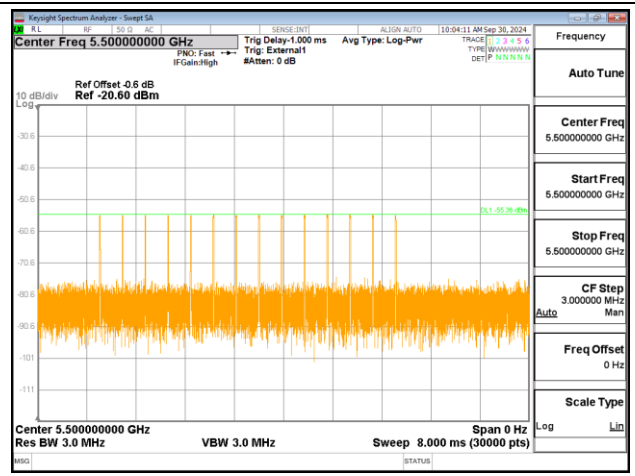

Single Burst of Radar Type 5

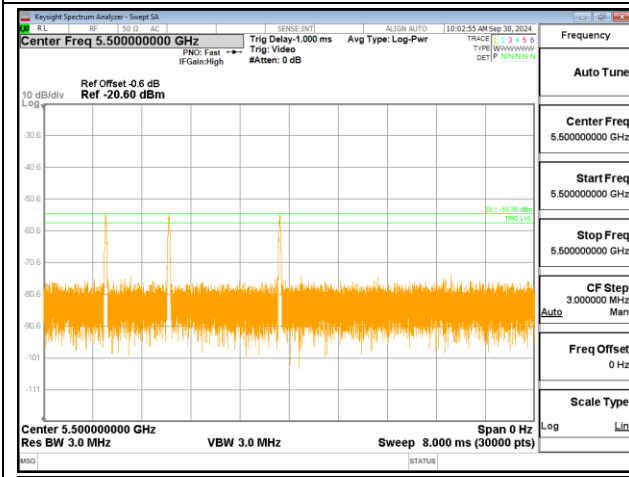

Single Burst of Radar Type 6

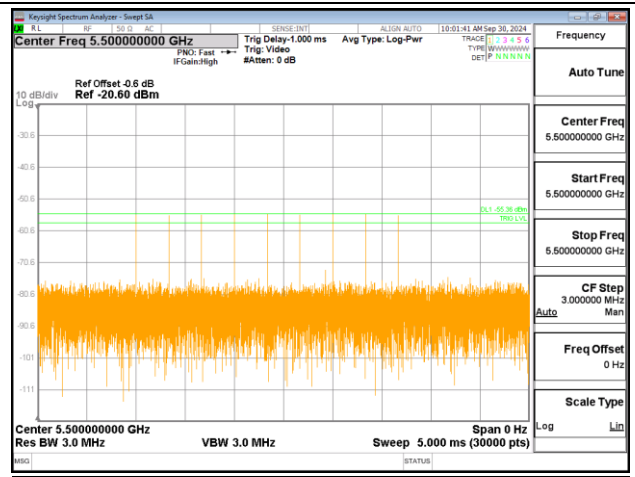



<40MHz / 5510MHz>

Radars Type 0

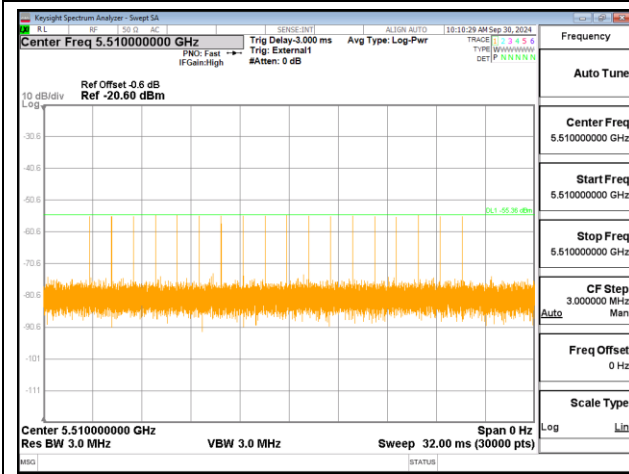

Radars Type 1

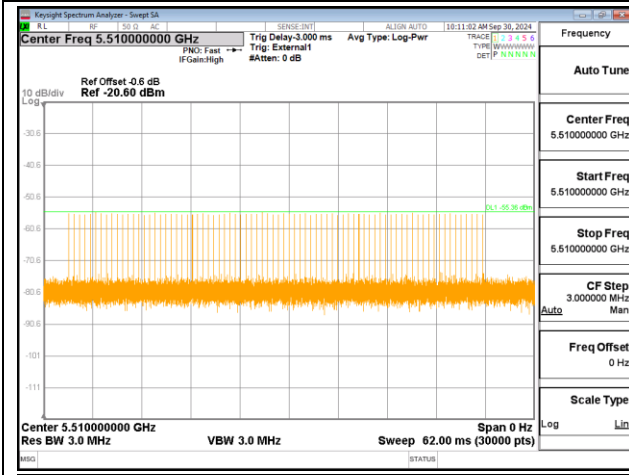

Radars Type 2

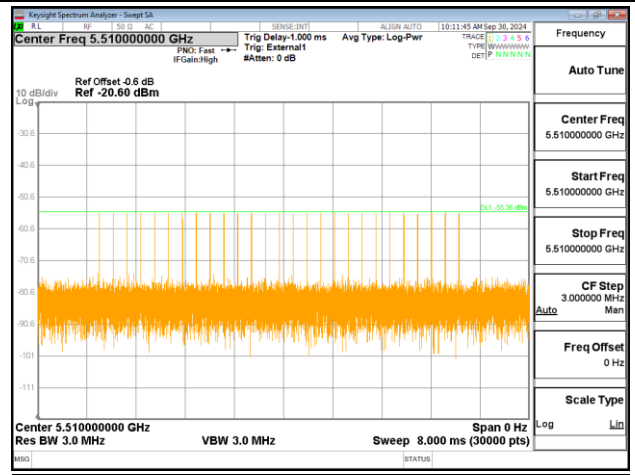



Radars Type 3

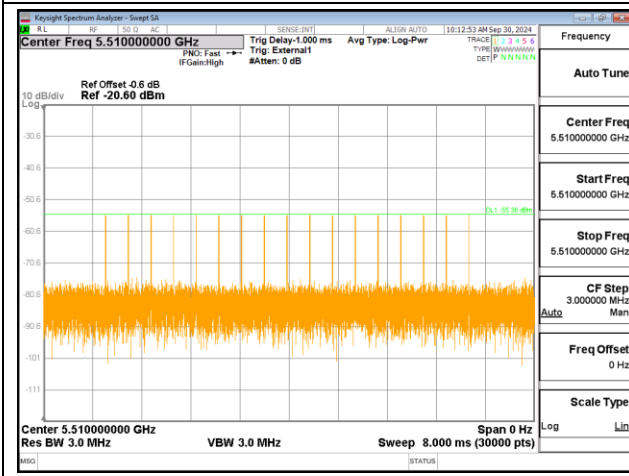

Radars Type 4

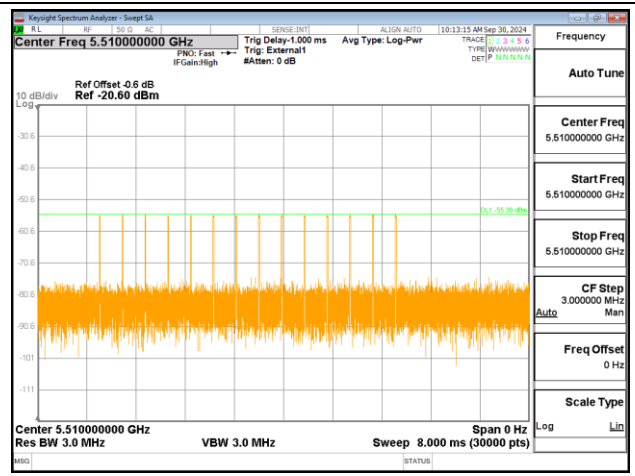

Single Burst of Radar Type 5

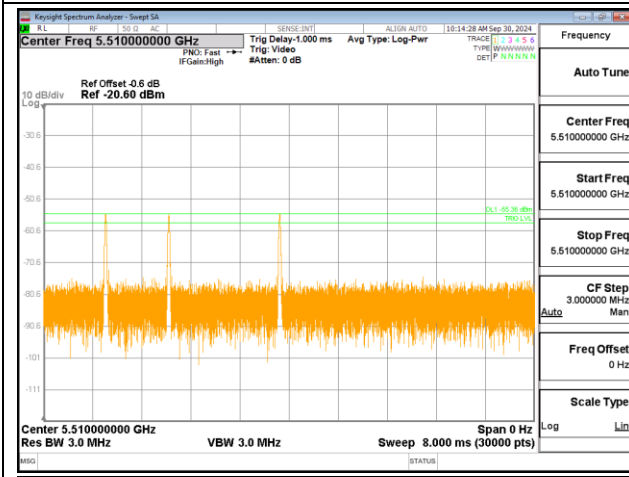

Single Burst of Radar Type 6

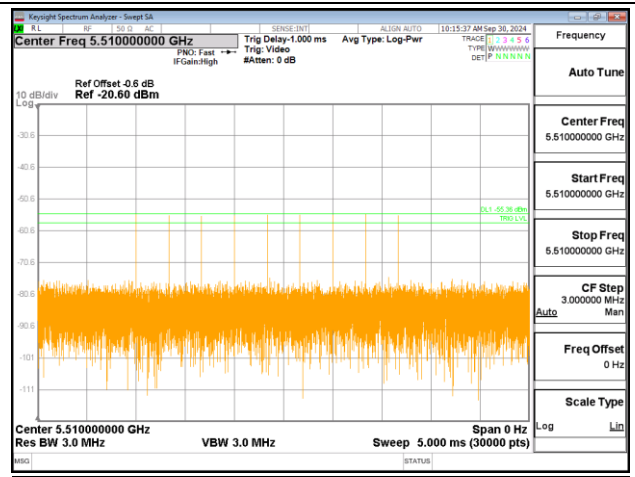



<80MHz / 5530MHz>

Radars Type 0

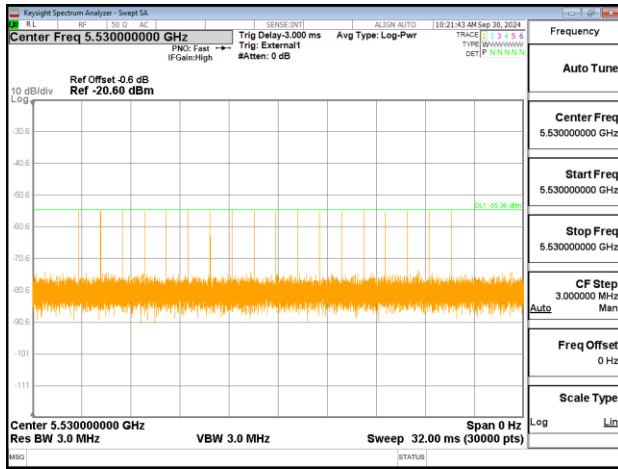

Radars Type 1

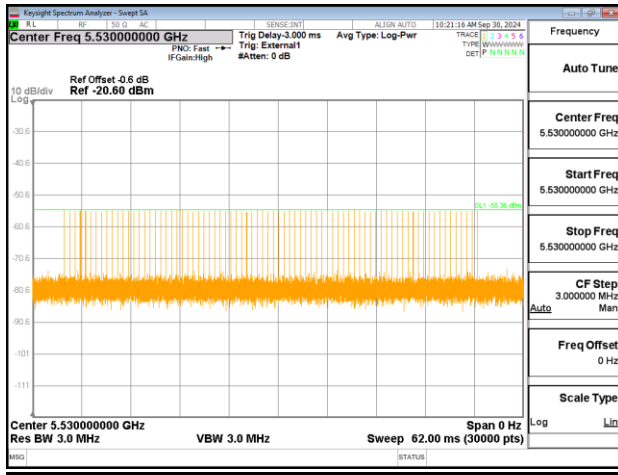

Radars Type 2

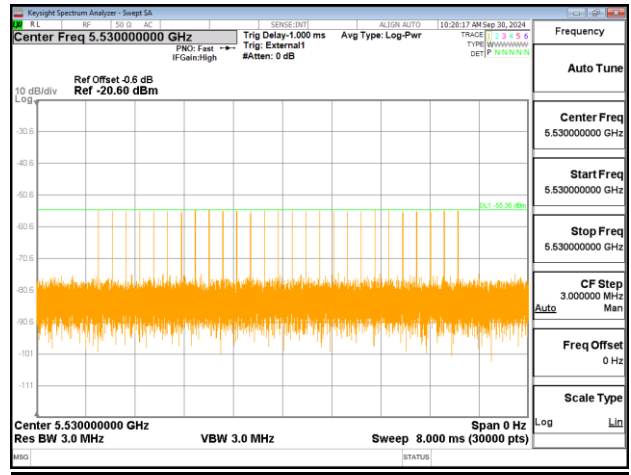



Radars Type 3

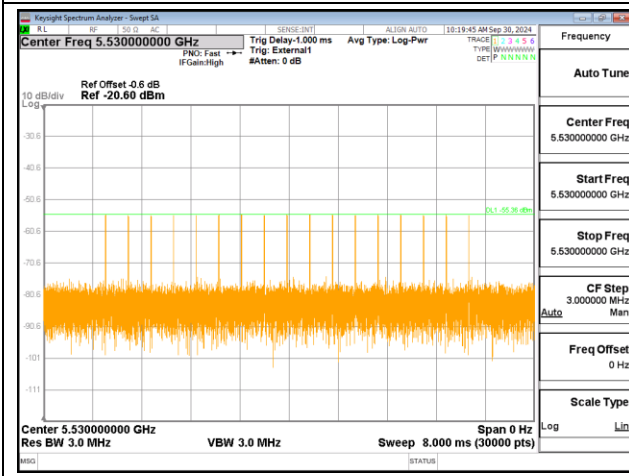

Radars Type 4

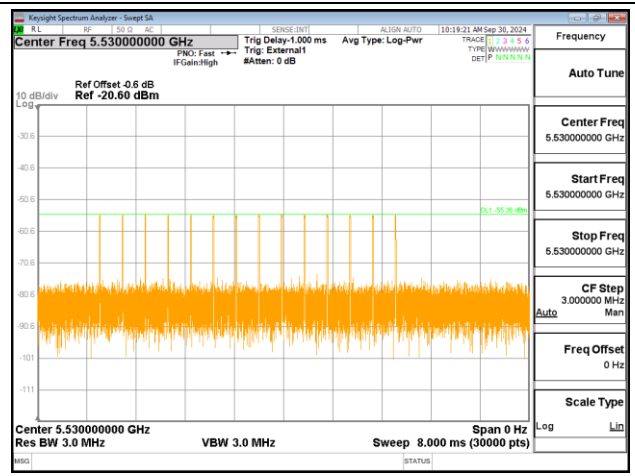

Single Burst of Radar Type 5

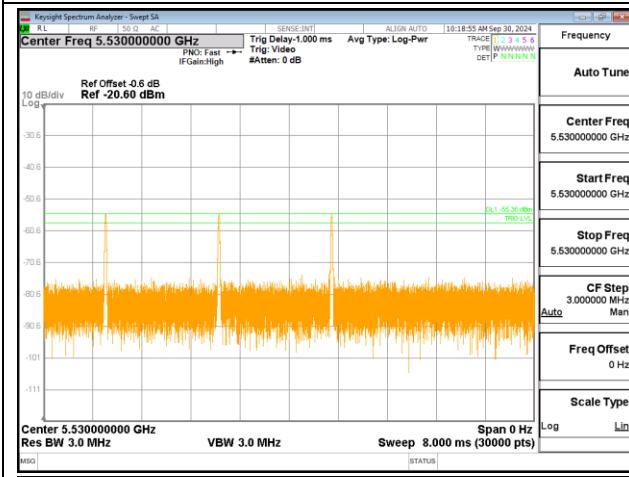

Single Burst of Radar Type 6

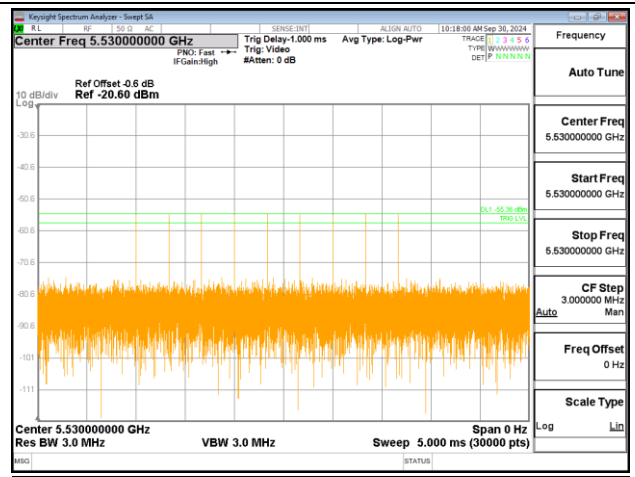



<160MHz / 5570MHz>

Radars Type 0

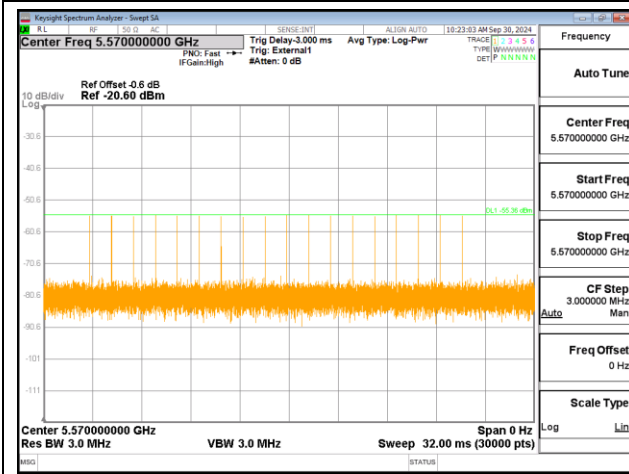

Radars Type 1

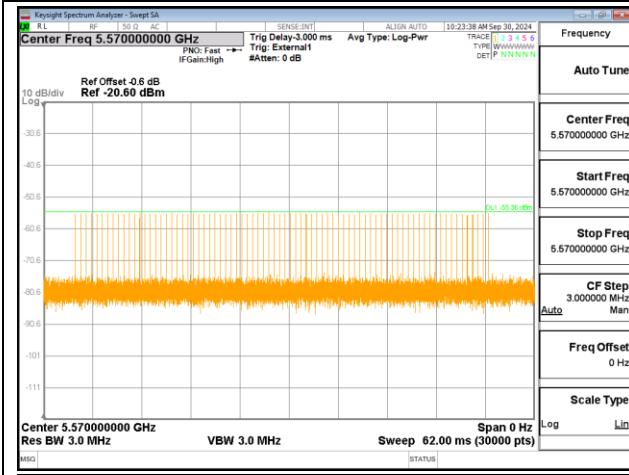

Radars Type 2

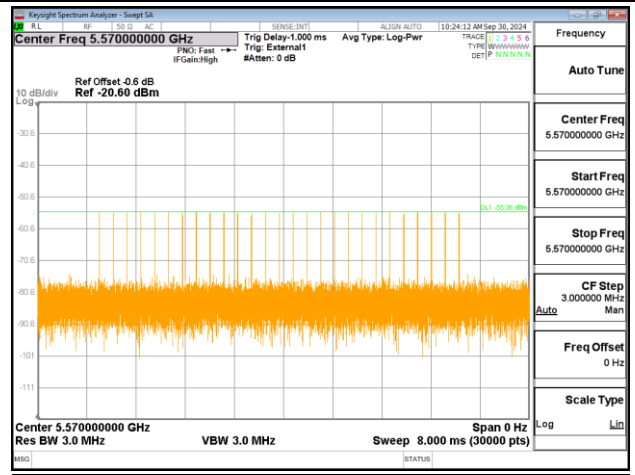



Radars Type 3

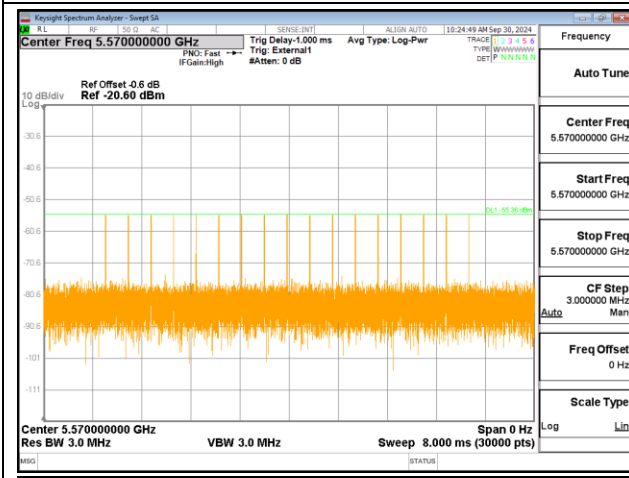

Radars Type 4

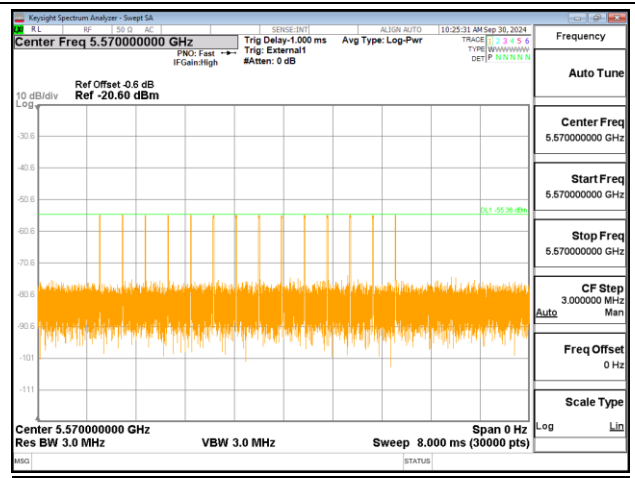

Single Burst of Radar Type 5

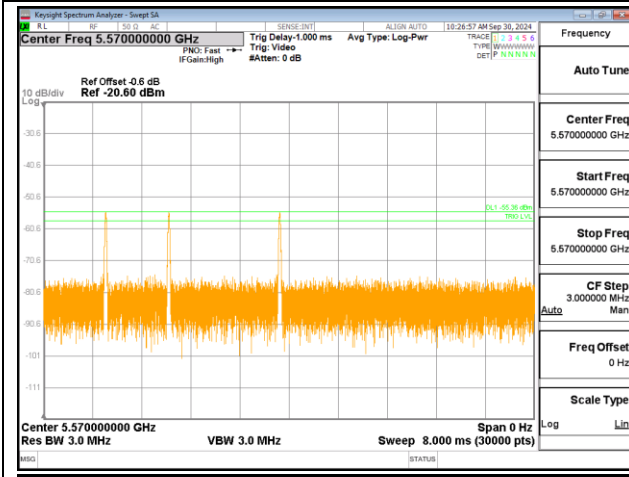

Single Burst of Radar Type 6

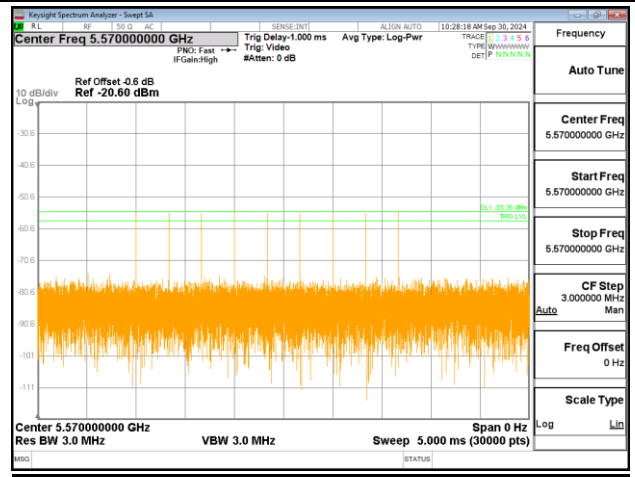



3.2 U-NII Detection Bandwidth

3.2.1 Limit of U-NII Detection Bandwidth

The U-NII Detection Bandwidth shall contain minimum 100% of the 99% power bandwidth. During the U-NII Detection Bandwidth detection test, radar type 0 is used and for each frequency step the minimum percentage of detection is 90%. Measurements are performed with no data traffic.

3.2.2 Test Procedures

- (1) Adjust the equipment to produce a single burst of the Short Pulse Radar Type 0 at the center frequency of the EUT Operating Channel at the specified DFS Detection Threshold level.
- (2) Set the EUT up as a standalone device (no associated Client or Master, as appropriate) and no traffic. Frame based systems will be set to a talk/listen ratio of 0%/100% during this test.
- (3) Generate a single radar burst, and note the response of the EUT. Repeat for a minimum of 10 trials. The EUT must detect the Radar Waveform using the specified U-NII Detection Bandwidth criterion.
- (4) Starting at the center frequency of the EUT operating Channel, increase the radar frequency in 5 MHz steps, repeating the above test sequence, until the detection rate falls below the U-NII Detection Bandwidth criterion specified in report clause 2.3. Repeat this measurement in 1MHz steps at frequencies 5 MHz below where the detection rate begins to fall. Record the highest frequency (denote as F_H) at which detection is greater than or equal to the U-NII Detection Bandwidth criterion. Recording the detection rate at frequencies above F_H is not required to demonstrate compliance.
- (5) Starting at the center frequency of the EUT operating Channel, decrease the radar frequency in 5 MHz steps, repeating the above test sequence, until the detection rate falls below the U-NII Detection Bandwidth criterion specified in report clause 2.3. Repeat this measurement in 1MHz steps at frequencies 5 MHz above where the detection rate begins to fall. Record the lowest frequency (denote as F_L) at which detection is greater than or equal to the U-NII Detection Bandwidth criterion. Recording the detection rate at frequencies below F_L is not required to demonstrate compliance.
- (6) The U-NII Detection Bandwidth is calculated as follows:
U-NII Detection Bandwidth = $F_H - F_L$

3.2.3 Test Setup

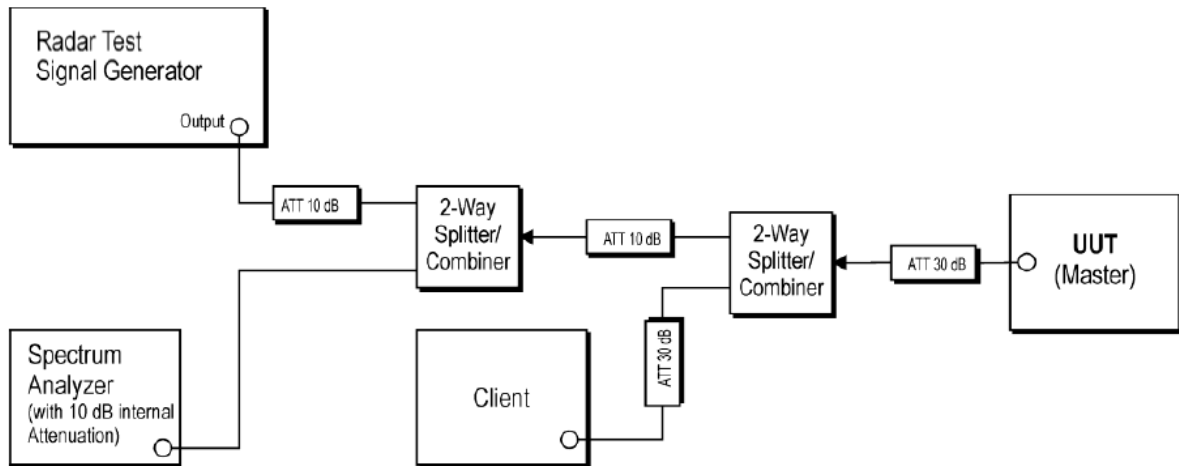

3.2.4 Test Deviation

There is no deviation with the original standard.



3.2.5 Result of U-NII Detection Bandwidth

<20MHz / 5300MHz>

Frequency (MHz)	Fc	Trial Number (Detection = Y, No Detection = N)										Rate (%)	F _H /F _L
		1	2	3	4	5	6	7	8	9	10		
5289	-11	N	N	N	N	N	N	N	N	N	N	0	
5290	-10	Y	Y	Y	Y	Y	Y	Y	Y	Y	Y	100%	F _L
5291	-9	Y	Y	Y	Y	Y	Y	Y	Y	Y	Y	100%	
5292	-8	Y	Y	Y	Y	Y	Y	Y	Y	Y	Y	100%	
5293	-7	Y	Y	Y	Y	Y	Y	Y	Y	Y	Y	100%	
5294	-6	Y	Y	Y	Y	Y	Y	Y	Y	Y	Y	100%	
5295	-5	Y	Y	Y	Y	Y	Y	N	Y	Y	Y	90%	
5300	0	Y	Y	Y	Y	Y	Y	Y	Y	Y	Y	100%	
5305	+5	Y	Y	Y	Y	Y	Y	Y	Y	Y	Y	100%	
5306	+6	Y	Y	Y	Y	Y	Y	Y	Y	Y	Y	100%	
5307	+7	Y	Y	Y	Y	Y	Y	Y	Y	Y	Y	100%	
5308	+8	Y	Y	Y	Y	Y	Y	Y	Y	Y	Y	100%	
5309	+9	Y	Y	Y	Y	Y	Y	Y	Y	Y	Y	100%	
5310	+10	Y	Y	Y	Y	Y	Y	Y	Y	Y	Y	100%	F _H
5311	+11	N	N	N	N	N	N	N	N	N	N	0	

Detection Bandwidth = F_H – F_L = **5310 – 5290 = 20** MHz
EUT 99% Bandwidth = 19.61 MHz (Refer to channel 60)



<40MHz / 5310MHz>

Frequency (MHz)	Fc	Trial Number (Detection = Y, No Detection = N)										Rate (%)	F _H /F _L
		1	2	3	4	5	6	7	8	9	10		
5289	-21	N	N	N	N	N	N	N	N	N	N	0%	
5290	-20	Y	Y	Y	Y	Y	Y	Y	Y	Y	Y	100%	F _L
5291	-19	Y	Y	Y	Y	Y	Y	Y	Y	Y	Y	100%	
5292	-18	Y	Y	Y	Y	Y	Y	Y	Y	Y	Y	100%	
5293	-17	Y	Y	Y	Y	Y	Y	Y	Y	Y	Y	100%	
5294	-16	Y	Y	Y	Y	Y	Y	Y	Y	Y	Y	100%	
5295	-15	Y	Y	Y	Y	Y	Y	Y	Y	Y	Y	100%	
5300	-10	Y	Y	Y	Y	Y	Y	Y	Y	Y	Y	100%	
5305	-5	Y	Y	Y	Y	Y	Y	Y	Y	Y	Y	100%	
5310	0	Y	Y	Y	Y	Y	Y	Y	Y	Y	Y	100%	
5315	+5	Y	Y	Y	Y	Y	Y	Y	Y	Y	Y	100%	
5320	+10	Y	Y	Y	Y	Y	Y	Y	Y	Y	Y	100%	
5325	+15	Y	Y	Y	Y	Y	Y	Y	Y	Y	Y	100%	
5326	+16	Y	Y	Y	Y	Y	Y	Y	Y	Y	Y	100%	
5327	+17	Y	Y	Y	Y	Y	Y	Y	Y	Y	Y	100%	
5328	+18	Y	Y	Y	Y	Y	Y	Y	Y	Y	Y	100%	
5329	+19	Y	Y	Y	Y	Y	Y	Y	Y	Y	Y	100%	
5330	+20	Y	Y	Y	Y	Y	Y	Y	Y	Y	Y	100%	F _H
5331	+21	N	N	N	N	N	N	N	N	N	N	0%	

Detection Bandwidth = F_H – F_L = 5330 – 5290 = 40 MHz
EUT 99% Bandwidth = 38.215 MHz (Refer to channel 62)



<80MHz / 5290MHz>

Frequency (MHz)	Fc	Trial Number (Detection = Y, No Detection = N)										Rate (%)	F _H /F _L
		1	2	3	4	5	6	7	8	9	10		
5249	-41	N	N	N	N	N	N	N	N	N	N	0%	
5250	-40	Y	Y	Y	Y	Y	Y	Y	Y	Y	Y	100%	F _L
5251	-39	Y	Y	Y	Y	Y	Y	Y	Y	Y	Y	100%	
5252	-38	Y	Y	Y	Y	Y	Y	Y	Y	Y	Y	100%	
5253	-37	Y	Y	Y	Y	Y	Y	Y	Y	Y	Y	100%	
5254	-36	Y	Y	Y	Y	Y	Y	Y	Y	Y	Y	100%	
5255	-35	Y	Y	Y	Y	Y	Y	Y	Y	Y	Y	100%	
5260	-30	Y	Y	Y	Y	Y	Y	Y	Y	Y	Y	100%	
5265	-25	Y	Y	Y	Y	Y	Y	Y	Y	Y	Y	100%	
5270	-20	Y	Y	Y	Y	Y	Y	Y	Y	Y	Y	100%	
5275	-15	Y	Y	Y	Y	Y	Y	N	Y	Y	Y	90%	
5380	-10	Y	Y	Y	Y	Y	Y	Y	Y	Y	Y	100%	
5285	-5	Y	Y	Y	Y	Y	Y	Y	Y	Y	Y	100%	
5290	0	Y	Y	Y	Y	Y	Y	Y	Y	Y	Y	100%	
5295	+5	Y	Y	Y	Y	Y	Y	Y	Y	Y	Y	100%	
5300	+10	Y	Y	N	Y	Y	Y	Y	Y	Y	Y	90%	
5305	+15	Y	Y	Y	Y	Y	Y	Y	Y	Y	Y	100%	
5310	+20	Y	Y	Y	Y	Y	Y	Y	Y	Y	Y	100%	
5315	+25	Y	Y	Y	Y	Y	Y	Y	Y	Y	Y	100%	
5320	+30	Y	Y	Y	Y	Y	Y	Y	Y	Y	Y	100%	
5325	+35	Y	Y	Y	Y	Y	Y	Y	Y	Y	Y	100%	
5326	+36	Y	Y	Y	Y	Y	Y	Y	Y	Y	Y	100%	
5327	+37	Y	Y	Y	Y	Y	Y	Y	Y	Y	Y	100%	
5328	+38	Y	Y	Y	Y	Y	Y	Y	Y	Y	Y	100%	
5329	+39	Y	Y	Y	Y	Y	Y	Y	Y	Y	Y	100%	
5330	+40	Y	Y	Y	Y	Y	Y	Y	Y	Y	Y	100%	F _H
5331	+41	N	N	N	N	N	N	N	N	N	N	0%	

Detection Bandwidth = F_H – F_L = 5330 – 5250 = 80 MHz
EUT 99% Bandwidth = 77.41 MHz (Refer to channel 58)



<160MHz / 5250MHz >

Frequency (MHz)	Fc	Trial Number (Detection = Y, No Detection = N)										Rate (%)	F _H /F _L
		1	2	3	4	5	6	7	8	9	10		
5249	-1	N	N	N	N	N	N	N	N	N	N	0%	
5250	0	Y	Y	Y	Y	Y	Y	Y	Y	Y	Y	100%	F _L
5251	+1	Y	Y	Y	N	Y	Y	Y	Y	Y	Y	90%	
5252	+2	Y	Y	Y	Y	Y	Y	Y	Y	Y	Y	100%	
5253	+3	Y	Y	Y	Y	Y	Y	Y	Y	Y	Y	100%	
5254	+4	Y	Y	Y	Y	Y	Y	Y	Y	Y	Y	100%	
5255	+5	Y	Y	Y	Y	Y	Y	Y	Y	Y	Y	100%	
5260	+10	Y	Y	Y	Y	Y	Y	Y	Y	Y	Y	100%	
5265	+15	Y	Y	Y	Y	Y	Y	Y	Y	Y	Y	100%	
5270	+20	Y	Y	Y	Y	Y	Y	Y	Y	Y	Y	100%	
5275	+25	Y	Y	Y	Y	Y	Y	Y	Y	Y	Y	100%	
5280	+30	Y	Y	Y	Y	Y	Y	Y	Y	Y	Y	100%	
5285	+35	Y	Y	Y	Y	Y	Y	Y	Y	Y	Y	100%	
5290	+40	Y	Y	Y	Y	Y	Y	Y	Y	Y	Y	100%	
5295	+45	Y	Y	Y	Y	Y	Y	Y	Y	Y	Y	100%	
5300	+50	Y	Y	Y	Y	Y	Y	Y	Y	Y	Y	100%	
5305	+55	Y	Y	Y	Y	Y	Y	Y	Y	Y	Y	100%	
5310	+60	Y	Y	Y	Y	Y	Y	Y	Y	Y	Y	100%	
5315	+65	Y	Y	Y	Y	Y	Y	Y	Y	Y	Y	100%	
5320	+70	Y	Y	Y	Y	Y	Y	Y	Y	Y	Y	100%	
5325	+75	Y	Y	Y	Y	Y	Y	Y	Y	Y	Y	100%	
5326	+76	Y	Y	Y	Y	Y	Y	Y	Y	Y	Y	100%	
5327	+77	Y	Y	Y	Y	Y	Y	Y	Y	Y	Y	100%	
5328	+78	Y	Y	Y	Y	Y	Y	Y	Y	Y	Y	100%	
5329	+79	Y	Y	Y	Y	Y	Y	Y	Y	Y	N	90%	
5330	+80	Y	Y	Y	Y	Y	Y	Y	Y	Y	Y	100%	F _H
5331	+81	N	N	N	N	N	N	N	N	N	N	0%	

Detection Bandwidth = F_H – F_L = 5330 – 5250 = 80 MHz
EUT 99% Bandwidth = 156.01 MHz (Refer to channel 42+58)
Detection BW is greater than channel OBW which overlap with UNII-2a.



<20MHz / 5500MHz>

Frequency (MHz)	Fc	Trial Number (Detection = Y, No Detection = N)										Rate (%)	F _H /F _L
		1	2	3	4	5	6	7	8	9	10		
5489	-11	N	N	N	N	N	N	N	N	N	N	0%	
5490	-10	Y	Y	Y	Y	Y	Y	Y	Y	Y	Y	100%	F _L
5491	-9	Y	Y	Y	Y	Y	Y	Y	Y	Y	Y	100%	
5492	-8	Y	Y	Y	Y	Y	Y	Y	Y	Y	Y	100%	
5493	-7	Y	Y	Y	Y	Y	Y	Y	Y	Y	Y	100%	
5494	-6	Y	Y	Y	Y	Y	Y	Y	Y	Y	Y	100%	
5495	-5	Y	Y	Y	Y	Y	Y	Y	Y	Y	Y	100%	
5500	0	Y	Y	Y	Y	Y	Y	Y	Y	Y	Y	100%	
5505	+5	Y	Y	Y	Y	Y	Y	Y	Y	Y	Y	100%	
5506	+6	Y	Y	Y	Y	Y	Y	Y	Y	Y	Y	100%	
5507	+7	Y	Y	Y	Y	Y	Y	Y	Y	Y	Y	100%	
5508	+8	Y	Y	Y	Y	Y	Y	Y	Y	Y	Y	100%	
5509	+9	Y	Y	Y	Y	Y	Y	Y	Y	Y	Y	100%	
5510	+10	Y	Y	Y	Y	Y	Y	Y	Y	Y	Y	100%	F _H
5511	+11	N	N	N	N	N	N	N	N	N	N	0%	

Detection Bandwidth = F_H – F_L = 5510 – 5490 = 20 MHz
EUT 99% Bandwidth = 19.645 MHz (Refer to channel 100)



<40MHz / 5510MHz>

Frequency (MHz)	Fc	Trial Number (Detection = Y, No Detection = N)										Rate (%)	F _H /F _L
		1	2	3	4	5	6	7	8	9	10		
5489	-21	N	N	N	N	N	N	N	N	N	N	0%	
5490	-20	Y	Y	Y	Y	Y	Y	Y	Y	Y	Y	100%	F _L
5491	-19	Y	Y	Y	Y	Y	Y	Y	Y	Y	Y	100%	
5492	-18	Y	Y	Y	Y	Y	Y	Y	Y	Y	Y	100%	
5493	-17	Y	Y	Y	Y	Y	Y	Y	Y	Y	Y	100%	
5494	-16	Y	Y	Y	Y	Y	Y	Y	Y	Y	Y	100%	
5495	-15	Y	Y	Y	Y	Y	Y	Y	Y	Y	Y	100%	
5500	-10	Y	Y	Y	Y	Y	Y	Y	Y	Y	Y	100%	
5505	-5	Y	Y	Y	Y	Y	Y	Y	Y	Y	Y	100%	
5510	0	Y	Y	Y	Y	Y	Y	Y	Y	Y	Y	100%	
5515	+5	Y	Y	Y	Y	Y	Y	Y	Y	Y	Y	100%	
5520	+10	Y	Y	Y	Y	Y	Y	Y	Y	Y	Y	100%	
5525	+15	Y	Y	Y	Y	Y	Y	Y	Y	Y	Y	100%	
5526	+16	Y	Y	Y	Y	Y	Y	Y	Y	Y	Y	100%	
5527	+17	Y	Y	Y	Y	Y	Y	Y	Y	Y	Y	100%	
5528	+18	Y	Y	Y	Y	Y	Y	Y	Y	Y	Y	100%	
5529	+19	Y	Y	Y	Y	Y	Y	Y	Y	Y	Y	100%	
5530	+20	Y	Y	Y	Y	Y	Y	Y	Y	Y	Y	100%	F _H
5531	+21	N	N	N	N	N	N	N	N	N	N	0%	

Detection Bandwidth = F_H – F_L = **5530 – 5490 = 40 MHz**
EUT 99% Bandwidth = 38.105 MHz (Refer to channel 102)



<80MHz / 5530MHz>

Frequency (MHz)	Fc	Trial Number (Detection = Y, No Detection = N)										Rate (%)	F _H /F _L
		1	2	3	4	5	6	7	8	9	10		
5489	-41	N	N	N	N	N	N	N	N	N	N	0%	
5490	-40	Y	Y	Y	Y	Y	Y	Y	Y	Y	Y	100%	F _L
5491	-39	Y	Y	Y	Y	Y	Y	Y	Y	Y	Y	100%	
5492	-38	Y	Y	Y	Y	Y	Y	Y	Y	Y	Y	100%	
5493	-37	Y	Y	Y	Y	Y	Y	Y	Y	Y	Y	100%	
5494	-36	Y	Y	Y	Y	Y	Y	Y	Y	Y	Y	100%	
5495	-35	Y	Y	Y	Y	Y	Y	Y	Y	Y	Y	100%	
5500	-30	Y	Y	Y	Y	Y	Y	Y	Y	Y	Y	100%	
5505	-25	Y	Y	Y	Y	Y	Y	Y	Y	Y	Y	100%	
5510	-20	Y	Y	Y	Y	Y	Y	Y	Y	Y	Y	100%	
5515	-15	Y	Y	Y	Y	Y	Y	Y	Y	Y	Y	100%	
5520	-10	Y	Y	Y	Y	Y	Y	Y	Y	Y	Y	100%	
5525	-5	Y	Y	Y	Y	Y	Y	Y	Y	Y	Y	100%	
5530	0	Y	Y	Y	Y	Y	Y	Y	Y	Y	Y	100%	
5535	+5	Y	Y	Y	Y	Y	Y	Y	Y	Y	Y	100%	
5540	+10	Y	Y	Y	Y	Y	Y	Y	Y	Y	Y	100%	
5545	+15	Y	Y	Y	Y	Y	Y	Y	Y	Y	Y	100%	
5550	+20	Y	Y	Y	Y	Y	Y	Y	Y	Y	Y	100%	
5555	+25	Y	Y	Y	Y	Y	Y	Y	Y	Y	Y	100%	
5560	+30	Y	Y	Y	Y	Y	Y	Y	Y	Y	Y	100%	
5565	+35	Y	Y	Y	Y	Y	Y	Y	Y	Y	Y	100%	
5566	+36	Y	Y	Y	Y	Y	Y	Y	Y	Y	Y	100%	
5567	+37	Y	Y	Y	Y	Y	Y	Y	Y	Y	Y	100%	
5568	+38	Y	Y	Y	Y	Y	Y	Y	Y	Y	Y	100%	
5569	+39	Y	Y	Y	Y	Y	Y	Y	Y	Y	Y	100%	
5570	+40	Y	Y	Y	Y	Y	Y	Y	Y	Y	Y	100%	F _H
5571	+41	N	N	N	N	N	N	N	N	N	N	0%	

Detection Bandwidth = F_H – F_L = 5570 – 5490 = 80 MHz
EUT 99% Bandwidth = 77.457 MHz (Refer to channel 106)



<160MHz / 5570MHz>

Frequency (MHz)	Fc	Trial Number (Detection = Y, No Detection = N)										Rate (%)	F _H /F _L
		1	2	3	4	5	6	7	8	9	10		
5489	-81	N	N	N	N	N	N	N	N	N	N	0%	
5490	-80	Y	Y	Y	Y	Y	Y	Y	Y	Y	Y	100%	F _L
5491	-79	Y	Y	Y	Y	Y	Y	Y	Y	Y	Y	100%	
5492	-78	Y	Y	Y	Y	Y	Y	Y	Y	Y	Y	100%	
5493	-77	Y	Y	Y	Y	Y	Y	Y	Y	Y	Y	100%	
5494	-76	Y	Y	Y	Y	Y	Y	Y	Y	Y	Y	100%	
5495	-75	Y	Y	Y	Y	Y	Y	Y	Y	Y	Y	100%	
5500	-70	Y	Y	Y	Y	Y	Y	Y	Y	Y	Y	100%	
5505	-65	Y	Y	Y	Y	Y	Y	Y	Y	Y	Y	100%	
5510	-60	Y	Y	Y	Y	Y	Y	Y	Y	Y	Y	100%	
5515	-55	Y	Y	Y	Y	Y	Y	Y	Y	Y	Y	100%	
5520	-50	Y	Y	Y	Y	Y	Y	Y	Y	Y	Y	100%	
5525	-45	Y	Y	Y	Y	Y	Y	Y	Y	Y	Y	100%	
5530	-40	Y	Y	Y	Y	Y	Y	Y	Y	Y	Y	100%	
5535	-35	Y	Y	Y	Y	Y	Y	Y	Y	Y	Y	100%	
5540	-30	Y	Y	Y	Y	Y	Y	Y	Y	Y	Y	100%	
5545	-25	Y	Y	Y	Y	Y	Y	Y	Y	Y	Y	100%	
5550	-20	Y	Y	Y	Y	Y	Y	Y	Y	Y	Y	100%	
5555	-15	Y	Y	Y	Y	Y	Y	Y	Y	Y	Y	100%	
5560	-10	Y	Y	Y	Y	Y	Y	Y	Y	Y	Y	100%	
5565	-5	Y	Y	Y	Y	Y	Y	Y	Y	Y	Y	100%	
5570	0	Y	Y	Y	Y	Y	Y	Y	Y	Y	Y	100%	
5575	5	Y	Y	Y	Y	Y	Y	Y	Y	Y	Y	100%	
5580	10	Y	Y	Y	Y	Y	Y	Y	Y	Y	Y	100%	
5585	15	Y	Y	Y	Y	Y	Y	Y	Y	Y	Y	100%	
5590	20	Y	Y	Y	Y	Y	Y	Y	Y	Y	Y	100%	
5595	25	Y	Y	Y	Y	Y	Y	Y	Y	Y	Y	100%	
5600	30	Y	Y	Y	Y	Y	Y	Y	Y	Y	Y	100%	
5605	35	Y	Y	Y	Y	Y	Y	Y	Y	Y	Y	100%	
5610	40	Y	Y	Y	Y	Y	Y	Y	Y	Y	Y	100%	



Frequency (MHz)	Fc	Trial Number (Detection = Y, No Detection = N)										Rate (%)	F _H /F _L
		1	2	3	4	5	6	7	8	9	10		
5615	45	Y	Y	Y	Y	Y	Y	Y	Y	Y	Y	100%	
5620	50	Y	Y	Y	Y	Y	Y	Y	Y	Y	Y	100%	
5625	55	Y	Y	Y	Y	Y	Y	Y	Y	Y	Y	100%	
5630	60	Y	Y	Y	Y	Y	Y	Y	Y	Y	Y	100%	
5635	65	Y	Y	Y	Y	Y	Y	Y	Y	Y	Y	100%	
5640	70	Y	Y	Y	Y	Y	Y	Y	Y	Y	Y	100%	
5645	75	Y	Y	Y	Y	Y	Y	Y	Y	Y	Y	100%	
5646	76	Y	Y	Y	Y	Y	Y	Y	Y	Y	Y	100%	
5647	77	Y	Y	Y	Y	Y	Y	Y	Y	Y	Y	100%	
5648	78	Y	Y	Y	Y	Y	Y	Y	Y	Y	Y	100%	
5649	79	Y	Y	Y	Y	Y	Y	Y	Y	Y	Y	100%	
5650	80	Y	Y	Y	Y	Y	Y	Y	Y	Y	Y	100%	F _H
5651	81	N	N	N	N	N	N	N	N	N	N	0%	

Detection Bandwidth = F_H – F_L = **5650 – 5490 = 160 MHz**
EUT 99% Bandwidth = 156.49 MHz (Refer to channel 106+122)



3.3 Channel Availability Check

3.3.1 Limit of Channel Availability Check

The Initial Channel Availability Check Time tests that the EUT does not emit beacon, control, or data signals on the test Channel until the power-up sequence has been completed and the U-NII device checks for radar waveforms for **one minute** on the test Channel.

3.3.2 Test Procedures of Initial Channel Availability Check Time

This test does not use any radar waveforms and only needs to be performed one time.

- (1) The U-NII devices will be powered on and be instructed to operate on the appropriate U-NII Channel that must incorporate DFS functions. At the same time the EUT is powered on, the spectrum analyzer will be set to zero span mode with a 3 MHz RBW and 3 MHz VBW on the Channel occupied by the radar (Chr) with at least a 2.5 minute sweep time. The spectrum analyzer's sweep will be started at the same time power is applied to the U-NII device.
- (2) The EUT should not transmit any beacon or data transmissions until at least 1 minute after the completion of the power-on cycle.

3.3.3 Radar Burst at the Beginning of the Channel Availability Check Time

The steps below define the procedure to verify successful radar detection on the test Channel during a period equal to the Channel Availability Check Time and avoidance of operation on that Channel when a radar Burst with a level equal to the DFS Detection Threshold + 1 dB occurs at the beginning of the Channel Availability Check Time. This is illustrated in Figure 15.

- (1) The Radar Waveform generator and EUT are connected using the applicable test setup and the power of the EUT is switched off.
- (2) The EUT is powered on at T_0 . T_1 denotes the instant when the EUT has completed its power-up sequence (T_{power_up}). The Channel Availability Check Time commences on Chr at instant T_1 and will end no sooner than $T_1 + T_{ch_avail_check}$.
- (3) A single Burst of one of the Short Pulse Radar Types 1-4 will commence within a 6 second window starting at T_1 . An additional 1 dB is added to the radar test signal to ensure it is at or above the DFS Detection Threshold, accounting for equipment variations/errors.
- (4) Visual indication or measured results on the EUT of successful detection of the radar Burst will be recorded and reported. Observation of Chr for EUT emissions will continue for 2.5 minutes after the radar Burst has been generated.
- (5) Verify that during the 2.5 minute measurement window no EUT transmissions occurred on Chr. The Channel Availability Check results will be recorded.

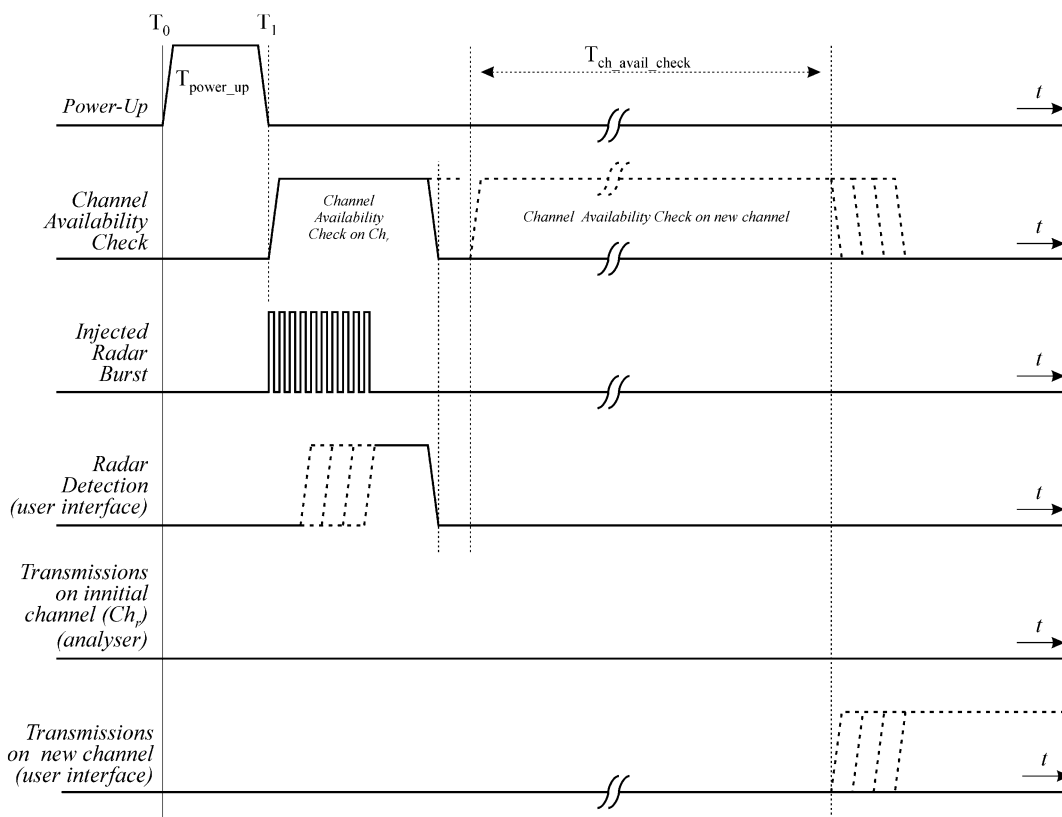

Figure 15: Example of timing for radar testing at the beginning of the Channel Availability Check Time

3.3.4 Radar Burst at the End of the Channel Availability Check Time

The steps below define the procedure to verify successful radar detection on the test Channel during a period equal to the Channel Availability Check Time and avoidance of operation on that Channel when a radar Burst with a level equal to the DFS Detection Threshold + 1dB occurs at the end of the Channel Availability Check Time. This is illustrated in Figure 16.

- (1) The Radar Waveform generator and EUT are connected using the applicable test setup and the power of the EUT is switched off.
- (2) The EUT is powered on at T_0 . T_1 denotes the instant when the EUT has completed its power-up sequence (T_{power_up}). The Channel Availability Check Time commences on Chr at instant T_1 and will end no sooner than $T_1 + T_{ch_avail_check}$.
- (3) A single Burst of one of the Short Pulse Radar Types 1-4 will commence within a 6 second window starting at $T_1 + 54$ seconds. An additional 1 dB is added to the radar test signal to ensure it is at or above the DFS Detection Threshold, accounting for equipment variations/errors.
- (4) Visual indication or measured results on the EUT of successful detection of the radar Burst will be recorded and reported. Observation of Chr for EUT emissions will continue for 2.5 minutes after the radar Burst has been generated.
- (5) Verify that during the 2.5 minute measurement window no EUT transmissions occurred on Chr. The Channel Availability Check results will be recorded.

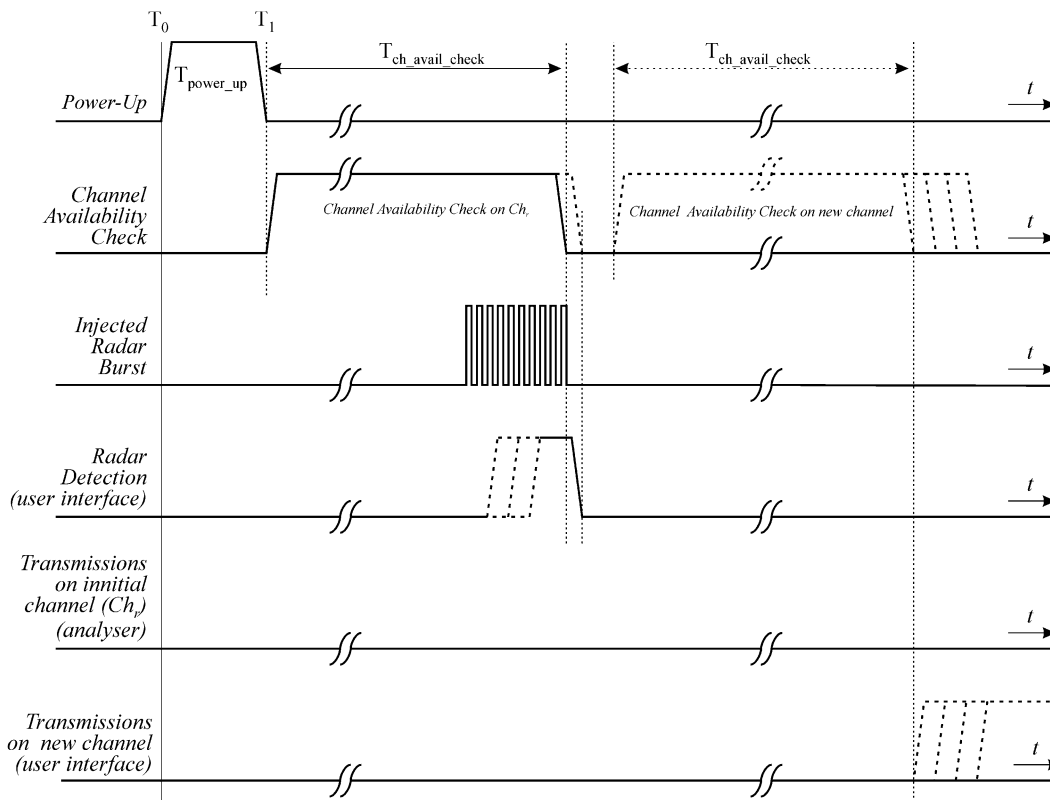
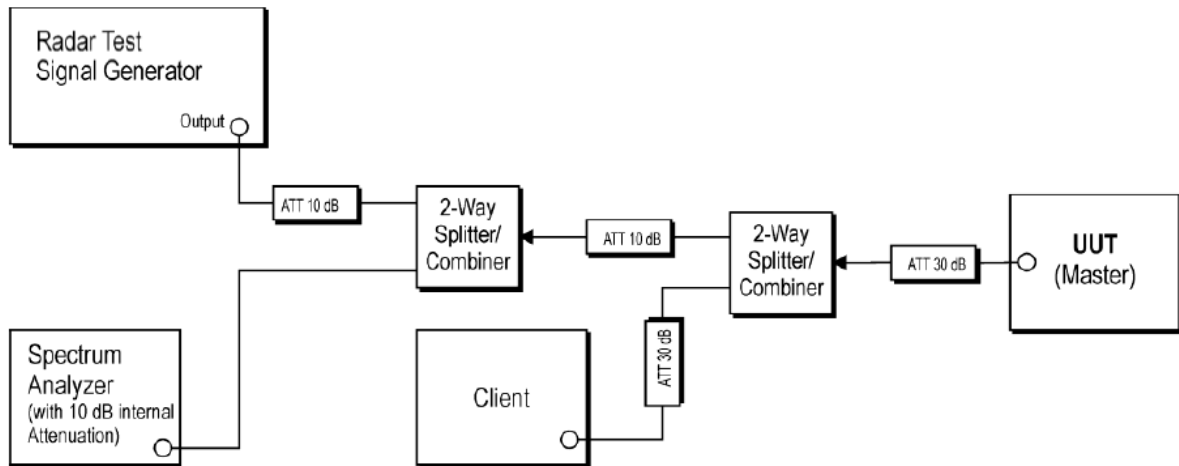

Figure 16: Example of timing for radar testing towards the end of the Channel Availability Check Time

3.3.5 Test Setup



3.3.6 Test Deviation

There is no deviation with the original standard.



3.3.7 Result of Channel Availability Check Time

<160MHz / 5250MHz> (Radar injected on 5290MHz)

EUT Power up and Initial Channel Availability Check Time

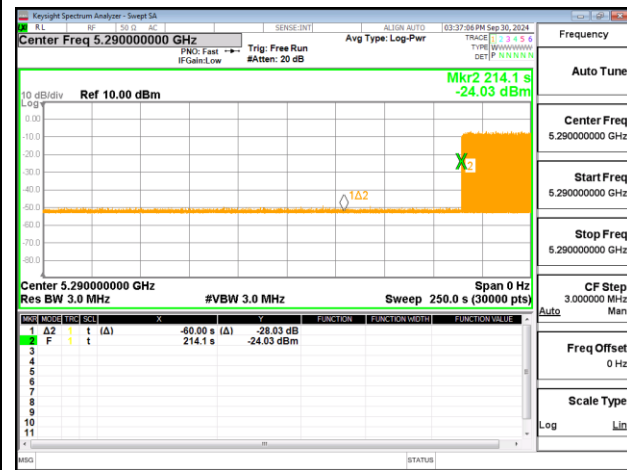

Radar Burst at the Beginning of the Channel Availability Check Time



Radar Burst at the End of the Channel Availability Check Time



Marker 1(Delta 2): 60 seconds before End of Channel Availability Check

Marker 2: End of Channel Availability Check

Marker 3: 54 seconds or 6 seconds before End of Channel Availability Check



<160MHz / 5570MHz>

EUT Power up and Initial Channel Availability Check Time



Radar Burst at the Beginning of the Channel Availability Check Time

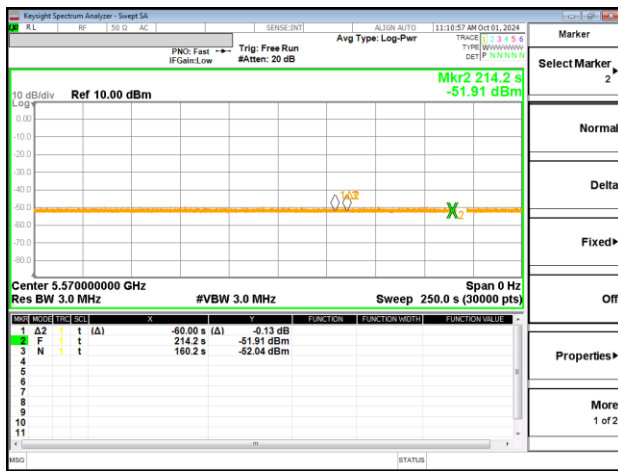

Radar Burst at the End of the Channel Availability Check Time



- Marker 1(Delta 2): 60 seconds before End of Channel Availability Check
- Marker 2: End of Channel Availability Check
- Marker 3: 54 seconds or 6 seconds before End of Channel Availability Check



3.4 In-Service Monitoring: Channel Move Time, Channel Closing Transmission Time and Non-Occupancy Period

3.4.1 Limit of In-Service Monitoring

The EUT has In-Service Monitoring function to continuously monitor the radar signals, If radar is detected, it must leave the channel (Shutdown). The Channel Move Time to cease all transmissions on the current Channel upon detection of a Radar Waveform above the DFS Detection Threshold within 10 sec. The total duration of Channel Closing Transmission Time is comprised of 200 milliseconds starting at the beginning of the Channel Move Time plus any additional intermittent control signals required to facilitate Channel changes (an aggregate of 60 milliseconds) during the remainder of the 10 second period. The aggregate duration of control signals will not count quiet periods in between transmissions.

Non-Occupancy Period time is 30 minute during which a Channel will not be utilized after a Radar Waveform is detected on that Channel.

3.4.2 Test Procedures

- (1) One frequency will be chosen from the Operating Channels of the EUT within the 5250-5350 MHz or 5470-5725 MHz bands. For 802.11 devices, the test frequency must contain control signals. This can be verified by disabling channel loading and monitoring the spectrum analyzer. If no control signals are detected, another frequency must be selected within the emission bandwidth where control signals are detected.
- (2) In case the EUT is a Master Device, a U-NII device operating as a Client Device will be used and it is assumed that the Client will associate with the EUT (Master). For radiated tests, the emissions of the Radar Waveform generator will be directed towards the Master Device. If the Master Device has antenna gain, the main beam of the antenna will be directed toward the radar emitter. Vertical polarization is used for testing.
- (3) The TCP protocol unicast data stream was generated by the iperf software command line with at least 17% activity ratio over any 100ms period.
- (4) Timing plots are reported with calculations demonstrating a minimum channel loading of approximately 17% or greater. For example, channel loading can be estimated by setting the spectrum analyzer for zero span and approximate the Time On/ (Time On + Off Time).
- (5) At time T0 the Radar Waveform generator sends a Burst of pulses for one of the Short Pulse Radar Types 1-4 at DFS Detection Threshold levels on the Operating Channel. An additional 1 dB is added to the radar test signal to ensure it is at or above the DFS Detection Threshold, accounting for equipment variations/errors.
- (6) Observe the transmissions of the EUT at the end of the radar Burst on the Operating Channel for duration greater than 10 seconds. Measure and record the transmissions from the EUT during the observation time (Channel Move Time). Measure and record the Channel Move Time and Channel Closing Transmission Time if radar detection occurs.

- (7) When operating as a Master Device, monitor the EUT for more than 30 minutes following instant T2 to verify that the EUT does not resume any transmissions on this Channel. Perform this test once and record the measurement result.

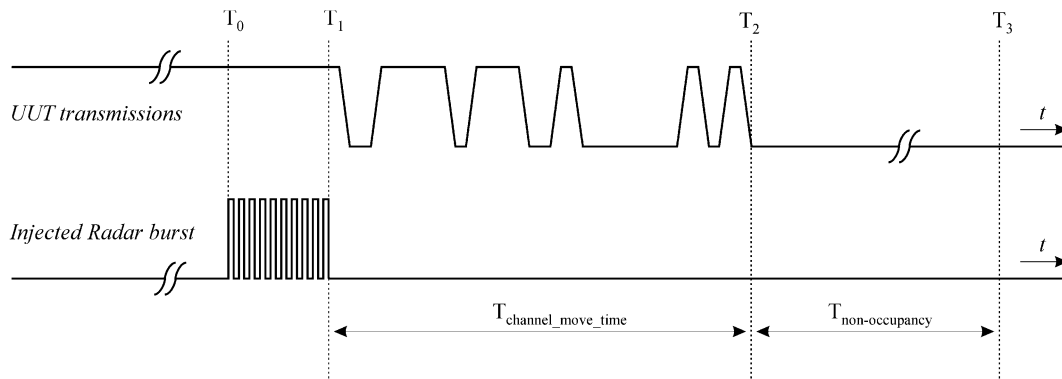

- (8) One 12 seconds plot is reported for the Short Pulse Radar Type 0.
- (9) Measurement of the aggregate duration of the Channel Closing Transmission Time method. With the spectrum analyzer set to zero span tuned to the center frequency of the EUT operating channel at the radar simulated frequency, peak detection, and max hold, the dwell time per bin is given by: $Dwell (0.4ms) = S (12000ms) / B (30000)$; where Dwell is the dwell time per spectrum analyzer sampling bin, S is the sweep time and B is the number of spectrum analyzer sampling bins. An upper bound of the aggregate duration of the intermittent control signals of Channel Closing Transmission Time is calculated by: $C (ms) = N \times Dwell (0.4 ms)$; where C is the Closing Time, N is the number of spectrum analyzer sampling bins (intermittent control signals) showing a U-NII transmission and Dwell is the dwell time per bin.

3.4.3 Test Setup

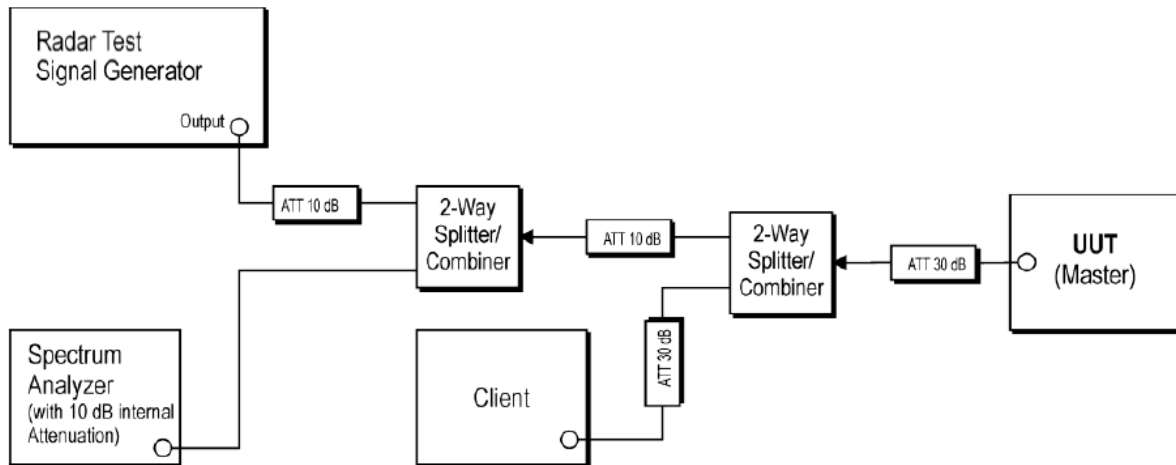

3.4.4 Test Deviation

There is no deviation with the original standard.



3.4.5 Result of Channel Move Time, Channel Closing Transmission Time and Non-Occupancy Period for Client Beacon Test

Test Mode :	Master	Temperature :	20.7~22.1°C
Test Engineer :	Liliana Gonzalez	Relative Humidity :	47.1~58%

BW / Channel	Test Item	Test Result	Limit	Pass/Fail
160MHz / 5250MHz	Channel Move Time	0.4132 s	< 10s	Pass
	Channel Closing Transmission Time	200ms + 2.8003 ms	< 260ms	Pass
	Non-Occupancy Period	≥ 30	≥ 30 min	Pass
160MHz / 5570MHz	Channel Move Time	0.3292 s	< 10s	Pass
	Channel Closing Transmission Time	200ms + 3.6004 ms	< 260ms	Pass
	Non-Occupancy Period	≥ 30	≥ 30 min	Pass

Note: The Channel Closing Transmission Time is comprised of 200 milliseconds starting at the beginning of the Channel Move Time plus any additional intermittent control signals required to facilitate a Channel move (an aggregate of 60 milliseconds) during the remainder of the 10 seconds period. The aggregate duration of control signals will not count quiet periods in between transmissions.



3.4.6 Channel Move Time, Channel Closing Transmission Time and Non-Occupancy Period Test Plots

<160MHz / 5250MHz > (Radar injected on 5290MHz) In-Service Monitoring

Channel Move Time & Channel Closing Transmission Time

Marker 1: signal found within channel moving time.
Marker 2: 200ms after radar injected ; Marker 3: 10s after radar injected.

MKR	MODE	TRC	SCL	X	Y	FUNCTION	FUNCTION WIDTH	FUNCTION VALUE
1	N	1	t	413.2 ms	-3.66 dBm			
2	N	1	t	200.0 ms	-48.54 dBm			
3	N	1	t	10.00 s	-49.57 dBm			

DFS & Adaptivity Test Tools Ver1.0 (2015-05-22)

Option

Trigger Level(dBm):	MK1 Time(s)	MK2 Time(s)	Delta2 Time(s)
-40	200.0000ms	10000.0000s	9800.0000m
On Time Point:	Total Point:	Sum of On Time(s):	
7	24497	2.8003ms	
Sweep Time(s)	Sweep Point	Duty Cycle(%):	
12001.60ms	30000	0.0286%	

Run

耕興股份有限公司
 SPORTON INTERNATIONAL INC.
 Copyright (c) 2013 by Sporton Lab.

Note:

Dwell (0.4 ms)= Sweep Time (12000 ms) / Sweep Point Bins (30000)

Channel Closing Transmission Time (200 + 2.8 ms) = 200 + Number (7) X Dwell (0.4 ms) < 260ms



Non-Occupancy Period

Marker 2: radar injected ; Delta 1: 30 minutes after radar injected





<160MHz / 5570MHz > In-Service Monitoring

Channel Move Time & Channel Closing Transmission Time

Marker 1: signal found within channel moving time.

Marker 2: 200ms after radar injected ; Marker 3: 10s after radar injected.

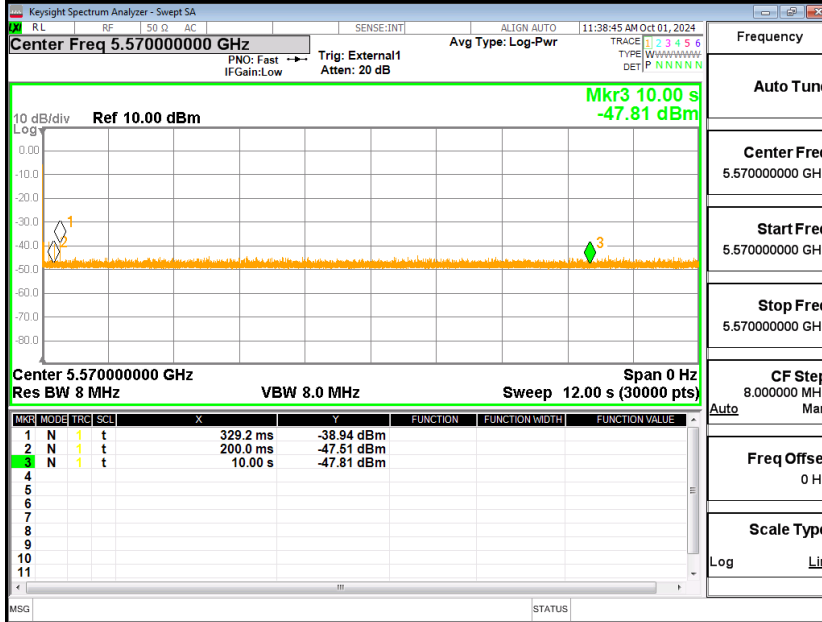

DFS & Adaptivity Test Tools Ver1.0 (2015-05-22)

Option

Trigger Level(dBm):	MK1 Time(s)	MK2 Time(s)	Delta2 Time(s)
-40	200.0000ms	10000.0000s	9800.0000ms
On Time Point:	Total Point:	Sum of On Time(s):	
9	24497	3.6004ms	
Sweep Time(s)	Sweep Point	Duty Cycle(%):	
12001.60ms	30000	0.0367%	

Run

耕興股份有限公司
SPORTON INTERNATIONAL INC.
Copyright (c) 2013 by Sporton Lab.

Note:

Dwell (0.4 ms)= Sweep Time (12000 ms) / Sweep Point Bins (30000)

Channel Closing Transmission Time (200 + 3.6 ms) = 200 + Number (9) X Dwell (0.4 ms) < 260ms



Non-Occupancy Period

Marker 2: radar injected ; Delta 1: 30 minutes after radar injected





3.4.7 Long Pulsed Radar Type Channel Move Time Test Plots (22second)

<160MHz / 5250MHz > (Radar injected on 5290MHz) Radar Type 5

Channel Move Time

Marker 1: End of transmission time ; Marker 2: 22seconds after radar injected

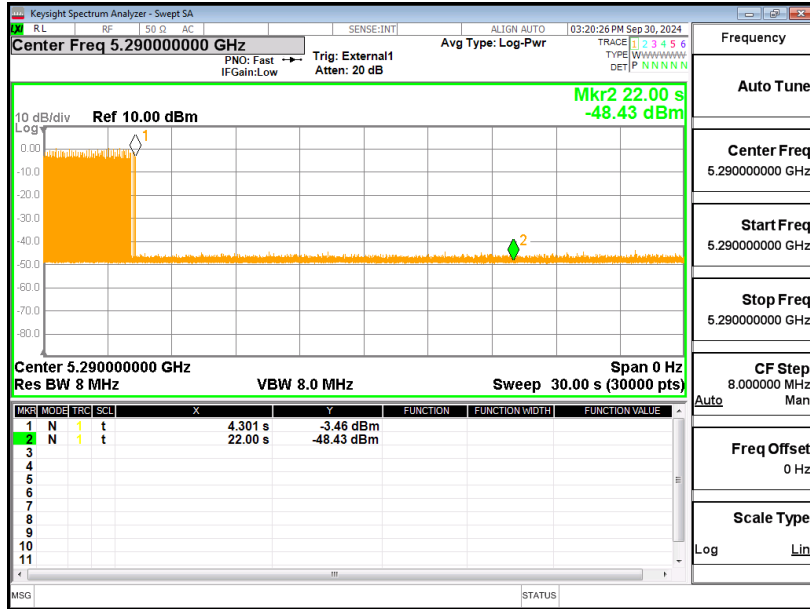

<160MHz / 5570MHz > Radar Type 5

Channel Move Time

Marker 1: End of transmission time ; Marker 2: 22seconds after radar injected

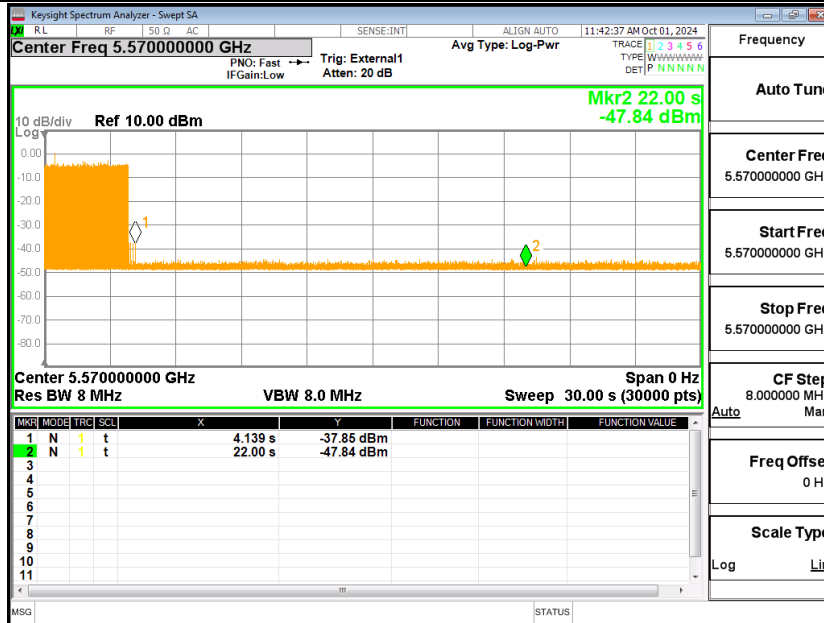



3.4.8 Data Traffic Channel Loading and Noise Floor Plots

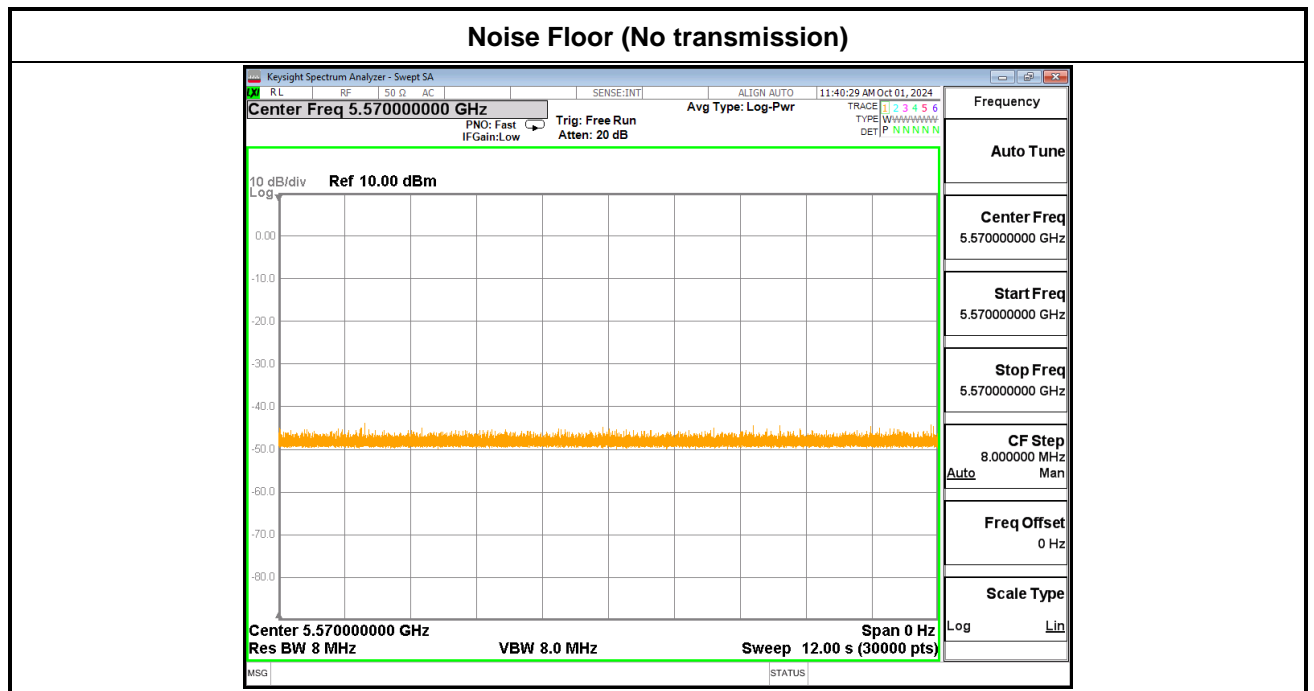
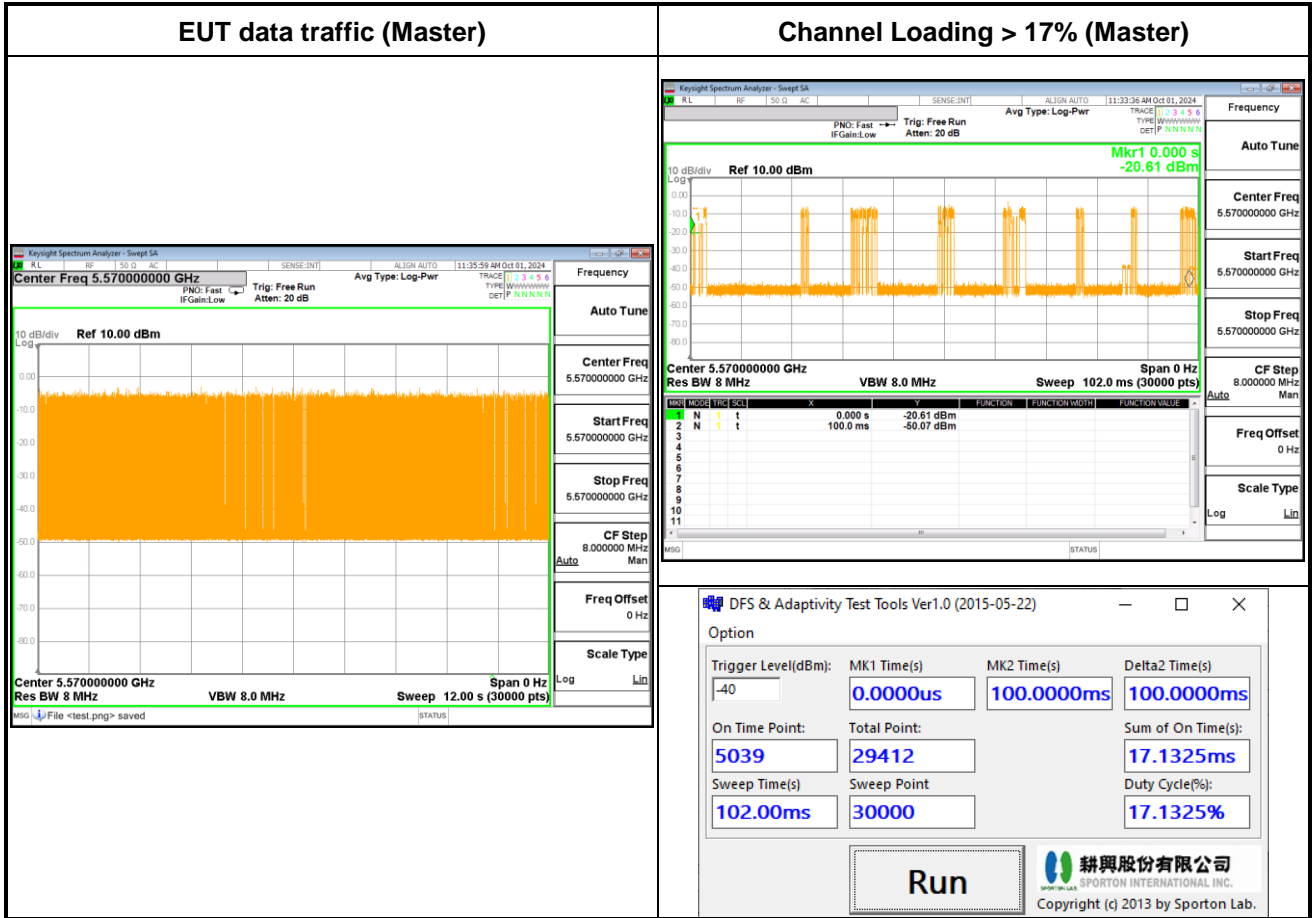



3.5 Statistical Performance Check

3.5.1 Limit of Statistical Performance Check

Short Pulse Radar Test

Once the performance requirements check is complete, statistical data will be gathered, to determine the ability of the device to detect the radar test waveforms (Short Pulse Radar Types 1-4) found in **Table 5**. The device can utilize a test mode to demonstrate when detection occurs to prevent the need to reset the device between trials. The percentage of successful detection is calculated by:

$$\frac{\text{TotalWaveformDetections}}{\text{TotalWaveformTrials}} \times 100 = \text{Percentage of Successful Detection Radar Waveform N} = P_dN$$

In addition an aggregate minimum percentage of successful detection across all Short Pulse Radar Types 1-4 is required and is calculated as follows:

$$\frac{P_d 1 + P_d 2 + P_d 3 + P_d 4}{4}$$

The minimum number of trails, minimum percentage of successful detection and the aggregate minimum percentage of successful detection are found in **Table 5**.

Table 5 – Short Pulse Radar Test Waveforms

Radar Type	Pulse Width (µsec)	PRI (µsec)	Number of Pulses	Minimum Percentage of Successful Detection	Minimum Number of Trials
1	1	1428	18	60%	30
2	1-5	150-230	23-29	60%	30
3	6-10	200-500	16-18	60%	30
4	11-20	200-500	12-16	60%	30
Aggregate (Radar Types 1-4)				80%	120



A minimum of 30 unique waveforms are required for each of the Short Pulse Radar Types 1 through 4. For Short Pulse Radar Type 0, the same waveform is used a minimum of 30 times. If more than 30 waveforms are used for Short Pulse Radar Types 1 through 4, then each additional waveform must also be unique and not repeated from the previous waveforms.

An example of aggregate detection probability calculation is listed in following table:

Radar Type	Number of Trials	Number of Successful Detections	Percentage of Successful Detection
1	30	29	96.7%
2	30	18	60%
3	30	27	90%
4	30	30	100%
Aggregate $(96.7\% + 60\% + 90\% + 100\%)/4 = 86.67\%$			