

TEST REPORT

DT&C Co., Ltd.

42, Yurim-ro, 154Beon-gil, Cheoin-gu, Yongin-si,
Gyeonggi-do, Korea
Tel : 031-321-2664, Fax : 031-321-1664

Report No : DRTFCC1512-0248
Pages:(1) / (87) page

**1. Customer**

- Name : Sena Technologies, Inc.
- Address : 19, Heolleung-ro 569-gil, Gangnam-gu, Seoul, Korea

2. Use of Report : FCC & IC Original Grant**3. Product Name (FCCID / IC): Bluetooth Stereo Motorcycle Headset (S7A-SP26 / 8154A-SP26)****4. Date of Test : 2015-10-05 ~ 2015-10-29****5. Test Method Used: FCC Part 15 Subpart C.247**

RSS-247 Issue 1 (2015-05), RSS-GEN Issue 4 (2014-11)

6. Testing Environment : See appended test report**7. Test Result : Pass Fail**

The results shown in this test report refer only to the sample(s) tested unless otherwise stated. This Test Report cannot be reproduced, except in full.

Affirmation	Tested by	Technical Manager
	Name : JungWoo Kim (Signature)	Name : GeunKi Son (Signature)

2015. 12. 08.

DT&C Co., Ltd.

Test Report Version

Test Report No.	Date	Description
DRTFCC1512-0248	Dec. 08, 2015	Initial issue

Table of Contents

- 1. General Information 4**
 - 1.1 Testing Laboratory4
 - 1.2 Details of Applicant4
 - 1.3 Description of EUT4
 - 1.4 Declaration by the applicant / manufacturer5
 - 1.5 Information about the FHSS characteristics5
 - 1.6 Test conditions5
 - 1.7 Test Equipment List.....6
 - 1.8 Summary of Test Results.....7
 - 1.9 Conclusion of worst-case and operation mode.....8
- 2. Maximum Peak Output Power Measurement 9**
 - 2.1 Test Setup9
 - 2.2 Limit.....9
 - 2.3 Test Procedure.....9
 - 2.4 Test Results10
- 3. 20 dB BW 16**
 - 3.1 Test Setup16
 - 3.2 Limit.....16
 - 3.3 Test Procedure.....16
 - 3.4 Test Results16
- 4. Carrier Frequency Separation 22**
 - 4.1 Test Setup22
 - 4.2 Limit.....22
 - 4.3 Procedure.....22
 - 4.4 Test Results22
- 5. Number of Hopping Frequencies 27**
 - 5.1 Test Setup27
 - 5.2 Limit.....27
 - 5.3 Procedure.....27
 - 5.4 Test Results27
- 6. Time of Occupancy (Dwell Time)..... 33**
 - 6.1 Test Setup33
 - 6.2 Limit.....33
 - 6.3 Test Procedure.....33
 - 6.4 Test Results33
- 7. Transmitter Radiated Spurious Emissions and Conducted Spurious Emission 38**
 - 7.1 Test Setup38
 - 7.2 Limit.....38
 - 7.3. Test Procedures.....39
 - 7.3.1. Test Procedures for Radiated Spurious Emissions39
 - 7.3.2. Test Procedures for Conducted Spurious Emissions.....39
 - 7.4. Test Results40
 - 7.4.1. Radiated Emissions.....40
 - 7.4.2. Conducted Spurious Emissions43
- 8. Transmitter AC Power Line Conducted Emission 67**
 - 8.1 Test Setup67
 - 8.2 Limit.....67
 - 8.3 Test Procedures.....67
 - 8.4 Test Results68
- 9. Antenna Requirement 70**
- 10. Occupied Bandwidth (99 %) 71**
 - 10.1 Test Setup71
 - 10.2 Limit.....71
 - 10.3 Test Procedure.....71
 - 10.4 Test Results71
- APPENDIX I..... 78**
- APPENDIX II..... 79**

1. General Information

1.1 Testing Laboratory

DT&C Co., Ltd.			
Standard	Site number	Address	
FCC	<input checked="" type="checkbox"/>	165783	42, Yurim-ro 154 beon-gil, Cheoin -gu, Yongin-si, Gyeonggi -do, South Korea 449-935
	<input type="checkbox"/>	804488	42, Yurim-ro 154 beon-gil, Cheoin -gu, Yongin-si, Gyeonggi -do, South Korea 449-935
	<input type="checkbox"/>	596748	42, Yurim-ro 154 beon-gil, Cheoin -gu, Yongin-si, Gyeonggi -do, South Korea 449-935
	<input type="checkbox"/>	678747	683-3, Yubang-dong, Cheoin-gu, Yongin-si, Kyeonggi-do, Korea, 449-080
IC	<input checked="" type="checkbox"/>	5740A-3	42, Yurim-ro 154 beon-gil, Cheoin -gu, Yongin-si, Gyeonggi -do, South Korea 449-935
	<input type="checkbox"/>	5740A-2	683-3, Yubang-dong, Cheoin-gu, Yongin-si, Kyeonggi-do, Korea, 449-080
www.dtnc.net			
Telephone	:	+ 82-31-321-2664	
FAX	:	+ 82-31-321-1664	

1.2 Details of Applicant

Applicant : Sena Technologies, Inc.
 Address : 19, Heolleung-ro 569-gil, Gangnam-gu, Seoul, South Korea
 Contact person : Seunghyun KIM

1.3 Description of EUT

EUT	Bluetooth Stereo Motorcycle Headset
Model Name	10S
Serial Number	Identical prototype
Hardware version	1.0
Software version	1.0
Power Supply	DC 3.7 V
Battery type	Standard Battery: Lithium Ion Battery
Frequency Range	2402 MHz ~ 2480 MHz
Modulation Technique	GFSK, $\pi/4$ -DQPSK, 8DPSK
Number of Channels	79
Antenna Type	Chip Antenna
Antenna Gain	PK : 1.0 dBi

1.4 Declaration by the applicant / manufacturer

- NA

1.5 Information about the FHSS characteristics

- This Bluetooth module has been tested by a Bluetooth Qualification Lab, and we confirm the following :
 - A) The hopping sequence is pseudorandom
 - B) All channels are used equally on average
 - C) The receiver input bandwidth equals the transmit bandwidth
 - D) The receiver hops in sequence with the transmit signal
- 15.247(g) : In accordance with the Bluetooth Industry Standard, the system is designed to comply with all of the regulations in Section 15.247 when the transmitter is presented with a continuous data (or information) system.
- 15.247(h) : In accordance with the Bluetooth Industry Standard, the system does not coordinate its channels selection / hopping sequence with other frequency hopping systems for the express purpose of avoiding the simultaneous occupancy of individual hopping frequencies by multiple transmitters.
- 15.247(h) : The EUT employs Adaptive Frequency Hopping (AFH) which identifies sources of interference namely devices operating in 802.11 WLAN and excludes them from the list of available channels. The process of re-mapping reduces the number of test channels from 79 channels to a minimum number of 20 channels.

1.6 Test conditions

Ambient Condition	
▪ Temperature	+22 °C ~ +25 °C
▪ Relative Humidity	42 % ~ 47 %

1.7 Test Equipment List

Type	Manufacturer	Model	Cal.Date (yy/mm/dd)	Next.Cal.Date (yy/mm/dd)	S/N
MXA Signal Analyzer	Agilent	N9020A	15/09/14	16/09/14	MY50200834
DIGITAL MULTIMETER	Agilent	34401A	15/01/06	16/01/06	US36099541
Dynamic Measurement DC Source	Agilent	66332A	15/09/09	16/09/09	MY43000440
Vector Signal Generator	Rohde Schwarz	SMBV100A	15/01/06	16/01/06	255571
Signal Generator	Rohde Schwarz	SMF100A	15/06/29	16/06/29	102341
Thermohygrometer	BODYCOM	BJ5478	15/05/08	16/05/08	120612-2
50W 10dB ATT	SMAJK	SMAJK-50-10	14/10/21	15/10/21	3-50-10
			15/10/19	16/10/19	
LOOP Antenna	Schwarzbeck	FMZB1513	14/04/29	16/04/29	1513-128
TRILOG Broadband Test-Antenna(30MHz-1GHz)	Schwarzbeck	VULB 9160	14/04/30	16/04/30	3358
Double-Ridged Guide Antenna	ETS	3117	14/05/12	16/05/12	140394
Horn Antenna	A.H.Systems	SAS-574	15/04/30	17/04/30	154
Low Noise Pre Amplifier	tsj	MLA-010K01-B01-27	15/04/09	16/04/09	1844538
PreAmplifier	Agilent	8449B	15/02/26	16/02/26	3008A00370
EMI TEST RECEIVER	R&S	ESU	15/01/06	16/01/06	100014
High-pass filter	Wainwright Instruments	WHKX3.0	15/01/06	16/01/06	12
EMI TEST RECEIVER	R&S	ESCI	15/02/25	16/02/25	100364
SINGLE-PHASE MASTER	NF	4420	15/09/09	16/09/09	3049354420023
ARTIFICIAL MAINS NETWORK	Narda S.T.S. / PMM	PMM L2-16B	15/06/26	16/06/26	000WX20305
Power Meter & Wide Bandwidth Sensor	Anritsu	ML2495A MA2490A	15/03/26	16/03/26	1306007 1249001

1.8 Summary of Test Results

FCC Part RSS Std.	Parameter	Limit (Using in 2400~ 2483.5 MHz)	Test Condition	Status Note 1
15.247(a) RSS-247(5.1)	Carrier Frequency Separation	>= 20 dB BW or >= Two thirds of the 20 dB BW, whichever is greater.	Conducted	C
	Number of Hopping Frequencies	>= 15 hops		C
	20 dB Bandwidth	None		C
	Dwell Time	=< 0.4 seconds		C
15.247(b) RSS-247(5.4)	Transmitter Output Power	For FCC =< 1 Watt , if CHs >= 75 Others =< 0.125 W For IC if CHs >= 75 =< 1 Watt For Conducted Power =< 4 Watt For e.i.r.p, Others =< 0.125 W For Conducted Power. =< 0.5 Watt For e.i.r.p		C
15.247(d) RSS-247(5.5)	Conducted Spurious Emissions	The radiated emission to any 100 kHz of out-band shall be at least 20 dB below the highest in-band spectral density.		C
RSS Gen(6.6)	Occupied Bandwidth (99 %)	RSS-Gen		C
15.205 & 209 RSS-247(5.5) RSS-Gen (8.9 & 8.10)	Radiated Spurious Emissions	FCC 15.209 Limits RSS-Gen 8.9	Radiated	C ^{Note2}
15.207 RSS-Gen(8.8)	AC Conducted Emissions	FCC 15.207 Limits	AC Line Conducted	C
15.203 RSS-Gen(6.7)	Antenna Requirements	FCC 15.203	-	C

Note 1 : **C** = Comply **NC** = Not Comply **NT** = Not Tested **NA** = Not Applicable

Note 2 : This test item was performed in each axis and the worst case data was reported.

Note 3 : The sample was tested according to the following specifications :

- ANSI C63.10-2013

1.9 Conclusion of worst-case and operation mode

The EUT has three type of modulation (GFSK, $\pi/4$ DQPSK and 8DPSK).

Therefore all applicable requirements were tested with all the modulations.

The field strength of spurious emission was measured in three orthogonal EUT positions (X-axis, Y-axis and Z-axis).

Tested frequency information,

- Hopping Function : Enable

	TX Frequency (MHz)	RX Frequency (MHz)
Hopping Band	2402 ~ 2480	2402 ~ 2480

- Hopping Function : Disable

	TX Frequency (MHz)	RX Frequency (MHz)
Lowest Channel	2402	2402
Middle Channel	2441	2441
Highest Channel	2480	2480

2. Maximum Peak Output Power Measurement

2.1 Test Setup

Refer to the APPENDIX I.

2.2 Limit

■ FCC Requirements

The maximum peak output power of the intentional radiator shall not exceed the following :

1. §15.247(a)(1), Frequency hopping systems shall have hopping channel carrier frequencies separated by a minimum of 25 kHz or the 20 dB bandwidth of the hopping channel, whichever is greater, provided the systems operate with an output power no greater than 125 mW.
2. §15.247(b)(1), For frequency hopping systems operating in the 2400 – 2483.5 MHz employing at least 75 non-overlapping hopping channels, and all frequency hopping systems in the 5725 – 5805 MHz band : 1 Watt.

■ IC Requirements

1. RSS-247(5.4), For FHSs operating in the band 2400 - 2483.5 MHz, the maximum peak conducted output power shall not exceed 1.0 W and the e.i.r.p. shall not exceed 4 W if the hopset uses 75 or more hopping channels the maximum peak conducted output power shall not exceed 0.125 W and the e.i.r.p. shall not exceed 0.5 W if the hopset uses less than 75 hopping channels

2.3 Test Procedure

1. The RF output power was measured with a spectrum analyzer connected to the RF Antenna connector (conducted measurement) while EUT was operating in transmit mode at the appropriate center frequency, A spectrum analyzer was used to record the shape of the transmit signal.
2. The bandwidth of the fundamental frequency was measured with the spectrum analyzer using ;
Span = approximately 5 times of the 20 dB bandwidth, centered on a hopping channel
RBW \geq 20 dB BW
VBW \geq RBW
Sweep = auto
Detector function = peak
Trace = max hold

2.4 Test Results

Modulation	Tested Channel	Frame Average Output Power		Peak Output Power	
		dBm	mW	dBm	mW
<u>GFSK</u>	Lowest	3.94	2.477	5.34	3.420
	Middle	7.76	5.970	9.14	8.204
	Highest	6.61	4.581	8.21	6.622
<u>$\pi/4$DQPSK</u>	Lowest	1.72	1.486	7.34	5.420
	Middle	4.86	3.062	10.79	11.995
	Highest	3.84	2.421	9.69	9.311
<u>8DPSK</u>	Lowest	1.73	1.489	8.26	6.699
	Middle	4.88	3.076	11.57	14.355
	Highest	3.86	2.432	10.52	11.272

Note 1 : Average output power was using the average power meter for reference only.

Note 2 : See next pages for actual measured spectrum plots.

Peak Output Power

Lowest Channel & Modulation : GFSK

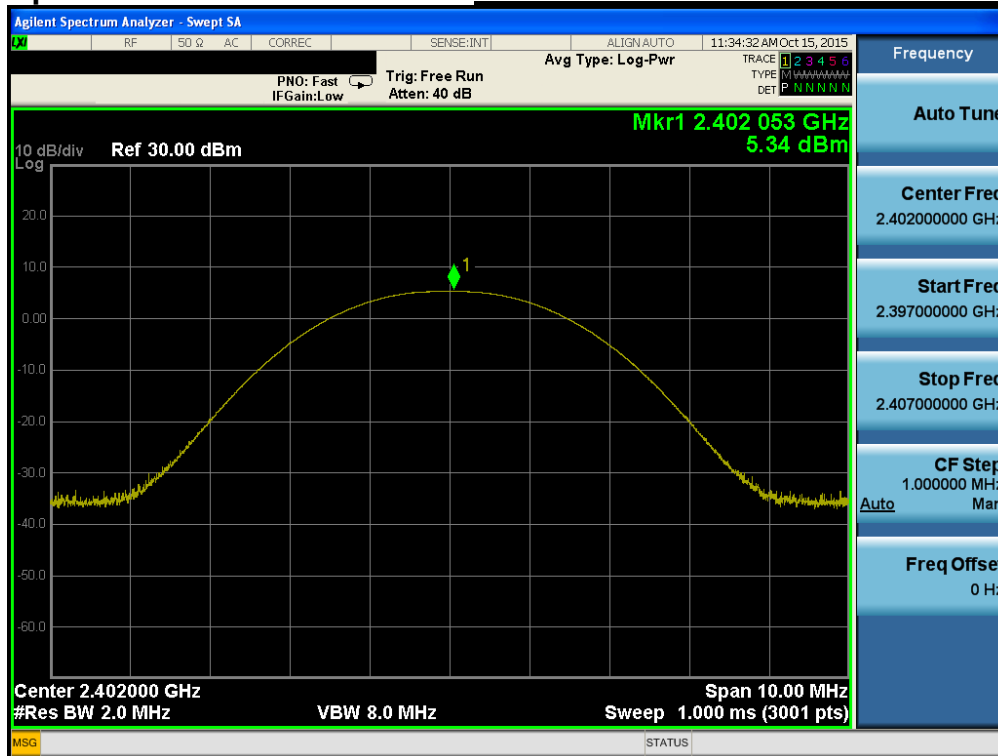

Peak Output Power

Middle Channel & Modulation : GFSK

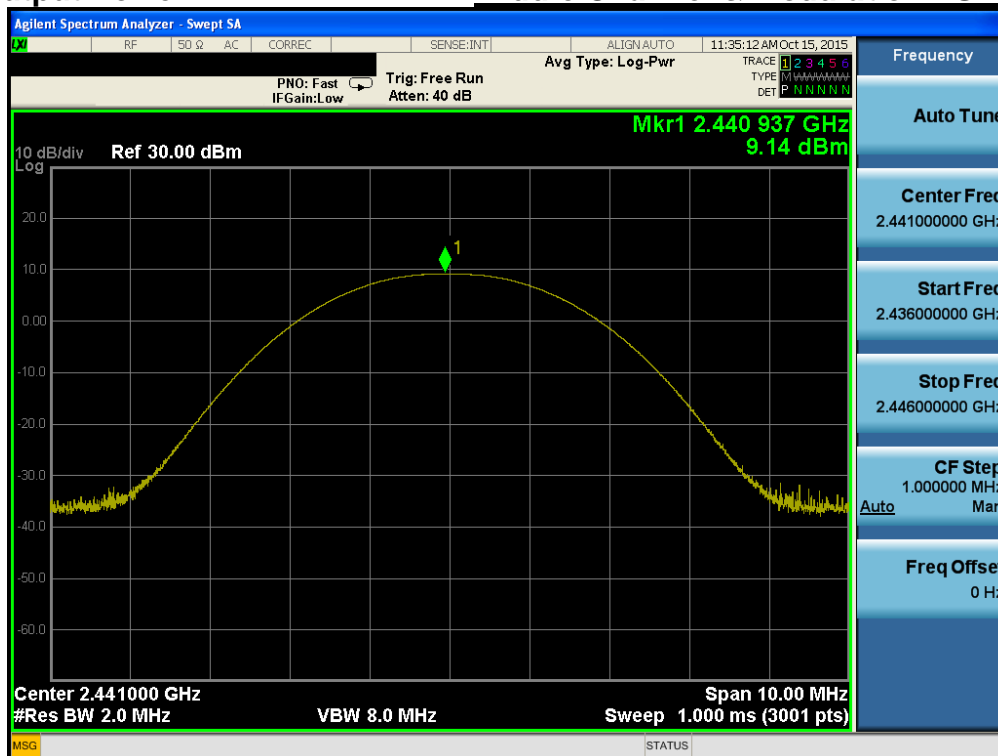

Peak Output Power

Middle Channel & Modulation : $\pi/4$ DQPSK

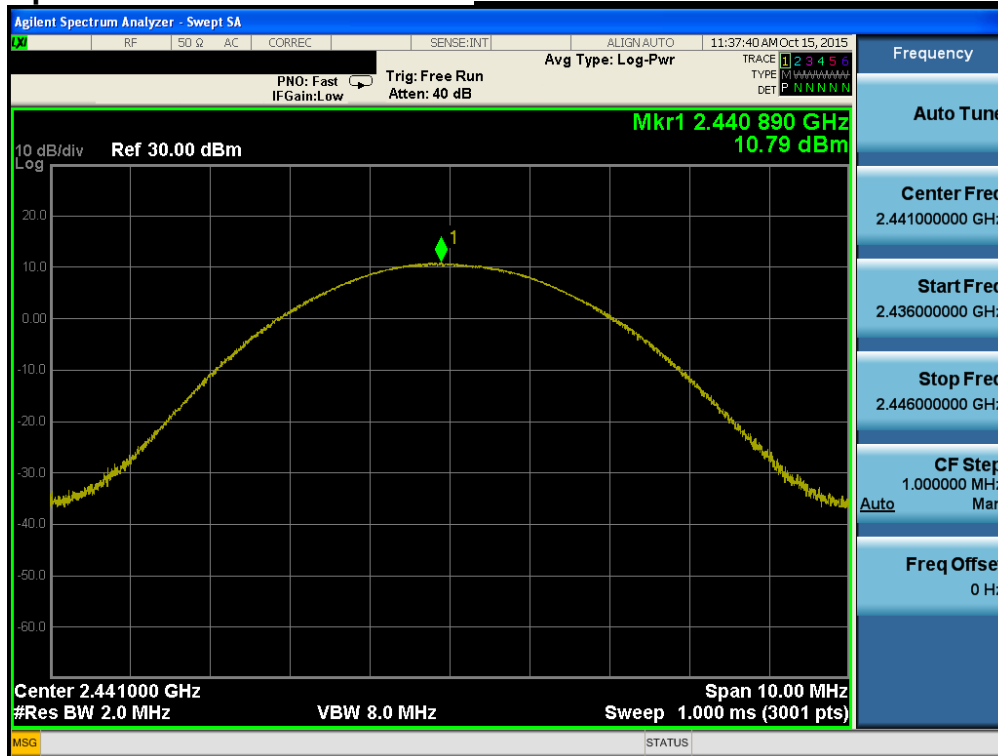

Peak Output Power

Highest Channel & Modulation : $\pi/4$ DQPSK

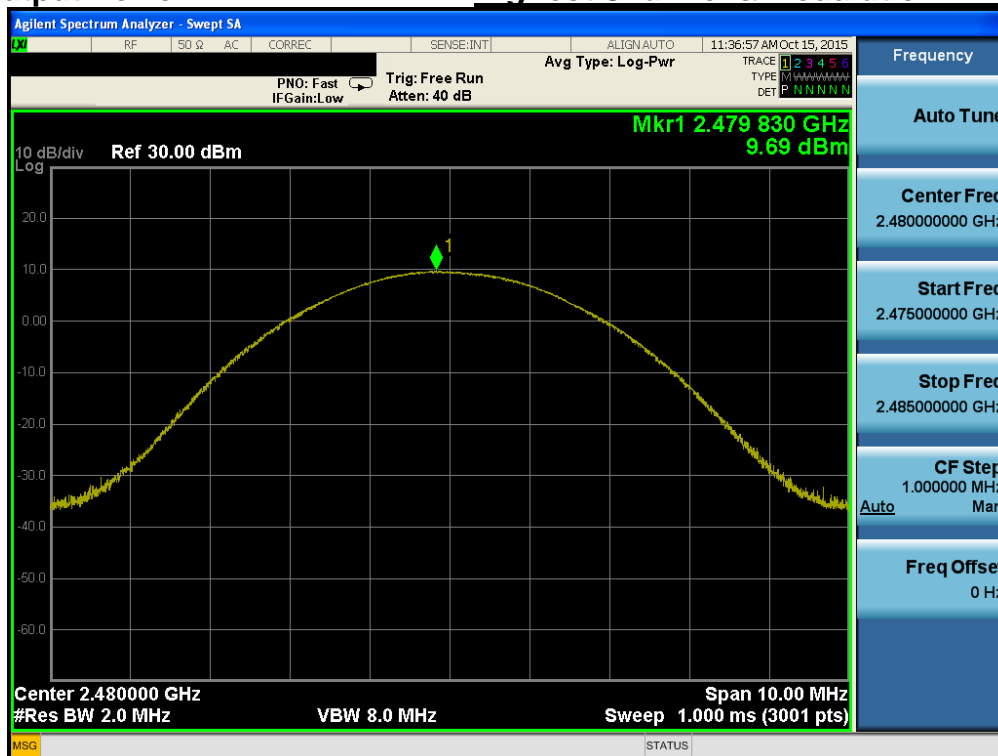

3. 20 dB BW

3.1 Test Setup

Refer to the APPENDIX I.

3.2 Limit

Limit : Not Applicable

3.3 Test Procedure

1. The 20 dB bandwidth were measured with a spectrum analyzer connected to RF antenna Connector (conducted measurement) while EUT was operating in transmit mode. The analyzer center frequency was set to the EUT carrier frequency, using the analyzer.
2. The bandwidth of the fundamental frequency was measured with the spectrum analyzer using $RBW \geq 1\%$ of the 20 dB bandwidth, $VBW \geq RBW$, Span = 3 MHz.

3.4 Test Results

Modulation	Tested Channel	20 dB BW (MHz)
<u>GFSK</u>	Lowest	0.934
	Middle	0.930
	Highest	0.934
<u>$\pi/4$DQPSK</u>	Lowest	1.248
	Middle	1.250
	Highest	1.250
<u>8DPSK</u>	Lowest	1.255
	Middle	1.254
	Highest	1.256

Note 1 : See next pages for actual measured spectrum plots.

20 dB Bandwidth

Lowest Channel & Modulation : GFSK

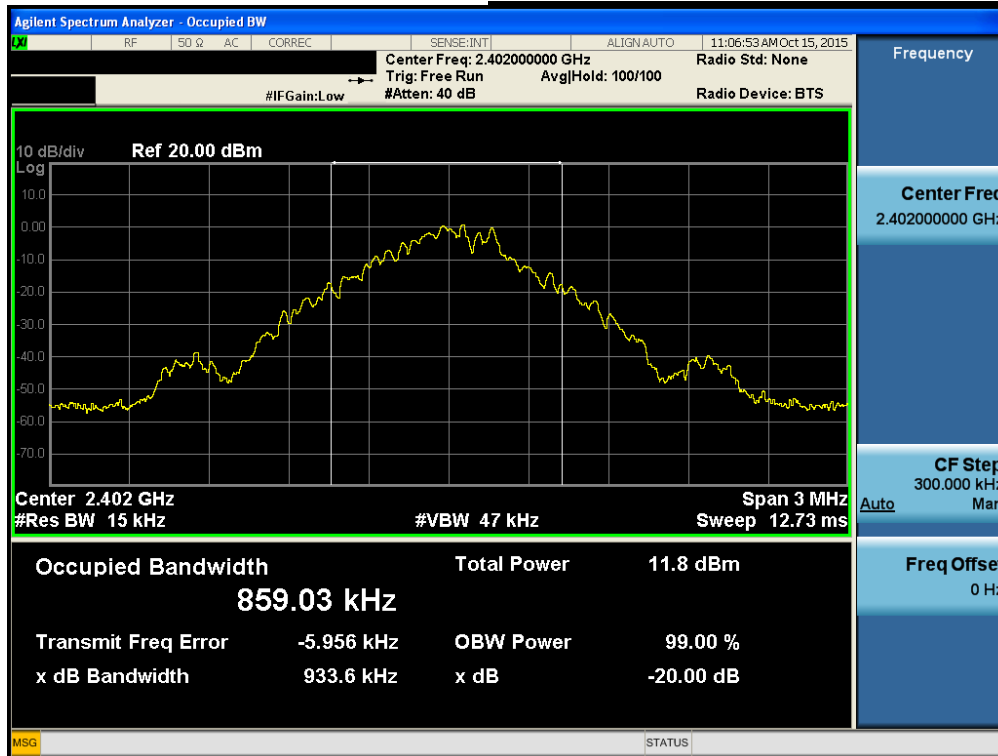

20 dB Bandwidth

Middle Channel & Modulation : GFSK

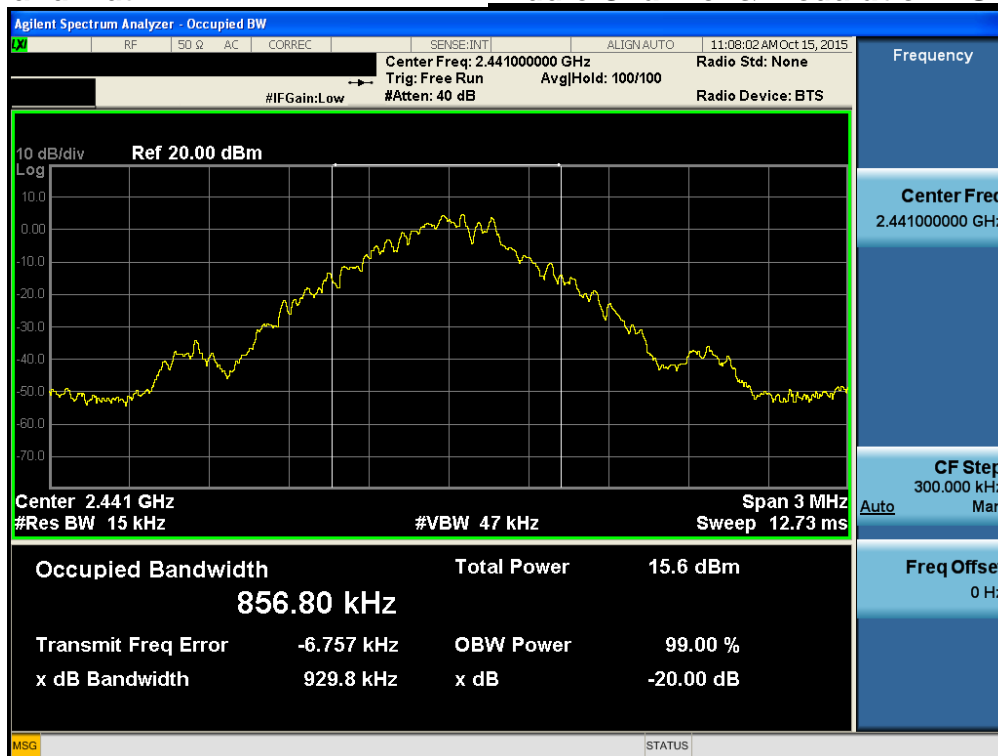

20 dB Bandwidth

Highest Channel & Modulation : GFSK

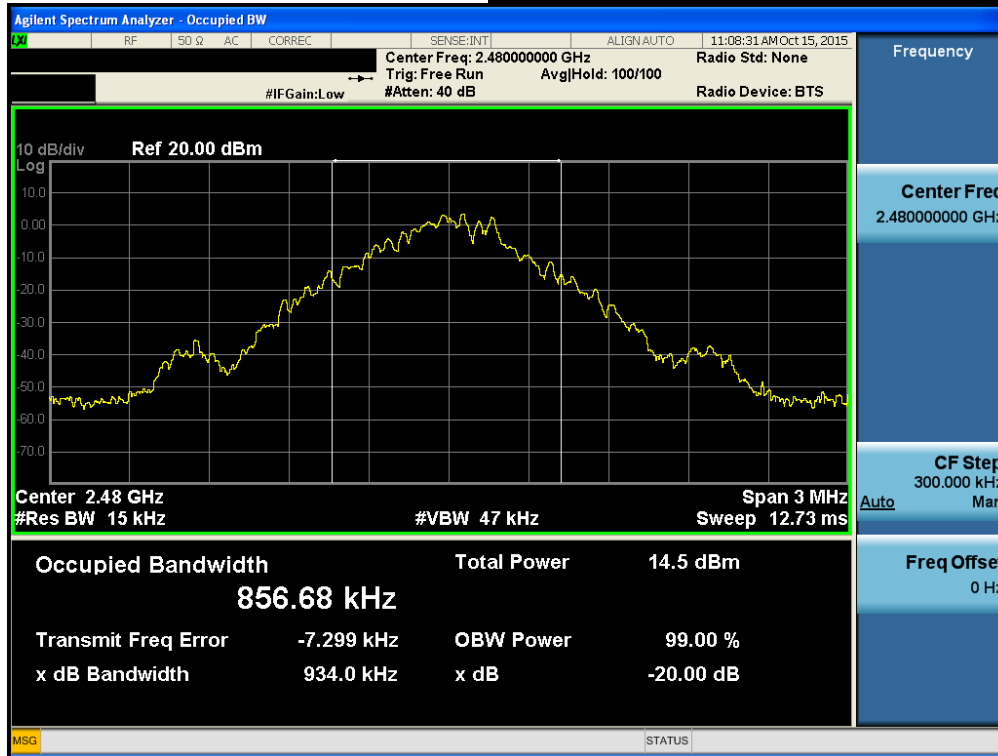

20 dB Bandwidth

Lowest Channel & Modulation : $\pi/4$ DQPSK

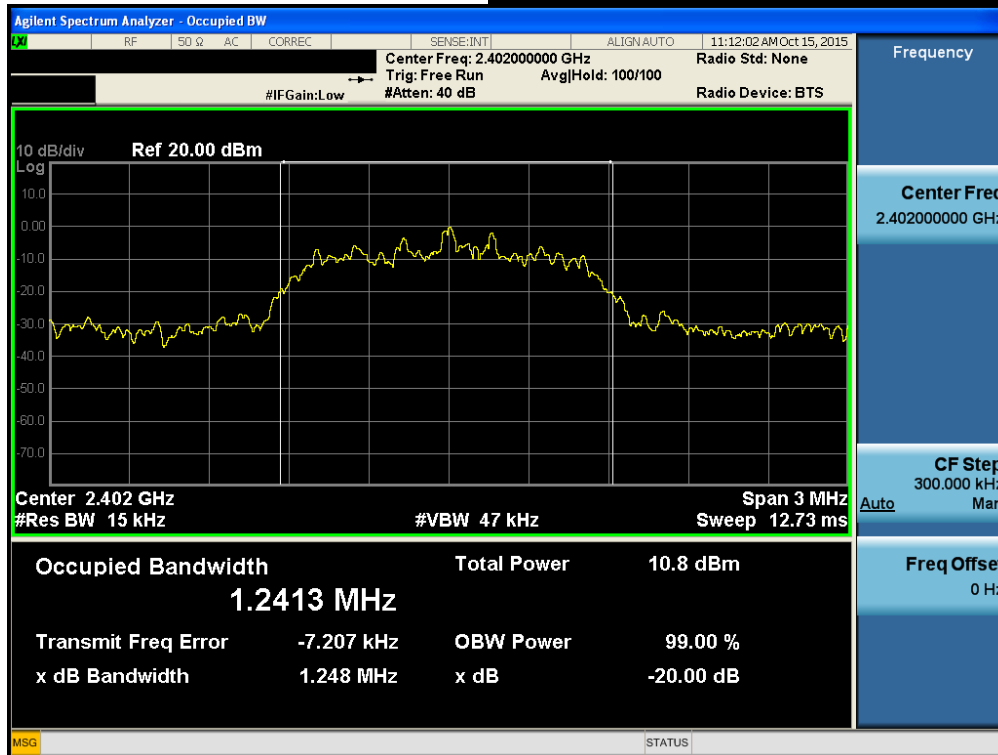

20 dB Bandwidth

Middle Channel & Modulation : $\pi/4$ DQPSK

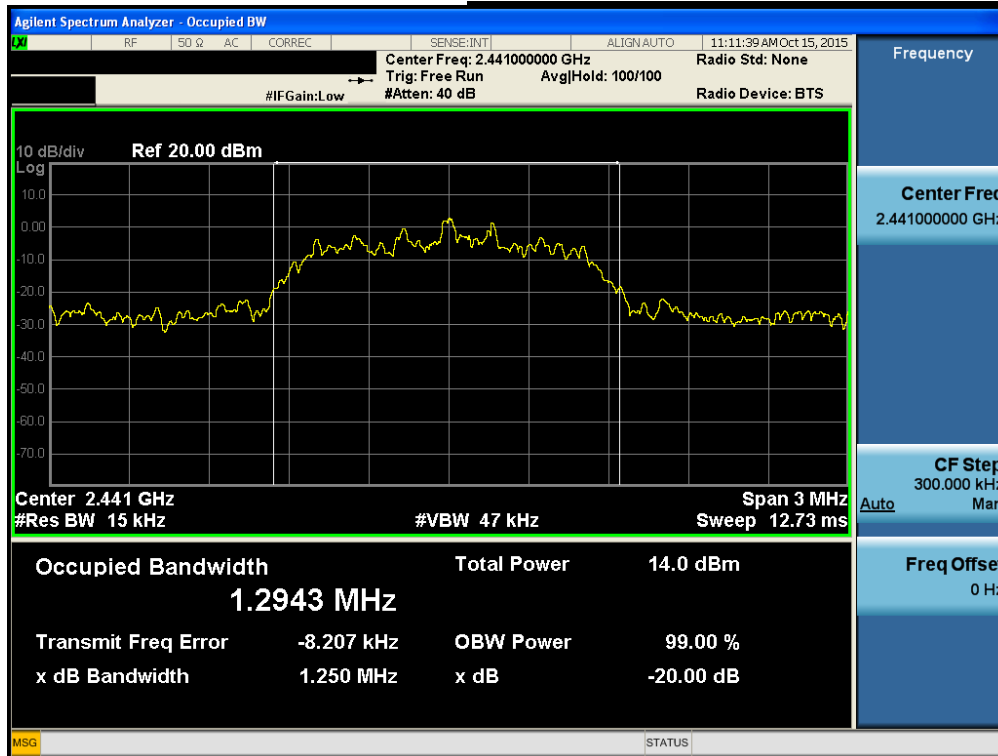

20 dB Bandwidth

Highest Channel & Modulation : $\pi/4$ DQPSK

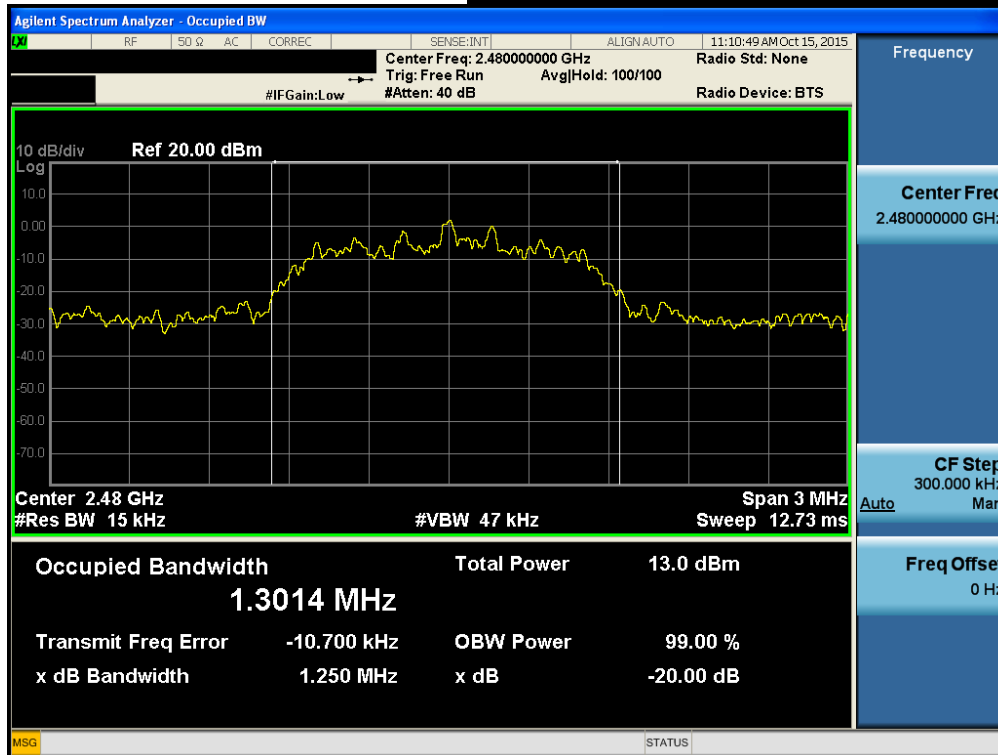

20 dB Bandwidth

Lowest Channel & Modulation : 8DPSK

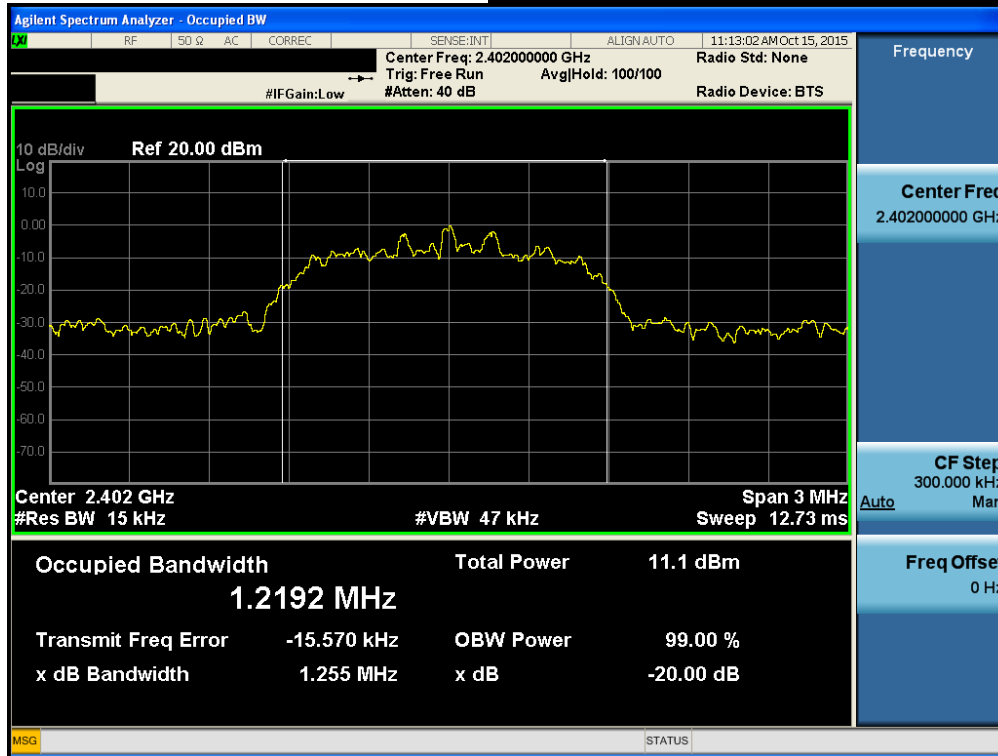

20 dB Bandwidth

Middle Channel & Modulation : 8DPSK

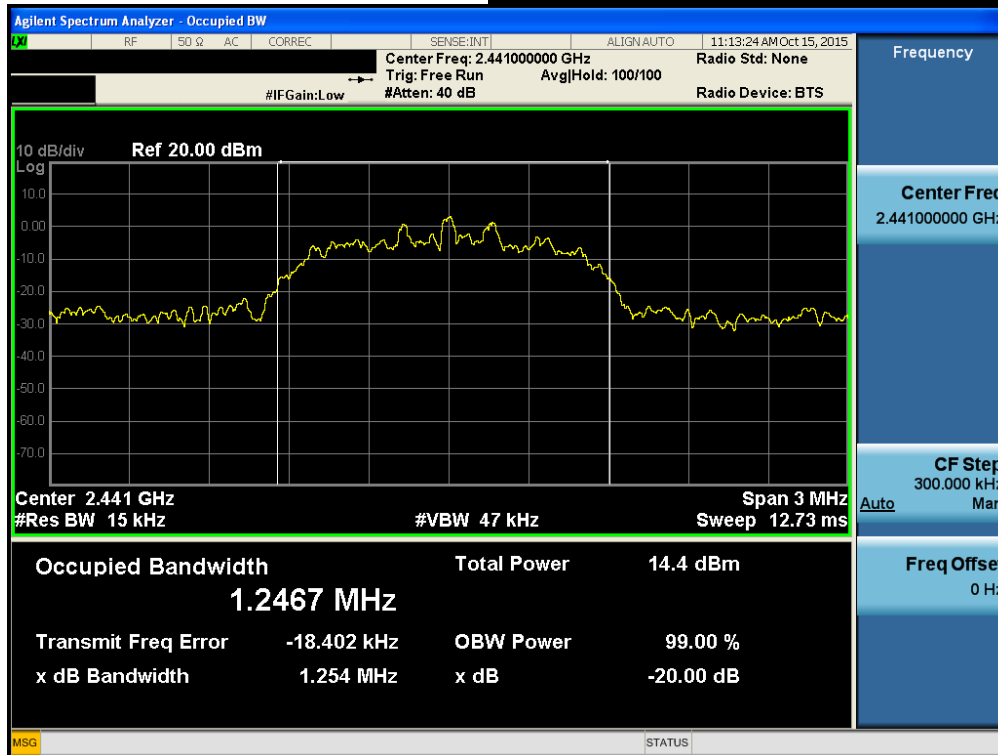

20 dB Bandwidth

Highest Channel & Modulation : 8DPSK

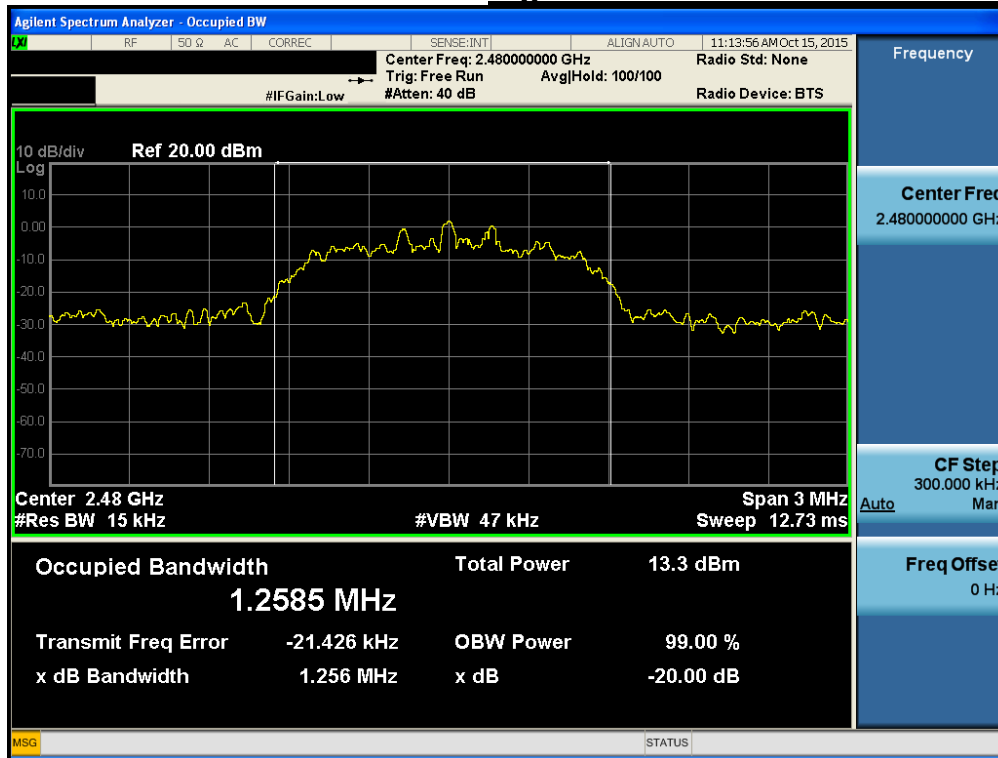

4. Carrier Frequency Separation

4.1 Test Setup

Refer to the APPENDIX I.

4.2 Limit

Limit : ≥ 20 dB BW or \geq Two-Thirds of the 20 dB BW

4.3 Procedure

The carrier frequency separation was measured with a spectrum analyzer connected to the antenna terminal, while EUT had its hopping function enabled.

After the trace being stable, the reading value between the peaks of the adjacent channels using the marker-delta function was recorded as the measurement results.

The spectrum analyzer is set to :

Span = wide enough to capture the peaks of two adjacent channels

RBW = Start with the RBW set to approximately 30% of the channel spacing; adjust as necessary to best identify the center of each individual channel.

VBW \geq RBW

Sweep = auto

Detector function = peak

Trace = max hold

4.4 Test Results

FH mode

Hopping Mode	Test Mode	Peak of center channel (MHz)	Peak of adjacent Channel (MHz)	Test Result (MHz)
Enable	GFSK	2441.000	2441.999	0.999
	$\pi/4$ -DQPSK	2441.000	2441.999	0.999
	8DPSK	2441.000	2442.002	1.002

AFH mode

Hopping Mode	Test Mode	Peak of center channel (MHz)	Peak of adjacent Channel (MHz)	Test Result (MHz)
Enable	GFSK	2411.000	2412.002	1.002
	$\pi/4$ -DQPSK	2411.000	2411.996	0.996
	8DPSK	2411.000	2411.999	0.999

Note 1 : See next pages for actual measured spectrum plots.

- Minimum Standard :

Frequency hopping systems shall have hopping channel carrier frequencies separated by a minimum of 25 kHz or the 20 dB bandwidth of the hopping channel, whichever is greater. Alternatively, frequency hopping systems operating in the 2400 - 2483.5 MHz band may have hopping channel carrier frequencies that are separated by 25 kHz or two-thirds of the 20 dB bandwidth of the hopping channel, whichever is greater, provided the systems operate with an output power no greater than 125 mW

Carrier Frequency Separation (FH) *Hopping mode : Enable & GFSK*



Carrier Frequency Separation (FH) *Hopping mode : Enable & π/4-DQPSK*

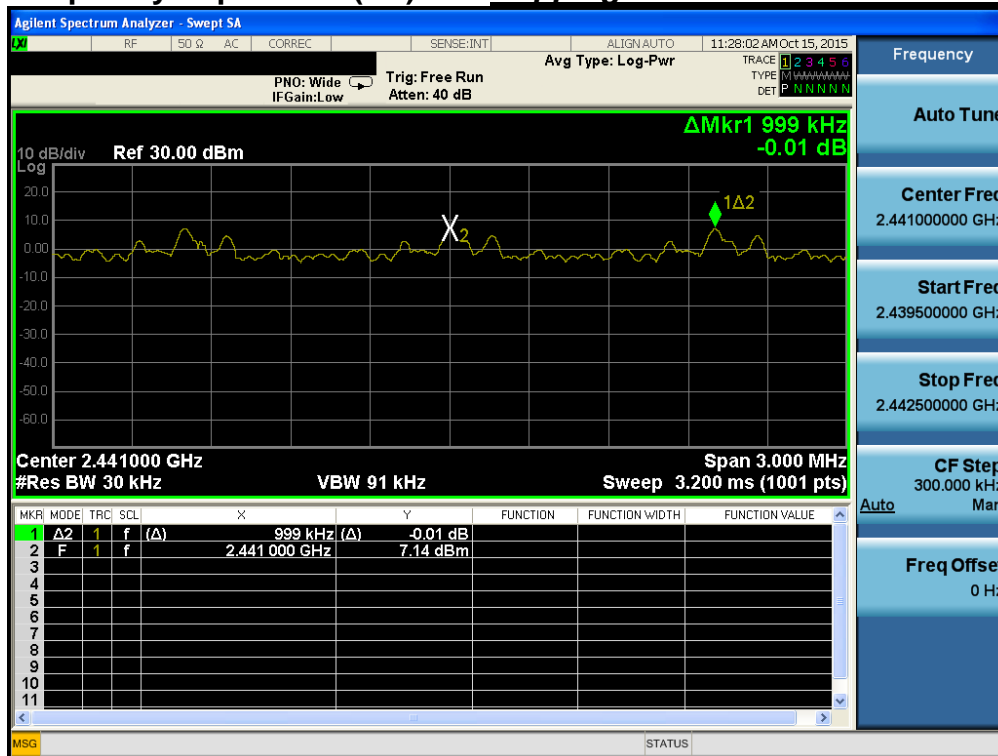

Carrier Frequency Separation (AFH) *Hopping mode : Enable & GFSK*



Carrier Frequency Separation (AFH) *Hopping mode : Enable & π/4-DQPSK*

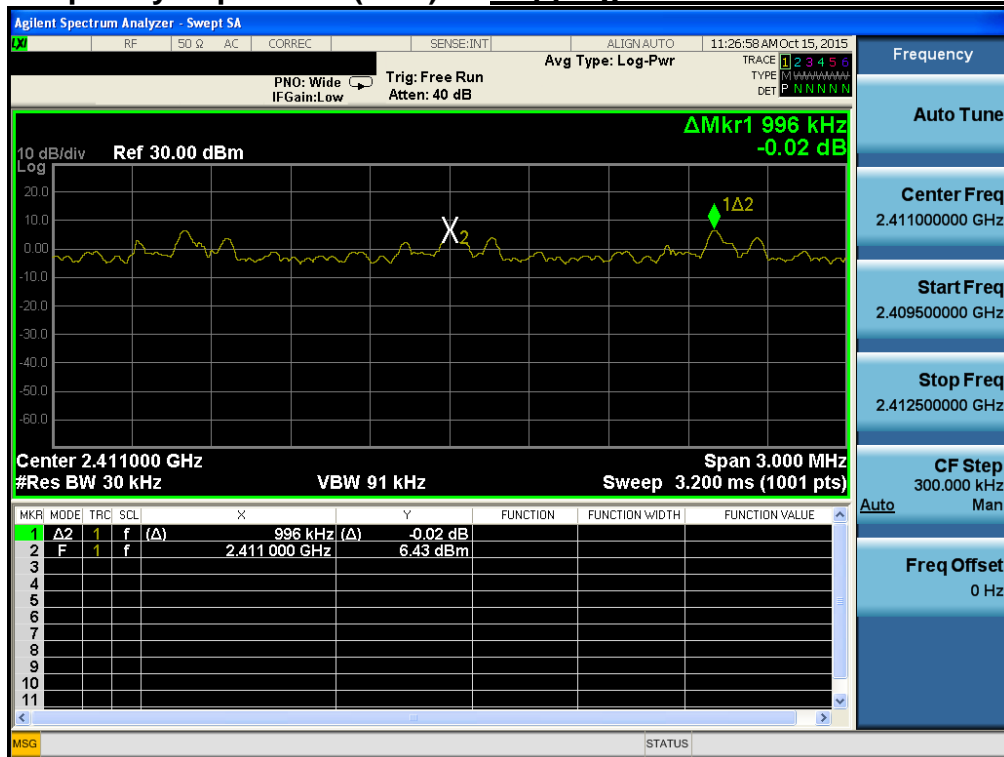

Carrier Frequency Separation (AFH) *Hopping mode : Enable & 8DPSK*

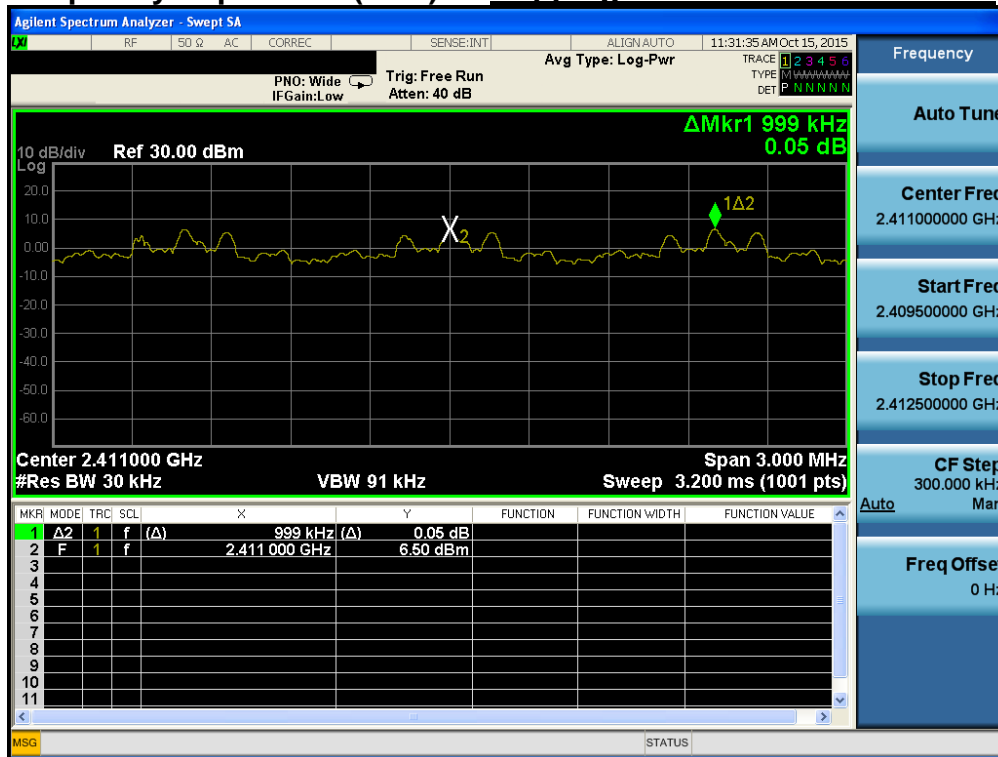

Number of Hopping Frequencies 1(FH) *Hopping mode : Enable & GFSK*

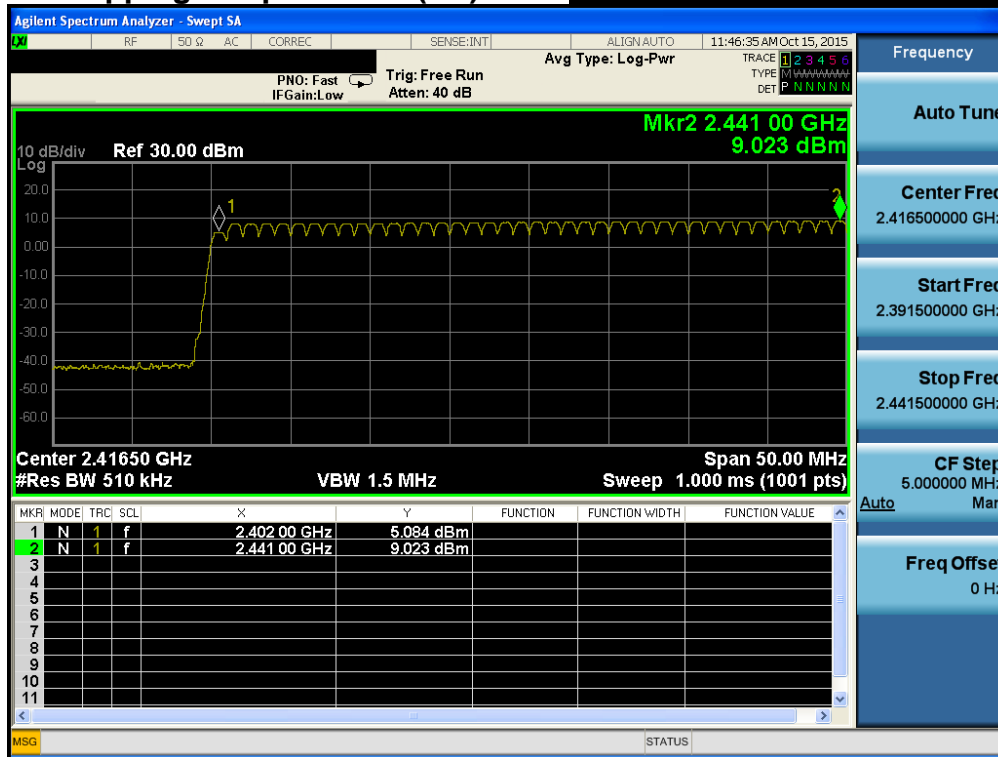

Number of Hopping Frequencies 2(FH) *Hopping mode : Enable & GFSK*

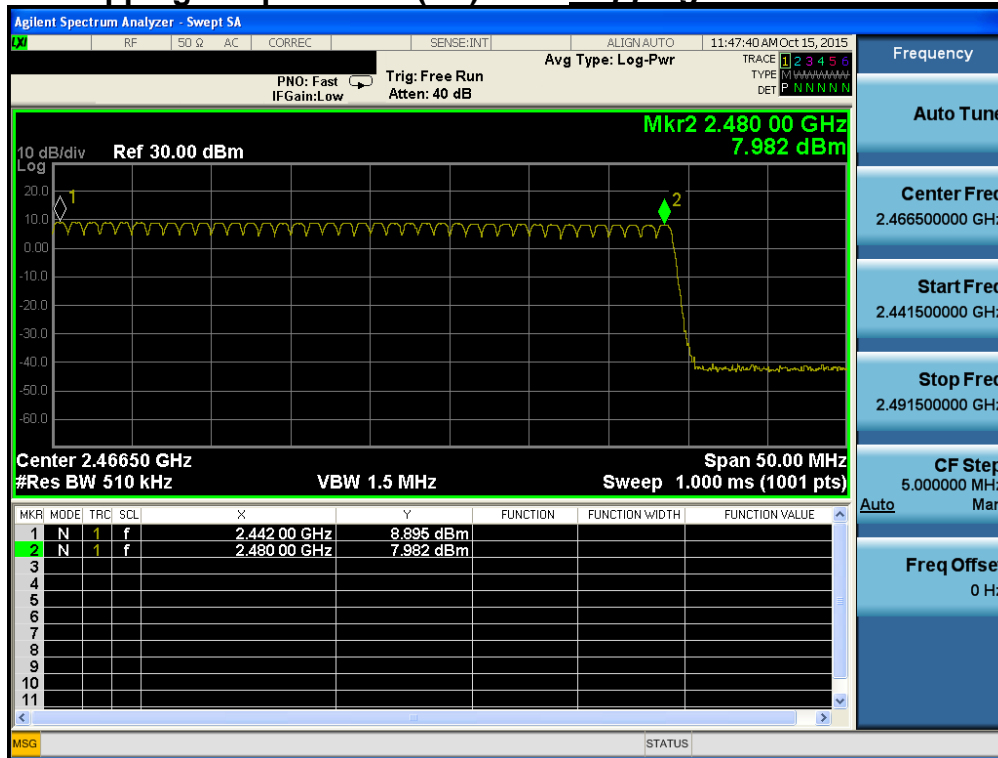

Number of Hopping Frequencies 1(FH)

Hopping mode : Enable & $\pi/4$ -DQPSK

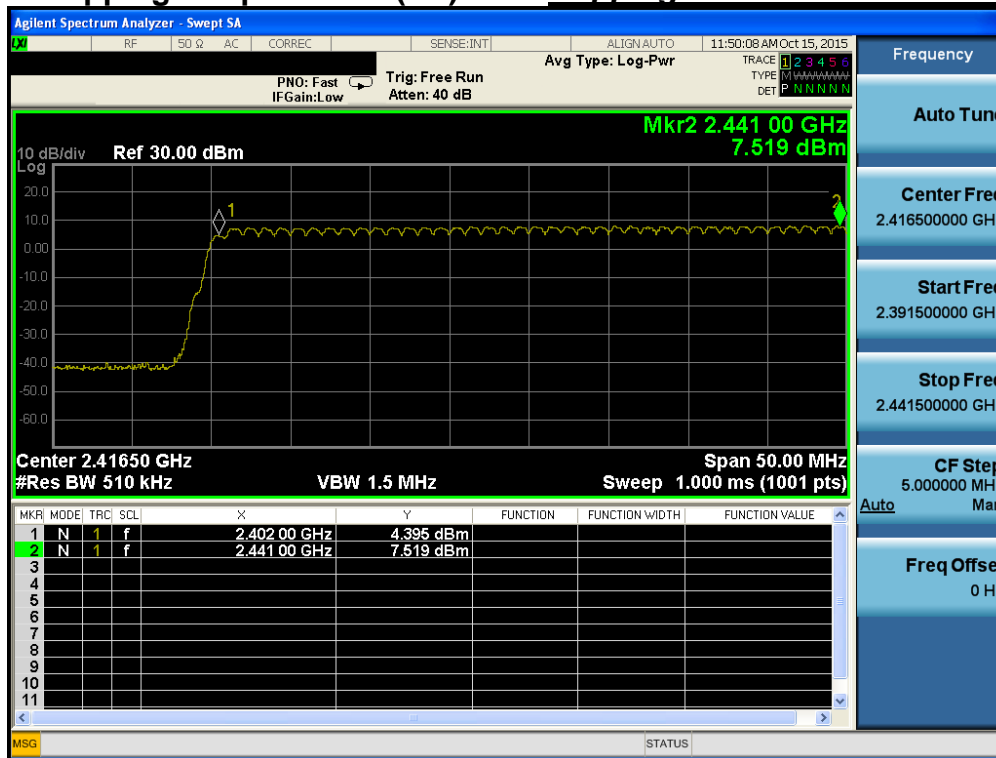

Number of Hopping Frequencies 2(FH)

Hopping mode : Enable & $\pi/4$ -DQPSK

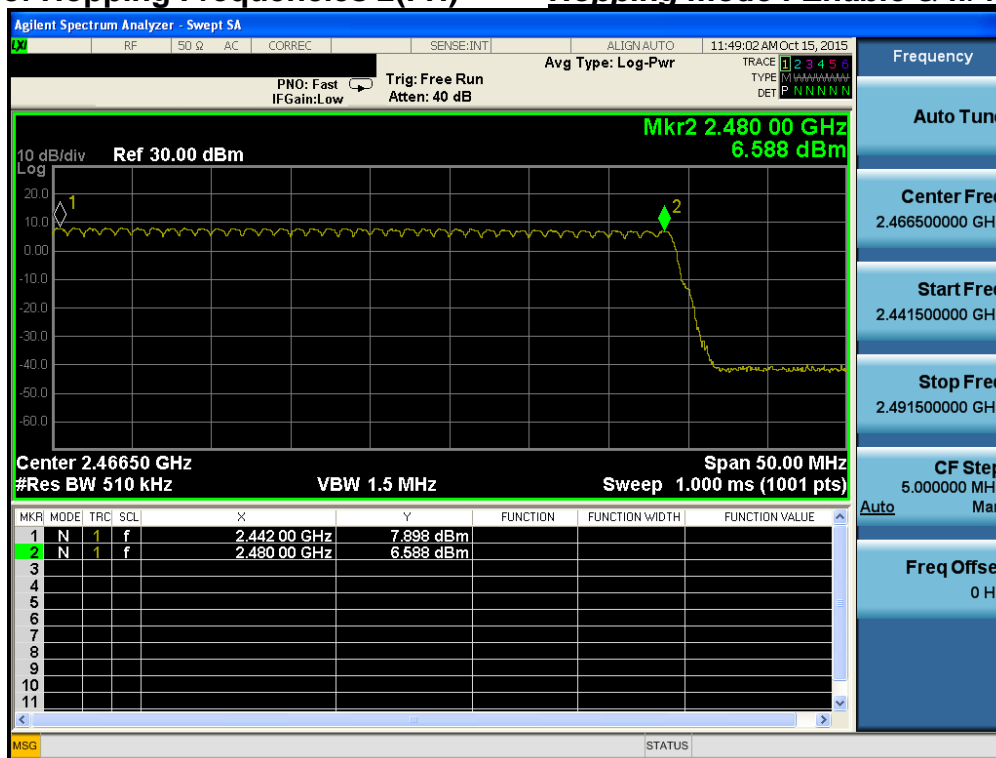

Number of Hopping Frequencies 1(FH) *Hopping mode : Enable & 8DPSK*

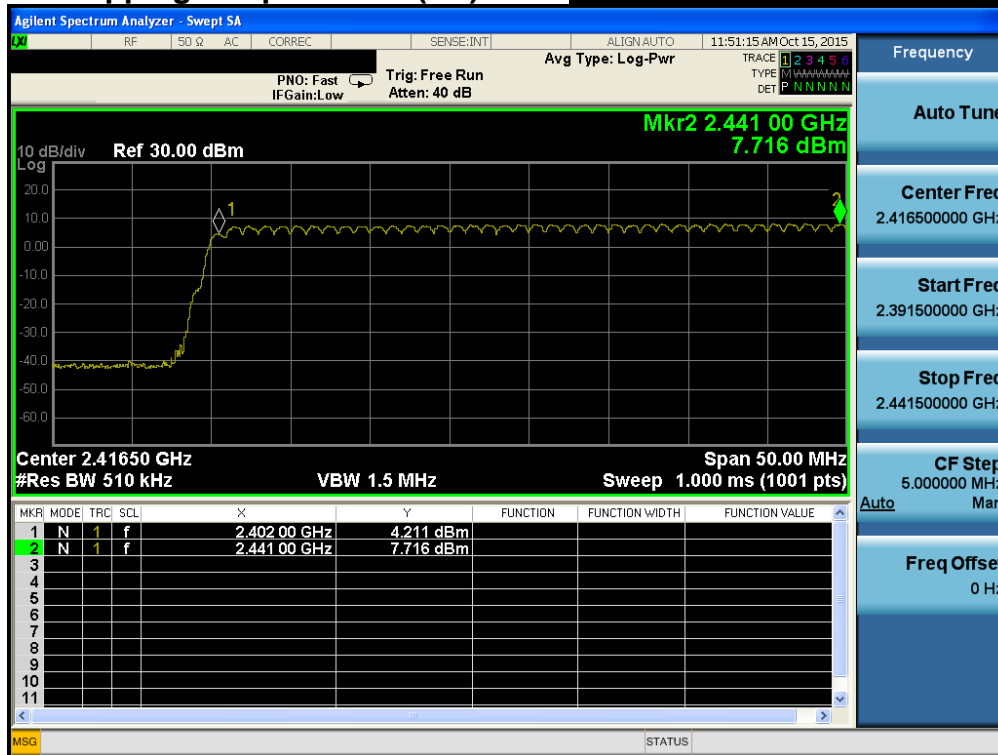

Number of Hopping Frequencies 2(FH) *Hopping mode : Enable & 8DPSK*

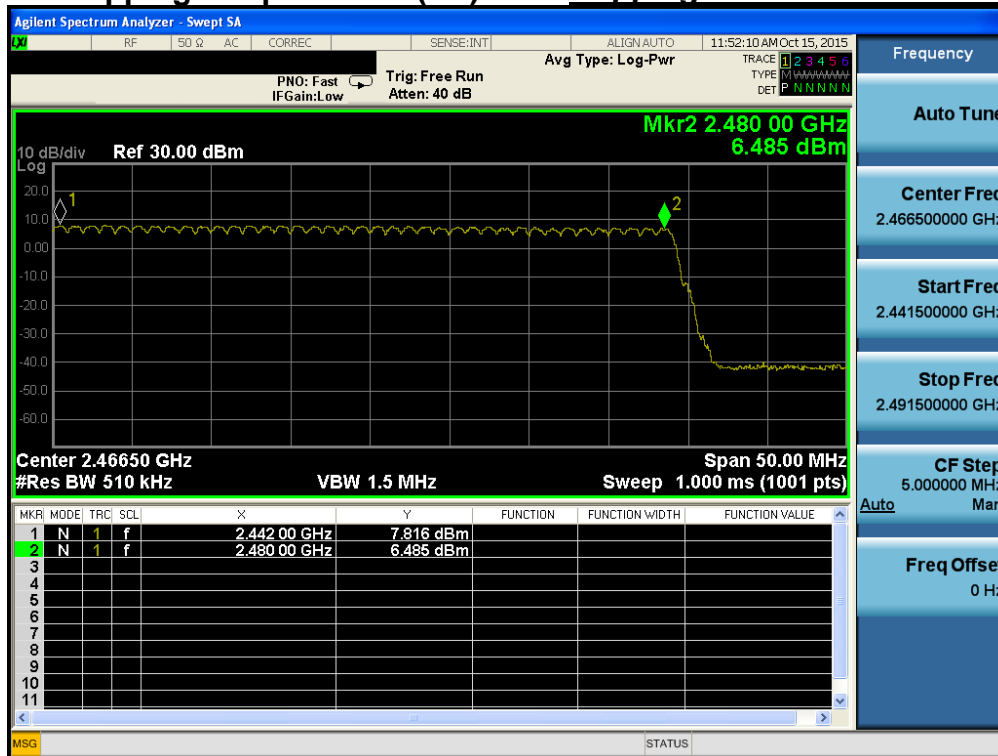

Number of Hopping Frequencies 1(AFH) *Hopping mode : Enable & GFSK*

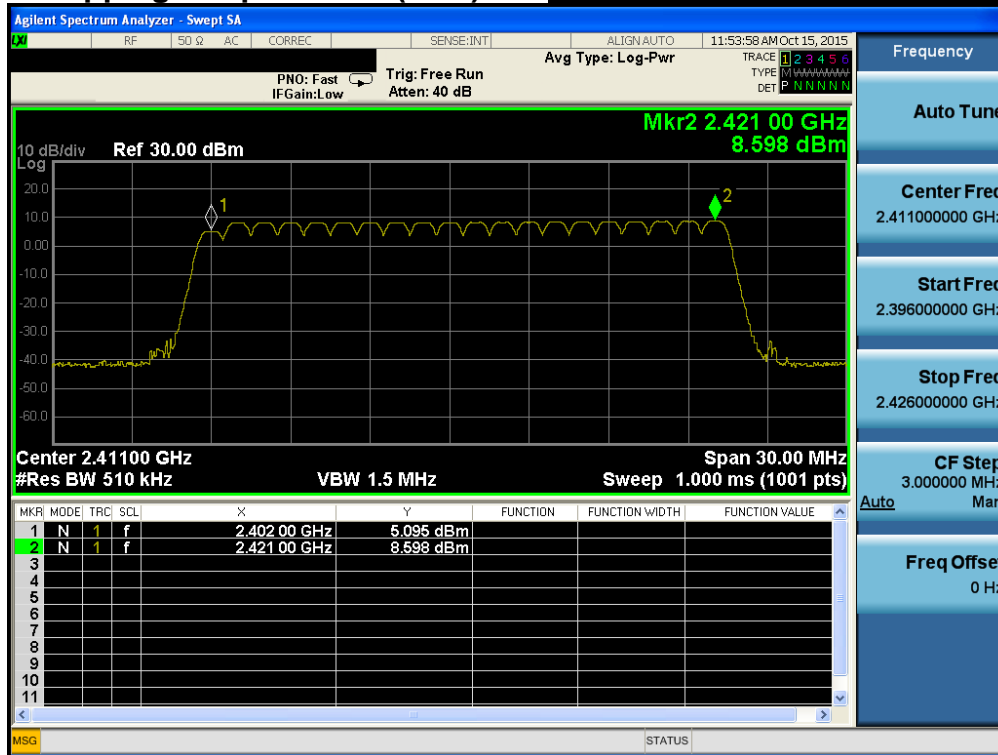

Number of Hopping Frequencies 1(AFH) *Hopping mode : Enable & π/4-DQPSK*

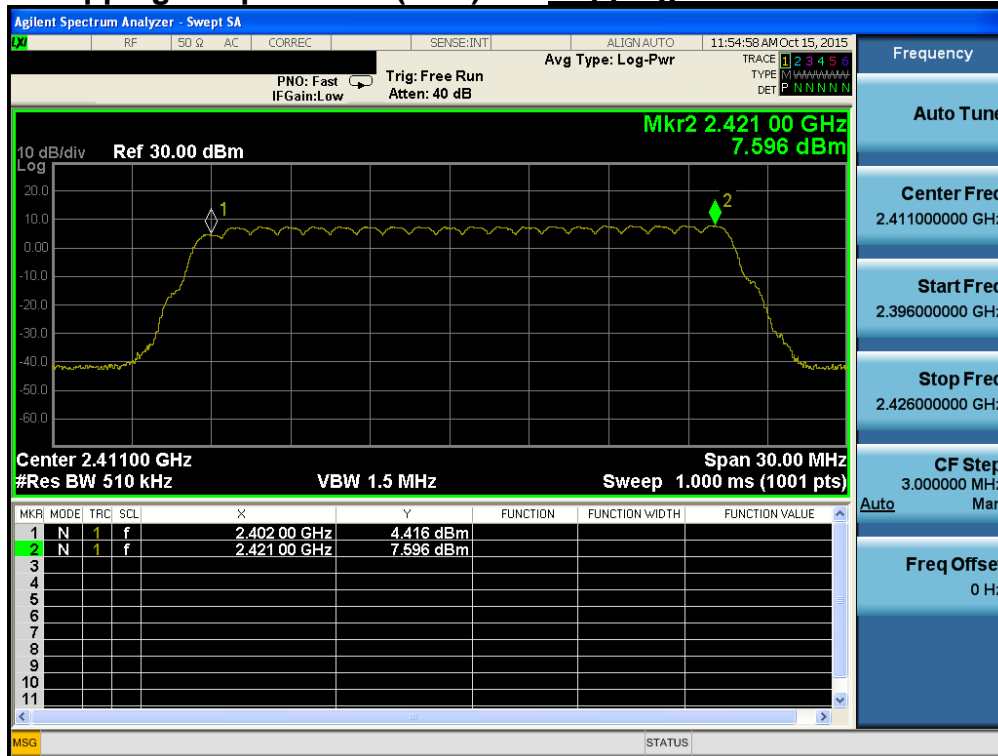

Number of Hopping Frequencies 1(AFH) *Hopping mode : Enable & 8DPSK*

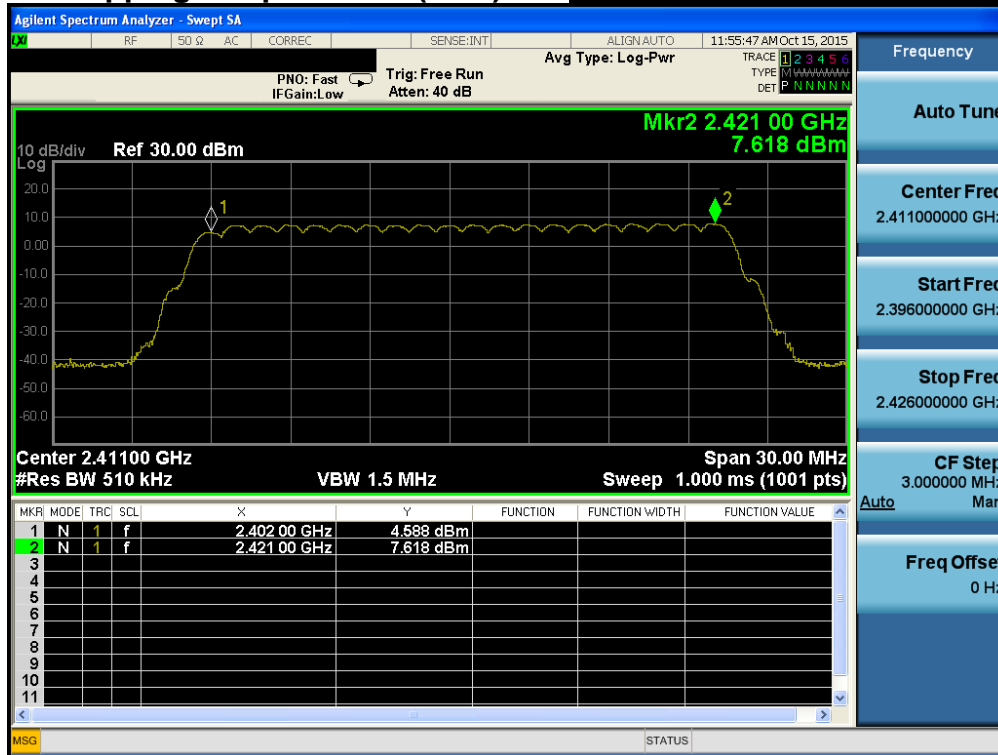

6. Time of Occupancy (Dwell Time)

6.1 Test Setup

Refer to the APPENDIX I.

6.2 Limit

The maximum permissible time of occupancy is 400 ms within a period of 400 ms multiplied by the number of hopping channels employed.

6.3 Test Procedure

The dwell time was measured with a spectrum analyzer connected to the antenna terminal, while EUT had its hopping function enabled.

The spectrum analyzer is set to :

Center frequency = 2441 MHz

Span = zero

RBW = 1 MHz (RBW shall be \leq channel spacing and where possible RBW should be set $\gg 1 / T$, where T is the expected dwell time per channel)

VBW \geq RBW

Detector function = peak

Trace = max hold

6.4 Test Results

FH mode

Hopping mode	Packet Type	Number of hopping Channels	Burst On Time (ms)	Period (ms)	Test Result (sec)
Enable	DH 5	79	2.880	3.750	0.307
	2 DH 5	79	2.880	3.750	0.307
	3 DH 5	79	2.880	3.750	0.307

AFH mode

Hopping mode	Packet Type	Number of hopping Channels	Burst On Time (ms)	Period (ms)	Test Result (sec)
Enable	DH 5	20	2.880	3.750	0.154
	2 DH 5	20	2.880	3.750	0.154
	3 DH 5	20	2.880	3.750	0.154

Note 1 : Dwell Time = $0.4 \times \text{Hopping channel} \times \text{Burst ON time} \times ((\text{Hopping rate} \div \text{Time slots}) \div \text{Hopping channel})$

- Time slots for DH5 = 6 slots (TX = 5 slot / RX = 1 slot)

- Hopping Rate = 1600 for FH mode & 800 for AFH mode

Note 2 : See next pages for actual measured spectrum plots.

Time of Occupancy (FH)

Hopping mode : Enable & GFSK

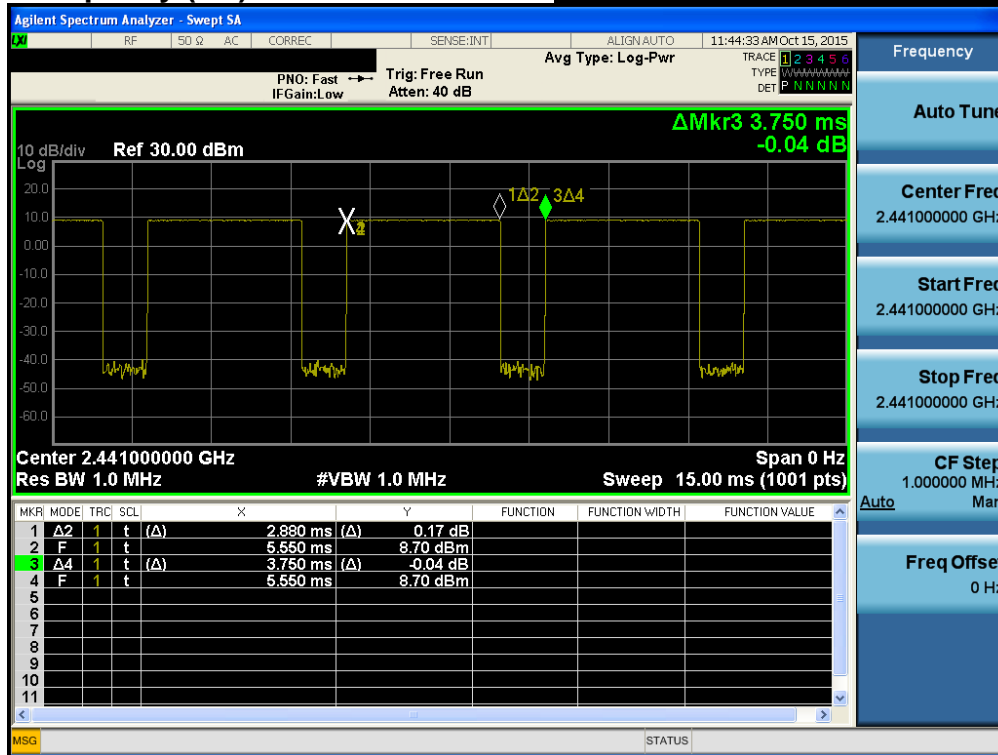

Time of Occupancy (FH)

Hopping mode : Enable & $\pi/4$ -DQPSK

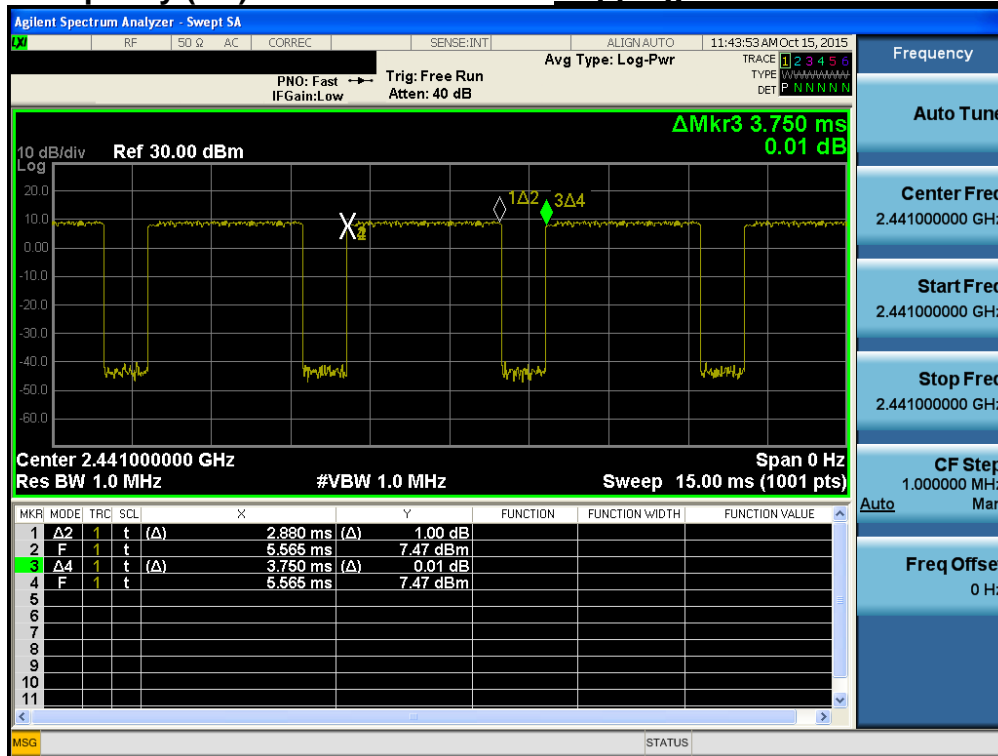

Time of Occupancy (FH)

Hopping mode : Enable & 8DPSK

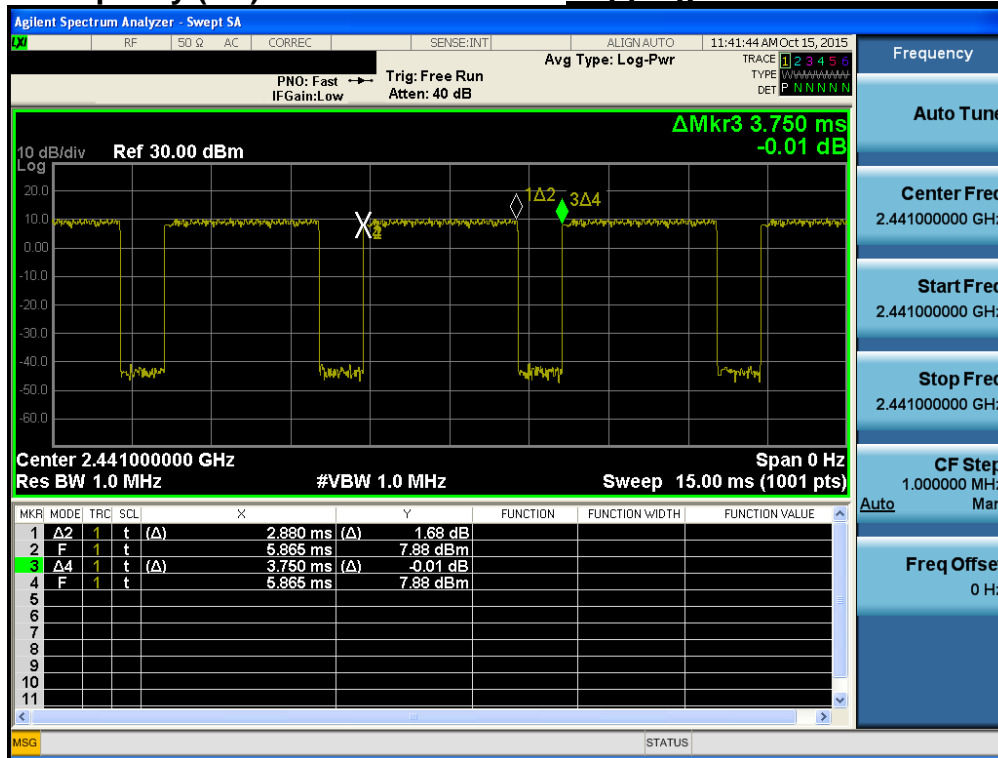

Time of Occupancy (AFH)

Hopping mode : Enable & GFSK

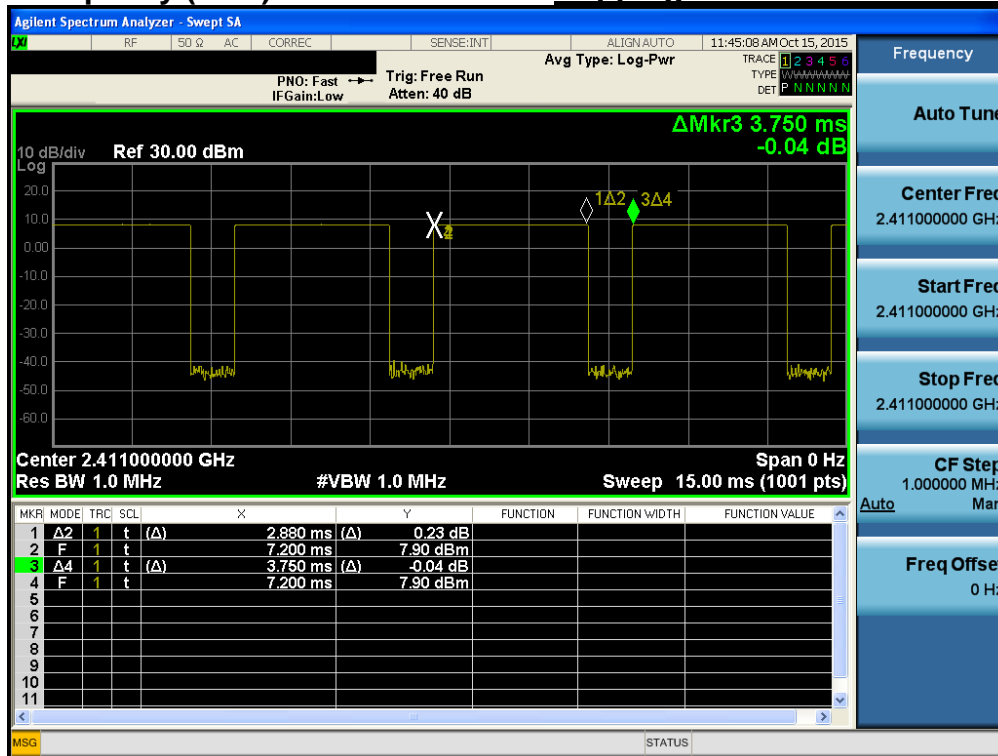

Time of Occupancy (AFH)

Hopping mode : Enable & $\pi/4$ -DQPSK

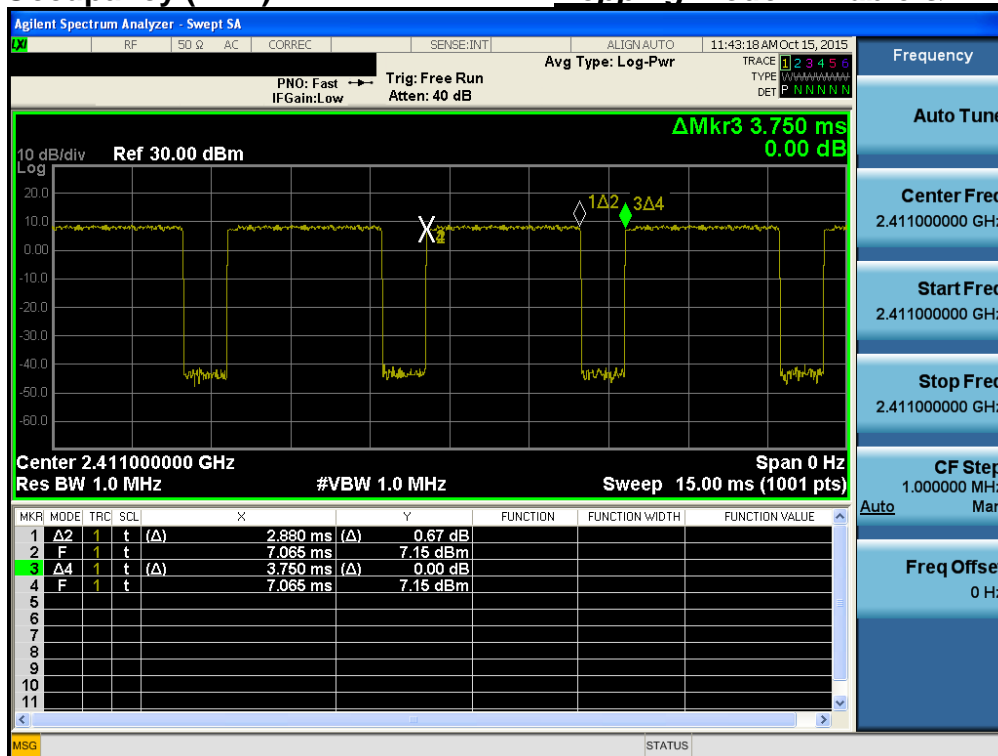

Time of Occupancy (AFH)

Hopping mode : Enable & 8DPSK

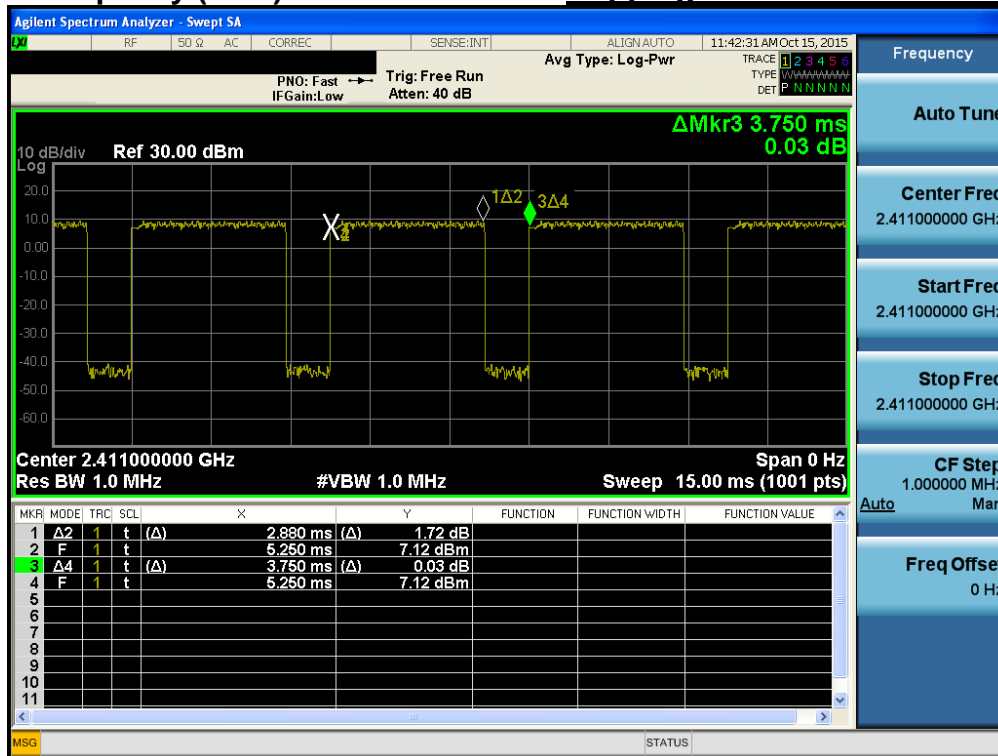

7. Transmitter Radiated Spurious Emissions and Conducted Spurious Emission

7.1 Test Setup

Refer to the APPENDIX I.

7.2 Limit

According to §15.247(d), in any 100 kHz bandwidth outside the frequency band in which the spread spectrum or digitally modulated intentional radiator is operating, the radio frequency power that is produced by the intentional radiator shall be at least 20 dB below that in the 100 kHz bandwidth within the band that contains the highest level of the desired power, based on either an RF conducted or a radiated measurement, provided the transmitter demonstrates compliance with the peak conducted power limits. If the transmitter complies with the conducted power limits based on the use of RMS averaging over a time interval, as permitted under paragraph(b)(3) of this section, the attenuation required under this paragraph shall be 30 dB instead of 20 dB. Attenuation below the general limits specified in section §15.209(a) is not required. In addition, radiated emission which in the restricted band, as define in section §15.205(a), must also comply the radiated emission limits specified in section §15.209(a) (see section §15.205(c))

According to § 15.209(a), except as provided elsewhere in this Subpart, the emissions from an intentional radiator shall not exceed the field strength levels specified in the following table

Frequency (MHz)	Limit (uV/m)	Measurement Distance (meter)
0.009 ~ 0.490	2400/F (kHz)	300
0.490 ~ 1705	24000/F (kHz)	30
1705 ~ 30.0	30	30
30 ~ 88	100 **	3
88 ~ 216	150 **	3
216 ~ 960	200 **	3
Above 960	500	3

** Except as provided in 15.209(g), fundamental emissions from intentional radiators operating under this Section shall not be located in the frequency bands 54 - 72 MHz, 76 - 88 MHz, 174 - 216 MHz or 470 - 806 MHz. However, operation within these frequency bands is permitted under other sections of this Part, e.g. 15.231 and 15.241.

According to § 15.205(a) and (b), only spurious emissions are permitted in any of the frequency bands listed below :

MHz	MHz	MHz	MHz	GHz	GHz
0.009 ~ 0.110	8.41425 ~ 8.41475	108 ~ 121.94	1300 ~ 1427	4.5 ~ 5.15	14.47 ~ 14.5
0.495 ~ 0.505	12.29 ~ 12.293	123 ~ 138	1435 ~ 1626.5	5.35 ~ 5.46	15.35 ~ 16.2
2.1735 ~ 2.1905	12.51975 ~ 12.52025	149.9 ~ 150.05	1645.5 ~ 1646.5	7.25 ~ 7.75	17.7 ~ 21.4
4.125 ~ 4.128	12.57675 ~ 12.57725	156.52475 ~ 156.52525	1660 ~ 1710	8.025 ~ 8.5	22.01 ~ 23.12
4.17725 ~ 4.17775	13.36 ~ 13.41	156.7 ~ 156.9	1718.8 ~ 1722.2	9.0 ~ 9.2	23.6 ~ 24.0
4.20725 ~ 4.20775	16.42 ~ 16.423	162.0125 ~ 167.17	2200 ~ 2300	9.3 ~ 9.5	31.2 ~ 31.8
6.215 ~ 6.218	16.69475 ~ 16.69525	167.72 ~ 173.2	2310 ~ 2390	10.6 ~ 12.7	36.43 ~ 36.5
6.26775 ~ 6.26825	16.80425 ~ 16.80475	240 ~ 285	2483.5 ~ 2500	13.25 ~ 13.4	Above 38.6
6.31175 ~ 6.31225	25.5 ~ 25.67	322 ~ 335.4	2655 ~ 2900		
8.291 ~ 8.294	37.5 ~ 38.25	399.90 ~ 410	3260 ~ 3267		
8.362 ~ 8.366	73 ~ 74.6	608 ~ 614	3332 ~ 3339		
8.37625 ~ 8.38675	74.8 ~ 75.2	960 ~ 1240	3345.8 ~ 3358		
			3600 ~ 4400		

The field strength of emissions appearing within these frequency bands shall not exceed the limits shown in §15.209. At frequencies equal to or less than 1000 MHz, compliance with the limits in §15.209 shall be demonstrated using measurement instrumentation employing a CISPR quasi-peak detector. Above 1000 MHz, compliance with the emission limits in §15.209 shall be demonstrated based on the average value of the measured emissions. The provisions in §15.35 apply to these measurements.

7.3. Test Procedures

7.3.1. Test Procedures for Radiated Spurious Emissions

1. The EUT is placed on a non-conductive table. For emission measurements at or below 1 GHz, the table height is 80 cm. For emission measurements above 1 GHz, the table height is 1.5 m. The table was rotated 360 degrees to determine the position of the highest radiation.
2. During performing radiated emission below 1 GHz, the EUT was set 3 meters away from the interference receiving antenna, which was mounted on the top of a variable-height antenna tower. During performing radiated emission above 1 GHz, the EUT was set 1 or 3 meter away from the interference-receiving antenna.
3. For measurements above 1GHz absorbers are placed on the floor between the turn table and the antenna mast in such a way so as to maximize the reduction of reflections. For measurements below 1 GHz, the absorbers are removed.
4. The antenna is a broadband antenna, and its height is varied from one meter to four meters above the ground to determine the maximum value of the field strength. Both horizontal and vertical polarizations of the antenna are set to make the measurement.
5. For each suspected emission, the EUT was arranged to its worst case and then the antenna was tuned to heights from 1 meter to 4 meters and the table was turned from 0 degrees to 360 degrees to find the maximum reading.
6. The test-receiver system was set to Peak Detect Function and Specified Bandwidth with Maximum Hold Mode.
7. If the emission level of the EUT in peak mode was 10 dB lower than the limit specified, then testing could be stopped and the peak values of the EUT would be reported. Otherwise the emissions that did not have 10 dB margin would be re-tested one by one using peak, quasi-peak or average method as specified and then reported in a data sheet.

NOTE 1. The resolution bandwidth and video bandwidth of test receiver/spectrum analyzer is 120 kHz for Quasi-peak detection (QP) at frequency below 1 GHz.

NOTE 2. The resolution bandwidth and video bandwidth of test receiver/spectrum analyzer is 1 MHz for Peak detection and frequency above 1 GHz.

NOTE 3. The resolution bandwidth of test receiver/spectrum analyzer is 1 MHz and the video bandwidth is 1 kHz for Average detection (AV) at frequency above 1 GHz.

7.3.2. Test Procedures for Conducted Spurious Emissions

1. The transmitter output was connected to the spectrum analyzer.
2. The **reference level** of the fundamental frequency was measured with the spectrum analyzer using RBW = 100 kHz, VBW = 300 kHz.
3. The conducted spurious emission was tested each ranges were set as below.

Frequency range : 9 kHz ~ 30 MHz

RBW = 100 kHz, VBW = 300 kHz, SWEEP TIME = AUTO, DETECTOR = PEAK, TRACE = MAX HOLD, SWEEP POINT : 40001

Frequency range : 30 MHz ~ 10 GHz, 10 GHz ~ 25 GHz

RBW = 1 MHz, VBW = 3 MHz, SWEEP TIME = AUTO, DETECTOR = PEAK, TRACE = MAX HOLD, SWEEP POINT : 40001

LIMIT LINE = 20 dB below of the reference level of above measurement procedure Step 2. (RBW = 100 kHz, VBW = 300 kHz)

If the emission level with above setting was close to the limit (ie, less than 3 dB margin) then zoom scan is required using RBW = 100 kHz, VBW = 300 kHz, SPAN = 100 MHz and BINS = 2001 to get accurate emission level within 100 kHz BW.

Also the path loss for conducted measurement setup was used as described on the Appendix I of this test report.

7.4. Test Results

7.4.1. Radiated Emissions

9 kHz ~ 25 GHz Data (Modulation : GFSK)

• Lowest Channel

Frequency (MHz)	ANT Pol	The worst case EUT Position (Axis)	Detector Mode	Reading (dBuV)	T.F (dB/m)	D.C.F (dB)	Distance Factor (dB)	Result (dBuV/m)	Limit (dBuV/m)	Margin (dB)
2376.08	V	Z	PK	47.58	0.83	N/A	N/A	48.41	74.00	25.59
2376.00	V	Z	AV	37.85	0.83	-24.79	N/A	13.89	54.00	40.11
4804.00	V	Y	PK	49.46	7.78	N/A	N/A	57.24	74.00	16.76
4804.01	V	Y	AV	43.62	7.78	-24.79	N/A	26.61	54.00	27.39

• Middle Channel

Frequency (MHz)	ANT Pol	The worst case EUT Position (Axis)	Detector Mode	Reading (dBuV)	T.F (dB/m)	D.C.F (dB)	Distance Factor(dB)	Result (dBuV/m)	Limit (dBuV/m)	Margin (dB)
4882.32	V	Y	PK	51.50	7.81	N/A	N/A	59.31	74.00	14.69
4882.04	V	Y	AV	47.53	7.81	-24.79	N/A	30.55	54.00	23.45

• Highest Channel

Frequency (MHz)	ANT Pol	The worst case EUT Position (Axis)	Detector Mode	Reading (dBuV)	T.F (dB/m)	D.C.F (dB)	Distance Factor (dB)	Result (dBuV/m)	Limit (dBuV/m)	Margin (dB)
2483.62	V	Z	PK	59.57	1.40	N/A	N/A	60.97	74.00	13.03
2483.52	V	Z	AV	41.31	1.40	-24.79	N/A	17.92	54.00	36.08
4959.96	V	Y	PK	47.64	7.84	N/A	N/A	55.48	74.00	18.52
4960.09	V	Y	AV	40.24	7.84	-24.79	N/A	23.29	54.00	30.71

• Note.

1. No other spurious and harmonic emissions were found greater than listed emissions on above table.

2. Information of Distance Factor

For finding emissions, the test distance might be reduced from 3m to 1m. In this case, the distance factor(-9.54dB) is applied to the result.

- Calculation of distance factor = $20 \log(\text{applied distance} / \text{required distance}) = 20 \log(1 \text{ m} / 3 \text{ m}) = -9.54 \text{ dB}$

When distance factor is "N/A", the distance is 3 m and distance factor is not applied.

3. D.C.F Calculation. (D.C.F = Duty Cycle Correction Factor)

- Time to cycle through all channels = $\Delta t = T [\text{ms}] \times 20$ minimum hopping channels, where T = pulse width = **2.88 ms**

- $100 \text{ ms} / \Delta t [\text{ms}] = H \rightarrow$ Round up to next highest integer, to account for worst case, $H' = 100 / (2.88 \times 20) = 1.736 \approx 2$

- The Worst Case Dwell Time = $T [\text{ms}] \times H' = 2.88 \text{ ms} \times 2 = 5.76 \text{ ms}$

- D.C.F = $20 \log(\text{The Worst Case Dwell Time} / 100 \text{ ms}) \text{ dB} = 20 \log(5.76 / 100) = -24.79 \text{ dB}$

4. Sample Calculation.

Margin = Limit – Result / Result = Reading + T.F + D.C.F / T.F = AF + CL – AG

Where, T.F = Total Factor, AF = Antenna Factor, CL = Cable Loss, AG = Amplifier Gain.

9 kHz ~ 25 GHz Data (Modulation : $\pi/4$ DQPSK)

▪ Lowest Channel

Frequency (MHz)	ANT Pol	The worst case EUT Position (Axis)	Detector Mode	Reading (dBuV)	T.F (dB/m)	D.C.F (dB)	Distance Factor (dB)	Result (dBuV/m)	Limit (dBuV/m)	Margin (dB)
2375.84	V	Z	PK	48.09	0.83	N/A	N/A	48.92	74.00	25.08
2375.60	V	Z	AV	36.72	0.83	-24.79	N/A	12.76	54.00	41.24
4803.66	V	Y	PK	48.82	7.78	N/A	N/A	56.60	74.00	17.40
4804.05	V	Y	AV	36.05	7.78	-24.79	N/A	19.04	54.00	34.96

▪ Middle Channel

Frequency (MHz)	ANT Pol	The worst case EUT Position (Axis)	Detector Mode	Reading (dBuV)	T.F (dB/m)	D.C.F (dB)	Distance Factor (dB)	Result (dBuV/m)	Limit (dBuV/m)	Margin (dB)
4881.81	V	Y	PK	50.69	7.81	N/A	N/A	58.50	74.00	15.50
4882.06	V	Y	AV	41.01	7.81	-24.79	N/A	24.03	54.00	29.97

▪ Highest Channel

Frequency (MHz)	ANT Pol	The worst case EUT Position (Axis)	Detector Mode	Reading (dBuV)	T.F (dB/m)	D.C.F (dB)	Distance Factor (dB)	Result (dBuV/m)	Limit (dBuV/m)	Margin (dB)
2483.52	V	Z	PK	59.53	1.40	N/A	N/A	60.93	74.00	13.07
2483.52	V	Z	AV	46.46	1.40	-24.79	N/A	23.07	54.00	30.93
4959.90	V	Y	PK	49.82	7.84	N/A	N/A	57.66	74.00	16.34
4960.01	V	Y	AV	40.49	7.84	-24.79	N/A	23.54	54.00	30.46

▪ Note.

1. No other spurious and harmonic emissions were found greater than listed emissions on above table.

2. Information of Distance Factor

For finding emissions, the test distance might be reduced from 3m to 1m. In this case, the distance factor(-9.54dB) is applied to the result.

- Calculation of distance factor = $20 \log(\text{applied distance} / \text{required distance}) = 20 \log(1 \text{ m} / 3 \text{ m}) = -9.54 \text{ dB}$

When distance factor is "N/A", the distance is 3 m and distance factor is not applied.

3. D.C.F Calculation. (D.C.F = Duty Cycle Correction Factor)

- Time to cycle through all channels = $\Delta t = T [\text{ms}] \times 20$ minimum hopping channels, where T = pulse width = **2.88 ms**

- $100 \text{ ms} / \Delta t [\text{ms}] = H \rightarrow$ Round up to next highest integer, to account for worst case, $H' = 100 / (2.88 \times 20) = 1.736 \approx 2$

- The Worst Case Dwell Time = $T [\text{ms}] \times H' = 2.88 \text{ ms} \times 2 = 5.76 \text{ ms}$

- D.C.F = $20 \log(\text{The Worst Case Dwell Time} / 100 \text{ ms}) \text{ dB} = 20 \log(5.76 / 100) = -24.79 \text{ dB}$

4. Sample Calculation.

Margin = Limit – Result / Result = Reading + T.F + D.C.F / T.F = AF + CL – AG

Where, T.F = Total Factor, AF = Antenna Factor, CL = Cable Loss, AG = Amplifier Gain.

9 kHz ~ 25 GHz Data (Modulation : 8DPSK)

▪ Lowest Channel

Frequency (MHz)	ANT Pol	The worst case EUT Position (Axis)	Detector Mode	Reading (dBuV)	T.F (dB/m)	D.C.F (dB)	Distance Factor (dB)	Result (dBuV/m)	Limit (dBuV/m)	Margin (dB)
2376.16	V	Z	PK	48.22	0.83	N/A	N/A	49.05	74.00	24.95
2375.52	V	Z	AV	36.58	0.83	-24.79	N/A	12.62	54.00	41.38
4803.70	V	Y	PK	47.52	7.78	N/A	N/A	55.30	74.00	18.70
4803.89	V	Y	AV	36.17	7.78	-24.79	N/A	19.16	54.00	34.84

▪ Middle Channel

Frequency (MHz)	ANT Pol	The worst case EUT Position (Axis)	Detector Mode	Reading (dBuV)	T.F (dB/m)	D.C.F (dB)	Distance Factor (dB)	Result (dBuV/m)	Limit (dBuV/m)	Margin (dB)
4882.13	V	Y	PK	50.30	7.81	N/A	N/A	58.11	74.00	15.89
4882.02	V	Y	AV	41.06	7.81	-24.79	N/A	24.08	54.00	29.92

▪ Highest Channel

Frequency (MHz)	ANT Pol	The worst case EUT Position (Axis)	Detector Mode	Reading (dBuV)	T.F (dB/m)	D.C.F (dB)	Distance Factor (dB)	Result (dBuV/m)	Limit (dBuV/m)	Margin (dB)
2483.52	V	Z	PK	59.60	1.40	N/A	N/A	61.00	74.00	13.00
2483.52	V	Z	AV	46.44	1.40	-24.79	N/A	23.05	54.00	30.95
4959.61	V	Y	PK	49.72	7.84	N/A	N/A	57.56	74.00	16.44
4959.95	V	Y	AV	40.72	7.84	-24.79	N/A	23.77	54.00	30.23

▪ Note.

1. No other spurious and harmonic emissions were found greater than listed emissions on above table.

2. Information of Distance Factor

For finding emissions, the test distance might be reduced from 3m to 1m. In this case, the distance factor(-9.54dB) is applied to the result.

- Calculation of distance factor = $20 \log(\text{applied distance} / \text{required distance}) = 20 \log(1 \text{ m} / 3 \text{ m}) = -9.54 \text{ dB}$

When distance factor is "N/A", the distance is 3 m and distance factor is not applied.

3. D.C.F Calculation. (D.C.F = Duty Cycle Correction Factor)

- Time to cycle through all channels = $\Delta t = T [\text{ms}] \times 20$ minimum hopping channels, where T = pulse width = **2.88 ms**

- $100 \text{ ms} / \Delta t [\text{ms}] = H \rightarrow$ Round up to next highest integer, to account for worst case, $H' = 100 / (2.88 \times 20) = 1.736 \approx 2$

- The Worst Case Dwell Time = $T [\text{ms}] \times H' = 2.88 \text{ ms} \times 2 = 5.76 \text{ ms}$

- D.C.F = $20 \text{ Log}(\text{The Worst Case Dwell Time} / 100 \text{ ms}) \text{ dB} = 20 \text{ log}(5.76 / 100) = -24.79 \text{ dB}$

4. Sample Calculation.

Margin = Limit – Result / Result = Reading + T.F + D.C.F / T.F = AF + CL – AG

Where, T.F = Total Factor, AF = Antenna Factor, CL = Cable Loss, AG = Amplifier Gain.

7.4.2. Conducted Spurious Emissions

Low Band-edge

Lowest Channel & Modulation : GFSK

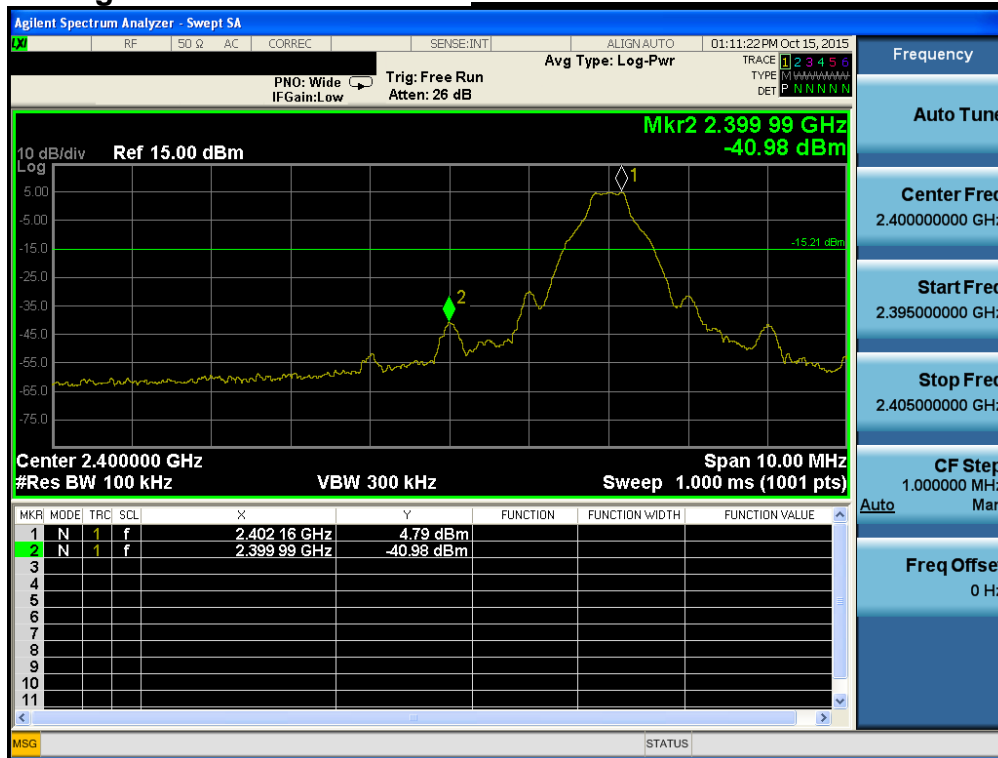

Low Band-edge

Hopping mode & Modulation : GFSK

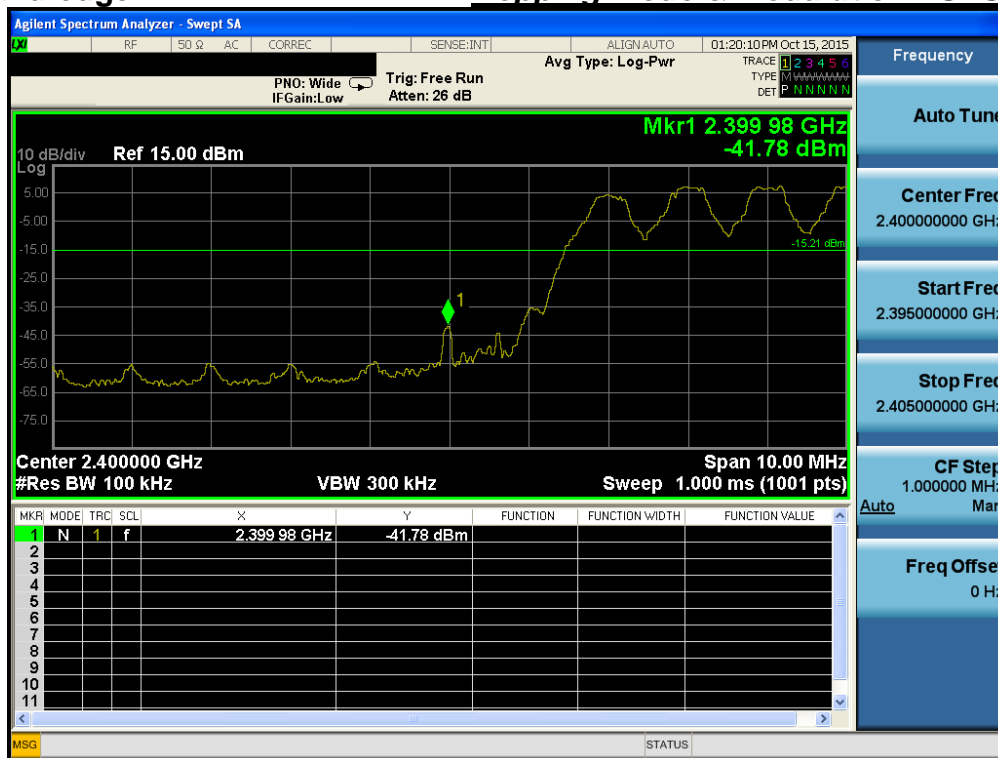

Conducted Spurious Emissions *Lowest Channel & Modulation : GFSK*

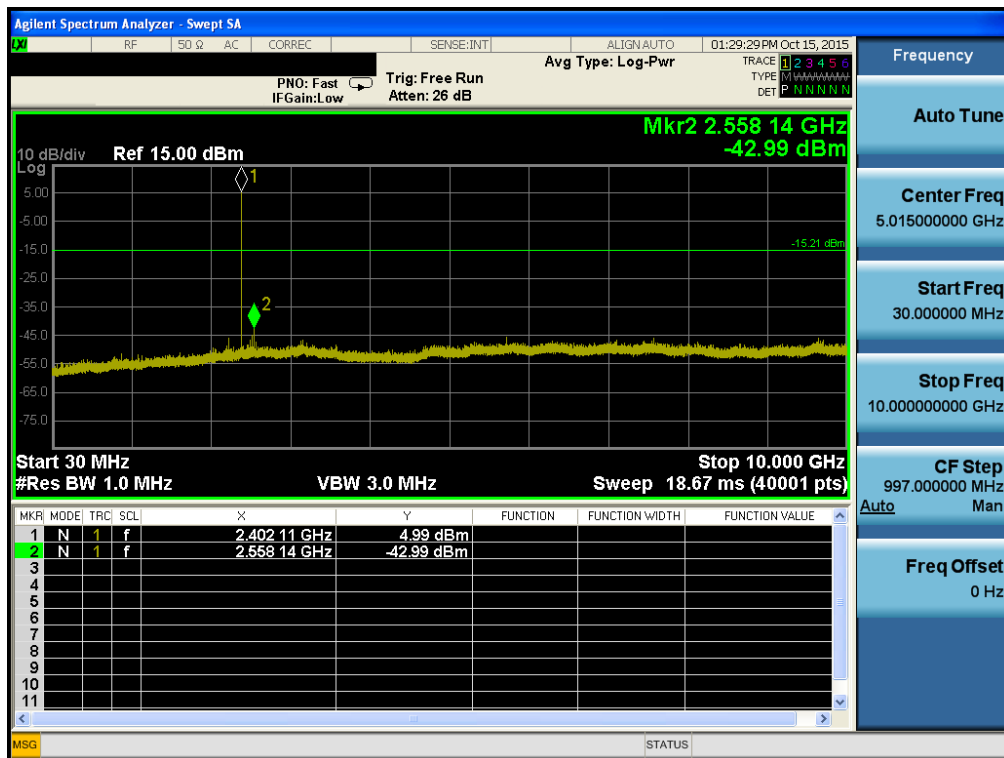
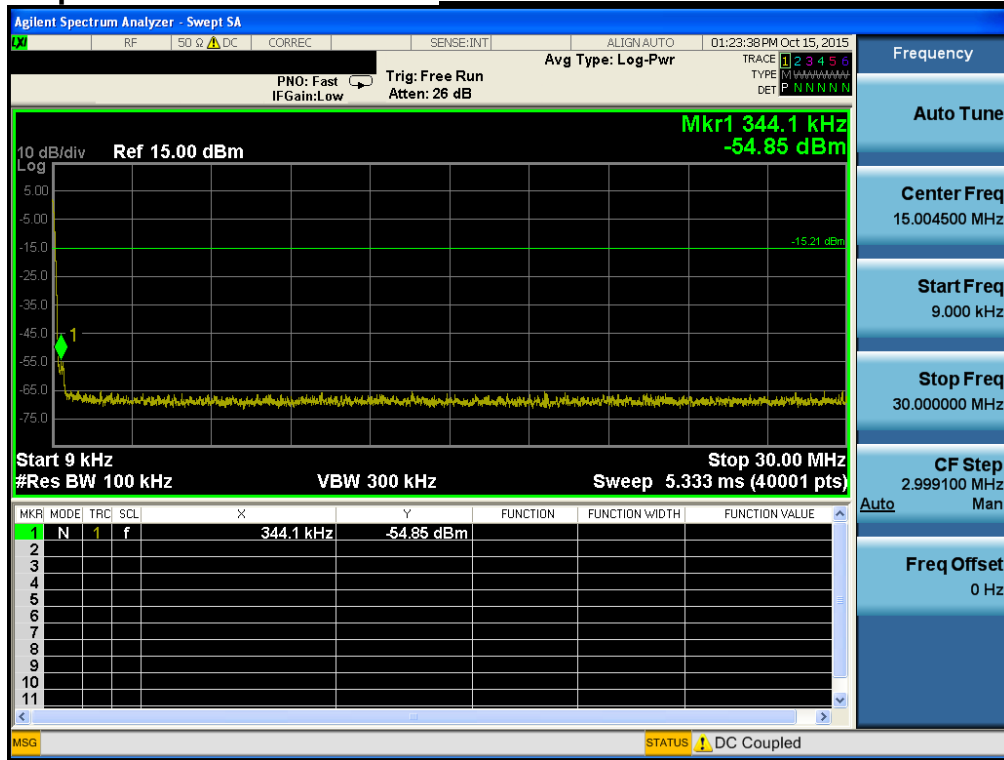

Reference for limit

Middle Channel & Modulation : GFSK

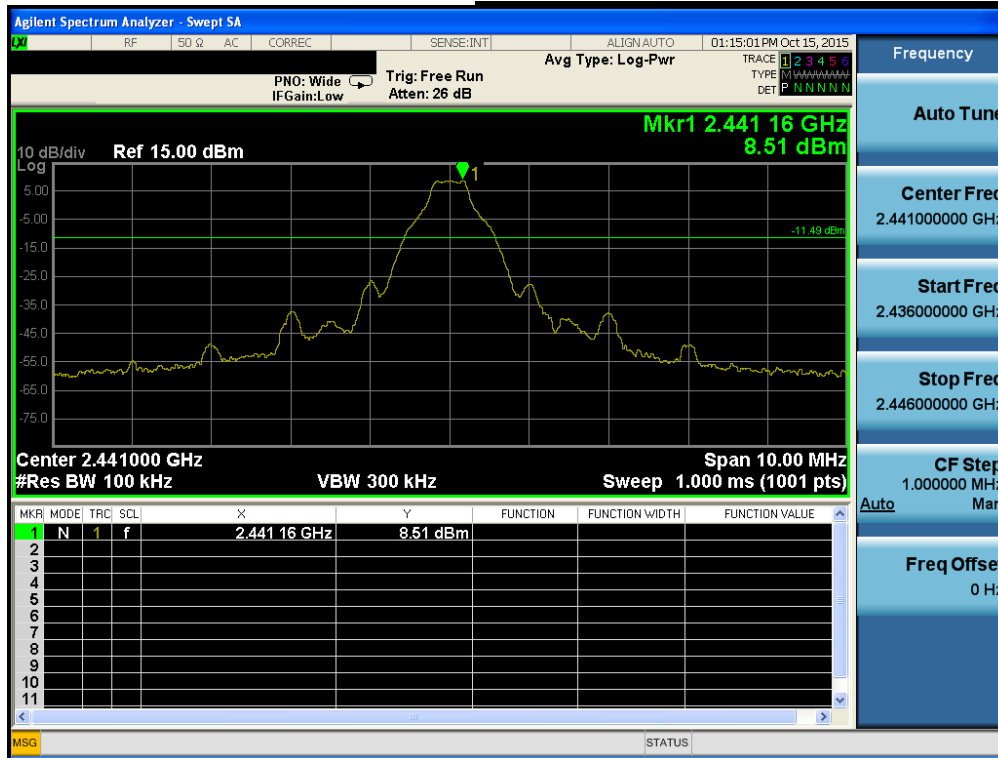

Conducted Spurious Emissions

Middle Channel & Modulation : GFSK

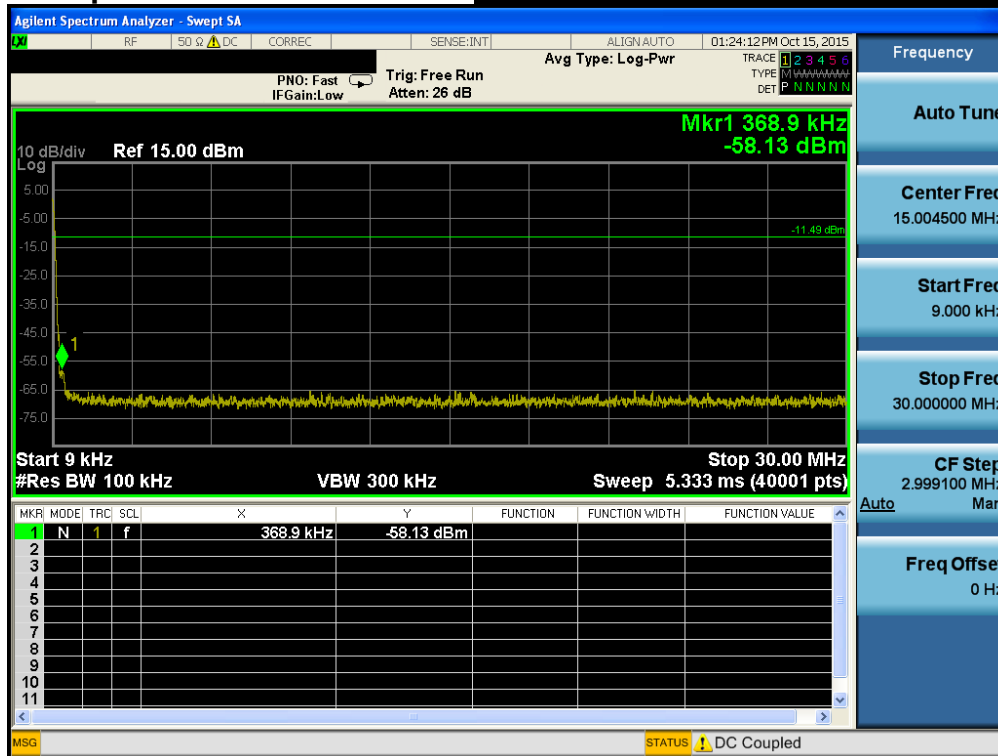

Conducted Spurious Emissions *Middle Channel & Modulation : GFSK*

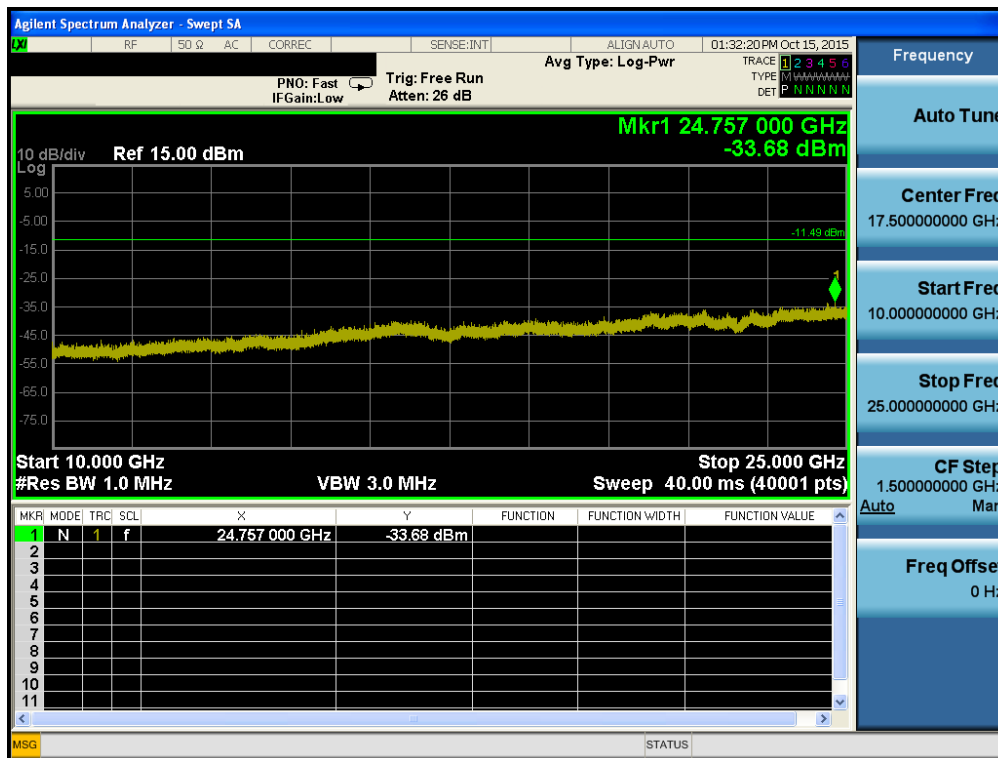
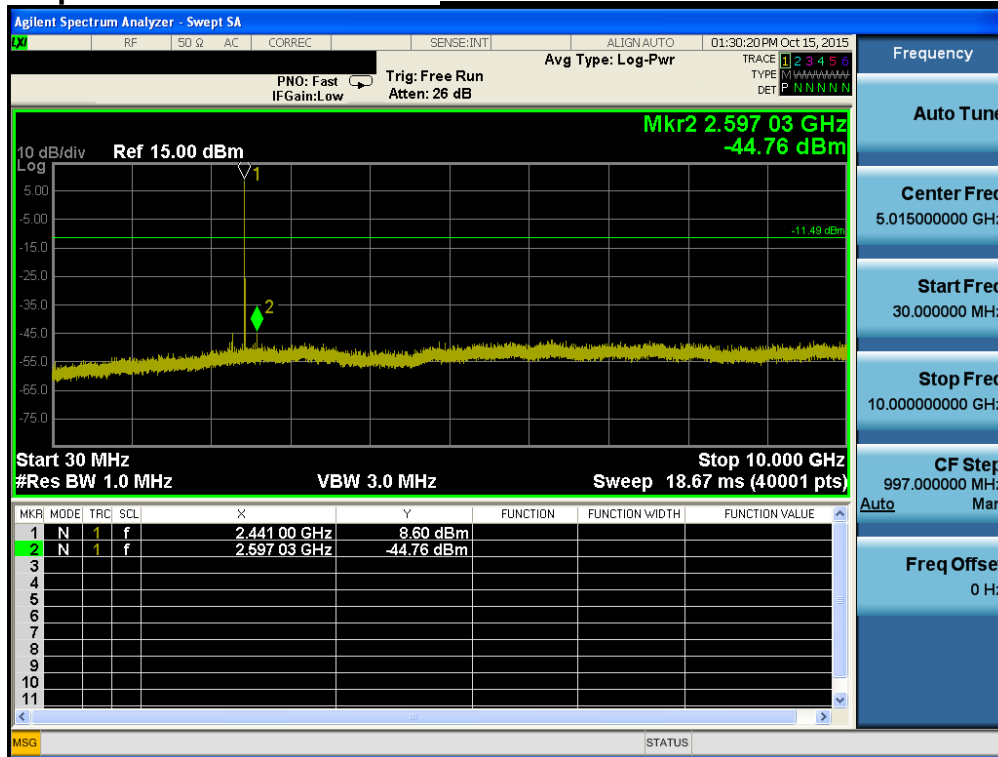

High Band-edge

Highest Channel & Modulation : GFSK

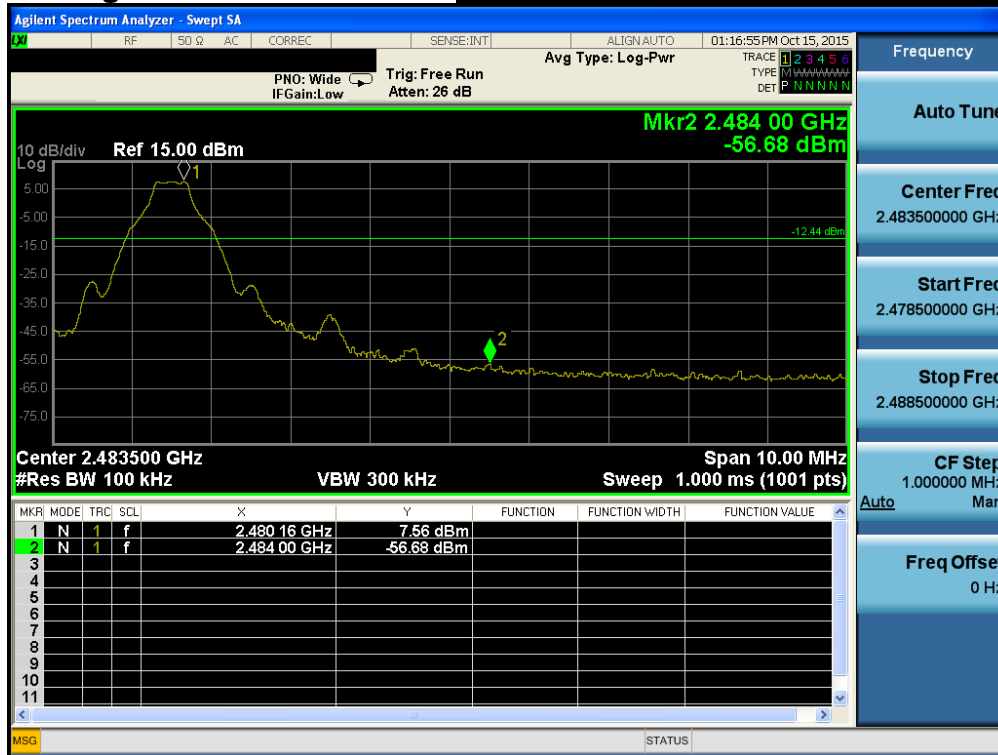

High Band-edge

Hopping mode & Modulation : GFSK



Conducted Spurious Emissions **Highest Channel & Modulation : GFSK**

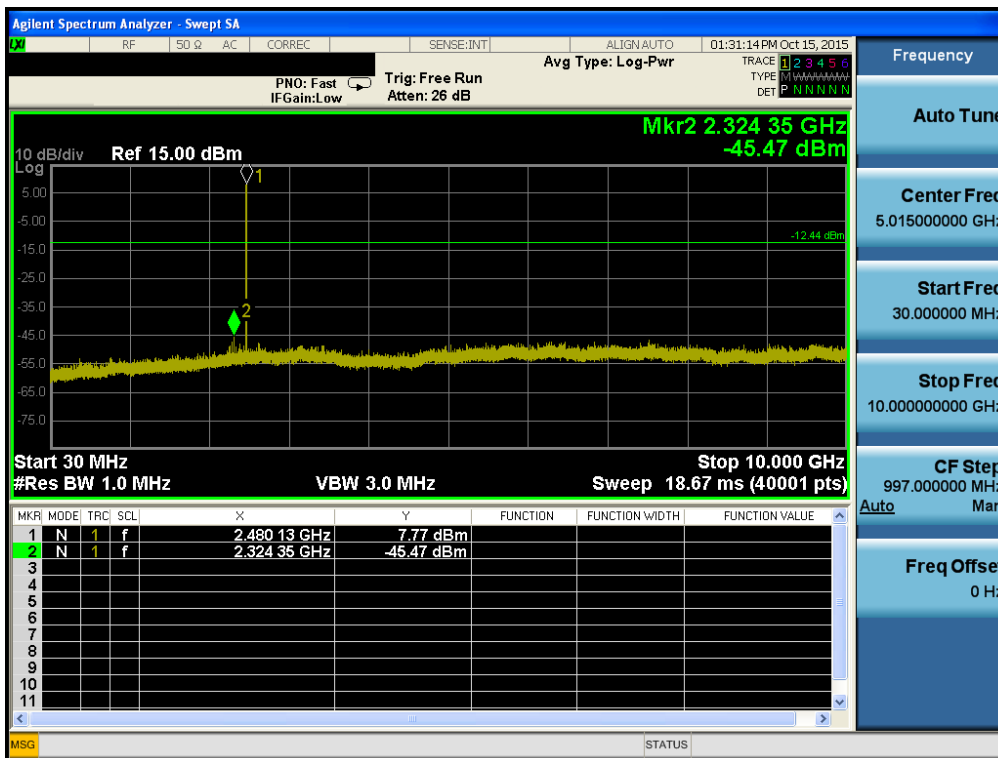
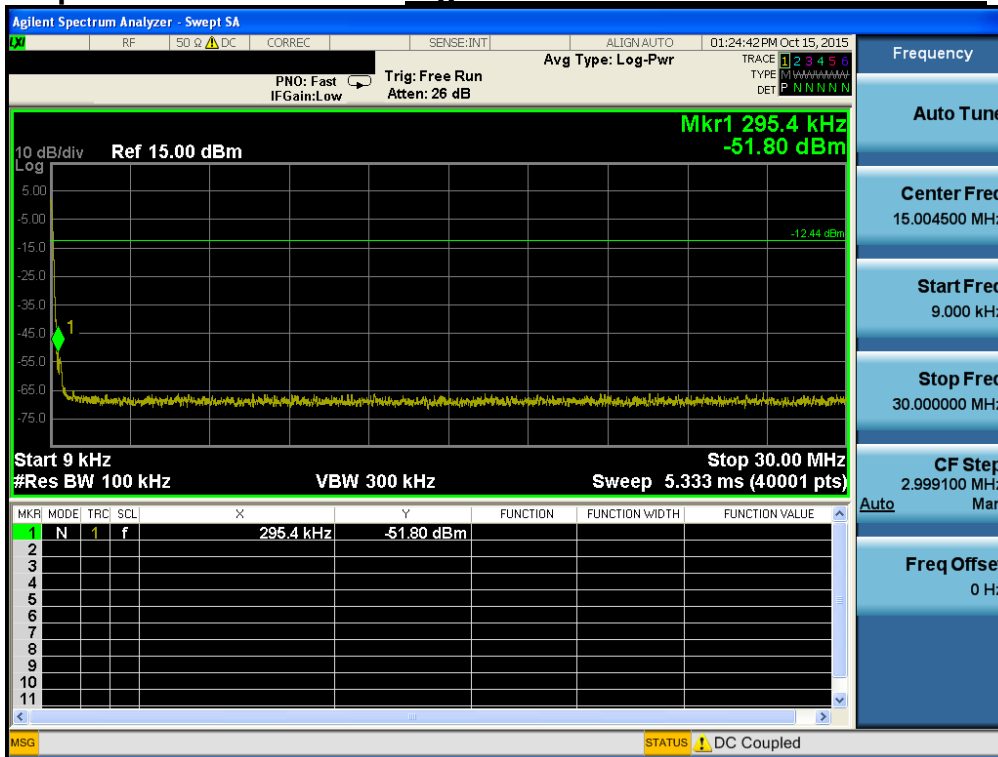

Conducted Spurious Emissions *Highest Channel & Modulation : GFSK*

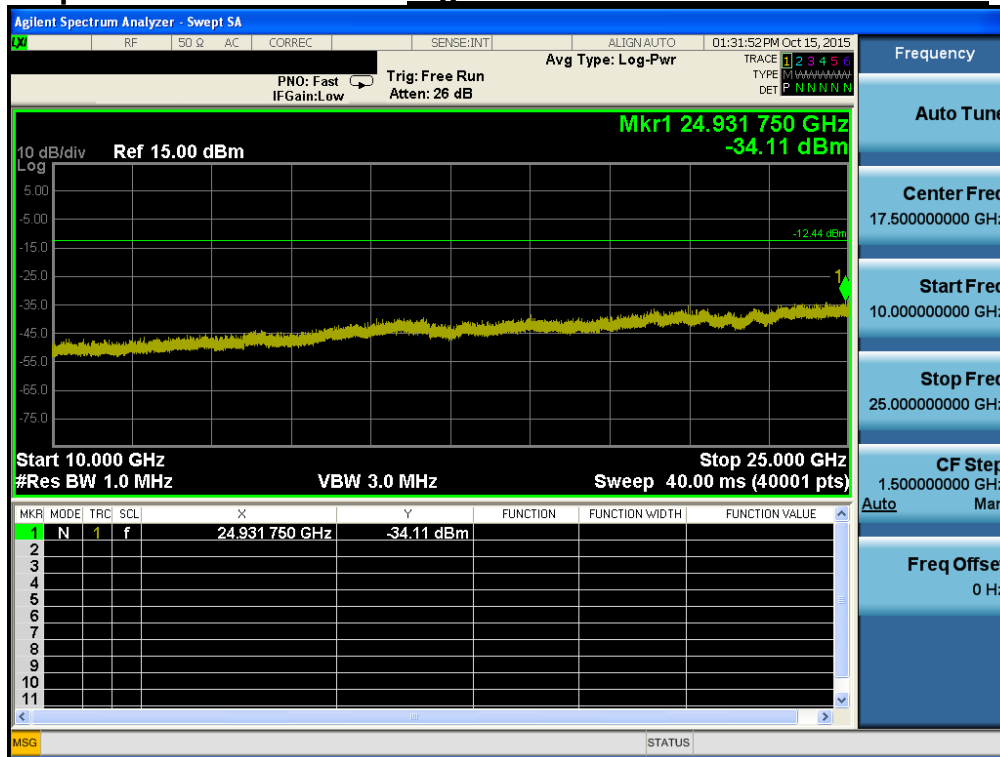

Low Band-edge

Lowest Channel & Modulation : $\pi/4$ DQPSK



Low Band-edge

Hopping mode & Modulation : $\pi/4$ DQPSK



Conducted Spurious Emissions **Lowest Channel & Modulation : $\pi/4$ DQPSK**

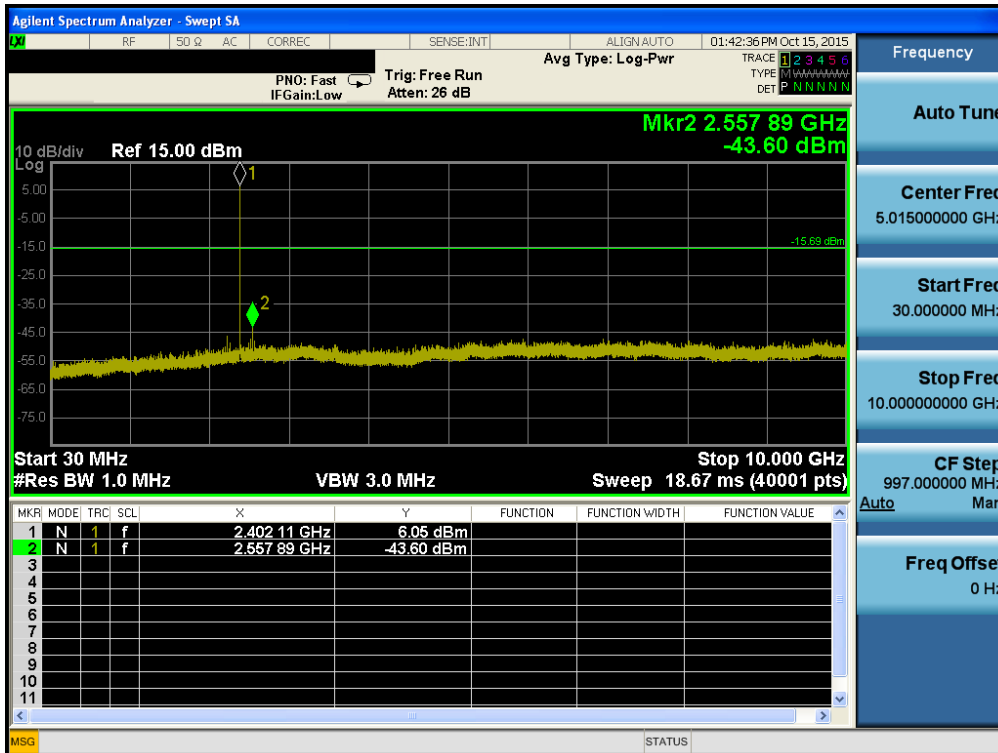
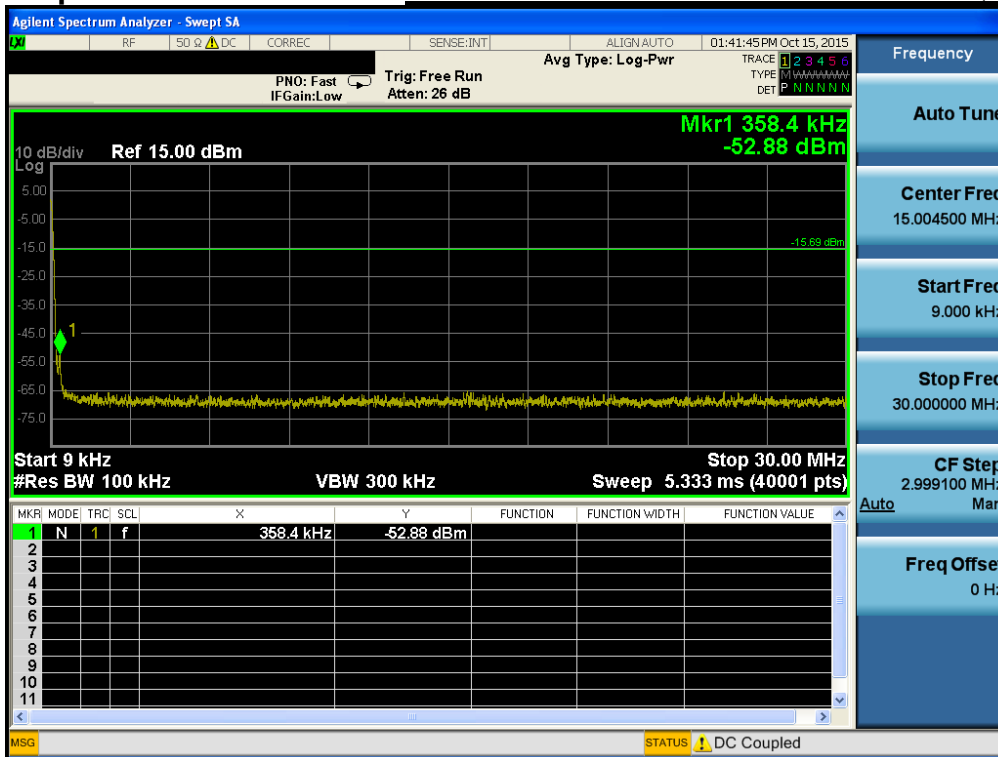

Conducted Spurious Emissions ***Lowest Channel & Modulation : $\pi/4$ DQPSK***

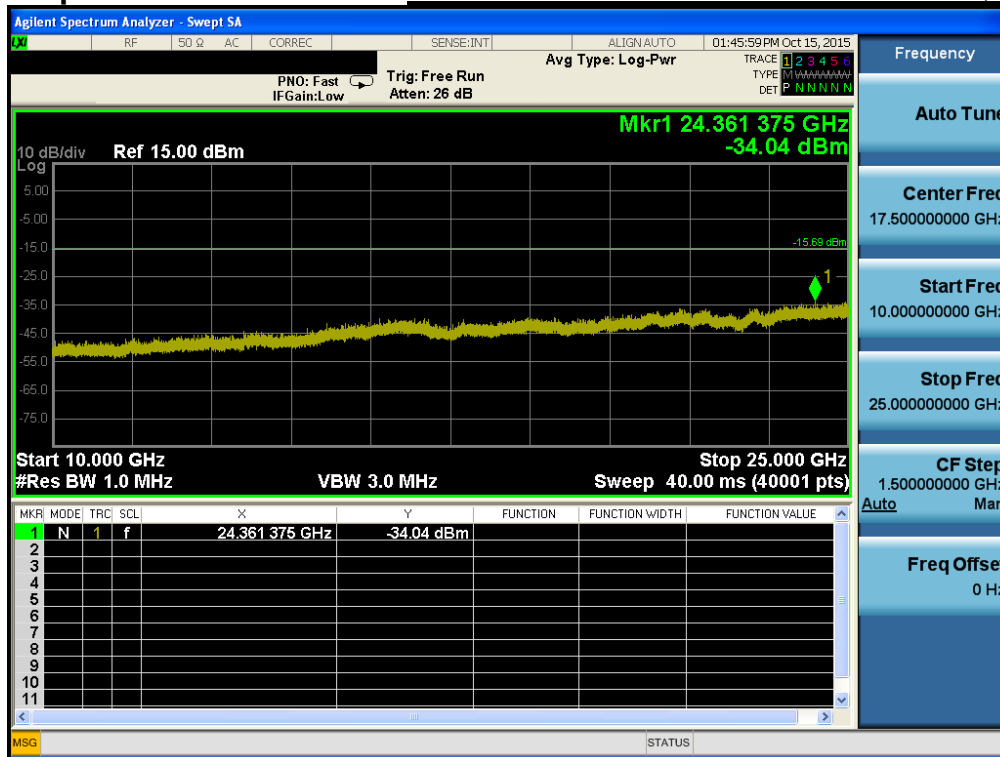

Reference for limit

Middle Channel & Modulation : $\pi/4$ DQPSK



Conducted Spurious Emissions

Middle Channel & Modulation : $\pi/4$ DQPSK

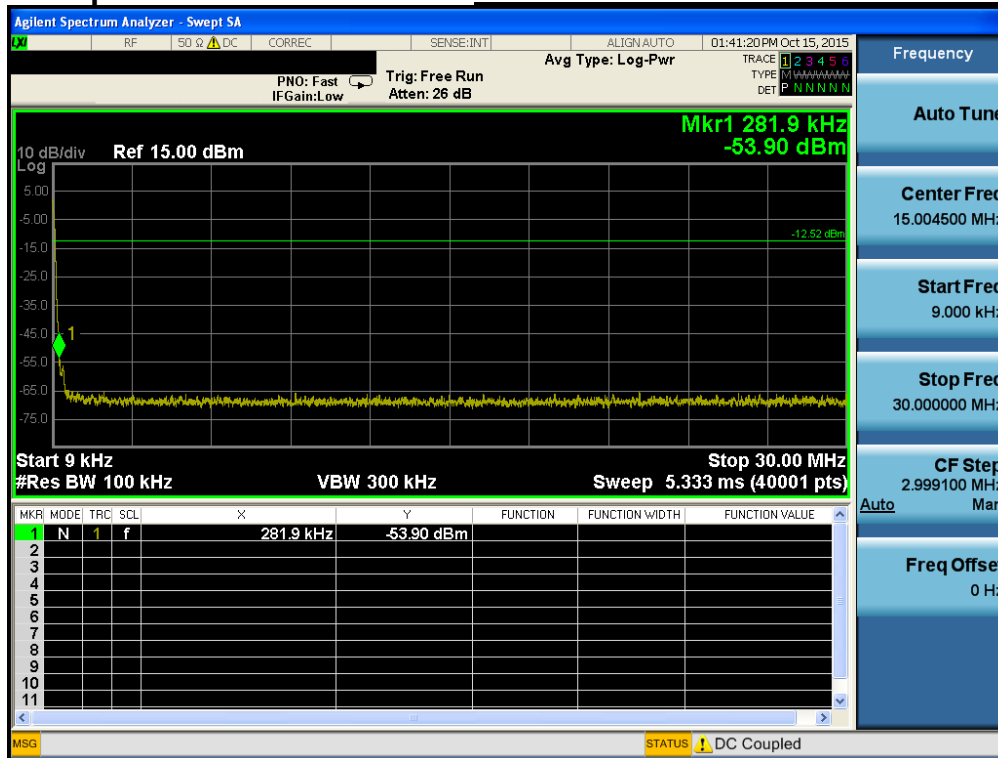

Conducted Spurious Emissions *Middle Channel & Modulation : $\pi/4$ QPSK*

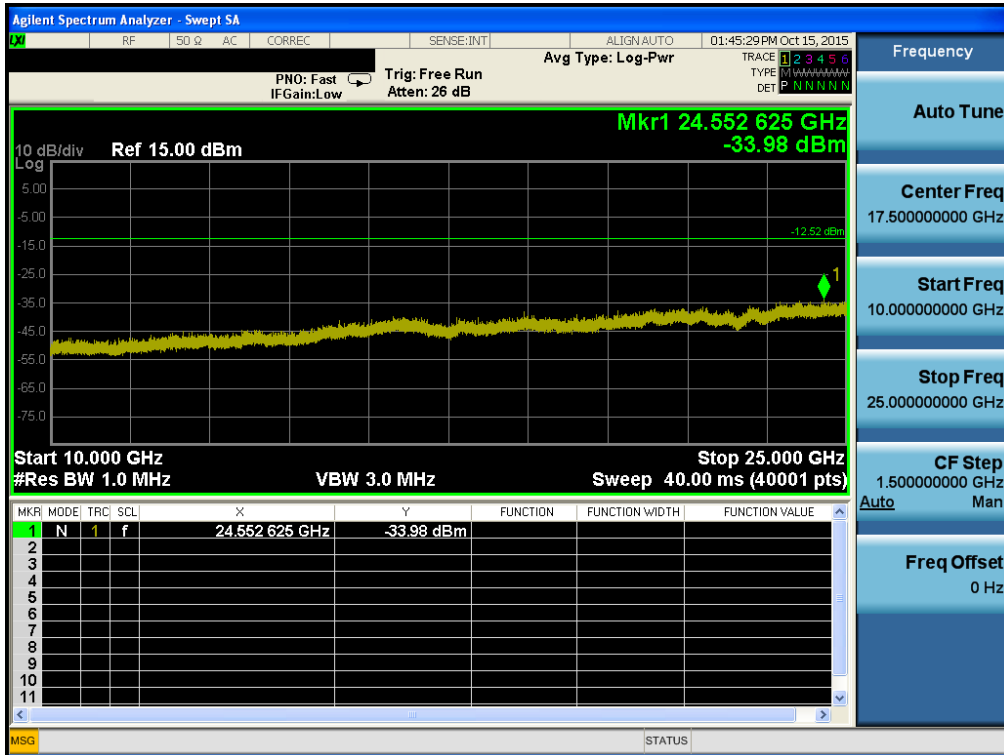
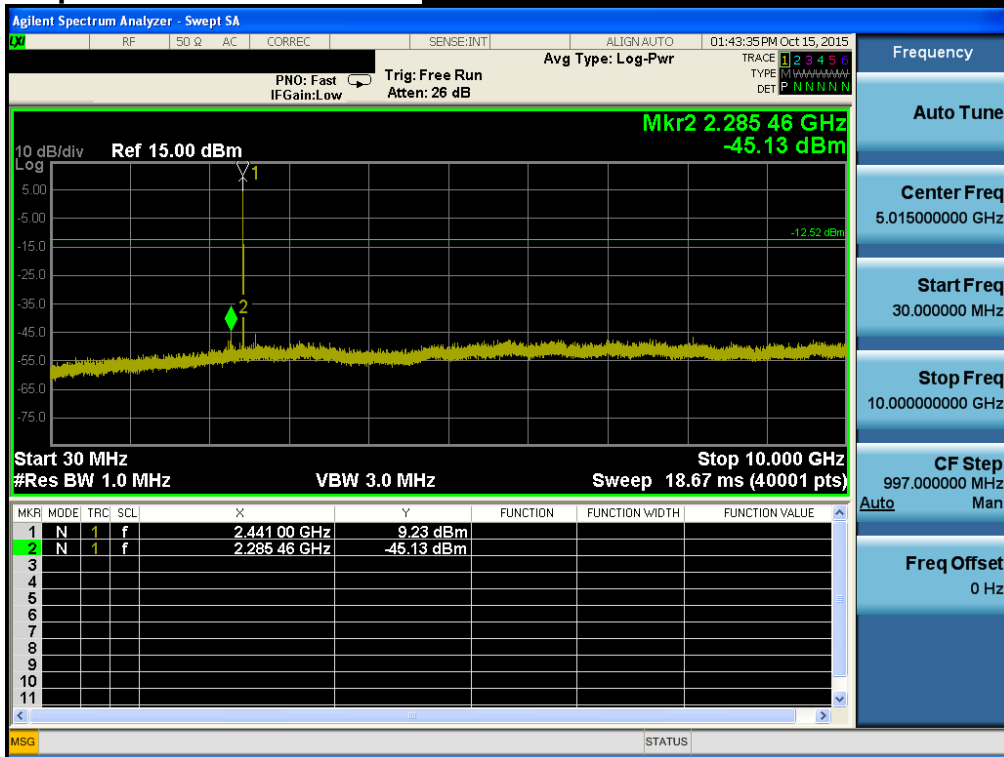

High Band-edge

Highest Channel & Modulation : $\pi/4$ DQPSK



High Band-edge

Hopping mode & Modulation : $\pi/4$ DQPSK



Conducted Spurious Emissions

Highest Channel & Modulation : $\pi/4$ DQPSK

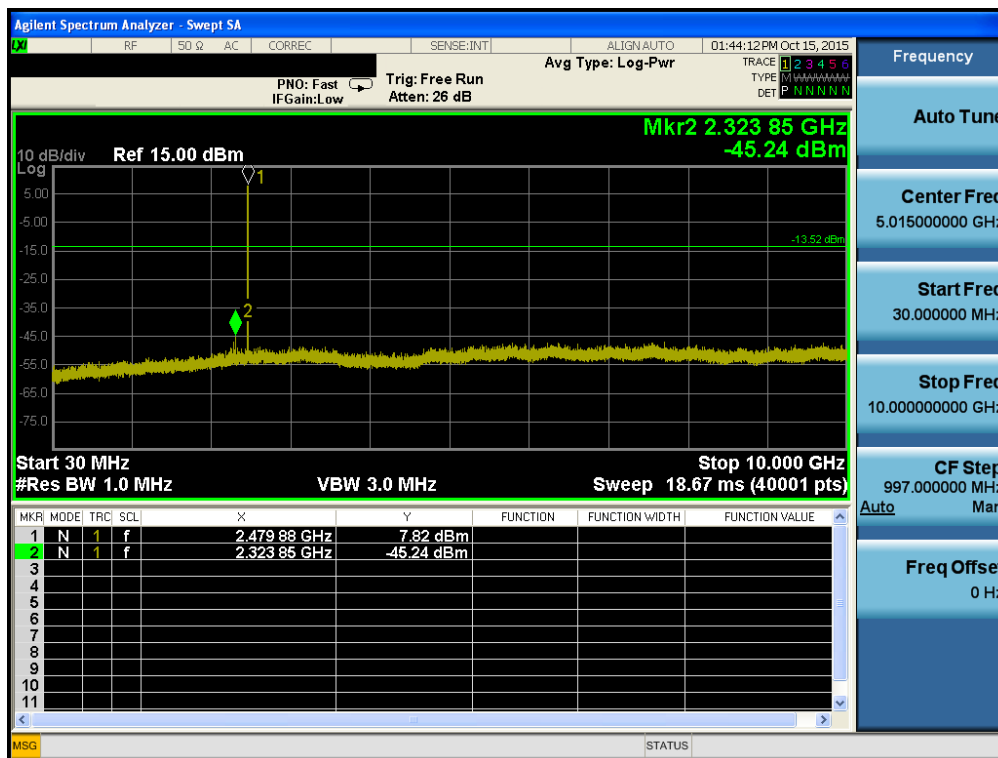
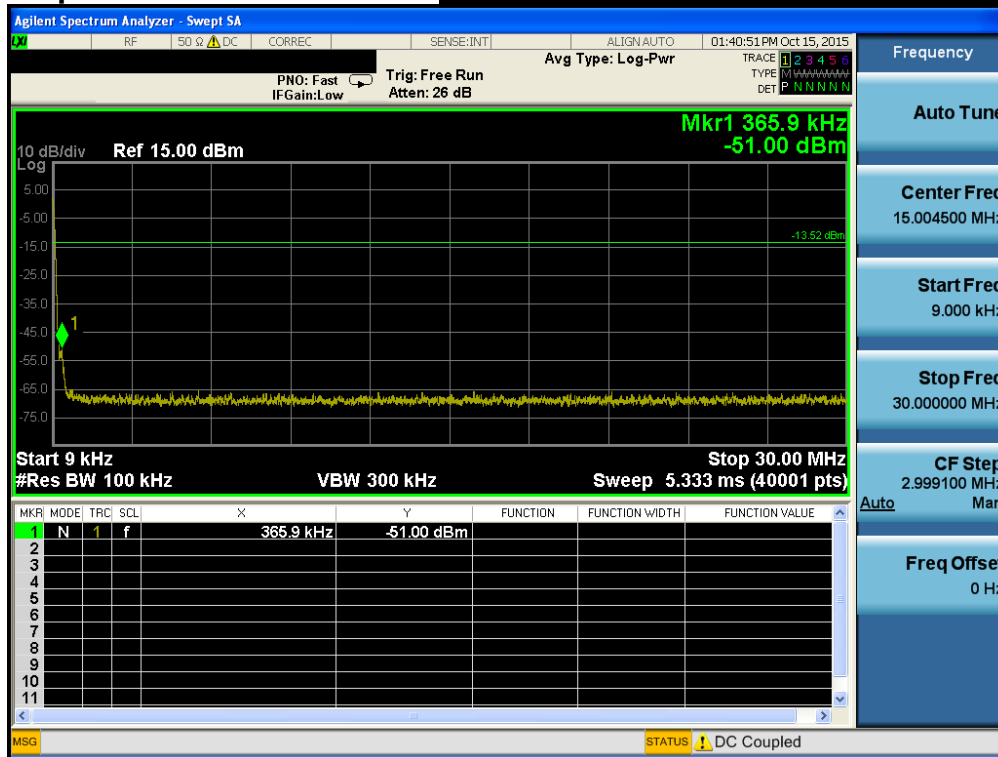

Conducted Spurious Emissions

Highest Channel & Modulation : $\pi/4$ DQPSK

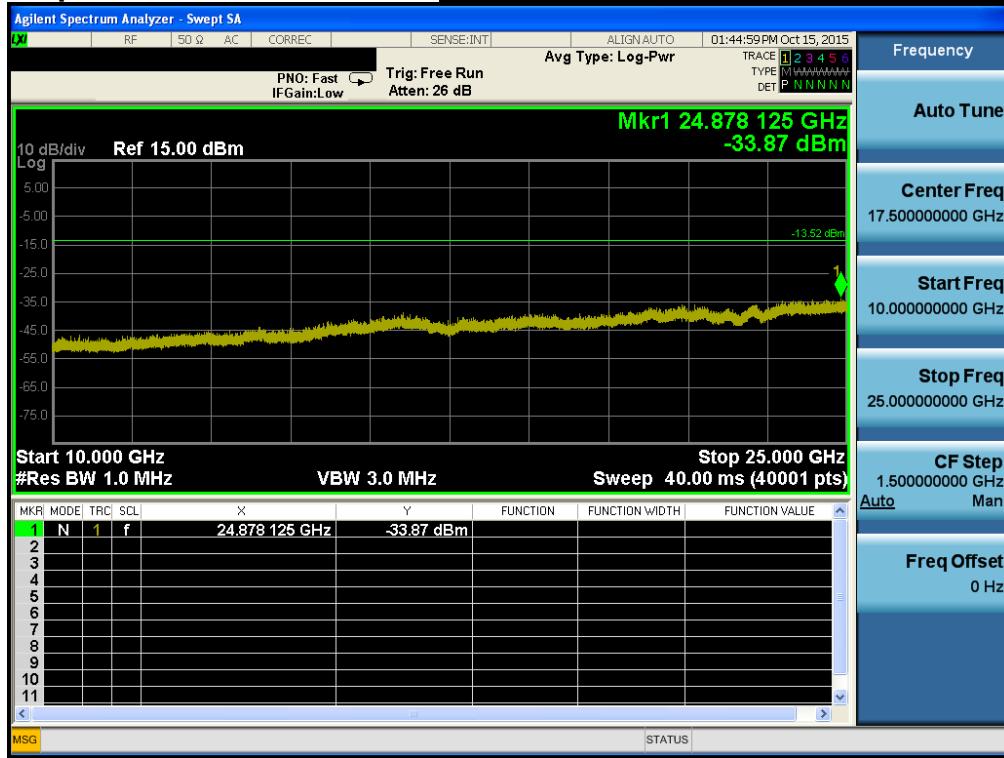

Low Band-edge

Lowest Channel & Modulation : 8DPSK

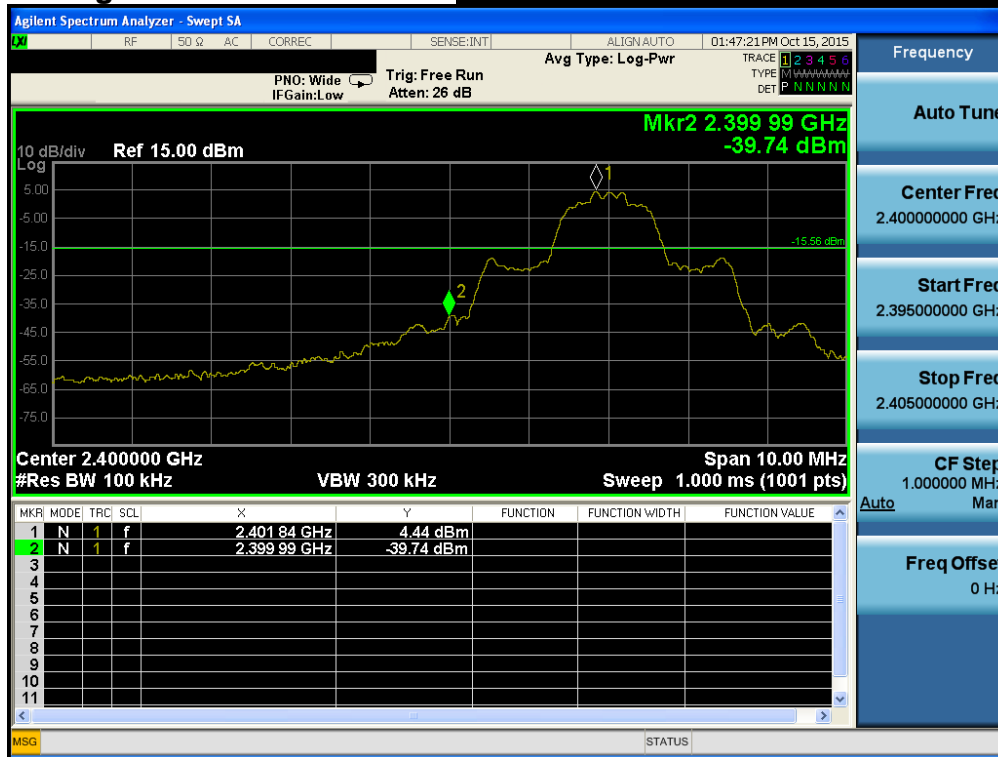

Low Band-edge

Hopping mode & Modulation : 8DPSK



Conducted Spurious Emissions *Lowest Channel & Modulation : 8DPSK*

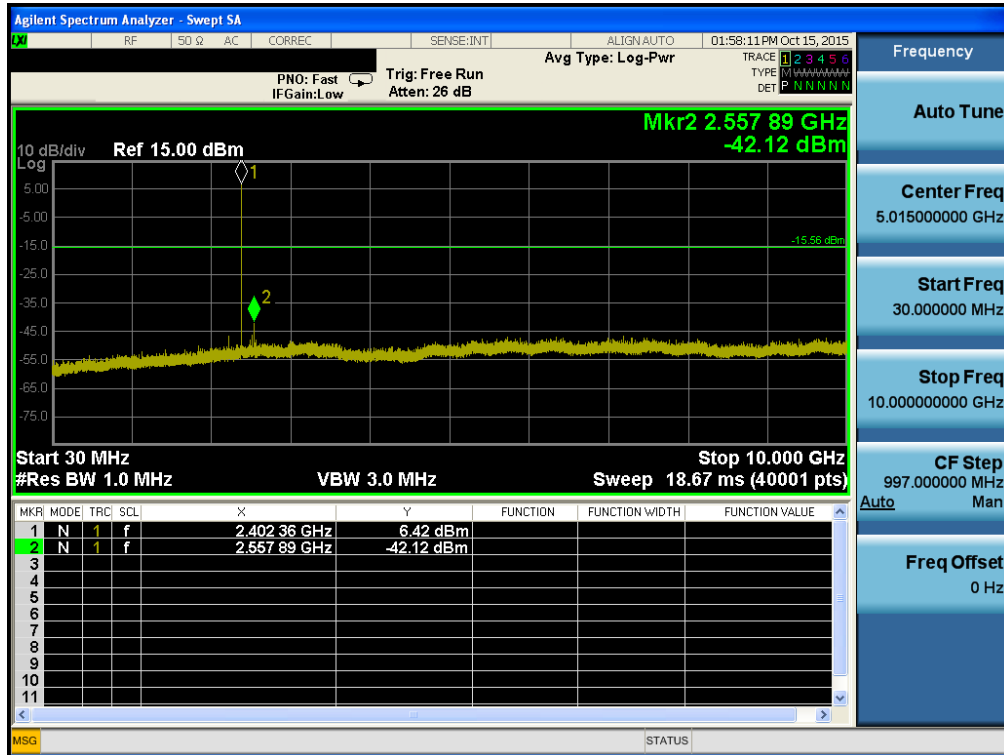
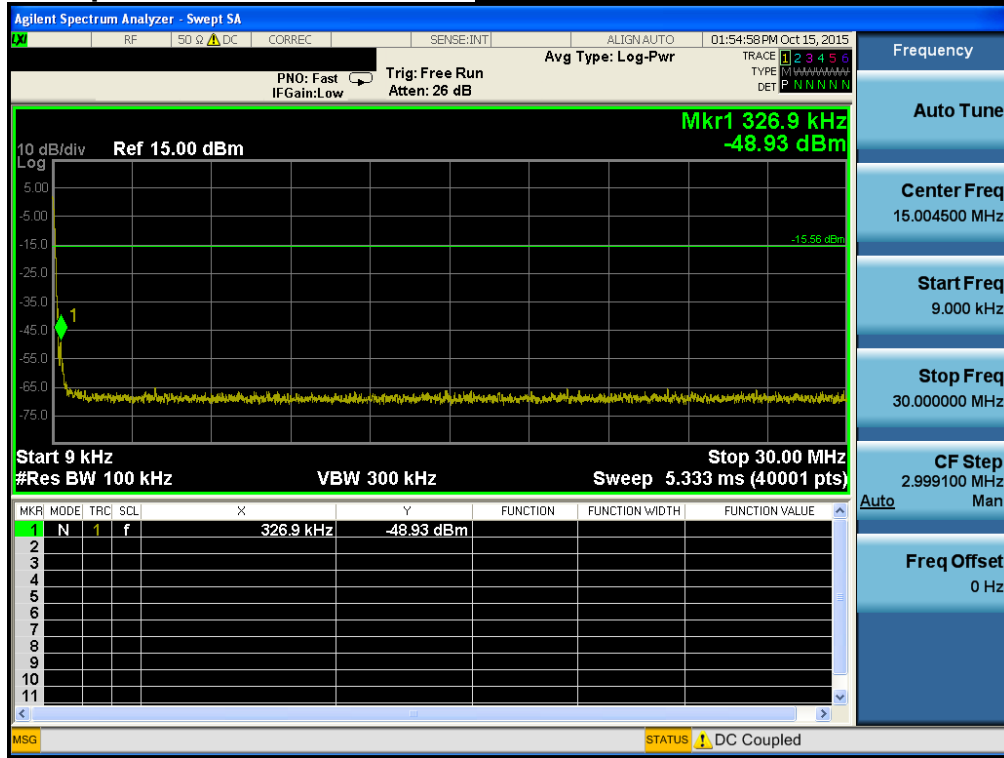

Conducted Spurious Emissions *Lowest Channel & Modulation : 8DPSK*

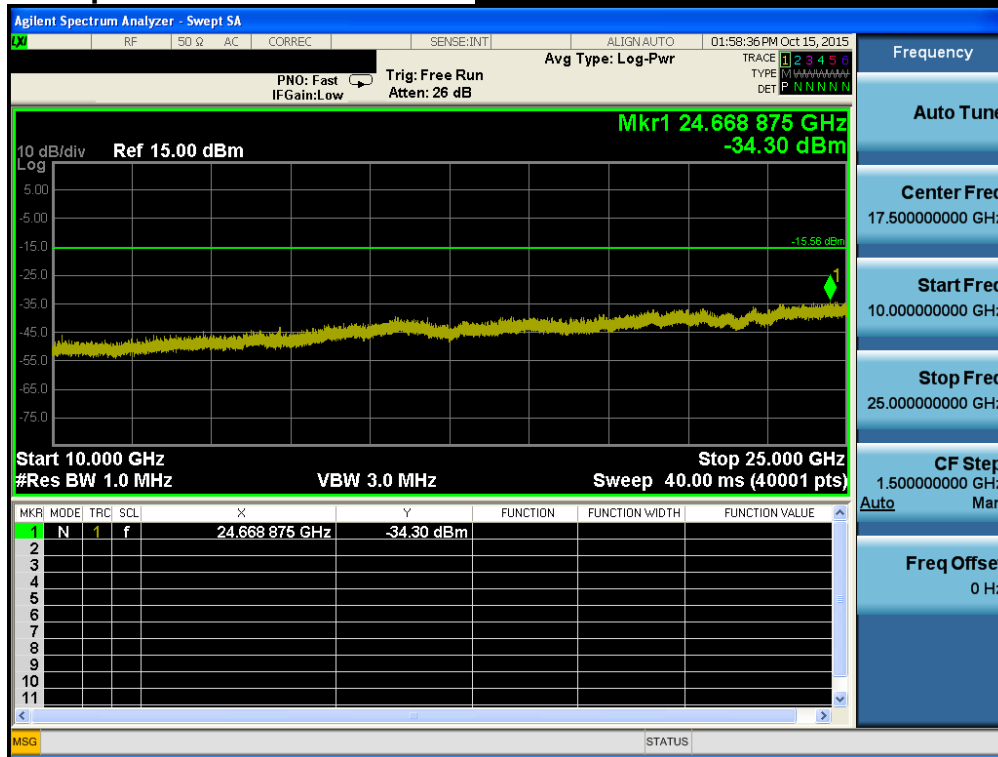

Reference for limit

Middle Channel & Modulation : 8DPSK



Conducted Spurious Emissions

Middle Channel & Modulation : 8DPSK

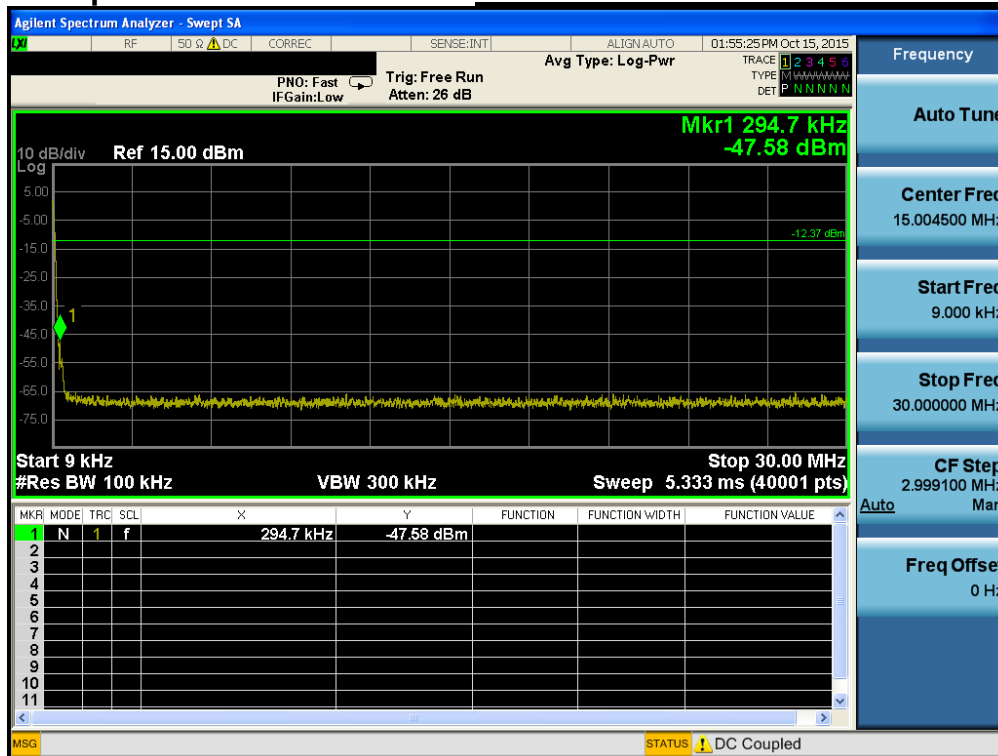

Conducted Spurious Emissions *Middle Channel & Modulation : 8DPSK*

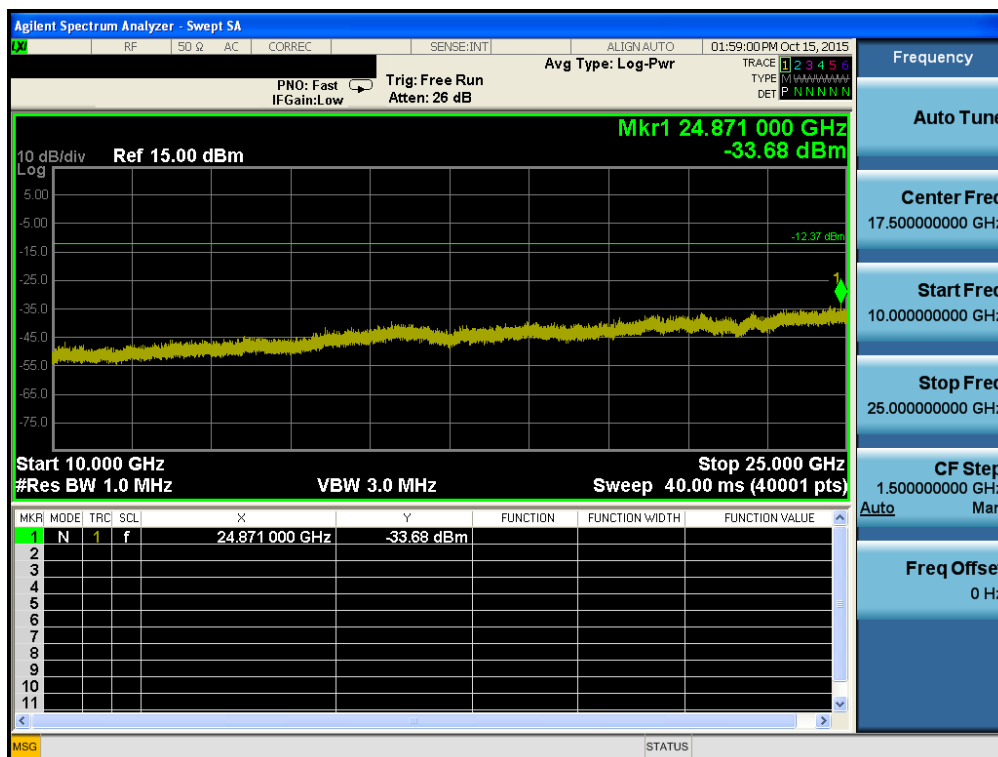
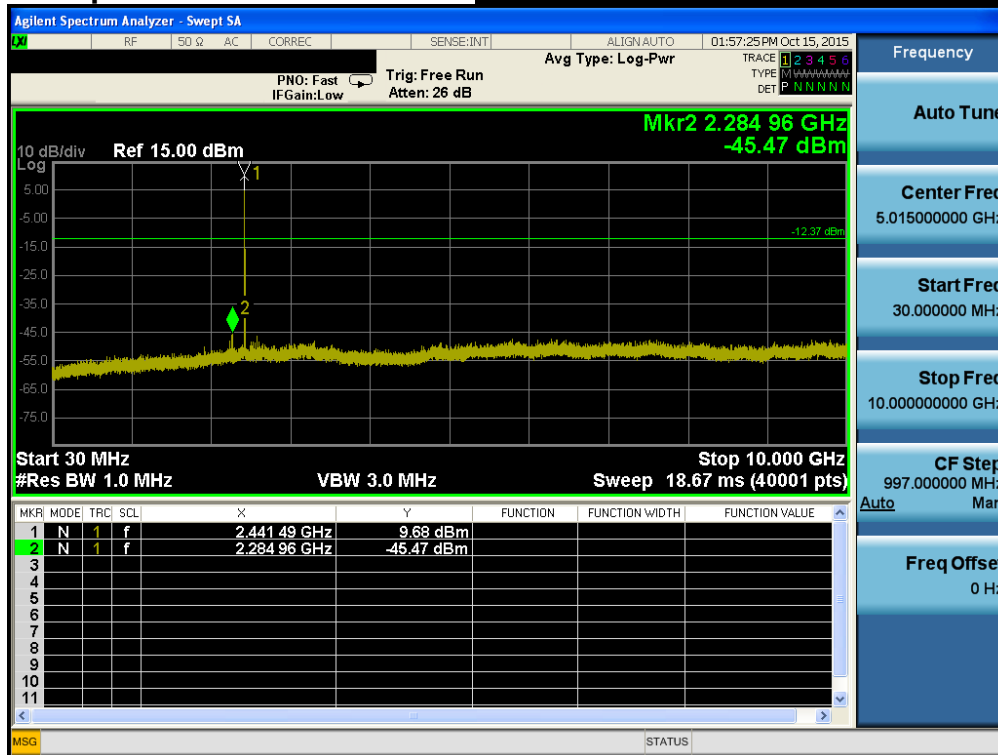

High Band-edge

Highest Channel & Modulation : 8DPSK



High Band-edge

Hopping mode & Modulation : 8DPSK



Conducted Spurious Emissions *Highest Channel & Modulation : 8DPSK*

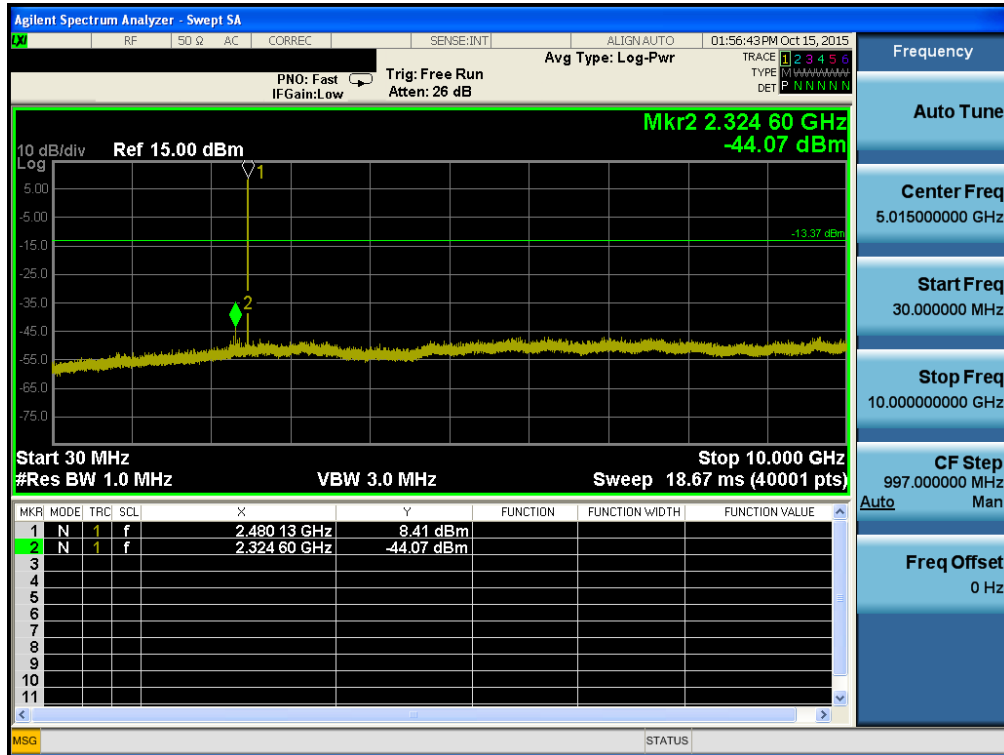
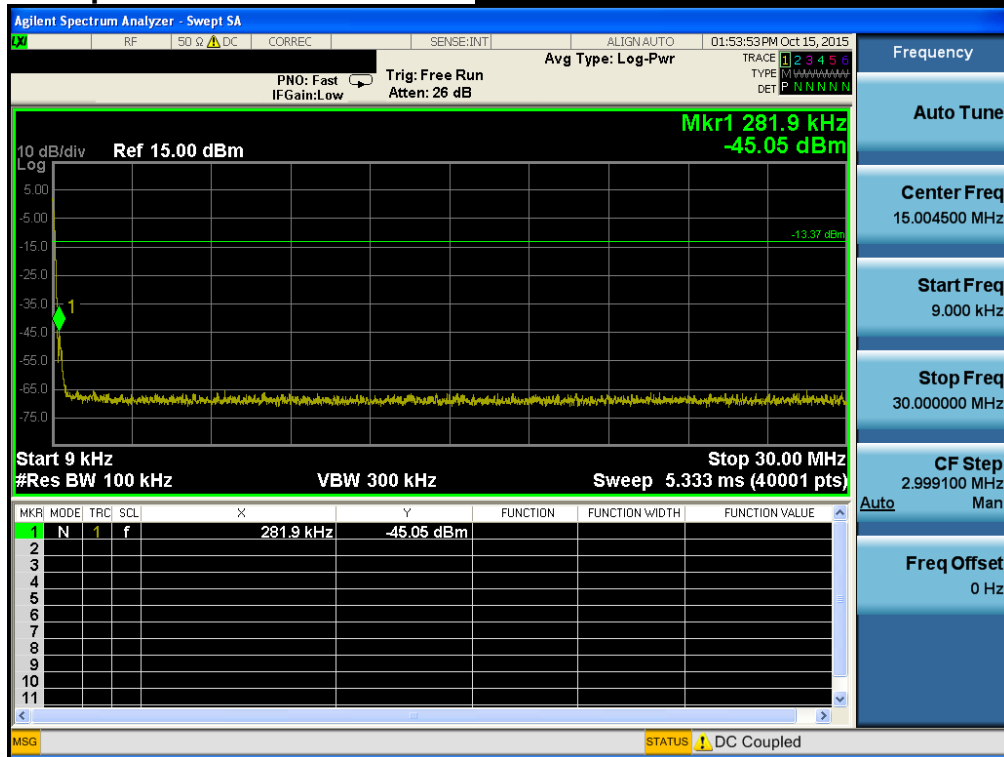

Conducted Spurious Emissions

Highest Channel & Modulation : 8DPSK

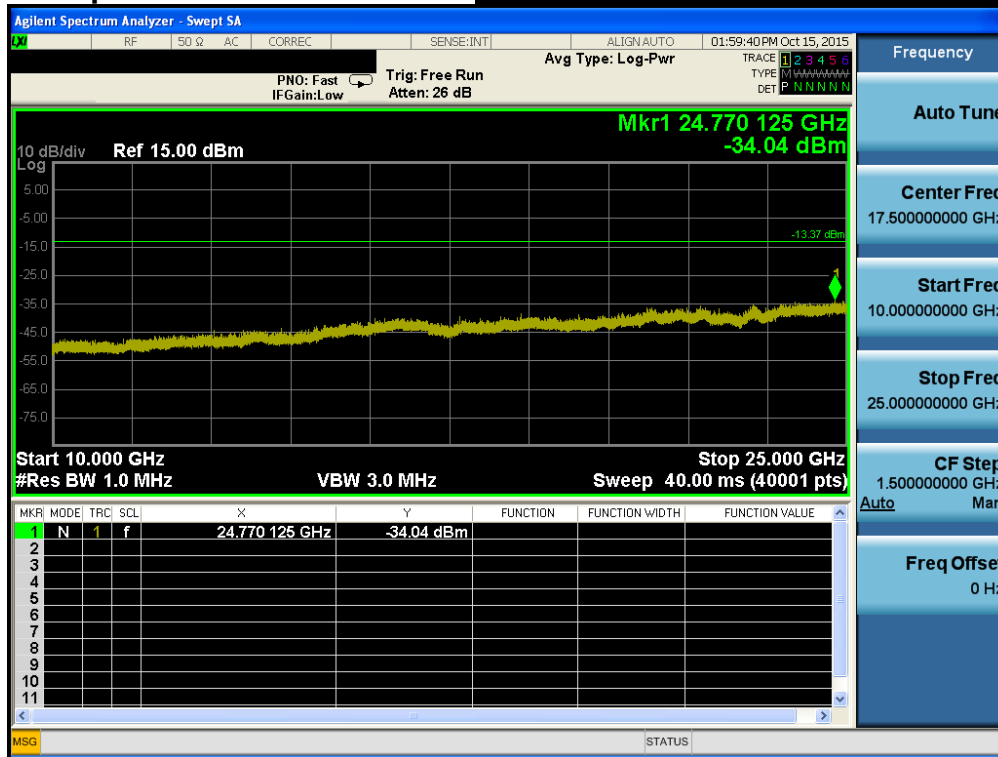

8. Transmitter AC Power Line Conducted Emission

8.1 Test Setup

Refer to test setup photo.

8.2 Limit

According to §15.207(a) for an intentional radiator that is designed to be connected to the public utility (AC) power line, the radio frequency voltage that is conducted back onto the AC power line on any frequency or frequencies, within the band 150 kHz to 30 MHz, shall not exceed the limits in the following table, as measured using a 50 uH/50 ohm line impedance stabilization network (LISN).

Compliance with the provision of this paragraph shall on the measurement of the radio frequency voltage between each power line and ground at the power terminal. The lower applies at the boundary between the frequency ranges.

Frequency Range (MHz)	Conducted Limit (dBuV)	
	Quasi-Peak	Average
0.15 ~ 0.5	66 to 56 *	56 to 46 *
0.5 ~ 5	56	46
5 ~ 30	60	50

* Decreases with the logarithm of the frequency

8.3 Test Procedures

Conducted emissions from the EUT were measured according to the ANSI C63.10.

1. The test procedure is performed in a 6.5 m × 3.5 m × 3.5 m (L × W × H) shielded room. The EUT along with its peripherals were placed on a 1.0 m (W) × 1.5 m (L) and 0.8 m in height wooden table and the EUT was adjusted to maintain a 0.4 meter space from a vertical reference plane.
2. The EUT was connected to power mains through a line impedance stabilization network (LISN) which provides 50 ohm coupling impedance for measuring instrument and the chassis ground was bounded to the horizontal ground plane of shielded room.
3. All peripherals were connected to the second LISN and the chassis ground also bounded to the horizontal ground plane of shielded room.
4. The excess power cable between the EUT and the LISN was bundled. The power cables of peripherals were unbundled. All connecting cables of EUT and peripherals were moved to find the maximum emission.

8.4 Test Results

AC Line Conducted Emissions (Graph) = Modulation : GFSK

Results of Conducted Emission

DTNC		Date : 2015-10-29
Order No.	:	Reference No.
Model No.	: 10S	Power Supply
Serial No.	:	: 120 V 60 Hz
Test Condition	: BT_1Mbps	Temp/Humi.
		: 22 °C 46 % R.H.
		Operator
		: J.W.Kim
Memo	:	
LIMIT : FCC P15.207 QP		
FCC P15.207 AV		

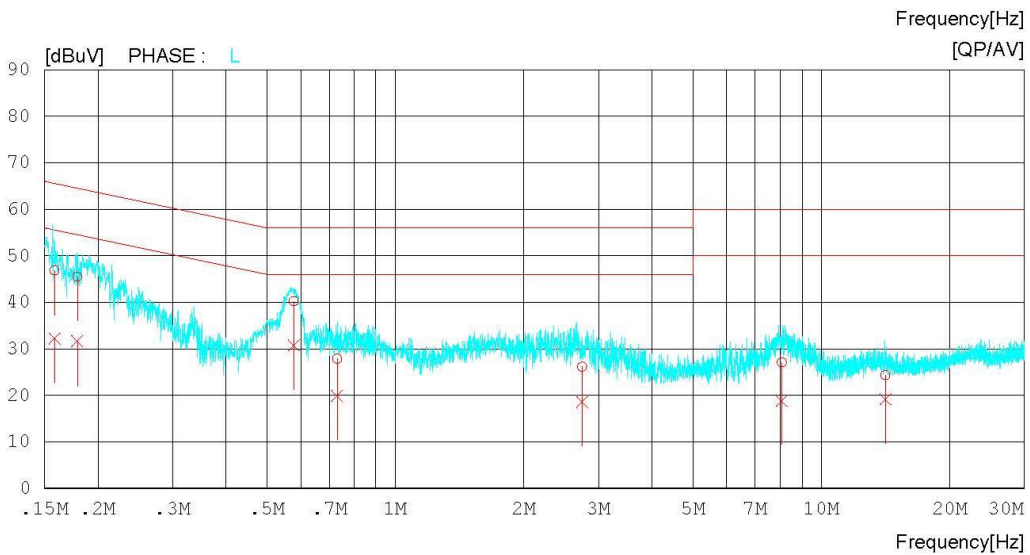
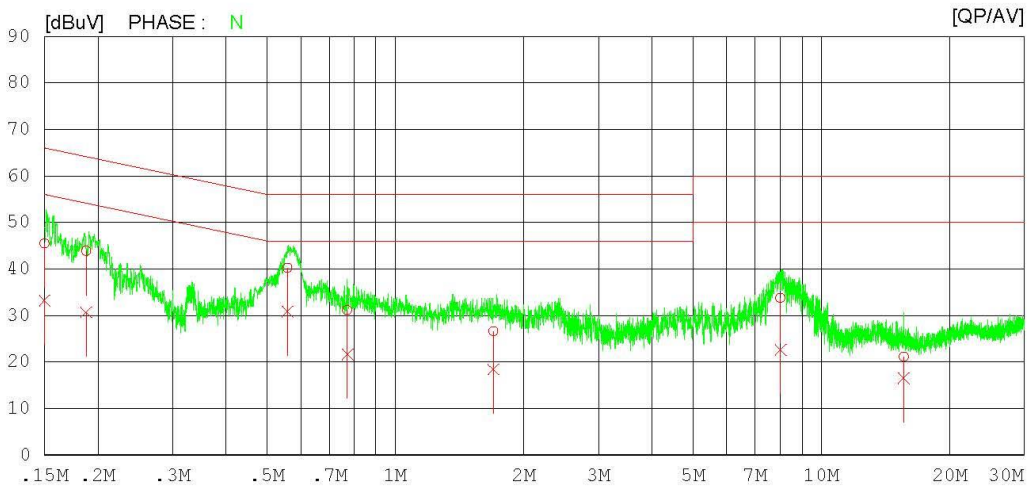



AC Line Conducted Emissions (List) = Modulation : GFSK

Results of Conducted Emission

DTNC

Date : 2015-10-29

Order No.	:		Reference No.	:	
Model No.	:	10S	Power Supply	:	120 V 60 Hz
Serial No.	:		Temp/Humi.	:	22 'C 46 % R.H.
Test Condition	:	BT_1Mbps	Operator	:	J.W.Kim

Memo :

LIMIT : FCC P15.207 QP
 FCC P15.207 AV

NO	FREQ [MHz]	READING		C. FACTOR [dB]	RESULT		LIMIT		MARGIN		PHASE
		QP [dBuV]	AV [dBuV]		QP [dBuV]	AV [dBuV]	QP [dBuV]	AV [dBuV]	QP [dBuV]	AV [dBuV]	
1	0.15000	35.3	23.2	10.1	45.4	33.3	66.0	56.0	20.6	22.7	N
2	0.18773	33.7	20.6	10.1	43.8	30.7	64.1	54.1	20.3	23.4	N
3	0.55777	30.2	20.7	10.1	40.3	30.8	56.0	46.0	15.7	15.2	N
4	0.77092	21.0	11.6	10.1	31.1	21.7	56.0	46.0	24.9	24.3	N
5	1.69900	16.4	8.2	10.2	26.6	18.4	56.0	46.0	29.4	27.6	N
6	8.02540	23.2	12.2	10.5	33.7	22.7	60.0	50.0	26.3	27.3	N
7	15.63120	10.6	6.0	10.6	21.2	16.6	60.0	50.0	38.8	33.4	N
8	0.15850	36.6	22.0	10.1	46.7	32.1	65.5	55.5	18.8	23.4	L
9	0.17892	35.3	21.5	10.1	45.4	31.6	64.5	54.5	19.1	22.9	L
10	0.57804	30.1	20.6	10.1	40.2	30.7	56.0	46.0	15.8	15.3	L
11	0.72926	17.8	9.8	10.1	27.9	19.9	56.0	46.0	28.1	26.1	L
12	2.74440	15.9	8.3	10.2	26.1	18.5	56.0	46.0	29.9	27.5	L
13	8.07820	16.4	8.2	10.6	27.0	18.8	60.0	50.0	33.0	31.2	L
14	14.14080	13.5	8.3	10.8	24.3	19.1	60.0	50.0	35.7	30.9	L

9. Antenna Requirement

Describe how the EUT complies with the requirement that either its antenna is permanently attached, or that it employs a unique antenna connector, for every antenna proposed for use with the EUT.

Conclusion: Comply

The antenna is permanently attached. (Refer to Internal photo file.)

- Minimum Standard :

An intentional radiator shall be designed to ensure that no antenna other than that furnished by the responsible party shall be used with the device. The use of a permanently attached antenna or of an antenna that uses a unique coupling to the intentional radiator shall be considered sufficient to comply with the provisions.

10. Occupied Bandwidth (99 %)

10.1 Test Setup

Refer to the APPENDIX I.

10.2 Limit

Limit : Not Applicable

10.3 Test Procedure

The 99 % power bandwidth was measured with a calibrated spectrum analyzer.

The resolution bandwidth (RBW) shall be in the range of 1 % to 5 % of the occupied bandwidth (OBW) and video bandwidth (VBW) shall be approximately 3 × RBW.

Spectrum analyzer plots are included on the following pages.

10.4 Test Results

Test Mode	Tested Channel	Test Results (MHz)
<u>GFSK</u>	Lowest	0.869
	Middle	0.866
	Highest	0.868
<u>$\pi/4$DQPSK</u>	Lowest	1.247
	Middle	1.290
	Highest	1.246
<u>8DPSK</u>	Lowest	1.210
	Middle	1.235
	Highest	1.237

Occupied Bandwidth (99 %)

Lowest Frequency & GFSK

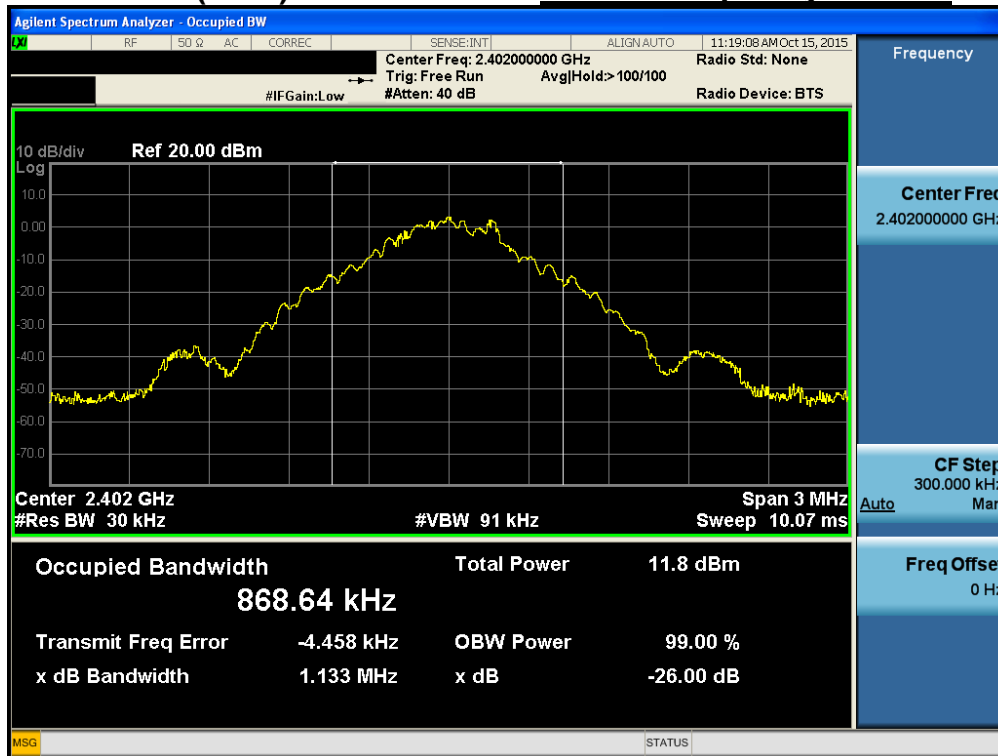

Occupied Bandwidth (99 %)

Middle Frequency & GFSK

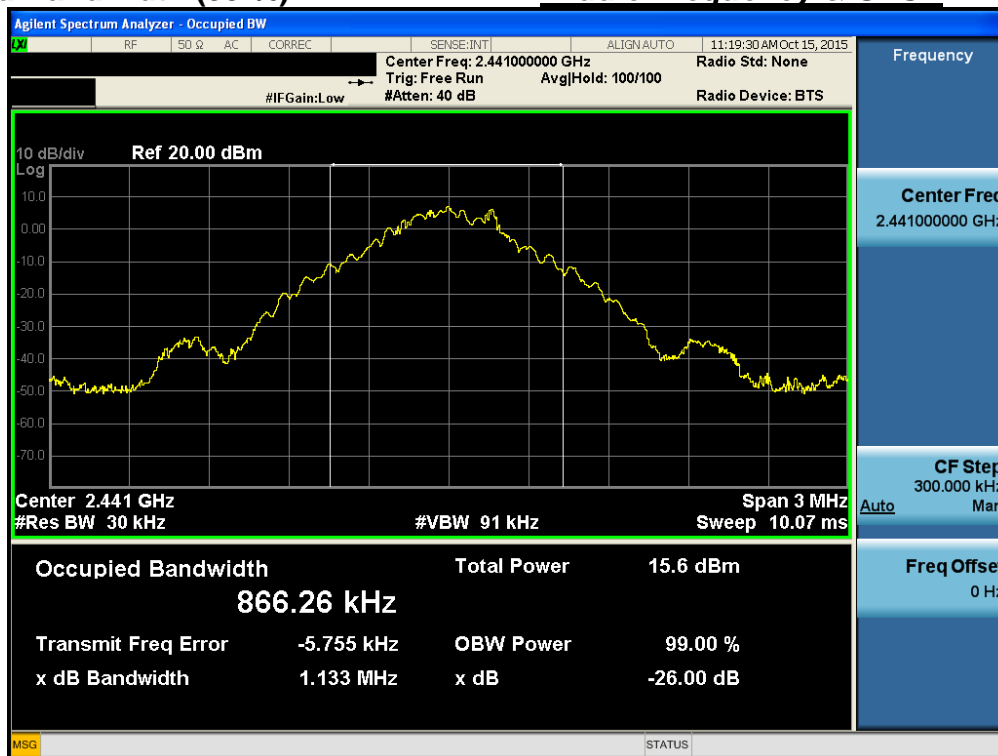

Occupied Bandwidth (99 %)

Highest Frequency & GFSK

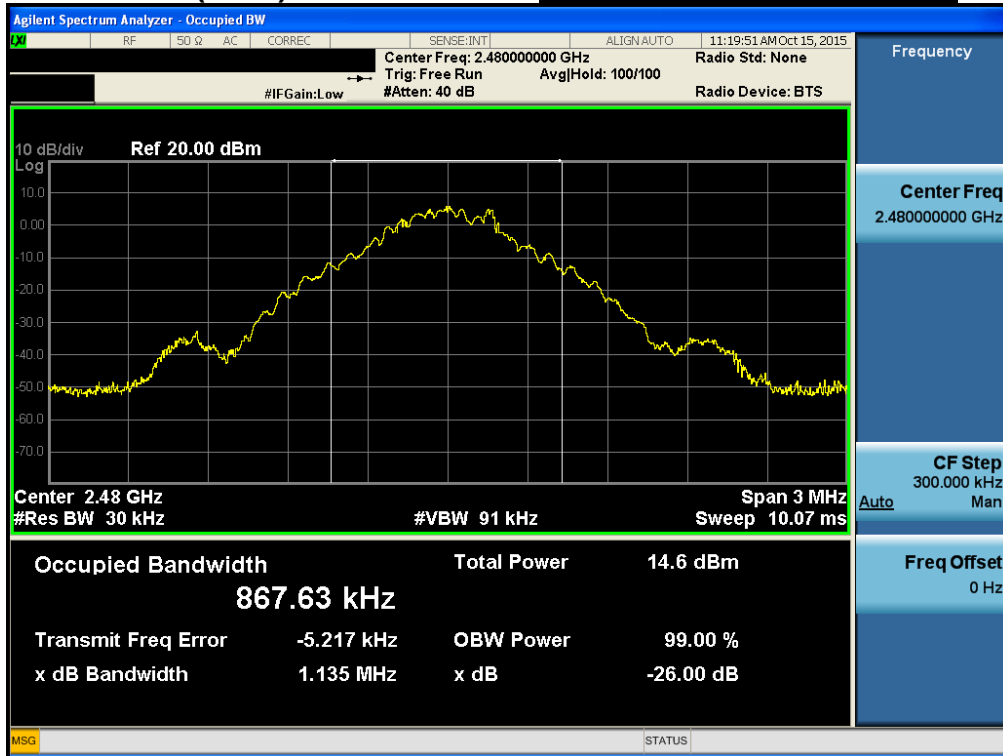

Occupied Bandwidth (99 %)

Lowest Frequency & $\pi/4$ DQPSK

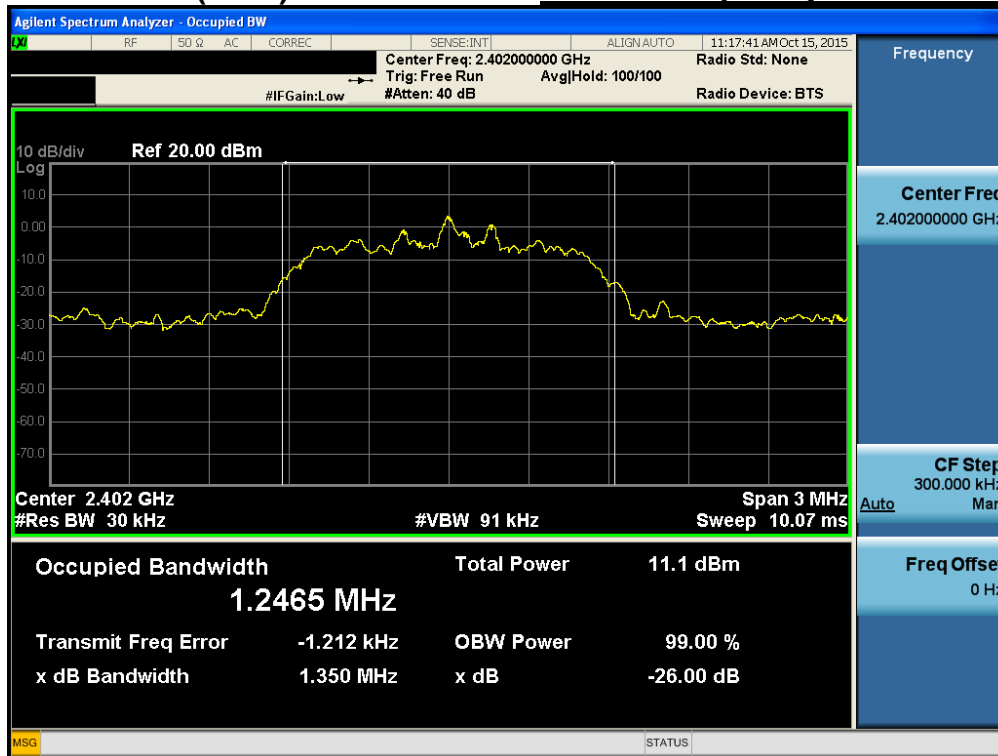

Occupied Bandwidth (99 %)

Middle Frequency & $\pi/4$ DQPSK

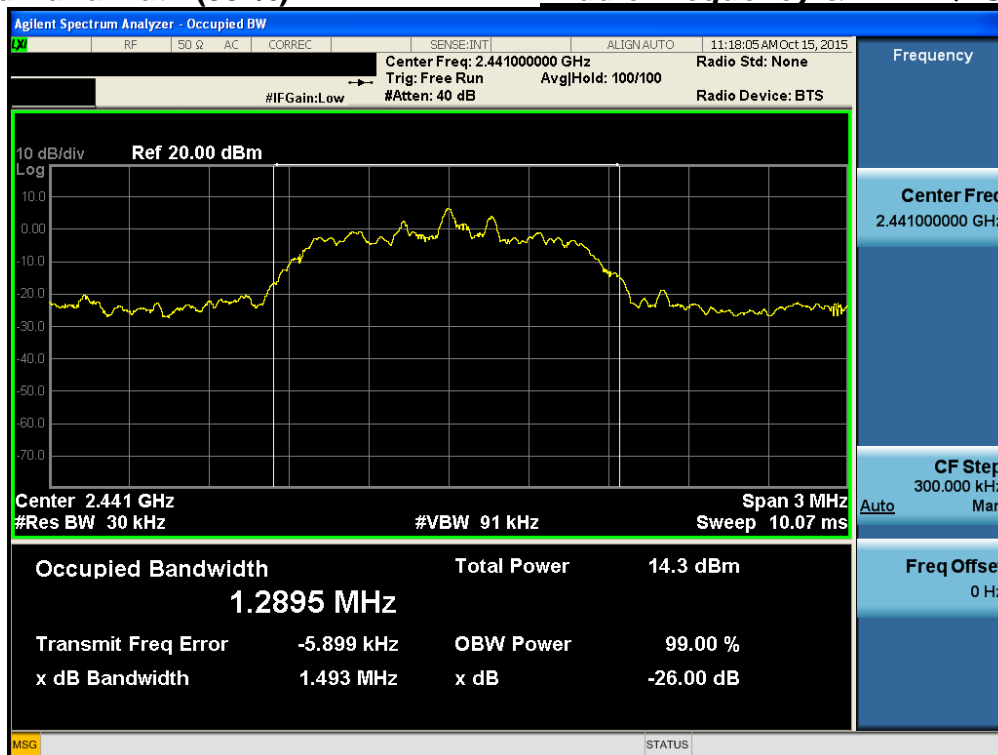

Occupied Bandwidth (99 %)

Highest Frequency & $\pi/4$ DQPSK

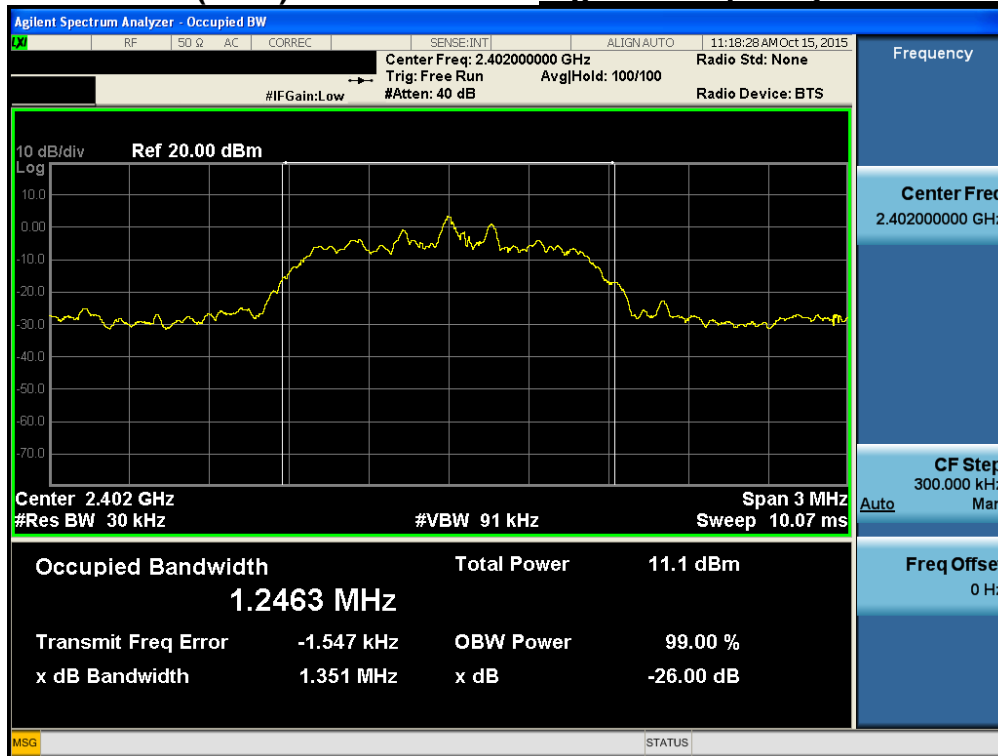

Occupied Bandwidth (99 %)

Lowest Frequency & 8DPSK

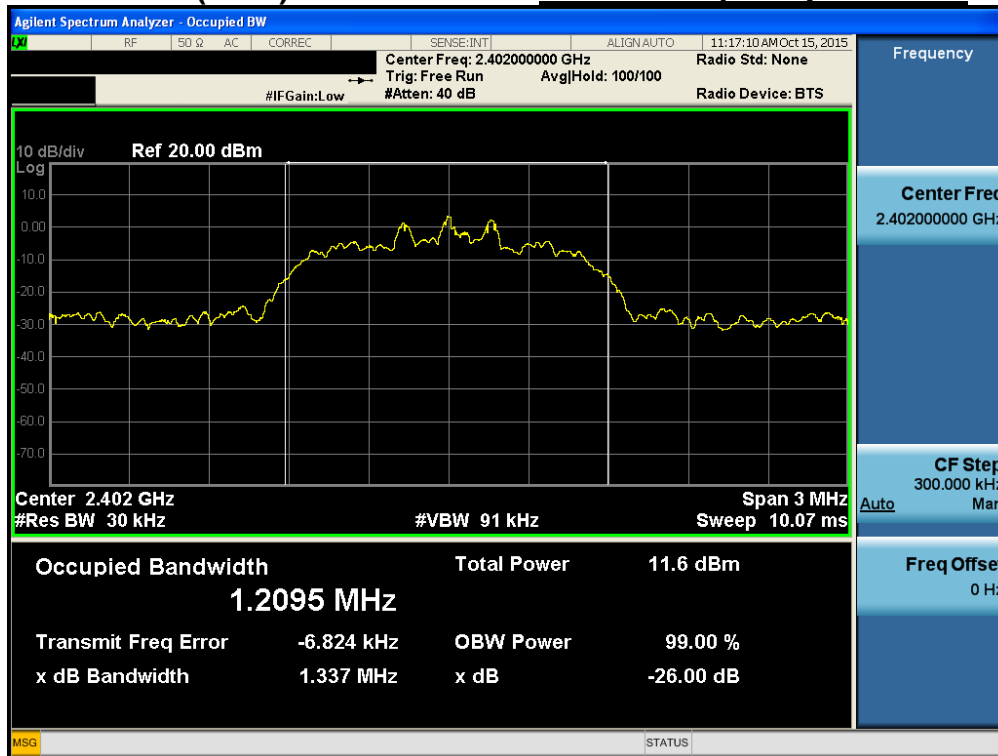

Occupied Bandwidth (99 %)

Middle Frequency & 8DPSK

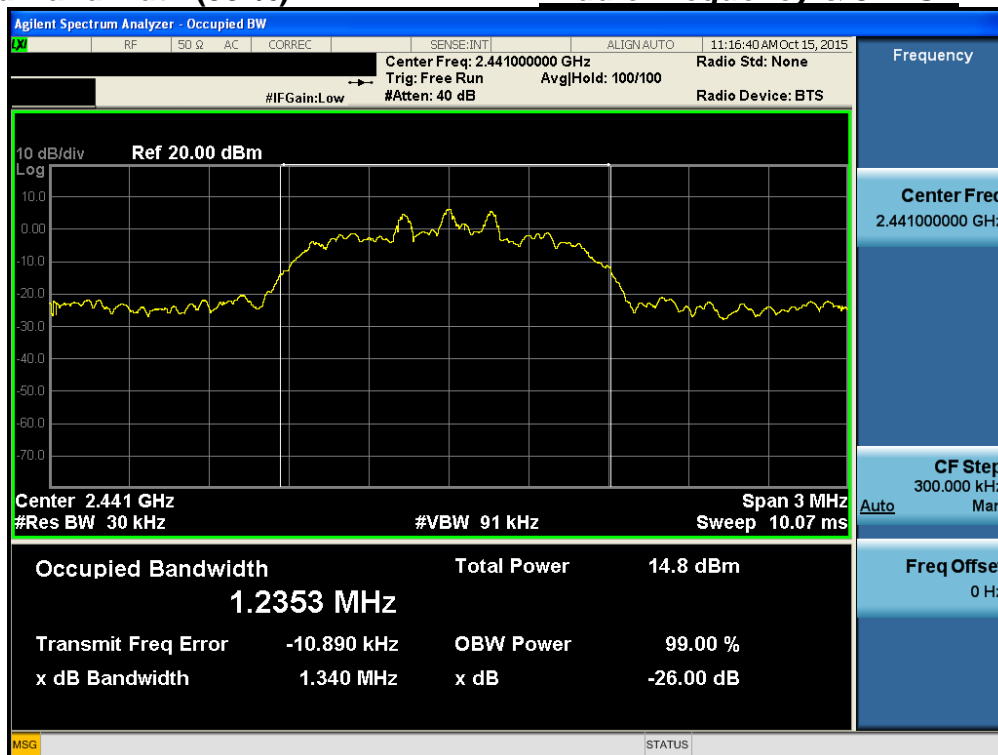

Occupied Bandwidth (99 %)

Highest Frequency & 8DPSK

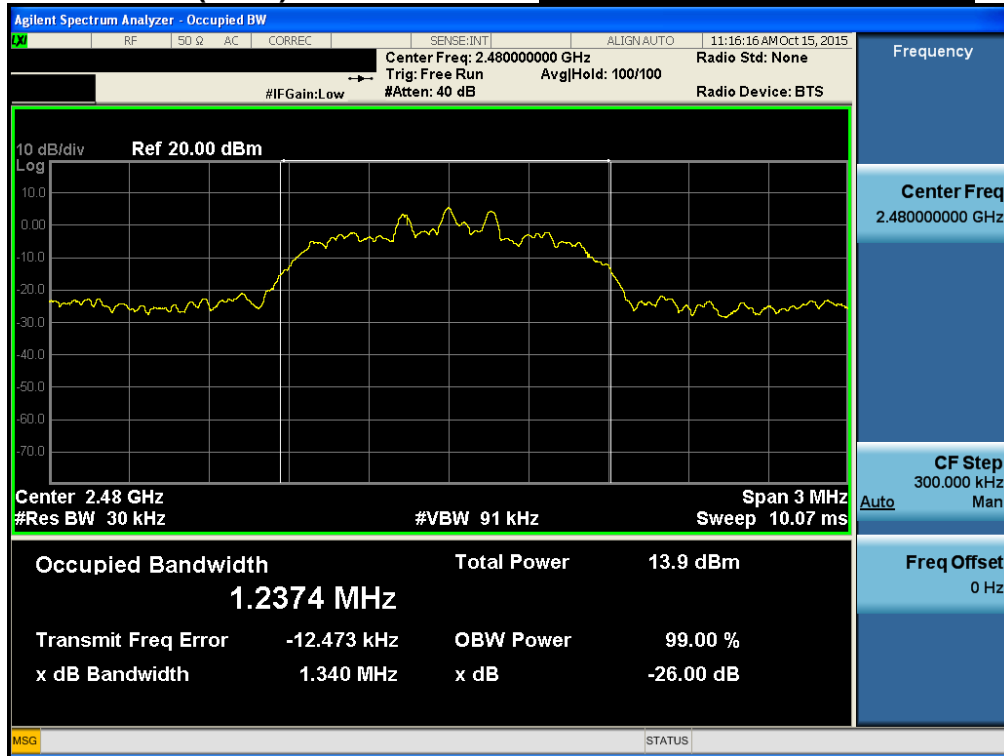

APPENDIX I

Test set up diagrams

▪ Radiated Measurement

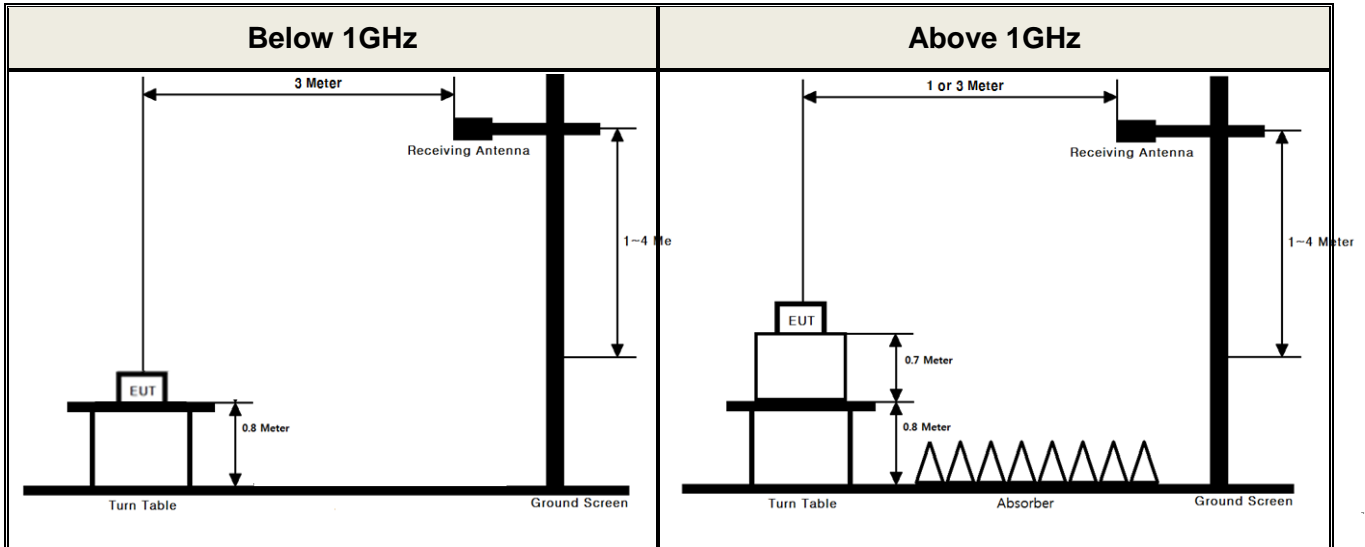

▪ Conducted Measurement

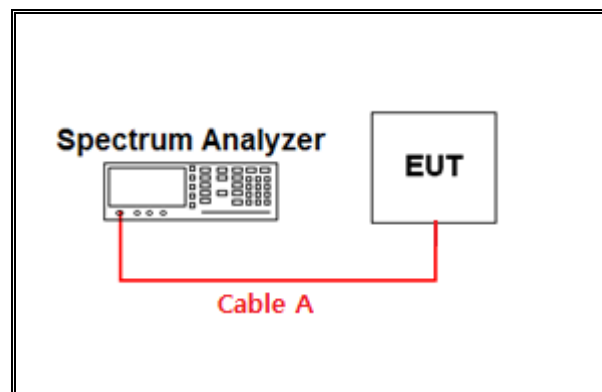

Path loss information

Frequency (GHz)	Path Loss (dB)	Frequency (GHz)	Path Loss (dB)
0.03	0.27	15	7.40
1	1.44	20	8.50
2402 & 2440 & 2480	2.34	25	10.22
5	3.49	-	-
10	5.54	-	-

Note 1 : The path loss from EUT to Spectrum analyzer were measured and used for test.

Path loss (S/A's Correction factor) = Cable A

APPENDIX II

Unwanted Emissions (Radiated) Test Plot

GFSK & Lowest & Z axis & Ver

Detector Mode : PK

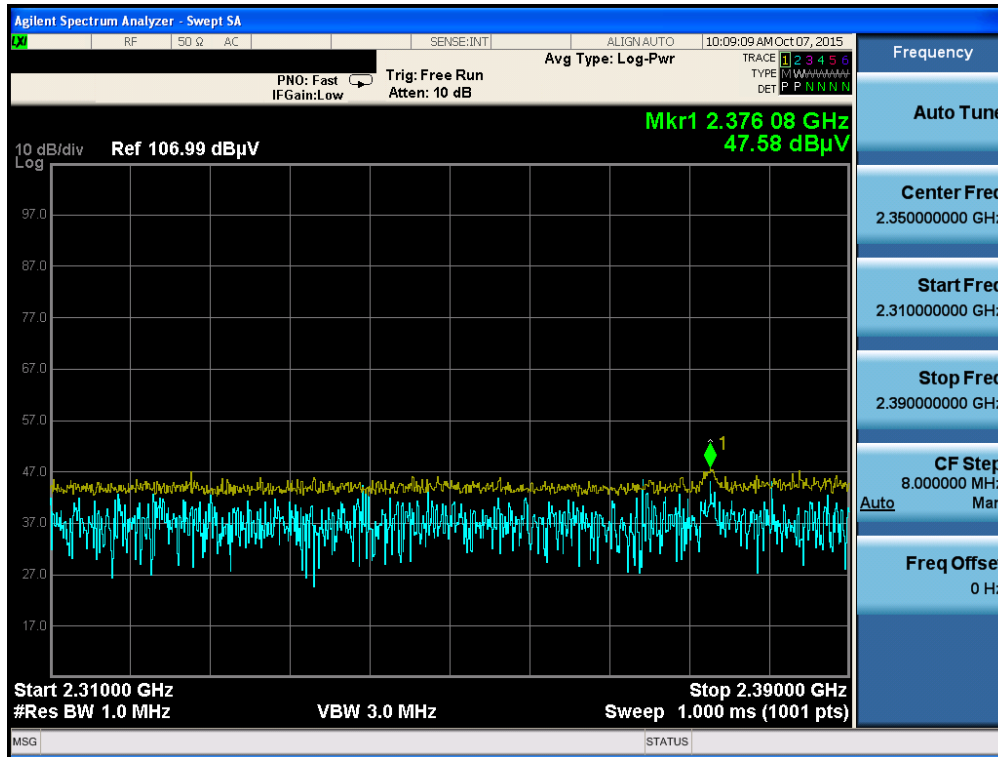

GFSK & Lowest & Y axis & Ver

Detector Mode : PK

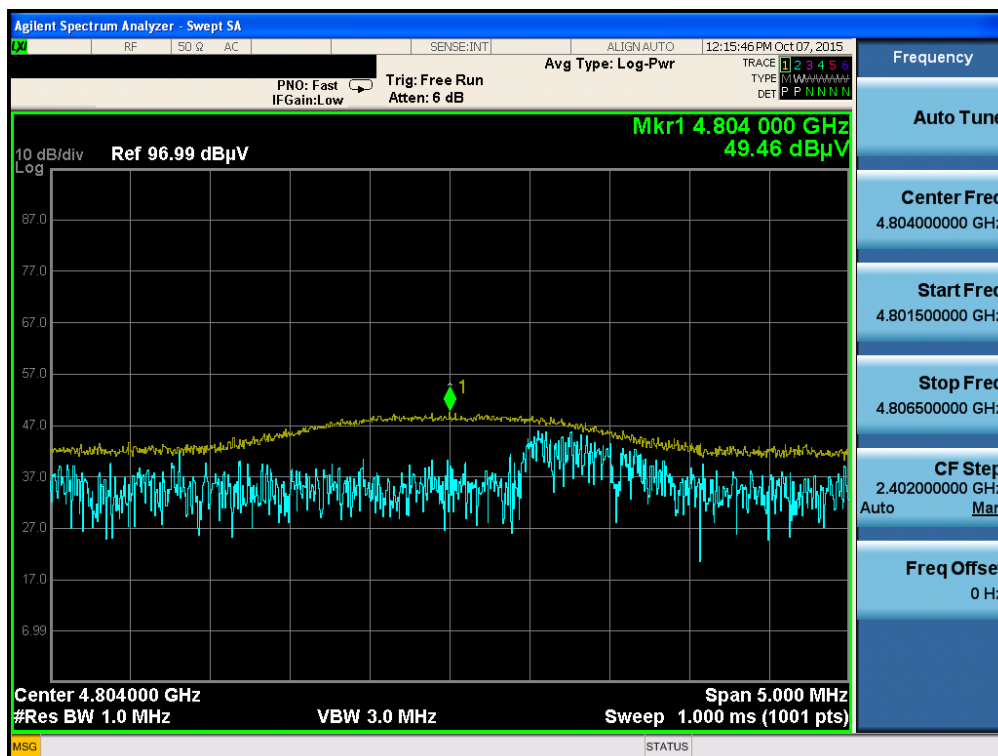

GFSK & Highest & Z axis & Ver

Detector Mode : PK

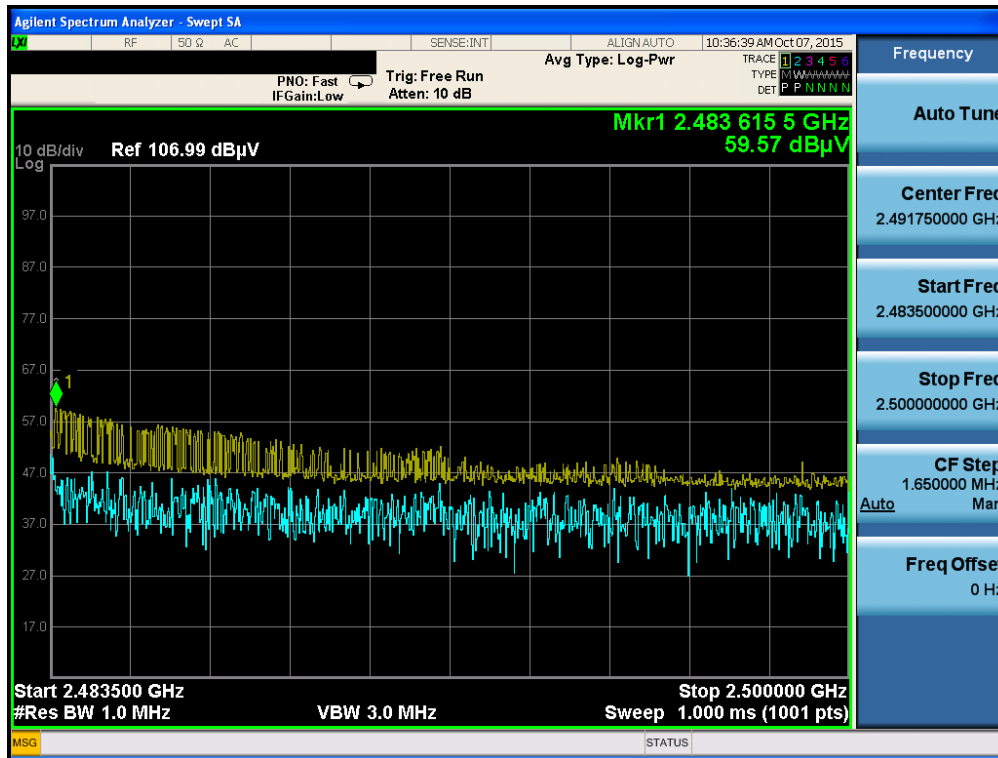

GFSK & Highest & Y axis & Ver

Detector Mode : PK

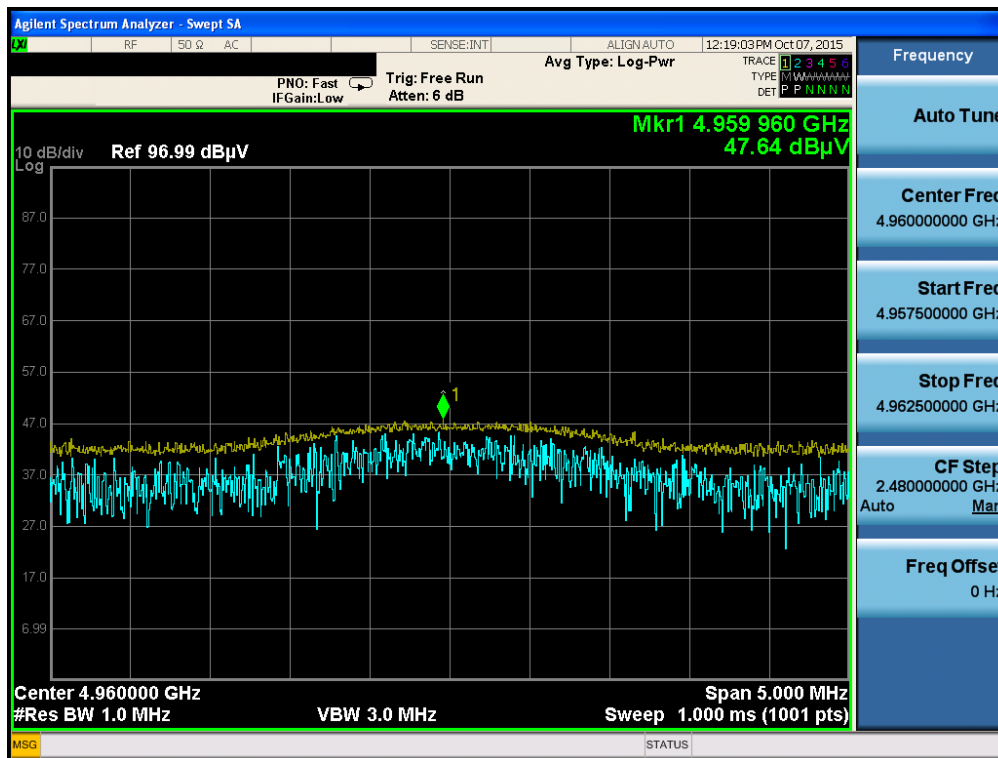

$\pi/4$ DQPSK & Lowest & Z axis & Ver

Detector Mode : PK

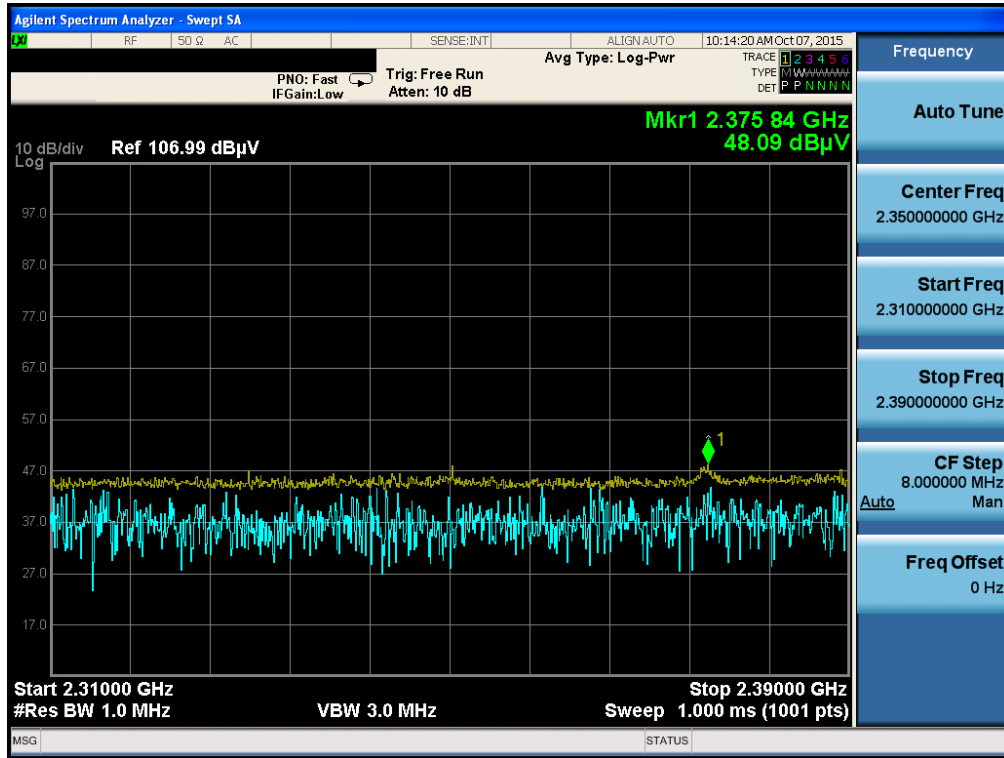

$\pi/4$ DQPSK Lowest & Y axis & Ver

Detector Mode : PK

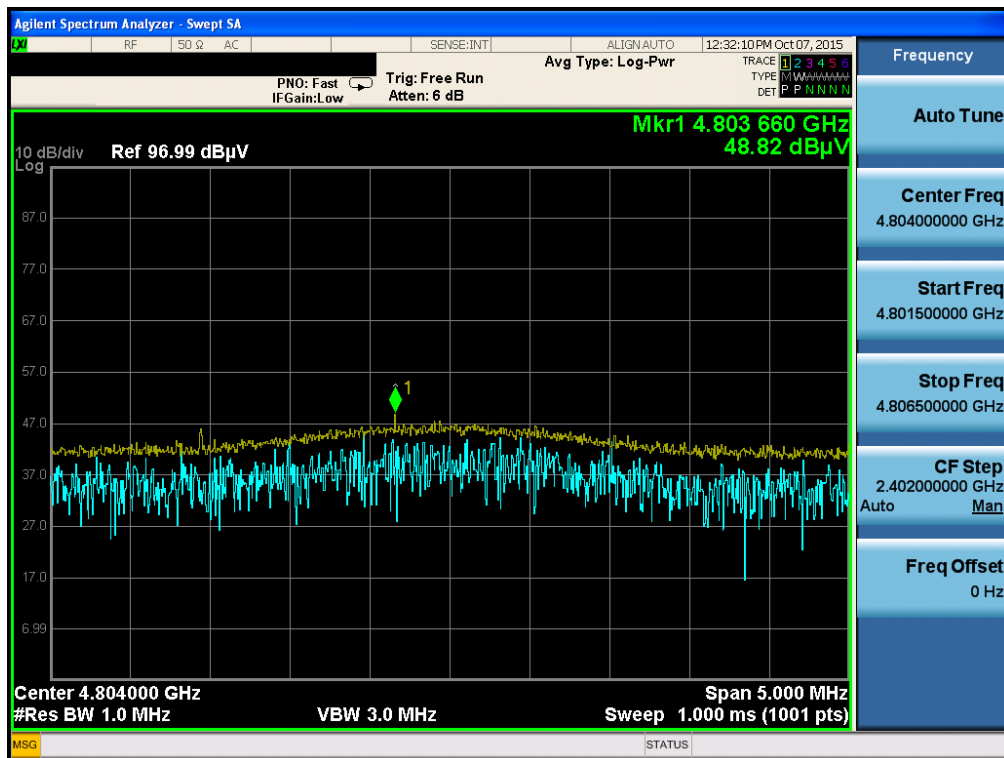

$\pi/4$ DQPSK & Middle & Y axis & Ver

Detector Mode : PK

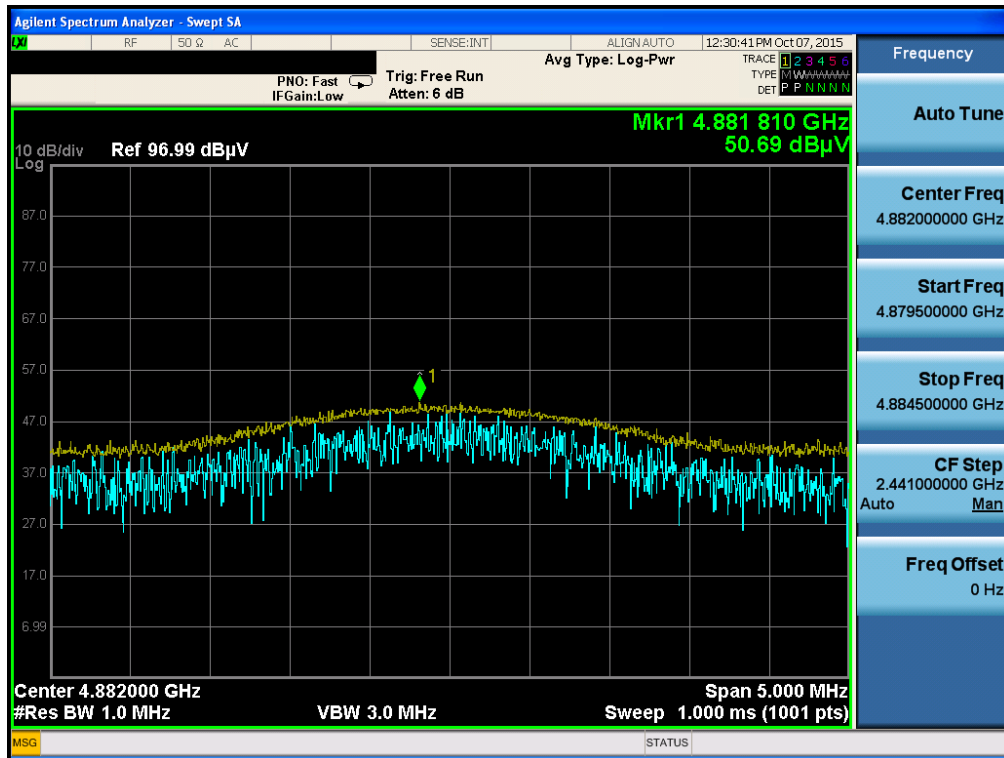

8DPSK & Lowest & Z axis & Ver

Detector Mode : PK

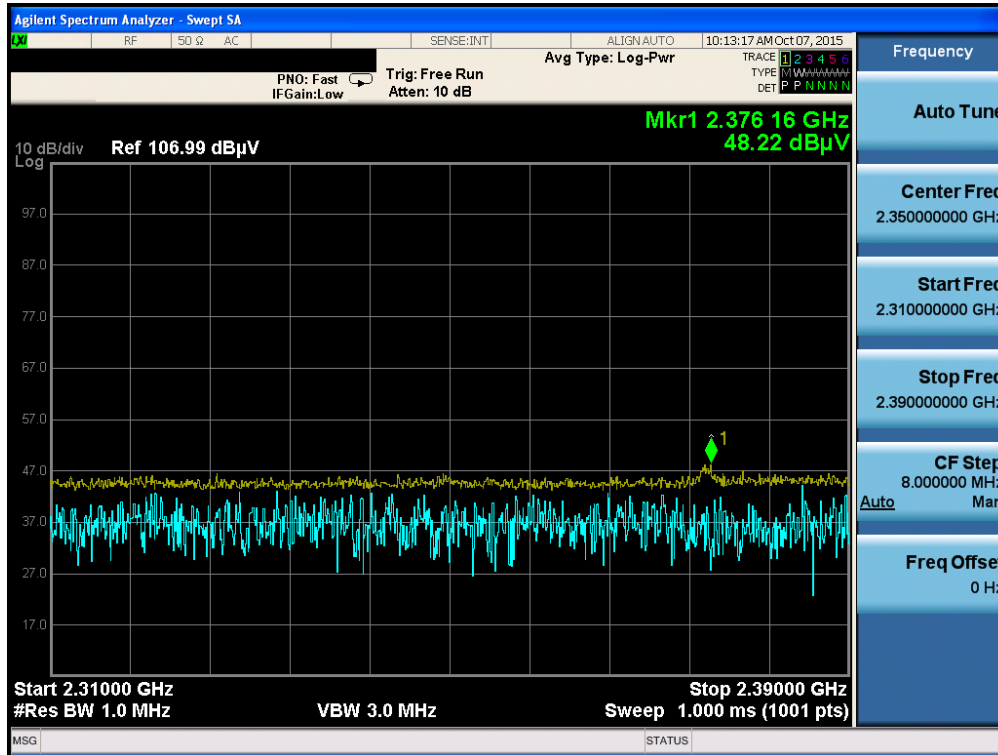

8DPSK & Lowest & Y axis & Ver

Detector Mode : PK

