



No.I22Z61444-SEM06



# HAC T-Coil TEST REPORT

No. I22Z61444-SEM06

For

FIH CO., LTD.

Smart phone

Model Name: EABF22206A, ECBF22208A

With

Hardware Version: 1.0

Software Version: EABF22206A\_2140U;ECBF22208A\_2140U

FCC ID: RYQEABF22206A

Results Summary: T Category = T3

Issued Date: 2022-09-16

**Note:**

The test results in this test report relate only to the devices specified in this report. This report shall not be reproduced except in full without the written approval of CTTL.

**Test Laboratory:**

**CTTL, Telecommunication Technology Labs, CAICT**

No. 51, Xueyuan Road, Haidian District, Beijing, P. R. China 100191.

Tel:+86(0)10-62304633-2512, Fax:+86(0)10-62304633-2504

Email: [ctl\\_terminals@caict.ac.cn](mailto:ctl_terminals@caict.ac.cn), website: [www.caict.ac.cn](http://www.caict.ac.cn)



No.I22Z61444-SEM06

## **REPORT HISTORY**

<b>Report Number</b>	<b>Revision</b>	<b>Issue Date</b>	<b>Description</b>
I22Z61444-SEM06	Rev.0	2022-09-16	Initial creation of test report

## TABLE OF CONTENT

<b>1 TEST LABORATORY .....</b>	<b>5</b>
1.1 TESTING LOCATION .....	5
1.2 TESTING ENVIRONMENT .....	5
1.3 PROJECT DATA .....	5
1.4 SIGNATURE .....	5
<b>2 CLIENT INFORMATION .....</b>	<b>6</b>
2.1 APPLICANT INFORMATION.....	6
2.2 MANUFACTURER INFORMATION .....	6
<b>3 EQUIPMENT UNDER TEST (EUT) AND ANCILLARY EQUIPMENT (AE) .....</b>	<b>7</b>
3.1 ABOUT EUT .....	7
3.2 INTERNAL IDENTIFICATION OF EUT USED DURING THE TEST .....	7
3.3 INTERNAL IDENTIFICATION OF AE USED DURING THE TEST .....	7
3.4 AIR INTERFACES / BANDS INDICATING OPERATING MODES.....	8
<b>4 REFERENCE DOCUMENTS.....</b>	<b>9</b>
<b>5 OPERATIONAL CONDITIONS DURING TEST .....</b>	<b>10</b>
5.1 HAC MEASUREMENT SET-UP.....	10
5.2 AM1D PROBE .....	11
5.3 AMCC.....	12
5.4 AMMI.....	12
5.5 TEST ARCH PHANTOM &PHONE POSITIONER .....	12
5.6 ROBOTIC SYSTEM SPECIFICATIONS.....	13
5.7 T-COIL MEASUREMENT POINTS AND REFERENCE PLANE .....	13
<b>6 T-COIL TEST PROCEDURES .....</b>	<b>15</b>
<b>7 T-COIL PERFORMANCE REQUIREMENTS .....</b>	<b>16</b>
7.1 T-COIL COUPLING FIELD INTENSITY .....	16
7.2 FREQUENCY RESPONSE.....	16
<b>8 CMRS VOICE DUT CONFIGURATION.....</b>	<b>18</b>
8.1 UMTS CODEC INVESTIGATION.....	18
<b>9 VOLTE TEST SYSTEM SETUP AND DUT CONFIGURATION.....</b>	<b>19</b>
9.1 TEST SYSTEM SETUP FOR VOLTE OVER IMS T-COIL TESTING.....	19
9.2 CODEC CONFIGURATION.....	20
9.3 RADIO CONFIGURATION.....	20
<b>10 VOWIFI TEST SYSTEM SETUP AND DUT CONFIGURATION.....</b>	<b>21</b>
10.1 TEST SYSTEM SETUP FOR VOWIFI OVER IMS T-COIL TESTING.....	21
10.2 CODEC CONFIGURATION.....	22
10.3 RADIO CONFIGURATION.....	22
<b>11 OTT VOIP TEST SYSTEM AND DUT CONFIGURATION .....</b>	<b>24</b>
11.1 TEST SYSTEM SETUP FOR OTT VOIP T-COIL TESTING .....	24
11.2 CODEC CONFIGURATION.....	27
11.3 RADIO CONFIGURATION FOR OTT VOIP (LTE).....	28
11.4 RADIO CONFIGURATION FOR OTT VOIP (WiFi) .....	29
<b>12 HAC T-COIL TEST DATA SUMMARY.....</b>	<b>31</b>
12.1 TEST RESULTS FOR 3G .....	31
12.2 TEST RESULTS FOR LTE.....	31
12.3 TEST RESULTS FOR WiFi.....	32
12.4 TEST RESULTS FOR OTT VOIP .....	32
12.5 TOTAL MEASUREMENT CONCLUSION .....	35



**14 MEASUREMENT UNCERTAINTY ..... 36**

**15 MAIN TEST INSTRUMENTS..... 37**

**ANNEX A TEST LAYOUT..... 38**

**ANNEX B TEST PLOTS ..... 39**

**ANNEX C FREQUENCY REPOSE CURVES..... 47**

**ANNEX D PROBE CALIBRATION CERTIFICATE..... 48**

**ANNEX E DAE CALIBRATION CERTIFICATE ..... 51**

## 1 Test Laboratory

### 1.1 Testing Location

Company Name:	CTTL(Shouxiang)
Address:	No. 51 Shouxiang Science Building, Xueyuan Road, Haidian District, Beijing, P. R. China100191

### 1.2 Testing Environment

Temperature:	18°C~25°C,
Relative humidity:	30%~ 70%
Ground system resistance:	< 0.5 Ω
Ambient noise is checked and found very low and in compliance with requirement of standards. Reflection of surrounding objects is minimized and in compliance with requirement of standards.	

### 1.3 Project Data

Project Leader:	Qi Dianyuan
Test Engineer:	Lin Xiaojun
Testing Start Date:	August 05, 2022
Testing End Date:	August 28, 2022

### 1.4 Signature



Lin Xiaojun  
(Prepared this test report)

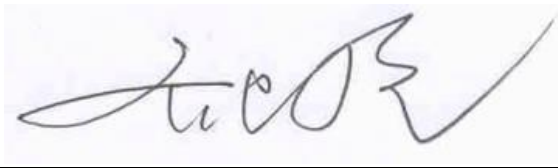

Qi Dianyuan  
(Reviewed this test report)

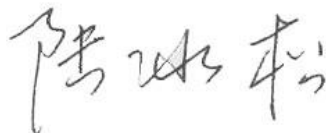

Lu Bingsong  
Deputy Director of the laboratory  
(Approved this test report)



## 2 Client Information

### 2.1 Applicant Information

Company Name:	FIH CO., LTD.
Address/Post:	No.4, Minsheng St., Tu-Cheng Dist., New Taipei City 23679, Taiwan
Contact Person:	Hu Dongji
Contact Email:	dongji.hu@fih-foxconn.com
Telephone:	0086-1067869988 Ext.26442
Fax	\

### 2.2 Manufacturer Information

Company Name:	FIH CO., LTD.
Address/Post:	No.4, Minsheng St., Tu-Cheng Dist., New Taipei City 23679, Taiwan
Contact Person:	Hu Dongji
Contact Email:	dongji.hu@fih-foxconn.com
Telephone:	0086-1067869988 Ext.26442
Fax	\

### 3 Equipment Under Test (EUT) and Ancillary Equipment (AE)

#### 3.1 About EUT

Description:	Smart phone
Model name:	EABF22206A, ECBF22208A
Operating mode(s):	WCDMAB2/B4/B5, BT, Wi-Fi, LTE Band 2/4/5/12/14/30

#### 3.2 Internal Identification of EUT used during the test

EUT ID*	IMEI	HW Version	SW Version
EUT	350702820002233	1.0	EABF22206A_2140U;ECBF22208A_2140U
EUT	350702820001854	1.0	EABF22206A_2140U;ECBF22208A_2140U

\*EUT ID: is used to identify the test sample in the lab internally.

**Note:** It is performed to test HAC with the EUT1-2

#### 3.3 Internal Identification of AE used during the test

AE ID*	Description	Model	SN	Manufacturer
AE1	Battery	HE401	\	ZHONGSHAN TIANMAO BATTERY CO., LTD.

\*AE ID: is used to identify the test sample in the lab internally.

### 3.4 Air Interfaces / Bands Indicating Operating Modes

Air-interface	Band(MHz)	Type	C63.19/tested	Simultaneous Transmissions	Name of Voice Service
WCDMA (UMTS)	850	VO	Yes	BT, WLAN	CMRS Voice
	1700				
	1900	DT	Yes		Google duo
	HSPA				
LTE FDD	Band2/4/5/12/14/30	V/D	Yes	BT, WLAN	VoLTE, Google duo
BT	2450	DT	NA	WCDMA ,LTE	NA
WLAN	2450	V/D	Yes	WCDMA ,LTE	VoWiFi, Google duo
WLAN	5G	V/D	Yes	WCDMA ,LTE	VoWiFi, Google duo

NA: Not Applicable VO: Voice Only V/D: CMRS and IP Voice Service over Digital Transport  
DT: Digital Transport

\* HAC Rating was not based on concurrent voice and data modes, Non current mode was found to represent worst case rating for both M and T rating

Note1 = No Associated T-Coil measurement has been made in accordance with 285076 D02 T-Coil testing for CMRS IP



## 4 Reference Documents

The following document listed in this section is referred for testing.

Reference	Title	Version
ANSI C63.19-2011	American National Standard for Methods of Measurement of Compatibility between Wireless Communication Devices and Hearing Aids	2011 Edition
KDB285076 D01v06	Equipment Authorization Guidance for Hearing Aid Compatibility	2022 Edition
KDB285076 D02v04	Guidance for performing T-Coil tests for air interfaces supporting voice over IP (e.g., LTE and WiFi) to support CMRS based telephone services	2022 Edition
KDB285076 D03v01r05	Hearing aid compatibility frequently asked questions	2022 Edition

## 5 OPERATIONAL CONDITIONS DURING TEST

### 5.1 HAC MEASUREMENT SET-UP

These measurements are performed using the DASY5 NEO automated dosimetric assessment system. It is made by Schmid & Partner Engineering AG (SPEAG) in Zurich, Switzerland. It consists of high precision robotics system (Stäubli), robot controller, Intel Core2 computer, near-field probe, probe alignment sensor. The robot is a six-axis industrial robot performing precise movements. A cell controller system contains the power supply, robot controller, teach pendant (Joystick), and remote control, is used to drive the robot motors. The PC consists of the HP Intel Core2 1.86 GHz computer with Windows XP system and HAC Measurement Software DASY5 NEO, A/D interface card, monitor, mouse, and keyboard. The Stäubli Robot is connected to the cell controller to allow software manipulation of the robot. A data acquisition electronic (DAE) circuit performs the signal amplification, signal multiplexing, AD-conversion, offset measurements, mechanical surface detection, collision detection, etc. is connected to the Electro-optical coupler (EOC). The EOC performs the conversion from the optical into digital electric signal of the DAE and transfers data to the PC plug-in card.

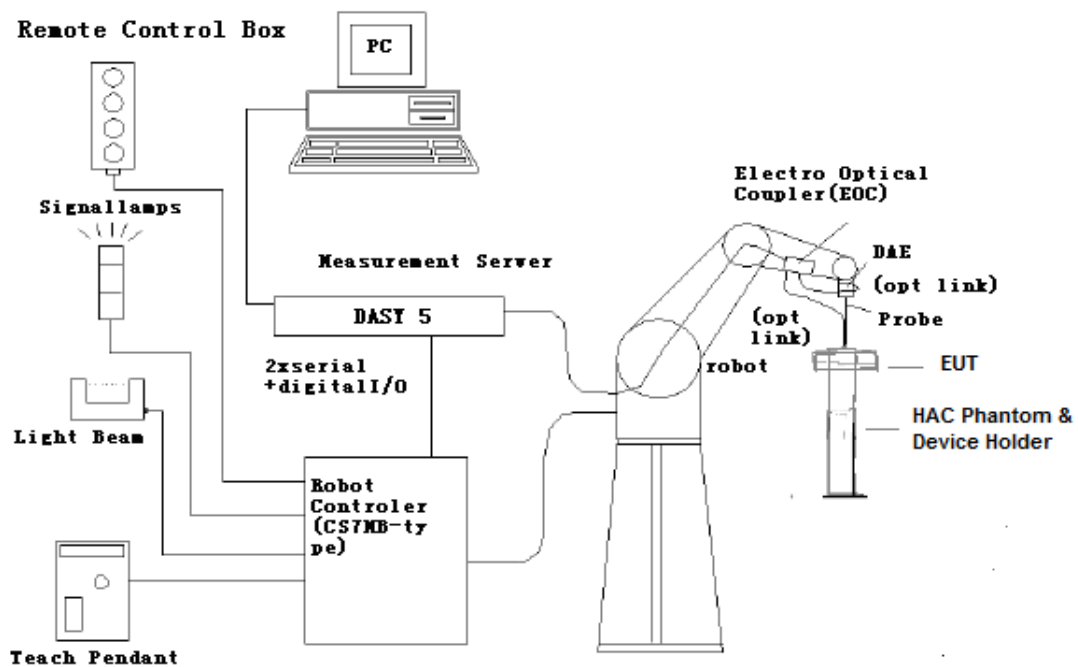

**Figure 5.1 HAC Test Measurement Set-up**

The DAE4 consists of a highly sensitive electrometer-grade preamplifier with auto-zeroing, a channel and gain-switching multiplexer, a fast 16 bit AD-converter and a command decoder and control logic unit. Transmission to the PC-card is accomplished through an optical downlink for data and status information and an optical uplink for commands and clock lines. The mechanical probe mounting device includes two different sensor systems for frontal and sidewise probe contacts. They are also used for mechanical surface detection and probe collision detection. The robot uses its own controller with a built in VME-bus computer.

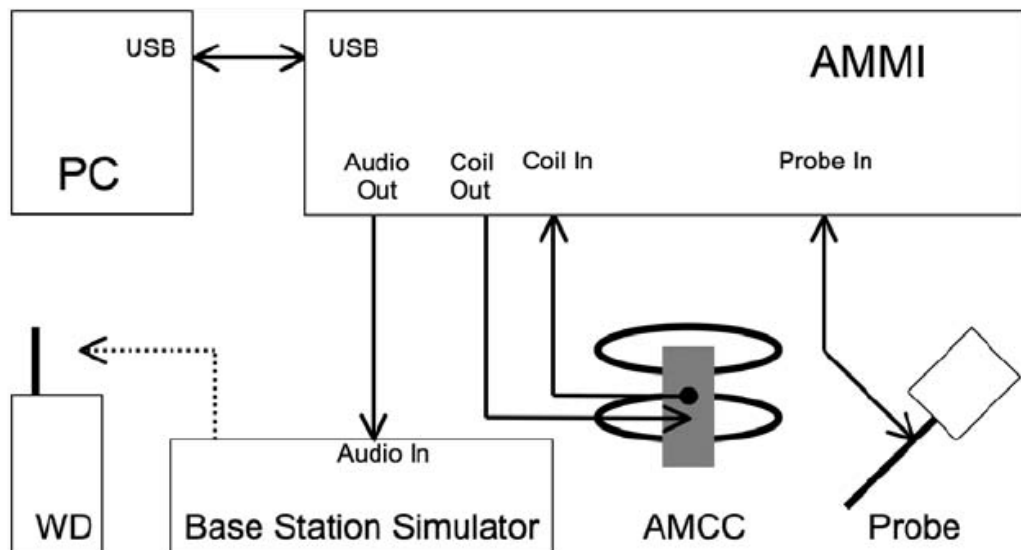

Figure 5.2 T-Coil setup with HAC Test Arch and AMCC

## 5.2 AM1D probe

The AM1D probe is an active probe with a single sensor. It is fully RF-shielded and has a rounded tip 6mm in diameter incorporating a pickup coil with its center offset 3mm from the tip and the sides. The symmetric signal preamplifier in the probe is fed via the shielded symmetric output cable from the AMMI with a 48V "phantom" voltage supply. The 7-pin connector on the back in the axis of the probe does not carry any signals. It is mounted to the DAE for the correct orientation of the sensor. If the probe axis is tilted 54.7 degree from the vertical, the sensor is approximately vertical when

the signal connector is at the underside of the probe (cable hanging downwards).

Specification:

<b>Frequency range</b>	0.1~20kHz (RF sensitivity < -100dB, fully RF shielded)
<b>Sensitivity</b>	< -50dB A/m @ 1kHz
<b>Pre-amplifier</b>	40dB, symmetric
<b>Dimensions</b>	Tip diameter/length: 6/290mm, sensor according to ANSI-C63.19

### 5.3 AMCC

The Audio Magnetic Calibration coil is a Helmholtz Coil designed for calibration of the AM1D probe. The two horizontal coils generate a homogeneous magnetic field in the z direction. The DC input resistance is adjusted by a series resistor to approximately 50Ohm, and a shunt resistor of 100Ohm permits monitoring the current with a scale of 1:10

Port description:

Signal	Connector	Resistance
Coil In	BNC	Typically 50Ohm
Coil Monitor	BNO	100Ohm±1% (100mV corresponding to 1 A/m)

Specification:

<b>Dimensions</b>	370 x 370 x 196 mm, according to ANSI-C63.19
-------------------	--

### 5.4 AMMI



**Figure 5.3 AMMI front panel**

The Audio Magnetic Measuring Instrument (AMMI) is a desktop 19-inch unit containing a sampling unit, a waveform generator for test and calibration signals, and a USB interface.

Specification:

<b>Sampling rate</b>	48 kHz / 24 bit
<b>Dynamic range</b>	85 dB
<b>Test signal generation</b>	User selectable and predefined (vis PC)
<b>Calibration</b>	Auto-calibration / full system calibration using AMCC with monitor output
<b>Dimensions</b>	482 x 65 x 270 mm

### 5.5 Test Arch Phantom & Phone Positioner

The Test Arch phantom should be positioned horizontally on a stable surface. Reference markings on the Phantom allow the complete setup of all predefined phantom positions and measurement grids by manually teaching three points in the robot. It enables easy and well defined positioning of the phone and validation dipoles as well as simple teaching of the robot (Dimensions: 370 x 370 x 370 mm).

The Phone Positioner supports accurate and reliable positioning of any phone with effect on near

field  $< \pm 0.5$  dB.

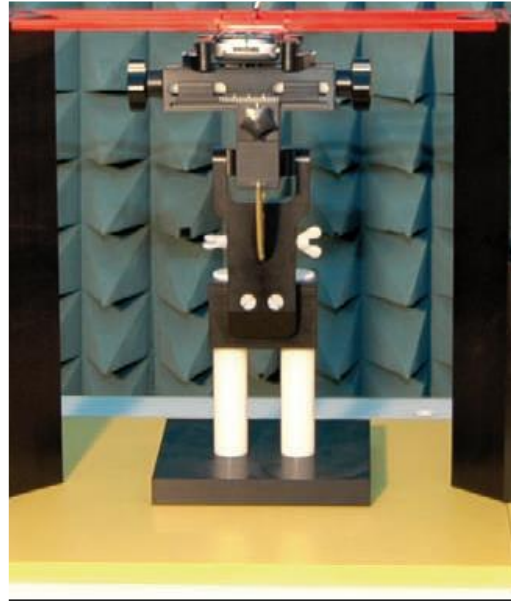

Figure 5.4 HAC Phantom & Device Holder

## 5.6 Robotic System Specifications

### Specifications

**Positioner:** Stäubli Unimation Corp. Robot Model: RX160L

**Repeatability:**  $\pm 0.02$  mm

**No. of Axis:** 6

### Data Acquisition Electronic (DAE) System

#### Cell Controller

**Processor:** Intel Core2

**Clock Speed:** 1.86GHz

**Operating System:** Windows XP

#### Data Converter

**Features:** Signal Amplifier, multiplexer, A/D converter, and control logic

**Software:** DASY5 software

**Connecting Lines:** Optical downlink for data and status info.

Optical uplink for commands and clock

## 5.7 T-Coil measurement points and reference plane

Figure 6.5 illustrates the standard probe orientations. Position 1 is the perpendicular orientation of the probe coil; orientation 2 is the transverse orientations. The space between the measurement positions is not fixed. It is recommended that a scan of the WD be done for each probe coil orientation and that the maximum level recorded be used as the reading for that orientation of the probe coil.

1) The reference plane is the planar area that contains the highest point in the area of the phone that normally rests against the user's ear. It is parallel to the centerline of the receiver area of the

phone and is defined by the points of the receiver-end of the WD handset, which, in normal handset use, rest against the ear.

- 2) The measurement plane is parallel to, and 10 mm in front of, the reference plane.
- 3) The reference axis is normal to the reference plane and passes through the center of the receiver speaker section (or the center of the hole array); or may be centered on a secondary inductive source. The actual location of the measurement point shall be noted in the test report as the measurement reference point.
- 4) The measurement points may be located where the axial and radial field intensity measurements are optimum with regard to the requirements. However, the measurement points should be near the acoustic output of the WD and shall be located in the same half of the phone as the WD receiver. In a WD handset with a centered receiver and a circularly symmetrical magnetic field, the measurement axis and the reference axis would coincide.
- 5) The relative spacing of each measurement orientation is not fixed. The axial and two radial orientations should be chosen to select the optimal position.
- 6) The measurement point for the axial position is located 10 mm from the reference plane on the measurement axis. The actual location of the measurement point shall be noted in test reports and designated as the measurement reference point.

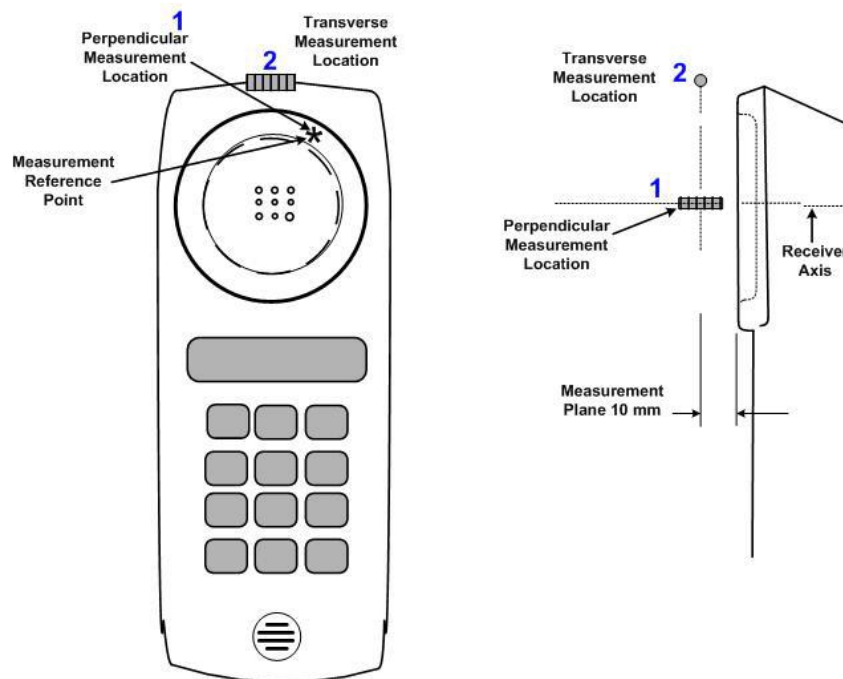

**Figure 5.5 Axis and planes for WD audio frequency magnetic field measurements**

## 6 T-Coil TEST PROCEDURES

**The following illustrate a typical test scan over a wireless communications device:**

- 1) Geometry and signal check: system probe alignment, proper operation of the field probe, probe measurement system, other instrumentation, and the positioning system was confirmed. A surface calibration was performed before each setup change to ensure repeatable spacing and proper maintenance of the measurement plane using the test Arch.
- 2) Set the reference drive level of signal voice defined in C63.19 per 7.4.2.1.
- 3) The ambient and test system background noise (dB A/m) was measured as well as ABM2 over the full measurement. The maximum noise level must be at least 10dB below the limit.
- 4) The DUT was positioned in its intended test position, acoustic output point of the device perpendicular to the field probe.
- 5) The DUT operation for maximum rated RF output power was configured and connected by using of coaxial cable connection to the base station simulator at the test channel and other normal operating parameters as intended for the test. The battery was ensured to be fully charged before each test. The center sub-grid was centered over the center of the acoustic output (also audio band magnetic output, if applicable). The DUT audio output was positioned tangent (as physically possible) to the measurement plane.
- 6) The DUT's RF emission field was eliminated from T-coil results by using a well RF-shielding of the probe, AM1D, and by using of coaxial cable connection to a Base Station Simulator. One test channel was pre-measurement to avoid this possibility.
- 7) Determined the optimal measurement locations for the DUT by following the three steps, coarse resolution scan, fine resolution scans, and point measurement, as described in C63.19 per 7.4.4.2. At each measurement locations, samples in the measurement window duration were evaluated to get ABM1 and the signal spectrum. The noise measurement was performed after the scan with the signal, the same happened, just with the voice signal switched off. The ABM2 was calculated from this second scan.
- 8) All results resulting from a measurement point in a T-Coil job were calculated from the signal samples during this window interval. ABM values were averaged over the sequence of these samples.
- 9) At an optimal point measurement, the SNR (ABM1/ABM2) was calculated for perpendicular and transverse orientation, and the frequency response was measured for perpendicular.
- 10) Corrected for the frequency response after the DUT measurement since the DASY5 system had known the spectrum of the input signal by using a reference job.
- 11) In SEMCAD postprocessing, the spectral points are in addition scaled with the high-pass (half-band) and the A-weighting, bandwidth compensated factor (BWC) and those results are final as shown in this report.



## 7 T-Coil PERFORMANCE REQUIREMENTS

In order to be rated for T-Coil use, a WD shall meet the requirements for signal level and signal quality contained in this part.

### 7.1 T-Coil coupling field intensity

When measured as specified in ANSI C63.19, the T-Coil signal shall be  $\geq -18$  dB (A/m) at 1 kHz, in a 1/3 octave band filter for all orientations.

### 7.2 Frequency response

The frequency response of the axial component of the magnetic field, measured in 1/3 octave bands, shall follow the response curve specified in this sub-clause, over the frequency range 300 Hz to 3000 Hz. Figure 7.1 and Figure 7.2 provide the boundaries for the specified frequency. These response curves are for true field strength measurements of the T-Coil signal. Thus the 6 dB/octave probe response has been corrected from the raw readings.

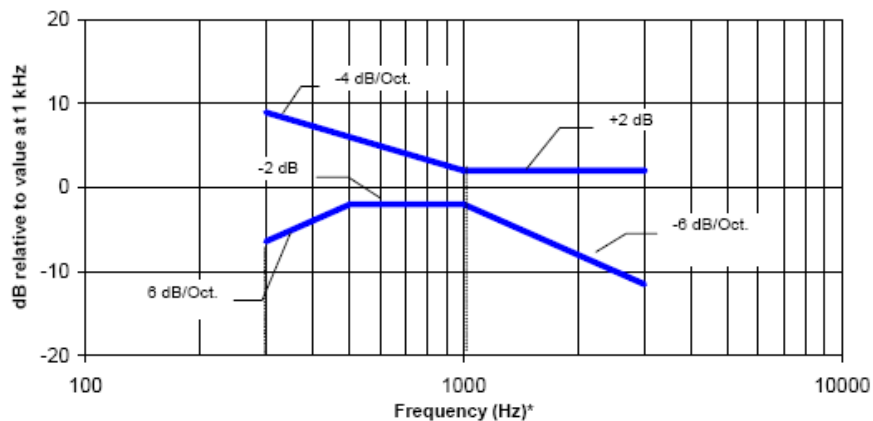

NOTE—Frequency response is between 300 Hz and 3000 Hz.

**Figure 7.1—Magnetic field frequency response for WDs with a field  $\leq -15$  dB (A/m) at 1 kHz**

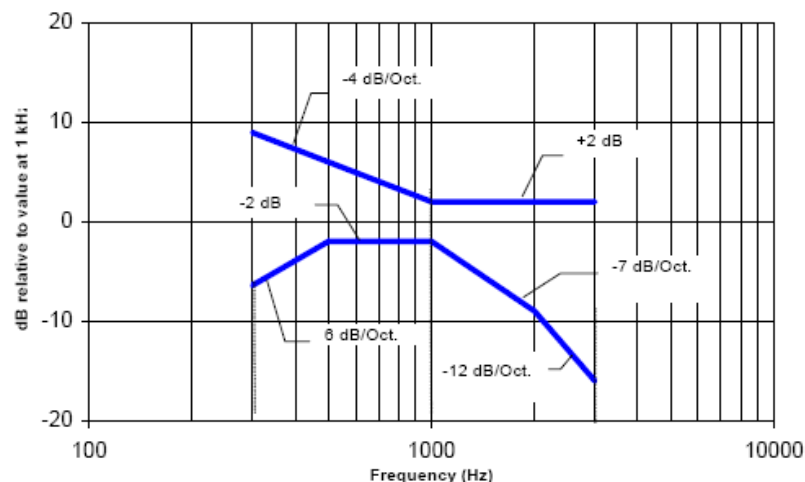

NOTE—Frequency response is between 300 Hz and 3000 Hz.

**Figure 7.2—Magnetic field frequency response for WDs with a field that exceeds  $-15$  dB (A/m) at 1 kHz**



### 7.3 Signal quality

This part provides the signal quality requirement for the intended T-Coil signal from a WD. Only the RF immunity of the hearing aid is measured in T-Coil mode. It is assumed that a hearing aid can have no immunity to an interference signal in the audio band, which is the intended reception band for this mode. So, the only criteria that can be measured is the RF immunity in T-Coil mode. This is measured using the same procedure as for the audio coupling mode and at the same levels.

The worst signal quality of the three T-Coil signal measurements shall be used to determine the T-Coil mode category per Table 1

**Table 1:T-Coil signal quality categories**

<b>Category</b>	<b>Telephone parameters WD signal quality [(signal + noise) – to – noise ratio in decibels]</b>
Category T1	0 dB to 10 dB
Category T2	10 dB to 20 dB
Category T3	20 dB to 30 dB
Category T4	> 30 dB

## 8 CMRS Voice DUT CONFIGURATION

### 8.1 UMTS Codec Investigation

The middle channel of each frequency band is used for T-coil testing according ANSI C63.19-2011. Choose worst case from radio configuration investigation. After investigation was performed to determine the audio codec configuration to be used for testing, the following tests results which the worst case codec would be remarked to be used for the testing for the DUT. According to C63 and KDB 285076 D02v04, UMTS input level is -16dBm0.

**Table 8-2 WCDMA/UMTS CMRS Codec Investigation**

Codec Setting	AMR 12.2kbps	AMR 7.95kbps	AMR 4.75kbps	Orientation	Band	Channel
ABM1 (dBA/m)	-2.19	-3.06	-2.55	Z(axial)	WCDMA 1900	9400
Frequency Response	PASS	PASS	PASS			
SNR (dB)	41.84	41.47	40.51			

## 9 VoLTE TEST SYSTEM SETUP AND DUT CONFIGURATION

### 9.1 Test System Setup for VoLTE over IMS T-coil Testing

The general test setup used for VoLTE over IMS is shown below. The callbox used when performing VoLTE over IMS T-coil measurements is a CMW500. The Data Application Unit (DAU) of the CMW500 was used to simulate the IP Multimedia Subsystem (IMS) server. According to C63 and KDB 285076 D02v04, VoLTE input level is -20dBm0.

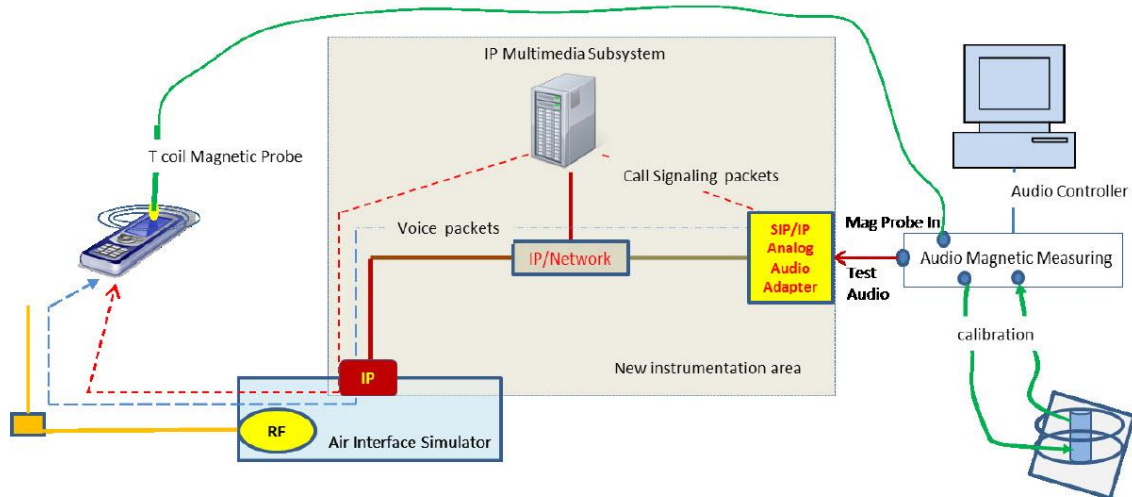

**Figure 9.1 Test Setup for VoLTE over IMS T-coil Measurements**

The following software/firmware was used to simulate the VoLTE server for testing:

Firmware	License Keys	Software Name
V3.7.50 for LTE	KS500	LTE FDD R8 SIG BASIC
	KS550	LTE TDD R8 SIG BASIC
	KA100	IP APPL ENABLING IPv4
	KA150	IP APPL ENABLING IPv6
V3.7.20 for Audio	KAA20	IP APPL IMS BASIC
	KM050	DATA APPL MEAS
	KS104	EVS SPEECH CODEC

## 9.2 Codec Configuration

An investigation was performed to determine the audio codec configuration to be used for testing. EVS Primary NB 5.9kbps setting was used for the audio codec on the CMW500 for VoLTE over IMS T-coil testing. See below table for comparisons between different codecs and codec data rates:

**Table 9-1 AMR Codec Investigation – VoLTE over IMS**

Codec Setting	WB AMR 23.85kbps	WB AMR 6.60kbps	NB AMR 12.2kbps	NB AMR 4.75kbps	Orientation	Band/BW	Channel
ABM1 (dBA/m)	-5.72	-6.65	-2.46	-2.62	Z(axial)	B2/20M	18900
Frequency Response	PASS	PASS	PASS	PASS			
SNR (dB)	31.15	30.52	34.37	33.16			

**Table 9-2 EVS Codec Investigation – VoLTE over IMS**

Codec Setting	EVS Primary WB 13.2kbps	EVS Primary WB 5.9kbps	EVS Primary NB 13.2kbps	EVS Primary NB 5.9kbps	Orientation	Band /BW	Channel
ABM1 (dBA/m)	-5.66	-5.47	-5.42	-5.48	Z(axial)	B2/20M	18900
Frequency Response	PASS	PASS	PASS	PASS			
SNR (dB)	31.78	31.27	31.19	30.50			

## 9.3 Radio Configuration

An investigation was performed to determine the modulation, the bandwidth configuration and RB configuration to be used for testing. 20MHz BW, QPSK, 1RB, 50RB offset was used for the testing as the worst-case configuration for the handset. See below table for comparisons between different radio configurations:

**Table 9-3 VoLTE over IMS SNR by Radio Configuration**

Band	Channel	Bandwidth [MHz]	Modulation	RB Size	RB Offset(%)	ABM1 [dB(A/m)]	SNR [dB]
LTE B2	18900	20	QPSK	1	0	-4.19	31.94
LTE B2	18900	20	QPSK	1	50	-5.48	30.50
LTE B2	18900	20	QPSK	1	100	-6.38	31.85
LTE B2	18900	20	QPSK	50	0	-4.20	30.96
LTE B2	18900	20	QPSK	50	50	-5.29	30.85
LTE B2	18900	20	QPSK	50	100	-5.53	32.06
LTE B2	18900	20	QPSK	100	0	-4.25	31.48
LTE B2	18900	20	16QAM	1	50	-4.55	31.27
LTE B2	18900	20	64QAM	1	50	-6.39	30.77
LTE B2	18900	15	QPSK	1	50	-5.06	30.95
LTE B2	18900	10	QPSK	1	50	-5.74	30.52
LTE B2	18900	5	QPSK	1	50	-6.74	31.64
LTE B2	18900	3	QPSK	1	50	-4.83	31.74
LTE B2	18900	1.4	QPSK	1	50	-5.84	31.85

## 10 VoWiFi TEST SYSTEM SETUP AND DUT CONFIGURATION

### 10.1 Test System Setup for VoWiFi over IMS T-coil Testing

The general test setup used for VoWiFi over IMS, or CMRS WiFi Calling, is shown below. The callbox used when performing VoWiFi over IMS T-coil measurements is a CMW500. The Data Application Unit (DAU) of the CMW500 was used to simulate the IP Multimedia Subsystem (IMS) server. According to C63 and KDB 285076 D02v04, VoWiFi input level is -20dBm0.

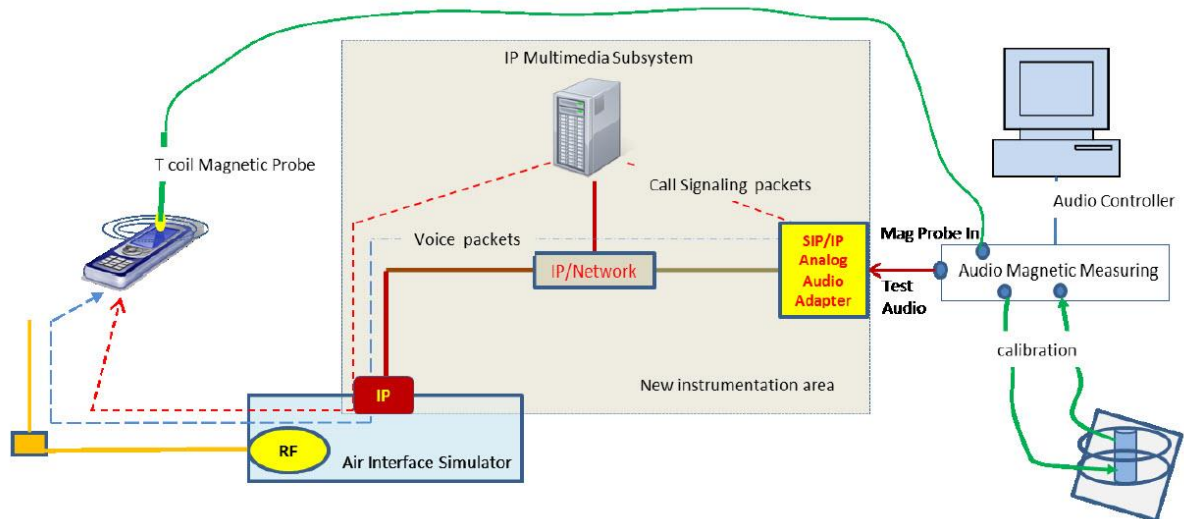

**Figure 10.1 Test Setup for VoWiFi over IMS T-coil Measurements**

The following software/firmware was used to simulate the VoWiFi server for testing:

Firmware	License Keys	Software Name
V3.7.40 for WLAN	KS650	WLAN A/B/G SIG BASIC
	KS651	WLAN N SIG BASIC
	KA100	IP APPL ENABLING IPv4
	KA150	IP APPL ENABLING IPv6
V3.7.20 for Audio	KAA20	IP APPL IMS BASIC
	KM050	DATA APPL MEAS
	KS104	EVS SPEECH CODEC

## 10.2 Codec Configuration

An investigation was performed to determine the audio codec configuration to be used for testing. The EVS Primary NB 13.2kbps setting was used for the audio codec on the CMW500 for VoWiFi over IMS T-coil testing. See below table for comparisons between different codecs and codec data rates:

**Table 10-1 AMR Codec Investigation – VoWiFi over IMS**

Codec Setting	WB AMR 23.85kbps	WB AMR 6.60kbps	NB AMR 12.2kbps	NB AMR 4.75kbps	Orientation	Band/BW	Channel
ABM1 (dBA/m)	-4.67	-4.94	-1.29	-1.76	Z(axial)	2.4GHz 802.11b	6
Frequency Response	PASS	PASS	PASS	PASS			
SNR (dB)	37.61	37.60	39.70	38.81			

**Table 10-2 EVS Codec Investigation – VoWiFi over IMS**

Codec Setting	EVS Primary WB 13.2kbps	EVS Primary WB 5.9kbps	EVS Primary NB 13.2kbps	EVS Primary NB 5.9kbps	Orientation	Mode	Channel
ABM1 (dBA/m)	-4.44	-4.44	-4.47	-4.41	Z(axial)	2.4GHz 802.11b	6
Frequency Response	PASS	PASS	PASS	PASS			
SNR (dB)	38.05	37.92	37.46	37.86			

## 10.3 Radio Configuration

An investigation was performed on all applicable data rates and modulations to determine the radio configuration to be used for testing. See below table for comparisons between different radio configurations in each 802.11 standard:

**Table 10-3 802.11b SNR by Radio Configuration**

Mode	Channel	Modulation	Data Rate [Mbps]	ABM1 [dB(A/m)]	SNR [dB]
802.11b	6	DSSS	1	-4.30	38.28
802.11b	6	DSSS	2	-3.87	38.96
802.11b	6	CCK	5.5	-4.47	37.46
802.11b	6	CCK	11	-5.06	38.06

**Table 10-4 802.11g/a SNR by Radio Configuration**

Mode	Channel	Modulation	Data Rate [Mbps]	ABM1 [dB(A/m)]	SNR [dB]
802.11g	6	BPSK	6	-4.24	38.14
802.11g	6	BPSK	9	-4.74	38.22
802.11g	6	QPSK	12	-4.54	37.55
802.11g	6	QPSK	18	-4.66	38.01
802.11g	6	16-QAM	24	-4.64	38.09
802.11g	6	16-QAM	36	-4.72	38.12
802.11g	6	64-QAM	48	-4.31	37.99
802.11g	6	64-QAM	54	-4.48	37.91

**Table 10-5 802.11ac 20MHz BW SNR by Radio Configuration**

Mode	Bandwidth [MHz]	Channel	Modulation	Data Rate [Mbps]	ABM1 [dB(A/m)]	SNR [dB]
802.11ac	20	44	BPSK	6.5	-8.08	35.35
802.11ac	20	44	QPSK	13	-7.86	36.22
802.11ac	20	44	QPSK	19.5	-7.78	35.17
802.11ac	20	44	16-QAM	26	-7.62	35.83
802.11ac	20	44	16-QAM	39	-7.58	36.14
802.11ac	20	44	64-QAM	52	-7.65	36.06
802.11ac	20	44	64-QAM	58.5	-7.94	35.55
802.11ac	20	44	64-QAM	65	-7.91	35.37
802.11ac	20	44	256-QAM	78	-8.53	37.17

**Table 10-6 802.11ac 40MHz BW SNR by Radio Configuration**

Mode	Bandwidth [MHz]	Channel	Modulation	Data Rate [Mbps]	ABM1 [dB(A/m)]	SNR [dB]
802.11ac	40	46	BPSK	13.5	-5.17	34.86
802.11ac	40	46	QPSK	27	-5.22	34.17
802.11ac	40	46	QPSK	40.5	-5.39	34.35
802.11ac	40	46	16-QAM	54	-5.20	35.07
802.11ac	40	46	16-QAM	81	-5.10	34.92
802.11ac	40	46	64-QAM	108	-4.97	34.52
802.11ac	40	46	64-QAM	121.5	-4.82	34.63
802.11ac	40	46	64-QAM	135	-5.42	34.33
802.11ac	40	46	256-QAM	180	-6.03	36.77

**Table 10-6 802.11ac 80MHz BW SNR by Radio Configuration**

Mode	Bandwidth [MHz]	Channel	Modulation	Data Rate [Mbps]	ABM1 [dB(A/m)]	SNR [dB]
802.11ac	80	42	BPSK	29.3	-4.16	38.04
802.11ac	80	42	QPSK	58.5	-3.26	37.93
802.11ac	80	42	QPSK	87.8	-3.95	37.45
802.11ac	80	42	16-QAM	117	-3.44	38.24
802.11ac	80	42	16-QAM	175.5	-3.29	39.03
802.11ac	80	42	64-QAM	234	-4.31	38.51
802.11ac	80	42	64-QAM	263.3	-3.04	38.29
802.11ac	80	42	64-QAM	292.5	-4.22	38.33
802.11ac	80	42	256-QAM	351	-3.84	39.16
802.11ac	80	42	256-QAM	390	-3.96	38.52

## 11 OTT VoIP TEST SYSTEM AND DUT CONFIGURATION

### 11.1 Test System Setup for OTT VoIP T-coil Testing

#### OTT VoIP Application

Google Duo is a pre-installed application on the DUT which allows for VoIP calls in a head-to-ear scenario. Duo uses the OPUS audio codec and supports a bitrate range of 6kbps to 75kbps. All air interfaces capable of a data connection were evaluated with Google Duo. When HAC testing we are using the Google Duo version is 26.0.179825522.alpha.DEV and the bitrate configuration can find at settings → Voice call parameters settings → Audio codec bitrate(6-75kbps).

#### Test Procedure and Equipment Setup

The test procedure for OTT testing is identical to the section above, except for how the signal is sent to the DUT, as outlined in the diagram below.

The AMMI is connected to the support device's Mic via Audio Data Line. The support device is connected to the Internet via Wi-Fi and the DUT is connected to the mobile base station via the technology under test. Using the DUT's OTT application, a VoIP call is established with the support device. The test signal is sent from the DASY PC to the AMMI, from the AMMI to the support device, and finally to the DUT. To exercise the license antenna, the DUT was simultaneously connected to an external AP and to a mobile base station.

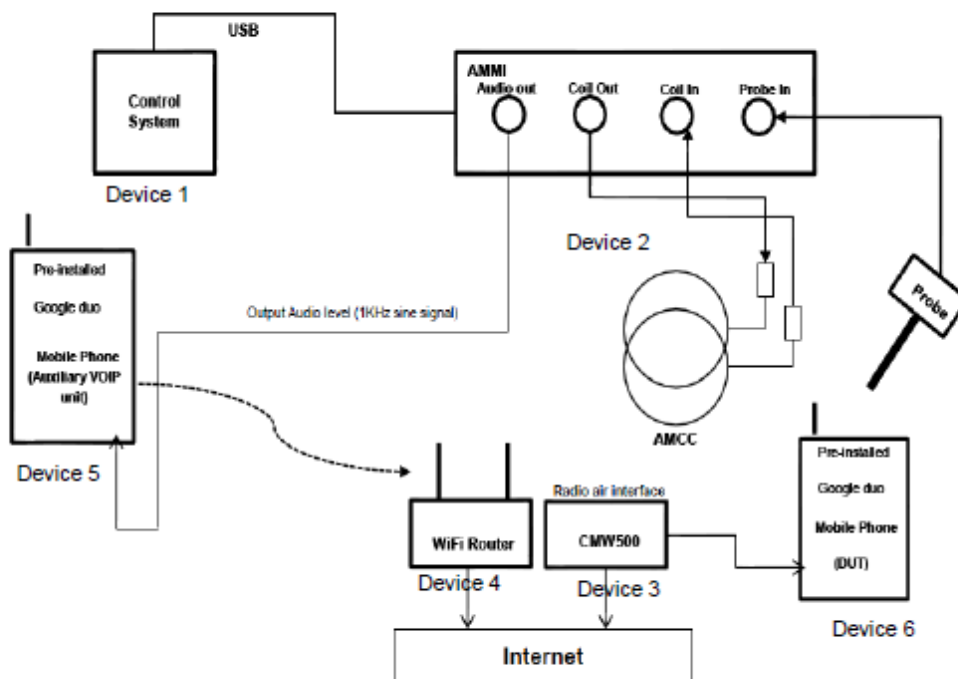

Device1:



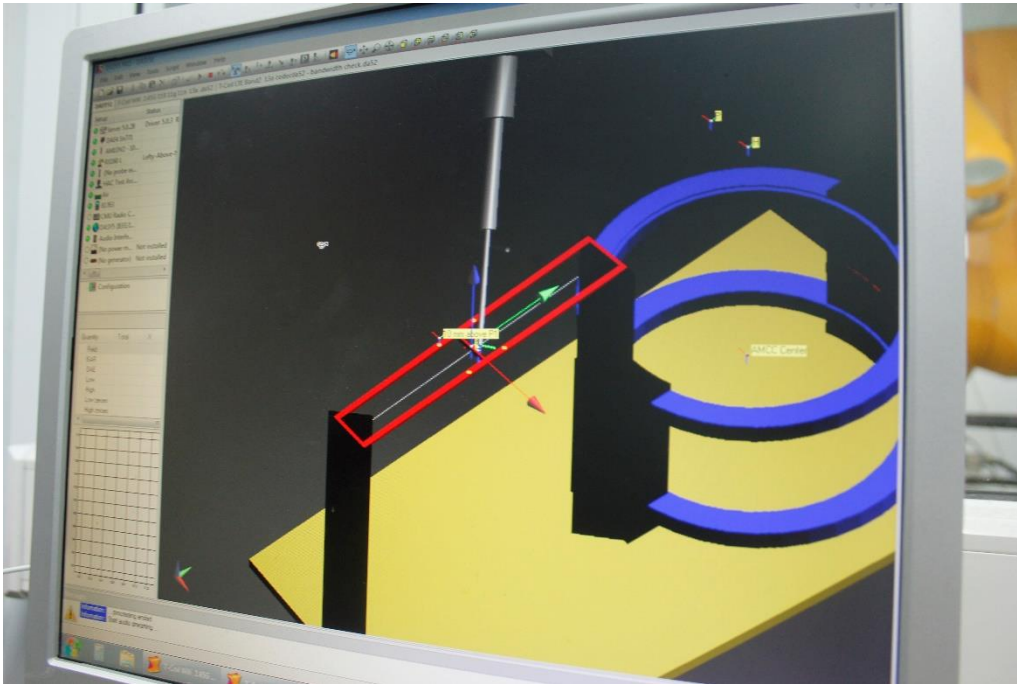

Device2:

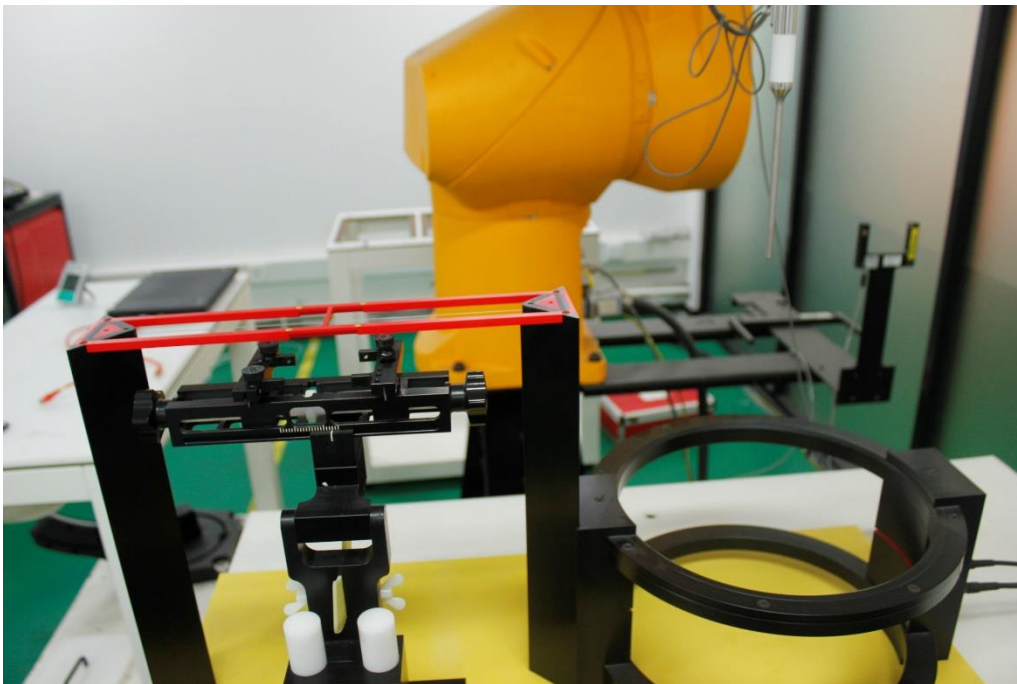

Device3:



Device4:



Device5: The auxiliary device is pre-installed with a test version of Google duo app, The test version app can control the configurations of audio codec bitrate

Device6: The photo of DUT are presented in the additional document: Appendix to test report No.I22Z61444-SEM05/06 The photos of HAC test

### Audio Level Settings

According to KDB 285076 D02, the average speech level of -20dBm0 shall be used for protocols not specifically listed in Table 7.1 of ANSI C63.19-2011.

Determine Input Audio level is based on the Added additional dBFS level readout by Google Duo customize application and three steps need to do.

1. Input a gain value to readout the -23dBFS level as reference. (0dBFS = 3.14 dBm0)
2. Adjust gain level to readout the dBFS level until it changes to -24dBFS.
3. Based on the step 1 and 2, and then calculate the gain value(dB) by interpolation to get the -20dBm0 corresponding gain value.

### Codec Bit-rate Investigation

An investigation between the various bit-rate configurations (Low/Mid/High bit rates for Narrowband, Wideband, and EVS) are documented (ABM, SNNR, frequency response) to determine the worst case bit-rate for each voice service type. The tables below compare the varying bit-rate configurations

### Air Interface Investigation

Using the worst-case bit-rate and Radio Configuration found in §11.2/11.3/11.4, a limited set of bands/channel/ bandwidths were then tested to confirm that there is no effect to the T-rating when changing the band/channel/bandwidth, it is necessary to report only a set band/channel/bandwidth for each orientation for a voice service/air interface.

## 11.2 Codec Configuration

An investigation was performed for each applicable data mode to determine the audio codec configuration to be used for testing. The 6kbps codec setting was used for the audio codec on the auxiliary VoIP unit for OTT VoIP T-coil testing. See below tables for comparisons between codec data rates on all applicable data modes:

**Table 11-2 Codec Investigation – OTT over HSPA**

Codec Setting	64kbps	6kbps	Orientation	Channel
ABM1 (dBA/m)	-6.05	-5.44	Z(axial)	9400
Frequency Response	Pass	Pass		
SNR (dB)	33.63	32.88		

**Table 11-3 Codec Investigation – OTT over LTE**

Codec Setting	64kbps	6kbps	Orientation	Band/BW	Channel
ABM1 (dBA/m)	-4.86	-6.25	Z(axial)	B2/20M	18900
Frequency Response	Pass	Pass			
SNR (dB)	30.66	30.28			

**Table 11-4 Codec Investigation – OTT over WiFi**

Codec Setting	64kbps	6kbps	Orientation	Band/BW	Channel
ABM1 (dBA/m)	-5.03	-4.48	Z(axial)	2.4GHz 802.11b	6
Frequency Response	Pass	Pass			
SNR (dB)	36.31	35.32			

### 11.3 Radio Configuration for OTT VoIP (LTE)

An investigation was performed to determine the modulation and RB configuration to be used for testing. 20MHz BW, QPSK, 1RB, 0RB offset was used for the testing as the worst-case configuration for the handset. See below table for comparisons between different radio configurations:

**Table 11-5 OTT VoIP (LTE) SNR by Radio Configuration**

Band	Channel	Bandwidth [MHz]	Modulation	RB Size	RB Offset(%)	ABM1 [dB(A/m)]	SNR [dB]
LTE B2	18900	20	QPSK	1	0	-5.95	31.78
LTE B2	18900	20	QPSK	1	50	-6.25	30.28
LTE B2	18900	20	QPSK	1	99	-6.38	32.75
LTE B2	18900	20	QPSK	50	0	-6.16	32.98
LTE B2	18900	20	QPSK	50	25	-5.33	33.12
LTE B2	18900	20	QPSK	50	50	-6.28	33.26
LTE B2	18900	20	QPSK	100	0	-4.16	32.49
LTE B2	18900	20	16QAM	1	0	-7.47	33.01
LTE B2	18900	20	64QAM	1	0	-6.20	32.59
LTE B2	18900	15	QPSK	1	0	-4.42	32.88
LTE B2	18900	10	QPSK	1	0	-6.44	31.55
LTE B2	18900	5	QPSK	1	0	-5.36	33.70
LTE B2	18900	3	QPSK	1	0	-6.75	32.94
LTE B2	18900	1.4	QPSK	1	0	-6.07	32.89

An investigation was performed to determine the worst-case LTE band to be used for OTT VoIP testing. LTE Band 30 of FDD were used for the testing as the worst-case configuration for the handset. See below table for comparisons between different LTE bands:

**Table 11-6 OTT VoIP (LTE) SNR by LTE bands**

Band	Channel	Bandwidth [MHz]	Modulation	RB Size	RB Offset	ABM1 [dB(A/m)]	SNR [dB]
LTE B2	18900	20	QPSK	1	50	-6.25	30.28
LTE B4	20175	20	QPSK	1	50	-5.94	32.47
LTE B5	20525	10	QPSK	1	50	-5.74	33.00
LTE B12	23095	10	QPSK	1	50	-5.14	34.34
LTE B14	23330	10	QPSK	1	50	-5.69	30.99
LTE B30	27710	10	QPSK	1	50	-6.97	30.25



## 11.4 Radio Configuration for OTT VoIP (WiFi)

An investigation was performed on all applicable data rates and modulations to determine the radio configuration to be used for testing. See below tables for comparisons between different radio configurations in each 802.11 standard:

**Table 11-7 802.11b SNR by Radio Configuration**

Mode	Channel	Modulation	Data Rate [Mbps]	ABM1 [dB(A/m)]	SNR [dB]
802.11b	6	DSSS	1	-5.28	35.95
802.11b	6	DSSS	2	-3.58	36.77
802.11b	6	CCK	5.5	-4.48	35.32
802.11b	6	CCK	11	-4.01	36.17

**Table 11-8 802.11g/a SNR by Radio Configuration**

Mode	Channel	Modulation	Data Rate [Mbps]	ABM1 [dB(A/m)]	SNR [dB]
802.11g	6	BPSK	6	-6.23	35.06
802.11g	6	BPSK	9	-5.28	34.95
802.11g	6	QPSK	12	-6.06	34.30
802.11g	6	QPSK	18	-4.18	35.01
802.11g	6	16-QAM	24	-5.30	35.74
802.11g	6	16-QAM	36	-4.42	35.94
802.11g	6	64-QAM	48	-6.77	34.81
802.11g	6	64-QAM	54	-4.05	35.04

**Table 11-9 802.11ac 20MHz BW SNR by Radio Configuration**

Mode	Bandwidth [MHz]	Channel	Modulation	Data Rate [Mbps]	ABM1 [dB(A/m)]	SNR [dB]
802.11ac	20	44	BPSK	6.5	-5.50	33.57
802.11ac	20	44	QPSK	13	-5.86	32.10
802.11ac	20	44	QPSK	19.5	-5.91	32.78
802.11ac	20	44	16-QAM	26	-5.29	32.19
802.11ac	20	44	16-QAM	39	-5.81	32.98
802.11ac	20	44	64-QAM	52	-6.04	33.21
802.11ac	20	44	64-QAM	58.5	-5.86	33.03
802.11ac	20	44	64-QAM	65	-5.86	33.39
802.11ac	20	44	256-QAM	78	-6.27	35.08

**Table 11-10 802.11ac 40MHz BW SNR by Radio Configuration**

Mode	Bandwidth [MHz]	Channel	Modulation	Data Rate [Mbps]	ABM1 [dB(A/m)]	SNR [dB]
802.11ac	40	46	BPSK	13.5	-5.66	34.15
802.11ac	40	46	QPSK	27	-5.93	34.29
802.11ac	40	46	QPSK	40.5	-5.24	32.14
802.11ac	40	46	16-QAM	54	-5.55	33.97
802.11ac	40	46	16-QAM	81	-5.06	32.55
802.11ac	40	46	64-QAM	108	-4.89	33.06
802.11ac	40	46	64-QAM	121.5	-5.08	34.21
802.11ac	40	46	64-QAM	135	-4.88	34.82
802.11ac	40	46	256-QAM	180	-6.27	35.29

**Table 11-11 802.11ac 80MHz BW SNR by Radio Configuration**

Mode	Bandwidth [MHz]	Channel	Modulation	Data Rate [Mbps]	ABM1 [dB(A/m)]	SNR [dB]
802.11ac	80	42	BPSK	29.3	-4.33	33.26
802.11ac	80	42	QPSK	58.5	-5.78	32.46
802.11ac	80	42	QPSK	87.8	-4.34	34.08
802.11ac	80	42	16-QAM	117	-5.11	33.54
802.11ac	80	42	16-QAM	175.5	-4.94	32.82
802.11ac	80	42	64-QAM	234	-5.82	33.06
802.11ac	80	42	64-QAM	263.3	-4.71	34.19
802.11ac	80	42	64-QAM	292.5	-4.93	33.73
802.11ac	80	42	256-QAM	351	-5.06	32.66
802.11ac	80	42	256-QAM	390	-4.28	34.08

## 12 HAC T-Coil TEST DATA SUMMARY

### 12.1 Test Results for 3G

Table 12-1 Test results for 3G

Probe Position	Band	Ch.	Measurement Position (x mm, y mm)	ABM1 (dB A/m)	SNR (dB)	Category T ?
Transverse y	W850	4407	0.4,2.1	-8.5	41.35	T4
	W1900	9800	3.3,0	-8.12	41.33	T4
	W1700	1637	1.3,0	-9.98	38.83	T4
Perpendicular z	W850	4407	5,8.7	-1.85	39.95	T4
	W1900	9800	11.7,9.6	-2.55	40.51	T4
	W1700	1637	4.6,9.2	-3.19	37.37	T4

Note:

1. Bluetooth and WiFi function is turn off and microphone is muted.
2. The volume is adjusted to maximum level during T-Coil testing.

### 12.2 Test Results for LTE

Table 12-2 Test results for LTE

Probe Position	Band	Ch.	Bandwidth	Measurement Position (x mm, y mm)	ABM1 (dB A/m)	SNR (dB)	Category T ?
Transverse y	LTE B2	18900	20M	2.9,-0.4	-12.25	35.51	T4
	LTE B4	20175	20M	4.2,0.4	-11.71	37.26	T4
	LTE B5	20525	10M	3.3,0	-12.00	37.34	T4
	LTE B12	23095	10M	4.2,0.8	-11.79	36.87	T4
	LTE B14	23330	10M	4.2,0	-11.86	36.80	T4
	LTE B30	27710	10M	4.2,0.4	-11.55	36.66	T4
Perpendicular z	LTE B2	18900	20M	5.4,10.4	-5.48	30.50	T4
	LTE B4	20175	20M	4.6,11.2	-5.44	32.28	T4
	LTE B5	20525	10M	4.2,9.6	-5.69	31.73	T4
	LTE B12	23095	10M	4.6,11.7	-5.59	32.39	T4
	LTE B14	23330	10M	4.2,10.8	-6.08	31.19	T4
	LTE B30	27710	10M	4.6,10.4	-5.87	30.02	T4

Note:

1. Bluetooth and WiFi function is turn off and microphone is muted.
2. The volume is adjusted to maximum level during T-Coil testing.

### 12.3 Test Results for WiFi

Table 12-3 Test results for WiFi

Probe Position	Mode	Ch.	Bandwidth	Measurement Position (x mm, y mm)	ABM1 (dB A/m)	SNR (dB)	Category T ?
Transverse y	802.11b	6	20M	1,3,0	-12.78	35.39	T4
	802.11g	6	20M	5,0,8	-10.76	41.12	T4
	802.11n	6	20M	3.3,3.3	-11.49	36.97	T4
	802.11n	6	40M	7.1,2.1	-10.96	40.24	T4
	802.11a UNII-1	44	20M	0.4,0	-13.39	38.20	T4
	802.11n UNII-1	44	20M	7.9,-4.2	-13.38	38.18	T4
		46	40M	7.9,1.7	-11.07	40.38	T4
	802.11ac UNII-1	44	20M	7.5,2.5	-10.91	40.20	T4
		46	40M	4.2,0	-11.65	37.05	T4
		42	80M	3.3,0.8	-11.43	37.17	T4
	802.11ac	62	40M	3.8,-0.4	-11.79	37.13	T4
802.11ac	126	40M	2.5,0	-12.29	38.01	T4	
802.11ac	159	40M	3.8,-2.1	-12.60	34.96	T4	
Perpendicular z	802.11b	6	20M	7.1,12.1	-4.47	37.46	T4
	802.11g	6	20M	7.1,12.1	-4.54	37.55	T4
	802.11n	6	20M	6.7,12.5	-4.65	37.72	T4
	802.11n	6	40M	4.2,12.1	-4.62	36.94	T4
	802.11a UNII-1	44	20M	7.5,10.4	-4.73	36.55	T4
	802.11n UNII-1	44	20M	7.9,13.3	-4.38	33.61	T4
		46	40M	4.2,8.7	-5.81	36.19	T4
	802.11ac UNII-1	44	20M	0.4,8.3	-7.78	35.17	T4
		46	40M	4.2,9.6	-5.22	34.17	T4
		42	80M	7.5,12.1	-3.95	37.45	T4
	802.11n	60	20M	7.9,12.1	-4.87	34.29	T4
	802.11n	124	20M	7.5,12.5	-0.31	39.31	T4
802.11n	157	20M	7.1,12.5	-4.66	37.09	T4	

Note:

1. Bluetooth function is turn of Nf and microphone is muted.
2. The volume is adjusted to maximum level during T-Coil testing.

### 12.4 Test Results for OTT VoIP

Table 12-4 Test results for 2/3G

Probe Position	Band	Ch.	Measurement Position (x mm, y mm)	ABM1 (dB A/m)	SNR (dB)	Category T ?
Transverse y	W850	4407	0.4,-0.8	-13.44	36.19	T4
	W1900	9800	0.4,-3.3	-13.59	36.57	T4
	W1700	1637	0,0.4	-14.10	35.02	T4



<b>Perpendicular z</b>	<b>W850</b>	4407	4.2,8.7	-6.29	32.80	<b>T4</b>
	<b>W1900</b>	9800	4.6,9.6	-5.44	32.88	<b>T4</b>
	<b>W1700</b>	1637	4.6,8.7	-6.55	35.63	<b>T4</b>

Note:

1. Bluetooth and WiFi function is turn off and microphone is muted.
2. The volume is adjusted to maximum level during T-Coil testing.

**Table 12-5 Test results for LTE**

Probe Position	Band	Ch.	Band width	Measurement Position (x mm, y mm)	ABM1 (dB A/m)	SNR (dB)	Category T ?
<b>Transverse y</b>	<b>LTE B30</b>	27710	10	4.2,0	-12.00	33.49	<b>T4</b>
<b>Perpendicular z</b>	<b>LTE B30</b>	27710	10	5,8.7	-6.97	30.25	<b>T4</b>

Note:

1. Bluetooth and WiFi function is turn off and microphone is muted.
2. The volume is adjusted to maximum level during T-Coil testing.

**Table 12-6 Test results for WiFi**

Probe Position	Mode	Ch.	Bandwidth	Measurement Position (x mm, y mm)	ABM1 (dB A/m)	SNR (dB)	Category T ?
<b>Transverse y</b>	<b>802.11b</b>	6	20M	-1.2,0	-14.58	29.93	<b>T3</b>
	<b>802.11g</b>	6	20M	3.3,4.2	-12.27	34.22	<b>T4</b>
	<b>802.11n</b>	6	20M	4.2,0	-12.38	35.39	<b>T4</b>
	<b>802.11n</b>	6	40M	2.9,3.3	-12.39	32.89	<b>T4</b>
	<b>802.11a UNII-1</b>	44	20M	3.8,-3.8	-13.20	32.62	<b>T4</b>
	<b>802.11n UNII-1</b>	44	20M	0.4,-1.3	-12.98	32.66	<b>T4</b>
		46	40M	2.1,0.4	-11.86	33.07	<b>T4</b>
	<b>802.11ac UNII-1</b>	44	20M	0.4,0	-11.62	34.43	<b>T4</b>
		46	40M	-0.4,-0.8	-13.45	31.91	<b>T4</b>
		42	80M	-0.4,-2.9	-14.14	31.95	<b>T4</b>
	<b>802.11ac</b>	62	40M	3.3,0	-12.26	31.21	<b>T4</b>
<b>802.11ac</b>	126	40M	0.4,0	-14.00	30.05	<b>T4</b>	
<b>802.11ac</b>	159	40M	-3.3,-0.8	-16.03	30.98	<b>T4</b>	
<b>Perpendicular z</b>	<b>802.11b</b>	6	20M	5.4,12.1	-4.48	35.32	<b>T4</b>
	<b>802.11g</b>	6	20M	4.6,10.8	-6.06	34.30	<b>T4</b>
	<b>802.11n</b>	6	20M	7.1,9.2	-5.31	35.91	<b>T4</b>
	<b>802.11n</b>	6	40M	7.5,9.2	-4.65	34.90	<b>T4</b>
	<b>802.11a UNII-1</b>	44	20M	7.9,8.7	-5.65	35.82	<b>T4</b>
	<b>802.11n UNII-1</b>	44	20M	7.9,9.6	-6.03	34.09	<b>T4</b>
		46	40M	4.6,9.2	-5.32	36.11	<b>T4</b>
	<b>802.11ac UNII-1</b>	44	20M	8.3,8.7	-5.86	32.10	<b>T4</b>



		46	40M	7.9,10.8	-5.24	32.14	<b>T4</b>
		42	80M	4.2,8.7	-5.78	32.46	<b>T4</b>
	<b>802.11ac</b>	60	20M	5,11.7	-5.35	34.55	<b>T4</b>
	<b>802.11ac</b>	124	20M	4.6,11.7	-4.41	35.74	<b>T4</b>
	<b>802.11ac</b>	157	20M	6.3,8.3	-5.16	39.20	<b>T4</b>

Note:

1. Bluetooth function is turn off and microphone is muted.
2. The volume is adjusted to maximum level during T-Coil testing.

**12.5 Total Measurement Conclusion**

Probe	Frequency Band(MHz)	ABM1	Frequency Response	T Category
Transverse	WCDMA850	Pass	\	T4
	WCDMA1900	Pass		T4
	WCDMA1700	Pass		T4
	LTE B2	Pass		T4
	LTE B4	Pass		T4
	LTE B5	Pass		T4
	LTE B12	Pass		T4
	LTE B14	Pass		T4
	LTE B30	Pass		T4
	WiFi 2.4G	Pass		T3
	WiFi 5G	Pass		T4
Perpendicular	WCDMA850	Pass	Pass	T4
	WCDMA1900	Pass	Pass	T4
	WCDMA1700	Pass	Pass	T4
	LTE B2	Pass	Pass	T4
	LTE B4	Pass	Pass	T4
	LTE B5	Pass	Pass	T4
	LTE B12	Pass	Pass	T4
	LTE B14	Pass	Pass	T4
	LTE B30	Pass	Pass	T4
	WiFi 2.4G	Pass	Pass	T4
	WiFi 5G	Pass	Pass	T4

## 14 MEASUREMENT UNCERTAINTY

No.	Error source	Type	Uncertainty Value $a_i$ (%)	Prob. Dist.	Div.	ABM1 ci	ABM2 ci	Std. Unc. ABM1 $u_i$ (%)	Std. Unc. ABM2 $u_i$ (%)
1	System Repeatability	A	0.016	N	1	1	1	0.016	0.016
<b>Probe Sensitivity</b>									
2	Reference Level	B	3.0	R	$\sqrt{3}$	1	1	3.0	3.0
3	AMCC Geometry	B	0.4	R	$\sqrt{3}$	1	1	0.2	0.2
4	AMCC Current	B	0.6	R	$\sqrt{3}$	1	1	0.4	0.4
5	Probe Positioning during Calibration	B	0.1	R	$\sqrt{3}$	1	1	0.1	0.1
6	Noise Contribution	B	0.7	R	$\sqrt{3}$	0.014 3	1	0.0	0.4
7	Frequency Slope	B	5.9	R	$\sqrt{3}$	0.1	1	0.3	3.5
<b>Probe System</b>									
8	Repeatability / Drift	B	1.0	R	$\sqrt{3}$	1	1	0.6	0.6
9	Linearity / DynamicRange	B	0.6	N	1	1	1	0.4	0.4
10	Acoustic Noise	B	1.0	R	$\sqrt{3}$	0.1	1	0.1	0.6
11	Probe Angle	B	2.3	R	$\sqrt{3}$	1	1	1.4	1.4
12	Spectral Processing	B	0.9	R	$\sqrt{3}$	1	1	0.5	0.5
13	Integration Time	B	0.6	N	1	1	5	0.6	3.0
14	Field Distribution	B	0.2	R	$\sqrt{3}$	1	1	0.1	0.1

<b>Test Signal</b>										
15	Ref.Signal Response	Spectral	B	0.6	R	$\sqrt{3}$	0	1	0.0	0.4
<b>Positioning</b>										
16	Probe Positioning		B	1.9	R	$\sqrt{3}$	1	1	1.1	1.1
17	Phantom Thickness		B	0.9	R	$\sqrt{3}$	1	1	0.5	0.5
18	DUT Positioning		B	1.9	R	$\sqrt{3}$	1	1	1.1	1.1
<b>External Contributions</b>										
19	RF Interference		B	0.0	R	$\sqrt{3}$	1	0.3	0.0	0.0
20	Test Signal Variation		B	2.0	R	$\sqrt{3}$	1	1	1.2	1.2
Combined Std. Uncertainty (ABM Field)			$u_c' = \sqrt{\sum_{i=1}^{20} c_i^2 u_i^2}$						4.1	6.1
Expanded Std. Uncertainty			$u_e = 2u_c$	N	$k = 2$			8.2	12.2	

## 15 MAIN TEST INSTRUMENTS

### List of Main Instruments

No.	Name	Type	Serial Number	Calibration Date	Valid Period
01	Audio Magnetic 1D Field Probe	AM1DV2	1064	July 19, 2022	One year
02	Audio Magnetic Calibration Coil	AMCC	1064	NCR	NCR
03	Audio Measuring Instrument	AMMI	1044	NCR	NCR
04	HAC Test Arch	N/A	1014	NCR	NCR
05	DAE	SPEAG DAE4	1524	October 08,2021	One year
06	Software	DASY5	N/A	NCR	NCR

		V5.0 Build 119.9			
07	Software	SEMCAD V13.2 Build 87	N/A	NCR	NCR
08	Universal Radio Communication Tester	CMW 500	166370	June28,2022	One year

\*\*\*END OF REPORT BODY\*\*\*

## ANNEX A TEST LAYOUT

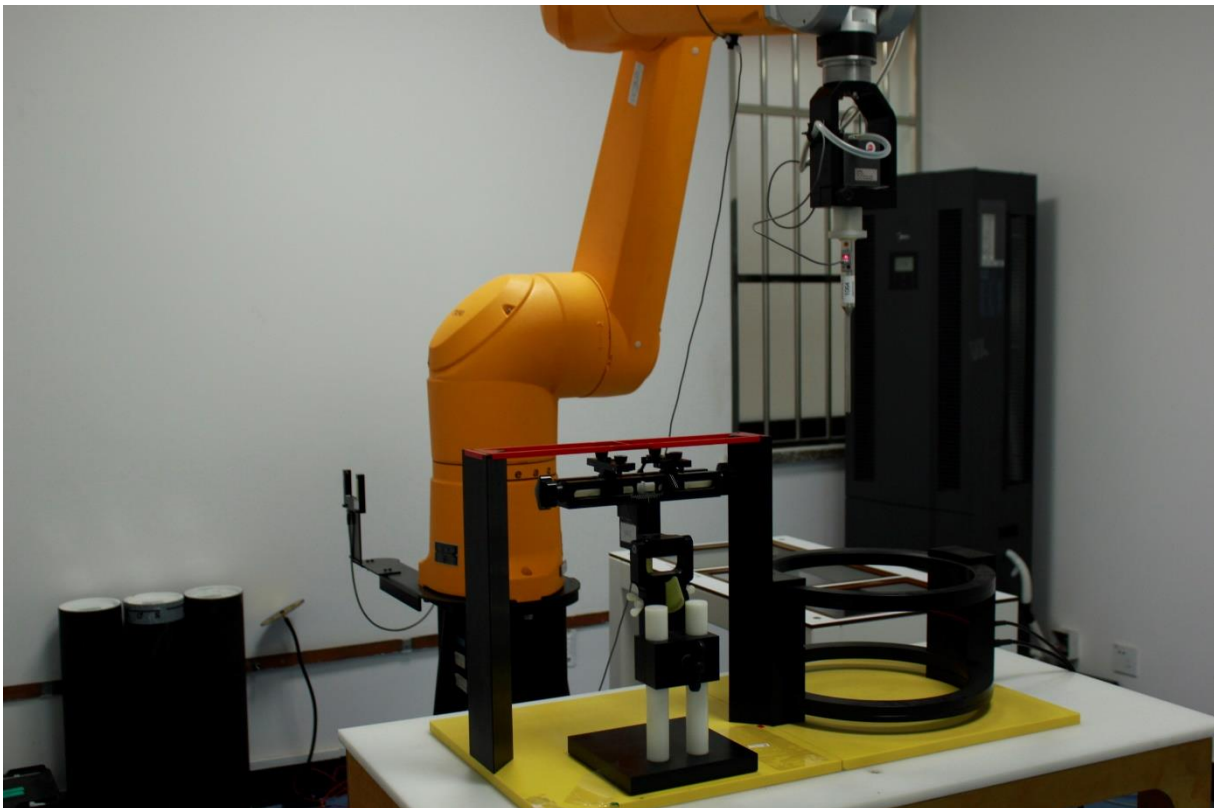

Picture A1: HAC T-Coil System Layout



## ANNEX B TEST PLOTS

### T-Coil WIFI5G Transverse

Date: 2022-08-09

Electronics: DAE4 Sn1524

Medium: Air

Medium parameters used:  $\sigma = 0$  mho/m,  $\epsilon_r = 1$ ;  $\rho = 1$  kg/m<sup>3</sup>

Ambient Temperature: 22.5°C

Communication System: WIFI5G; Frequency: 5795 MHz; Duty Cycle: 1:1

Probe: AM1DV2 - 1064;

T-Coil scan (scan for ANSI C63.19-2007 & 2011 compliance)/General

Scans/y (transversal) 4.2mm 50 x 50/ABM Interpolated Signal(x, y, z)

(121x121x1): Interpolated grid: dx=1.000 mm, dy=1.000 mm

Signal Type: Audio File (.wav) 48k\_voice\_1kHz\_1s.wav

Output Gain: 30

Measure Window Start: 300ms

Measure Window Length: 1000ms

BWC applied: 0.16 dB

Device Reference Point: 0, 0, -6.3 mm

### Cursor:

ABM1 = -10.99 dBA/m

BWC Factor = 0.16 dB

Location: 8.3, 2.1, 3.7 mm

T-Coil scan (scan for ANSI C63.19-2007 & 2011 compliance)/General

Scans/y (transversal) 4.2mm 50 x 50/ABM Interpolated SNR(x, y, z)

(121x121x1): Interpolated grid: dx=1.000 mm, dy=1.000 mm

Signal Type: Audio File (.wav) 48k\_voice\_1kHz\_1s.wav

Output Gain: 30

Measure Window Start: 300ms

Measure Window Length: 1000ms

BWC applied: 0.16 dB

Device Reference Point: 0, 0, -6.3 mm

### Cursor:

ABM1/ABM2 = 34.96 dB

ABM1 comp = -12.60 dBA/m

BWC Factor = 0.16 dB

Location: 3.8, -2.1, 3.7 mm

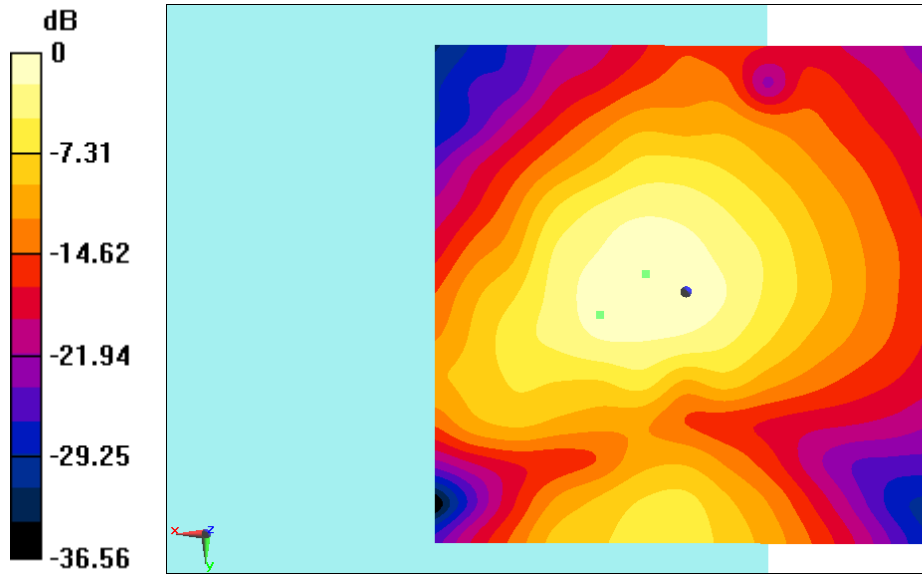

0 dB = 0.2822 A/m = -10.99 dBA/m

**Fig B.1 T-Coil WiFi5G**



**T-Coil LTEB30 Perpendicular**

Date: 2022-08-13

Electronics: DAE4 Sn1524

Medium: Air

Medium parameters used:  $\sigma = 0$  mho/m,  $\epsilon_r = 1$ ;  $\rho = 1$  kg/m<sup>3</sup>

Ambient Temperature: 22.5°C

Communication System: LTEB30; Frequency: 2310 MHz; Duty Cycle: 1:1

Probe: AM1DV2 - 1064;

T-Coil scan (scan for ANSI C63.19-2007 &amp; 2011 compliance)/General

Scans/z (axial) 4.2mm 50 x 50/ABM Interpolated Signal(x, y, z)

(121x121x1): Interpolated grid: dx=1.000 mm, dy=1.000 mm

Signal Type: Audio File (.wav) 48k\_voice\_1kHz\_1s.wav

Output Gain: 30

Measure Window Start: 300ms

Measure Window Length: 1000ms

BWC applied: 0.16 dB

Device Reference Point: 0, 0, -6.3 mm

**Cursor:**

ABM1 = -4.40 dBA/m

BWC Factor = 0.16 dB

Location: 12.1, 15.8, 3.7 mm

T-Coil scan (scan for ANSI C63.19-2007 &amp; 2011 compliance)/General

Scans/z (axial) 4.2mm 50 x 50/ABM Interpolated SNR(x, y, z)

(121x121x1): Interpolated grid: dx=1.000 mm, dy=1.000 mm

Signal Type: Audio File (.wav) 48k\_voice\_1kHz\_1s.wav

Output Gain: 30

Measure Window Start: 300ms

Measure Window Length: 1000ms

BWC applied: 0.16 dB

Device Reference Point: 0, 0, -6.3 mm

**Cursor:**

ABM1/ABM2 = 30.02 dB

ABM1 comp = -5.87 dBA/m

BWC Factor = 0.16 dB

Location: 4.6, 10.4, 3.7 mm

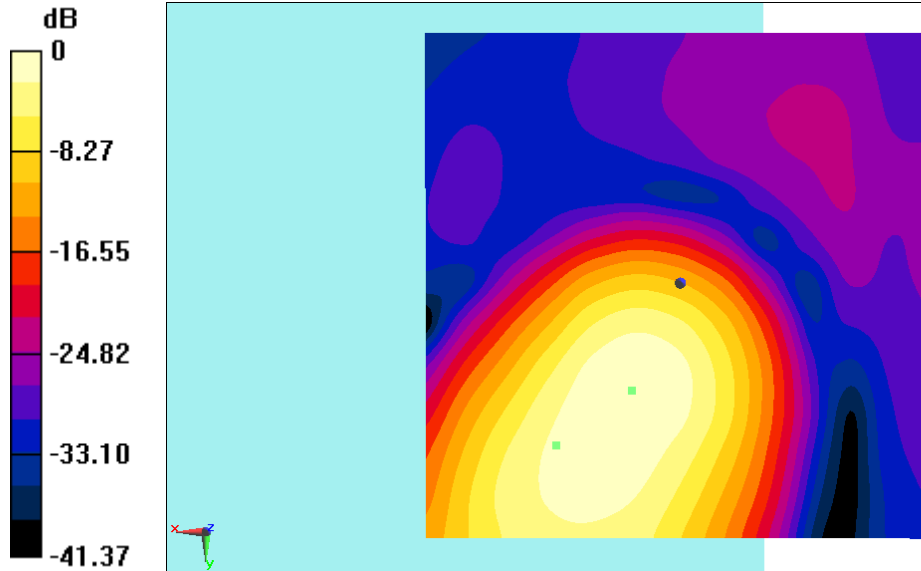
 $0 \text{ dB} = 0.6028 \text{ A/m} = -4.40 \text{ dBA/m}$ **Fig B.2 T-Coil LTEB30**

**T-Coil WIFI2.4G Transverse – OTT VoIP**

Date: 2022-08-06

Electronics: DAE4 Sn1524

Medium: Air

Medium parameters used:  $\sigma = 0$  mho/m,  $\epsilon_r = 1$ ;  $\rho = 1$  kg/m<sup>3</sup>

Ambient Temperature: 22.5°C

Communication System: WIFI2.4G; Frequency: 2437MHz; Duty Cycle: 1:1

Probe: AM1DV2 - 1064;

T-Coil scan (scan for ANSI C63.19–2007 &amp; 2011 compliance)/General

Scans/y (transversal) 4.2mm 50 x 50/ABM Interpolated Signal(x, y, z)

(121x121x1): Interpolated grid: dx=1.000 mm, dy=1.000 mm

Signal Type: Audio File (.wav) 48k\_voice\_1kHz\_1s.wav

Output Gain: 100

Measure Window Start: 300ms

Measure Window Length: 1000ms

BWC applied: 0.16 dB

Device Reference Point: 0, 0, -6.3 mm

**Cursor:**

ABM1 = -11.29 dBA/m

BWC Factor = 0.16 dB

Location: 8.8, 2.9, 3.7 mm

T-Coil scan (scan for ANSI C63.19–2007 &amp; 2011 compliance)/General

Scans/y (transversal) 4.2mm 50 x 50/ABM Interpolated SNR(x, y, z)

(121x121x1): Interpolated grid: dx=1.000 mm, dy=1.000 mm

Signal Type: Audio File (.wav) 48k\_voice\_1kHz\_1s.wav

Output Gain: 100

Measure Window Start: 300ms

Measure Window Length: 1000ms

BWC applied: 0.16 dB

Device Reference Point: 0, 0, -6.3 mm

**Cursor:**

ABM1/ABM2 = 29.93 dB

ABM1 comp = -14.58 dBA/m

BWC Factor = 0.16 dB

Location: -1.2, 0, 3.7 mm

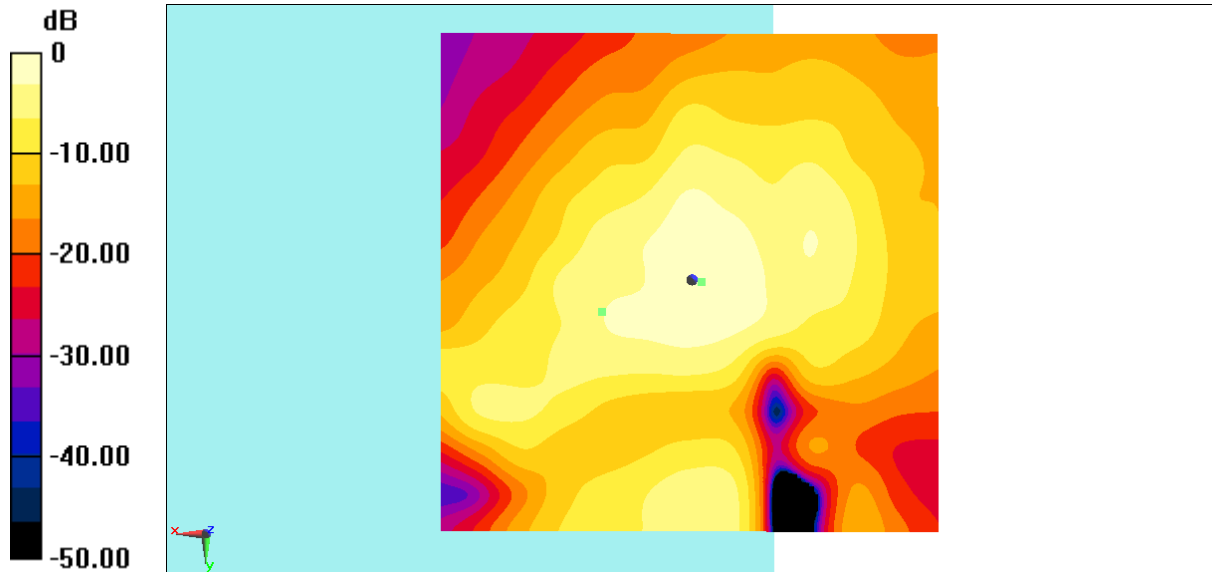

0 dB = 0.2725 A/m = -11.29 dBA/m

**Fig B.3 T-Coil WIFI2.4G-OTT**

**T-Coil LTEB30 Perpendicular- OTT VoIP**

Date: 2022-08-07

Electronics: DAE4 Sn1524

Medium: Air

Medium parameters used:  $\sigma = 0$  mho/m,  $\epsilon_r = 1$ ;  $\rho = 1$  kg/m<sup>3</sup>

Ambient Temperature: 22.5°C

Communication System: LTEB30; Frequency: 2310 MHz; Duty Cycle: 1:1

Probe: AM1DV2 - 1064;

T-Coil scan (scan for ANSI C63.19-2007 &amp; 2011 compliance)/General

Scans/z (axial) 4.2mm 50 x 50/ABM Interpolated Signal(x, y, z)

(121x121x1): Interpolated grid: dx=1.000 mm, dy=1.000 mm

Signal Type: Audio File (.wav) 48k\_voice\_1kHz\_1s.wav

Output Gain: 100

Measure Window Start: 300ms

Measure Window Length: 1000ms

BWC applied: 0.16 dB

Device Reference Point: 0, 0, -6.3 mm

**Cursor:**

ABM1 = -4.72 dBA/m

BWC Factor = 0.16 dB

Location: 12.5, 15.4, 3.7 mm

T-Coil scan (scan for ANSI C63.19-2007 &amp; 2011 compliance)/General

Scans/z (axial) 4.2mm 50 x 50/ABM Interpolated SNR(x, y, z)

(121x121x1): Interpolated grid: dx=1.000 mm, dy=1.000 mm

Signal Type: Audio File (.wav) 48k\_voice\_1kHz\_1s.wav

Output Gain: 100

Measure Window Start: 300ms

Measure Window Length: 1000ms

BWC applied: 0.16 dB

Device Reference Point: 0, 0, -6.3 mm

**Cursor:**

ABM1/ABM2 = 30.25 dB  
ABM1 comp = -6.97 dBA/m  
BWC Factor = 0.16 dB  
Location: 5, 8.7, 3.7 mm

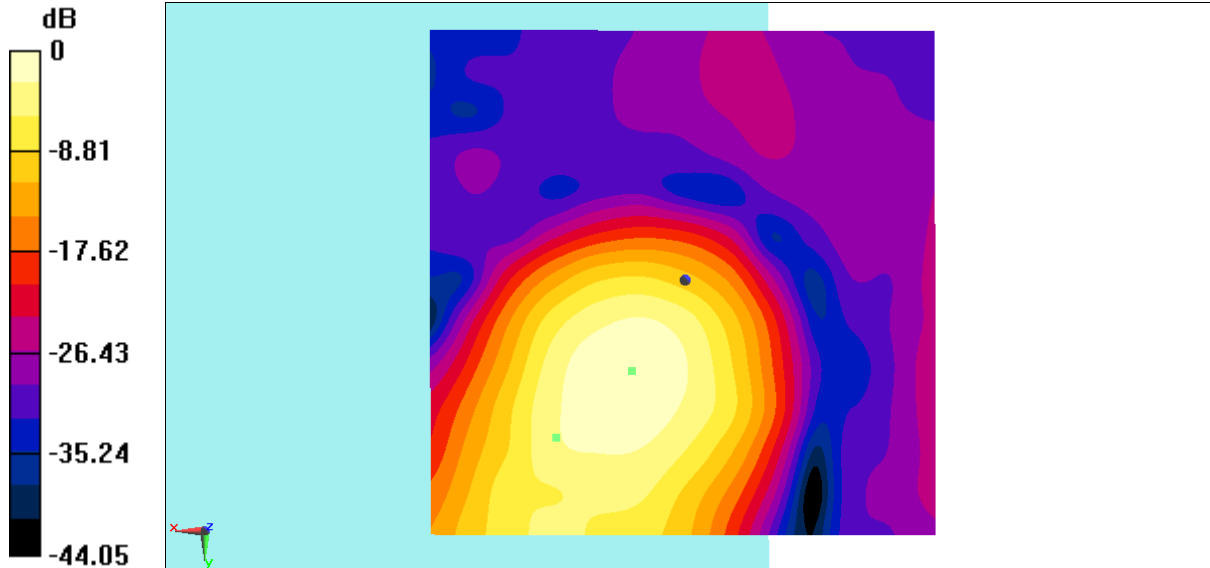

0 dB = 0.5809 A/m = -4.72 dBA/m

**Fig B.4 T-Coil LTEB30**

## ANNEX C FREQUENCY RESPONSE CURVES

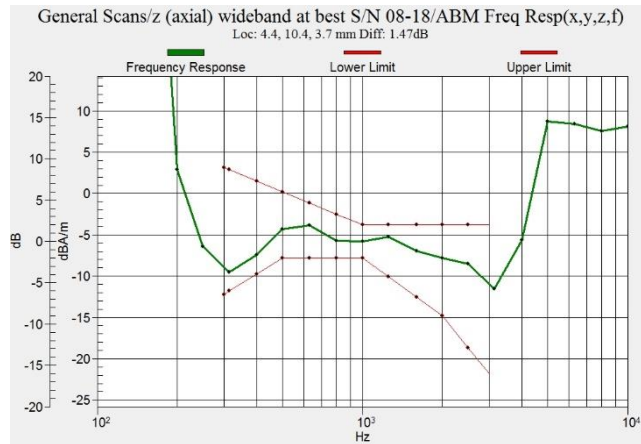

**Figure C.1 Frequency Response of LTEB30**

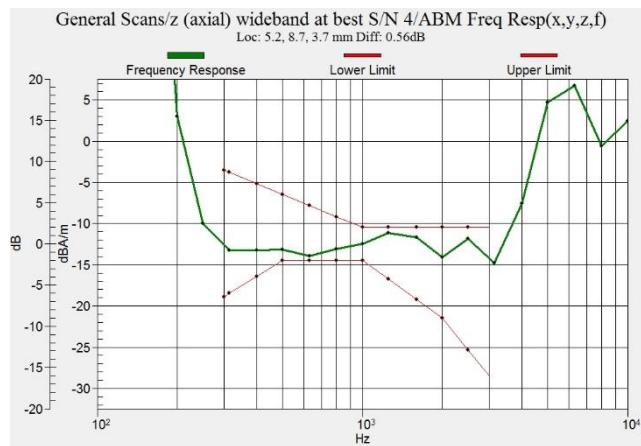

**Figure C.2 Frequency Response of LTEB30 - OTT VoIP**

# ANNEX D PROBECALIBRATIONCERTIFICATE

**Calibration Laboratory of**  
**Schmid & Partner**  
**Engineering AG**  
 Zeughausstrasse 43, 8004 Zurich, Switzerland



**S** Schweizerischer Kalibrierdienst  
**S** Service suisse d'étalonnage  
**C** Servizio svizzero di taratura  
**S** Swiss Calibration Service

Accredited by the Swiss Accreditation Service (SAS)  
 The Swiss Accreditation Service is one of the signatories to the EA  
 Multilateral Agreement for the recognition of calibration certificates

Accreditation No.: **SCS 0108**

Client **CTTL (Auden)**

Certificate No: **AM1DV2-1064\_Jul22**

## CALIBRATION CERTIFICATE

Object **AM1DV2 - SN: 1064**  
 Calibration procedure(s) **QA CAL-24.v4  
 Calibration procedure for AM1D magnetic field probes and TMFS in the  
 audio range**  
 Calibration date: **July 19, 2022**

This calibration certificate documents the traceability to national standards, which realize the physical units of measurements (SI).  
 The measurements and the uncertainties with confidence probability are given on the following pages and are part of the certificate.

All calibrations have been conducted in the closed laboratory facility: environment temperature ( $22 \pm 3$ )°C and humidity < 70%.

Calibration Equipment used (M&TE critical for calibration)

Primary Standards	ID #	Cal Date (Certificate No.)	Scheduled Calibration
Keithley Multimeter Type 2001	SN: 0810278	31-Aug-21 (No. 31368)	Aug-22
Reference Probe AM1DV2	SN: 1008	28-Dec-21 (No. AM1DV2-1008_Dec21)	Dec-22
DAE4	SN: 781	22-Dec-21 (No. DAE4-781_Dec21)	Dec-22
Secondary Standards	ID #	Check Date (in house)	Scheduled Check
AMCC	SN: 1050	01-Oct-13 (in house check Oct-20)	Oct-23
AMMI Audio Measuring Instrument	SN: 1062	26-Sep-12 (in house check Oct-20)	Oct-23

Calibrated by: **Name** **Function** **Signature**  
**Leif Klysner** **Laboratory Technician**

Approved by: **Niels Kuster** **Quality Manager**

Issued: July 20, 2022

This calibration certificate shall not be reproduced except in full without written approval of the laboratory.



## References

- [1] ANSI-C63.19-2007  
American National Standard for Methods of Measurement of Compatibility between Wireless Communications Devices and Hearing Aids.
- [2] ANSI-C63.19-2019 (ANSI-C63.19-2011)  
American National Standard, Methods of Measurement of Compatibility between Wireless Communications Devices and Hearing Aids.
- [3] DASY System Handbook

## Description of the AM1D probe

The AM1D Audio Magnetic Field Probe is a fully shielded magnetic field probe for the frequency range from 100 Hz to 20 kHz. The pickup coil is compliant with the dimensional requirements of [1+2]. The probe includes a symmetric low noise amplifier for the signal available at the shielded 3 pin connector at the side. Power is supplied via the same connector (phantom power supply) and monitored via the LED near the connector. The 7 pin connector at the end of the probe does not carry any signals, but determines the angle of the sensor when mounted on the DAE. The probe supports mechanical detection of the surface.

The single sensor in the probe is arranged in a tilt angle allowing measurement of 3 orthogonal field components when rotating the probe by 120° around its axis. It is aligned with the perpendicular component of the field, if the probe axis is tilted nominally 35.3° above the measurement plane, using the connector rotation and sensor angle stated below.

The probe is fully RF shielded when operated with the matching signal cable (shielded) and allows measurement of audio magnetic fields in the close vicinity of RF emitting wireless devices according to [1+2] without additional shielding.

## Handling of the item

The probe is manufactured from stainless steel. In order to maintain the performance and calibration of the probe, it must not be opened. The probe is designed for operation in air and shall not be exposed to humidity or liquids. For proper operation of the surface detection and emergency stop functions in a DASY system, the probe must be operated with the special probe cup provided (larger diameter).

## Methods Applied and Interpretation of Parameters

- *Coordinate System:* The AM1D probe is mounted in the DASY system for operation with a HAC Test Arch phantom with AMCC Helmholtz calibration coil according to [3], with the tip pointing to “southwest” orientation.
- *Functional Test:* The functional test preceding calibration includes test of Noise level RF immunity (1kHz AM modulated signal). The shield of the probe cable must be well connected. Frequency response verification from 100 Hz to 10 kHz.
- *Connector Rotation:* The connector at the end of the probe does not carry any signals and is used for fixation to the DAE only. The probe is operated in the center of the AMCC Helmholtz coil using a 1 kHz magnetic field signal. Its angle is determined from the two minima at nominally +120° and –120° rotation, so the sensor in the tip of the probe is aligned to the vertical plane in z-direction, corresponding to the field maximum in the AMCC Helmholtz calibration coil.
- *Sensor Angle:* The sensor tilting in the vertical plane from the ideal vertical direction is determined from the two minima at nominally +120° and –120°. DASY system uses this angle to align the sensor for radial measurements to the x and y axis in the horizontal plane.
- *Sensitivity:* With the probe sensor aligned to the z-field in the AMCC, the output of the probe is compared to the magnetic field in the AMCC at 1 kHz. The field in the AMCC Helmholtz coil is given by the geometry and the current through the coil, which is monitored on the precision shunt resistor of the coil.

**AM1D probe identification and configuration data**

Item	<b>AM1DV2</b> Audio Magnetic 1D Field Probe
Type No	SP AM1 001 AF
Serial No	<b>1064</b>

Overall length	296 mm
Tip diameter	6.0 mm (at the tip)
Sensor offset	3.0 mm (centre of sensor from tip)
Internal Amplifier	40 dB

Manufacturer / Origin	Schmid & Partner Engineering AG, Zurich, Switzerland
-----------------------	--

**Calibration data**

Connector rotation angle	(in DASY system)	<b>100.6°</b>	+/- 3.6 ° (k=2)
Sensor angle	(in DASY system)	<b>0.36 °</b>	+/- 0.5 ° (k=2)
Sensitivity at 1 kHz	(in DASY system)	<b>0.0658 V/(A/m)</b>	+/- 2.2 % (k=2)

The reported uncertainty of measurement is stated as the standard uncertainty of measurement multiplied by the coverage factor k=2, which for a normal distribution corresponds to a coverage probability of approximately 95%.







### ANNEX E DAE CALIBRATION CERTIFICATE

 In Collaboration with   
**speag**  
 CALIBRATION LABORATORY

Address: No.52 HuaYuanBei Road, Haidian District, Beijing, 100191, China  
 Tel: +86-10-62304633-2512 Fax: +86-10-62304633-2504  
 E-mail: cttl@chinattl.com [Http://www.chinattl.cn](http://www.chinattl.cn)

Client: **CTTL** Certificate No: **Z21-60392**

---

## CALIBRATION CERTIFICATE

Item: **DAE4 - SN: 1524**

Procedure(s): **FF-Z11-002-01**  
 Calibration Procedure for the Data Acquisition Electronics (DAEx)

Date: **October 08, 2021**

This Calibration Certificate documents the traceability to national standards, which realize the physical quantities (SI). The measurements and the uncertainties with confidence probability are given on this certificate.

Measurements have been conducted in the closed laboratory facility: environment temperature (20 ± 0.5) °C.

Equipment used (M&TE critical for calibration)

Standards	ID #	Cal Date (Calibrated by, Certificate No.)	Scheduled Calibration
Generator 753	1971018	15-Jun-21 (CTTL, No.J21X04465)	Jun-22

Operator: **Yu Zongying** SAR Test Engineer

Signature: 

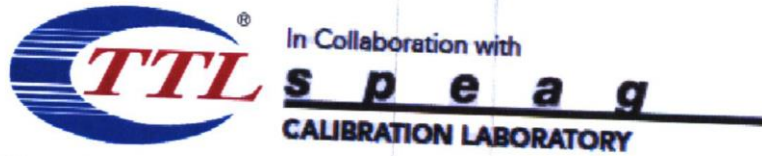

Add: No.52 HuaYuanBei Road, Haidian District, Beijing, 100191, China  
Tel: +86-10-62304633-2512 Fax: +86-10-62304633-2504  
E-mail: cttl@chinattl.com Http://www.chinattl.cn

**Summary:**

connector angle data acquisition electronics  
information used in DASY system to align probe sensor  
to the robot coordinate system.

**Methods Applied and Interpretation of Parameters:**

*DC Voltage Measurement:* Calibration Factor assessed for use in DASY system by comparison with a calibrated instrument traceable to national standards. The figure given corresponds to the full scale range of the multimeter in the respective range.

*connector angle:* The angle of the connector is assessed measuring the angle mechanically by a tool inserted. Uncertainty is not required.

The report provide only calibration results for DAE, it does not contain performance test results.





Add: No.52 HuaYuanBei Road, Haidian District, Beijing, 100191, China
Tel: +86-10-62304633-2512 Fax: +86-10-62304633-2504
E-mail: cttl@chinattl.com Http://www.chinattl.cn

Voltage Measurement

1 - Converter Resolution nominal

High Range: 1LSB = 6.1µV, full range = -100...+300 mV

Low Range: 1LSB = 61nV, full range = -1.....+3mV

ASY measurement parameters: Auto Zero Time: 3 sec; Measuring time: 3 sec

Table with 4 columns: Calibration Factors, X, Y, Z. Rows include High Range and Low Range with values like 406.136 ± 0.15% (k=2) and 3.99155 ± 0.7% (k=2).

Detector Angle

Table with 2 columns: Detector Angle to be used in DASY system, 83° ± 1°



**The photos of HAC test are presented in the additional document:**

Appendix to test report No.I22Z61444-SEM05/06

The photos of HAC test