

High Frequency Ceramic Solutions

2.4, 5, and 6GHz BT/WiFi6E Mini Chip Antenna, Single-feed, Tri-band, Corner Mount P/N 2450AD18A6050

Detail Specification: 10/20/2021

Page 1 of 7

General Specifications			
Part Number	2450AD18A6050		
Frequency (MHz)	2400 - 2500	4900 - 5850	5850 - 7200
Peak Gain (dBi typ.)	+2.0 (YZ-plane)	+1.5 (YZ-plane)	+2.7 (YZ-plane)
Average Gain (dBi typ.)	-1.5 (YZ-plane)	-2.0 (YZ-plane)	-2.0 (YZ-plane)
Return Loss (dB)	6 min.	5 min.	5 min.
Radiation Efficiency % ¹	79	74	85
Impedance (Ω)	50		
Power Capacity (W)	3 max. (CW)		
Operating Temp.	-40°C to +85°C		
Reel Quantity (pcs./reel)	3,000		
Recommended Storage Conditions and Period for unused Product on T&R	+5°C to +35°C Humidity 45 - 75% RH 18 months max.		

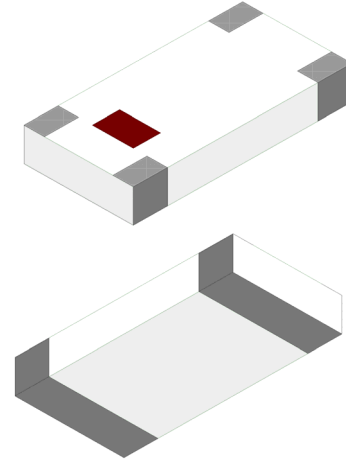

Use this antenna with our diplexers and filters to split the signal into the corresponding RF path. Go to page 7 for the links.

¹Efficiency measured on Johanson's evaluation board PN 2450AD18A6050-EB1SMA

Part Number Explanation				
P/N Suffix	Packing Style	Bulk (loose pcs.)	Suffix = S	E.g. 2450AD18A6050S
		T & R	Suffix = E	E.g. 2450AD18A6050E
		100% Tin	Suffix = E or S	E.g. 2450AD18A6050(E or S)
	Evaluation Board	2450AD18A6050-EB1SMA (Pre-tuned with SMA connectors)		

Mechanical Dimensions		
	In	mm
L	0.126 ± 0.008	3.20 ± 0.20
W	0.063 ± 0.008	1.60 ± 0.20
T	0.020 ± 0.004	0.50 ± 0.10
a	0.012 +0.004/+0.008	0.30 +0.1/-0.2
b	0.020 ± 0.004	0.50 ± 0.10

<Side view>

<Top view>

<Bottom view>

Terminal Configuration	
No.	Function
1	Feed Point
2	NC

Johanson Technology, Inc. reserves the right to make design changes without notice.
All sales are subject to Johanson Technology, Inc. terms and conditions.



<https://www.johansontechnology.com>

4001 Calle Tecate • Camarillo, CA 93012 • TEL 805.389.1166 FAX 805.389.1821

Ver 1.2

2021 Johanson Technology, Inc. All Rights Reserved

High Frequency Ceramic Solutions

2.4, 5, and 6GHz BT/WiFi6E Mini Antenna, Single-feed, Tri-band, Corner Mount

P/N 2450AD18A6050

Detail Specification: 10/20/2021



Page 2 of 7

Layout Recommendations

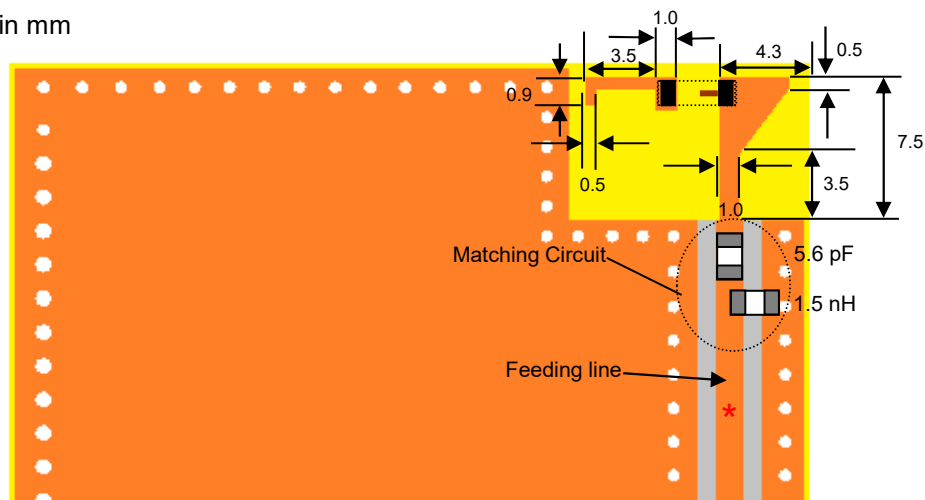
Unit in mm



Ask for the layout/gerber files at: <https://www.johansontechnology.com/ask-a-question>

-  Solder Resist
-  Land

Attention: Matching circuits and component values will be different on the client's design, depending on PCB layout, geometry, etc. It is recommended that the designer leave available slots for a "pi" (or shunt-series-shunt) network. The antenna matching network values you see here are used when antenna is mounted on Johanson's evaluation board.

Need help laying out the antenna, want us to review your antenna design (free!), or would like us to measure and derive the new tuning values of your PCB (fee may apply) go to: <https://www.johansontechnology.com/ask-a-question>

Orderable EVB for evaluation, it comes with a female SMA connector. Go to: <https://www.johansontechnology.com/component/request-a-sample> and ask for p/n 2450AD18A6050-EB1SMA

* Line width should be designed to match 50Ω characteristic impedance, depending on PCB material, thickness, and preferably CPWG (co-planar wave guide) type.

Johanson Technology, Inc. reserves the right to make design changes without notice.
All sales are subject to Johanson Technology, Inc. terms and conditions.



<https://www.johansontechnology.com>

4001 Calle Tecate • Camarillo, CA 93012 • TEL 805.389.1166 FAX 805.389.1821

Ver 1.2

2021 Johanson Technology, Inc. All Rights Reserved

High Frequency Ceramic Solutions

2.4, 5, and 6GHz BT/WiFi6E Mini Antenna, Single-feed, Tri-band, Corner Mount

P/N 2450AD18A6050

Detail Specification: 10/20/2021

Page 3 of 7

Johanson Technology Evaluation Board Mounting Configuration

❖ Test Board-Top View

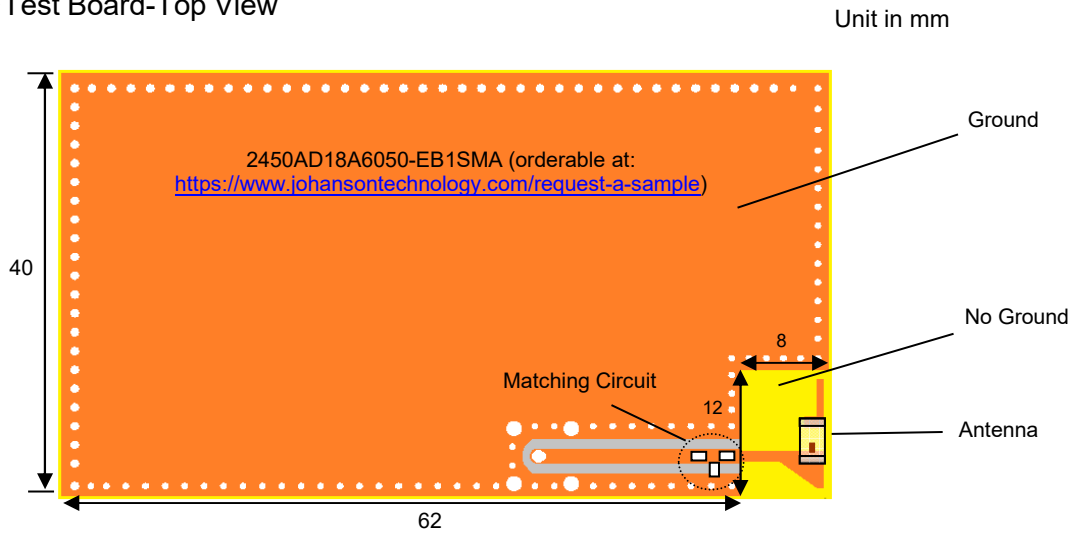

Typical Electrical Characteristics (T=25°C)

Antenna Return Loss with Matching Circuits On Johanson EVB

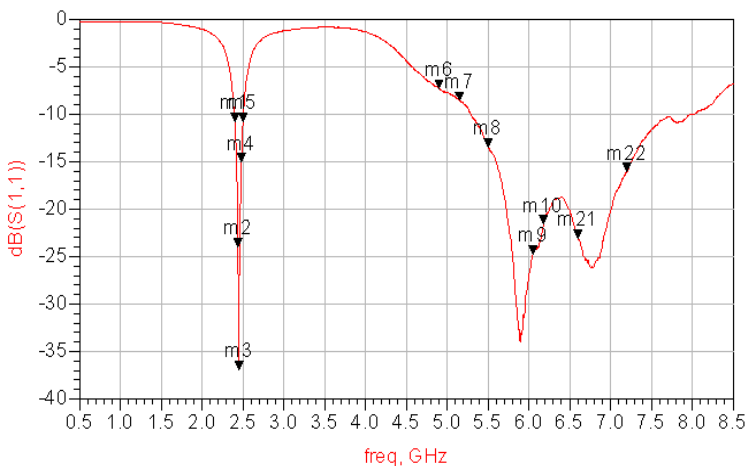

m1	freq=2.400GHz	dB(S(1,1))=-10.756
m2	freq=2.440GHz	dB(S(1,1))=-23.983
m3	freq=2.450GHz	dB(S(1,1))=-36.886
m4	freq=2.480GHz	dB(S(1,1))=-15.047
m5	freq=2.500GHz	dB(S(1,1))=-10.778

m6	freq=4.900GHz	dB(S(1,1))=-7.277
m7	freq=5.150GHz	dB(S(1,1))=-8.522
m8	freq=5.500GHz	dB(S(1,1))=-13.415
m9	freq=6.050GHz	dB(S(1,1))=-24.728
m10	freq=6.175GHz	dB(S(1,1))=-21.581

m21	freq=6.600GHz	dB(S(1,1))=-23.053
m22	freq=7.200GHz	dB(S(1,1))=-16.091

Johanson Technology, Inc. reserves the right to make design changes without notice.

All sales are subject to Johanson Technology, Inc. terms and conditions.



<https://www.johansontechnology.com>

4001 Calle Tecate • Camarillo, CA 93012 • TEL 805.389.1166 FAX 805.389.1821

Ver 1.2

2021 Johanson Technology, Inc. All Rights Reserved

High Frequency Ceramic Solutions

2.4, 5, and 6GHz BT/WiFi6E Mini Antenna, Single-feed, Tri-band, Corner Mount

P/N 2450AD18A6050

Detail Specification: 10/20/2021

Page 4 of 7

Typical Radiation Patterns

❖ Radiation Patterns @ 2.45GHz

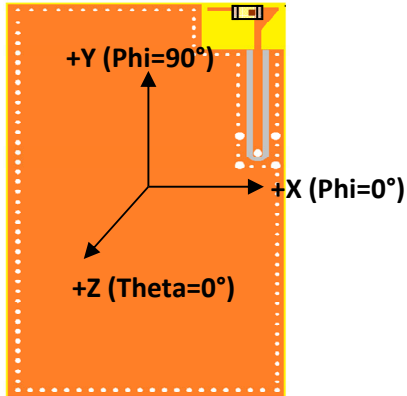

XY-Plane

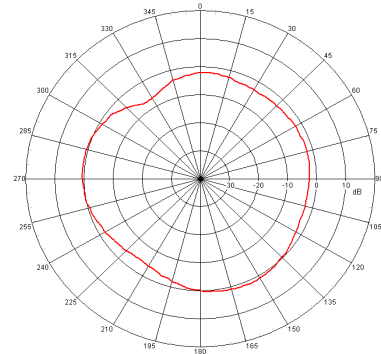

YZ-Plane

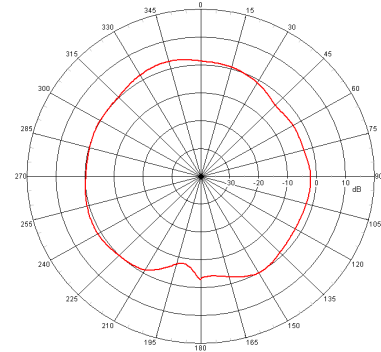

XZ-Plane

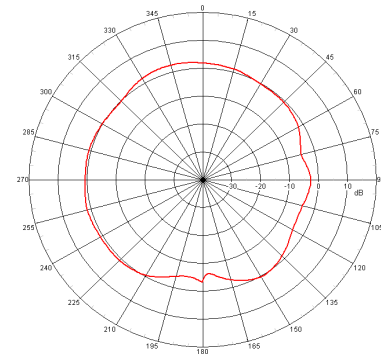

Johanson Technology, Inc. reserves the right to make design changes without notice.

All sales are subject to Johanson Technology, Inc. terms and conditions.



<https://www.johansontechnology.com>

4001 Calle Tecate • Camarillo, CA 93012 • TEL 805.389.1166 FAX 805.389.1821

Ver 1.2

2021 Johanson Technology, Inc. All Rights Reserved

High Frequency Ceramic Solutions

2.4, 5, and 6GHz BT/WiFi6E Mini Antenna, Single-feed, Tri-band, Corner Mount

P/N 2450AD18A6050

Detail Specification: 10/20/2021

Page 5 of 7

Typical Radiation Patterns

❖ Radiation Patterns @ 5.375GHz

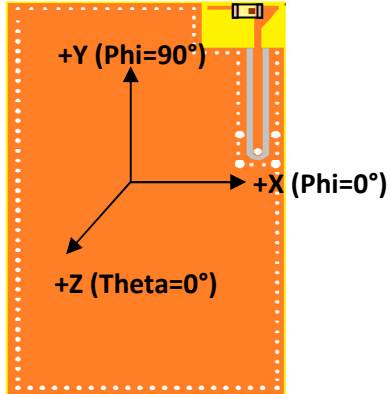

XY-Plane

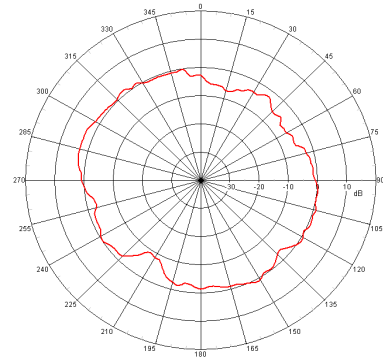

YZ-Plane

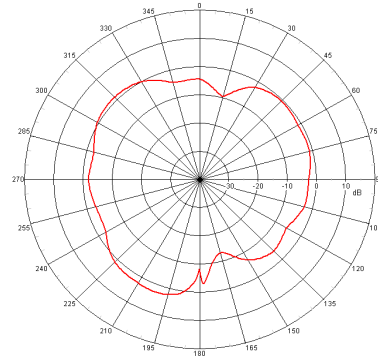

XZ-Plane

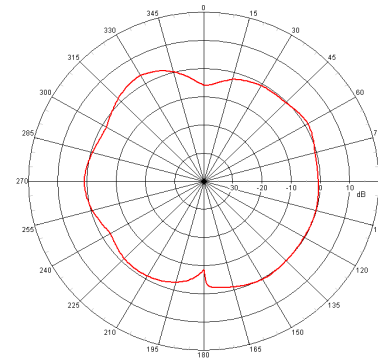

Johanson Technology, Inc. reserves the right to make design changes without notice.

All sales are subject to Johanson Technology, Inc. terms and conditions.



<https://www.johansontechnology.com>

4001 Calle Tecate • Camarillo, CA 93012 • TEL 805.389.1166 FAX 805.389.1821

Ver 1.2

2021 Johanson Technology, Inc. All Rights Reserved

High Frequency Ceramic Solutions

2.4, 5, and 6GHz BT/WiFi6E Mini Antenna, Single-feed, Tri-band, Corner Mount

P/N 2450AD18A6050

Detail Specification: 10/20/2021

Page 6 of 7

Typical Radiation Patterns

❖ Radiation Patterns @ 6.525GHz

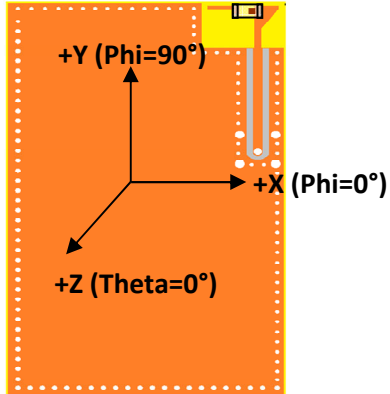

XY-Plane

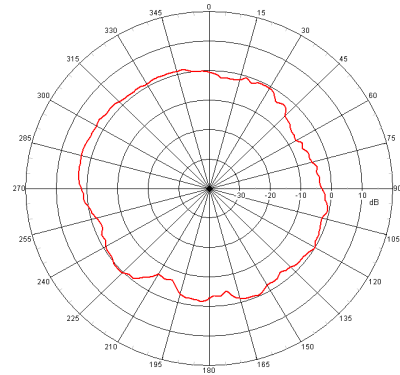

YZ-Plane

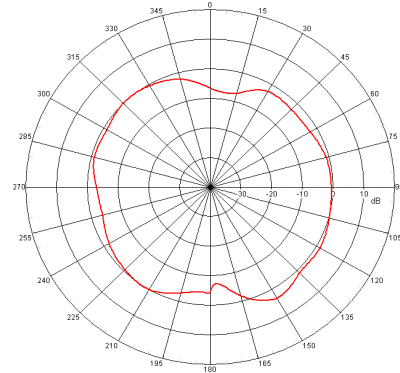

XZ-Plane

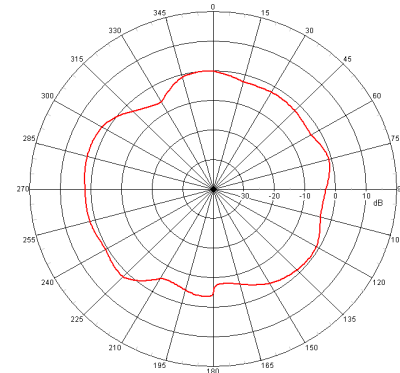

Johanson Technology, Inc. reserves the right to make design changes without notice.

All sales are subject to Johanson Technology, Inc. terms and conditions.



<https://www.johansontechnology.com>

4001 Calle Tecate • Camarillo, CA 93012 • TEL 805.389.1166 FAX 805.389.1821

Ver 1.2

2021 Johanson Technology, Inc. All Rights Reserved

High Frequency Ceramic Solutions

2.4, 5, and 6GHz BT/WiFi6E Mini Antenna, Single-feed, Tri-band, Corner Mount

P/N 2450AD18A6050

Detail Specification: 10/20/2021

Page 7 of 7

Antenna tuning, optimization, and validation services:

<https://www.johansontechnology.com/ipc-antenna-services>

For more antennas and to download measured S-parameters, go to:

<https://www.johansontechnology.com/antennas>

Soldering Information

<https://www.johansontechnology.com/ipcsoldering-profile>

MSL Info

<https://www.johansontechnology.com/msl-rating>

Packaging information

<https://www.johansontechnology.com/tape-reel-packaging>

For layout review contact our Applications Team at:

<https://www.johansontechnology.com/ask-a-question>

RoHS Compliance

<https://www.johansontechnology.com/rohs-compliance>

Recommended Storage Condition and Max Shelf Life

<https://www.johansontechnology.com/recommended-storage-conditions>

Diplexers Page

<https://www.johansontechnology.com/diplexers>

Band Pass Filters Page

<https://www.johansontechnology.com/band-pass-filters>

Johanson Technology, Inc. reserves the right to make design changes without notice.

All sales are subject to Johanson Technology, Inc. terms and conditions.



<https://www.johansontechnology.com>

4001 Calle Tecate • Camarillo, CA 93012 • TEL 805.389.1166 FAX 805.389.1821

Ver 1.2

2021 Johanson Technology, Inc. All Rights Reserved