



**FCC CFR 47 PART 15 SUBPART C**

**TEST REPORT**

**For**

**FM Transmitter**

**Model: MC-111F**

**Trade Name: Action Star Enterprise Co., Ltd.**

Issued to

**Action Star Enterprise Co., Ltd.**  
10F, No. 159, Ta-Tung Rd., Sec. 2, Hsichih City,  
Taipei Hsien, Taiwan R.O.C. 221

Issued by



**Compliance Certification Services Inc.**  
**Hsintien Lab.**  
No. 163-1, Chunghsen Road, Hsintien City  
Taipei Hsien, Taiwan  
**TEL: (02) 2217-0894**  
**FAX: (02) 2217-1029**

---

*Note: This report shall not be reproduced except in full, without the written approval of Compliance Certification Services Inc. This document may be altered or revised by Compliance Certification Services Inc. personnel only, and shall be noted in the revision section of the document.*



**TABLE OF CONTENTS**

**1. TEST RESULT CERTIFICATION ..... 3**

**2. EUT DESCRIPTION ..... 4**

**3. TEST METHODOLOGY ..... 5**

**3.1 EUT CONFIGURATION ..... 5**

**3.2 EUT EXERCISE ..... 5**

**3.3 GENERAL TEST PROCEDURES ..... 5**

**3.4 FCC PART 15.205 RESTRICTED BANDS OF OPERATIONS ..... 6**

**3.5 DESCRIPTION OF TEST MODES ..... 6**

**4. INSTRUMENT CALIBRATION ..... 7**

**5. FACILITIES AND ACCREDITATIONS ..... 7**

**5.1 FACILITIES ..... 7**

**5.2 EQUIPMENT ..... 7**

**5.3 LABORATORY ACCREDITATIONS AND LISTINGS ..... 7**

**5.4 TABLE PF ACCREDITATIONS AND LISTINGS ..... 8**

**6. SETUP OF EQUIPMENT UNDER TEST ..... 9**

**6.1 SETUP CONFIGURATION OF EUT ..... 9**

**6.2 SUPPORT EQUIPMENT ..... 9**

**7. FCC PART 15.239 REQUIREMENTS ..... 10**

**7.1 26 DB BANDWIDTH ..... 10**

**7.2 RADIATED EMISSIONS ..... 13**

**7.3 POWERLINE CONDUCTED EMISSIONS ..... 18**

**APPENDIX I - PHOTOGRAPHS OF TEST SETUP ..... 19**



# 1. TEST RESULT CERTIFICATION

<b>Applicant:</b>	Action Star Enterprise Co., Ltd. 10F, No. 159, Ta-Tung Rd., Sec.2, Hsichih City, Taipei Hsien, Taiwan, R.O.C. 221
<b>Equipment Under Test:</b>	FM Transmitter
<b>Trade Name:</b>	Action Star Enterprise Co., Ltd.
<b>Model:</b>	MC-111F
<b>Model Difference</b>	N/A
<b>Report Number:</b>	61116210-RP1
<b>Date of Test:</b>	December 20, 2006 & December 25, 2006

APPLICABLE STANDARDS	
STANDARD	TEST RESULT
FCC Part 15 Subpart C	No non-compliance noted

The above equipment was tested by Compliance Certification Services Inc. The test data, data evaluation, test procedures, and equipment configurations shown in this report were made in accordance with the procedures given in ANSI C63.4 (2003) and the energy emitted by the sample EUT tested as described in this report is in compliance with conducted and radiated emission limits of FCC Rules Part 15.239.

The test results of this report relate only to the tested sample identified in this report.

Approved by:

Reviewed by:



David Wang  
 Manager of Hsintien Laboratory  
 Compliance Certification Services Inc.



Vince Chiang  
 Assistant Manager of Hsintien Laboratory  
 Compliance Certification Services Inc.



## 2. EUT DESCRIPTION

<b>Product</b>	FM Transmitter
<b>Trade Name</b>	Action Star Enterprise Co., Ltd.
<b>Model</b>	MC-111F
<b>Power Supply</b>	From 12VDC / 24 VDC
<b>Operate Frequency</b>	88.3MHz~107.7MHz
<b>Modulation Technique</b>	FM
<b>Number of Channels</b>	194Channel
<b>Operating Mode</b>	Point-to-Point
<b>Antenna Designation</b>	Fixed Antenna, which is built in EUT
<b>Antenna Type</b>	Integral Loop Antenna

*Note: 1. The product is a Transmitter. This submittal(s) (test report) is intended for*

*FCC ID: RX4MC-111F-U filing to comply with Section 15.239 of the FCC Part 15 Subpart C Rules.*

*2. The composite system (digital device) is compliance with subpart B is authorized under a DOC procedure.*

*3. The lowest channel is 88.3MHz and the highest channel is 107.7MHz. The tuning controls were manually adjusted to verify maximum tuning range.*



### **3. TEST METHODOLOGY**

The tests documented in this report were performed in accordance with ANSI C63.4 and FCC CFR 47 Part 15 Subpart C.

#### **3.1 EUT CONFIGURATION**

The EUT configuration for testing is installed on RF field strength measurement to meet the Commissions requirement and operating in a manner that intends to maximize its emission characteristics in a continuous normal application.

#### **3.2 EUT EXERCISE**

The calibrated antennas used to sample the radiated field strength are mounted on a non-conductive, motorized antenna mast 3 or 10 meters from the leading edge of the turntable.

#### **3.3 GENERAL TEST PROCEDURES**

##### **Conducted Emissions**

The EUT is placed on the turntable, which is 0.8 m above ground plane. According to the requirements in Section 7.1 of ANSI C63.4-2003. Conducted emissions from the EUT measured in the frequency range between 0.15 MHz and 30MHz using CISPR Quasi-Peak detector mode.

##### **Radiated Emissions**

The EUT is a placed on as turntable, which is 0.8 m above ground plane. The turntable shall rotate 360 degrees to determine the position of maximum emission level. EUT is set 3m away from the receiving antenna, which varied from 1m to 4m to find out the highest emission. And also, each emission was to be maximized by changing the polarization of receiving antenna both horizontal and vertical.



### 3.4 FCC PART 15.205 RESTRICTED BANDS OF OPERATIONS

(a) Except as shown in paragraph (d) of this section, only spurious emissions are permitted in any of the frequency bands listed below:

MHz	MHz	MHz	GHz
0.090 - 0.110	16.42 - 16.423	399.9 - 410	4.5 - 5.15
<sup>1</sup> 0.495 - 0.505	16.69475 - 16.69525	608 - 614	5.35 - 5.46
2.1735 - 2.1905	16.80425 - 16.80475	960 - 1240	7.25 - 7.75
4.125 - 4.128	25.5 - 25.67	1300 - 1427	8.025 - 8.5
4.17725 - 4.17775	37.5 - 38.25	1435 - 1626.5	9.0 - 9.2
4.20725 - 4.20775	73 - 74.6	1645.5 - 1646.5	9.3 - 9.5
6.215 - 6.218	74.8 - 75.2	1660 - 1710	10.6 - 12.7
6.26775 - 6.26825	108 - 121.94	1718.8 - 1722.2	13.25 - 13.4
6.31175 - 6.31225	123 - 138	2200 - 2300	14.47 - 14.5
8.291 - 8.294	149.9 - 150.05	2310 - 2390	15.35 - 16.2
8.362 - 8.366	156.52475 - 156.52525	2483.5 - 2500	17.7 - 21.4
8.37625 - 8.38675	156.7 - 156.9	2655 - 2900	22.01 - 23.12
8.41425 - 8.41475	162.0125 - 167.17	3260 - 3267	23.6 - 24.0
12.29 - 12.293	167.72 - 173.2	3332 - 3339	31.2 - 31.8
12.51975 - 12.52025	240 - 285	3345.8 - 3358	36.43 - 36.5
12.57675 - 12.57725	322 - 335.4	3600 - 4400	( <sup>2</sup> )
13.36 - 13.41			

<sup>1</sup> Until February 1, 1999, this restricted band shall be 0.490-0.510 MHz.

<sup>2</sup> Above 38.6

(b) Except as provided in paragraphs (d) and (e), the field strength of emissions appearing within these frequency bands shall not exceed the limits shown in Section 15.209. At frequencies equal to or less than 1000 MHz, compliance with the limits in Section 15.209 shall be demonstrated using measurement instrumentation employing a CISPR quasi-peak detector. Above 1000 MHz, compliance with the emission limits in Section 15.209 shall be demonstrated based on the average value of the measured emissions. The provisions in Section 15.35 apply to these measurements.

### 3.5 DESCRIPTION OF TEST MODES

The EUT has been tested under operating condition and tested in continuous transmitting mode.

1. The following test mode(s) were scanned during the preliminary test:

**Mode(s):**

1. **Audio Mode**
2. **USB Mode**

2. After the preliminary scan, the following test mode was found to produce the highest emission level.

**Mode 2**

Then, the EUT configuration and cable configuration of the above highest emission mode was recorded for all final test items. The iPod played a music MP3 and set the volume to Max.

*(Note: The tuning range was checked by physically adjusting the tuning controls by artificial during test.)*

There are 194 channels on EUT. All 194 channels are pre-tested and choose three channels, low (88.3MHz), middle (98.3MHz), high (107.7MHz), for final test.



## 4. INSTRUMENT CALIBRATION

The measuring equipment, which was utilized in performing the tests documented herein, has been calibrated in accordance with the manufacturer's recommendations for utilizing calibration equipment, which is traceable to recognized national standards

## 5. FACILITIES AND ACCREDITATIONS

### 5.1 FACILITIES

All measurement facilities used to collect the measurement data are located at

- No. 81-1, Lane 210, Pa-de 2nd Road, Luchu Hsiang, Taoyuan Hsien, Taiwan
- No. 163-1, Chunghsen Road, Hsintien City, Taipei Hsien, Taiwan

The sites are constructed in conformance with the requirements of ANSI C63.7, ANSI C63.4 (2003) and CISPR Publication 22.

### 5.2 EQUIPMENT

Radiated emissions are measured with one or more of the following types of linearly polarized antennas: tuned dipole, biconical, log periodic, bi-log, and/or ridged waveguide, horn. Spectrum analyzers with preselectors and quasi-peak detectors are used to perform radiated measurements.

Conducted emissions are measured with Line Impedance Stabilization Networks and EMI Test Receivers.







Calibrated wideband preamplifiers, coaxial cables, and coaxial attenuators are also used for making measurements.

All receiving equipment conforms to CISPR Publication 16-1, "Radio Interference Measuring Apparatus and Measurement Methods."

### 5.3 LABORATORY ACCREDITATIONS AND LISTINGS

The test facilities used to perform Electromagnetic compatibility tests are registered or accredited by the organizations listed in the following table which includes the recognized scope specifically.

## 5.4 TABLE PF ACCREDITATIONS AND LISTINGS

Country	Agency	Scope of Accreditation	Logo
USA	A2LA	CFR 47, FCC Part 15/18; AS/NZS 3548; VCCI V3; CNS 13438; CNS 13439; CNS 13783; CNS 14115; CISPR 11/EN 55011; CISPR 14-1/EN 55014-1; CISPR 15/EN 55015; CISPR 22/EN 55022; EN 50081-1/EN 61000-6-3; EN 50082-1/EN 61000-6-4; IEC/EN 61000-4-2, IEC/EN 61000-4-3, IEC/EN 61000-4-4, IEC/EN 61000-4-5, IEC/EN 61000-4-6, IEC/EN 61000-4-8, IEC/EN 61000-4-11, IEC/EN 61000-3-2, IEC/EN 61000-3-3; CISPR 24/EN 55024; CISPR 14-2/EN 55014-2; EN 50081-2/EN 61000-6-1; EN 50082-2/EN 61000-6-2.	 ACCREDITED No. 0824-01
USA	FCC	3/10 meter Open Area Test Sites to perform FCC Part 15/18 measurements	 250366
Japan	VCCI	3/10 meter Open Area Test Sites and Line Conducted Test Room to perform conducted/radiated measurements	 R-2265/1630~4 C-1882/ 2146
Norway	NEMKO	EN 50081-1/2, EN 50082-1/2, IEC 61000-6-1/2/3/4, EN 50091-2, EN 50130-4, EN 55011, EN 55013, EN 55014-1/2, EN 55015, EN 55022, EN 55024, EN 61000-3-2/3, EN 61326-1, IEC 61000-4-2/3/4/5/6/8/11, Cisprr 16-1/2/3/4	 ELA 103
Taiwan	CNLA	47 CFR FCC Part 15 Subpart B, EN 61000-3-2, EN 61000-3-3, CNS 13439, CNS 13783-1, CNS 13438, AS/NZS 3548, VCCI, CNS 13022-1/2/3, EN 55022, EN 55013, EN 55014-1, EN 61000-4-2/3/4/5/6/8/11, ENV 50204, ENV 50141, ENV 50142	 Testing Laboratory 1108
Taiwan	BSMI	CNS 13438, CNS 13783-1, CNS 13439	 SL2-IN-E-0005 SL2-A1-E-0005 SL2-R1-E-0005 SL2-R2-E-0005

**Note:** No part of this report may be used to claim or imply product endorsement by CNLA, A2LA or other government agency.



## 6. SETUP OF EQUIPMENT UNDER TEST

### 6.1 SETUP CONFIGURATION OF EUT

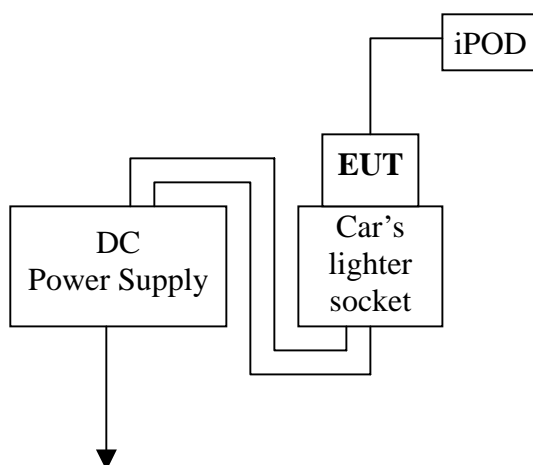

**Remark:** Either from USB port or from audio port, but not both.

### 6.2 SUPPORT EQUIPMENT

Device Type	Model	Series No.	FCC ID	Brand	Data Cable	Power Cord
DC Power Supply	GPC-3030D	N/A	N/A	GW	Unshielded, 0.6m X2	Unshielded, 0.3m
iPOD	A1112	N/A	R33057	Apple	N/A	N/A
Car's lighter socket	N/A	N/A	N/A	N/A	Unshielded, 0.65m	N/A

**Notes:**

1. All the equipment/cables were placed in the worst-case configuration to maximize the emission during the test.
2. Grounding was established in accordance with the manufacturer's requirements and conditions for the intended use.

## 7. FCC PART 15.239 REQUIREMENTS

### 7.1 26 dB BANDWIDTH

#### LIMIT

N/A

#### MEASUREMENT EQUIPMENT USED

Open Area Test Site: # K

EQUIPMENT TYPE	MFR	MODEL NUMBER	SERIAL NUMBER	CAL. DUE
SITE NSA	CCS	K Site	N/A	09/30/2007
MEASURE RECEIVER	SCHAFFNER	SCR3501	412	05/18/2007
SPECTRUM ANALYZER	ADVANTEST	R3132	120900029	No Calibration Required
ANTENNA	SCHAFFNER	CBL 6112B	2846	05/26/2007
PRE-AMPLIFIER	SCHAFFNER	CPA9231A	3639	10/10/2007
CABLE	SUHNER	RG 214	N-TYPE #K2	02/17/2007
THERMO-HYGRO METER	TFA	N/A	NO.4	02/08/2007

*Note: Each piece of equipment is scheduled for calibration once a year.*

#### Test Configuration

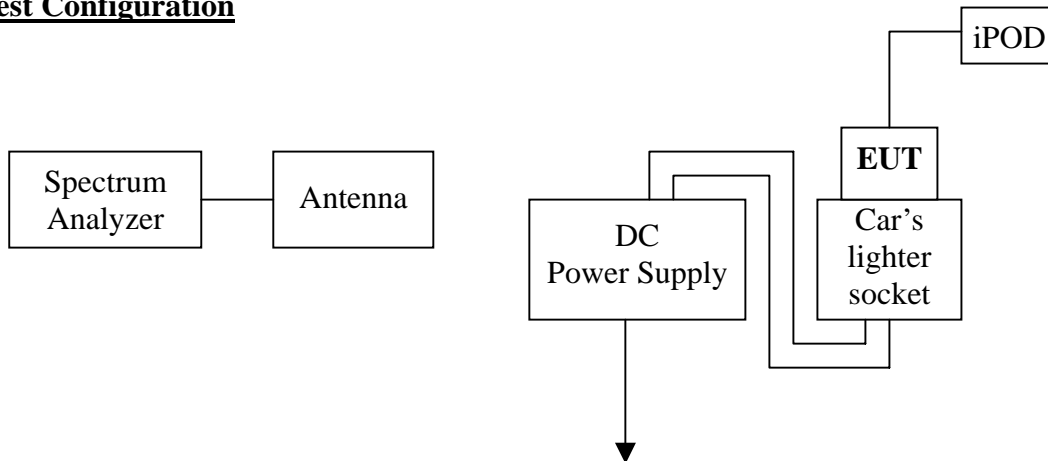

#### TEST PROCEDURE

- Place the EUT on the table and set it in the transmitting mode.  
(**Note:** The iPod is playing rock song and the iPod is adjusted to maximum volume.)
- Remove the antenna from the EUT and then connect a low loss RF cable from the antenna port to the spectrum analyzer.
- Set the spectrum analyzer as RBW=10kHz, VBW = RBW, Span = 200kHz, Sweep = auto.
- Mark the peak frequency and 26dB (upper and lower) frequency.
- Repeat until all the rest channels are investigated.



## TEST RESULTS

*No non-compliance noted*

### Test Data

Channel	Frequency (MHz)	Bandwidth (kHz)
1	88.3	101.0
2	98.3	103.5
3	107.7	103.0

### Test Date Plot

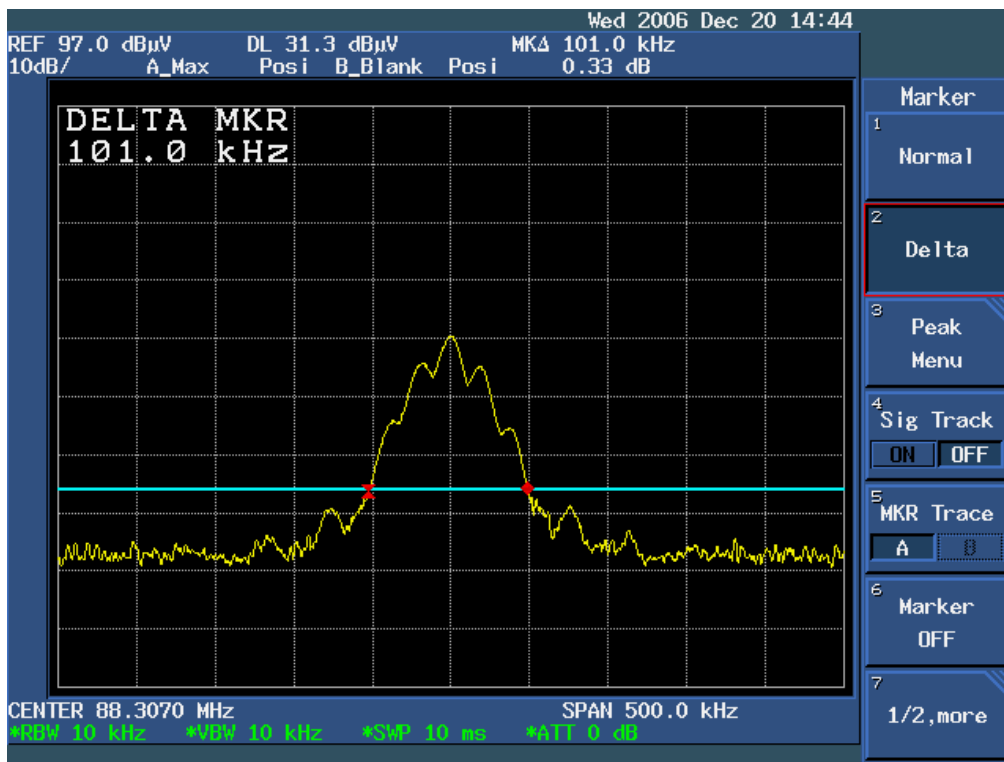

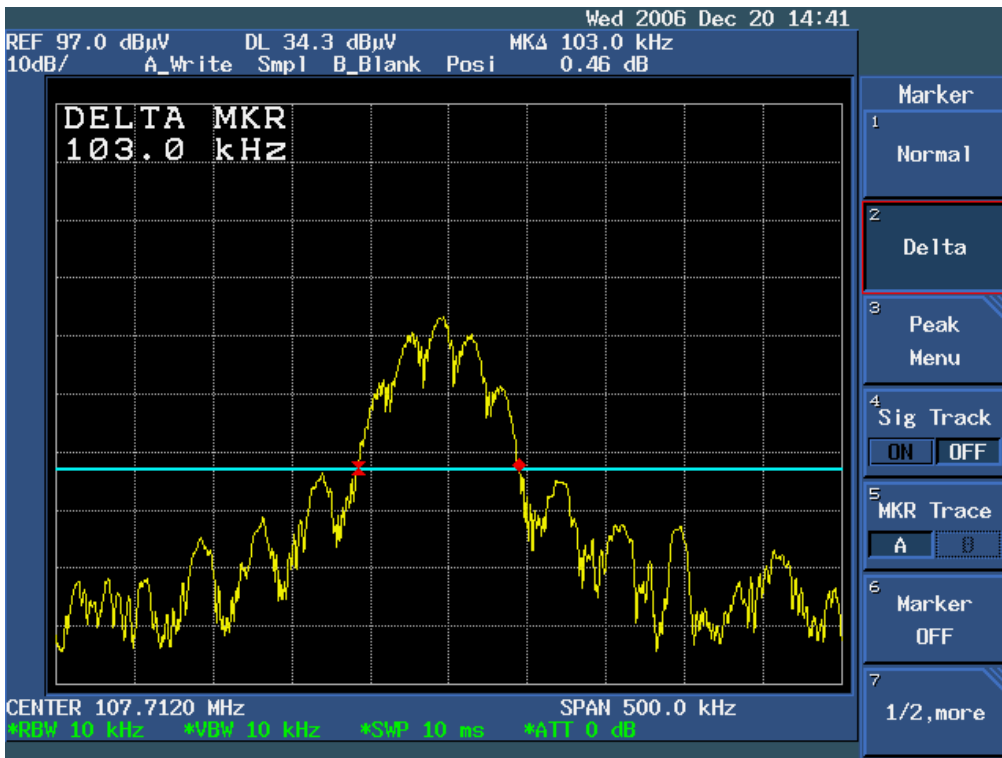
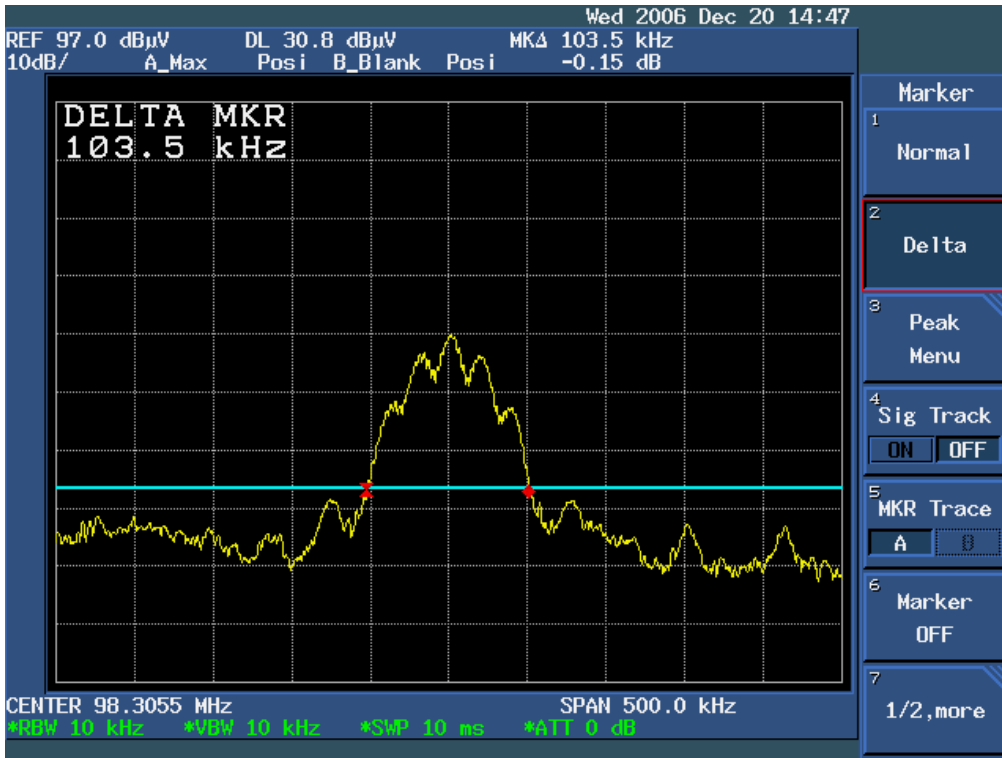



## 7.2 RADIATED EMISSIONS

### LIMIT

1. The field strength of any emission within this band (section 15.239 frequency between 88 MHz –108 MHz) shall not exceed 250 microvolts /meter at 3 meters. (48dBμV/m at 3m) The emission limit in this paragraph is based on measurement instrumentation employing an average detector. The provisions in section 15.35 for limiting peak emissions apply.

The field strength of any emissions which appear outside of this band shall not exceed the general radiated emission limits in section 15.209(Intentional Radiators general limit), as below.

Frequency (MHz)	Field Strength (mV/m)	Measurement Distance (m)
1.705-30	30	30
30-88	100*	3
88-216	150*	3
216-960	200*	3
Above 960	500	3

*Note: Except as provided in paragraph (g), fundamental emissions from intentional radiators operating under this Section shall not be located in the frequency bands 54-72 MHz, 76-88 MHz, 174-216 MHz or 470-806 MHz. However, operation within these frequency bands is permitted under other sections of this Part, e.g., Sections 15.231 and 15.241.*

2. In the above emission table, the tighter limit applies at the band edges.

Frequency (Hz)	Field Strength (μV/m at 3-meter)	Field Strength (dBμV/m at 3-meter)
1.705-30	30	69.54
30-88	100	40
88-216	150	43.5
216-960	200	46
Above 960	500	54

**MEASUREMENT EQUIPMENT USED**

**Open Area Test Site: # K**

EQUIPMENT TYPE	MFR	MODEL NUMBER	SERIAL NUMBER	CAL. DUE
SITE NSA	CCS	K Site	N/A	09/30/2007
MEASURE RECEIVER	SCHAFFNER	SCR3501	412	05/18/2007
SPECTRUM ANALYZER	ADVANTEST	R3132	120900029	No Calibration Required
ANTENNA	SCHAFFNER	CBL 6112B	2846	05/26/2007
PRE-AMPLIFIER	SCHAFFNER	CPA9231A	3639	10/10/2007
CABLE	SUHNER	RG 214	N-TYPE #K2	02/17/2007
THERMO-HYGRO METER	TFA	N/A	NO.4	02/08/2007

*Note: The measurement uncertainty is less than +/- 3.36dB, which is evaluated as per the NAMAS NIS 81 and CISPR/A/291/CD*

**Test Configuration**

**For Frequencies Below 1 GHz**

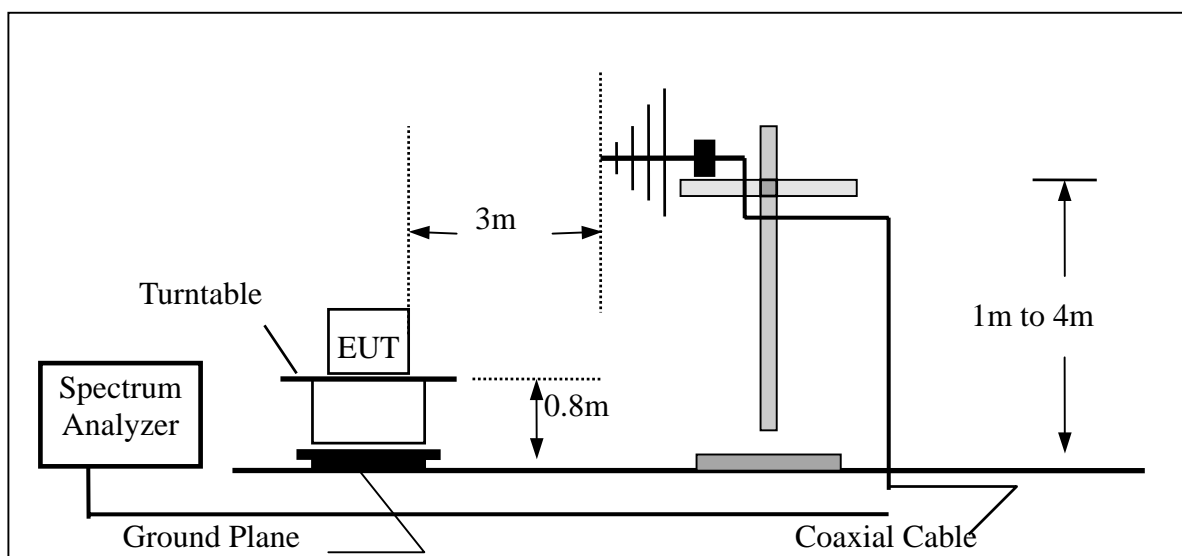



## **TEST PROCEDURE**

1. The EUT was placed on a turntable, which was 0.8m above ground plane.
2. The turntable was rotated for 360 degrees to determine the position of maximum emission level.
3. EUT was set at 3m away from the receiving antenna, which was varied from 1m to 4m to find out the highest emissions.
4. Maximum procedure was performed on the six highest emissions to ensure EUT compliance.
5. And also, each emission was maximized by changing the polarization of receiving antenna, both horizontal and vertical.
6. Repeated above procedures until the measurements for all frequencies are completed.



**TEST RESULTS**

**Test Data**

We have tested two modes (X, Y). Below is the worst mode (X axis) for final test.

**Frequencies for 88MHz - 108MHz:**

Frequency (MHz)	Reading (dBUV)	Correction Factor (dBUV/m)	FS (dBUV/m)	Limit (dBUV/m)	Margin (dB)	Detector Mode (P/A)	Ant.Pol. H/V
88.310	39.90	-1.26	38.64	68.00	-29.36	P	V
88.310	---	---	---	48.00	---	A	V
98.298	39.20	-2.09	37.11	68.00	-30.89	P	V
98.298	---	---	---	48.00	---	A	V
107.740	33.10	-6.50	26.60	68.00	-41.40	P	V
107.740	---	---	---	48.00	---	A	V
88.296	35.90	-0.67	35.23	68.00	-32.77	P	H
88.296	---	---	---	48.00	---	A	H
98.310	37.80	-7.62	30.18	68.00	-37.82	P	H
98.310	---	---	---	48.00	---	A	H
107.695	41.70	-8.82	32.88	68.00	-35.12	P	H
107.695	---	---	---	48.00	---	A	H

***Remark:***

- 1. Measuring frequencies from 88MHz to the 108MHz.*
- 2. Datas of measurement within this frequency range shown “ -- ” in the table above means the reading of emissions are attenuated more than 20dB below the permissible limits or the field strength is too small to be measured.*
- 3. The IF bandwidth of SPA between 88MHz to 108MHz was 10kHz.*
- 4. Ant. Pol = Antenna Polarization / FS = Field strength*



**Frequencies for 30MHz-1GHz:**

Frequency (MHz)	Reading (dBuV)	Correction Factor (dBuV/m)	FS (dBuV/m)	Limit (dBuV/m)	Margin (dB)	Detector Mode (P/A)	Ant.Pol. H/V
59.980	37.80	-20.14	17.66	40.00	-22.34	Q	V
86.420	40.10	-17.35	22.75	40.00	-17.25	Q	V
120.070	34.80	-13.78	21.02	43.50	-22.48	Q	V
130.210	35.10	-13.68	21.42	43.50	-22.08	Q	V
176.340	37.50	-14.59	22.91	43.50	-20.59	Q	V
444.490	30.20	-4.91	25.29	46.00	-20.71	Q	V
46.490	40.80	-16.35	24.45	40.00	-15.55	Q	H
57.280	45.80	-19.61	26.19	40.00	-13.81	Q	H
176.400	41.70	-14.59	27.11	43.50	-16.39	Q	H
240.140	33.70	-11.55	22.15	46.00	-23.85	Q	H
250.020	33.70	-10.83	22.87	46.00	-23.13	Q	H
529.700	32.20	-2.46	29.74	46.00	-16.26	Q	H

**Remark:**

1. *Measuring frequencies from 30 MHz to the 1GHz.*
2. *Radiated emissions measured in frequency range from 30 MHz to 1000MHz were made with an instrument using Peak/AV detector mode.*
3. *Datas of measurement within this frequency range shown "--" in the table above means the reading of emissions are attenuated more than 20dB below the permissible limits or the field strength is too small to be measured..*
4. *The IF bandwidth of SPA between 30MHz to 1GHz was 100kHz.*
5. *Ant. Pol = Antenna Polarization / FS = Field strength*



### **7.3 POWERLINE CONDUCTED EMISSIONS**

Not applicable, as it's power was supplied from DC Power Supply.

## 8. APPENDIX I - PHOTOGRAPHS OF TEST SETUP

