

## FCC Test Report

**Report No.:** RF191230C15

**FCC ID:** RX3-WBU053LGA

**Test Model:** WBU053-LGA

**Received Date:** Dec. 30, 2019

**Test Date:** Feb. 07 ~ Feb. 14, 2020

**Issued Date:** Feb. 21, 2020

**Applicant:** Hon Hai Precision Industry Co., Ltd.

**Address:** No.151, Sec. 1, Nankan Rd., Lujhu Dist., Taoyuan County 33859, Taiwan  
(R.O.C.)

**Issued By:** Bureau Veritas Consumer Products Services (H.K.) Ltd., Taoyuan Branch  
Lin Kou Laboratories

**Lab Address:** No. 47-2, 14th Ling, Chia Pau Vil., Lin Kou Dist., New Taipei City, Taiwan

**Test Location (1):** No.19, Hwa Ya 2nd Rd., Wen Hwa Vil., Kwei Shan Dist., Taoyuan City  
33383, Taiwan

**Test Location (2):** B2F., No.215, Sec. 3, Beixin Rd., Xindian Dist., New Taipei City 231,  
Taiwan

**FCC Registration /** 788550 / TW0003

**Designation Number:** 427177 / TW0011



This report is for your exclusive use. Any copying or replication of this report to or for any other person or entity, or use of our name or trademark, is permitted only with our prior written permission. This report sets forth our findings solely with respect to the test samples identified herein. The results set forth in this report are not indicative or representative of the quality or characteristics of the lot from which a test sample was taken or any similar or identical product unless specifically and expressly noted. Our report includes all of the tests requested by you and the results thereof based upon the information that you provided to us. You have 60 days from date of issuance of this report to notify us of any material error or omission caused by our negligence, provided, however, that such notice shall be in writing and shall specifically address the issue you wish to raise. A failure to raise such issue within the prescribed time shall constitute your unqualified acceptance of the completeness of this report, the tests conducted and the correctness of the report contents. Unless specific mention, the uncertainty of measurement has been explicitly taken into account to declare the compliance or non-compliance to the specification. The report must not be used by the client to claim product certification, approval, or endorsement by TAF or any government agencies.

## Table of Contents

<b>Release Control Record</b> .....	<b>4</b>
<b>1 Certificate of Conformity</b> .....	<b>5</b>
<b>2 Summary of Test Results</b> .....	<b>6</b>
2.1 Measurement Uncertainty .....	6
2.2 Modification Record .....	6
<b>3 General Information</b> .....	<b>7</b>
3.1 General Description of EUT .....	7
3.2 Description of Test Modes .....	8
3.2.1 Test Mode Applicability and Tested Channel Detail .....	9
3.3 Duty Cycle of Test Signal .....	11
3.4 Description of Support Units .....	12
3.4.1 Configuration of System under Test .....	12
3.5 General Description of Applied Standards and References .....	12
<b>4 Test Types and Results</b> .....	<b>13</b>
4.1 Radiated Emission and Bandedge Measurement .....	13
4.1.1 Limits of Radiated Emission and Bandedge Measurement .....	13
4.1.2 Test Instruments .....	14
4.1.3 Test Procedures .....	15
4.1.4 Deviation from Test Standard .....	16
4.1.5 Test Set Up .....	16
4.1.6 EUT Operating Conditions .....	17
4.1.7 Test Results .....	18
4.2 6 dB Bandwidth Measurement .....	32
4.2.1 Limits of 6 dB Bandwidth Measurement .....	32
4.2.2 Test Setup .....	32
4.2.3 Test Instruments .....	32
4.2.4 Test Procedure .....	32
4.2.5 Deviation from Test Standard .....	32
4.2.6 EUT Operating Conditions .....	32
4.2.7 Test Results .....	33
4.3 Occupied Bandwidth Measurement .....	35
4.3.1 Test Setup .....	35
4.3.2 Test Instruments .....	35
4.3.3 Test Procedure .....	35
4.3.4 Deviation from Test Standard .....	35
4.3.5 EUT Operating Conditions .....	35
4.3.6 Test Results .....	36
4.4 Conducted Output Power Measurement .....	38
4.4.1 Limits of Conducted Output Power Measurement .....	38
4.4.2 Test Setup .....	38
4.4.3 Test Instruments .....	38
4.4.4 Test Procedures .....	38
4.4.5 Deviation from Test Standard .....	38
4.4.6 EUT Operating Conditions .....	38
4.4.7 Test Results .....	39
4.5 Power Spectral Density Measurement .....	41
4.5.1 Limits of Power Spectral Density Measurement .....	41
4.5.2 Test Setup .....	41
4.5.3 Test Instruments .....	41
4.5.4 Test Procedure .....	41
4.5.5 Deviation from Test Standard .....	41
4.5.6 EUT Operating Condition .....	41
4.5.7 Test Results .....	42

4.6	Conducted Out of Band Emission Measurement .....	45
4.6.1	Limits of Conducted Out of Band Emission Measurement.....	45
4.6.2	Test Setup.....	45
4.6.3	Test Instruments .....	45
4.6.4	Test Procedure .....	45
4.6.5	Deviation from Test Standard .....	45
4.6.6	EUT Operating Condition .....	45
4.6.7	Test Results .....	46
<b>5</b>	<b>Pictures of Test Arrangements.....</b>	<b>62</b>
	<b>Appendix – Information of the Testing Laboratories .....</b>	<b>63</b>

### Release Control Record

Issue No.	Description	Date Issued
RF191230C15	Original Release	Feb. 21, 2020

## 1 Certificate of Conformity

**Product:** Wireless Module  
**Brand:** Foxconn  
**Test Model:** WBU053-LGA  
**Sample Status:** Engineering Sample  
**Applicant:** Hon Hai Precision Industry Co., Ltd.  
**Test Date:** Feb. 07 ~ Feb. 14, 2020  
**Standards:** 47 CFR FCC Part 15, Subpart C (Section 15.247)  
ANSI C63.10:2013

The above equipment has been tested by **Bureau Veritas Consumer Products Services (H.K.) Ltd., Taoyuan Branch**, and found compliance with the requirement of the above standards. The test record, data evaluation & Equipment Under Test (EUT) configurations represented herein are true and accurate accounts of the measurements of the sample's RF characteristics under the conditions specified in this report.

*Lena Wang*  
**Prepared by :** \_\_\_\_\_, **Date:** Feb. 21, 2020  
Lena Wang / Specialist

*Dylan Chiou*  
**Approved by :** \_\_\_\_\_, **Date:** Feb. 21, 2020  
Dylan Chiou / Senior Project Engineer

## 2 Summary of Test Results

47 CFR FCC Part 15, Subpart C (Section 15.247)			
FCC Clause	Test Item	Result	Remarks
15.207	AC Power Conducted Emission	N/A	Without AC power port of the EUT
15.205 / 15.209 / 15.247(d)	Radiated Emissions and Band Edge Measurement	Pass	Meet the requirement of limit. Minimum passing margin is -1.29 dB at 2483.5 MHz.
15.247(d)	Antenna Port Emission	Pass	Meet the requirement of limit.
15.247(a)(2)	6 dB Bandwidth	Pass	Meet the requirement of limit.
---	Occupied Bandwidth Measurement	Pass	Reference only
15.247(b)	Conducted power	Pass	Meet the requirement of limit.
15.247(e)	Power Spectral Density	Pass	Meet the requirement of limit.
15.203	Antenna Requirement	Pass	Antenna connector is i-pex(MHF) not a standard connector.

Note: Determining compliance based on the results of the compliance measurement, not taking into account measurement instrumentation uncertainty.

### 2.1 Measurement Uncertainty

Where relevant, the following measurement uncertainty levels have been estimated for tests performed on the EUT as specified in CISPR 16-4-2:

Measurement	Frequency	Expanded Uncertainty (k=2) ( $\pm$ )
Conducted Emissions at mains ports	150 kHz ~ 30 MHz	2.79 dB
Radiated Emissions up to 1 GHz	9 kHz ~ 30 MHz	3.04 dB
	30 MHz ~ 200 MHz	2.0153 dB
	200 MHz ~ 1000 MHz	2.0224 dB
Radiated Emissions above 1 GHz	1 GHz ~ 18 GHz	1.0121 dB
	18 GHz ~ 40 GHz	1.1508 dB

### 2.2 Modification Record

There were no modifications required for compliance.

### 3 General Information

#### 3.1 General Description of EUT

<b>Product</b>	Wireless Module
<b>Brand</b>	Foxconn
<b>Test Model</b>	WBU053-LGA
<b>Status of EUT</b>	Engineering Sample
<b>Power Supply Rating</b>	3.0 ~3.6 Vdc
<b>Modulation Type</b>	CCK, DQPSK, DBPSK for DSSS 64QAM, 16QAM, QPSK, BPSK for OFDM
<b>Modulation Technology</b>	DSSS, OFDM
<b>Transfer Rate</b>	802.11b: 11.0 / 5.5 / 2.0 / 1.0 Mbps 802.11g: 54.0 / 48.0 / 36.0 / 24.0 / 18.0 / 12.0 / 9.0 / 6.0 Mbps 802.11n: up to 300 Mbps
<b>Operating Frequency</b>	2412 ~ 2462 MHz
<b>Number of Channel</b>	11 for 802.11b, 802.11g, 802.11n (HT20) 7 for 802.11n (HT40)
<b>Output Power</b>	216.018 mW
<b>Antenna Type</b>	Refer to note as below
<b>Antenna Connector</b>	N/A
<b>Accessory Device</b>	N/A
<b>Data Cable Supplied</b>	N/A

Note:

- The EUT incorporates a MIMO function. Physically, the EUT provides two completed transmitters and two receivers.

Modulation Mode	Tx Function
802.11b	2TX
802.11g	2TX
802.11n (HT20)	2TX
802.11n (HT40)	2TX

- The antenna information is listed as below.

WLAN Antenna							
Ant. Type	Parts Number	Antenna Gain (dBi)					
		2400 MHz	2450 MHz	2500 MHz	5150 MHz	5500 MHz	5850 MHz
PIFA	790128B00-600-G	-0.58	1.12	1.78	-1.30	0.07	-0.78
	790128C00-600-G	1.48	3.16	2.05	1.11	2.56	1.56
	79012AL00-600-G	1.19	1.63	1.97	2.56	-0.37	-0.11

\* For 2.4G and 5G Band 2, 3, 4 : during testing to set Chain 0 and Chain 1 are Part # 790128C00-600-G.  
 \* For 5G Band 1 : during testing to set Chain 0 is Part # 790128C00-600-G and Chain 1 is Part # 79012AL00-600-G.  
 \* Only the antenna which has the maximum gain were chosen as a representative for the final test.

- The above EUT information is declared by manufacturer and for more detailed features description, please refers to the manufacturer's specifications or user's manual.

### 3.2 Description of Test Modes

11 channels are provided for 802.11b, 802.11g and 802.11n (HT20):

Channel	Frequency (MHz)	Channel	Frequency (MHz)
1	2412	7	2442
2	2417	8	2447
3	2422	9	2452
4	2427	10	2457
5	2432	11	2462
6	2437		

7 channels are provided for 802.11n (HT40):

Channel	Frequency (MHz)	Channel	Frequency (MHz)
3	2422	7	2442
4	2427	8	2447
5	2432	9	2452
6	2437		



### 3.2.1 Test Mode Applicability and Tested Channel Detail

EUT Configure Mode	Applicable To				Description
	RE≥1G	RE<1G	PLC	APCM	
-	√	√	-	√	-

Where **RE≥1G**: Radiated Emission above 1 GHz      **RE<1G**: Radiated Emission below 1 GHz  
**PLC**: Power Line Conducted Emission      **APCM**: Antenna Port Conducted Measurement

**NOTE:** The EUT had been pre-tested on the positioned of each 3 axis. The worst case was found when positioned on **X-plane**.  
**NOTE:** "-" means no effect.

#### **Radiated Emission Test (Above 1 GHz):**

- Pre-Scan has been conducted to determine the worst-case mode from all possible combinations between available modulations, data rates and antenna ports (if EUT with antenna diversity architecture).
- Following channel(s) was (were) selected for the final test as listed below.

EUT Configure Mode	Mode	Available Channel	Tested Channel	Modulation Technology	Modulation Type	Data Rate (Mbps)
-	802.11b	1 to 11	1, 6, 11	DSSS	DBPSK	1.0
-	802.11g	1 to 11	1, 6, 11	OFDM	BPSK	6.0
-	802.11n (HT20)	1 to 11	1, 6, 11	OFDM	BPSK	6.5
-	802.11n (HT40)	3 to 9	3, 6, 9	OFDM	BPSK	13.5

#### **Radiated Emission Test (Below 1 GHz):**

- Pre-Scan has been conducted to determine the worst-case mode from all possible combinations between available modulations, data rates and antenna ports (if EUT with antenna diversity architecture).
- Following channel(s) was (were) selected for the final test as listed below.

EUT Configure Mode	Mode	Available Channel	Tested Channel	Modulation Technology	Modulation Type	Data Rate (Mbps)
-	802.11g	1 to 11	11	OFDM	BPSK	6.0

#### **Bandedge Measurement:**

- Pre-Scan has been conducted to determine the worst-case mode from all possible combinations between available modulations, data rates and antenna ports (if EUT with antenna diversity architecture).
- Following channel(s) was (were) selected for the final test as listed below.

EUT Configure Mode	Mode	Available Channel	Tested Channel	Modulation Technology	Modulation Type	Data Rate (Mbps)
-	802.11b	1 to 11	1, 11	DSSS	DBPSK	1.0
-	802.11g	1 to 11	1, 11	OFDM	BPSK	6.0
-	802.11n (HT20)	1 to 11	1, 11	OFDM	BPSK	6.5
-	802.11n (HT40)	3 to 9	3, 9	OFDM	BPSK	13.5

### Antenna Port Conducted Measurement:

- This item includes all test value of each mode, but only includes spectrum plot of worst value of each mode.
- Pre-Scan has been conducted to determine the worst-case mode from all possible combinations between available modulations, data rates and antenna ports (if EUT with antenna diversity architecture).
- Following channel(s) was (were) selected for the final test as listed below.

EUT Configure Mode	Mode	Available Channel	Tested Channel	Modulation Technology	Modulation Type	Data Rate (Mbps)
-	802.11b	1 to 11	1, 6, 11	DSSS	DBPSK	1.0
-	802.11g	1 to 11	1, 6, 11	OFDM	BPSK	6.0
-	802.11n (HT20)	1 to 11	1, 6, 11	OFDM	BPSK	6.5
-	802.11n (HT40)	3 to 9	3, 6, 9	OFDM	BPSK	13.5

### Test Condition:

Applicable To	Environmental Conditions	Input Power	Tested by
RE $\geq$ 1G	25 deg. C, 65 % RH	120 Vac, 60 Hz	Harry Hsueh, Karl Lee
RE $<$ 1G	25 deg. C, 65 % RH	120 Vac, 60 Hz	Harry Hsueh
APCM	25 deg. C, 65 % RH	3.3 Vdc	Gavin Wu

### 3.3 Duty Cycle of Test Signal

Duty cycle of test signal is  $\geq 98\%$ , duty factor is not required.

Duty cycle of test signal is  $< 98\%$ , duty factor shall be considered.

**802.11b:** Duty cycle =  $8.4/8.438 = 0.995$

**802.11g:** Duty cycle =  $1.384/1.424 = 0.972$ , Duty factor =  $10 * \log(1/0.972) = 0.12$

**802.11n (HT20):** Duty cycle =  $1.293/1.338 = 0.966$ , Duty factor =  $10 * \log(1/0.966) = 0.15$

**802.11n (HT40):** Duty cycle =  $0.642/0.697 = 0.921$ , Duty factor =  $10 * \log(1/0.921) = 0.36$



### 3.4 Description of Support Units

The EUT has been tested as an independent unit together with other necessary accessories or support units. The following support units or accessories were used to form a representative test configuration during the tests.

No.	Product	Brand	Model No.	Serial No.	FCC ID
1.	DC Power Supply	Topward	3303D	803136	N/A
2.	Notebook	DELL	E6420	D3T96R1	N/A

Note:

1. All power cords of the above support units are non-shielded (1.8m).
2. Items 2 acted as communication partners to transfer data.

#### 3.4.1 Configuration of System under Test

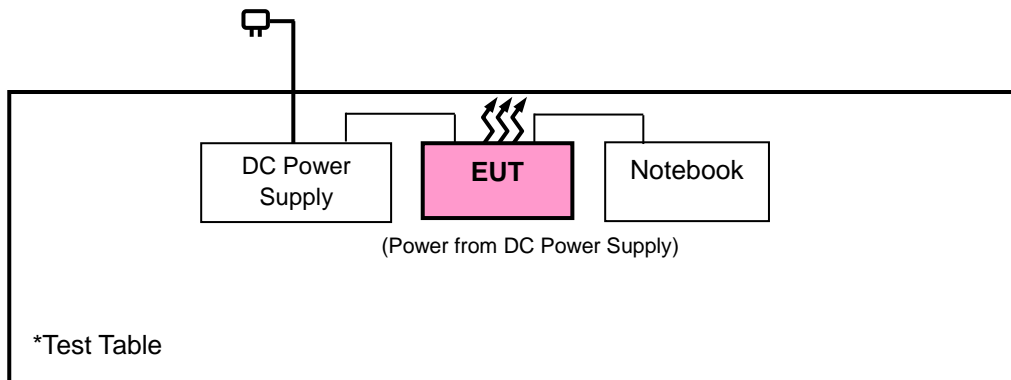

### 3.5 General Description of Applied Standards and References

The EUT is a RF Product. According to the specifications of the manufacturer, it must comply with the requirements of the following standards and references:

#### Test Standard:

##### FCC Part 15, Subpart C (15.247)

ANSI C63.10-2013

All test items have been performed and recorded as per the above standards.

#### References Test Guidance:

##### KDB 558074 D01 Meas Guidance v05r02

##### KDB 662911 D01 Multiple Transmitter Output v02r01

All test items have been performed as a reference to the above KDB test guidance.

## 4 Test Types and Results

### 4.1 Radiated Emission and Bandedge Measurement

#### 4.1.1 Limits of Radiated Emission and Bandedge Measurement

Radiated emissions which fall in the restricted bands must comply with the radiated emission limits specified as below table. Other emissions shall be at least 20 dB below the highest level of the desired power:

Frequencies (MHz)	Field Strength (microvolts/meter)	Measurement Distance (meters)
0.009 ~ 0.490	2400/F (kHz)	300
0.490 ~ 1.705	24000/F (kHz)	30
1.705 ~ 30.0	30	30
30 ~ 88	100	3
88 ~ 216	150	3
216 ~ 960	200	3
Above 960	500	3

**NOTE:**

1. The lower limit shall apply at the transition frequencies.
2. Emission level (dBuV/m) = 20 log Emission level (uV/m).
3. For frequencies above 1000 MHz, the field strength limits are based on average detector, however, the peak field strength of any emission shall not exceed the maximum permitted average limits, specified above by more than 20 dB under any condition of modulation.

## 4.1.2 Test Instruments

Description & Manufacturer	Model No.	Serial No.	Date of Calibration	Due Date of Calibration
Test Receiver Agilent Technologies	N9038A	MY52260177	Aug. 26, 2019	Aug. 25, 2020
Spectrum Analyzer ROHDE & SCHWARZ	FSU43	101261	Apr. 15, 2019	Apr. 14, 2020
HORN Antenna ETS-Lindgren	3117	00143293	Nov. 24, 2019	Nov. 23, 2020
BILOG Antenna SCHWARZBECK	VULB 9168	9168-616	Nov. 12, 2019	Nov. 11, 2020
HORN Antenna SCHWARZBECK	BBHA 9170	9170-480	Nov. 24, 2019	Nov. 23, 2020
Fixed Attenuator Mini-Circuits	MDCS18N-10	MDCS18N-10-01	Apr. 15, 2019	Apr. 14, 2020
Loop Antenna	EM-6879	269	Sep. 16, 2019	Sep. 15, 2020
Preamplifier Agilent	310N	187226	Jun. 18, 2019	Jun. 17, 2020
Preamplifier Agilent	83017A	MY39501357	Jun. 18, 2019	Jun. 17, 2020
Power Meter Anritsu	ML2495A	1012010	Sep. 04, 2019	Sep. 03, 2020
Power Sensor Anritsu	MA2411B	1315050	Sep. 04, 2019	Sep. 03, 2020
RF signal cable ETS-LINDGREN	5D-FB	Cable-CH1-01(RFC-SMS-100-SMS-120+RFC-SMS-100-SMS-400)	Jun. 18, 2019	Jun. 17, 2020
RF signal cable ETS-LINDGREN	8D-FB	Cable-CH1-02(RFC-SMS-100-SMS-24)	Jun. 18, 2019	Jun. 17, 2020
Preamplifier Agilent	310N	187226	Jun. 18, 2019	Jun. 17, 2020
Software BV ADT	E3 8.130425b	NA	NA	NA
Antenna Tower MF	NA	NA	NA	NA
Turn Table MF	NA	NA	NA	NA
Antenna Tower & Turn Table Controller MF	MF-7802	NA	NA	NA
DC Power Supply Topward	3303D	803136	NA	NA

Note: 1. The calibration interval of the above test instruments is 12 months and the calibrations are traceable to NML/ROC and NIST/USA.

2. The test was performed in HsinTien Chamber 1.

#### 4.1.3 Test Procedures

##### **For Radiated Emission below 30 MHz**

- a. The EUT was placed on the top of a rotating table 0.8 meters above the ground at a 3 meter chamber room. The table was rotated 360 degrees to determine the position of the highest radiation.
- b. The EUT was set 3 meters away from the interference-receiving antenna, which was mounted on the top of a variable-height antenna tower.
- c. Parallel, perpendicular, and ground-parallel orientations of the antenna are set to make the measurement.
- d. For each suspected emission, the EUT was arranged to its worst case and the rotatable table was turned from 0 degrees to 360 degrees to find the maximum reading.
- e. The test-receiver system was set to Quasi-Peak Detect Function and Specified Bandwidth with Maximum Hold Mode.

##### **Note:**

1. The resolution bandwidth and video bandwidth of test receiver/spectrum analyzer is 9 kHz at frequency below 30 MHz.

##### **For Radiated Emission above 30 MHz**

- a. The EUT was placed on the top of a rotating table 0.8 meters (for 30 MHz ~ 1 GHz) / 1.5 meters (for above 1 GHz) above the ground at 3 meter chamber room for test. The table was rotated 360 degrees to determine the position of the highest radiation.
- b. The EUT was set 3 meters away from the interference-receiving antenna, which was mounted on the top of a variable-height antenna tower.
- c. The height of antenna is varied from one meter to four meters above the ground to determine the maximum value of the field strength. Both horizontal and vertical polarizations of the antenna are set to make the measurement.
- d. For each suspected emission, the EUT was arranged to its worst case and then the antenna was tuned to heights from 1 meter to 4 meters and the rotatable table was turned from 0 degrees to 360 degrees to find the maximum reading.
- e. The test-receiver system was set to quasi-peak detect function and specified bandwidth with maximum hold mode when the test frequency is below 1 GHz.
- f. The test-receiver system was set to peak and average detected function and specified bandwidth with maximum hold mode when the test frequency is above 1 GHz. If the peak reading value also meets average limit, measurement with the average detector is unnecessary.

##### **Note:**

1. The resolution bandwidth and video bandwidth of test receiver/spectrum analyzer is 120 kHz for Quasi-peak detection (QP) or Peak detection (PK) at frequency below 1 GHz.
2. The resolution bandwidth of test receiver/spectrum analyzer is 1 MHz and the video bandwidth is 3 MHz for Peak detection (PK) at frequency above 1 GHz.
3. The resolution bandwidth of test receiver/spectrum analyzer is 1 MHz and the video bandwidth is  $\geq 1/T$  (Duty cycle < 98 %) or 10 Hz (Duty cycle  $\geq 98$  %) for Average detection (AV) at frequency above 1 GHz.  
(11b: RBW = 1 MHz, VBW = 300 Hz ; 11g: RBW = 1 MHz, VBW = 1 kHz ;  
11n (HT20): RBW = 1 MHz, VBW = 1 kHz ; 11n (HT40): RBW = 1 MHz, VBW = 3 kHz)
4. All modes of operation were investigated and the worst-case emissions are reported.

4.1.4 Deviation from Test Standard

No deviation.

4.1.5 Test Set Up

<Radiated Emission below 30 MHz>

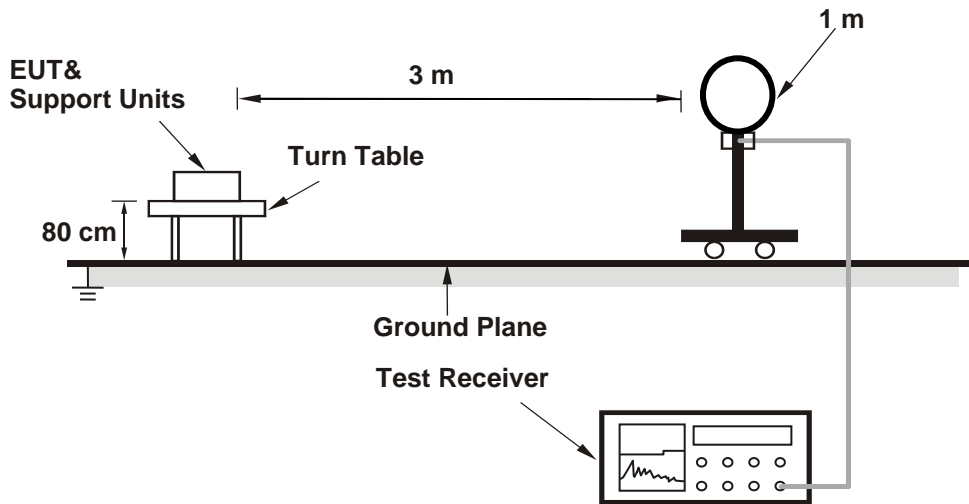

<Radiated Emission 30 MHz to 1 GHz>

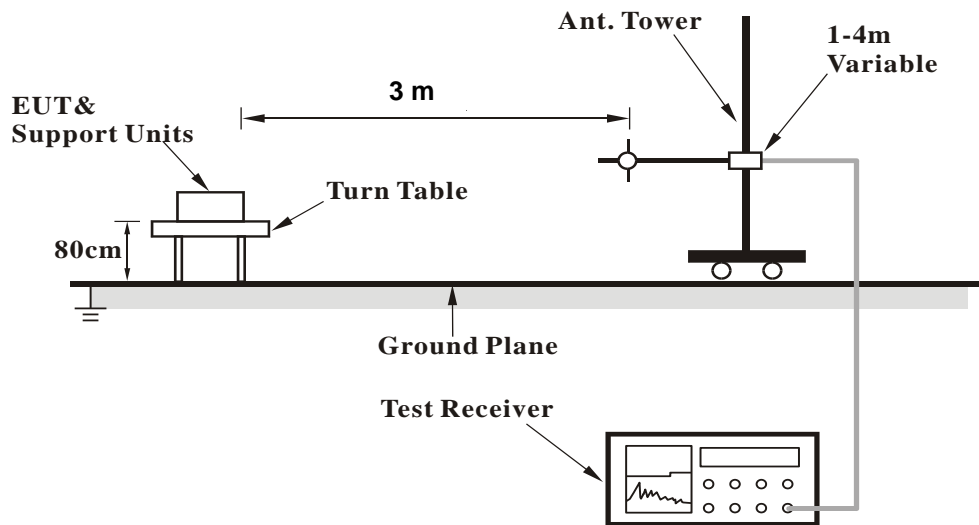



**<Radiated Emission above 1 GHz>**

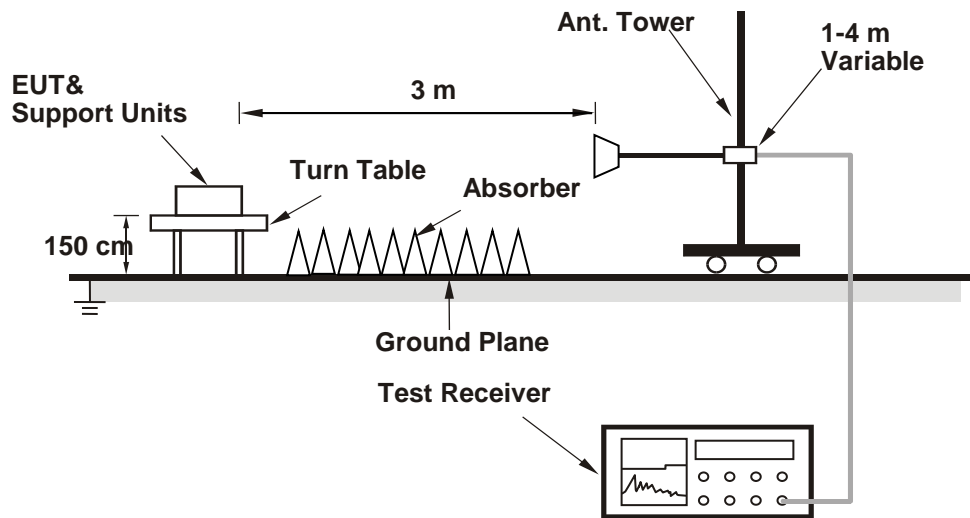

For the actual test configuration, please refer to the attached file (Test Setup Photo).

**4.1.6 EUT Operating Conditions**

- a. Placed the EUT on a testing table.
- b. Use the software to control the EUT under transmission condition continuously at specific channel frequency.

4.1.7 Test Results

Above 1 GHz Data :  
802.11b

EUT Test Condition		Measurement Detail	
Channel	Channel 1	Frequency Range	1 GHz ~ 25 GHz
Input Power	120 Vac, 60 Hz	Detector Function	Peak (PK) Average (AV)
Environmental Conditions	25 deg. C, 65 % RH	Tested By	Harry Hsueh

Antenna Polarity & Test Distance: Horizontal at 3 m								
Frequency (MHz)	Emission Level (dBuV/m)	Read Level (dBuV)	Factor (dB/m)	Limit (dBuV/m)	Margin (dB)	Antenna Height (cm)	Table Angle (Degree)	Remark
2390	40.19	35.69	4.5	54	-13.81	257	137	Average
2390	51.8	47.3	4.5	74	-22.2	257	137	Peak
2412	99.23	94.68	4.55			261	134	Average
2412	102.15	97.6	4.55			261	134	Peak
4824	41.74	31.45	10.29	54	-12.26	136	188	Average
4824	47.96	37.67	10.29	74	-26.04	136	188	Peak

Antenna Polarity & Test Distance: Vertical at 3 m								
Frequency (MHz)	Emission Level (dBuV/m)	Read Level (dBuV)	Factor (dB/m)	Limit (dBuV/m)	Margin (dB)	Antenna Height (cm)	Table Angle (Degree)	Remark
2390	40.95	36.45	4.5	54	-13.05	246	101	Average
2390	51.65	47.15	4.5	74	-22.35	246	101	Peak
2412	97.12	92.57	4.55			250	108	Average
2412	99.63	95.08	4.55			250	108	Peak
4824	41.82	31.53	10.29	54	-12.18	108	169	Average
4824	48.13	37.84	10.29	74	-25.87	108	169	Peak

Remarks:

- Emission Level = Read Level + Factor  
Margin value = Emission level – Limit value
- 2412 MHz: Fundamental frequency.
- The emission levels of other frequencies were very low against the limit.

EUT Test Condition		Measurement Detail	
Channel	Channel 6	Frequency Range	1 GHz ~ 25 GHz
Input Power	120 Vac, 60 Hz	Detector Function	Peak (PK) Average (AV)
Environmental Conditions	25 deg. C, 65 % RH	Tested By	Harry Hsueh

Antenna Polarity & Test Distance: Horizontal at 3 m								
Frequency (MHz)	Emission Level (dBuV/m)	Read Level (dBuV)	Factor (dB/m)	Limit (dBuV/m)	Margin (dB)	Antenna Height (cm)	Table Angle (Degree)	Remark
2390	40.1	35.6	4.5	54	-13.9	350	360	Average
2390	51.68	47.18	4.5	74	-22.32	350	360	Peak
2437	99.29	94.7	4.59			350	360	Average
2437	102.95	98.36	4.59			350	360	Peak
2483.5	40.63	35.97	4.66	54	-13.37	350	360	Average
2483.5	51.64	46.98	4.66	74	-22.36	350	360	Peak
4874	41.04	30.83	10.21	54	-12.96	139	256	Average
4874	47.18	36.97	10.21	74	-26.82	139	256	Peak
Antenna Polarity & Test Distance: Vertical at 3 m								
Frequency (MHz)	Emission Level (dBuV/m)	Read Level (dBuV)	Factor (dB/m)	Limit (dBuV/m)	Margin (dB)	Antenna Height (cm)	Table Angle (Degree)	Remark
2390	41.02	36.52	4.5	54	-12.98	280	328	Average
2390	52.5	48	4.5	74	-21.5	280	328	Peak
2437	97.28	92.69	4.59			280	328	Average
2437	100.96	96.37	4.59			280	328	Peak
2483.5	40.54	35.88	4.66	54	-13.46	280	328	Average
2483.5	51.9	47.24	4.66	74	-22.1	280	328	Peak
4874	41.29	31.08	10.21	54	-12.71	128	114	Average
4874	47.67	37.46	10.21	74	-26.33	128	114	Peak

Remarks:

- Emission Level = Read Level + Factor  
Margin value = Emission level – Limit value
- 2437 MHz: Fundamental frequency.
- The emission levels of other frequencies were very low against the limit.

EUT Test Condition		Measurement Detail	
Channel	Channel 11	Frequency Range	1 GHz ~ 25 GHz
Input Power	120 Vac, 60 Hz	Detector Function	Peak (PK) Average (AV)
Environmental Conditions	25 deg. C, 65 % RH	Tested By	Karl Lee

Antenna Polarity & Test Distance: Horizontal at 3 m								
Frequency (MHz)	Emission Level (dBuV/m)	Read Level (dBuV)	Factor (dB/m)	Limit (dBuV/m)	Margin (dB)	Antenna Height (cm)	Table Angle (Degree)	Remark
2462	104.07	99.45	4.62			251	134	Average
2462	106.38	101.76	4.62			251	134	Peak
2483.5	41.88	37.22	4.66	54	-12.12	251	134	Average
2483.5	52.26	47.6	4.66	74	-21.74	251	134	Peak
4924	42.03	31.78	10.25	54	-11.97	195	211	Average
4924	48.31	38.06	10.25	74	-25.69	195	211	Peak
Antenna Polarity & Test Distance: Vertical at 3 m								
Frequency (MHz)	Emission Level (dBuV/m)	Read Level (dBuV)	Factor (dB/m)	Limit (dBuV/m)	Margin (dB)	Antenna Height (cm)	Table Angle (Degree)	Remark
2462	100.99	96.37	4.62			298	110	Average
2462	103.39	98.77	4.62			298	110	Peak
2483.5	40.59	35.93	4.66	54	-13.41	298	110	Average
2483.5	51.8	47.14	4.66	74	-22.2	298	110	Peak
4924	42.19	31.94	10.25	54	-11.81	106	137	Average
4924	48.32	38.07	10.25	74	-25.68	106	137	Peak

Remarks:

- Emission Level = Read Level + Factor  
Margin value = Emission level – Limit value
- 2462 MHz: Fundamental frequency.
- The emission levels of other frequencies were very low against the limit.

802.11g

EUT Test Condition		Measurement Detail	
Channel	Channel 1	Frequency Range	1 GHz ~ 25 GHz
Input Power	120 Vac, 60 Hz	Detector Function	Peak (PK) Average (AV)
Environmental Conditions	25 deg. C, 65 % RH	Tested By	Karl Lee

Antenna Polarity & Test Distance: Horizontal at 3 m								
Frequency (MHz)	Emission Level (dBuV/m)	Read Level (dBuV)	Factor (dB/m)	Limit (dBuV/m)	Margin (dB)	Antenna Height (cm)	Table Angle (Degree)	Remark
2390	42.93	38.43	4.5	54	-11.07	257	141	Average
2390	56.43	51.93	4.5	74	-17.57	257	141	Peak
2412	97.1	92.55	4.55			261	133	Average
2412	103.8	99.25	4.55			261	133	Peak
4824	41.78	31.49	10.29	54	-12.22	156	84	Average
4824	48.06	37.77	10.29	74	-25.94	156	84	Peak
Antenna Polarity & Test Distance: Vertical at 3 m								
Frequency (MHz)	Emission Level (dBuV/m)	Read Level (dBuV)	Factor (dB/m)	Limit (dBuV/m)	Margin (dB)	Antenna Height (cm)	Table Angle (Degree)	Remark
2390	41.93	37.43	4.5	54	-12.07	311	109	Average
2390	53.87	49.37	4.5	74	-20.13	311	109	Peak
2412	95.05	90.5	4.55			311	109	Average
2412	101.58	97.03	4.55			311	109	Peak
4824	42.06	31.77	10.29	54	-11.94	175	131	Average
4824	48.26	37.97	10.29	74	-25.74	175	131	Peak

Remarks:

- Emission Level = Read Level + Factor  
Margin value = Emission level – Limit value
- 2412 MHz: Fundamental frequency.
- The emission levels of other frequencies were very low against the limit.

EUT Test Condition		Measurement Detail	
Channel	Channel 6	Frequency Range	1 GHz ~ 25 GHz
Input Power	120 Vac, 60 Hz	Detector Function	Peak (PK) Average (AV)
Environmental Conditions	25 deg. C, 65 % RH	Tested By	Karl Lee

Antenna Polarity & Test Distance: Horizontal at 3 m								
Frequency (MHz)	Emission Level (dBuV/m)	Read Level (dBuV)	Factor (dB/m)	Limit (dBuV/m)	Margin (dB)	Antenna Height (cm)	Table Angle (Degree)	Remark
2390	41.31	36.81	4.5	54	-12.69	231	134	Average
2390	51.37	46.87	4.5	74	-22.63	231	134	Peak
2437	99.79	95.2	4.59			231	134	Average
2437	106.54	101.95	4.59			231	134	Peak
2483.5	41.83	37.17	4.66	54	-12.17	231	134	Average
2483.5	52	47.34	4.66	74	-22	231	134	Peak
4874	41.03	30.82	10.21	54	-12.97	168	226	Average
4874	47.33	37.12	10.21	74	-26.67	168	226	Peak
Antenna Polarity & Test Distance: Vertical at 3 m								
Frequency (MHz)	Emission Level (dBuV/m)	Read Level (dBuV)	Factor (dB/m)	Limit (dBuV/m)	Margin (dB)	Antenna Height (cm)	Table Angle (Degree)	Remark
2390	41.22	36.72	4.5	54	-12.78	288	111	Average
2390	51.24	46.74	4.5	74	-22.76	288	111	Peak
2437	96.61	92.02	4.59			288	111	Average
2437	103.02	98.43	4.59			288	111	Peak
2483.5	41.55	36.89	4.66	54	-12.45	288	111	Average
2483.5	52.05	47.39	4.66	74	-21.95	288	111	Peak
4874	41.51	31.3	10.21	54	-12.49	166	105	Average
4874	47.85	37.64	10.21	74	-26.15	166	105	Peak

Remarks:

- Emission Level = Read Level + Factor  
Margin value = Emission level – Limit value
- 2437 MHz: Fundamental frequency.
- The emission levels of other frequencies were very low against the limit.

EUT Test Condition		Measurement Detail	
Channel	Channel 11	Frequency Range	1 GHz ~ 25 GHz
Input Power	120 Vac, 60 Hz	Detector Function	Peak (PK) Average (AV)
Environmental Conditions	25 deg. C, 65 % RH	Tested By	Karl Lee

Antenna Polarity & Test Distance: Horizontal at 3 m								
Frequency (MHz)	Emission Level (dBuV/m)	Read Level (dBuV)	Factor (dB/m)	Limit (dBuV/m)	Margin (dB)	Antenna Height (cm)	Table Angle (Degree)	Remark
2462	100.79	96.17	4.62			251	134	Average
2462	107.19	102.57	4.62			251	134	Peak
<b>2483.5</b>	<b>52.71</b>	<b>48.05</b>	<b>4.66</b>	<b>54</b>	<b>-1.29</b>	<b>278</b>	<b>134</b>	<b>Average</b>
2483.5	65.8	61.14	4.66	74	-8.2	278	134	Peak
4924	42.26	32.01	10.25	54	-11.74	156	227	Average
4924	48.31	38.06	10.25	74	-25.69	156	227	Peak
Antenna Polarity & Test Distance: Vertical at 3 m								
Frequency (MHz)	Emission Level (dBuV/m)	Read Level (dBuV)	Factor (dB/m)	Limit (dBuV/m)	Margin (dB)	Antenna Height (cm)	Table Angle (Degree)	Remark
2462	97.47	92.85	4.62			298	110	Average
2462	104.75	100.13	4.62			298	110	Peak
2483.5	48.77	44.11	4.66	54	-5.23	298	106	Average
2483.5	60.46	55.8	4.66	74	-13.54	298	106	Peak
4924	42.17	31.92	10.25	54	-11.83	112	83	Average
4924	48.52	38.27	10.25	74	-25.48	112	83	Peak

Remarks:

- Emission Level = Read Level + Factor  
Margin value = Emission level – Limit value
- 2462 MHz: Fundamental frequency.
- The emission levels of other frequencies were very low against the limit.

802.11n (HT20)

EUT Test Condition		Measurement Detail	
Channel	Channel 1	Frequency Range	1 GHz ~ 25 GHz
Input Power	120 Vac, 60 Hz	Detector Function	Peak (PK) Average (AV)
Environmental Conditions	25 deg. C, 65 % RH	Tested By	Karl Lee

Antenna Polarity & Test Distance: Horizontal at 3 m								
Frequency (MHz)	Emission Level (dBuV/m)	Read Level (dBuV)	Factor (dB/m)	Limit (dBuV/m)	Margin (dB)	Antenna Height (cm)	Table Angle (Degree)	Remark
2390	43.39	38.89	4.5	54	-10.61	264	138	Average
2390	57.72	53.22	4.5	74	-16.28	264	138	Peak
2412	95.9	91.35	4.55			261	133	Average
2412	103.27	98.72	4.55			261	133	Peak
4824	40.88	30.59	10.29	54	-13.12	186	235	Average
4824	47.03	36.74	10.29	74	-26.97	186	235	Peak
Antenna Polarity & Test Distance: Vertical at 3 m								
Frequency (MHz)	Emission Level (dBuV/m)	Read Level (dBuV)	Factor (dB/m)	Limit (dBuV/m)	Margin (dB)	Antenna Height (cm)	Table Angle (Degree)	Remark
2390	42.52	38.02	4.5	54	-11.48	311	109	Average
2390	54.33	49.83	4.5	74	-19.67	311	109	Peak
2412	93.48	88.93	4.55			311	109	Average
2412	100.7	96.15	4.55			311	109	Peak
4824	41.74	31.45	10.29	54	-12.26	103	56	Average
4824	47.99	37.7	10.29	74	-26.01	103	56	Peak

Remarks:

- Emission Level = Read Level + Factor  
Margin value = Emission level – Limit value
- 2412 MHz: Fundamental frequency.
- The emission levels of other frequencies were very low against the limit.



EUT Test Condition		Measurement Detail	
Channel	Channel 6	Frequency Range	1 GHz ~ 25 GHz
Input Power	120 Vac, 60 Hz	Detector Function	Peak (PK) Average (AV)
Environmental Conditions	25 deg. C, 65 % RH	Tested By	Karl Lee

Antenna Polarity & Test Distance: Horizontal at 3 m								
Frequency (MHz)	Emission Level (dBuV/m)	Read Level (dBuV)	Factor (dB/m)	Limit (dBuV/m)	Margin (dB)	Antenna Height (cm)	Table Angle (Degree)	Remark
2390	41.26	36.76	4.5	54	-12.74	231	134	Average
2390	51.09	46.59	4.5	74	-22.91	231	134	Peak
2437	97.92	93.33	4.59			231	134	Average
2437	104.32	99.73	4.59			231	134	Peak
2483.5	41.75	37.09	4.66	54	-12.25	231	134	Average
2483.5	52.21	47.55	4.66	74	-21.79	231	134	Peak
4874	40.13	29.92	10.21	54	-13.87	191	172	Average
4874	46.27	36.06	10.21	74	-27.73	191	172	Peak
Antenna Polarity & Test Distance: Vertical at 3 m								
Frequency (MHz)	Emission Level (dBuV/m)	Read Level (dBuV)	Factor (dB/m)	Limit (dBuV/m)	Margin (dB)	Antenna Height (cm)	Table Angle (Degree)	Remark
2390	41.13	36.63	4.5	54	-12.87	288	111	Average
2390	51.04	46.54	4.5	74	-22.96	288	111	Peak
2437	95.61	91.02	4.59			288	111	Average
2437	101.97	97.38	4.59			288	111	Peak
2483.5	41.59	36.93	4.66	54	-12.41	288	111	Average
2483.5	52.14	47.48	4.66	74	-21.86	288	111	Peak
4874	40.58	30.37	10.21	54	-13.42	126	304	Average
4874	47.07	36.86	10.21	74	-26.93	126	304	Peak

Remarks:

- Emission Level = Read Level + Factor  
Margin value = Emission level – Limit value
- 2437 MHz: Fundamental frequency.
- The emission levels of other frequencies were very low against the limit.

EUT Test Condition		Measurement Detail	
Channel	Channel 11	Frequency Range	1 GHz ~ 25 GHz
Input Power	120 Vac, 60 Hz	Detector Function	Peak (PK) Average (AV)
Environmental Conditions	25 deg. C, 65 % RH	Tested By	Karl Lee

Antenna Polarity & Test Distance: Horizontal at 3 m								
Frequency (MHz)	Emission Level (dBuV/m)	Read Level (dBuV)	Factor (dB/m)	Limit (dBuV/m)	Margin (dB)	Antenna Height (cm)	Table Angle (Degree)	Remark
2462	99.4	94.78	4.62			251	134	Average
2462	105.69	101.07	4.62			251	134	Peak
2483.5	52.41	47.75	4.66	54	-1.59	277	134	Average
2483.5	67.97	63.31	4.66	74	-6.03	277	134	Peak
4924	41.02	30.77	10.25	54	-12.98	165	222	Average
4924	47.21	36.96	10.25	74	-26.79	165	222	Peak
Antenna Polarity & Test Distance: Vertical at 3 m								
Frequency (MHz)	Emission Level (dBuV/m)	Read Level (dBuV)	Factor (dB/m)	Limit (dBuV/m)	Margin (dB)	Antenna Height (cm)	Table Angle (Degree)	Remark
2462	96.27	91.65	4.62			298	110	Average
2462	102.75	98.13	4.62			298	110	Peak
2483.5	47.64	42.98	4.66	54	-6.36	298	110	Average
2483.5	60.41	55.75	4.66	74	-13.59	298	110	Peak
4924	40.94	30.69	10.25	54	-13.06	103	215	Average
4924	47.13	36.88	10.25	74	-26.87	103	215	Peak

Remarks:

- Emission Level = Read Level + Factor  
Margin value = Emission level – Limit value
- 2462 MHz: Fundamental frequency.
- The emission levels of other frequencies were very low against the limit.

### 802.11n (HT40)

EUT Test Condition		Measurement Detail	
Channel	Channel 3	Frequency Range	1 GHz ~ 25 GHz
Input Power	120 Vac, 60 Hz	Detector Function	Peak (PK) Average (AV)
Environmental Conditions	25 deg. C, 65 % RH	Tested By	Karl Lee

Antenna Polarity & Test Distance: Horizontal at 3 m								
Frequency (MHz)	Emission Level (dBuV/m)	Read Level (dBuV)	Factor (dB/m)	Limit (dBuV/m)	Margin (dB)	Antenna Height (cm)	Table Angle (Degree)	Remark
2390	49.8	45.3	4.5	54	-4.2	265	134	Average
2390	65.7	61.2	4.5	74	-8.3	265	134	Peak
2422	94.57	90.01	4.56			265	134	Average
2422	100.59	96.03	4.56			265	134	Peak
2483.5	42.12	37.46	4.66	54	-11.88	265	134	Average
2483.5	51.99	47.33	4.66	74	-22.01	265	134	Peak
4844	40.36	30.13	10.23	54	-13.64	158	109	Average
4844	46.64	36.41	10.23	74	-27.36	158	109	Peak
Antenna Polarity & Test Distance: Vertical at 3 m								
Frequency (MHz)	Emission Level (dBuV/m)	Read Level (dBuV)	Factor (dB/m)	Limit (dBuV/m)	Margin (dB)	Antenna Height (cm)	Table Angle (Degree)	Remark
2390	46.31	41.81	4.5	54	-7.69	311	109	Average
2390	61.92	57.42	4.5	74	-12.08	311	109	Peak
2422	90.97	86.41	4.56			311	109	Average
2422	98.07	93.51	4.56			311	109	Peak
2483.5	41.98	37.32	4.66	54	-12.02	311	109	Average
2483.5	51.65	46.99	4.66	74	-22.35	311	109	Peak
4844	41.06	30.83	10.23	54	-12.94	175	113	Average
4844	47.3	37.07	10.23	74	-26.7	175	113	Peak

Remarks:

- Emission Level = Read Level + Factor  
Margin value = Emission level – Limit value
- 2422 MHz: Fundamental frequency.
- The emission levels of other frequencies were very low against the limit.

EUT Test Condition		Measurement Detail	
Channel	Channel 6	Frequency Range	1 GHz ~ 25 GHz
Input Power	120 Vac, 60 Hz	Detector Function	Peak (PK) Average (AV)
Environmental Conditions	25 deg. C, 65 % RH	Tested By	Karl Lee

Antenna Polarity & Test Distance: Horizontal at 3 m								
Frequency (MHz)	Emission Level (dBuV/m)	Read Level (dBuV)	Factor (dB/m)	Limit (dBuV/m)	Margin (dB)	Antenna Height (cm)	Table Angle (Degree)	Remark
2390	42.05	37.55	4.5	54	-11.95	231	134	Average
2390	52.2	47.7	4.5	74	-21.8	231	134	Peak
2437	93.62	89.03	4.59			231	134	Average
2437	101.56	96.97	4.59			231	134	Peak
2483.5	43.7	39.04	4.66	54	-10.3	231	134	Average
2483.5	54.26	49.6	4.66	74	-19.74	231	134	Peak
4874	40.18	29.97	10.21	54	-13.82	117	321	Average
4874	46.24	36.03	10.21	74	-27.76	117	321	Peak
Antenna Polarity & Test Distance: Vertical at 3 m								
Frequency (MHz)	Emission Level (dBuV/m)	Read Level (dBuV)	Factor (dB/m)	Limit (dBuV/m)	Margin (dB)	Antenna Height (cm)	Table Angle (Degree)	Remark
2390	41.73	37.23	4.5	54	-12.27	288	111	Average
2390	51.35	46.85	4.5	74	-22.65	288	111	Peak
2437	91.48	86.89	4.59			288	111	Average
2437	98.7	94.11	4.59			288	111	Peak
2483.5	42.72	38.06	4.66	54	-11.28	288	111	Average
2483.5	52.97	48.31	4.66	74	-21.03	288	111	Peak
4874	40.28	30.07	10.21	54	-13.72	146	251	Average
4874	46.53	36.32	10.21	74	-27.47	146	251	Peak

Remarks:

- Emission Level = Read Level + Factor  
Margin value = Emission level – Limit value
- 2437 MHz: Fundamental frequency.
- The emission levels of other frequencies were very low against the limit.

EUT Test Condition		Measurement Detail	
Channel	Channel 9	Frequency Range	1 GHz ~ 25 GHz
Input Power	120 Vac, 60 Hz	Detector Function	Peak (PK) Average (AV)
Environmental Conditions	25 deg. C, 65 % RH	Tested By	Karl Lee

Antenna Polarity & Test Distance: Horizontal at 3 m								
Frequency (MHz)	Emission Level (dBuV/m)	Read Level (dBuV)	Factor (dB/m)	Limit (dBuV/m)	Margin (dB)	Antenna Height (cm)	Table Angle (Degree)	Remark
2390	41.49	36.99	4.5	54	-12.51	255	134	Average
2390	50.98	46.48	4.5	74	-23.02	255	134	Peak
2452	93.35	88.75	4.6			255	134	Average
2452	99.85	95.25	4.6			255	134	Peak
2483.5	52.41	47.75	4.66	54	-1.59	279	134	Average
2483.5	66.97	62.31	4.66	74	-7.03	279	134	Peak
4904	40.23	30.09	10.14	54	-13.77	183	21	Average
4904	46.35	36.21	10.14	74	-27.65	183	21	Peak
Antenna Polarity & Test Distance: Vertical at 3 m								
Frequency (MHz)	Emission Level (dBuV/m)	Read Level (dBuV)	Factor (dB/m)	Limit (dBuV/m)	Margin (dB)	Antenna Height (cm)	Table Angle (Degree)	Remark
2390	41.08	36.58	4.5	54	-12.92	298	110	Average
2390	50.54	46.04	4.5	74	-23.46	298	110	Peak
2452	90.59	85.99	4.6			298	110	Average
2452	97.27	92.67	4.6			298	110	Peak
2483.5	49.21	44.55	4.66	54	-4.79	298	110	Average
2483.5	63.27	58.61	4.66	74	-10.73	298	110	Peak
4904	41.25	31.11	10.14	54	-12.75	178	263	Average
4904	47.07	36.93	10.14	74	-26.93	178	263	Peak

Remarks:

- Emission Level = Read Level + Factor  
Margin value = Emission level – Limit value
- 2452 MHz: Fundamental frequency.
- The emission levels of other frequencies were very low against the limit.

**9 kHz ~ 30 MHz Data:**

The amplitude of spurious emissions attenuated more than 20 dB below the permissible value is not required to be report.

**30 MHz ~ 1 GHz Worst-Case Data:**

**802.11g**

EUT Test Condition		Measurement Detail	
Channel	Channel 11	Frequency Range	30 MHz ~ 1 GHz
Input Power	120 Vac, 60 Hz	Detector Function	Peak (PK) Quasi-peak (QP)
Environmental Conditions	25 deg. C, 65 % RH	Tested By	Harry Hsueh

Antenna Polarity & Test Distance: Horizontal at 3 m								
Frequency (MHz)	Emission Level (dBuV/m)	Read Level (dBuV)	Factor (dB/m)	Limit (dBuV/m)	Margin (dB)	Antenna Height (cm)	Table Angle (Degree)	Remark
68.34	12.06	31.2	-19.14	40	-27.94	102	132	Peak
101.82	27.57	44.73	-17.16	43.5	-15.93	142	165	Peak
153.12	37.91	58.78	-20.87	43.5	-5.59	169	158	Peak
395.2	18.54	32.58	-14.04	46	-27.46	105	187	Peak
568.8	17.38	28.57	-11.19	46	-28.62	144	157	Peak
692	21.02	30.31	-9.29	46	-24.98	105	198	Peak
Antenna Polarity & Test Distance: Vertical at 3 m								
Frequency (MHz)	Emission Level (dBuV/m)	Read Level (dBuV)	Factor (dB/m)	Limit (dBuV/m)	Margin (dB)	Antenna Height (cm)	Table Angle (Degree)	Remark
52.95	22.92	38.28	-15.36	40	-17.08	124	214	Peak
91.02	17.96	36.76	-18.8	43.5	-25.54	126	135	Peak
143.94	24.38	45.41	-21.03	43.5	-19.12	105	184	Peak
398.7	24.75	38.7	-13.95	46	-21.25	148	165	Peak
538	16.59	28.37	-11.78	46	-29.41	172	184	Peak
650.7	19.04	29.09	-10.05	46	-26.96	199	165	Peak

Remarks:

- Emission Level = Read Level + Factor  
Margin value = Emission level – Limit value.
- The emission levels of other frequencies were very low against the limit.

### Horizontal

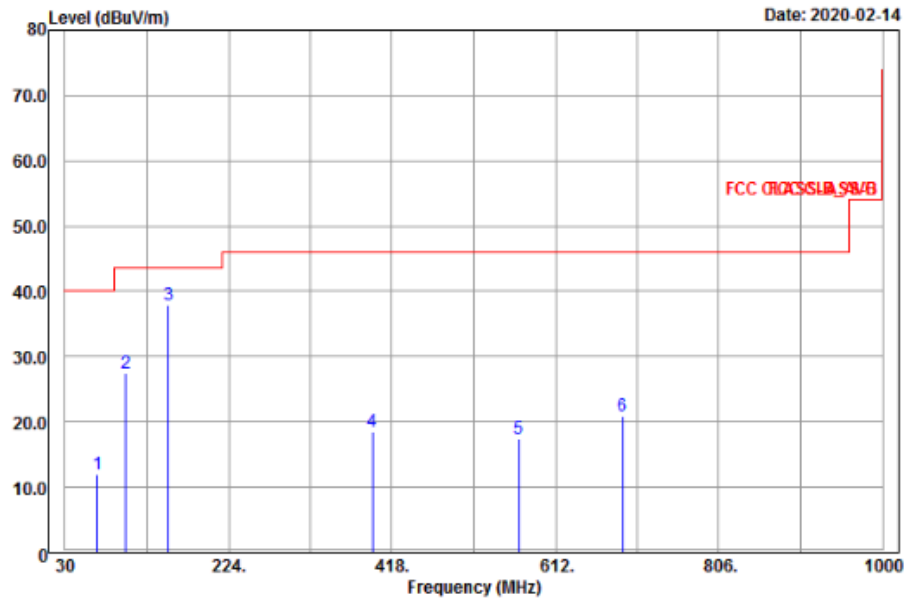

### Vertical

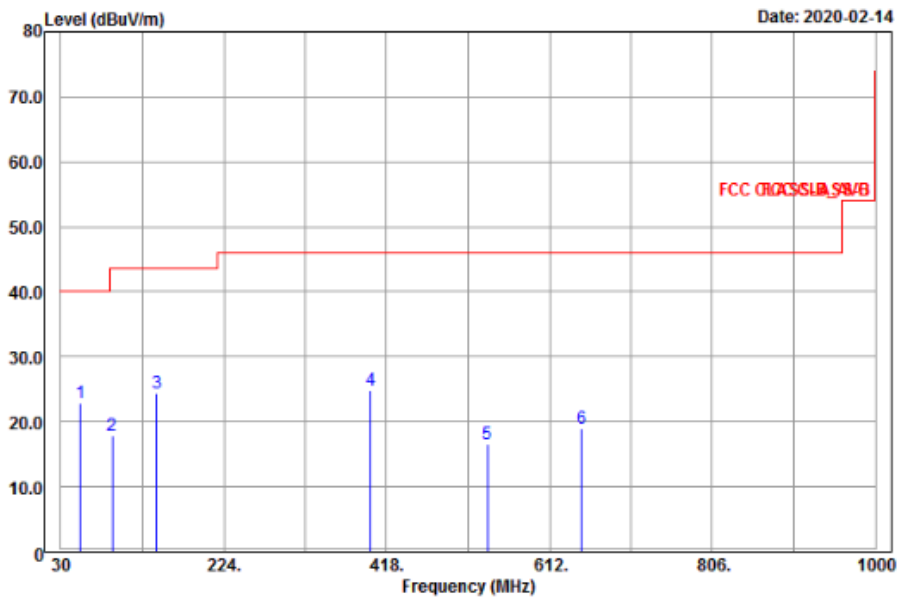

## 4.2 6 dB Bandwidth Measurement

### 4.2.1 Limits of 6 dB Bandwidth Measurement

The minimum of 6 dB Bandwidth Measurement is 0.5 MHz.

### 4.2.2 Test Setup

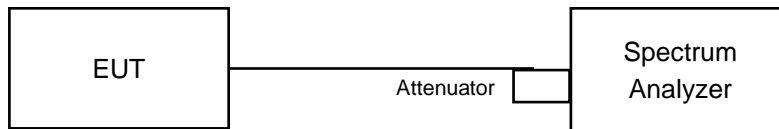

### 4.2.3 Test Instruments

Refer to section 4.1.2 to get information of above instrument.

### 4.2.4 Test Procedure

- Set resolution bandwidth (RBW) = 100 kHz
- Set the video bandwidth (VBW)  $\geq 3 \times$  RBW, Detector = Peak.
- Trace mode = max hold.
- Sweep = auto couple.
- Measure the maximum width of the emission that is constrained by the frequencies associated with the two amplitude points (upper and lower) that are attenuated by 6 dB relative to the maximum level measured in the fundamental emission

### 4.2.5 Deviation from Test Standard

No deviation.

### 4.2.6 EUT Operating Conditions

The software provided by client to enable the EUT under transmission condition continuously at lowest, middle and highest channel frequencies individually.



## 4.2.7 Test Results

## 802.11b

Channel	Frequency (MHz)	6 dB Bandwidth (MHz)		Minimum Limit (MHz)	Pass / Fail
		Chain 0	Chain 1		
1	2412	9.07	8.09	0.5	Pass
6	2437	8.58	9.07	0.5	Pass
11	2462	8.11	9.07	0.5	Pass

## 802.11g

Channel	Frequency (MHz)	6 dB Bandwidth (MHz)		Minimum Limit (MHz)	Pass / Fail
		Chain 0	Chain 1		
1	2412	15.18	15.15	0.5	Pass
6	2437	15.14	15.15	0.5	Pass
11	2462	15.19	15.15	0.5	Pass

## 802.11n (HT20)

Channel	Frequency (MHz)	6 dB Bandwidth (MHz)		Minimum Limit (MHz)	Pass / Fail
		Chain 0	Chain 1		
1	2412	15.15	15.14	0.5	Pass
6	2437	15.15	15.14	0.5	Pass
11	2462	15.19	15.18	0.5	Pass

## 802.11n (HT40)

Channel	Frequency (MHz)	6 dB Bandwidth (MHz)		Minimum Limit (MHz)	Pass / Fail
		Chain 0	Chain 1		
3	2422	35.28	35.19	0.5	Pass
6	2437	35.29	35.18	0.5	Pass
9	2452	35.28	35.27	0.5	Pass

### Spectrum Plot of Worst Value

#### 802.11b

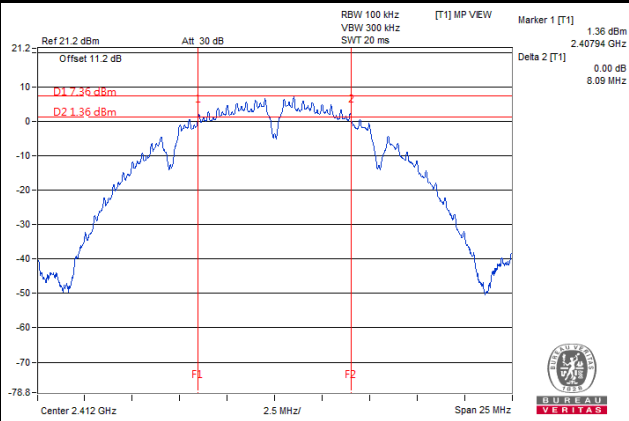

#### 802.11g

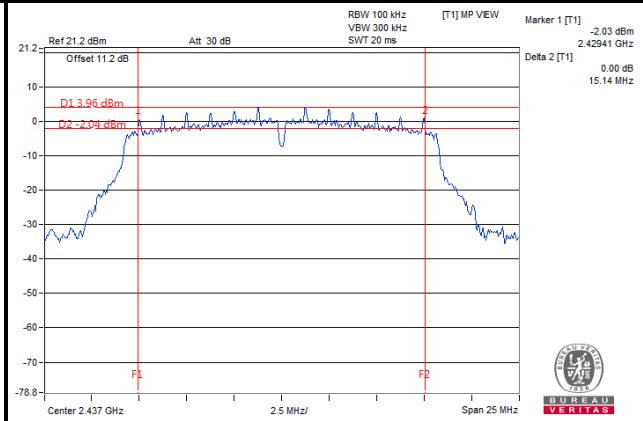

#### 802.11n (HT20)

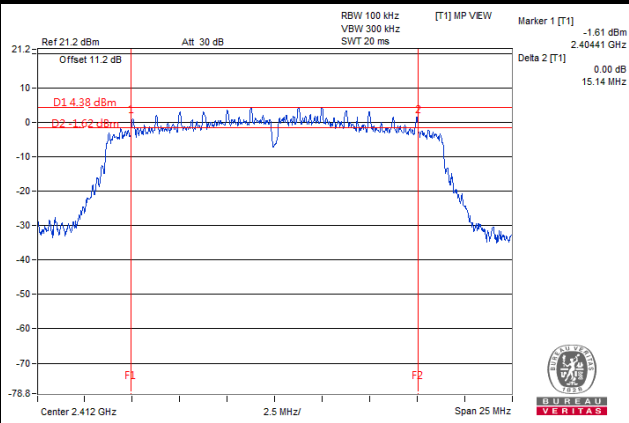

#### 802.11n (HT40)

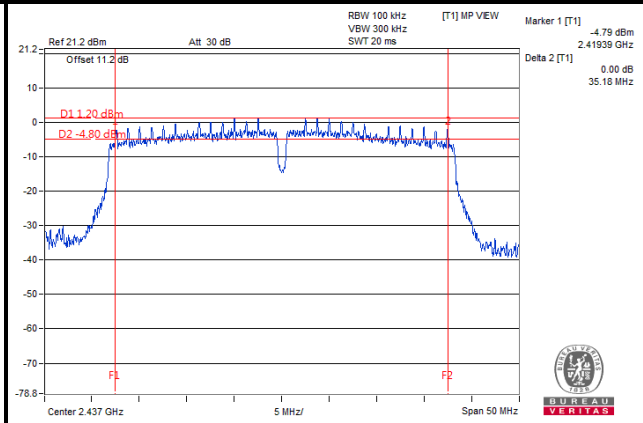

### 4.3 Occupied Bandwidth Measurement

#### 4.3.1 Test Setup

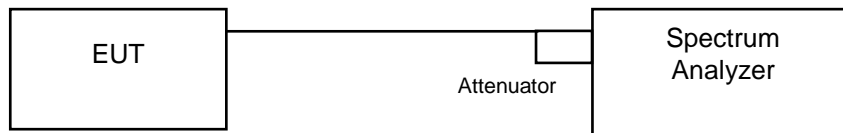

#### 4.3.2 Test Instruments

Refer to section 4.1.2 to get information of above instrument.

#### 4.3.3 Test Procedure

The transmitter output was connected to the spectrum analyzer through an attenuator. The bandwidth of the fundamental frequency was measured by spectrum analyzer with resolution bandwidth in the range of 1 % to 5 % of the anticipated emission bandwidth, and a video bandwidth at least 3x the resolution bandwidth and set the detector to sampling. The width of a frequency band such that, below the lower and above the upper frequency limits, the mean powers emitted are each equal to a specified percentage 0.5 % of the total mean power of a given emission.

#### 4.3.4 Deviation from Test Standard

No deviation.

#### 4.3.5 EUT Operating Conditions

The software provided by client to enable the EUT under transmission condition continuously at lowest, middle and highest channel frequencies individually.

## 4.3.6 Test Results

## 802.11b

Channel	Frequency (MHz)	Occupied Bandwidth (MHz)		Pass / Fail
		Chain 0	Chain 1	
1	2412	13.38	13.38	Pass
6	2437	13.38	13.44	Pass
11	2462	13.38	13.44	Pass

## 802.11g

Channel	Frequency (MHz)	Occupied Bandwidth (MHz)		Pass / Fail
		Chain 0	Chain 1	
1	2412	16.56	16.44	Pass
6	2437	16.68	16.44	Pass
11	2462	16.68	16.44	Pass

## 802.11n (HT20)

Channel	Frequency (MHz)	Occupied Bandwidth (MHz)		Pass / Fail
		Chain 0	Chain 1	
1	2412	17.64	17.64	Pass
6	2437	17.64	17.64	Pass
11	2462	17.60	17.60	Pass

## 802.11n (HT40)

Channel	Frequency (MHz)	Occupied Bandwidth (MHz)		Pass / Fail
		Chain 0	Chain 1	
3	2422	36.24	36.36	Pass
6	2437	36.24	36.36	Pass
9	2452	36.35	36.35	Pass

### Spectrum Plot of Worst Value

#### 802.11b

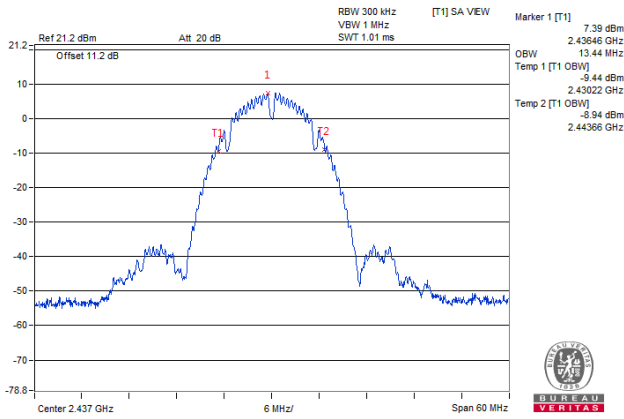

#### 802.11g

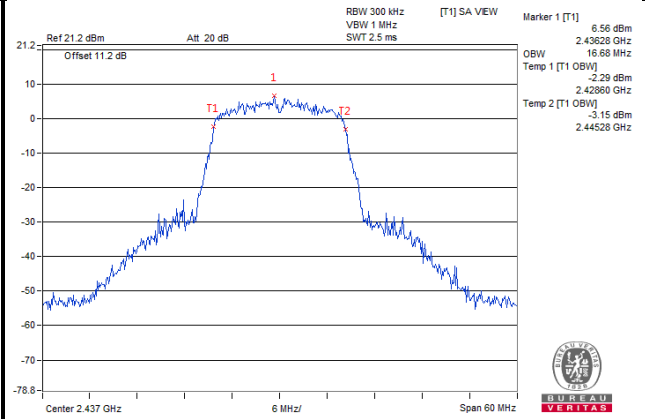

#### 802.11n (HT20)

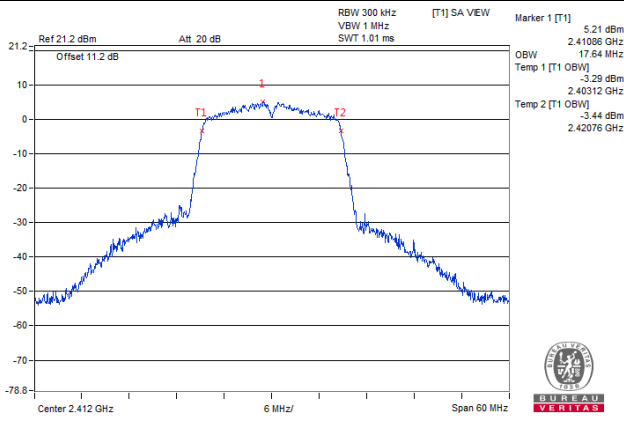

#### 802.11n (HT40)

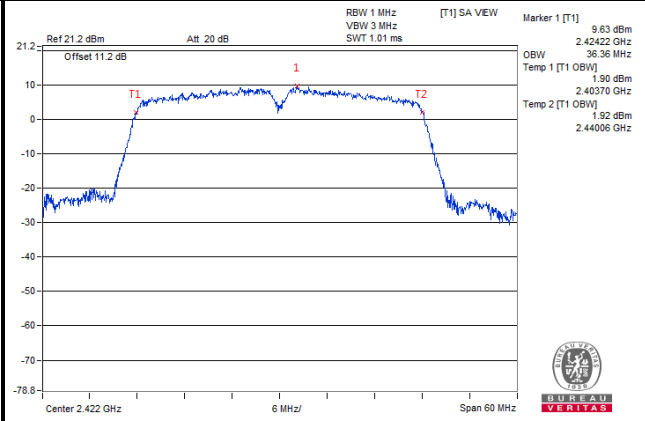

## 4.4 Conducted Output Power Measurement

### 4.4.1 Limits of Conducted Output Power Measurement

For systems using digital modulation in the 2400–2483.5 MHz bands: 1 Watt (30 dBm)

Per KDB 662911 D01 Multiple Transmitter Output Method of conducted output power measurement on IEEE 802.11 devices,

Array Gain = 0 dB (i.e., no array gain) for NANT  $\leq$  4;

Array Gain = 0 dB (i.e., no array gain) for channel widths  $\geq$  40 MHz for any NANT;

Array Gain =  $5 \log(\text{NANT}/\text{NSS})$  dB or 3 dB, whichever is less for 20 MHz channel widths with NANT  $\geq$  5.

For power measurements on all other devices: Array Gain =  $10 \log(\text{NANT}/\text{NSS})$  dB.

### 4.4.2 Test Setup

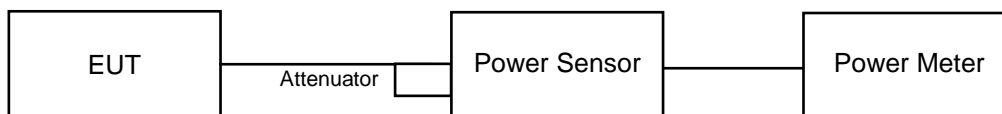

### 4.4.3 Test Instruments

Refer to section 4.1.2 to get information of above instrument.

### 4.4.4 Test Procedures

A peak power sensor was used on the output port of the EUT. A power meter was used to read the response of the peak power sensor. Record the power level.

### 4.4.5 Deviation from Test Standard

No deviation.

### 4.4.6 EUT Operating Conditions

The software provided by client to enable the EUT under transmission condition continuously at lowest, middle and highest channel frequencies individually.

#### 4.4.7 Test Results

##### Peak Power

##### 802.11b

Channel	Frequency (MHz)	Peak Power (dBm)		Total Power (mW)	Total Power (dBm)	Limit (dBm)	Pass / Fail
		Chain 0	Chain 1				
1	2412	15.44	15.54	70.805	18.50	30	Pass
6	2437	15.43	15.53	70.641	18.49	30	Pass
11	2462	15.45	15.57	71.133	18.52	30	Pass

##### 802.11g

Channel	Frequency (MHz)	Peak Power (dBm)		Total Power (mW)	Total Power (dBm)	Limit (dBm)	Pass / Fail
		Chain 0	Chain 1				
1	2412	19.43	21.05	215.05	23.33	30	Pass
6	2437	19.39	21.11	216.018	23.34	30	Pass
11	2462	19.83	20.36	204.804	23.11	30	Pass

##### 802.11n (HT20)

Channel	Frequency (MHz)	Peak Power (dBm)		Total Power (mW)	Total Power (dBm)	Limit (dBm)	Pass / Fail
		Chain 0	Chain 1				
1	2412	18.71	18.81	150.335	21.77	30	Pass
6	2437	18.63	18.76	148.108	21.71	30	Pass
11	2462	19.46	19.34	174.209	22.41	30	Pass

##### 802.11n (HT40)

Channel	Frequency (MHz)	Peak Power (dBm)		Total Power (mW)	Total Power (dBm)	Limit (dBm)	Pass / Fail
		Chain 0	Chain 1				
3	2422	16.01	16.13	80.922	19.08	30	Pass
6	2437	15.96	16.16	80.751	19.07	30	Pass
9	2452	17.10	18.16	116.75	20.67	30	Pass

## Average Power

### 802.11b

Channel	Frequency (MHz)	Average Power (dBm)		Total Power (mW)	Total Power (dBm)	Limit (dBm)	Pass / Fail
		Chain 0	Chain 1				
1	2412	13.35	14.41	52.247	17.18	30	Pass
6	2437	13.32	14.46	51.957	17.16	30	Pass
11	2462	13.39	14.48	52.73	17.22	30	Pass

### 802.11g

Channel	Frequency (MHz)	Average Power (dBm)		Total Power (mW)	Total Power (dBm)	Limit (dBm)	Pass / Fail
		Chain 0	Chain 1				
1	2412	12.29	13.46	39.125	15.92	30	Pass
6	2437	12.33	13.44	39.18	15.93	30	Pass
11	2462	12.77	13.41	40.851	16.11	30	Pass

### 802.11n (HT20)

Channel	Frequency (MHz)	Average Power (dBm)		Total Power (mW)	Total Power (dBm)	Limit (dBm)	Pass / Fail
		Chain 0	Chain 1				
1	2412	11.29	12.85	32.734	15.15	30	Pass
6	2437	11.21	12.79	32.224	15.08	30	Pass
11	2462	12.20	12.93	36.23	15.59	30	Pass

### 802.11n (HT40)

Channel	Frequency (MHz)	Average Power (dBm)		Total Power (mW)	Total Power (dBm)	Limit (dBm)	Pass / Fail
		Chain 0	Chain 1				
3	2422	8.30	9.62	15.923	12.02	30	Pass
6	2437	8.25	9.70	16.016	12.05	30	Pass
9	2452	8.46	9.83	16.631	12.21	30	Pass



## 4.5 Power Spectral Density Measurement

### 4.5.1 Limits of Power Spectral Density Measurement

The Maximum of Power Spectral Density Measurement is 8 dBm in any 3 kHz band during any time interval of continuous transmission.

### 4.5.2 Test Setup

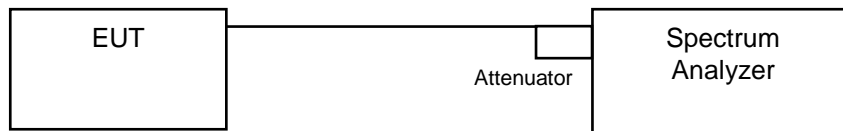

### 4.5.3 Test Instruments

Refer to section 4.1.2 to get information of above instrument.

### 4.5.4 Test Procedure

- a. Set analyzer center frequency to DTS channel center frequency.
- b. Set the span to 1.5 times the DTS bandwidth.
- c. Set the RBW to:  $3 \text{ kHz} \leq \text{RBW} \leq 100 \text{ kHz}$ .
- d. Set the VBW  $\geq 3 \times \text{RBW}$ .
- e. Detector = peak.
- f. Sweep time = auto couple.
- g. Trace mode = max hold.
- h. Allow trace to fully stabilize.
- i. Use the peak marker function to determine the maximum amplitude level within the RBW.

### 4.5.5 Deviation from Test Standard

No deviation.

### 4.5.6 EUT Operating Condition

The software provided by client to enable the EUT under transmission condition continuously at lowest, middle and highest channel frequencies individually.

#### 4.5.7 Test Results

##### 802.11b

TX Chain	Channel	Freq. (MHz)	PSD (dBm/3 kHz)	10 log (N=2) dB	Total PSD (dBm/3 kHz)	Limit (dBm/3 kHz)	Pass / Fail
0	1	2412	-10.05	3.01	-7.04	7.83	Pass
	6	2437	-10.80	3.01	-7.79	7.83	Pass
	11	2462	-10.53	3.01	-7.52	7.83	Pass
1	1	2412	-8.46	3.01	-5.45	7.83	Pass
	6	2437	-9.13	3.01	-6.12	7.83	Pass
	11	2462	-8.66	3.01	-5.65	7.83	Pass

**NOTE:**

1. Directional gain =  $10\log[(10G1/20 + 10G2/20 + \dots + 10GN/20)^2 / NANT] = 6.17 \text{ dBi} > 6 \text{ dBi}$ , so the power density limit shall be reduced to  $8-(6.17-6) = 7.83 \text{ dBm}$ .
2. Method 2) C) of power density measurement of KDB 662911 is using for calculating total power density.

##### 802.11g

TX Chain	Channel	Freq. (MHz)	PSD (dBm/3 kHz)	10 log (N=2) dB	Total PSD (dBm/3 kHz)	Limit (dBm/3 kHz)	Pass / Fail
0	1	2412	-11.41	3.01	-8.40	7.83	Pass
	6	2437	-10.74	3.01	-7.73	7.83	Pass
	11	2462	-11.85	3.01	-8.84	7.83	Pass
1	1	2412	-10.13	3.01	-7.12	7.83	Pass
	6	2437	-9.89	3.01	-6.88	7.83	Pass
	11	2462	-11.01	3.01	-8.00	7.83	Pass

**NOTE:**

1. Directional gain =  $10\log[(10G1/20 + 10G2/20 + \dots + 10GN/20)^2 / NANT] = 6.17 \text{ dBi} > 6 \text{ dBi}$ , so the power density limit shall be reduced to  $8-(6.17-6) = 7.83 \text{ dBm}$ .
2. Method E) 2) c) of power density measurement of KDB 662911 is using for calculating total power density.

### 802.11n (HT20)

TX Chain	Channel	Freq. (MHz)	PSD (dBm/3 kHz)	10 log (N=2) dB	Total PSD (dBm/3 kHz)	Limit (dBm/3 kHz)	Pass / Fail
0	1	2412	-12.66	3.01	-9.65	7.83	Pass
	6	2437	-12.54	3.01	-9.53	7.83	Pass
	11	2462	-13.13	3.01	-10.12	7.83	Pass
1	1	2412	-10.79	3.01	-7.78	7.83	Pass
	6	2437	-10.83	3.01	-7.82	7.83	Pass
	11	2462	-10.91	3.01	-7.90	7.83	Pass

**NOTE:**

1. Directional gain =  $10\log[(10^{G1/20} + 10^{G2/20} + \dots + 10^{GN/20})^2 / N_{ANT}] = 6.17 \text{ dBi} > 6 \text{ dBi}$ , so the power density limit shall be reduced to  $8 - (6.17 - 6) = 7.83 \text{ dBm}$ .
2. Method E) 2) c) of power density measurement of KDB 662911 is using for calculating total power density.

### 802.11n (HT40)

TX Chain	Channel	Freq. (MHz)	PSD (dBm/3 kHz)	10 log (N=2) dB	Total PSD (dBm/3 kHz)	Limit (dBm/3 kHz)	Pass / Fail
0	3	2422	-15.71	3.01	-12.70	7.83	Pass
	6	2437	-16.49	3.01	-13.48	7.83	Pass
	9	2452	-19.16	3.01	-16.15	7.83	Pass
1	3	2422	-13.79	3.01	-10.78	7.83	Pass
	6	2437	-13.79	3.01	-10.78	7.83	Pass
	9	2452	-15.97	3.01	-12.96	7.83	Pass

**NOTE:**

1. Directional gain =  $10\log[(10^{G1/20} + 10^{G2/20} + \dots + 10^{GN/20})^2 / N_{ANT}] = 6.17 \text{ dBi} > 6 \text{ dBi}$ , so the power density limit shall be reduced to  $8 - (6.17 - 6) = 7.83 \text{ dBm}$ .
2. Method E) 2) c) of power density measurement of KDB 662911 is using for calculating total power density.

### Spectrum Plot of Worst Value

#### 802.11b

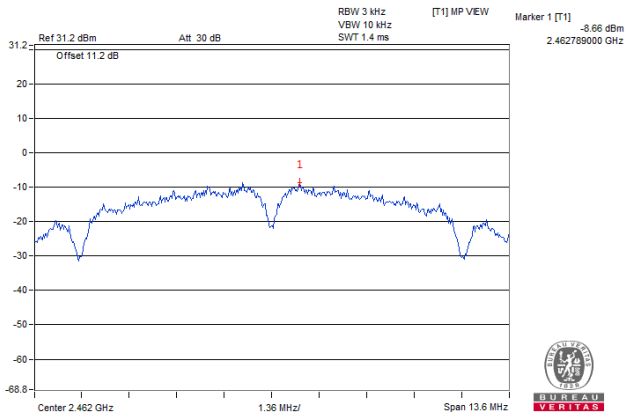

#### 802.11g

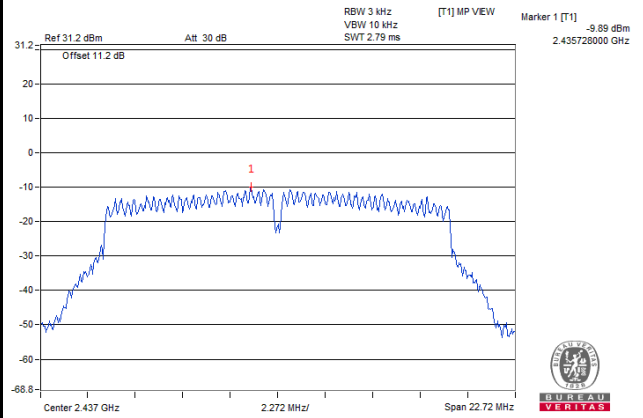

#### 802.11n (HT20)

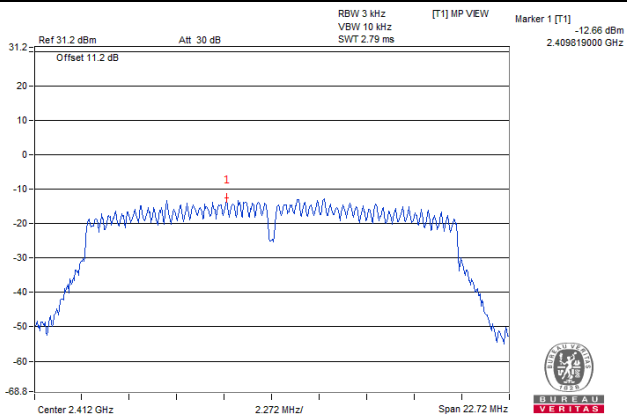

#### 802.11n (HT40)

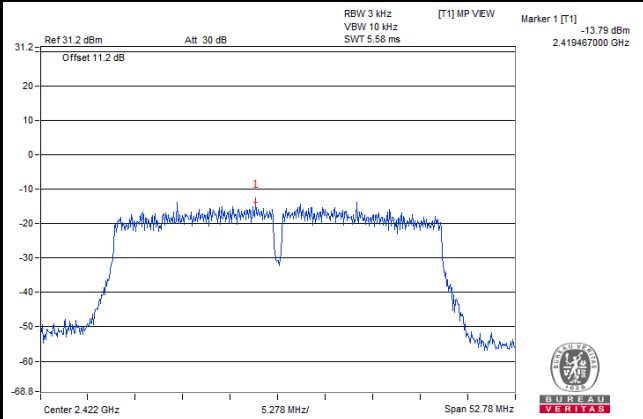

## 4.6 Conducted Out of Band Emission Measurement

### 4.6.1 Limits of Conducted Out of Band Emission Measurement

Below -20 dB of the highest emission level of operating band (in 100 kHz Resolution Bandwidth).

### 4.6.2 Test Setup

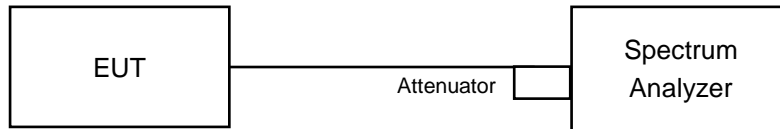

### 4.6.3 Test Instruments

Refer to section 4.1.2 to get information of above instrument.

### 4.6.4 Test Procedure

#### MEASUREMENT PROCEDURE REF

1. Set the RBW = 100 kHz.
2. Set the VBW  $\geq$  300 kHz.
3. Detector = peak.
4. Sweep time = auto couple.
5. Trace mode = max hold.
6. Allow trace to fully stabilize.
7. Use the peak marker function to determine the maximum power level in any 100 kHz band segment within the fundamental EBW.

#### MEASUREMENT PROCEDURE OOB

1. Set RBW = 100 kHz.
2. Set VBW  $\geq$  300 kHz.
3. Detector = peak.
4. Sweep = auto couple.
5. Trace Mode = max hold.
6. Allow trace to fully stabilize.
7. Use the peak marker function to determine the maximum amplitude level.

### 4.6.5 Deviation from Test Standard

No deviation.

### 4.6.6 EUT Operating Condition

The software provided by client to enable the EUT under transmission condition continuously at lowest, middle and highest channel frequencies individually.

### 4.6.7 Test Results

The conducted emission test is performed on each TX port of operating mode without summing or adding 10log (N) since the limit is relative emission limit.

The spectrum plots are attached on the following images. D1 line indicates the highest level, and D2 line indicates the 20 dB offset below D1. It shows compliance with the requirement.

#### 802.11b CHAIN 0

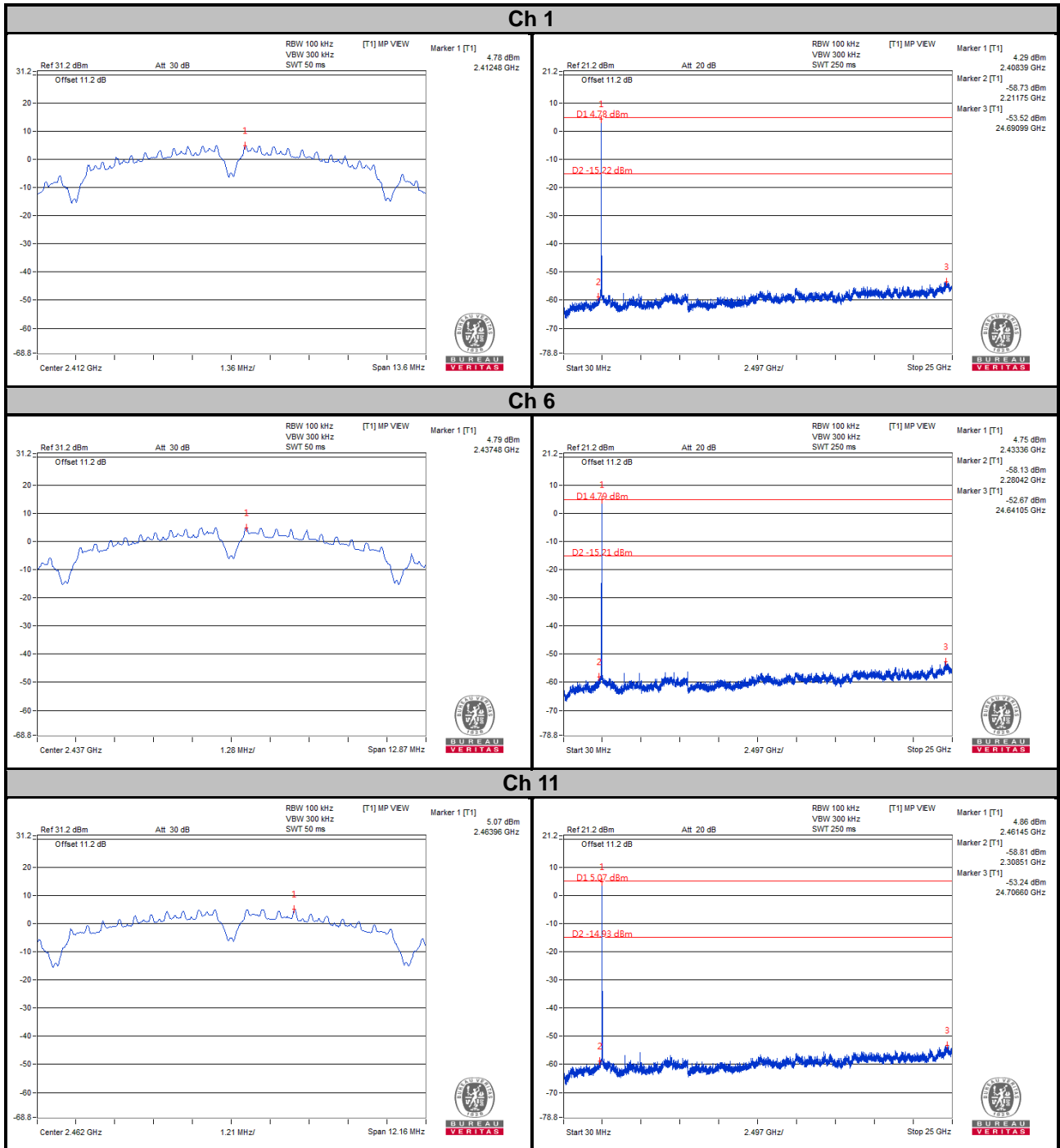

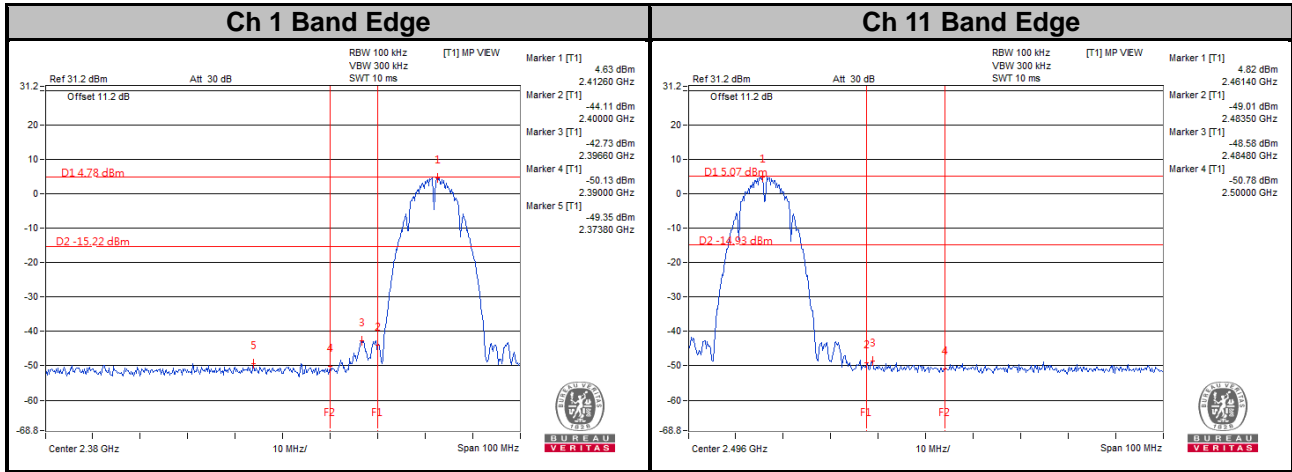

CHAIN 1

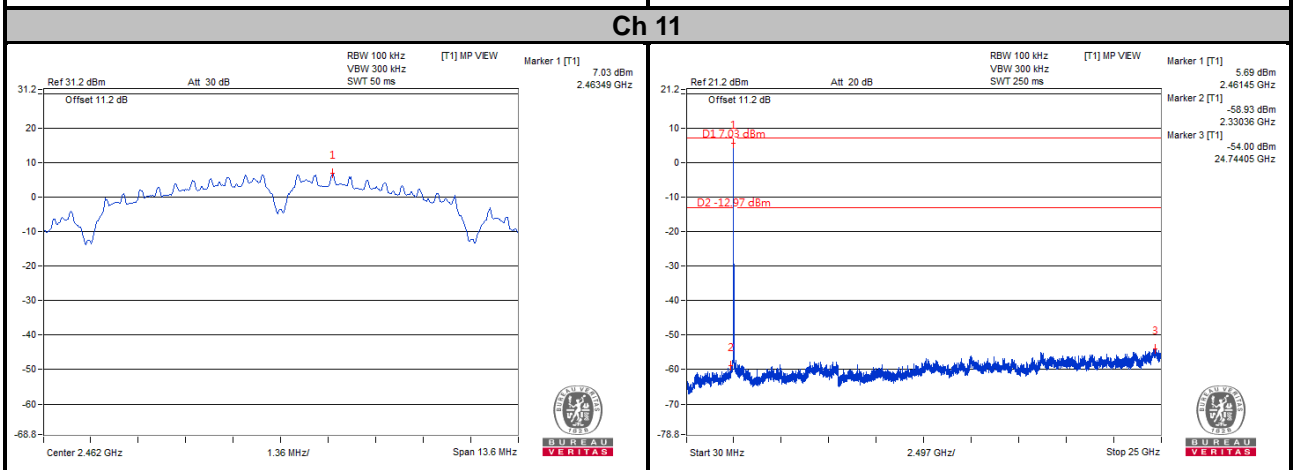
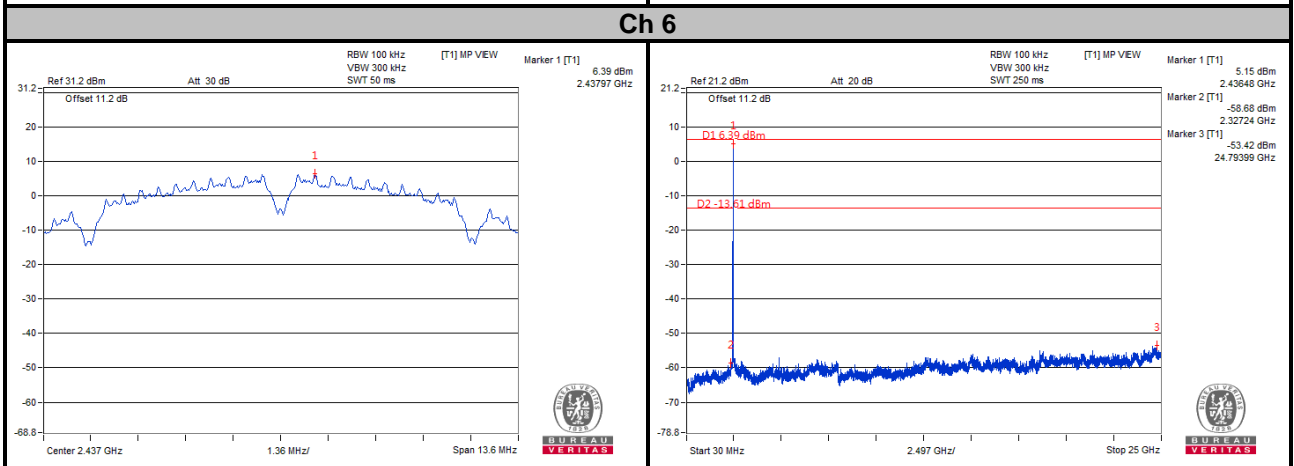
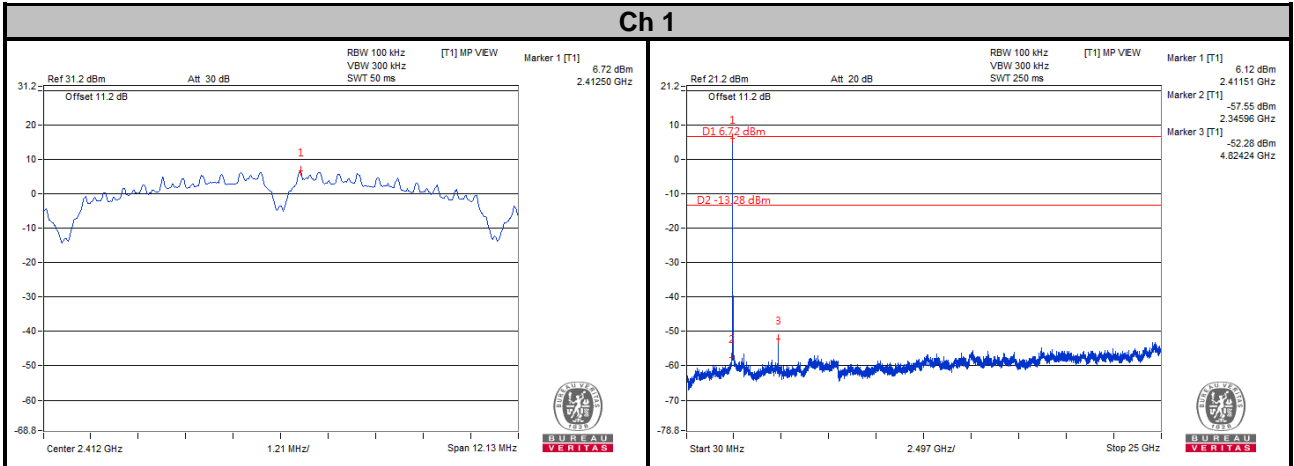



### Ch 1 Band Edge

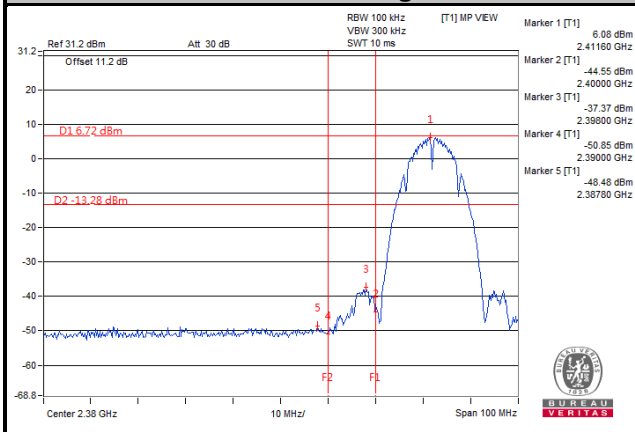

### Ch 11 Band Edge

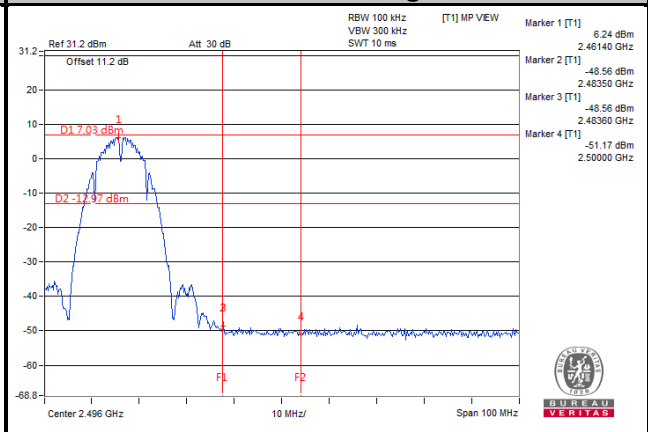

802.11g  
CHAIN 0

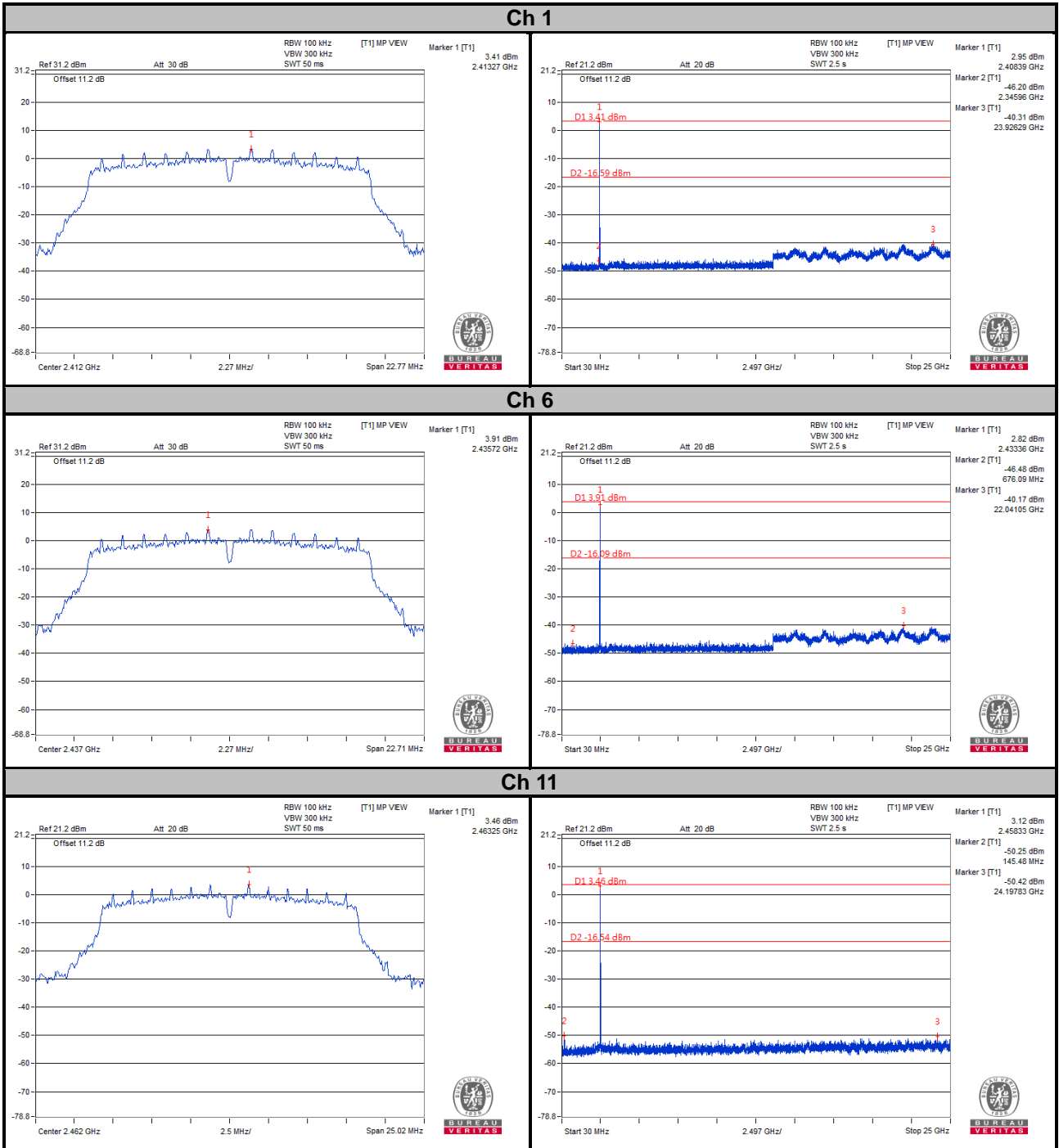

### Ch 1 Band Edge

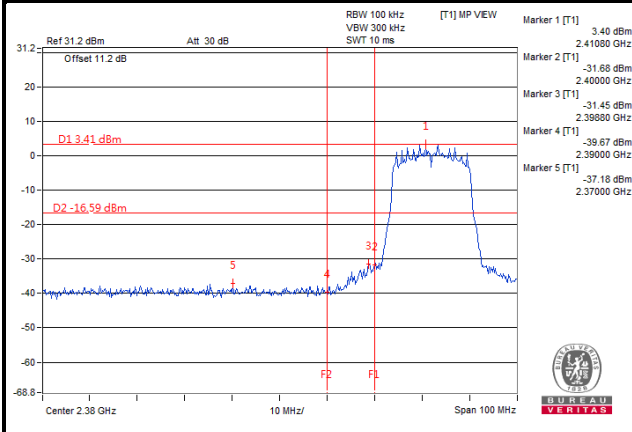

### Ch 11 Band Edge

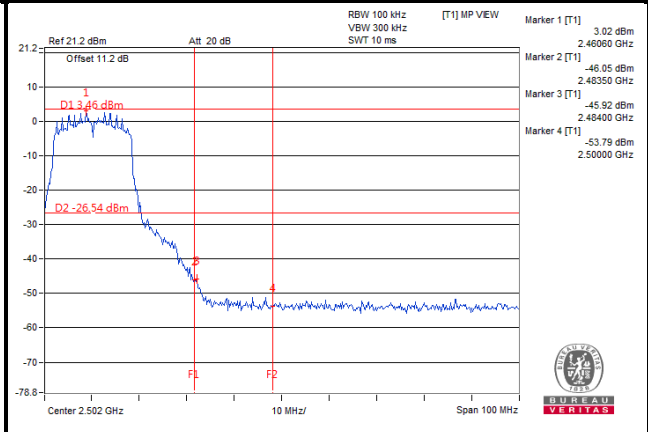

# CHAIN 1

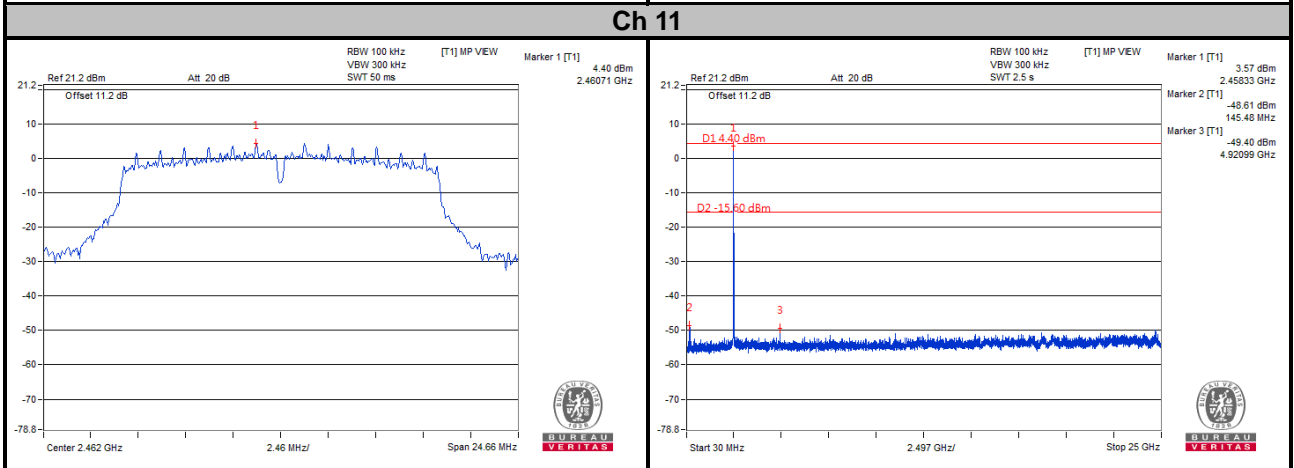
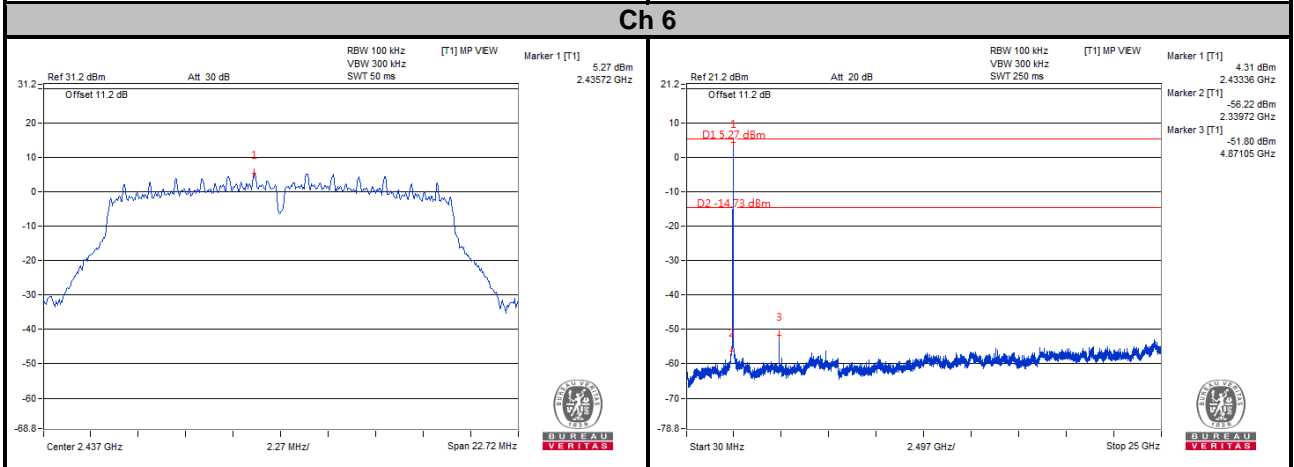
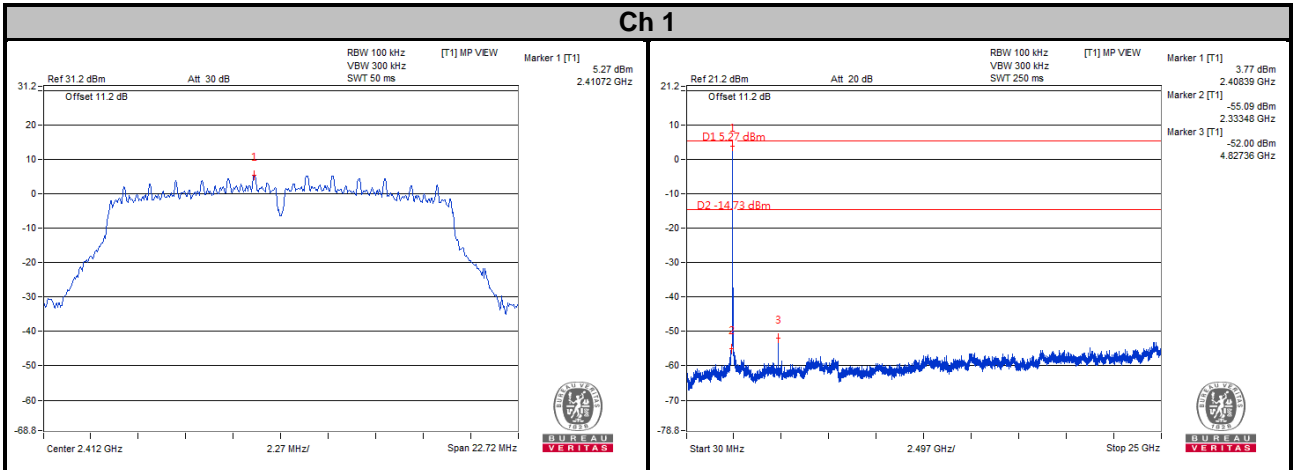

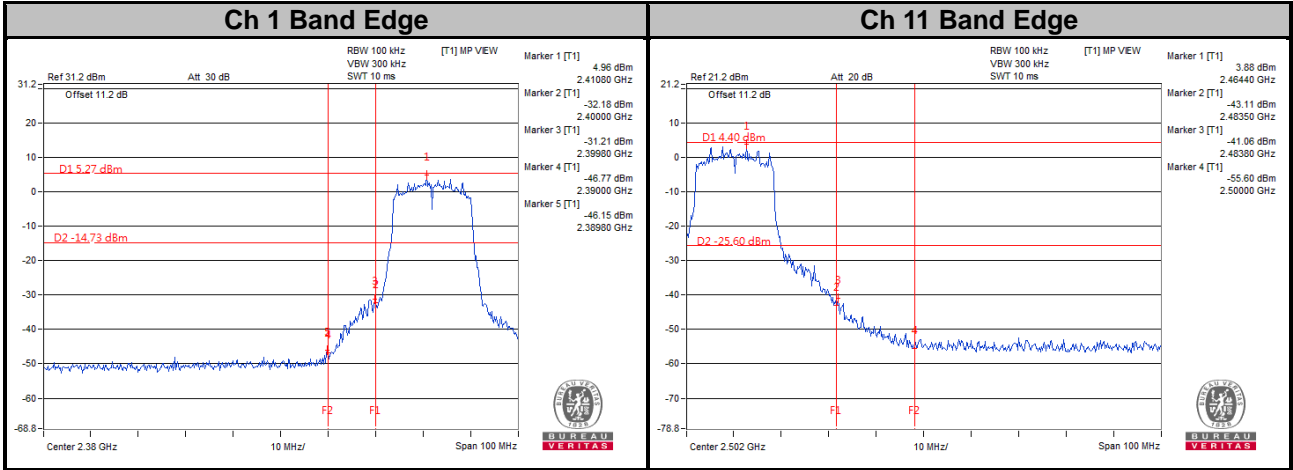

802.11n (HT20)  
CHAIN 0

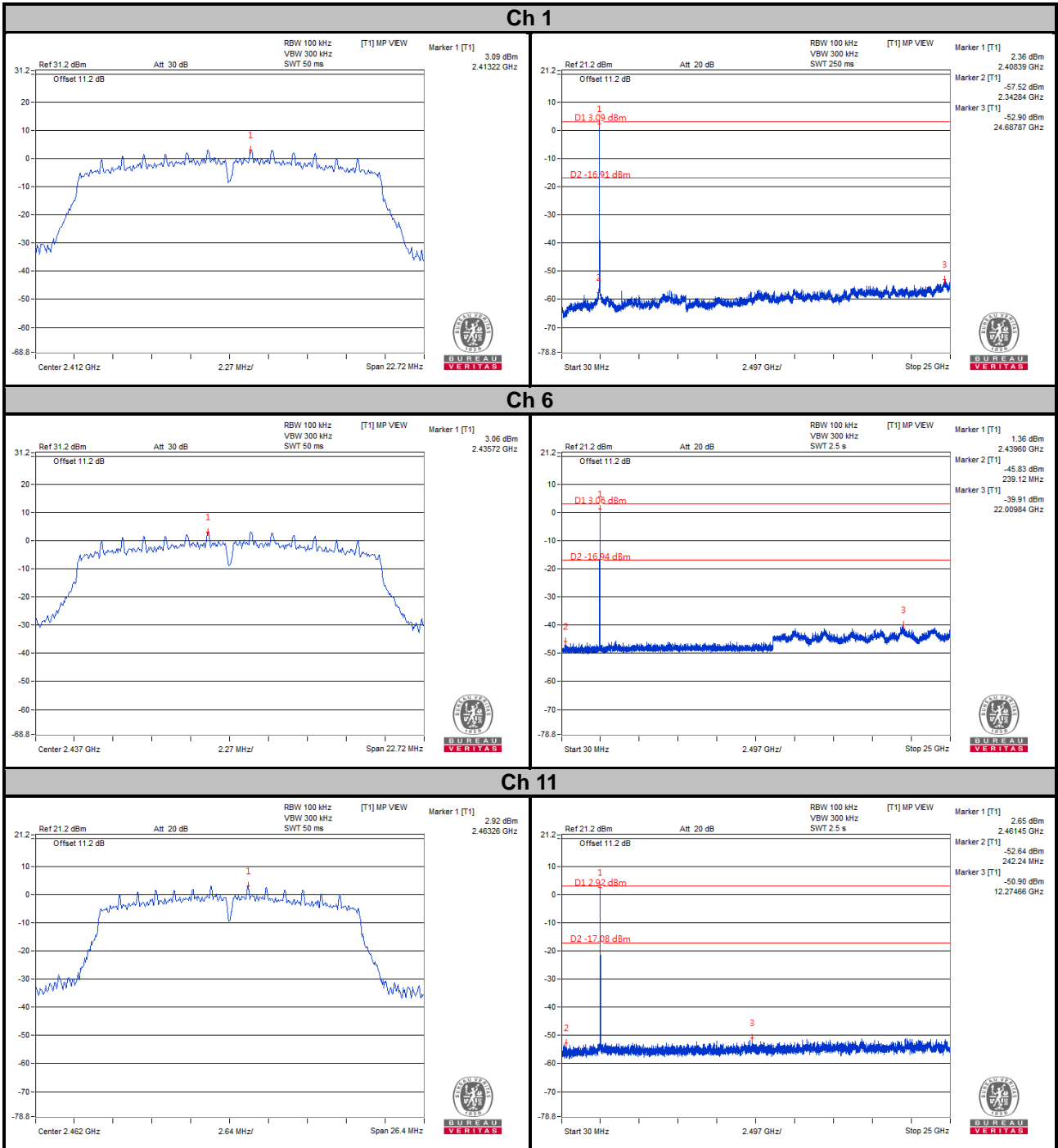

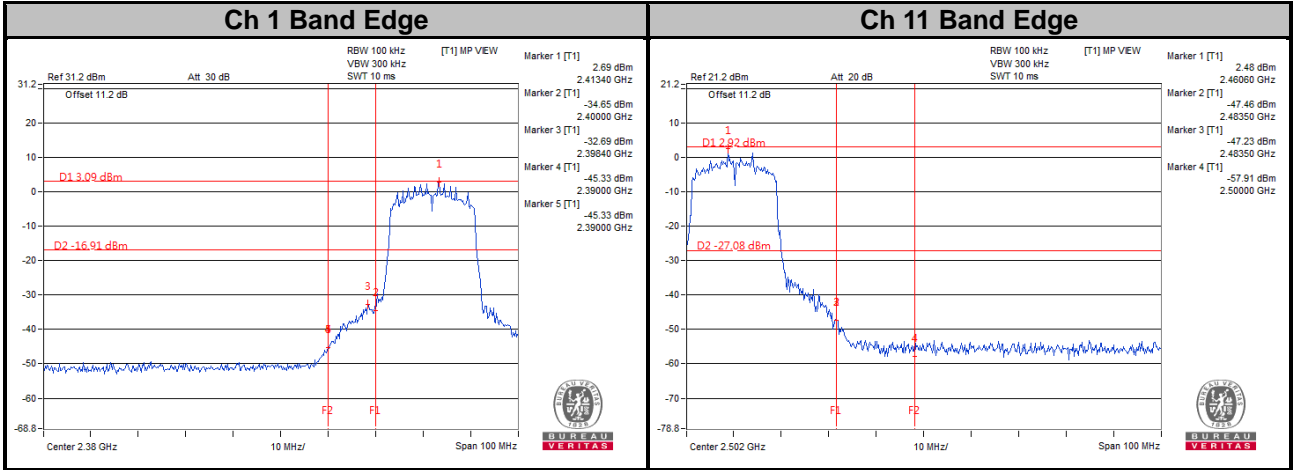

CHAIN 1

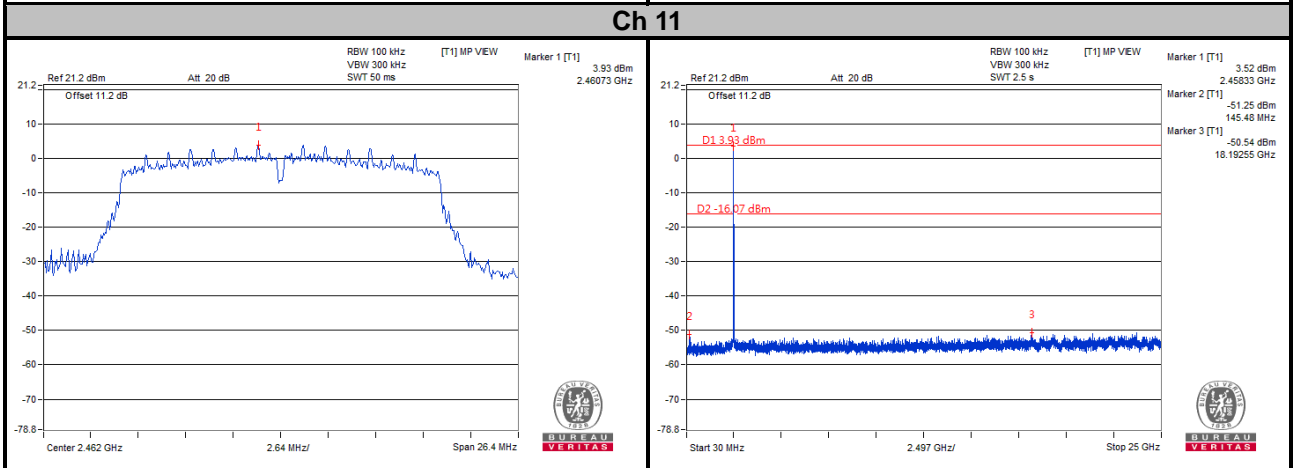
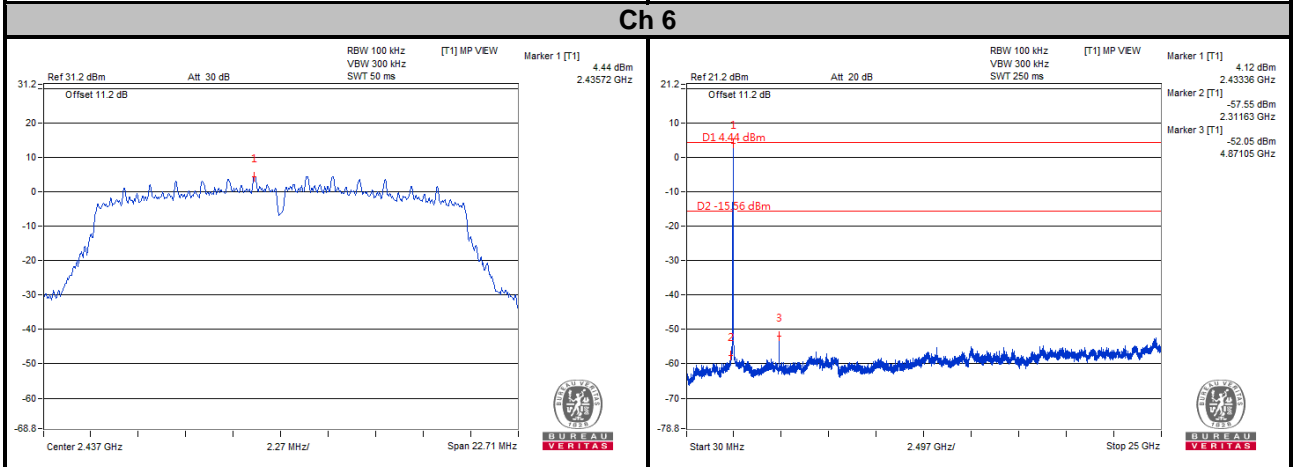
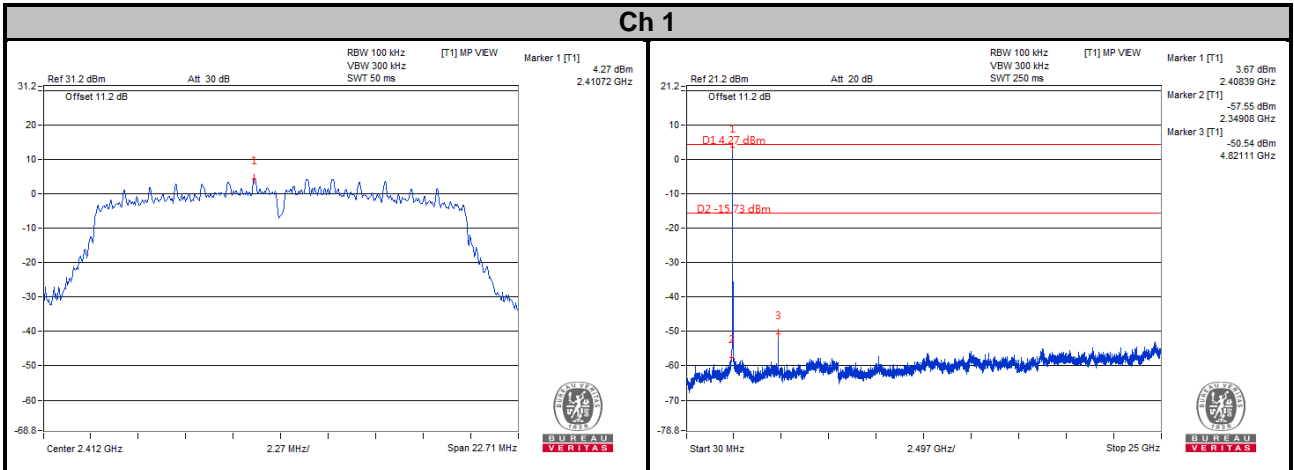



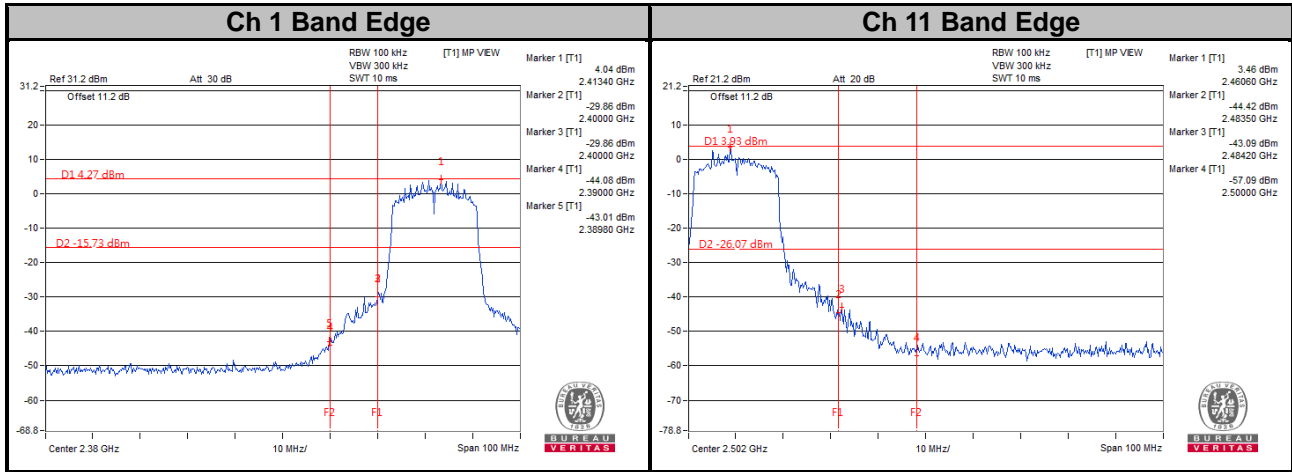

802.11n (HT40)  
CHAIN 0

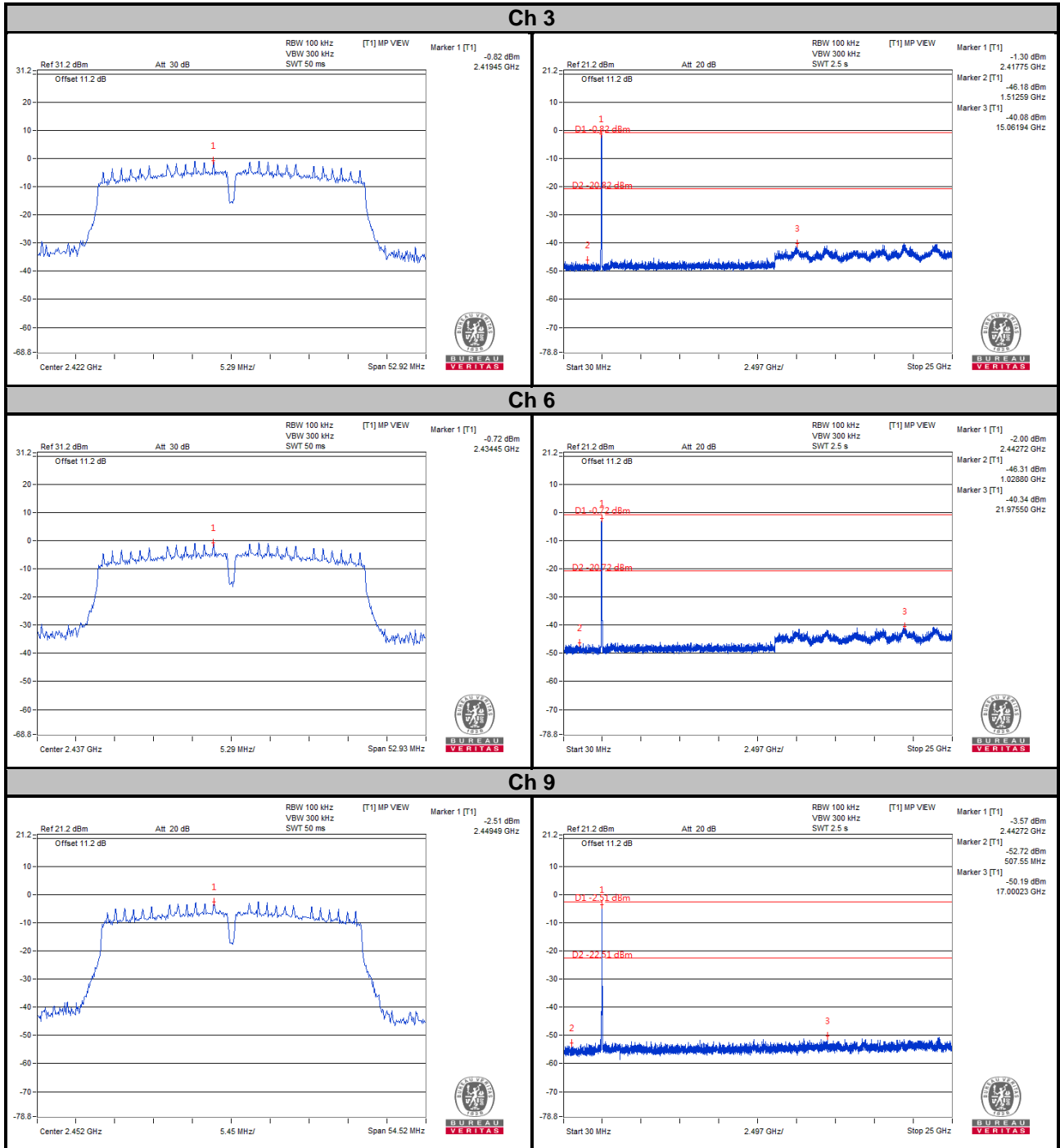

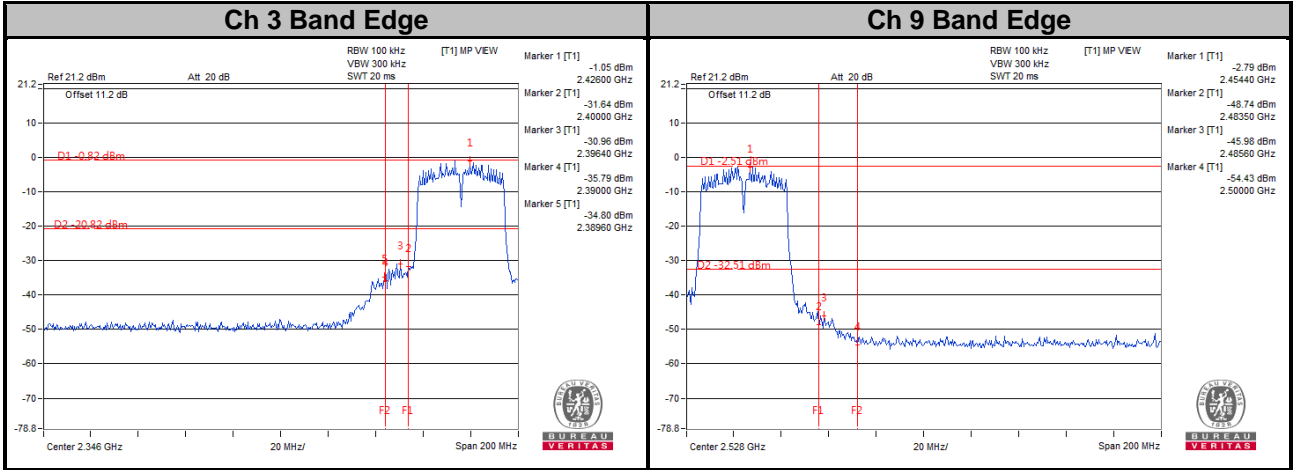

# CHAIN 1

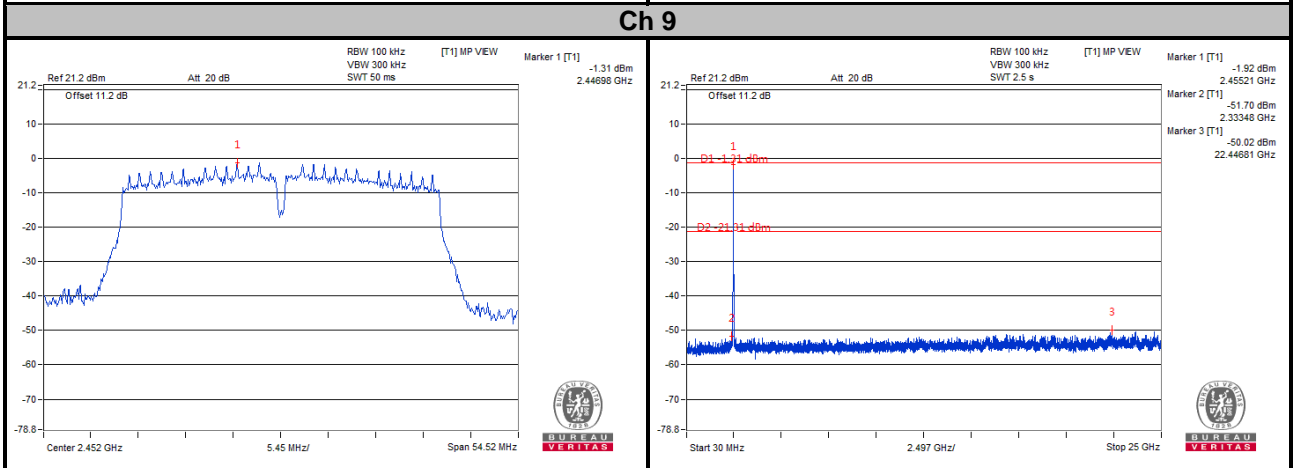
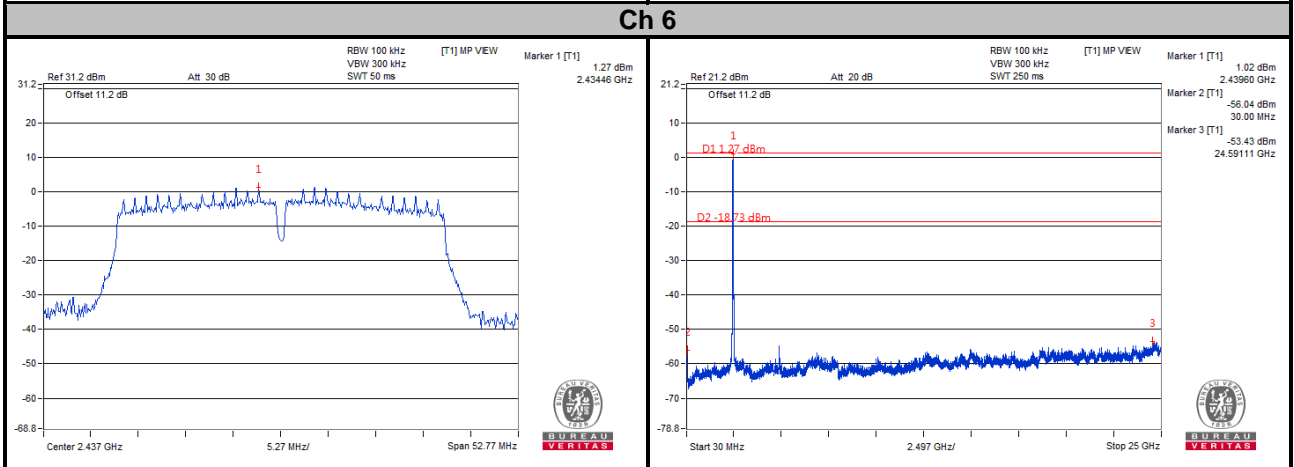
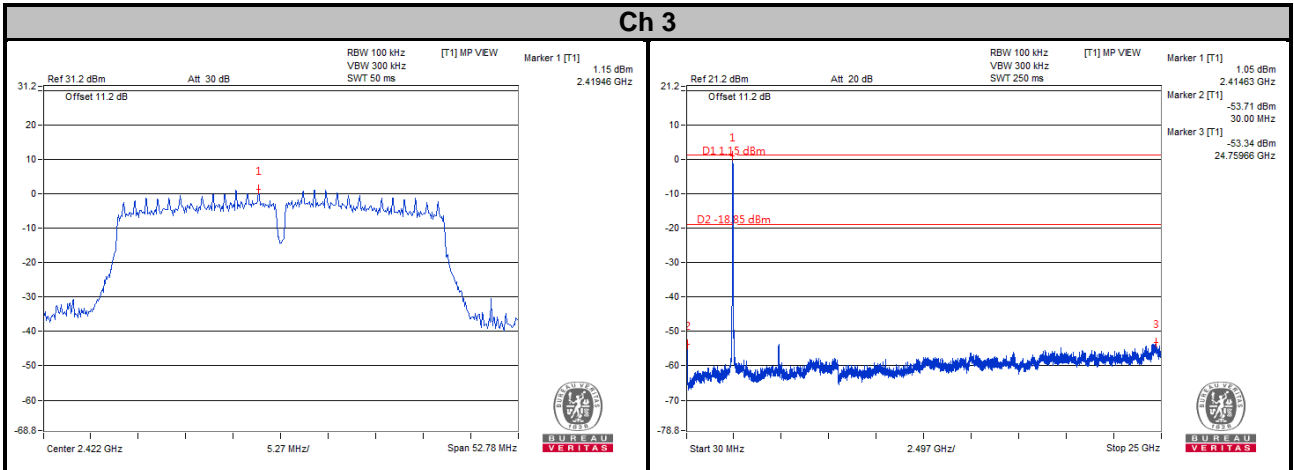

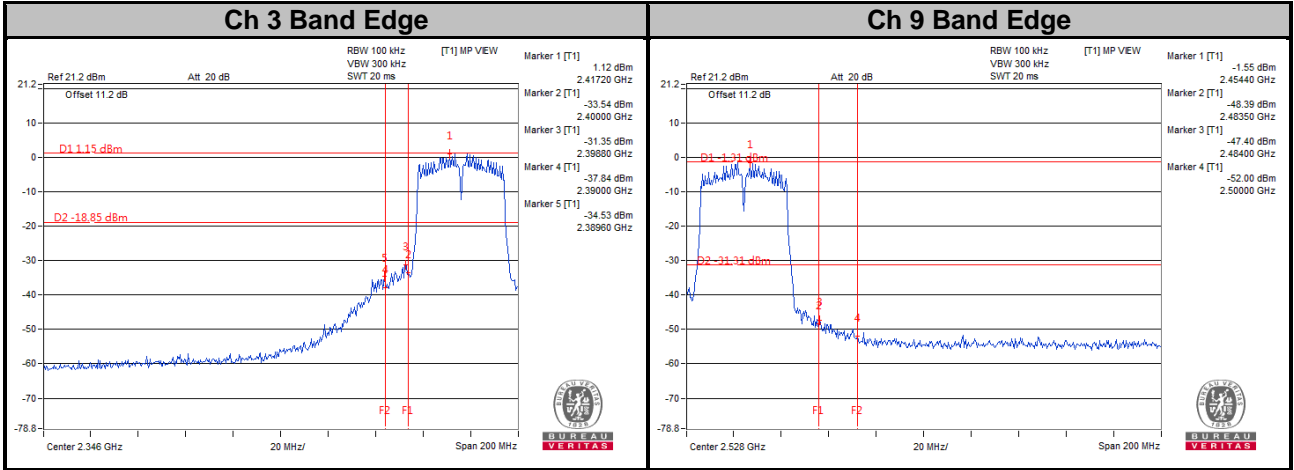

## 5 Pictures of Test Arrangements

Please refer to the attached file (Test Setup Photo).

## Appendix – Information of the Testing Laboratories

We, Bureau Veritas Consumer Products Services (H.K.) Ltd., Taoyuan Branch, were founded in 1988 to provide our best service in EMC, Radio, Telecom and Safety consultation. Our laboratories are FCC recognized accredited test firms and accredited according to ISO/IEC 17025.

If you have any comments, please feel free to contact us at the following:

**Lin Kou EMC/RF Lab**

Tel: 886-2-26052180

Fax: 886-2-26051924

**Hsin Chu EMC/RF/Telecom Lab**

Tel: 886-3-6668565

Fax: 886-3-6668323

**Hwa Ya EMC/RF/Safety Lab**

Tel: 886-3-3183232

Fax: 886-3-3270892

**Email:** [service.adt@tw.bureauveritas.com](mailto:service.adt@tw.bureauveritas.com)

**Web Site:** [www.bureauveritas-adt.com](http://www.bureauveritas-adt.com)

The address and road map of all our labs can be found in our web site also.

--- END ---