



FCC Radio Test Report

FCC ID:RWO-RZ090510

This report concerns: Class II Permissive Changes

Project No. : 2309C132
Equipment : Notebook PC
Brand Name : RAZER
Test Model : RZ09-0510
Series Model : N/A
Applicant : Razer Inc.
Address : 9 Pasteur, Suite 100, Irvine, CA92618, USA.
Manufacturer : Razer Inc.
Address : 9 Pasteur, Suite 100, Irvine, CA92618, USA.
Date of Receipt : Oct. 17, 2023
Date of Test : Dec. 13, 2023 ~ Dec. 18, 2023
Issued Date : Dec. 19, 2023
Report Version : R00
Test Sample : Sample No.: DG2023101721
Standard(s) : FCC CFR Title 47, Part 15, Subpart E
*FCC KDB 789033 D02 General UNII Test Procedures New Rules v02r01
*FCC KDB 662911 D01 Multiple Transmitter Output v02r01
ANSI C63.10-2013

The above equipment has been tested and found compliance with the requirement of the relative standards by BTL Inc.

The standards "*" is not authorized within the scope of NVLAP.

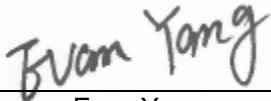
Prepared by : 
Evan Yang

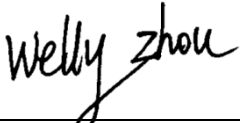
Approved by : 
Welly Zhou

Room 108, Building 2, No. 1, Yile Road, Songshan Lake Zone, Dongguan City, Guangdong 523000 China.

Tel: +86-769-8318-3000 Web: www.newbtl.com Service mail: btl_qa@newbtl.com

Declaration

BTL represents to the client that testing is done in accordance with standard procedures as applicable and that test instruments used has been calibrated with standards traceable to international standard(s) and/or national standard(s).

BTL's reports apply only to the specific samples tested under conditions. It is manufacture's responsibility to ensure that additional production units of this model are manufactured with the identical electrical and mechanical components. **BTL** shall have no liability for any declarations, inferences or generalizations drawn by the client or others from **BTL** issued reports.

The report must not be used by the client to claim product certification, approval, or endorsement by NVLAP, NIST, or any agency of the U.S. Government.

This report is the confidential property of the client. As a mutual protection to the clients, the public and ourselves, the test report shall not be reproduced, except in full, without our written approval.

BTL's laboratory quality assurance procedures are in compliance with the ISO/IEC 17025: 2017 requirements, and accredited by the conformity assessment authorities listed in this test report.

BTL is not responsible for the sampling stage, so the results only apply to the sample as received.

The information, data and test plan are provided by manufacturer which may affect the validity of results, so it is manufacturer's responsibility to ensure that the apparatus meets the essential requirements of applied standards and in all the possible configurations as representative of its intended use.

Limitation

For the use of the authority's logo is limited unless the Test Standard(s)/Scope(s)/Item(s) mentioned in this test report is (are) included in the conformity assessment authorities acceptance respective.

Please note that the measurement uncertainty is provided for informational purpose only and are not use in determining the Pass/Fail results.

Table of Contents	Page
REPORT ISSUED HISTORY	4
1 . SUMMARY OF TEST RESULTS	5
1.1 TEST FACILITY	6
1.2 MEASUREMENT UNCERTAINTY	6
1.3 TEST ENVIRONMENT CONDITIONS	6
2 . GENERAL INFORMATION	7
2.1 GENERAL DESCRIPTION OF EUT	7
2.2 TEST MODES	10
2.3 BLOCK DIAGRAM SHOWING THE CONFIGURATION OF SYSTEM TESTED	11
2.4 SUPPORT UNITS	11
3 . AC POWER LINE CONDUCTED EMISSIONS	12
3.1 LIMIT	12
3.2 TEST PROCEDURE	12
3.3 DEVIATION FROM TEST STANDARD	12
3.4 TEST SETUP	13
3.5 EUT OPERATION CONDITIONS	13
3.6 TEST RESULTS	13
4 . RADIATED EMISSIONS	14
4.1 LIMIT	14
4.2 TEST PROCEDURE	15
4.3 DEVIATION FROM TEST STANDARD	16
4.4 TEST SETUP	16
4.5 EUT OPERATION CONDITIONS	17
4.6 TEST RESULTS - 9 KHZ TO 30 MHZ	17
4.7 TEST RESULTS - 30 MHZ TO 1000 MHZ	17
4.8 TEST RESULTS - ABOVE 1000 MHZ	17
5 . MEASUREMENT INSTRUMENTS LIST	18
APPENDIX A - AC POWER LINE CONDUCTED EMISSIONS	20
APPENDIX B - RADIATED EMISSION - 9 KHZ TO 30 MHZ	23
APPENDIX C - RADIATED EMISSION - 30 MHZ TO 1000 MHZ	28
APPENDIX D - RADIATED EMISSION - ABOVE 1000 MHZ	31

REPORT ISSUED HISTORY

Report No.	Version	Description	Issued Date	Note
BTL-FCCP-4-2309C132	R00	Original Report.	Dec. 19, 2023	Valid

1. SUMMARY OF TEST RESULTS

Test procedures according to the technical standard(s):

FCC CFR Title 47, Part 15, Subpart E				
Standard(s) Section	Test Item	Test Result	Judgment	Remark
15.207 15.407(b)	AC Power Line Conducted Emissions	APPENDIX A	PASS	-----
15.407(b) 15.205(a) 15.209(a)	Radiated Emissions	APPENDIX B APPENDIX C APPENDIX D	PASS	-----
15.407(a) 15.407(e)	Bandwidth	-----	PASS	Note(5)
15.407(a)	Maximum Output Power	-----	PASS	Note(5)
15.407(a)	Power Spectral Density	-----	PASS	Note(5)
15.407(g)	Frequency Stability	-----	PASS	Note(5)
15.203	Antenna Requirements	-----	PASS	NOTE (2)
15.407(c)	Automatically Discontinue Transmission	-----	PASS	NOTE (3)

Note:

- (1) "N/A" denotes test is not applicable in this test report.
- (2) The device what use a permanently attached antenna were considered sufficient to comply with the provisions of 15.203.
- (3) During no any information transmission, the EUT can automatically discontinue transmission and become standby mode for power saving. the EUT can detect the controlling signal of ACK message transmitting from remote device and verify whether it shall resend or discontinue transmission.
- (4) For UNII-1 this device was functioned as a
 - Outdoor access point device
 - Indoor access point device
 - Fixed point-to-point access points device
 - Client device
- (5) The antenna gain of EUT is smaller than that of the module. So in this report the worst cases of radiated spurious emissions and AC Power Line Conducted Emissions were evaluated and recorded. For the test results of all other test items please refer to module test reports.

1.1 TEST FACILITY

The test facilities used to collect the test data in this report is at the location of No. 3 Jinshagang 1st Rd. Shixia, Dalang Town, Dongguan City, Guangdong 523792

BTL's Registration Number for FCC: 162128

BTL's Designation Number for FCC: CN5042

1.2 MEASUREMENT UNCERTAINTY

ISO/IEC 17025 requires that an estimate of the measurement uncertainties associated with the emissions test results be included in the report. The measurement uncertainties given below are based on a 95.45% confidence level (based on a coverage factor (k=2))

The BTL measurement uncertainty as below table:

A. AC power line conducted emissions test:

Test Site	Method	Measurement Frequency Range	U,(dB)
DG-C02	CISPR	150kHz ~ 30MHz	2.88

B. Radiated emissions test:

Test Site	Method	Measurement Frequency Range	U,(dB)
DG-CB01	CISPR	9kHz ~ 30MHz	2.36

Test Site	Method	Measurement Frequency Range	Ant. H / V	U,(dB)
DG-CB03 (3m)	CISPR	30MHz ~ 200MHz	V	4.40
		30MHz ~ 200MHz	H	3.62
		200MHz ~ 1,000MHz	V	4.58
		200MHz ~ 1,000MHz	H	3.98

Test Site	Method	Measurement Frequency Range	U,(dB)
DG-CB03 (3m)	CISPR	1GHz ~ 6GHz	4.08
		6GHz ~ 18GHz	4.62

Test Site	Method	Measurement Frequency Range	U,(dB)
DG-CB03 (1m)	CISPR	18 ~ 26.5 GHz	3.36
		26.5 ~ 40 GHz	3.58

Note: Unless specifically mentioned, the uncertainty of measurement has not been taken into account to declare the compliance or non-compliance to the specification.

1.3 TEST ENVIRONMENT CONDITIONS

Test Item	Temperature	Humidity	Test Voltage	Tested By
AC Power Line Conducted Emissions	24°C	58%	AC 120V/60Hz	Hayden Chen
Radiated Emissions-9kHz to 30MHz	22°C	48%	AC 120V/60Hz	Hayden Chen
Radiated Emissions-30MHz to 1000MHz	23°C	45%	AC 120V/60Hz	Max Wang
Radiated Emissions-Above 1000 MHz	23~24°C	44~45%	AC 120V/60Hz	Max Wang

2. GENERAL INFORMATION

2.1 GENERAL DESCRIPTION OF EUT

Equipment	Notebook PC
Brand Name	RAZER
Test Model	RZ09-0510
Series Model	N/A
Model Difference(s)	N/A
Software Version	Windows 11
Hardware Version	APF22002_MB
Power Source	1# DC voltage supplied from AC adapter. Model 1: RC30-042 Model 2: RC30-0484 2# Supplied from battery. Model: RC30-0483
Power Rating	1# Model 1: I/P: 100-240V~ 4A MAX 50/60Hz O/P: 19.5V===14.36A Model 2: I/P: 100-240V~ 4.5A 50/60Hz O/P: 19.5V===16.92A 2# DC 15.4V 6182mAh 95.2Wh
Operation Frequency Band(s)	UNII-1: 5150 MHz ~ 5250 MHz UNII-2A: 5250 MHz ~ 5350 MHz UNII-2C: 5470 MHz ~ 5725 MHz UNII-3: 5725 MHz ~ 5850 MHz
Modulation Type	IEEE 802.11a/n/ac: OFDM IEEE 802.11ax/be: OFDMA
Bit Rate of Transmitter	IEEE 802.11a: 54/48/36/24/18/12/9/6 Mbps IEEE 802.11n: up to 300 Mbps IEEE 802.11ac: up to 1733.3 Mbps IEEE 802.11ax: up to 2402 Mbps IEEE 802.11be: up to 2882 Mbps

Note:

1. For a more detailed features description, please refer to the manufacturer's specifications or the user's manual.

2. Channel List:

IEEE 802.11a IEEE 802.11n(HT20) IEEE 802.11ac(VHT20) IEEE 802.11ax(HE20) IEEE 802.11be(EHT20)		IEEE 802.11n(HT40) IEEE 802.11ac(VHT40) IEEE 802.11ax(HE40) IEEE 802.11be(EHT40)		IEEE 802.11ac(VHT80) IEEE 802.11ax(HE80) IEEE 802.11be(EHT80)	
UNII-1		UNII-1		UNII-1	
Channel	Frequency (MHz)	Channel	Frequency (MHz)	Channel	Frequency (MHz)
36	5180	38	5190	42	5210
40	5200	46	5230		
44	5220				
48	5240				

IEEE 802.11a IEEE 802.11n(HT20) IEEE 802.11ac(VHT20) IEEE 802.11ax(HE20) IEEE 802.11be(EHT20)		IEEE 802.11n(HT40) IEEE 802.11ac(VHT40) IEEE 802.11ax(HE40) IEEE 802.11be(EHT40)		IEEE 802.11ac(VHT80) IEEE 802.11ax(HE80) IEEE 802.11be(EHT80)	
UNII-2A		UNII-2A		UNII-2A	
Channel	Frequency (MHz)	Channel	Frequency (MHz)	Channel	Frequency (MHz)
52	5260	54	5270	58	5290
56	5280	62	5310		
60	5300				
64	5320				

IEEE 802.11a IEEE 802.11n(HT20) IEEE 802.11ac(VHT20) IEEE 802.11ax(HE20) IEEE 802.11be(EHT20)		IEEE 802.11n(HT40) IEEE 802.11ac(VHT40) IEEE 802.11ax(HE40) IEEE 802.11be(EHT40)		IEEE 802.11ac(VHT80) IEEE 802.11ax(HE80) IEEE 802.11be(EHT80)	
UNII-2C		UNII-2C		UNII-2C	
Channel	Frequency (MHz)	Channel	Frequency (MHz)	Channel	Frequency (MHz)
100	5500	102	5510	106	5530
104	5520	110	5550	122	5610
108	5540	118	5590		
112	5560	126	5630		
116	5580	134	5670		
120	5600				
124	5620				
128	5640				
132	5660				
136	5680				
140	5700				

IEEE 802.11a IEEE 802.11n(HT20) IEEE 802.11ac(VHT20) IEEE 802.11ax(HE20) IEEE 802.11be(EHT20)		IEEE 802.11n(HT40) IEEE 802.11ac(VHT40) IEEE 802.11ax(HE40) IEEE 802.11be(EHT40)		IEEE 802.11ac(VHT80) IEEE 802.11ax(HE80) IEEE 802.11be(EHT80)	
UNII-3		UNII-3		UNII-3	
Channel	Frequency (MHz)	Channel	Frequency (MHz)	Channel	Frequency (MHz)
149	5745	151	5755	155	5775
153	5765	159	5795		
157	5785				
161	5805				
165	5825				

IEEE 802.11ac(VHT160) IEEE 802.11ax(HE160) IEEE 802.11be(EHT160)	
Channel	Frequency (MHz)
50	5250
114	5570

3. Antenna Specification:

Ant.	Manufacturer	P/N	Antenna Type	Connector	Gain (dBi)
1	Amphenol Taiwan Corporation	BY510A-15-001-C	PIFA	Coaxial	3.67
2	Amphenol Taiwan Corporation	BY510A-15-001-C	PIFA	Coaxial	3.77

Note:

- 1) This EUT supports MIMO 2X2(Except IEEE 802.11a mode), any transmit signals are correlated with each other, so Directional gain= $10\log[(10^{G1/20}+10^{G2/20}+...+10^{GN/20})^2/N]$ dBi, that is Directional gain= $10\log[(10^{3.67/20}+10^{3.77/20})^2/2]$ dBi =6.73.
- 2) The antenna gain is provided by the manufacturer.
- 3) Ant.1 refers to Aux Antenna, Ant.2 refers to Main Antenna.

4. Table for Antenna Configuration:

Operating Mode	TX Mode	1TX	2TX
IEEE 802.11a		V (Ant. 1)	-
IEEE 802.11n(HT20)		-	V (Ant. 1+Ant. 2)
IEEE 802.11n(HT40)		-	V (Ant. 1+Ant. 2)
IEEE 802.11ac(VHT20)		-	V (Ant. 1+Ant. 2)
IEEE 802.11ac(VHT40)		-	V (Ant. 1+Ant. 2)
IEEE 802.11ac(VHT80)		-	V (Ant. 1+Ant. 2)
IEEE 802.11ac(VHT160)		-	V (Ant. 1+Ant. 2)
IEEE 802.11ax(HE20)		-	V (Ant. 1+Ant. 2)
IEEE 802.11ax(HE40)		-	V (Ant. 1+Ant. 2)
IEEE 802.11ax(HE80)		-	V (Ant. 1+Ant. 2)
IEEE 802.11ax(HE160)		-	V (Ant. 1+Ant. 2)
IEEE 802.11be(EHT20)		-	V (Ant. 1+Ant. 2)
IEEE 802.11be(EHT40)		-	V (Ant. 1+Ant. 2)
IEEE 802.11be(EHT80)		-	V (Ant. 1+Ant. 2)
IEEE 802.11be(EHT160)		-	V (Ant. 1+Ant. 2)

2.2 TEST MODES

The test system was pre-tested based on the consideration of all possible combinations of EUT operation mode.

Pretest Mode	Description
Mode 1	Normal Mode
Mode 2	TX N(HT40) Mode Channel 118 (UNII-2C)

Following mode(s) was (were) found to be the worst case(s) and selected for the final test.

AC power line conducted emissions test	
Final Test Mode	Description
Mode 1	Normal Mode

Radiated Emissions Test - Below 1GHz	
Final Test Mode	Description
Mode 1	Normal Mode

Radiated Emissions Test - Above 1GHz	
Final Test Mode	Description
Mode 2	TX N(HT40) Mode Channel 118 (UNII-2C)

Note:

- (1) This Notebook PC has two mainboards with two adapters. Both mainboard MB1 (with adapter RC30-0484) and mainboard MB2 (with adapter RC30-042) had been pre-tested and in this report only recorded the worst case.

2.3 BLOCK DIAGRAM SHOWING THE CONFIGURATION OF SYSTEM TESTED

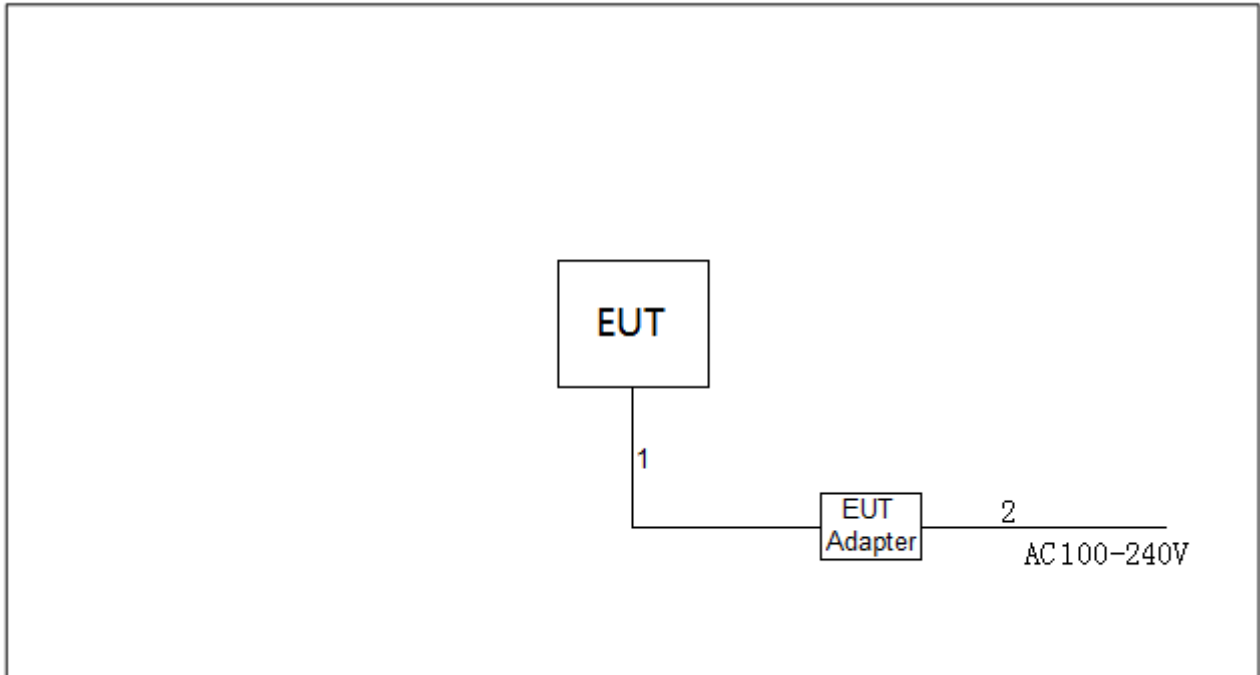

2.4 SUPPORT UNITS

Item	Equipment	Brand	Model No.	Series No.
-	-	-	-	-

Item	Cable Type	Shielded Type	Ferrite Core	Length
1	DC Cable	NO	NO	1.2m
2	AC Cable	NO	NO	1.5m

3. AC POWER LINE CONDUCTED EMISSIONS

3.1 LIMIT

Frequency (MHz)	Limit (dB μ V)	
	Quasi-peak	Average
0.15 - 0.5	66 to 56*	56 to 46*
0.5 - 5.0	56	46
5.0 - 30.0	60	50

NOTE:

- (1) The tighter limit applies at the band edges.
- (2) The limit of " * " marked band means the limitation decreases linearly with the logarithm of the frequency in the range.
- (3) The test result calculated as following:
Measurement Value = Reading Level + Correct Factor

3.2 TEST PROCEDURE

- a. The EUT was placed 0.8 meters from the horizontal ground plane with EUT being connected to the power mains through a line impedance stabilization network (LISN). All other support equipment powered from additional LISN(s). The LISN provide 50 Ohm/ 50uH of coupling impedance for the measuring instrument.
- b. Interconnecting cables that hang closer than 40 cm to the ground plane shall be folded back and forth in the center forming a bundle 30 to 40 cm long.
- c. I/O cables that are not connected to a peripheral shall be bundled in the center. The end of the cable may be terminated, if required, using the correct terminating impedance. The overall length shall not exceed 1 m.
- d. LISN at least 80 cm from nearest part of EUT chassis.
- e. For the actual test configuration, please refer to the related Item -EUT Test Photos.

The following table is the setting of the receiver:

Receiver Parameter	Setting
Start Frequency	0.15 MHz
Stop Frequency	30 MHz
IF Bandwidth	9 kHz

3.3 DEVIATION FROM TEST STANDARD

No deviation

3.4 TEST SETUP

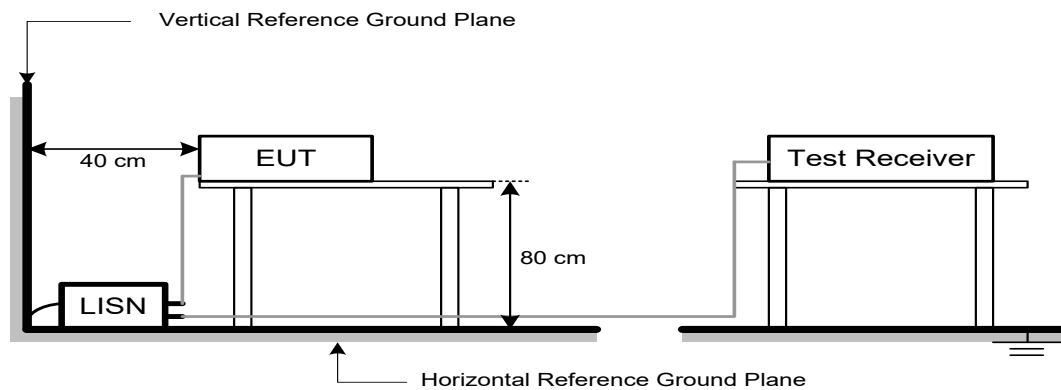

3.5 EUT OPERATION CONDITIONS

The EUT was configured for testing in a typical fashion (as a customer would normally use it). The EUT has been programmed to continuously transmit during test. This operating condition was tested and used to collect the included data.

The EUT was programmed to be in continuously transmitting/TX mode.

3.6 TEST RESULTS

Please refer to the APPENDIX A.

4. RADIATED EMISSIONS

4.1 LIMIT

In case the emission fall within the restricted band specified on 15.205(a), then the 15.209(a) limit in the table below has to be followed.

LIMITS OF RADIATED EMISSIONS MEASUREMENT (9 kHz to 1000 MHz)

Frequency (MHz)	Field Strength (microvolts/meter)	Measurement Distance (meters)
0.009-0.490	2400/F(kHz)	300
0.490-1.705	24000/F(kHz)	30
1.705-30.0	30	30
30-88	100	3
88-216	150	3
216-960	200	3
Above 960	500	3

LIMITS OF UNWANTED EMISSION OUT OF THE RESTRICTED BANDS (Above 1000 MHz)

Frequency (MHz)	EIRP Limit (dBm/MHz)	Equivalent Field Strength at 3m (dBμV/m)
5150-5250	-27	68.2
5250-5350	-27	68.2
5470-5725	-27	68.2
5725-5850 NOTE (2)	-27	68.2
	10	105.2
	15.6	110.8
	27	122.2

NOTE:

(1) The following formula is used to convert the equipment isotropic radiated power (eirp) to field strength:

$$E = \frac{1000000\sqrt{30P}}{3} \mu\text{V/m, where P is the eirp (Watts)}$$

(2) According to 15.407(b)(4)(i), all emissions shall be limited to a level of -27 dBm/MHz at 75 MHz or more above or below the band edge increasing linearly to 10 dBm/MHz at 25 MHz above or below the band edge, and from 25 MHz above or below the band edge increasing linearly to a level of 15.6 dBm/MHz at 5 MHz above or below the band edge, and from 5 MHz above or below the band edge increasing linearly to a level of 27 dBm/MHz at the band edge.

4.2 TEST PROCEDURE

- a. The measuring distance of 3 m shall be used for measurements. The EUT was placed on the top of a rotating table 0.8 meter above the ground at a 3 meter semi-anechoic chamber. The table was rotated 360 degrees to determine the position of the highest radiation.(below 1GHz)
- b. The measuring distance of 3 m shall be used for measurements. The EUT was placed on the top of a rotating table 1.5 meter above the ground at a 3 meter semi-anechoic chamber. The table was rotated 360 degrees to determine the position of the highest radiation.(above 1GHz)
- c. The height of the equipment or of the substitution antenna shall be 0.8m or 1.5m; the height of the test antenna shall vary between 1 m to 4 m. Both horizontal and vertical polarizations of the antenna are set to make the measurement.
- d. For each suspected emission, the EUT was arranged to its worst case and then the antenna was tuned to heights find the maximum reading (used Bore sight function).
- e. The receiver system was set to peak and average detect function and specified bandwidth with maximum hold mode when the test frequency is above 1 GHz.
- f. The initial step in collecting radiated emission data is a receiver peak detector mode pre-scanning the measurement frequency range. Significant peaks are then marked and then Quasi Peak detector mode re-measured.
- g. All readings are Peak unless otherwise stated QP in column of Note. Peak denotes that the Peak reading compliance with the QP Limits and then QP Mode measurement didn't perform. (below 1 GHz)
- h. All readings are Peak Mode value unless otherwise stated AVG in column of Note. If the Peak Mode Measured value compliance with the Peak Limits and lower than AVG Limits, the EUT shall be deemed to meet both Peak & AVG Limits and then only Peak Mode was measured, but AVG Mode didn't perform. (above 1 GHz)
- i. For the actual test configuration, please refer to the related Item –EUT Test Photos.

The following table is the setting of the receiver:

Spectrum Parameters	Setting
Start ~ Stop Frequency	9 kHz~150 kHz for RBW 200 Hz
Start ~ Stop Frequency	0.15 MHz~30 MHz for RBW 9 kHz
Start ~ Stop Frequency	30 MHz~1000 MHz for RBW 100 kHz

Spectrum Parameters	Setting
Start Frequency	1000 MHz
Stop Frequency	10th carrier harmonic or 40 GHz, whichever is lower
RBW / VBW (Emission in restricted band)	1 MHz / 3 MHz for PK value 1 MHz / 1/T Hz for AVG value

Receiver Parameters	Setting
Start ~ Stop Frequency	9 kHz~90 kHz for PK/AVG detector
Start ~ Stop Frequency	90 kHz~110 kHz for QP detector
Start ~ Stop Frequency	110 kHz~490 kHz for PK/AVG detector
Start ~ Stop Frequency	490 kHz~30 MHz for QP detector
Start ~ Stop Frequency	30 MHz~1000 MHz for QP detector
Start ~ Stop Frequency	1 GHz~40 GHz for PK/AVG detector

4.3 DEVIATION FROM TEST STANDARD

No deviation.

4.4 TEST SETUP

9 kHz to 30 MHz

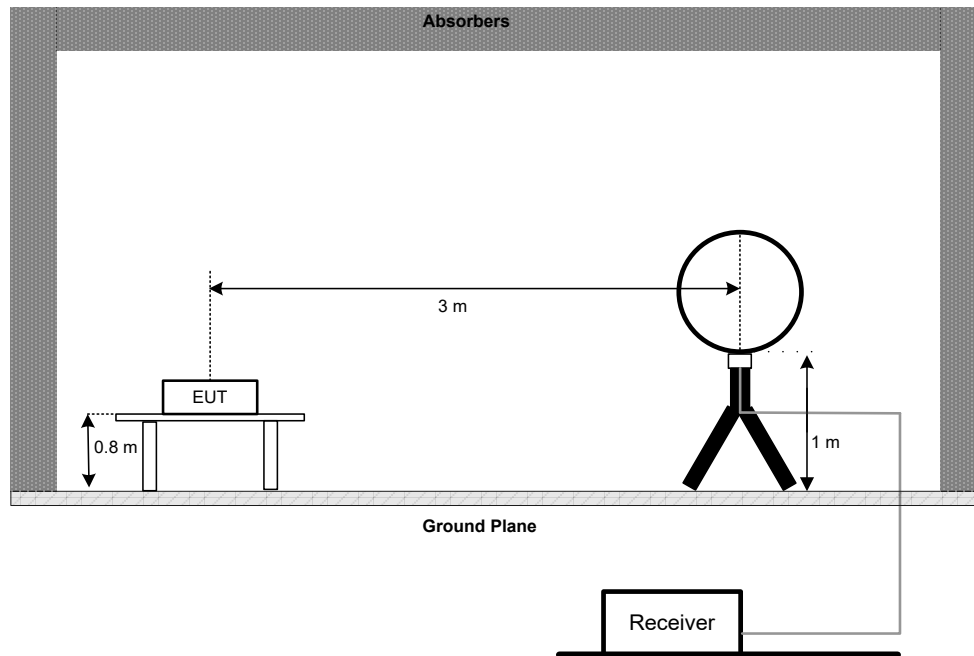

30 MHz to 1 GHz

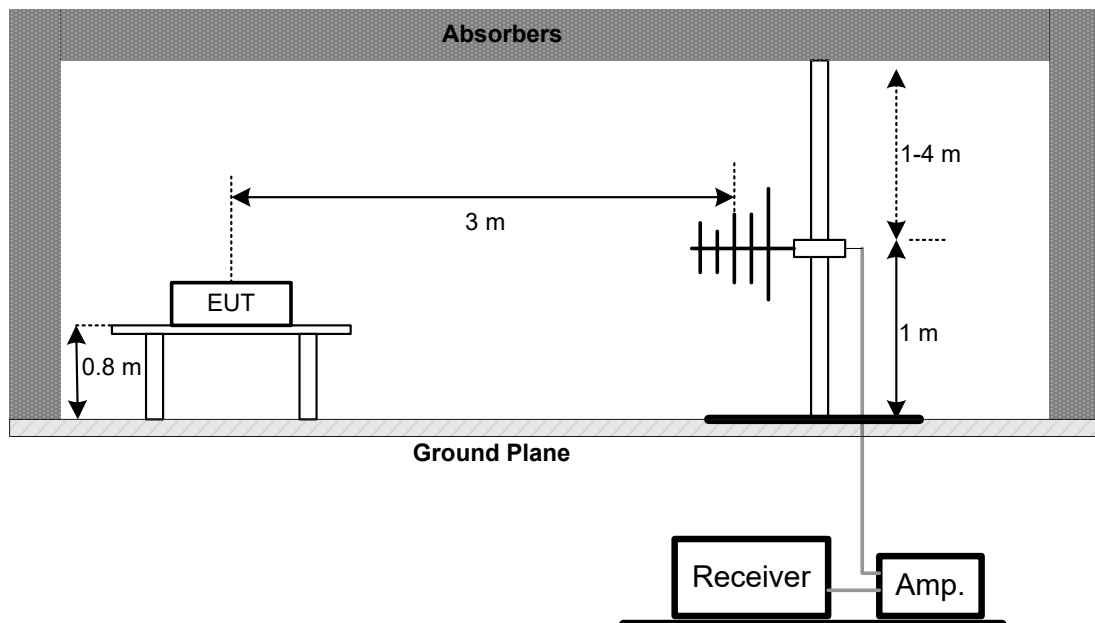

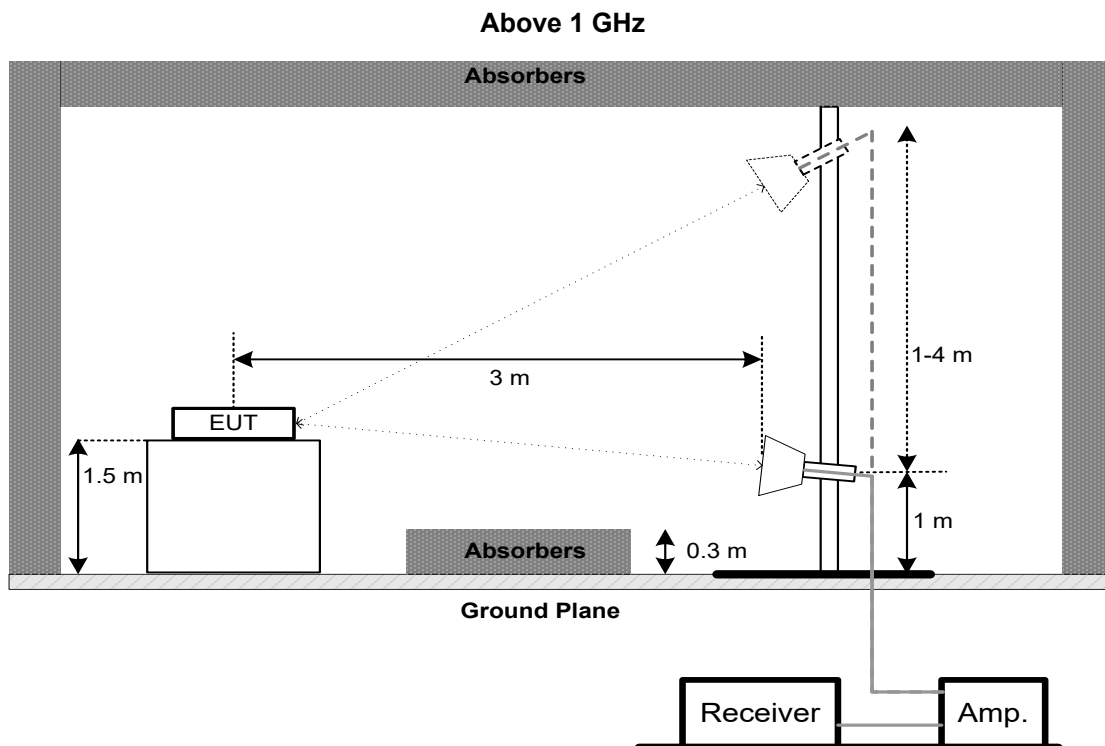

4.5 EUT OPERATION CONDITIONS

The EUT tested system was configured as the statements of 3.5 unless otherwise a special operating condition is specified in the follows during the testing.

4.6 TEST RESULTS - 9 KHZ TO 30 MHZ

Please refer to the APPENDIX B.

Remark:

- (1) Distance extrapolation factor = $40 \log (\text{specific distance} / \text{test distance})$ (dB).
- (2) Limit line = specific limits (dBuV) + distance extrapolation factor.

4.7 TEST RESULTS - 30 MHZ TO 1000 MHZ

Please refer to the APPENDIX C.

4.8 TEST RESULTS - ABOVE 1000 MHZ

Please refer to the APPENDIX D.

Remark:

- (1) No limit: This is fundamental signal, the judgment is not applicable.
For fundamental signal judgment was referred to Peak output test.

5. MEASUREMENT INSTRUMENTS LIST

AC Power Line Conducted Emissions					
Item	Kind of Equipment	Manufacturer	Type No.	Serial No.	Calibrated until
1	EMI Test Receiver	R&S	ESR3	103027	Jun. 16, 2024
2	TWO-LINE V-NETWORK	R&S	ENV216	101447	Jan. 07, 2024
3	Measurement Software	Farad	EZ-EMC Ver.NB-03A1-01	N/A	N/A
4	Cable	N/A	RG223	12m	Sep. 13, 2024
5	643 Shield Room	ETS	6*4*3	N/A	N/A

Radiated Emissions - 9 kHz to 30 MHz					
Item	Kind of Equipment	Manufacturer	Type No.	Serial No.	Calibrated until
1	Active Loop Antenna	Schwarzbeck	FMZB 1513-60B	1513-60 B-034	Apr. 01, 2024
2	MXE EMI Receiver	Keysight	N9038A	MY56400091	Jan. 07, 2024
3	Cable	N/A	RW2350-3.8A-NMB M-1.5M	N/A	Jun. 10, 2024
4	Measurement Software	Farad	EZ-EMC Ver.NB-03A1-01	N/A	N/A
5	966 Chamber room	ETS	9*6*6	N/A	Jul. 11, 2024

Radiated Emissions - 30 MHz to 1 GHz					
Item	Kind of Equipment	Manufacturer	Type No.	Serial No.	Calibrated until
1	Trilog-Broadband Antenna	Schwarzbeck	VULB 9168	1461	Nov. 28, 2024
2	Attenuator	EMC INSTRUMENT	EMCI-N-6-06	AT-06010	Nov. 28, 2024
3	Preamplifier	EMC INSTRUMENT	EMC001330	980863	Nov. 17, 2024
4	Cable	RegalWay	LMR400-NMNM-12 .5m	N/A	Jul. 04, 2024
5	Cable	RegalWay	LMR400-NMNM-3 m	N/A	Jul. 04, 2024
6	Cable	RegalWay	LMR400-NMNM-0. 5m	N/A	Jul. 04, 2024
7	Receiver	Agilent	N9038A	MY52130039	Jan. 07, 2024
8	Positioning Controller	MF	MF-7802	N/A	N/A
9	Measurement Software	Farad	EZ-EMC Ver.NB-03A1-01	N/A	N/A
10	966 Chamber room	CM	9*6*6	N/A	May 17, 2024

Radiated Emissions - Above 1 GHz					
Item	Kind of Equipment	Manufacturer	Type No.	Serial No.	Calibrated until
1	Receiver	Agilent	N9038A	MY52130039	Jan. 07, 2024
2	Preamplifier	EMC INSTRUMENT	EMC118A45SE	980888	Jan. 07, 2024
3	EXA Spectrum Analyzer	Keysight	N9010A	MY55150209	Jun. 16, 2024
4	Double Ridged Guide Antenna	ETS	3115	75789	May 31, 2024
5	Cable	RegalWay	A81-SMAMSMAM-12.5M	N/A	Aug. 08, 2024
6	Cable	RegalWay	RWLP50-4.0A-NMRASM-2.5M	N/A	Aug. 08, 2024
7	Cable	RegalWay	RWLP50-4.0A-NMRASM-RA-0.8M	N/A	Aug. 08, 2024
8	966 Chamber room	CM	9*6*6	N/A	May 17, 2024
9	Positioning Controller	MF	MF-7802	N/A	N/A
10	Measurement Software	Farad	EZ-EMC Ver.NB-03A1-01	N/A	N/A
11	Low Noise Amplifier	CONNPHY	CLN-18G40G-4330-K	619413	Jul. 06, 2024
12	Cable	RegalWay	RWLP50-2.6A-2.92M2.9-2M-1.1M	N/A	Jul. 26, 2024
13	Cable	Tonscend	HF160-KMKM-3M	N/A	Jul. 26, 2024
14	Broad-Band Horn Antenna	Schwarzbeck	BBHA9170(3m)	9170-319	Jun. 20, 2024

Remark "N/A" denotes no model name, serial no. or calibration specified.
 All calibration period of equipment list is one year.

APPENDIX A - AC POWER LINE CONDUCTED EMISSIONS

Test Mode	Normal Mode	Phase	Line
-----------	-------------	-------	------

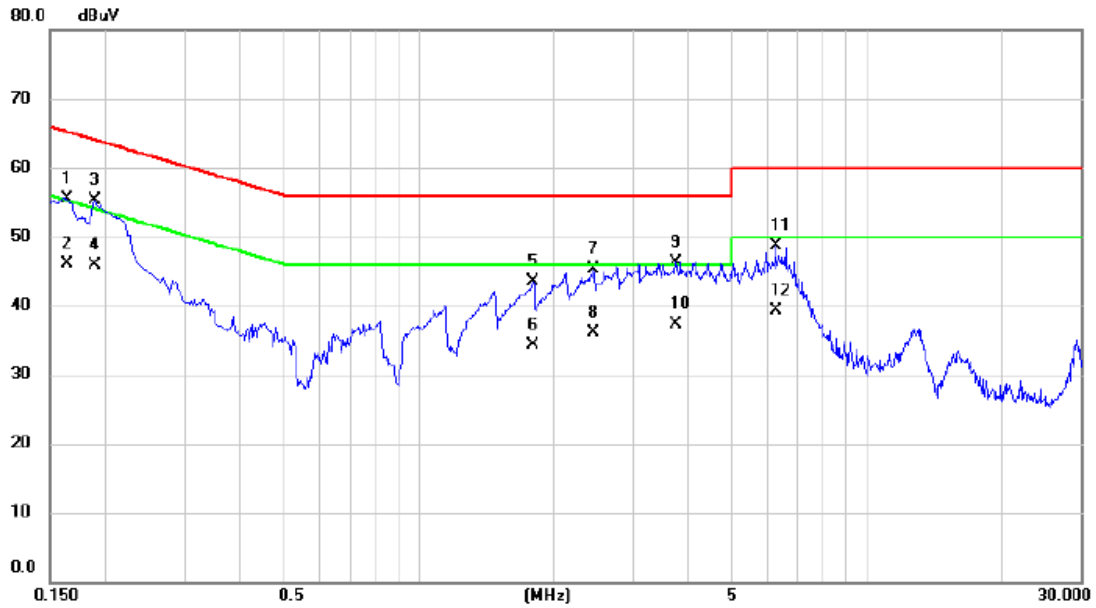

No.	Mk.	Freq. MHz	Reading Level dBuV	Correct Factor dB	Meas- ment dBuV	Limit dBuV	Margin dB	Detector	Comment
1		0.1635	45.78	9.70	55.48	65.28	-9.80	QP	
2		0.1635	36.50	9.70	46.20	55.28	-9.08	AVG	
3		0.1883	45.55	9.71	55.26	64.11	-8.85	QP	
4	*	0.1883	36.20	9.71	45.91	54.11	-8.20	AVG	
5		1.7925	33.63	9.85	43.48	56.00	-12.52	QP	
6		1.7925	24.50	9.85	34.35	46.00	-11.65	AVG	
7		2.4450	35.49	9.88	45.37	56.00	-10.63	QP	
8		2.4450	26.20	9.88	36.08	46.00	-9.92	AVG	
9		3.7500	36.30	9.97	46.27	56.00	-9.73	QP	
10		3.7500	27.40	9.97	37.37	46.00	-8.63	AVG	
11		6.2768	38.70	10.09	48.79	60.00	-11.21	QP	
12		6.2768	29.30	10.09	39.39	50.00	-10.61	AVG	

REMARKS:

- (1) Measurement Value = Reading Level + Correct Factor.
- (2) Margin Level = Measurement Value - Limit Value.

Test Mode	Normal Mode	Phase	Neutral
-----------	-------------	-------	---------

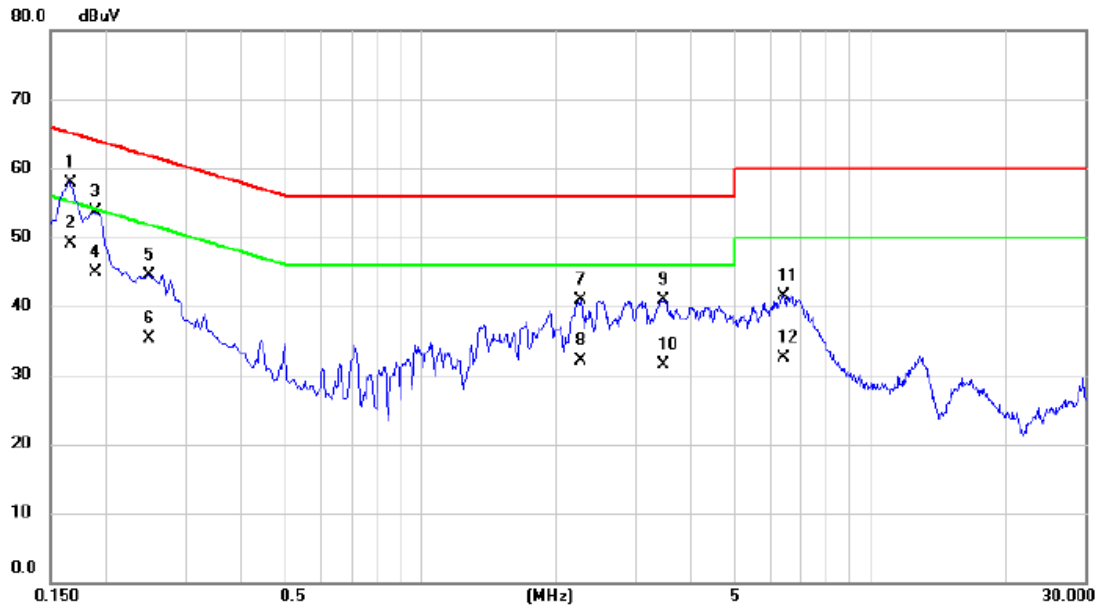

No.	Mk.	Freq. MHz	Reading Level dBuV	Correct Factor dB	Measure- ment dBuV	Limit dBuV	Margin dB	Detector	Comment
1		0.1658	48.23	9.68	57.91	65.17	-7.26	QP	
2	*	0.1658	39.40	9.68	49.08	55.17	-6.09	AVG	
3		0.1883	44.01	9.68	53.69	64.11	-10.42	QP	
4		0.1883	35.20	9.68	44.88	54.11	-9.23	AVG	
5		0.2490	34.82	9.68	44.50	61.79	-17.29	QP	
6		0.2490	25.60	9.68	35.28	51.79	-16.51	AVG	
7		2.2695	31.02	9.85	40.87	56.00	-15.13	QP	
8		2.2695	22.20	9.85	32.05	46.00	-13.95	AVG	
9		3.4778	30.98	9.91	40.89	56.00	-15.11	QP	
10		3.4778	21.60	9.91	31.51	46.00	-14.49	AVG	
11		6.3983	31.44	10.07	41.51	60.00	-18.49	QP	
12		6.3983	22.40	10.07	32.47	50.00	-17.53	AVG	

REMARKS:

(1) Measurement Value = Reading Level + Correct Factor.

(2) Margin Level = Measurement Value - Limit Value.

APPENDIX B - RADIATED EMISSION - 9 KHZ TO 30 MHZ

Test Mode	Normal Mode	Polarization	Ant 0°
-----------	-------------	--------------	--------

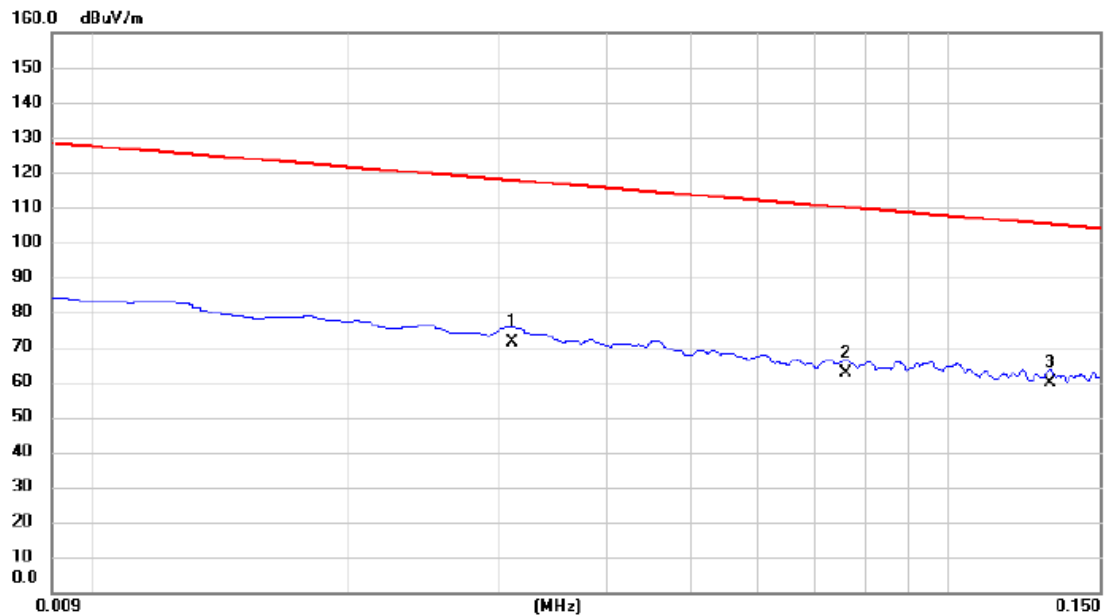

No.	Mk.	Freq. MHz	Reading Level dBuV	Correct Factor dB	Measure- ment dBuV/m	Limit dBuV/m	Margin dB	Detector	Comment
1		0.0310	51.62	19.80	71.42	117.78	-46.36	AVG	
2		0.0760	42.61	19.89	62.50	109.99	-47.49	AVG	
3	*	0.1315	39.84	19.83	59.67	105.23	-45.56	AVG	

REMARKS:

(1) Measurement Value = Reading Level + Correct Factor.

(2) Margin Level = Measurement Value - Limit Value.

Test Mode	Normal Mode	Polarization	Ant 0°
-----------	-------------	--------------	--------

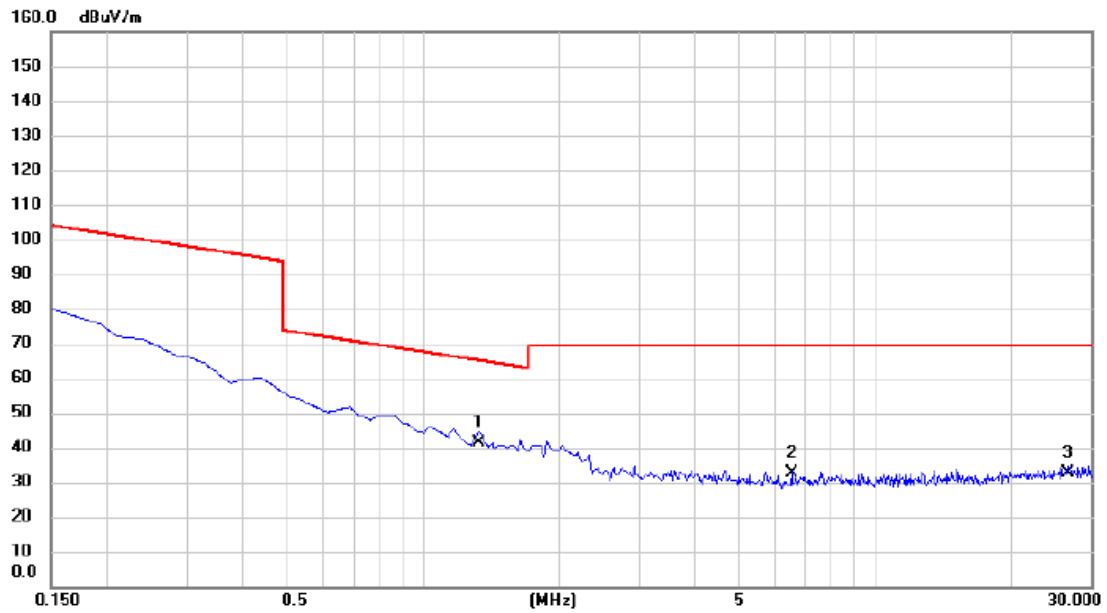

No.	Mk.	Freq. MHz	Reading Level dBuV	Correct Factor dB	Measure- ment dBuV/m	Limit dBuV/m	Margin dB	Detector	Comment
1	*	1.3290	21.69	19.85	41.54	65.13	-23.59	QP	
2		6.5380	12.63	20.00	32.63	69.54	-36.91	QP	
3		26.7613	11.67	21.08	32.75	69.54	-36.79	QP	

REMARKS:

- (1) Measurement Value = Reading Level + Correct Factor.
- (2) Margin Level = Measurement Value - Limit Value.

Test Mode	Normal Mode	Polarization	Ant 90°
-----------	-------------	--------------	---------

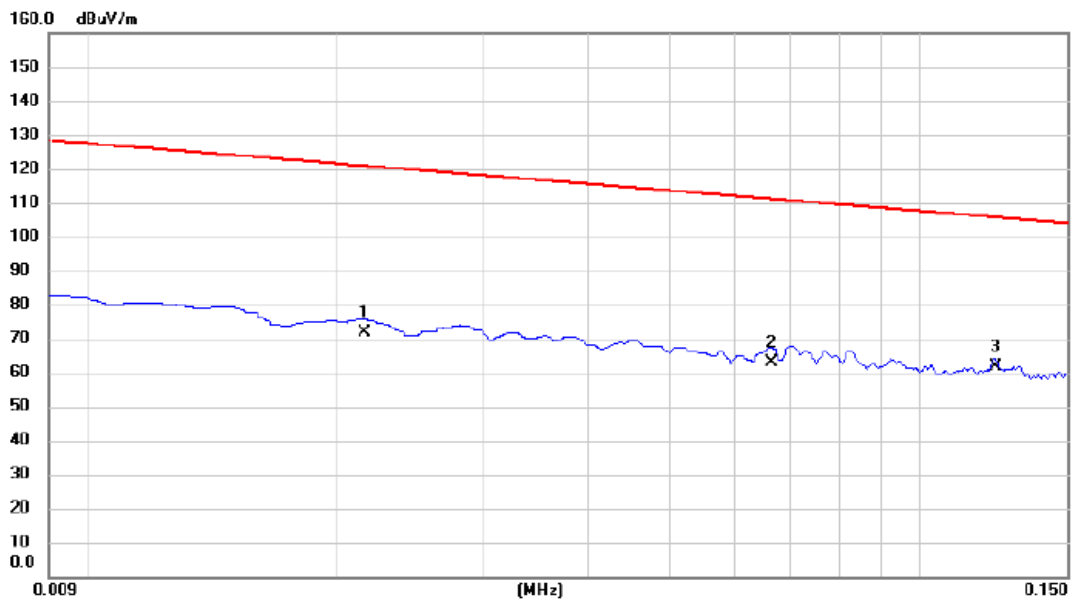

No.	Mk.	Freq.	Reading Level	Correct Factor	Measurement	Limit	Margin	Detector	Comment
		MHz	dBuV	dB	dBuV/m	dBuV/m	dB		
1		0.0215	51.64	20.27	71.91	120.96	-49.05	AVG	
2		0.0663	43.25	19.85	63.10	111.17	-48.07	AVG	
3	*	0.1230	41.84	19.83	61.67	105.81	-44.14	AVG	

REMARKS:

- (1) Measurement Value = Reading Level + Correct Factor.
- (2) Margin Level = Measurement Value - Limit Value.

Test Mode	Normal Mode	Polarization	Ant 90°
-----------	-------------	--------------	---------



No.	Mk.	Freq. MHz	Reading Level dBuV	Correct Factor dB	Measure- ment dBuV/m	Limit dBuV/m	Margin dB	Detector	Comment
1	*	0.6276	31.62	19.85	51.47	71.65	-20.18	QP	
2		3.4484	13.54	19.89	33.43	69.54	-36.11	QP	
3		20.2690	13.21	20.62	33.83	69.54	-35.71	QP	

REMARKS:

- (1) Measurement Value = Reading Level + Correct Factor.
- (2) Margin Level = Measurement Value - Limit Value.

APPENDIX C - RADIATED EMISSION - 30 MHZ TO 1000 MHZ

Test Mode	Normal Mode	Polarization	Vertical
-----------	-------------	--------------	----------

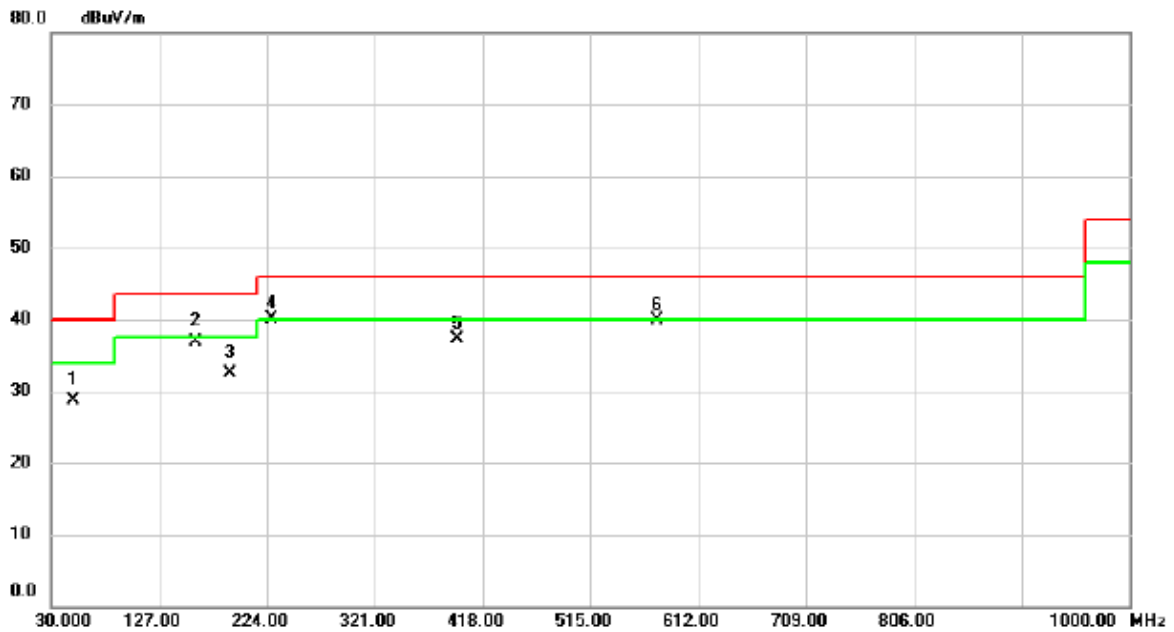

No. Mk.	Freq. MHz	Reading Level dBuV	Correct Factor dB	Measurement dBuV/m	Limit dBuV/m	Margin dB	Detector	Comment
1	49.8850	40.06	-11.36	28.70	40.00	-11.30	QP	
2	159.9800	48.00	-11.18	36.82	43.50	-6.68	QP	
3	191.5050	46.76	-14.16	32.60	43.50	-10.90	QP	
4 *	228.3650	54.25	-14.17	40.08	46.00	-5.92	peak	
5	394.7200	45.80	-8.56	37.24	46.00	-8.76	peak	
6	574.6550	44.39	-4.47	39.92	46.00	-6.08	peak	

REMARKS:

- (1) Measurement Value = Reading Level + Correct Factor.
- (2) Margin Level = Measurement Value - Limit Value.

Test Mode	Normal Mode	Polarization	Horizontal
-----------	-------------	--------------	------------

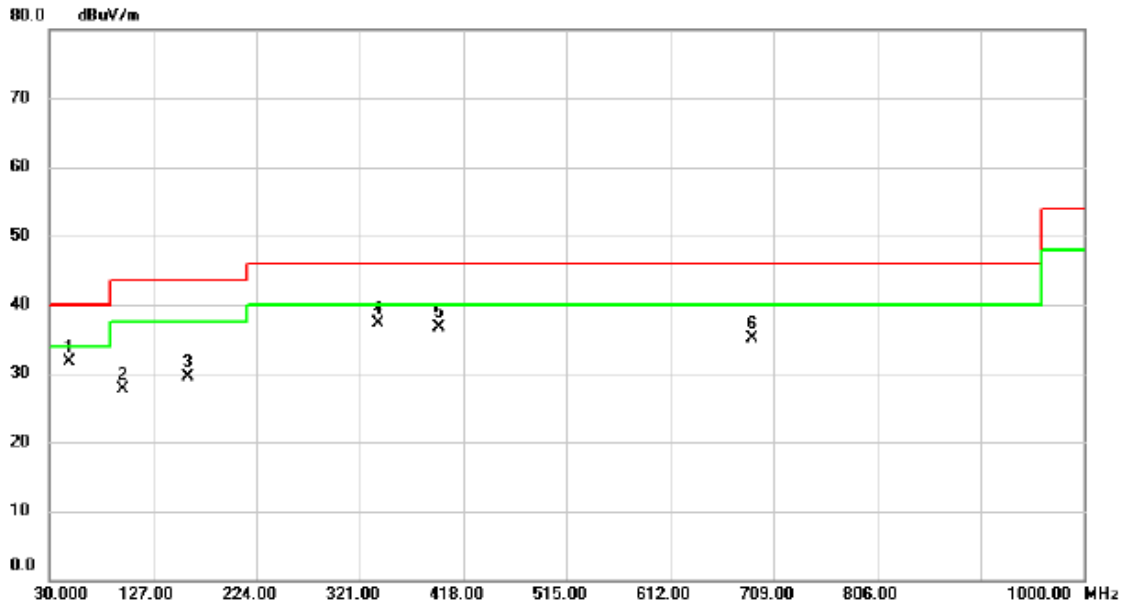

No.	Mk.	Freq. MHz	Reading Level dBuV	Correct Factor dB	Measure- ment dBuV/m	Limit dBuV/m	Margin dB	Detector	Comment
1	*	48.9150	43.16	-11.39	31.77	40.00	-8.23	peak	
2		99.3550	43.68	-16.06	27.62	43.50	-15.88	peak	
3		159.9800	40.65	-11.18	29.47	43.50	-14.03	peak	
4		338.4600	47.36	-10.00	37.36	46.00	-8.64	peak	
5		395.2050	45.21	-8.55	36.66	46.00	-9.34	peak	
6		688.6300	37.66	-2.54	35.12	46.00	-10.88	peak	

REMARKS:

(1) Measurement Value = Reading Level + Correct Factor.

(2) Margin Level = Measurement Value - Limit Value.

APPENDIX D - RADIATED EMISSION - ABOVE 1000 MHZ

Test Mode	TX N(HT40) Mode Channel 118 (UNII-2C)	Polarization	Vertical
-----------	---------------------------------------	--------------	----------

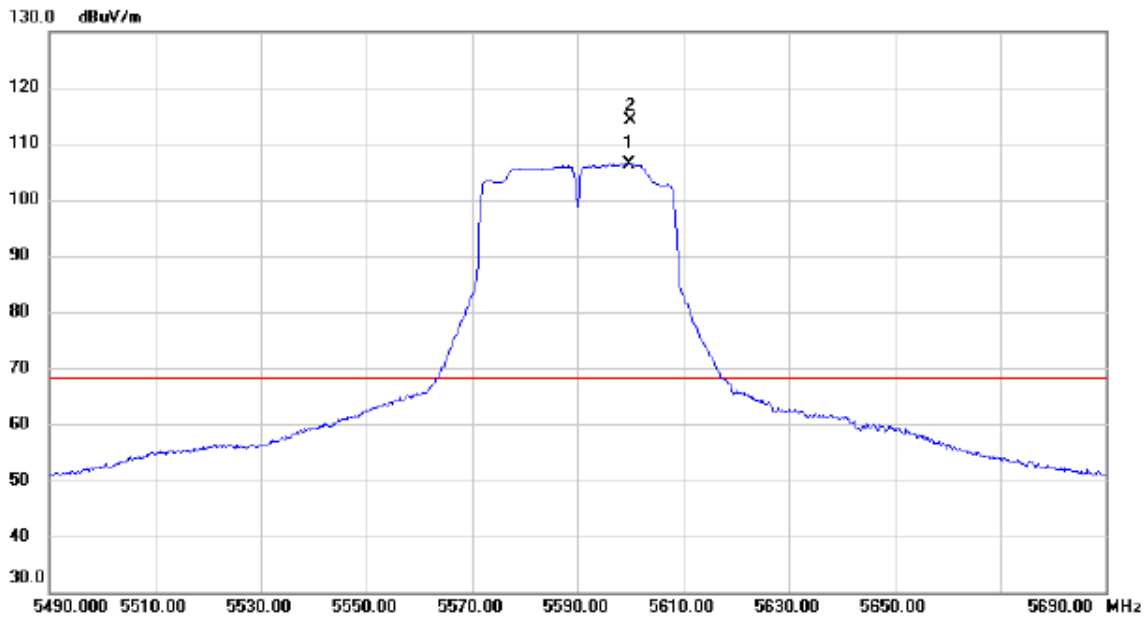

No.	Mk.	Freq. MHz	Reading Level dBuV	Correct Factor dB	Measure- ment dBuV/m	Limit dBuV/m	Margin dB	Detector	Comment
1	X	5599.600	93.93	12.51	106.44	68.20	38.24	AVG	No Limit
2	*	5599.900	101.6	12.51	114.20	68.20	46.00	peak	No Limit

REMARKS:

- (1) Measurement Value = Reading Level + Correct Factor.
- (2) Margin Level = Measurement Value - Limit Value.

Test Mode	TX N(HT40) Mode Channel 118 (UNII-2C)	Polarization	Vertical
-----------	---------------------------------------	--------------	----------

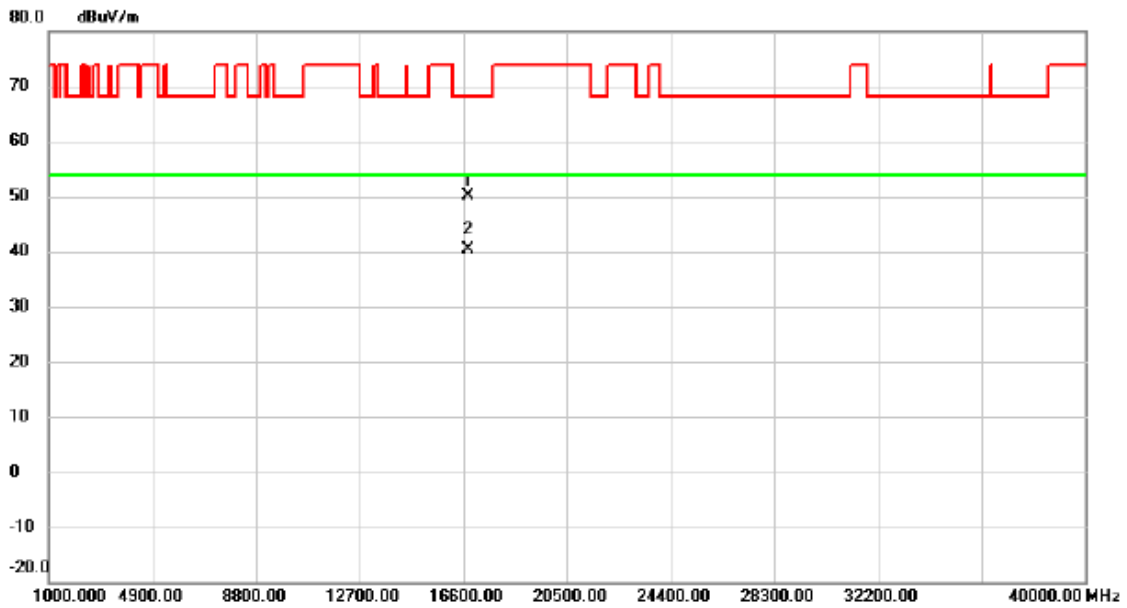

No.	Mk.	Freq. MHz	Reading Level dBuV	Correct Factor dB	Measure- ment dBuV/m	Limit dBuV/m	Margin dB	Detector	Comment
1		16770.75	43.60	6.43	50.03	68.20	-18.17	peak	
2	*	16772.82	34.00	6.44	40.44	54.00	-13.56	AVG	

REMARKS:

- (1) Measurement Value = Reading Level + Correct Factor.
- (2) Margin Level = Measurement Value - Limit Value.

End of Test Report