



SAR Test Report

For Ezze MEGA1, ID: RV2MEGA1

Application information:

DUT Type	Tri Band GSM 850/1800/1900 PCS handheld cellular phone
Trade Name / Mode(s)	Ezze MEGA1
FCC Classification	Licensed Portable Transmitter Held to Ear (PCE)
FCC Rule Part(s)	2.1093; FCC/OET Bulletin65 Supplement C [July 2001]
Application Type	Certification
Production Unit or Identical Prototype (47 CFR §2.908)	Identical prototype
Antenna type	internal antenna
RF exposure limits	General Population / Uncontrolled

Device under test (DUT):

DUT ID	IMEI	HW Ver.	SW Ver.
C01	135790246811220	1.0	1.0

Accessories of DUT

Accessories ID	Description
A01	Earphone

Batteries of DUT

Batteries ID	Type	Capacity
B01	Lithium Ion Rechargeable Battery	730mAh
B02	Lithium Ion Rechargeable Battery	730mAh

Executive Summary

The Ezze MEGA1 is in compliance with the Federal Communications Commission (FCC) Guidelines [OET65, June 2001] for uncontrolled exposure. The tests were performed according to the FCC requirements, and no change was made to the DUT during the tests.

Issued by (Test Engineer):

Cai Jing

Cai Jing, 2008-03-24

Reviewed by:

Li Hong Ru

Li Hong Ru, 2008-03-28

Approved by:

Xiong Xiao Hong

Xiong Xiao Hong, 2008-03-28



Table of Contents

1	General Information.....	3
2	Subject of investigation	3
3	Standard	5
3.1	Distinction between exposed population, duration of exposure and frequencies	5
3.2	Distinction between Maximum Permissible Exposure and SAR Limits	5
3.3	SAR limit.....	5
4	Test procedure.....	6
4.1	General requirements.....	6
4.2	Phantom requirements	6
4.3	Brain & Muscle Simulating Mixture Characterization.....	6
4.4	Test positions	7
4.5	Test to be performed	10
5	Test Equipment.....	11
5.1	Location of Test Equipment	Error! Bookmark not defined.
5.1.1	Test System Setup.....	12
5.2	Measurement Procedure	12
5.3	Test positions for device under test	13
5.4	Test environment	16
5.5	Liquid parameters	16
5.6	System performance check	18
6	Test results and evaluation.....	19
6.1	Prepare measurement Results	19
6.2	SAR Test results	20
6.2.1	Head SAR test results	20
6.2.2	Body SAR test results	21
6.3	Summary and comparison to the limit.....	22
6.4	Detailed Measurement Report	23
6.4.1	Maximum head SAR of GSM 850.....	23
6.4.2	Maximum head SAR of GSM 1900.....	24
6.4.3	Maximum body SAR of GSM 850	25
6.4.4	Maximum body SAR of GPRS 850.....	26
6.4.5	Maximum body SAR of GSM 1900	27
6.4.6	Maximum body SAR of GPRS 1900.....	28
6.5	System performance check report.....	29
7	Uncertainty Budget	33
8	Reference Document.....	34

SAR Test Report

1 GENERAL INFORMATION

	Test Laboratory	Customer
Name:	Flextronics (China) Electronics Technology Co., Ltd. Flexmobile Test Laboratory	Ezze Mobile Tech.,Inc
Address:	Huaxia Technology Building, 8 Zhongguangcun Software Park, No. 8, Dongbeiwang West Street, Haidian District, Beijing, P.R.China 100094	1F,Bubmusa Bldg., 151-31.Nonhyun-D Kangnam-Ku, Seoul, Korea
Contact Person:	Liang Mao	Derik SEO
Telephone:	+86 10 5875 5075	+82 2 519 7809
Fax:	+86 10 5875 4915	+82 2 519 7882
E-mail:	Mao.liang@cn.flextronics.com	jhseo@ezzemobile.com

2 SUBJECT OF INVESTIGATION

Picture of the application device:



SAR Test Report

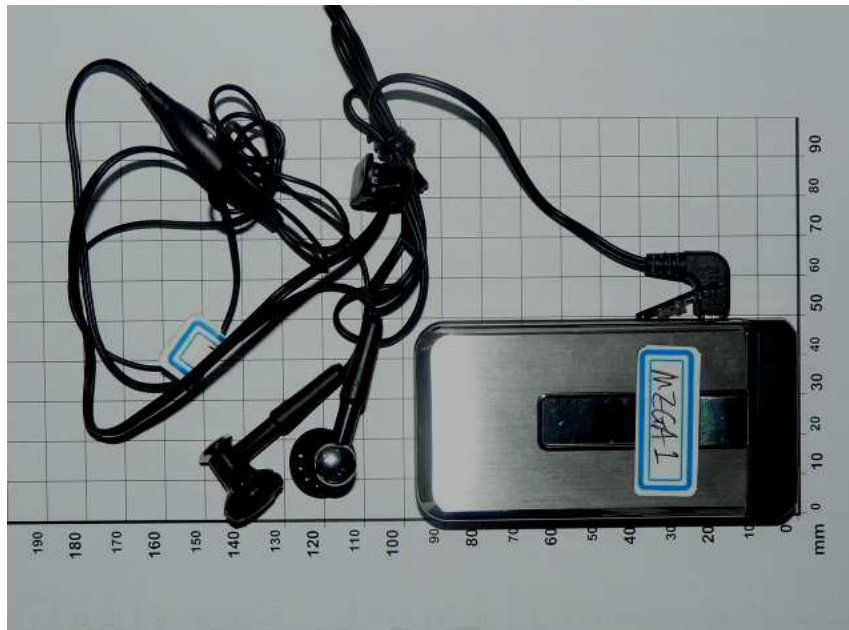

The objective of the measurements done by FlexMobile test laboratory was the dosimetric assessment. The examinations have been carried out with the dosimetric assessment system “DASY4” described in clause 5 below.

Flextronics (China) Electronics Technology Co., Ltd. Flexmobile Test Laboratory	 	Document No: DCP-BEJLM-TSRP-080020a.1
SAR Test Report		

3 STANDARD

In USA the recent FCC exposure criteria [OET 65] are based upon the IEEE Standard C95.1 [IEEE C95.1]. The IEEE standard C95.a sets limits for human exposure to radio frequency electromagnetic in the frequency range 3 kHz to 300GHz.

3.1 Distinction between exposed population, duration of exposure and frequencies

The American standard [IEEE C95.1] distinguishes between controlled and uncontrolled environment. Controlled environments are locations where there is exposure that may be incurred by persons who are aware of the potential for exposure as a concomitant of employment or by other cognizant persons. Uncontrolled environments are locations where there is the exposure of individuals who have no knowledge or control of their exposure. The exposures may occur in living quarters or workplaces. For exposure in controlled environments higher field strengths are admissible. In addition the duration of exposure is considered.

Due to the influence of frequency on important parameters, as the penetration depth of the electromagnetic fields into the human body and the absorption capability of different tissues, the limits in general vary with frequency.

3.2 Distinction between Maximum Permissible Exposure and SAR Limits

The biological relevant parameter describing the effects of electromagnetic fields in the frequency range of interest is the specific absorption rate SAR (dimension: power/mass). It is a measure of the power absorbed per unit mass. The SAR may be spatially averaged over the total mass of an exposed body or its parts. The SAR is calculated from the R.M.S. electric field strength E inside the human body, the conductivity σ and the mass density ρ of the biological tissue:

$$SAR = \sigma \frac{E^2}{\rho} = c \left. \frac{\partial T}{\partial t} \right|_{t \rightarrow 0+}$$

The specific absorption rate describes the initial rate of temperature rise $\partial T/\partial t$ as a function of the specific heat capacity c of the tissue. A limitation of the specific absorption rate prevents an excessive heating of the human body by electromagnetic energy.

As it is sometimes difficult to determine the SAR directly by measurement (e.g. whole body averaged SAR), the standard specifies more readily measurable maximum permissible exposures in terms of external electric E and magnetic field strength H and power density S , derived from the SAR limits. The limits for E , H and S have been fixed so that even under worst case conditions, the limits for the specific absorption rate SAR are not exceeded.

3.3 SAR limit

In this report the comparison between the American exposure limits and the measured data is made using the peak spatial-average SAR; the power level of the device under test guarantees that the whole body averaged SAR is not exceeded.

Having in mind a worst case consideration, the SAR limit is valid for uncontrolled environment and mobile respectively portable transmitters. According to table below the SAR values have to be averaged over a mass of $1g$ (SAR_{1g}) with the shape of a cube.

Relevant peak spatial-average SAR limit averaged over a mass of 1g.

Exposure limits	SAR(mw/g)	
	General Population/Uncontrolled Environment	Occupational/Controlled Exposure Environment
Spatial Average ANSI (Averaged over the whole body)	0.08	0.4
Spatial Peak ANSI (Averaged over any 1-g of tissue)	1.6	8.0
Spatial Peak ICNIRP/ANSI (hands/wrists/feet/ankles averaged over 10-g)	4.0	20.0
Localized SAR - ICNIRP - (Head and Trunk 10-g)	2.0	10.0

4 TEST REQUIREMENTS

IEEE has published a recommended practice for determining the peak spatial-average specific absorption rate (SAR) in the human body due to wireless communications devices [IEEE 1528-2003] for evaluation compliance of mobile phones with IEEE Standard C95.1 [IEEE C95.1]. The standard defines protocols of the measurement of the specific absorption rate (SAR) inside a simplified model of the head of users. It applies to mobile telecommunication equipment in the frequency range from 300 MHz to 3GHz intended to be operated while held next to the ear.

4.1 General requirements

The test shall be performed in a laboratory with an environment which avoids influence on SAR measurements by ambient EM sources and any reflection from the environment itself. The ambient temperature shall be in the range of 20°C to 24°C during the test.

4.2 Phantom requirements

The phantom is a simplified representation of the human anatomy and comprised of material with electrical properties similar to the corresponding tissues. The physical characteristics of the phantom model shall resemble the head and the neck of a user since the shape is a dominant parameter for exposure.

The shell of the phantom shall be made of low permittivity material and the thickness tolerance shall be $\pm 0.2\text{mm}$. Additionally the phantom shall enable to simulate both right and left hand operation of the device under test.

For the measurements the Specific Anthropomorphic Mannequin (SAM) which meet these requirements, shall be used.

4.3 Brain & Muscle Simulating Mixture Characterization

The brain and muscle mixtures consist of a viscous gel using hydroxethylcellulose (HEC) gelling agent and saline solution. Preservation with a bactericide is added and visual inspection is made to make sure air bubbles are not trapped during the mixing process. The mixture is calibrated to obtain proper dielectric constant

SAR Test Report

(permittivity) and conductivity of the desired tissue. The head tissue dielectric parameters recommended by the IEEE SCC-34/SC-2 have been incorporated in the following table. Other head and body tissue parameters that have not been specified in P1528 are derived from the tissue dielectric parameters computed from the 4-Cole-Cole equations.

Composition of the Brain & Muscle Tissue Equivalent Matter

INGREDIENTS	SIMULATING TISSUE			
	835MHz Brain	835MHz Muscle	1900MHz Brain	1900MHz Muscle
Water	40.29	50.75	55.24	70.17
DGBE	0	0	44.45	29.44
Sugar	57.90	48.21	0	0
Salt	1.38	0.94	0.31	0.39
Cellulose	0.24	0.00	0	0
Preventol	0.18	0.10	0	0

4.4 Test positions

As it cannot be expected that the user will hold the mobile phone exactly in one well defined position, different operational conditions shall be tested, the IEEE standard requires two test positions. For an exact description helpful geometrical definitions are introduced and shown in the below figure.

There are two imaginary lines on the mobile, the vertical centerline and the horizontal line. The vertical centerline passes through two points on the front side of the handset: the midpoint of the width w_i of the handset at the level of the acoustic output (point A on the below figure), and the midpoint of the width w_b of the bottom of the handset (point B). The horizontal line is perpendicular to the vertical centerline and passes through the center of the acoustic output. The two lines intersect at point A.

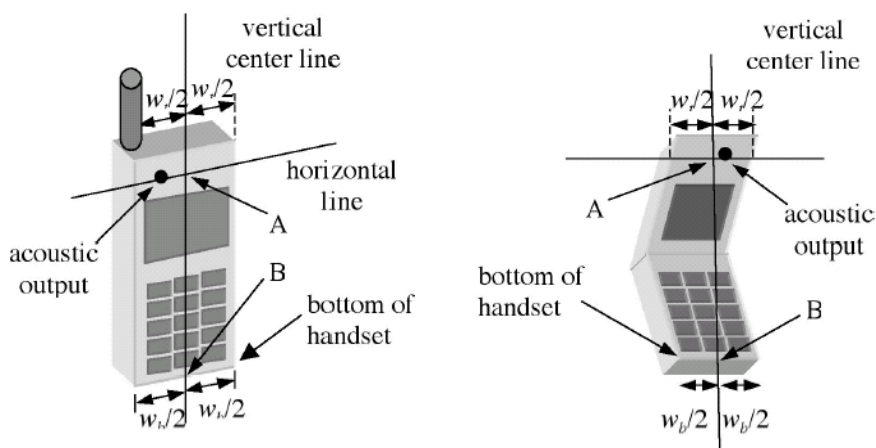

According to below the human head position is given by means of the following three reference points: auditory canal opening of both ears (RE and LE) and the center of the closed mouth (M). The ear reference points are 15-17 mm above the entrance to the ear canal along the BM line (back-month), as shown in the below figure. The plane passing through the two ear canals and M is defined as the reference plane. The line NF (Neck-Front)

SAR Test Report

perpendicular to the reference plane and passing through the RF (or LE) is called the reference pivoting line. Line BM is perpendicular to the NF line. With these definitions the test positions are given by:

➤ Cheek position:

Position the handset close to the surface of phantom such that point A is on the (virtual) extension of the line passing through points RE and LE on the phantom, such that the plane defined by the vertical center line and the horizontal line of the phone is approximately parallel to the sagittal plane of the phantom. Translate the handset towards the phantom along the line passing through RE and LE until the handset touches the ear. While maintaining the handset in this plane, rotate it around handset touches the ear. While maintaining the handset in this plane, rotate it around the LE-RE line until the vertical centerline is in the plane normal to MB-NF including the line MB (called the reference plane). Rotate the phone around the vertical centerline until the phone (horizontal line) is symmetrical with respect to the line NF. While maintaining the vertical centerline in the reference plane, keeping point A on the line passing through RE and LE, and maintaining the phone contact with the ear, rotate the handset about the line NF until any point any point on the handset is in contact with a phantom point below the ear.

The cheek position:

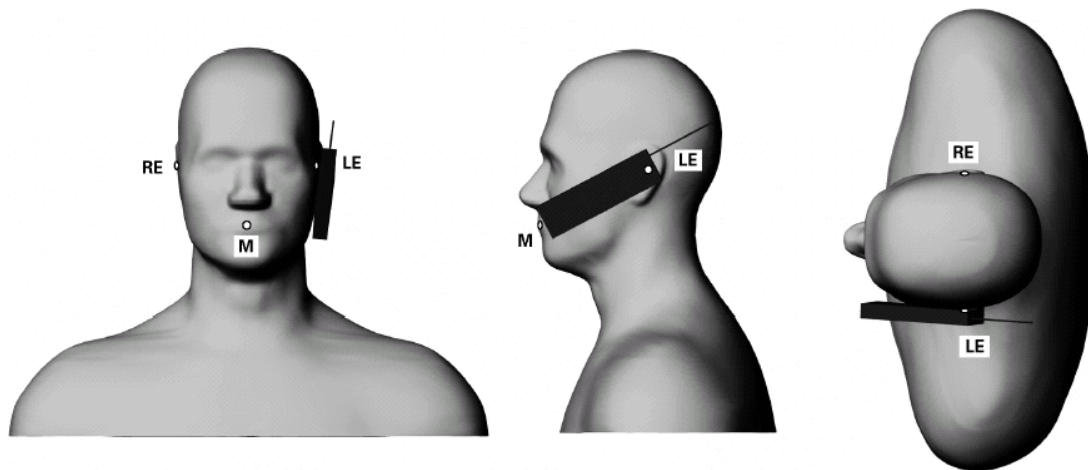

➤ Tilted position:

While maintaining the orientation of the phone, retract the phone parallel to the reference plane, which is far enough to enable a rotation of the phone by 15°. Rotate the phone around the horizontal line by 15°. While maintaining the orientation of the phone, move the phone parallel to the reference plane until any part of the phone touches the head. In this position, point A will be located on the line RE-LE.

SAR Test Report

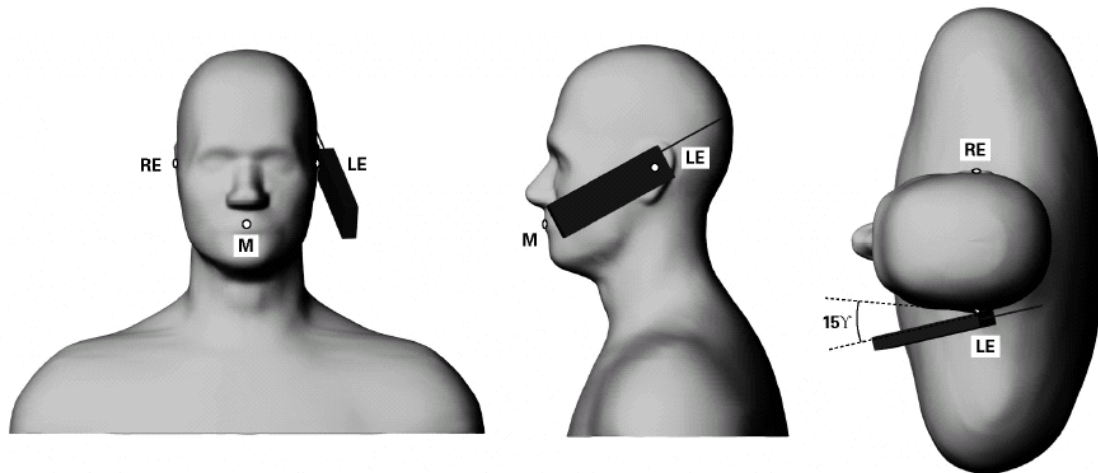

➤ Body position:

Body-worn operating configurations are tested with the belt-clips and holsters attached to the device and positioned against a flat phantom in a normal use configuration. A device with a headset output are tested with a headset connected to the device.

Accessories for Body-worn operation configurations are divided into two categories: those that do not contain metallic components and those that do contain metallic components. When multiple accessories that do not contain metallic components are supplied with the device, the device is tested with only the accessory that dictates the closest spacing to the body. Then multiple accessories that contain metallic components are tested with the device with each accessory. If multiple accessories share an identical metallic component (i.e. the same metallic belt-clip used with different holsters with no other metallic components) only the accessory that dictates the closest spacing to the body is tested.

Body-worn accessories may not always be supplied or available as options for some devices intended to be authorized for body-worn use. In this case, a test configuration with a separation distance between the back of the device and the flat phantom is used. Test position spacing was documented.

Transmitters that are designed to operate in front of a person's face, as in push-to-talk configurations, are test for SAR compliance with the front of the device positioned to face the flat phantom in brain fluid. For devices that are carried next to the body such as a shoulder, waist or chest-worn transmitters, SAR compliance is tested with the accessories, including headsets and microphones, attached to the device and positioned against a flat phantom in a normal use configuration.

In all cases SAR measurements are performed to investigate the worst-case positioning. Worst-case positioning is then documented and used to perform Body SAR testing.

In this test case, a belt position maintained a distance of approximately 1.5 cm between the back of the device and the flat phantom. The device was placed under the flat section of the phantom and suspended. The device is not provided with belt- clip.

Flextronics (China) Electronics Technology Co., Ltd. Flexmobile Test Laboratory	 	Document No: DCP-BEJLM-TSRP-080020a.1
SAR Test Report		

4.5 Test to be performed

The SAR test shall be performed with both phone positions described above, on the left and right side of the phantom. The devices shall be measured for all modes operation when the device is next to the ear, even if the different models operate in the same frequency band. First the SAR test shall be performed using the center frequency of each available operating band and mode with the maximum peak power level. At the device position with highest SAR (check or tilted, left and right), the test is repeated at lowest and highest frequency. In addition, for all other device positions respectively configurations where the spatial peak SAR value is within 2dB of the 1.6W/kg limit, the lowest and highest frequencies should be tested.

For devices with retractable antenna all of the tests described above shall be performed with the antenna fully extended and fully retracted. Other factors that may affect the exposure should also be tested. For example, optional antennas or optional battery packs which may significantly change the volume, lengths, flip open/closed, etc. of the device, or any other accessories which might have the potential to considerably increase the peak spatial-average SAR value.

5 TEST PROCEDURE

5.1.1 Test Equipment List

DASY is an abbreviation of “Dosimetric Assessment System” and describes a system that is able to determine the SAR distribution inside a phantom of a human being according to different standards. The DASY4 system consists of the following items:

TYPE	ITEM	S/N	CALIBRATION DATE	DUE DATE
CMU200	Wireless Communication Test Set	109172	2007-03-22	2008-03-21
ES3DV3	probe	3109	2007-11-12	2008-11-11
SD000D04BC	DAE4	685	2007-11-08	2008-11-07
D835V2	dipole	4d038	2007-11-12	2008-11-11
D1900V2	dipole	5d072	2007-11-13	2008-11-12
NRVD	Power Meter	83584310014	2007-12-14	2008-12-13
SME03	Signal Generator	100029	2007-12-27	2008-12-26
NRV-Z4	Power Sensor	100381	2007-09-27	2008-09-26
NRV-Z2	Power Sensor	100211	2007-09-27	2008-09-26
8491B	Attenuator	MY39262528	NA	NA
8491B	Attenuator	MY39262663	NA	NA
8491B	Attenuator	MY39262640	NA	NA
8491B	Attenuator	MY39262638	NA	NA
778D	Dual directional coupler	20040	NA	NA
E3640A	DC Power Supply	MY40008487	2007-08-14	2008-08-13
85070E	Probe kit	MY44300214	N.A.	N.A.
E5071B	Network Analyzer	MY42404001	2007-06-18	2008-06-17

The certifications of DASY4 E-field probe and dipole are attached in the annex document No. DCP-BEJLM-TSRP-080020.a.1-A01.

SAR Test Report

5.1.2 Test System Setup

Tests are performed in setup according to the scheme below:

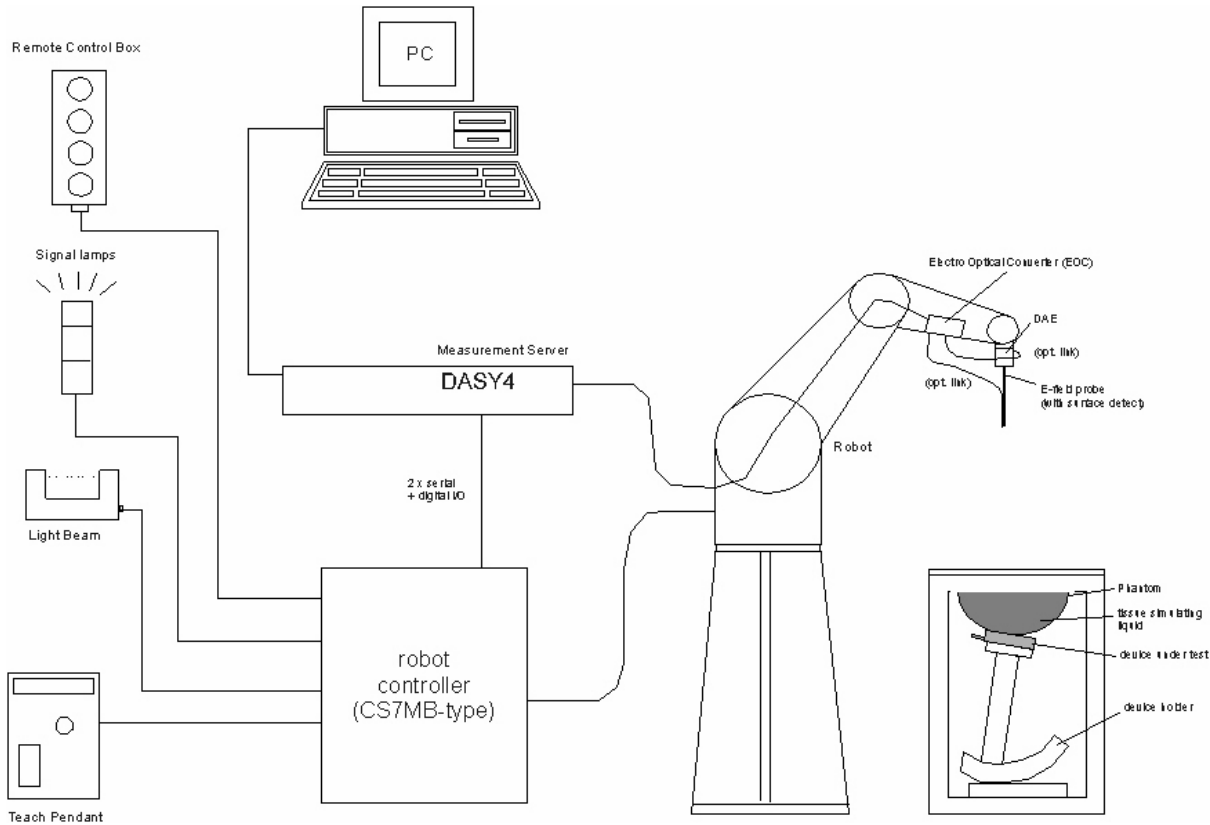

5.2 Measurement Procedure

The following steps are used for each test position:

1. The SAR measurement was taken at a selected spatial reference point to monitor power variations during testing. This fixed location point was measured and used as a reference value.
2. The SAR distribution at the exposed side of the head was measured at a distance of 3.9mm from the inner surface of the shell. The area covered the entire dimension of the head and the horizontal grid spacing was 15mm x 15mm.
3. Based on the area scan data, the area of the maximum absorption was determined by spline interpolation. Around this point, a volume of 32mm x 32mm x 30mm (fine resolution volume scan, zoom scan) was assessed by measuring 5 x 5 x 7 points. On this basis of this data set, the spatial peak SAR value was evaluated with the following procedure:
 - a. The data at the surface was extrapolated, since the center of the dipoles is 2.7mm away from the tip of the probe and the distance between the surface and the lowest measuring point is 1.2mm. The extrapolation was based on a least square algorithm. A polynomial of the fourth order was calculated through the points in z-axis. This polynomial was then used to evaluate the points between the surface and the probe tip.

SAR Test Report

- b. The maximum interpolated value was searched with a straight-forward algorithm. Around this maximum the SAR values averaged over the spatial volumes (1g or 10g) were computed using the 3D-Spline interpolation algorithm. The 3D-spline is composed of three one-dimensional splines with the “Not a knot” condition (in x, y, and z directions). The volume was integrated with the trapezoidal algorithm. One thousand points (10 x 10 x 10) were interpolated to calculate the average.
- c. All neighboring volumes were evaluated until no neighboring volume with a higher average value was found.
- 4. The SAR reference value, at the same location as procedure #1, was remeasured. If the value changed by more than 5%, the evaluation is repeated.

5.3 Test positions for device under test

Head SAR touch position:



SAR Test Report

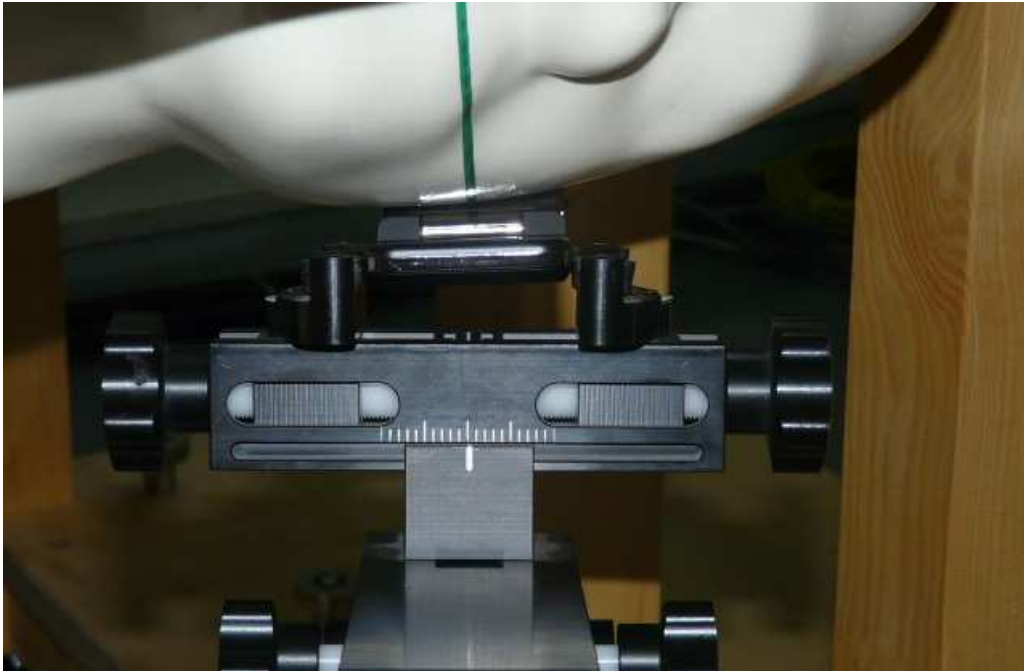

Head SAR tilt position:



SAR Test Report

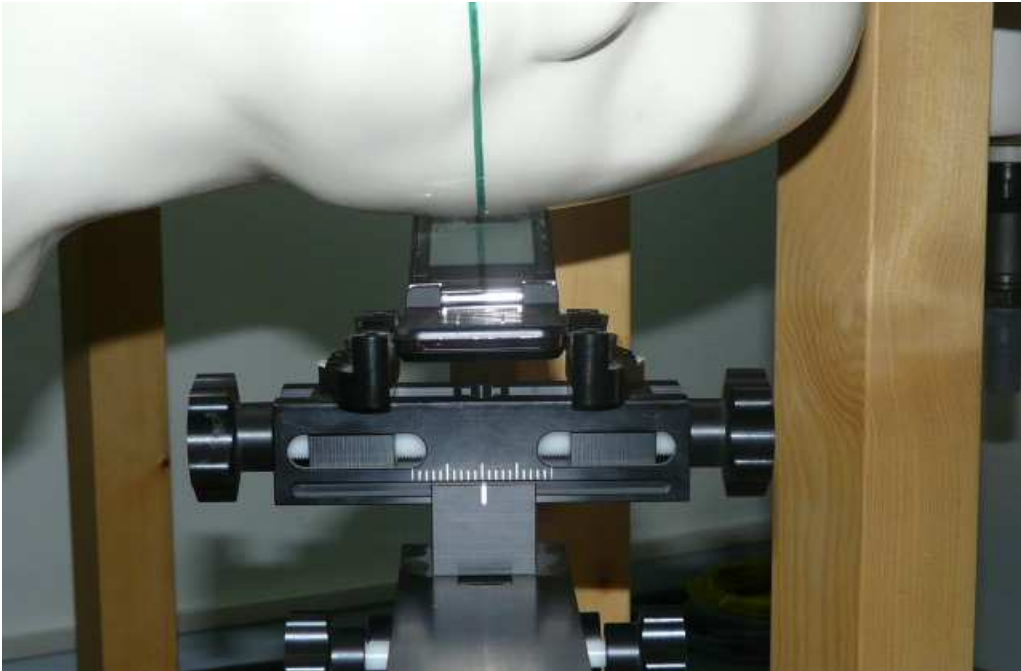

Body position with earphone:

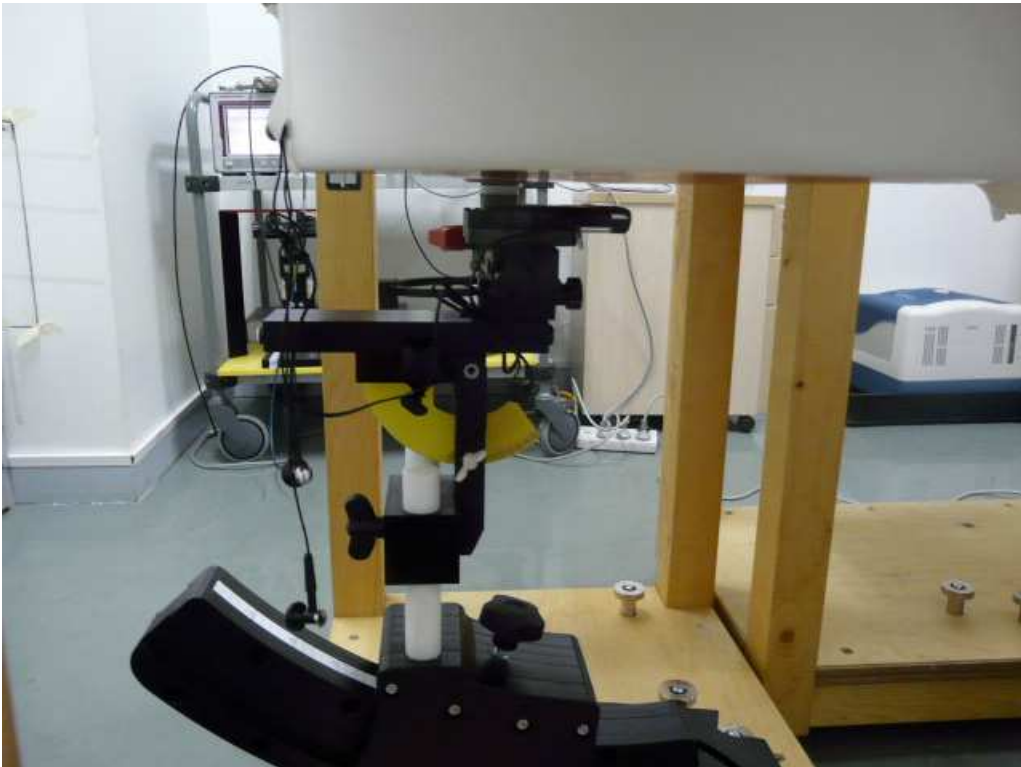

Body position without earphone



5.4 Test environment

	Ambient humidity (%)	Ambient temperature (°C)	Liquid temperature (°C)
standard	30~~70	20~~25	20~~24
Date: 2008-03-14	52	23	21.9
Date: 2008-03-17	46	23	23
Date: 2008-03-18	46	23	23.1
Date: 2008-03-19	40	24	23

5.5 Liquid parameters

Prior to conducting SAR measurements, the relative permittivity ϵ_r , and the conductivity σ , of the tissue simulating liquids were measured with the Dielectric Probe Kit. These values of the tissue simulate are shown in the table below. The recommended limits for maximum permittivity and minimum conductivity are also shown.

SAR Test Report

Date: 2008-03-14

Frequency	Tissue Type	Type	Dielectric Parameters	
			permittivity	conductivity
835	Head	Target	41.5	0.90
		±5% window	39.425~43.575	0.855~0.945
		Measured	41.7	0.885

Date: 2008-03-17

1900	Head	Target	40.0	1.38
		±5% window	38.00~42.00	1.33~1.47
		Measured	38.72	1.427

Date: 2008-03-18

1900	Body	Target	53.3	1.52
		±5% window	50.635~55.965	1.444~1.596
		Measured	52.3	1.446

Date: 2008-03-19

835	Body	Target	55.0	0.97
		±5% window	±5% window	52.25~57.75
		Measured	54.2	0.983

SAR Test Report

5.6 System performance check

A system check measurement was made following the determination of the dielectric parameters of the tissue simulating liquids using the dipole validation kit. A power level of 250 mW was supplied to the dipole antenna, which was placed under the flat section of the twin SAM phantom. For power setup, please see the following pictures:

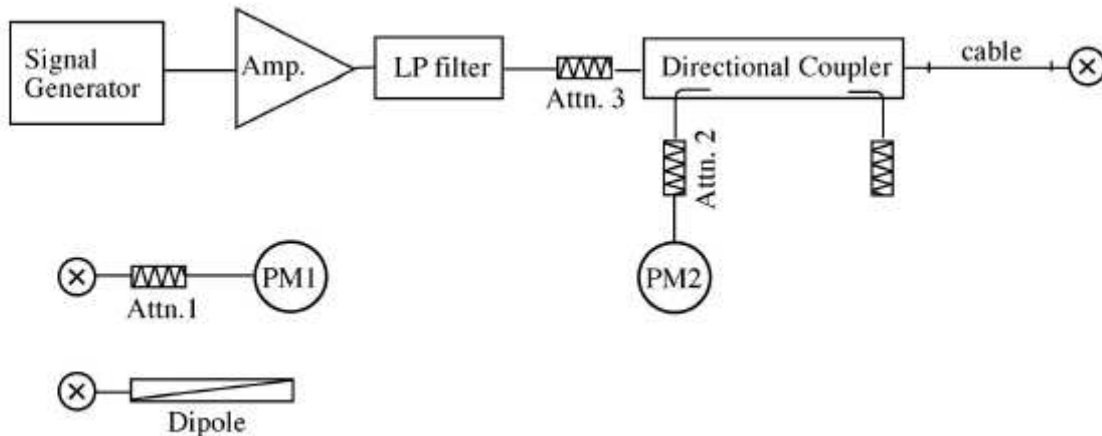

The figure shows the recommended setup. The PM1 (incl. Att1) measures the forward power at the location of the system performance check dipole connector. The signal generator is adjusted for the desired forward power at the dipole connector and the power meter PM2 is read at that level. After connecting the cable to the dipole, the signal generator is readjusted for the same reading at power meter PM2. The system checking results are given in the table below. Please see Annex B for detailed report.

Date:	Tissue	Input Power (mW)	Targeted SAR _{1g} (mW/g)	Measured SAR _{1g} (mW/g)	Deviation (%) (<±10%)
2008-03-14	835MHz Head	250	2.38	2.27	4.8
2008-03-17	1900MHz Head	250	9.85	10.4	5.5
2008-03-18	1900MHZ Body	250	9.41	9.6	2.0
2008-03-19	835MHZ Body	250	2.39	2.39	0.0

6 TEST RESULTS AND EVALUATION

6.1 Prepare measurement Results

The test results are used from a phone with the same function and hardware, but with different logo (see the right part in the following picture), and the customer declared that the logo contains no metal material. Please see the picture below with the two mobile phones.



Liquid tissue depth is 15.1 ± 0.1 cm.

The Device (FCC ID RV2MEGA1) has the 730mAH Lithium Ion Rechargeable Battery as the only battery option. This battery was used to do all of the SAR testing. The phone was placed in the SAR measurement system with a fully charged battery.

For head SAR, the device should be tested on the left and right side of the head phantom in the “Cheek/Touch” and “Ear/Tilt” positions, and for body SAR the device should be tested back and front positions to the flat phantom. When applicable, each configuration should be tested with the antenna in its fully extended and fully retracted positions. These test configurations should be tested at the high, middle and low frequency channels of each operating mode; for example, AMPS, CDMA, and TDMA. If the SAR measured at the middle channel for each test configuration (left, right, Cheek/Touch, Tile/Ear, extended and retracted) is at least 2.0 dB lower than the SAR limit, testing at the high and low channels is optional for such test configuration(s).

For Body SAR, tests are performed back and front to the flat phantom, the separate distance is 15mm. And earphone is connected to the DUT in GSM test mode.

The conducted power has been compensated with cable loss and connector loss.

GSM 850	Cable loss [dB]	Channel	Channel 128 [low] 824.20 MHz	Channel 190 [mid] 836.60 MHz	Channel 251 [high] 848.80 MHz
	0.4	Conducted power [dBm]	32.5	32.5	32.6
GSM 1900	Cable loss [dB]	Channel	Channel 512 [low] 1850.2 MHz	Channel 661 [Mid] 1880.0 MHz	Channel 810 [high] 1909.8 MHz
	0.5	Conducted power [dBm]	29.4	29.5	29.4

6.2 SAR Test results

6.2.1 Head SAR test results

GSM 850

Test configuration	Test position	SAR _{1g} [W/kg] / Power Drift [dB]		
		Channel 128 [low] 824.20 MHz	Channel 190 [Mid] 836.60 MHz	Channel 251 [high] 848.80 MHz
Left side of Head	Cheek	- / -	0.373 / 0.126	- / -
	Tilted	- / -	0.128 / 0.0192	- / -
Right side of Head	Cheek	0.373 / 0.0313	0.447 / 0.0559	0.576 / 0.0496¹
	Tilted	- / -	0.135 / 0.0344	- / -
Right side of Head with Bluetooth on	Cheek	- / -	/	0.5 / -0.0711

¹ Maximum test results specified in 6.4.1

GSM 1900

Test configuration	Test position	SAR _{1g} [W/kg] / Power Drift [dB]		
		Channel 512 [low] 1850.2 MHz	Channel 661 [Mid] 1880.0 MHz	Channel 810 [high] 1909.8 MHz
Left side of Head	Cheek	- / -	0.314 / -0.0201	- / -
	Tilted	- / -	0.352 / -0.0373	- / -
Right side of Head	Cheek	0.435 / -0.0504	0.55 / 0.0708²	0.503 / -0.0471
	Tilted	- / -	0.318 / 0.178	- / -
Right side of Head with Bluetooth on	Cheek	- / -	0.513 / 0.049	- / -

² Maximum test results specified in 6.4.2

6.2.2 Body SAR test results

GSM 850

Test configuration	Test position	SAR _{1g} [W/kg] / Power Drift [dB]		
		Channel 128 [low] 824.20 MHz	Channel 190 [Mid] 836.60 MHz	Channel 251 [high] 848.80 MHz
Front side with earphone	15 mm	- / -	0.102 / -0.0304	- / -
Back side with earphone	15 mm	0.24 / 0.00809	0.246 / 0.0214 ³	0.211 / 0.0161

³ Maximum test results specified in 6.4.3

GPRS 850

Test configuration	Test position	SAR _{1g} [W/kg] / Power Drift [dB]		
		Channel 128 [low] 824.20 MHz	Channel 190 [Mid] 836.60 MHz	Channel 251 [high] 848.80 MHz
Front side	15 mm	- / -	0.125 / -0.0735	- / -
Back side	15 mm	0.26 / 0.0136	0.265 / 0.0426	0.216 / 0.0605
Back side with Bluetooth on	15 mm	/	0.282 / 0.017 ⁴	/

⁴ Maximum test results specified in 6.4.4

GSM 1900

Test configuration	Test position	SAR _{1g} [W/kg] / Power Drift [dB]		
		Channel 512 [low] 1850.2 MHz	Channel 661 [Mid] 1880.0 MHz	Channel 810 [high] 1909.8 MHz
Front side with earphone	15mm	- / -	0.107 / 0.106	- / -
Back side with earphone	15 mm	0.188 / 0.0245	0.218 / -0.023	0.234 / -0.0454
Back side with earphone and Blue tooth on	15 mm	/	/	0.25 / -0.0136 ⁵

⁵ Maximum test results specified in 6.4.5

Flextronics (China) Electronics Technology Co., Ltd. Flexmobile Test Laboratory		Document No: DCP-BEJLM-TSRP-080020a.1
SAR Test Report		

GPRS1900

Test configuration	Test position	SAR _{1g} [W/kg] / Power Drift [dB]		
		Channel 512 [low] 1850.2 MHz	Channel 661 [Mid] 1880.0 MHz	Channel 810 [high] 1909.8 MHz
Front side	15mm	- / -	0.103 / -0.0144	- / -
Back side	15 mm	0.201 / 0.0154	0.196 / -0.0259	0.213 / -0.0114 ⁶

⁶ Maximum test results specified in 6.4.6

6.3 Summary and comparison to the limit

All test results are passed the uncontrolled SAR limit of 1.6W/kg.

SAR Test Report

6.4 Detailed Measurement Report

6.4.1 Maximum head SAR of GSM 850

File Name: [MEGA1-GSM850-RC-135790246811220-080314.da4](#)

DUT: MEGA1; IEEI: 135790246811220; Position: Right Cheek

Communication System: GSM850; Frequency: 848.8 MHz; Duty Cycle: 1:8.3
Medium parameters used (interpolated): $f = 848.8$ MHz; $\sigma = 0.897$ mho/m; $\epsilon_r = 41.5$; $\rho = 1000$ kg/m³ ;
Medium Notes: Ambient humidity:52; Ambient temperature: 23; Liquid temperature: 21.9;
Phantom section: Right Section ;Phantom: SAM with Right;Type: QD 000 P40 CA

DASY4 Configuration:

- Probe: ES3DV3 - SN3109; ConvF(6.02, 6.02, 6.02); Calibrated: 2007-11-12
- Sensor-Surface: 4mm (Mechanical Surface Detection)
- Electronics: DAE4 Sn685; Calibrated: 2007-11-8
- Measurement SW: DASY4, V4.7 Build 55; Postprocessing SW: SEMCAD, V1.8 Build 171

high/Zoom Scan (5x5x7)/Cube 0: Measurement grid: dx=8mm, dy=8mm, dz=5mm

Reference Value = 5.46 V/m; Power Drift = 0.050 dB

Peak SAR (extrapolated) = 0.843 W/kg

SAR(1 g) = 0.576 mW/g; SAR(10 g) = 0.406 mW/g

[Info: Interpolated medium parameters used for SAR evaluation.](#)

Maximum value of SAR (measured) = 0.617 mW/g

high/Area Scan (61x131x1): Measurement grid: dx=15mm, dy=15mm

[Info: Interpolated medium parameters used for SAR evaluation.](#)

Maximum value of SAR (interpolated) = 0.610 mW/g

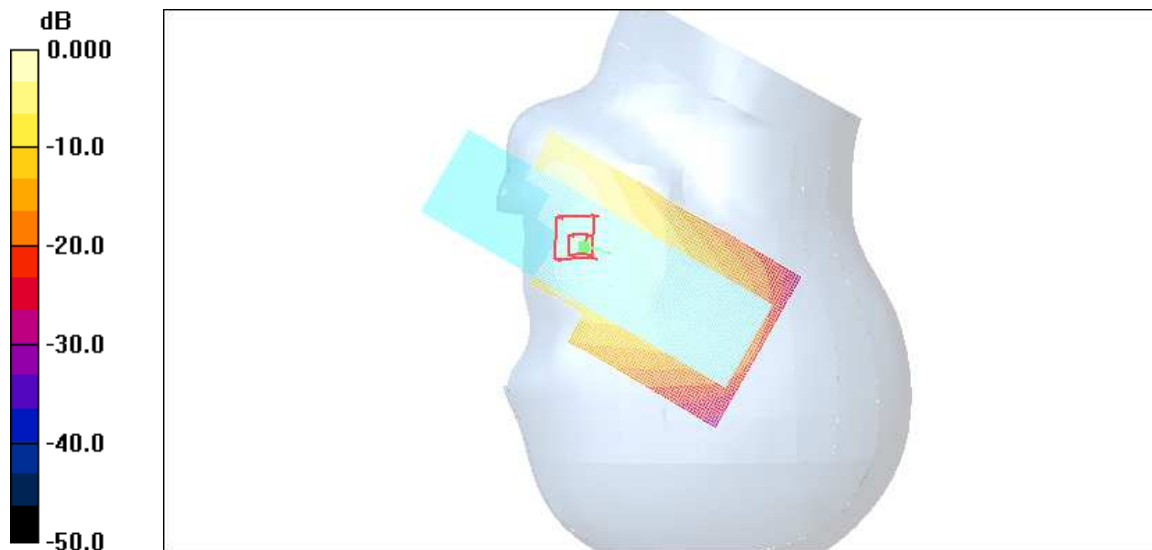

SAR Test Report

6.4.2 Maximum head SAR of GSM 1900

File Name: [MEGA1-GSM1900-RC-135790246811220-080317.da4](#)

DUT: MEGA1; IMEI: 135790246811220; Position: Right Cheek

Communication System: PCS 1900; Frequency: 1880 MHz; Duty Cycle: 1:8.3
Medium parameters used (interpolated): $f = 1880$ MHz; $\sigma = 1.41$ mho/m; $\epsilon_r = 38.8$; $\rho = 1000$ kg/m³ ;
Medium Notes: Ambient humidity:46; Ambient temperature: 23; Liquid temperature: 23;
Phantom section: Right Section ;Phantom: SAM with Front;Type: QD 000 P40 CA

DASY4 Configuration:

- Probe: ES3DV3 - SN3109; ConvF(4.63, 4.63, 4.63); Calibrated: 2007-11-12
- Sensor-Surface: 4mm (Mechanical Surface Detection)
- Electronics: DAE4 Sn685; Calibrated: 2007-11-8
- Measurement SW: DASY4, V4.7 Build 55; Postprocessing SW: SEMCAD, V1.8 Build 171

mid/Area Scan (61x131x1): Measurement grid: dx=15mm, dy=15mm

[Info: Interpolated medium parameters used for SAR evaluation.](#)

Maximum value of SAR (interpolated) = 0.650 mW/g

mid/Zoom Scan (5x5x7)/Cube 0: Measurement grid: dx=8mm, dy=8mm, dz=5mm

Reference Value = 4.65 V/m; Power Drift = 0.071 dB

Peak SAR (extrapolated) = 0.941 W/kg

SAR(1 g) = 0.550 mW/g; SAR(10 g) = 0.307 mW/g

[Info: Interpolated medium parameters used for SAR evaluation.](#)

Maximum value of SAR (measured) = 0.606 mW/g

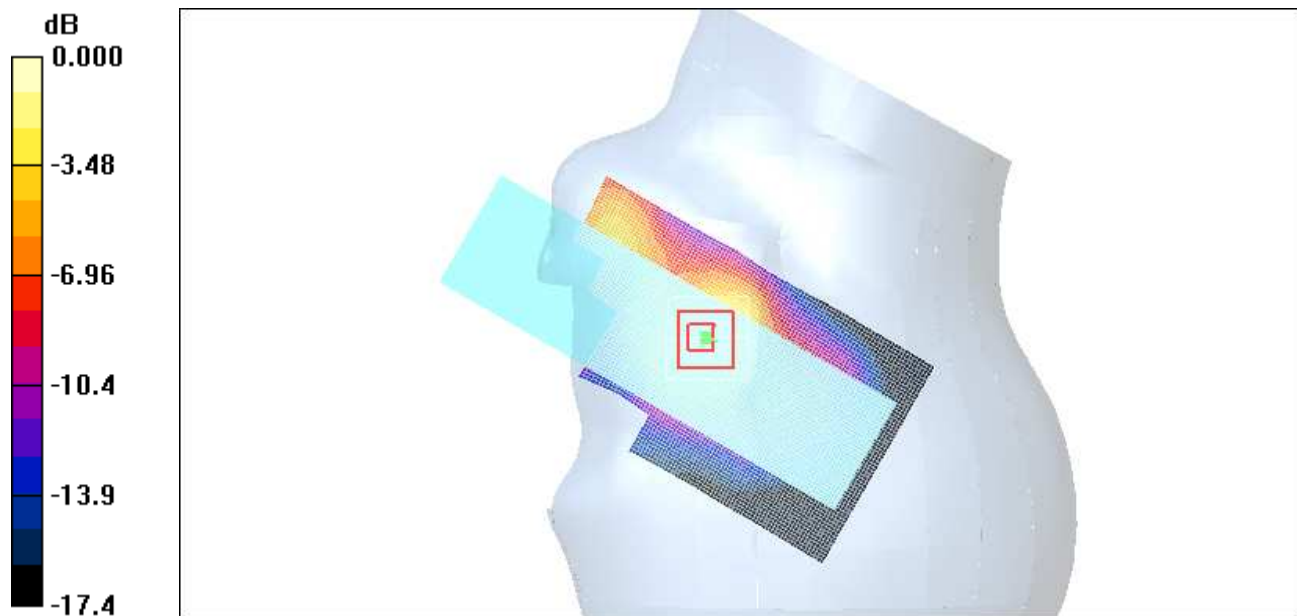

SAR Test Report

6.4.3 Maximum body SAR of GSM 850

File Name: [MEGA1-GSM850-BB-135790246811220-080319-With earphone.da4](#)

DUT: MEGA1; IMEI: 135790246811220; Position: Back

Communication System: GSM850; Frequency: 836.6 MHz; Duty Cycle: 1:8.3
Medium parameters used (interpolated): $f = 836.6$ MHz; $\sigma = 0.985$ mho/m; $\epsilon_r = 54.2$; $\rho = 1000$ kg/m³ ;
Medium Notes: Ambient humidity:40; Ambient temperature: 24; Liquid temperature: 23;
Phantom section: Flat Section ;Phantom: Flat Phantom ELI4.0;Type: QDOVA001BA

DASY4 Configuration:

- Probe: ES3DV3 - SN3109; ConvF(5.82, 5.82, 5.82); Calibrated: 2007-11-12
- Sensor-Surface: 4mm (Mechanical Surface Detection)
- Electronics: DAE4 Sn685; Calibrated: 2007-11-8
- Measurement SW: DASY4, V4.7 Build 55; Postprocessing SW: SEMCAD, V1.8 Build 171

mid/Area Scan (61x81x1): Measurement grid: dx=15mm, dy=15mm

[Info: Interpolated medium parameters used for SAR evaluation.](#)

Maximum value of SAR (interpolated) = 0.265 mW/g

mid/Zoom Scan (5x5x7)/Cube 0: Measurement grid: dx=8mm, dy=8mm, dz=5mm

Reference Value = 8.36 V/m; Power Drift = 0.021 dB

Peak SAR (extrapolated) = 0.333 W/kg

SAR(1 g) = 0.246 mW/g; SAR(10 g) = 0.171 mW/g

[Info: Interpolated medium parameters used for SAR evaluation.](#)

Maximum value of SAR (measured) = 0.262 mW/g

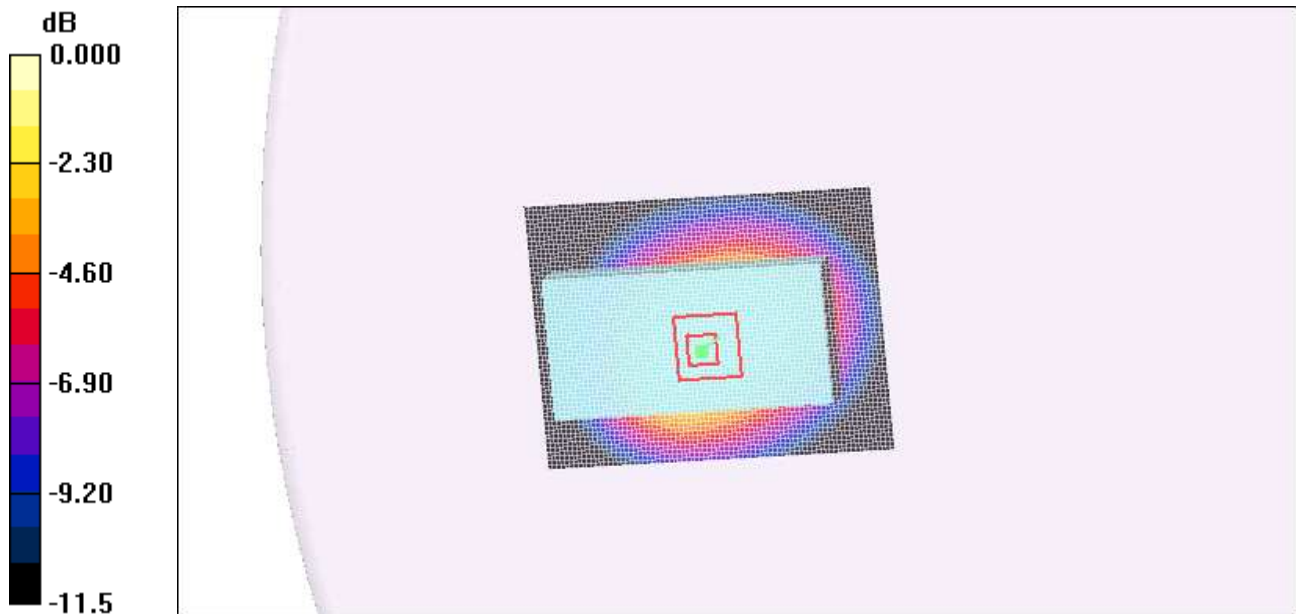

0 dB = 0.262mW/g

SAR Test Report

6.4.4 Maximum body SAR of GPRS 850

File Name: [MEGA1-GPRS850-BB-135790246811220-080319-Without earphone-BT on.da4](#)

DUT: MEGA1; IMEI: 135790246811220; Position: Back

Communication System: GSM850; Frequency: 836.6 MHz; Duty Cycle: 1:8.3
Medium parameters used (interpolated): $f = 836.6$ MHz; $\sigma = 0.985$ mho/m; $\epsilon_r = 54.2$; $\rho = 1000$ kg/m³ ;
Medium Notes: Ambient humidity:40; Ambient temperature: 24; Liquid temperature: 23;
Phantom section: Flat Section ;Phantom: Flat Phantom ELI4.0;Type: QDOVA001BA

DASY4 Configuration:

- Probe: ES3DV3 - SN3109; ConvF(5.82, 5.82, 5.82); Calibrated: 2007-11-12
- Sensor-Surface: 4mm (Mechanical Surface Detection)
- Electronics: DAE4 Sn685; Calibrated: 2007-11-8
- Measurement SW: DASY4, V4.7 Build 55; Postprocessing SW: SEMCAD, V1.8 Build 171

mid/Area Scan (61x81x1): Measurement grid: dx=15mm, dy=15mm

[Info: Interpolated medium parameters used for SAR evaluation.](#)

Maximum value of SAR (interpolated) = 0.304 mW/g

mid/Zoom Scan (5x5x7)/Cube 0: Measurement grid: dx=8mm, dy=8mm, dz=5mm

Reference Value = 8.69 V/m; Power Drift = 0.017 dB

Peak SAR (extrapolated) = 0.378 W/kg

SAR(1 g) = 0.282 mW/g; SAR(10 g) = 0.195 mW/g

[Info: Interpolated medium parameters used for SAR evaluation.](#)

Maximum value of SAR (measured) = 0.300 mW/g

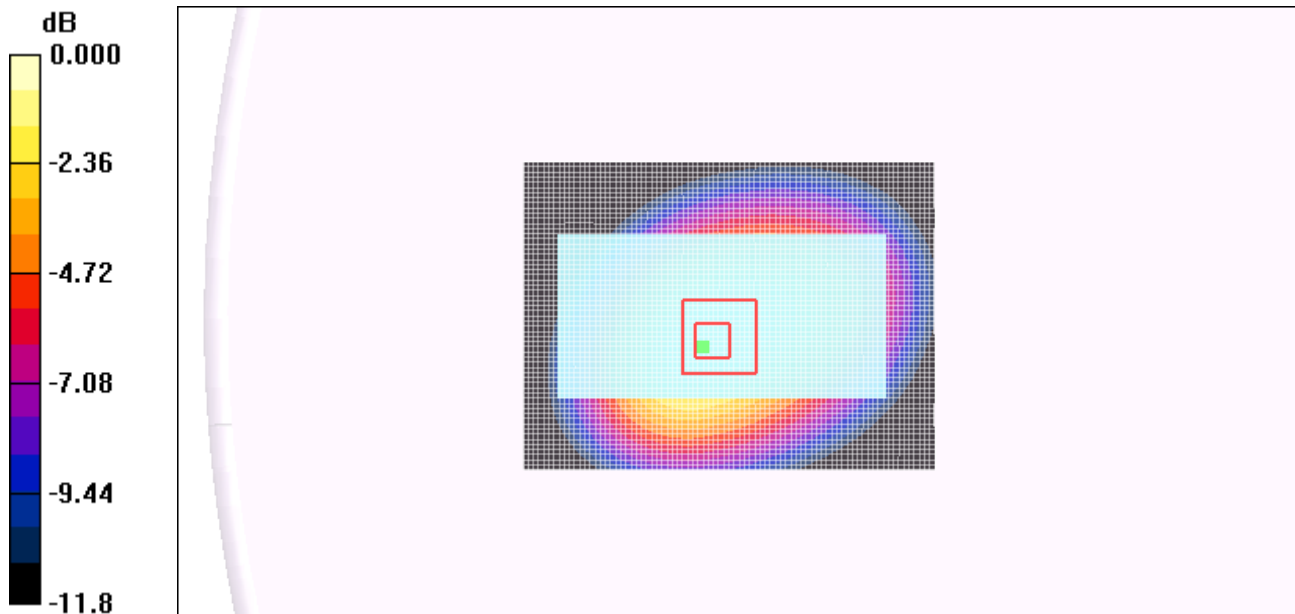

0 dB = 0.300mW/g

SAR Test Report

6.4.5 Maximum body SAR of GSM 1900

File Name: [MEGA1-GSM1900-BB-135790246811220-080318-With earphone BT on.da4](#)

DUT: MEGA1; IMEI: 135790246811220; Position:Back

Communication System: PCS 1900; Frequency: 1909.8 MHz; Duty Cycle: 1:8.3
Medium parameters used (interpolated): $f = 1909.8$ MHz; $\sigma = 1.46$ mho/m; $\epsilon_r = 52.3$; $\rho = 1000$ kg/m³ ;
Medium Notes: Ambient humidity:46; Ambient temperature: 23; Liquid temperature: 23.1;
Phantom section: Flat Section ;Phantom: Flat Phantom ELI4.0;Type: QDOVA001BA

DASY4 Configuration:

- Probe: ES3DV3 - SN3109; ConvF(4.41, 4.41, 4.41); Calibrated: 2007-11-12
- Sensor-Surface: 4mm (Mechanical Surface Detection)
- Electronics: DAE4 Sn685; Calibrated: 2007-11-8
- Measurement SW: DASY4, V4.7 Build 55; Postprocessing SW: SEMCAD, V1.8 Build 171

high/Zoom Scan (5x5x7)/Cube 0: Measurement grid: dx=8mm, dy=8mm, dz=5mm
Reference Value = 11.9 V/m; Power Drift = -0.014 dB
Peak SAR (extrapolated) = 0.421 W/kg
SAR(1 g) = 0.250 mW/g; SAR(10 g) = 0.140 mW/g

[Info: Interpolated medium parameters used for SAR evaluation.](#)

Maximum value of SAR (measured) = 0.274 mW/g

high/Area Scan (61x81x1): Measurement grid: dx=15mm, dy=15mm

[Info: Interpolated medium parameters used for SAR evaluation.](#)

Maximum value of SAR (interpolated) = 0.283 mW/g

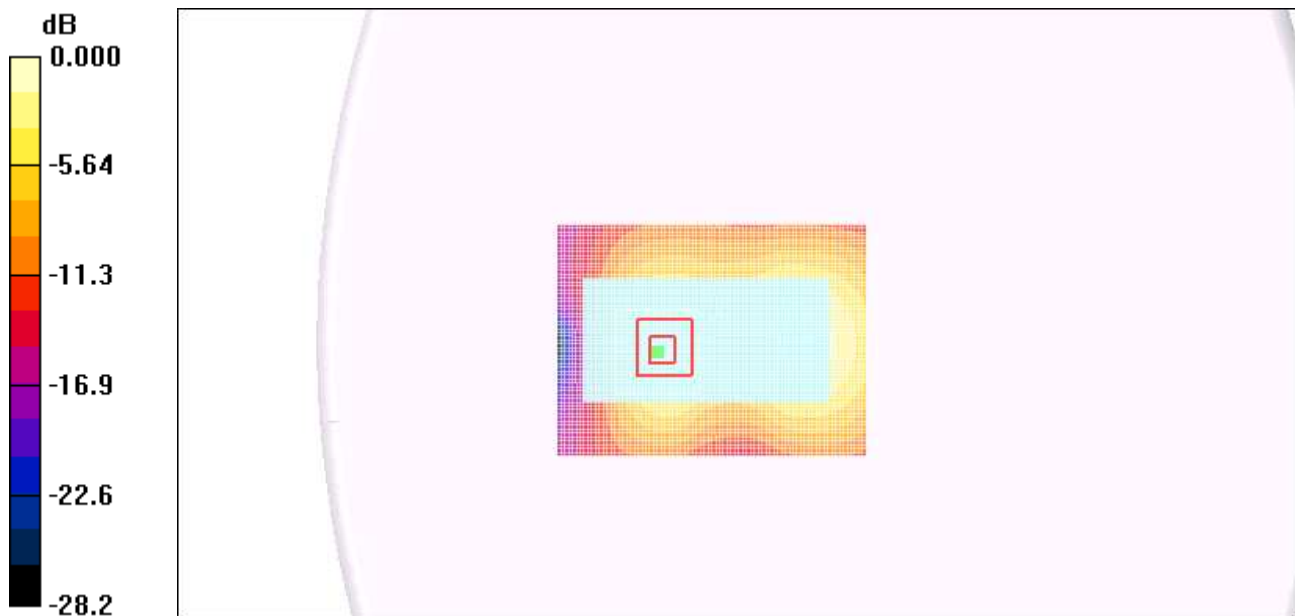

0 dB = 0.283mW/g

SAR Test Report

6.4.6 Maximum body SAR of GPRS 1900

File Name: [MEGA1-GPRS1900-BB-135790246811220-080318-Without earphone.da4](#)

DUT: MEGA1; IMEI: 135790246811220; Position: Back

Communication System: GPRS 1900 class 8; Frequency: 1909.8 MHz; Duty Cycle: 1:8.3
Medium parameters used (interpolated): $f = 1909.8$ MHz; $\sigma = 1.46$ mho/m; $\epsilon_r = 52.3$; $\rho = 1000$ kg/m³ ;
Medium Notes: Ambient humidity:46; Ambient temperature: 23; Liquid temperature: 23.1;
Phantom section: Flat Section ;Phantom: Flat Phantom ELI4.0;Type: QDOVA001BA

DASY4 Configuration:

- Probe: ES3DV3 - SN3109; ConvF(4.41, 4.41, 4.41); Calibrated: 2007-11-12
- Sensor-Surface: 4mm (Mechanical Surface Detection)
- Electronics: DAE4 Sn685; Calibrated: 2007-11-8
- Measurement SW: DASY4, V4.7 Build 55; Postprocessing SW: SEMCAD, V1.8 Build 171

high/Zoom Scan (5x5x7)/Cube 0: Measurement grid: dx=8mm, dy=8mm, dz=5mm

Reference Value = 11.0 V/m; Power Drift = -0.011 dB

Peak SAR (extrapolated) = 0.367 W/kg

SAR(1 g) = 0.213 mW/g; SAR(10 g) = 0.117 mW/g

[Info: Interpolated medium parameters used for SAR evaluation.](#)

Maximum value of SAR (measured) = 0.236 mW/g

high/Area Scan (61x81x1): Measurement grid: dx=15mm, dy=15mm

[Info: Interpolated medium parameters used for SAR evaluation.](#)

Maximum value of SAR (interpolated) = 0.249 mW/g

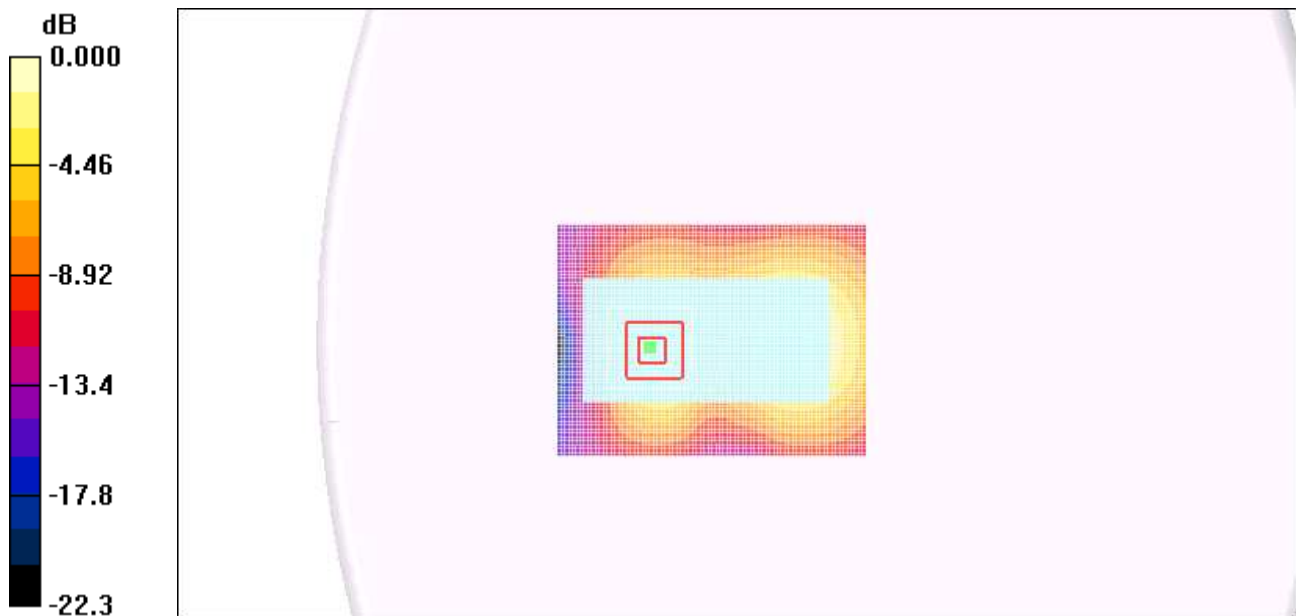

0 dB = 0.249mW/g

SAR Test Report

6.5 System performance check report

File Name: [SystemPerformanceCheck-D835Mhz-080314.da4](#)

DUT: Dipole 835 MHz;

Communication System: CW; Frequency: 835 MHz; Duty Cycle: 1:1
Medium parameters used (interpolated): $f = 835 \text{ MHz}$; $\sigma = 0.885 \text{ mho/m}$; $\epsilon_r = 41.7$; $\rho = 1000 \text{ kg/m}^3$;
Medium Notes: Ambient humidity:52; Ambient temperature: 23; Liquid temperature: 21.9;
Phantom section: Flat Section ;Phantom: SAM with Right;Type: QD 000 P40 CA

DASY4 Configuration:

- Probe: ES3DV3 - SN3109; ConvF(6.02, 6.02, 6.02); Calibrated: 2007-11-12
- Sensor-Surface: 4mm (Mechanical Surface Detection)
- Electronics: DAE4 Sn685; Calibrated: 2007-11-8
- Measurement SW: DASY4, V4.7 Build 55; Postprocessing SW: SEMCAD, V1.8 Build 171

2008-03-14/Area Scan (51x111x1): Measurement grid: dx=15mm, dy=15mm

[Info: Interpolated medium parameters used for SAR evaluation.](#)

Maximum value of SAR (interpolated) = 2.49 mW/g

2008-03-14/Zoom Scan (7x7x7)/Cube 0: Measurement grid: dx=5mm, dy=5mm, dz=5mm

Reference Value = 52.7 V/m; Power Drift = -0.037 dB

Peak SAR (extrapolated) = 3.35 W/kg

SAR(1 g) = 2.27 mW/g; SAR(10 g) = 1.49 mW/g

[Info: Interpolated medium parameters used for SAR evaluation.](#)

Maximum value of SAR (measured) = 2.45 mW/g

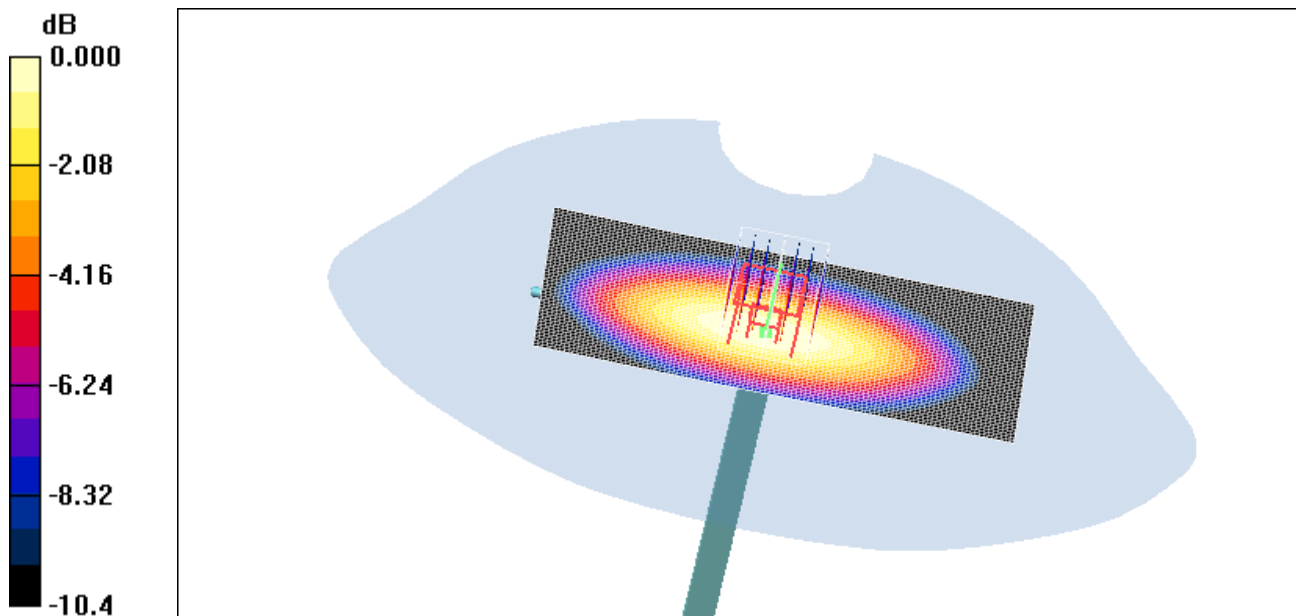

SAR Test Report

File Name: [SystemPerformanceCheck-D1900MHz-20080317.da4](#)

DUT: Dipole 1900 MHz;

Communication System: CW; Frequency: 1900 MHz; Duty Cycle: 1:1
Medium parameters used: $f = 1900$ MHz; $\sigma = 1.43$ mho/m; $\epsilon_r = 38.7$; $\rho = 1000$ kg/m³ ;
Medium Notes: Ambient humidity:46; Ambient temperature: 23; Liquid temperature: 23;
Phantom section: Flat Section ;Phantom: SAM with Front;Type: QD 000 P40 CA

DASY4 Configuration:

- Probe: ES3DV3 - SN3110; ConvF(4.96, 4.96, 4.96); Calibrated: 2008-1-28
- Sensor-Surface: 4mm (Mechanical Surface Detection)
- Electronics: DAE4 Sn685; Calibrated: 2007-11-8
- Measurement SW: DASY4, V4.7 Build 55; Postprocessing SW: SEMCAD, V1.8 Build 171

2008-03-17/Area Scan (61x71x1): Measurement grid: dx=15mm, dy=15mm
Maximum value of SAR (interpolated) = 12.9 mW/g

2008-03-17/Zoom Scan (7x7x7)/Cube 0: Measurement grid: dx=5mm, dy=5mm, dz=5mm
Reference Value = 84.4 V/m; Power Drift = -0.015 dB
Peak SAR (extrapolated) = 19.4 W/kg
SAR(1 g) = 10.4 mW/g; SAR(10 g) = 5.42 mW/g
Maximum value of SAR (measured) = 11.7 mW/g

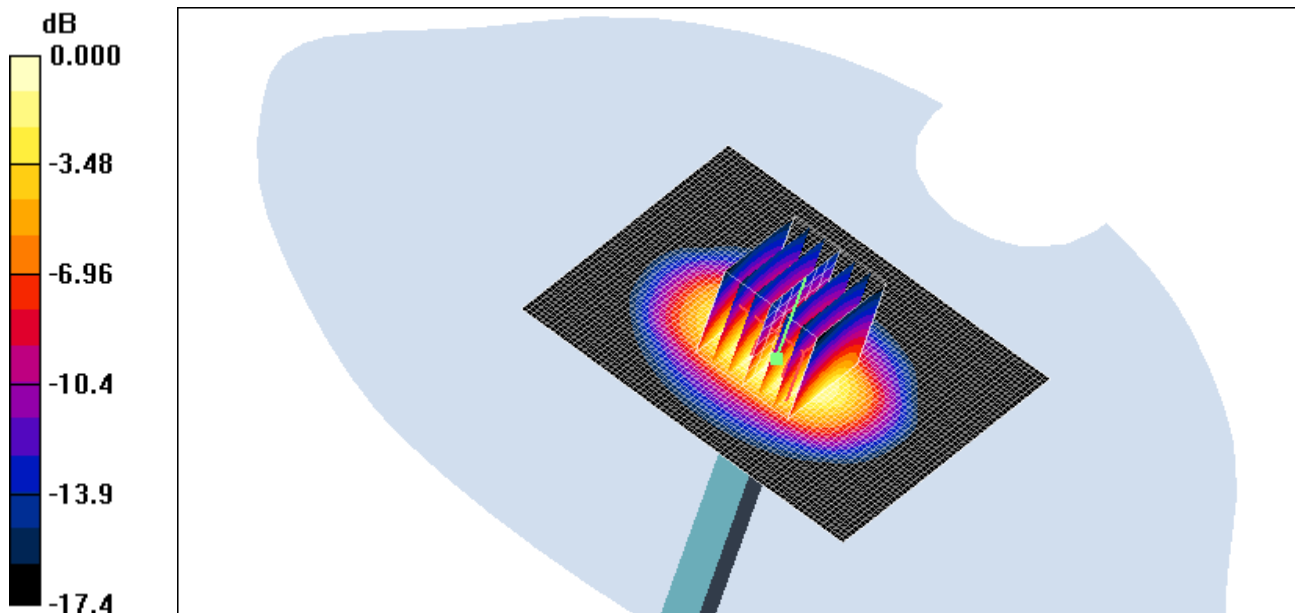

SAR Test Report

File Name: [SystemPerformanceCheck-body-D835MHz-20080319.da4](#)

DUT: Dipole 835 MHz;

Communication System: CW; Frequency: 835 MHz; Duty Cycle: 1:1
Medium parameters used (interpolated): $f = 835$ MHz; $\sigma = 0.983$ mho/m; $\epsilon_r = 54.2$; $\rho = 1000$ kg/m³ ;
Medium Notes: Ambient humidity:40; Ambient temperature: 24; Liquid temperature: 23;
Phantom section: Flat Section ;Phantom: Flat Phantom ELI4.0;Type: QDOVA001BA

DASY4 Configuration:

- Probe: ES3DV3 - SN3109; ConvF(5.82, 5.82, 5.82); Calibrated: 2007-11-12
- Sensor-Surface: 4mm (Mechanical Surface Detection)
- Electronics: DAE4 Sn685; Calibrated: 2007-11-8
- Measurement SW: DASY4, V4.7 Build 55; Postprocessing SW: SEMCAD, V1.8 Build 171

MSL/Area Scan (61x111x1): Measurement grid: dx=15mm, dy=15mm

[Info: Interpolated medium parameters used for SAR evaluation.](#)

Maximum value of SAR (interpolated) = 2.59 mW/g

MSL/Zoom Scan (7x7x7)/Cube 0: Measurement grid: dx=5mm, dy=5mm, dz=5mm

Reference Value = 50.3 V/m; Power Drift = -0.033 dB

Peak SAR (extrapolated) = 3.44 W/kg

SAR(1 g) = 2.39 mW/g; SAR(10 g) = 1.58 mW/g

[Info: Interpolated medium parameters used for SAR evaluation.](#)

Maximum value of SAR (measured) = 2.58 mW/g

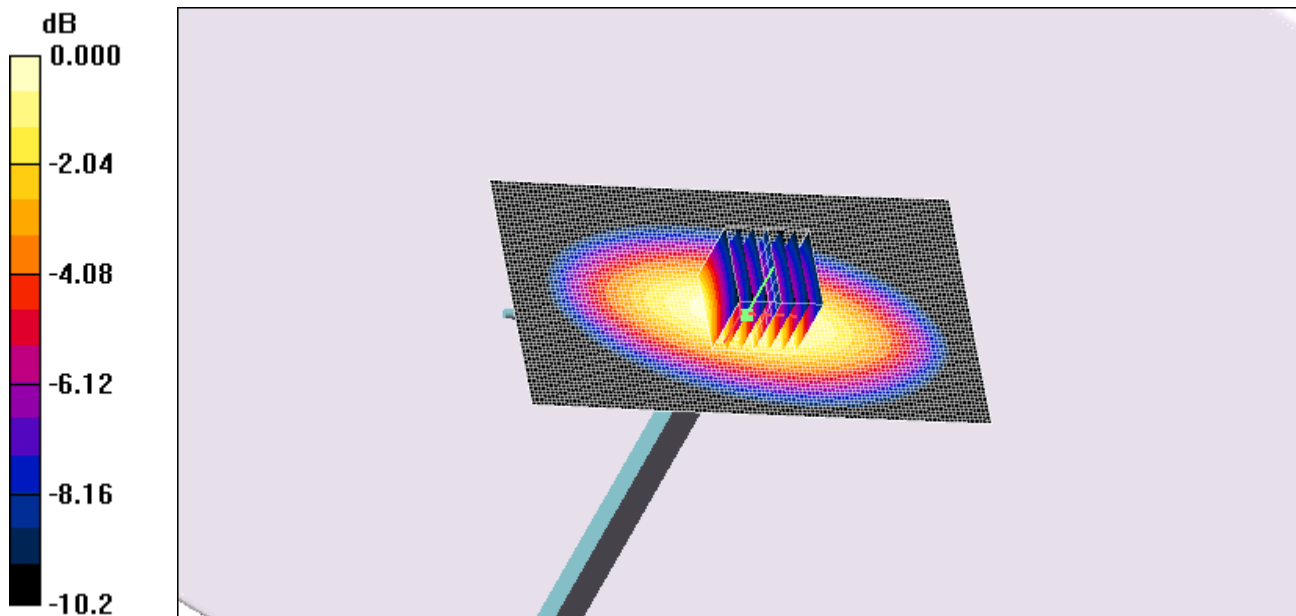

0 dB = 2.58mW/g

SAR Test Report

File Name: [SystemPerformanceCheck-Body-D1900MHz-20080318.da4](#)

DUT: Dipole 1900 MHz;

Communication System: CW; Frequency: 1900 MHz; Duty Cycle: 1:1
Medium parameters used: $f = 1900$ MHz; $\sigma = 1.45$ mho/m; $\epsilon_r = 52.3$; $\rho = 1000$ kg/m³ ;
Medium Notes: Ambient humidity:46; Ambient temperature: 23; Liquid temperature: 23.1;
Phantom section: Flat Section ;Phantom: Flat Phantom ELI4.0;Type: QDOVA001BA

DASY4 Configuration:

- Probe: ES3DV3 - SN3109; ConvF(4.41, 4.41, 4.41); Calibrated: 2007-11-12
- Sensor-Surface: 4mm (Mechanical Surface Detection)
- Electronics: DAE4 Sn685; Calibrated: 2007-11-8
- Measurement SW: DASY4, V4.7 Build 55; Postprocessing SW: SEMCAD, V1.8 Build 171

Body1900/Area Scan (61x71x1): Measurement grid: dx=15mm, dy=15mm
Maximum value of SAR (interpolated) = 12.4 mW/g

Body1900/Zoom Scan (7x7x7)/Cube 0: Measurement grid: dx=5mm, dy=5mm, dz=5mm
Reference Value = 83.5 V/m; Power Drift = -0.110 dB
Peak SAR (extrapolated) = 16.6 W/kg
SAR(1 g) = 9.6 mW/g; SAR(10 g) = 5.16 mW/g
Maximum value of SAR (measured) = 10.8 mW/g

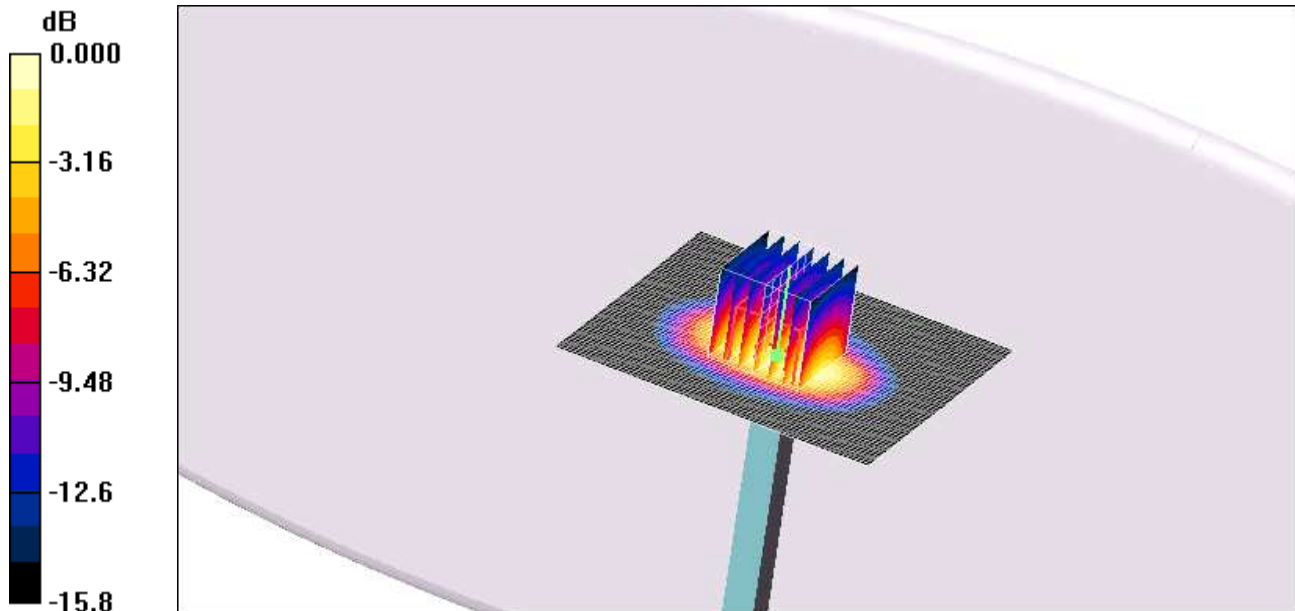

0 dB = 10.8mW/g

SAR Test Report

7 UNCERTAINTY BUDGET

It includes the uncertainty budget suggested by the [IEEE P1528] and determined by Schmid & Partner Engineering AG. **The expanded uncertainty (K=2) is assessed to be ±22.0%.**

Error Source	Type	Uncertainty Value (%)	Probability Distribution	ci	Standard Uncertainty (%) u_i (%)	Degree of freedom V_{eff} or v_i
System repetivity	A	0.5	N	1	1.5	4
Measurement system						
– probe calibration	B	5.9	N	1	5.9	∞
– axial isotropy of the probe	B	4.7	R	0.7	1.9	∞
– hemisphere isotropy of the probe	B	9.6	R	0.7	3.9	
– boundary effect	B	0.4	R	1	0.6	∞
– probe linearity	B	4.7	R	1	2.7	∞
– detection limit	B	1.0	R	1	0.6	∞
– Readout Electronics	B	1.0	N	1	0.3	∞
– response time	B	0.8	R	1	0.5	∞
– integration time	B	2.6	R	1	1.5	∞
– RF Ambient Noise	B	3.0	R	1	1.7	∞
– RF Ambient Reflections	B	3.0	R	1	1.7	∞
– Probe Positioning	B	0.4	R	1	0.2	∞
– Probe Positioning	B	2.9	R	1	1.7	∞
– Max. SAR Eval.	B	1.0	R	1	0.6	∞
Test Sample Related						
– Device Positioning	B	2.9	N	1	2.9	145
– Device Holder	B	3.6	N	1	3.6	∞
– Power Drift	B	5.0	R	1	2.9	∞
Phantom and setup						
– Phantom uncertainty	B	4.0	R	1	2.3	∞
– liquid conductivity (deviation from target)	B	5.0	R	0.64	1.8	∞
– liquid conductivity(measurement error)	B	2.5	N	0.64	1.6	∞
– liquid permittivity(deviation from target)	B	5.0	R	0.6	1.7	∞
– liquid permittivity(measurement error)	B	2.5	N	0.6	1.5	∞
– Combined Std. Uncertainty					11.0	∞
Expanded STD Uncertainty					22.0	∞

Flextronics (China) Electronics Technology Co., Ltd. Flexmobile Test Laboratory	FLEXTRONICS FLEXMobile	Document No: DCP-BEJLM-TSRP-080020a.1
SAR Test Report		

8 REFERENCE DOCUMENT

The DUT has been tested at Flextronics Mobile Test Laboratory according to the reference documents given below.

- [1] Federal Communications Commission: Evaluating Compliance with FCC Guidelines for Human Exposure to Radio frequency Electromagnetic Fields, Supplement C (Edition 01-01) to OET Bulletin 65 (Edition 97-01), FCC, 2001.
- [2] IEEE Std C95.1-1999: IEEE Standard for Safety Levels with Respect to Human Exposure to Radio Frequency Electromagnetic Fields, 3 kHz to 300 GHz, Inst. of Electrical and Electronics Engineer, Inc., 1999.
- [3] IEEE Std 1528-2003: IEEE Recommended Practice for Determining the Peak Spatial-Average Rate (SAR) in the Human Head from Wireless Communications Devices: Measurement Techniques. 1528-2003, December 19, 2003.the Institute of Electrical and Electronics Engineers.
- [4] Schmid & Partner Engineering AG, DASY4 Manual, February 2004 17-5.