



# DFS TEST REPORT

**REPORT NO.:** RF140714E01B-1

**MODEL NO.:** AT-TQ4600

**FCC ID:** RSL-TQ4600

**RECEIVED:** Jul. 24, 2014

**TESTED:** Nov. 20 ~ Nov. 24, 2014

**ISSUED:** Nov. 25, 2014

**APPLICANT:** Allied Telesis R&D Center K.K.

**ADDRESS:** 2nd TOC Bldg. 7-21-11 Nishi-Gotanda,  
Shinagawa-ku, Tokyo 141-0031, Japan

**ISSUED BY:** Bureau Veritas Consumer Products Services  
(H.K.) Ltd., Taoyuan Branch

**LAB ADDRESS:** No. 47-2, 14th Ling, Chia Pau Vil., Lin Kou Dist.,  
New Taipei City, Taiwan, R.O.C.

**TEST LOCATION:** No. 19, Hwa Ya 2nd Rd, Wen Hwa Tsuen, Kwei  
Shan Hsiang, Taoyuan Hsien 333, Taiwan, R.O.C.

This report should not be used by the client to claim product certification, approval, or endorsement by TAF or any government agencies.



This report is for your exclusive use. Any copying or replication of this report to or for any other person or entity, or use of our name or trademark, is permitted only with our prior written permission. This report sets forth our findings solely with respect to the test samples identified herein. The results set forth in this report are not indicative or representative of the quality or characteristics of the lot from which a test sample was taken or any similar or identical product unless specifically and expressly noted. Our report includes all of the tests requested by you and the results thereof based upon the information that you provided to us. You have 60 days from date of issuance of this report to notify us of any material error or omission caused by our negligence, provided, however, that such notice shall be in writing and shall specifically address the issue you wish to raise. A failure to raise such issue within the prescribed time shall constitute your unqualified acceptance of the completeness of this report, the tests conducted and the correctness of the report contents. Unless specific mention, the uncertainty of measurement has been explicitly taken into account to declare the compliance or non-compliance to the specification.



A D T

## TABLE OF CONTENTS

RELEASE CONTROL RECORD .....	3
1. CERTIFICATION .....	4
2. EUT INFORMATION .....	5
2.1 OPERATING FREQUENCY BANDS AND MODE OF EUT .....	5
2.2 EUT SOFTWARE AND FIRMWARE VERSION .....	5
2.3 DESCRIPTION OF AVAILABLE ANTENNAS TO THE EUT .....	5
2.4 EUT MAXIMUM CONDUCTED POWER .....	6
2.5 EUT MAXIMUM E.I.R.P. POWER .....	7
2.6 TRANSMIT POWER CONTROL (TPC) .....	8
2.7 STATEMENT OF MAUNFACTURER .....	8
3. U-NII DFS RULE REQUIREMENTS .....	9
3.1 WORKING MODES AND REQUIRED TEST ITEMS .....	9
3.2 TEST LIMITS AND RADAR SIGNAL PARAMETERS .....	10
4. TEST & SUPPORT EQUIPMENT LIST .....	13
4.1 TEST INSTRUMENTS .....	13
4.2 DESCRIPTION OF SUPPORT UNITS .....	13
5. TEST PROCEDURE .....	14
5.1 ADT DFS MEASUREMENT SYSTEM .....	14
5.2 CALIBRATION OF DFS DETECTION THRESHOLD LEVEL .....	15
5.3 DEVIATION FROM TEST STANDARD .....	15
5.4 RADIATED TEST SETUP CONFIGURATION .....	16
5.4.1 MASTER MODE .....	16
6. TEST RESULTS .....	17
6.1 SUMMARY OF TEST RESULTS .....	17
6.2 TEST RESULTS .....	18
6.2.1 TEST MODE: DEVICE OPERATING IN MASTER MODE .....	18
6.2.2 U-NII DETECTION BANDWIDTH .....	23
6.2.3 CHANNEL AVAILABILITY CHECK TIME .....	30
6.2.4 CHANNEL CLOSING TRANSMISSION AND CHANNEL MOVE TIME .....	32
6.2.5 NON- OCCUPANCY PERIOD .....	43
6.2.6 UNIFORM SPREADING .....	47
6.2.7 TRANSMIT POWER CONTROL (TPC) .....	47
7. INFORMATION ON THE TESTING LABORATORIES .....	48
APPENDIX A - MODIFICATIONS RECORDERS FOR ENGINEERING CHANGES TO THE EUT BY THE LAB .....	49



A D T

## RELEASE CONTROL RECORD

ISSUE NO.	REASON FOR CHANGE	DATE ISSUED
RF140714E01B-1	Original release	Nov. 25, 2014



A D T

## 1. CERTIFICATION

**PRODUCT:** Access Point

**MODEL:** AT-TQ4600

**BRAND:**  **Allied Telesis**

**APPLICANT:** Allied Telesis R&D Center K.K.

**TESTED:** Nov. 20 ~ Nov. 24, 2014

**TEST SAMPLE:** ENGINEERING SAMPLE

**STANDARDS:** **FCC Part 15, Subpart E (Section 15.407)**

FCC KDB 905462 D02

The above equipment (model: AT-TQ4600) has been tested by **Bureau Veritas Consumer Products Services (H.K.) Ltd., Taoyuan Branch**, and found compliance with the requirement of the above standards. The test record, data evaluation & Equipment Under Test (EUT) configurations represented herein are true and accurate accounts of the measurements of the sample's EMC characteristics under the conditions specified in this report.

**PREPARED BY** :  , **DATE** : Nov. 25, 2014  
Pettie Chen / Senior Specialist

**APPROVED BY** :  , **DATE** : Nov. 25, 2014  
Ken Liu / Senior Manager



## 2. EUT INFORMATION

### 2.1 OPERATING FREQUENCY BANDS AND MODE OF EUT

TABLE 1: OPERATING FREQUENCY BANDS AND MODE OF EUT

OPERATIONAL MODE	OPERATING FREQUENCY RANGE	
	5250~5350MHz	5470~5725MHz
Master	✓	✓

### 2.2 EUT SOFTWARE AND FIRMWARE VERSION

TABLE 2: THE EUT SOFTWARE/FIRMWARE VERSION

NO.	PRODUCT	MODEL NO.	SOFTWARE/FIRMWARE VERSION
1	Access Point	AT-TQ4600	FW Version: 3.0.0 A25

### 2.3 DESCRIPTION OF AVAILABLE ANTENNAS TO THE EUT

TABLE 3: ANTENNA LIST

ANT NO.	ANTENNA TYPE	OPERATION FREQUENCY RANGE (MHz)	MAX. GAIN (dBi)
1.	PIFA	5250-5725	2.65
2.	PIFA	5250-5725	4.15
3.	PIFA	5250-5725	4.04



## 2.4 EUT MAXIMUM CONDUCTED POWER

TABLE 4: THE MEASURED CONDUCTED OUTPUT POWER

### 802.11a

ANT NO.	FREQUENCY BAND (MHz)	MAX. POWER	
		OUTPUT POWER(dBm)	OUTPUT POWER(mW)
1	5250~5350	21.01	126.209
1	5470~5725	21.12	129.524

### 802.11ac (20MHz)

ANT NO.	FREQUENCY BAND (MHz)	MAX. POWER	
		OUTPUT POWER(dBm)	OUTPUT POWER(mW)
1	5250~5350	20.98	125.438
1	5470~5725	21.13	129.643

### 802.11ac (40MHz)

ANT NO.	FREQUENCY BAND (MHz)	MAX. POWER	
		OUTPUT POWER(dBm)	OUTPUT POWER(mW)
1	5250~5350	21.04	126.967
1	5470~5725	21.12	129.452

### 802.11ac (80MHz)

ANT NO.	FREQUENCY BAND (MHz)	MAX. POWER	
		OUTPUT POWER(dBm)	OUTPUT POWER(mW)
1	5250~5350	18.12	64.832
1	5470~5725	17.49	56.168



## 2.5 EUT MAXIMUM E.I.R.P. POWER

TABLE 5: THE E.I.R.P OUTPUT POWER LIST

### 802.11a

ANT NO.	FREQUENCY BAND (MHz)	MAX. POWER	
		OUTPUT POWER(dBm)	OUTPUT POWER(mW)
1	5250~5350	23.66	232.274
1	5470~5725	23.77	238.232

### 802.11ac (20MHz)

ANT NO.	FREQUENCY BAND (MHz)	MAX. POWER	
		OUTPUT POWER(dBm)	OUTPUT POWER(mW)
1	5250~5350	23.63	230.675
1	5470~5725	23.78	238.781

### 802.11ac (40MHz)

ANT NO.	FREQUENCY BAND (MHz)	MAX. POWER	
		OUTPUT POWER(dBm)	OUTPUT POWER(mW)
1	5250~5350	23.69	233.884
1	5470~5725	23.77	238.232

### 802.11ac (80MHz)

ANT NO.	FREQUENCY BAND (MHz)	MAX. POWER	
		OUTPUT POWER(dBm)	OUTPUT POWER(mW)
1	5250~5350	20.77	119.399
1	5470~5725	20.14	103.276

## 2.6 TRANSMIT POWER CONTROL (TPC)

U-NII devices operating in the 5.25-5.35 GHz band and the 5.47-5.725 GHz band shall employ a TPC mechanism. The U-NII device is required to have the capability to operate at least 6 dB below the mean EIRP value of 30 dBm. A TPC mechanism is not required for systems with an e.i.r.p. of less than 500 mW.

Maximum EIRP of this device is 238.781mW which less than 500mW, therefore it's not require TPC function.

## 2.7 STATEMENT OF MAUNFACTURER

Manufacturer statement confirming that information regarding the parameters of the detected Radar Waveforms is not available to the end user.





### 3. U-NII DFS RULE REQUIREMENTS

#### 3.1 WORKING MODES AND REQUIRED TEST ITEMS

The manufacturer shall state whether the EUT is capable of operating as a Master and/or a Client. If the EUT is capable of operating in more than one operating mode then each operating mode shall be tested separately. See tables 6 and 7 for the applicability of DFS requirements for each of the operational modes.

**TABLE 6: APPLICABILITY OF DFS REQUIREMENTS PRIOR TO USE A CHANNEL**

Requirement	Operational Mode		
	Master	Client without radar detection	Client with radar detection
Non-Occupancy Period	✓	Not required	✓
DFS Detection Threshold	✓	Not required	✓
Channel Availability Check Time	✓	Not required	Not required
U-NII Detection Bandwidth	✓	Not required	✓

**TABLE 7: APPLICABILITY OF DFS REQUIREMENTS DURING NORMAL OPERATION**

Requirement	Operational Mode	
	Master or Client with radar detection	Client without radar detection
DFS Detection Threshold	✓	Not required
Channel Closing Transmission Time	✓	✓
Channel Move Time	✓	✓
U-NII Detection Bandwidth	✓	Not required

Additional requirements for devices with multiple bandwidth modes	Master or Client with radar detection	Client without radar detection
U-NII Detection Bandwidth and Statistical Performance Check	All BW modes must be tested	Not required
Channel Move Time and Channel Closing Transmission Time	Test using widest BW mode available	Test using the widest BW mode available for the link
All other tests	Any single BW mode	Not required

**NOTE:** Frequencies selected for statistical performance check (Section 7.8.4) should include several frequencies within the radar detection bandwidth and frequencies near the edge of the radar detection bandwidth. For 802.11 devices it is suggested to select frequencies in all 20 MHz channel blocks and null frequencies between the bonded 20 MHz channel blocks.



### 3.2 TEST LIMITS AND RADAR SIGNAL PARAMETERS

#### DETECTION THRESHOLD VALUES

**TABLE 8: DFS DETECTION THRESHOLDS FOR MASTER DEVICES AND CLIENT DEVICES WITH RADAR DETECTION**

Maximum Transmit Power	Value (See Notes 1, 2, and 3)
EIRP ≥ 200 milliwatt	-64 dBm
EIRP < 200 milliwatt and power spectral density < 10 dBm/MHz	-62 dBm
EIRP < 200 milliwatt that do not meet the power spectral density requirement	-64 dBm

Note 1: This is the level at the input of the receiver assuming a 0 dBi receive antenna.  
 Note 2: Throughout these test procedures an additional 1 dB has been added to the amplitude of the test transmission waveforms to account for variations in measurement equipment. This will ensure that the test signal is at or above the detection threshold level to trigger a DFS response.  
 Note3: EIRP is based on the highest antenna gain. For MIMO devices refer to KDB Publication 662911 D01.

**TABLE 9: DFS RESPONSE REQUIREMENT VALUES**

Parameter	Value
Non-occupancy period	Minimum 30 minutes
Channel Availability Check Time	60 seconds
Channel Move Time	10 seconds See Note 1.
Channel Closing Transmission Time	200 milliseconds + an aggregate of 60 milliseconds over remaining 10 second period. See Notes 1 and 2.
U-NII Detection Bandwidth	Minimum 100% of the U-NII 99% transmission power bandwidth. See Note 3

Note 1: Channel Move Time and the Channel Closing Transmission Time should be performed with Radar Type 0. The measurement timing begins at the end of the Radar Type 0 burst.  
 Note 2: The Channel Closing Transmission Time is comprised of 200 milliseconds starting at the beginning of the Channel Move Time plus any additional intermittent control signals required to facilitate a Channel move (an aggregate of 60 milliseconds) during the remainder of the 10 second period. The aggregate duration of control signals will not count quiet periods in between transmissions.  
 Note 3: During the U-NII Detection Bandwidth detection test, radar type 0 should be used. For each frequency step the minimum percentage of detection is 90 percent. Measurements are performed with no data traffic.



**PARAMETERS OF DFS TEST SIGNALS**

Step intervals of 0.1 microsecond for Pulse Width, 1 microsecond for PRI, 1 MHz for chirp width and 1 for the number of pulses will be utilized for the random determination of specific test waveforms.

**TABLE 10: SHORT PULSE RADAR TEST WAVEFORMS**

Radar Type	Pulse Width (μsec)	PRI (μsec)	Number of Pulses	Minimum Percentage of Successful Detection	Minimum Number of Trials
0	1	1428	18	See Note 1	See Note 1
1	1	Test A: 15 unique PRI values randomly selected from the list of 23 PRI values in Table 5a	Roundup $\left\{ \begin{matrix} \frac{1}{360} \cdot \\ \frac{19 \cdot 10^6}{PRI_{\mu sec}} \end{matrix} \right\}$	60%	30
		Test B: 15 unique PRI values randomly selected within the range of 518-3066 μ sec, with a minimum increment of 1 μ sec, excluding PRI values selected in Test A			
2	1-5	150-230	23-29	60%	30
3	6-10	200-500	16-18	60%	30
4	11-20	200-500	12-16	60%	30
Aggregate (Radar Types 1-4)				80%	120
Note 1: Short Pulse Radar Type 0 should be used for the detection bandwidth test, channel move time, and channel closing time tests.					

**TABLE 11: LONG PULSE RADAR TEST WAVEFORM**

Radar Type	Pulse Width (μsec)	Chirp Width (MHz)	PRI (μsec)	Number of Pulses per Burst	Number of Bursts	Minimum Percentage of Successful Detection	Minimum Number of Trials
5	50-100	5-20	1000-2000	1-3	8-20	80%	30



**TABLE 12: FREQUENCY HOPPING RADAR TEST WAVEFORM**

<b>Radar Type</b>	<b>Pulse Width (μsec)</b>	<b>PRI (μsec)</b>	<b>Pulses per Hop</b>	<b>Hopping Rate (kHz)</b>	<b>Hopping Sequence Length (msec)</b>	<b>Minimum Percentage of Successful Detection</b>	<b>Minimum Number of Trials</b>
6	1	333	9	0.333	300	70%	30



## 4. TEST & SUPPORT EQUIPMENT LIST

### 4.1 TEST INSTRUMENTS

TABLE 13: TEST INSTRUMENTS LIST

DESCRIPTION & MANUFACTURER	MODEL NO.	BRAND	DATE OF CALIBRATION	DUE DATE OF CALIBRATION
R&S Spectrum analyzer	FSP40	R&S	2014/03/03	2015/03/02
Signal generator	8645A	Agilent	2014/06/24	2015/06/23
Oscilloscope	TDS 5104	Tektronix	2014/03/20	2015/03/19

### 4.2 DESCRIPTION OF SUPPORT UNITS

TABLE 14: SUPPORT UNIT INFORMATION.

No.	Product	Brand	Model No.	FCC ID
1	Intel Dual Band Wireless-AC 7260	Intel	AC 7260	PD97260H

NOTE: This device was functioned as a  Master  Slave device during the DFS test.

## 5. TEST PROCEDURE

### 5.1 ADT DFS MEASUREMENT SYSTEM

A complete ADT DFS Measurement System consists of two subsystems: (1) the Radar Signal Generating Subsystem and (2) the Traffic Monitoring Subsystem. The control PC is necessary for generating the Radar waveforms in Table 10, 11 and 12. The traffic monitoring subsystem is specified to the type of unit under test (UUT).

### RADIATED SETUP CONFIGURATION OF ADT DFS MEASUREMENT SYSTEM

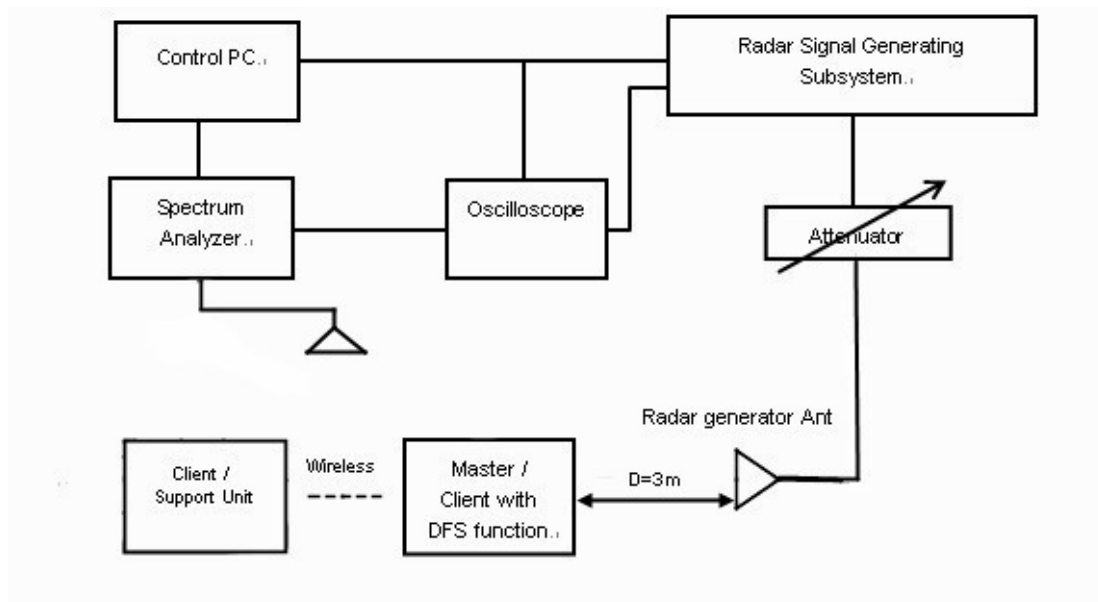

System testing will be performed with channel-loading using means appropriate to the data types that are used by the unlicensed device. The following requirements apply:

	a) The data file must be of a type that is typical for the device (i.e., MPEG-2, MPEG-4, WAV, MP3, MP4, AVI, etc.) and must generally be transmitting in a streaming mode.
	b) Software to ping the client is permitted to simulate data transfer but must have random ping intervals.
V	c) Timing plots are required with calculations demonstrating a minimum channel loading of approximately 17% or greater.
	d) Unicast or Multicast protocols are preferable but other protocols may be used. The appropriate protocol used must be described in the test procedures.

## 5.2 CALIBRATION OF DFS DETECTION THRESHOLD LEVEL

The measured channel is 5500MHz, 5510MHz and 5530MHz. The radar signal was the same as transmitted channels, and injected into the antenna of AP (master) or Client Device with Radar Detection, measured the channel closing transmission time and channel move time. The calibrated detection threshold level is set to -64dBm. The tested level is lower than required level hence it provides margin to the limit.

### Radiated setup configuration of Calibration of DFS Detection Threshold Level

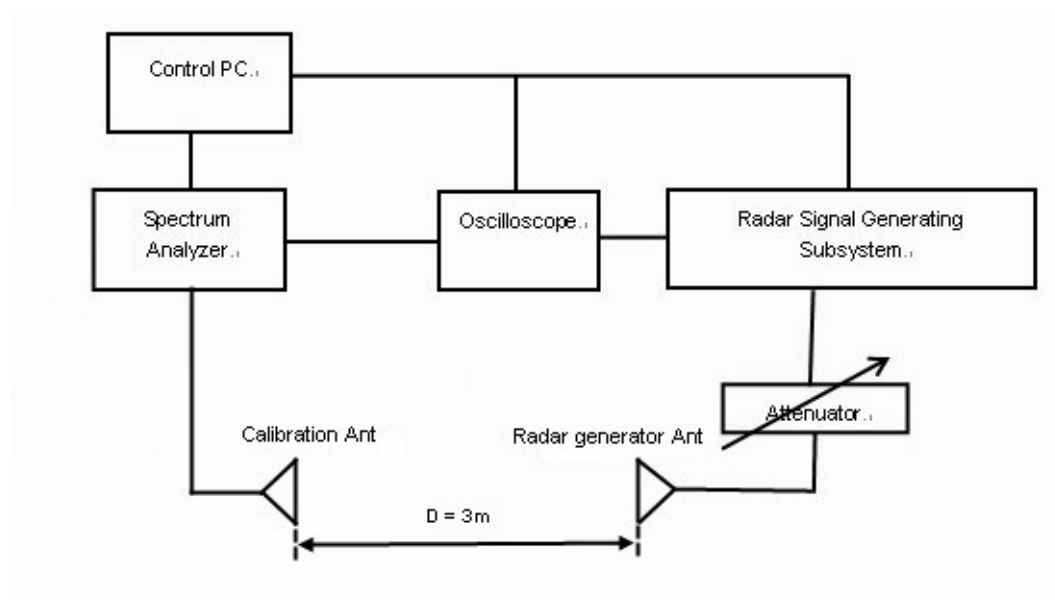

## 5.3 DEVIATION FROM TEST STANDARD

No deviation.

## 5.4 RADIATED TEST SETUP CONFIGURATION

### 5.4.1 MASTER MODE

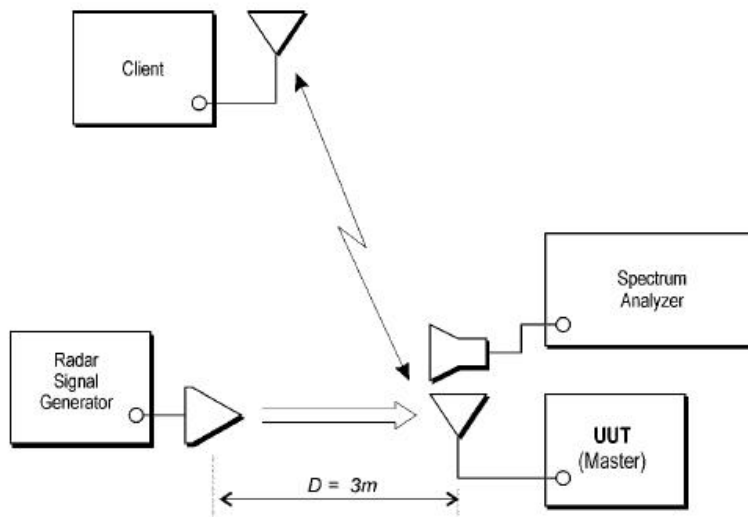

The EUT is a U-NII Device operating in Master mode. The radar test signals are injected into the Master Device.





## 6. TEST RESULTS

### 6.1 SUMMARY OF TEST RESULTS

CLAUSE	TEST PARAMETER	REMARKS	PASS/FAIL
15.407	DFS Detection Threshold	Applicable	Pass
15.407	U-NII Detection Bandwidth	Applicable	Pass
15.407	Channel Availability Check Time	Applicable	Pass
15.407	Channel Move Time	Applicable	Pass
15.407	Channel Closing Transmission Time	Applicable	Pass
15.407	Non- Occupancy Period	Applicable	Pass
15.407	Uniform Spreading	Applicable	Pass

## 6.2 TEST RESULTS

### 6.2.1 TEST MODE: DEVICE OPERATING IN MASTER MODE

Master with injection at the Master. (Radar Test Waveforms are injected into the Master.

### DFS DETECTION THRESHOLD

For a detection threshold level of -64dBm, the required signal strength at EUT antenna location is -64 dBm. The tested level is lower than required level hence it provides margin to the limit.

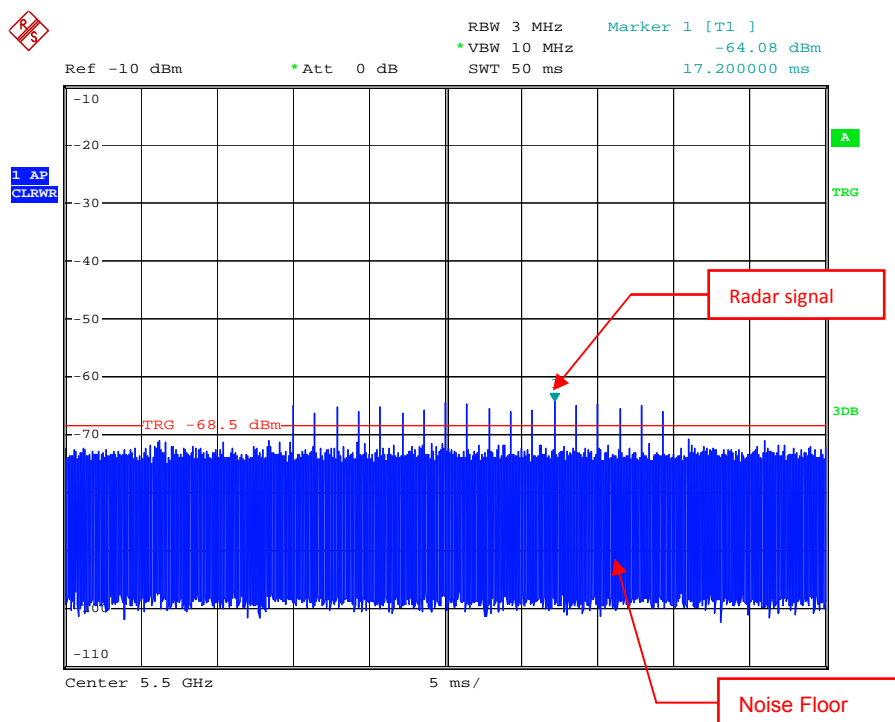

Radar Signal 0



A D T

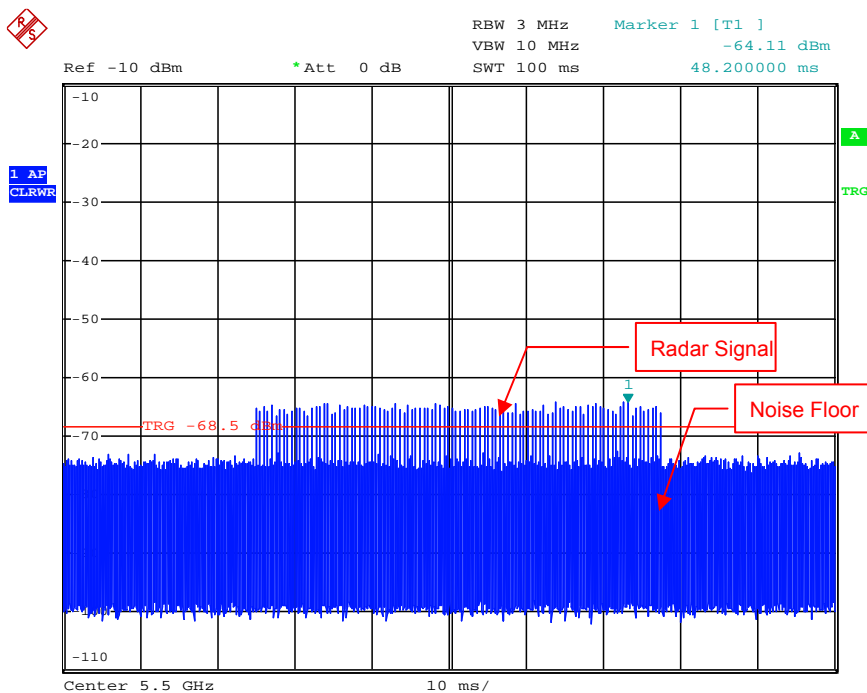

Radar Signal 1 (Test A)

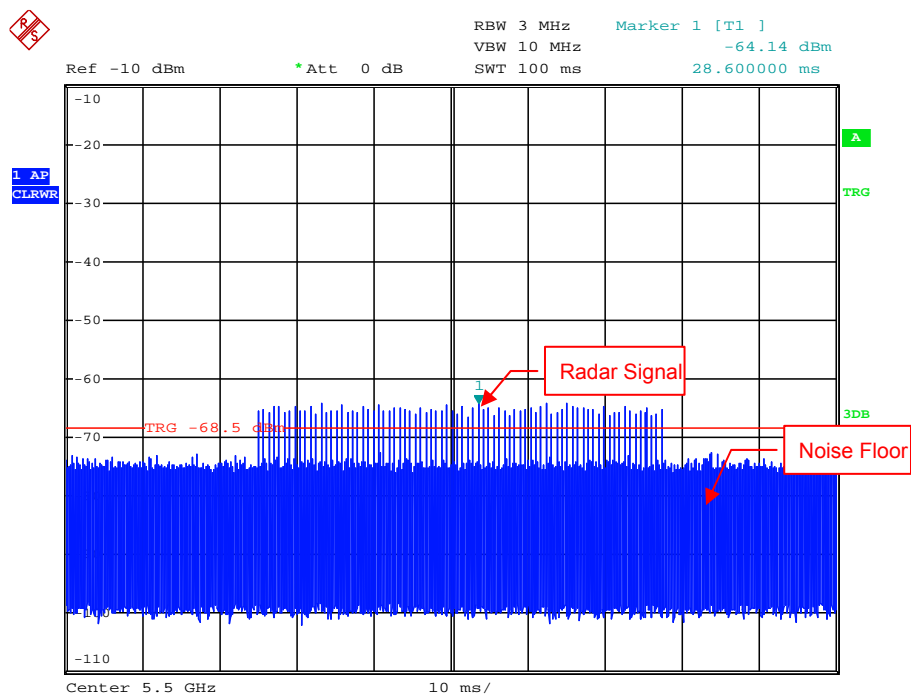

Radar Signal 1 (Test B)



A D T

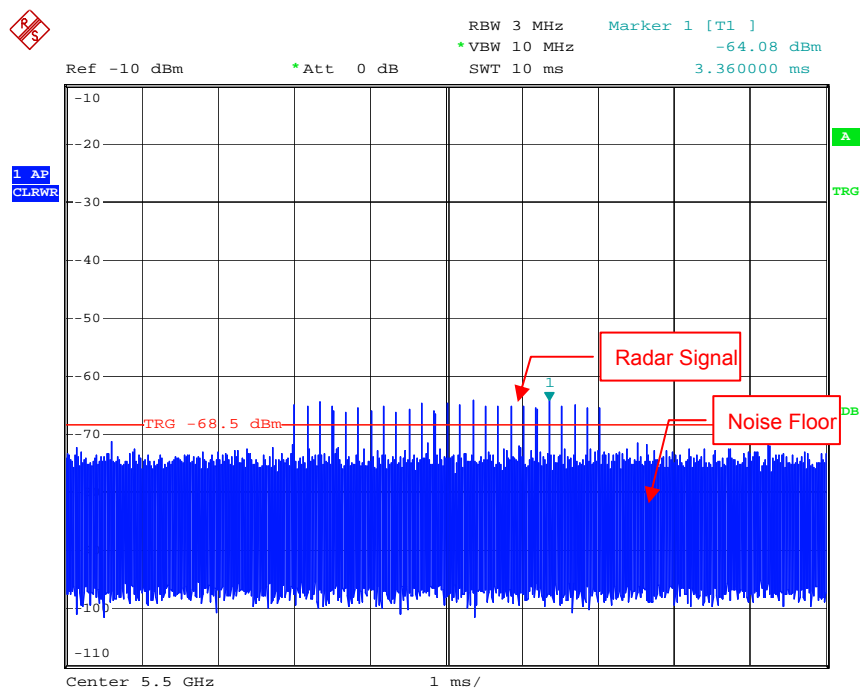

Radar Signal 2

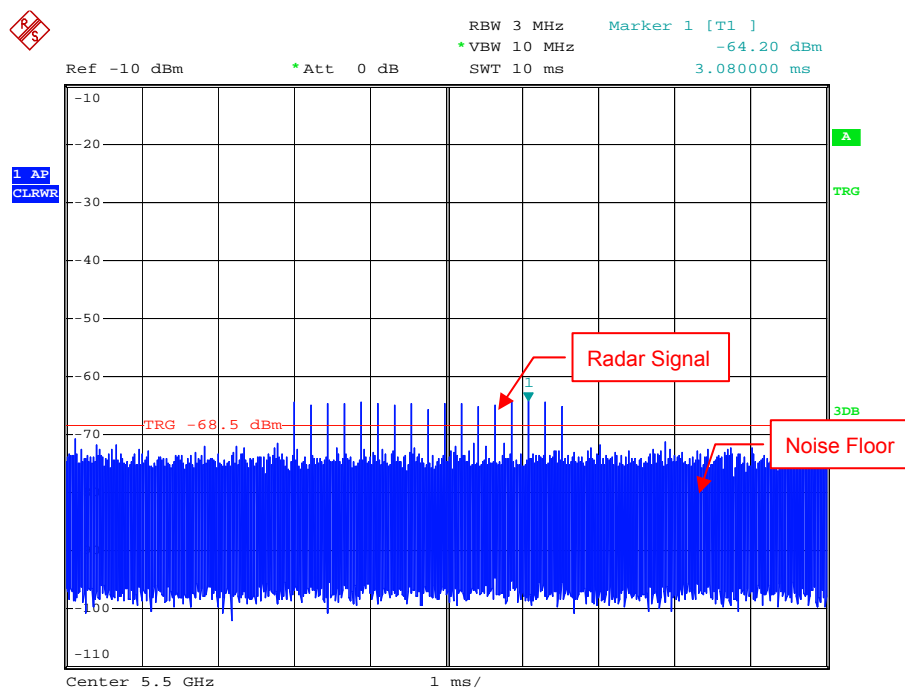

Radar Signal 3

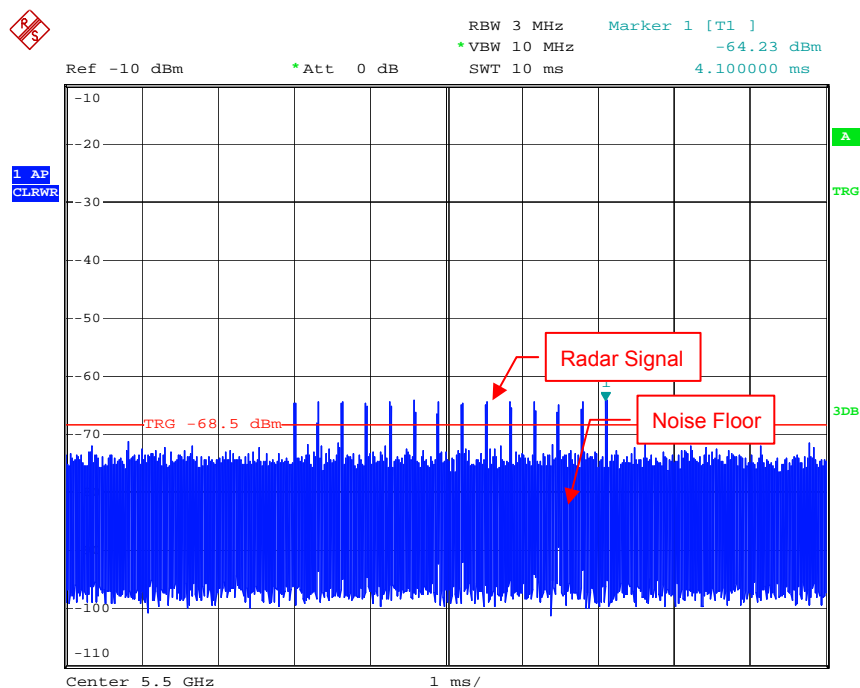

Radar Signal 4

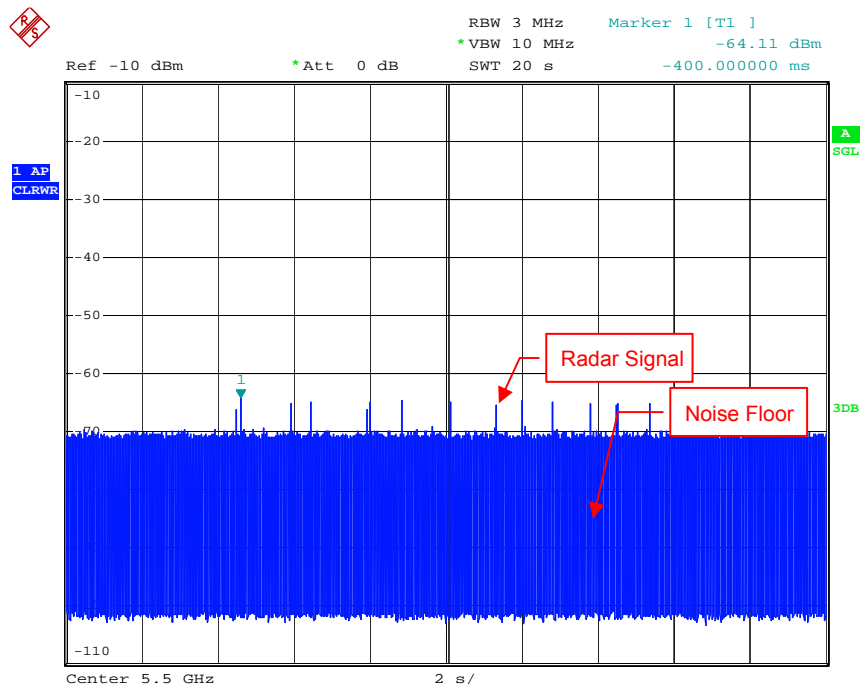

Radar Signal 5

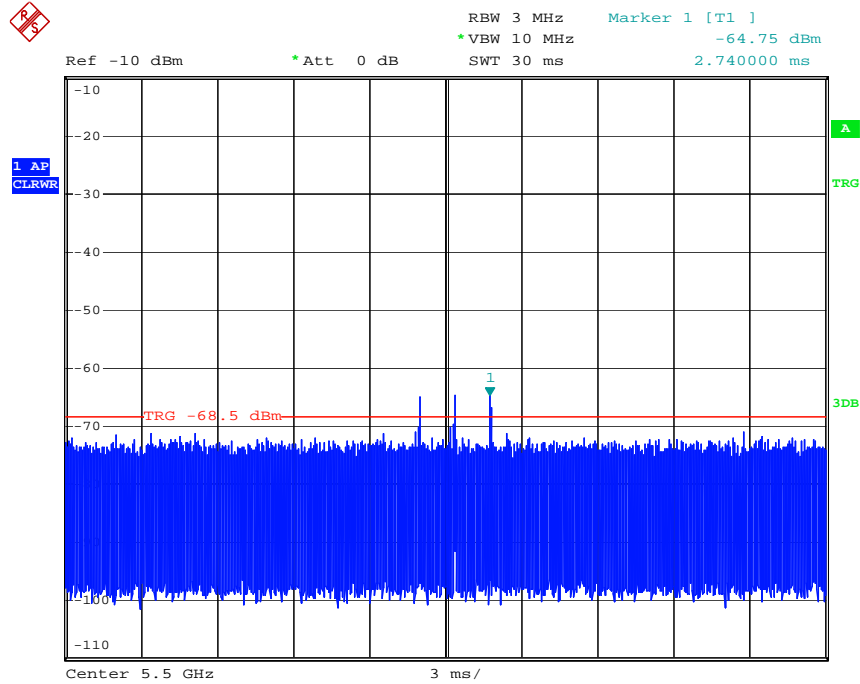

Single Burst of Radar Signal 5

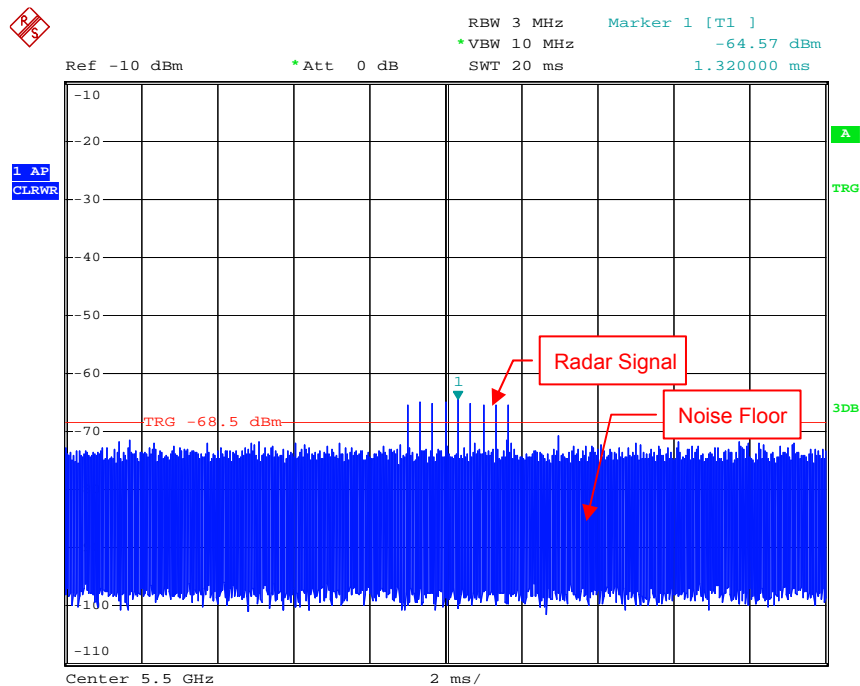

Radar Signal 6



A D T

## 6.2.2 U-NII DETECTION BANDWIDTH

### IEEE 802.11ac 20MHz



Ref -22 dBm \*Att 10 dB \*RBW 100 kHz Marker 1 [T1 ]  
\*VBW 300 kHz -28.07 dBm  
\*SWT 500 ms 5.498700000 GHz

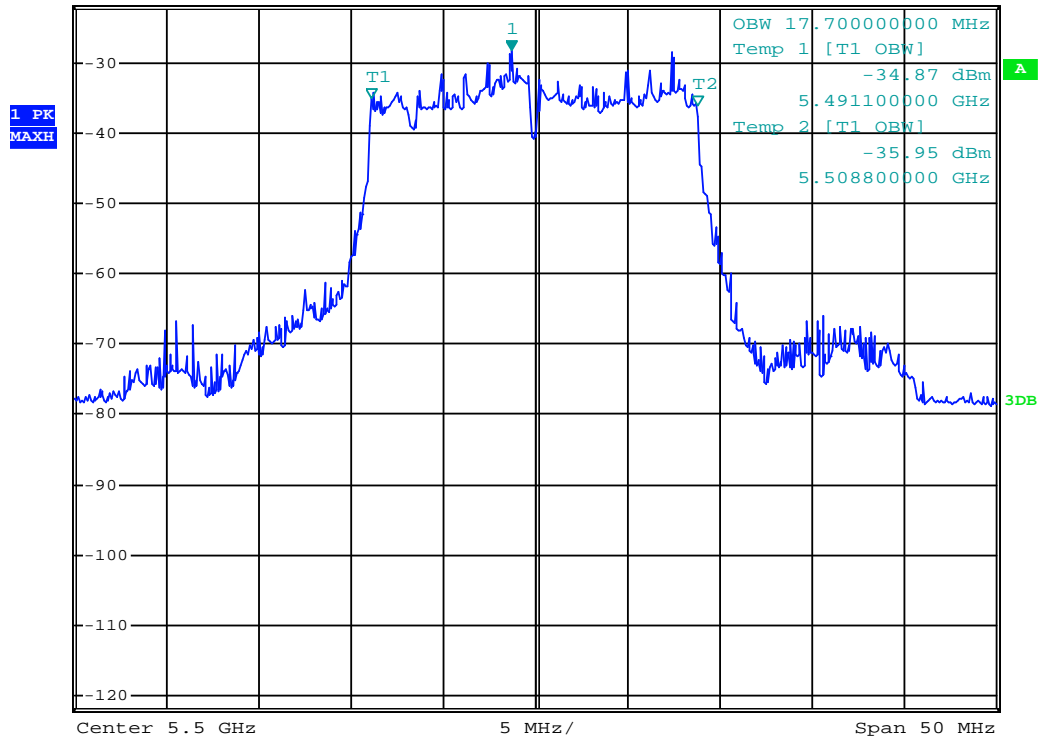

U-NII 99% Channel bandwidth



A D T

# IEEE 802.11ac 40MHz



Ref -10 dBm      \*Att 10 dB      \*RBW 100 kHz      Marker 1 [T1]      -32.48 dBm  
\*VBW 300 kHz      \*SWT 500 ms      5.507400000 GHz

1 PK  
MAXH

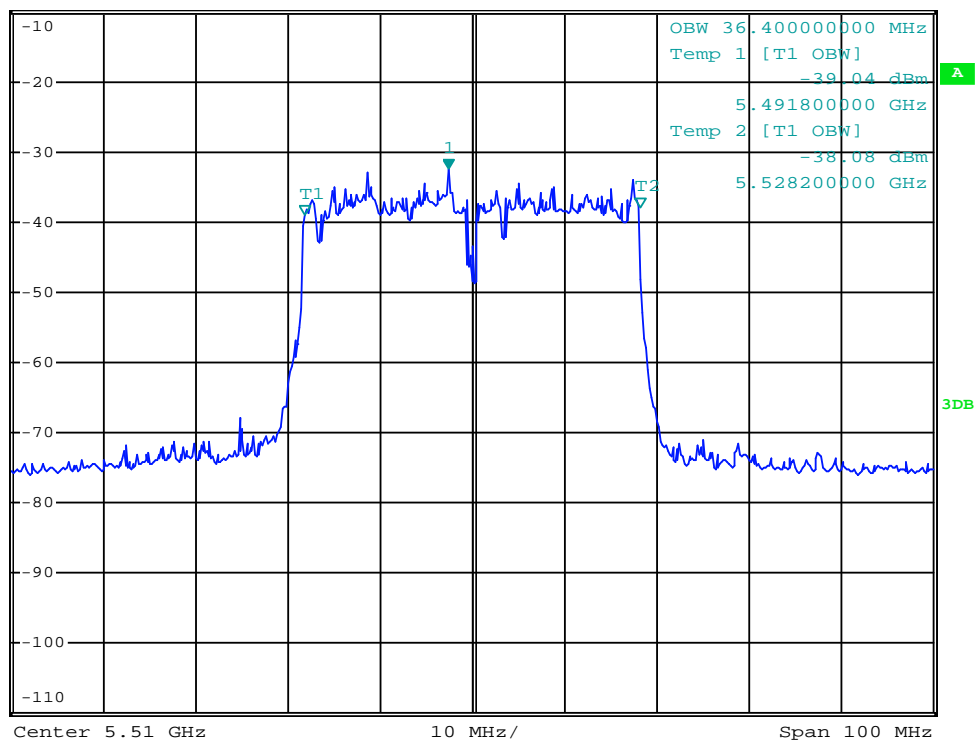

U-NII 99% Channel bandwidth





A D T

# IEEE 802.11ac 80MHz



Ref -10 dBm      \*Att 10 dB      \*RBW 100 kHz      Marker 1 [T1 ]  
\*VBW 300 kHz      -32.48 dBm  
\*SWT 500 ms      5.507400000 GHz

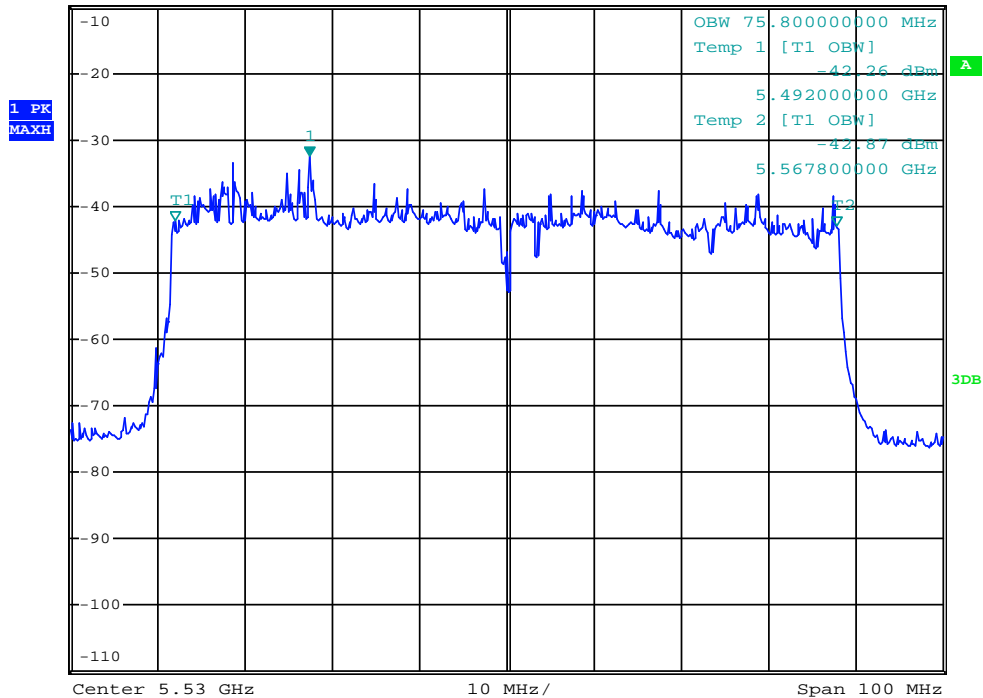

U-NII 99% Channel bandwidth



Detection Bandwidth Test - IEEE 802.11ac 20MHz											
Radar Type 0											
EUT Frequency: 5500MHz											
EUT 99% Power bandwidth: 17.7MHz											
Detection bandwidth limit (100% of EUT 99% Power bandwidth): 17.7MHz											
Detection bandwidth (5509(FH) – 5491(FL)) : 18MHz											
Test Result : PASS											
Radar Frequency (MHz)	Trial Number / Detection										Detection Rate (%)
	1	2	3	4	5	6	7	8	9	10	
5490	N	N	N	N	N	N	N	N	N	N	0
5491(FL)	Y	Y	Y	Y	Y	Y	Y	Y	Y	Y	100
5492	Y	Y	Y	Y	Y	Y	Y	Y	Y	Y	100
5493	Y	Y	Y	Y	Y	Y	Y	Y	Y	Y	100
5494	Y	Y	Y	Y	Y	Y	Y	Y	Y	Y	100
5495	Y	Y	Y	Y	Y	Y	Y	Y	Y	Y	100
5496	Y	Y	Y	Y	Y	Y	Y	Y	Y	Y	100
5497	Y	Y	Y	Y	Y	Y	Y	Y	Y	Y	100
5498	Y	Y	Y	Y	Y	Y	Y	Y	Y	Y	100
5499	Y	Y	Y	Y	Y	Y	Y	Y	Y	Y	100
5500	Y	Y	Y	Y	Y	Y	Y	Y	Y	Y	100
5501	Y	Y	Y	Y	Y	Y	Y	Y	Y	Y	100
5502	Y	Y	Y	Y	Y	Y	Y	Y	Y	Y	100
5503	Y	Y	Y	Y	Y	Y	Y	Y	Y	Y	100
5504	Y	Y	Y	Y	Y	Y	Y	Y	Y	Y	100
5505	Y	Y	Y	Y	Y	Y	Y	Y	Y	Y	100
5506	Y	Y	Y	Y	Y	Y	Y	Y	Y	Y	100
5507	Y	Y	Y	Y	Y	Y	Y	Y	Y	Y	100
5508	Y	Y	Y	Y	Y	Y	Y	Y	Y	Y	100
5509(FH)	Y	Y	Y	Y	Y	Y	Y	Y	Y	Y	100
5510	N	N	N	N	N	N	N	N	N	N	0



Detection Bandwidth Test - IEEE 802.11ac 40MHz  
Radar Type 0  
EUT Frequency: 5510MHz  
EUT 99% Power bandwidth: 36.4MHz  
Detection bandwidth limit (100% of EUT 99% Power bandwidth): 36.4MHz  
Detection bandwidth (5529(FH) – 5491(FL)) : 38MHz  
Test Result : PASS

Radar Frequency (MHz)	Trial Number / Detection										Detection Rate (%)
	1	2	3	4	5	6	7	8	9	10	
5490	N	N	N	Y	N	N	N	N	N	Y	0
5491(FL)	Y	Y	Y	Y	Y	Y	Y	Y	Y	Y	100
5492	Y	Y	Y	Y	Y	Y	Y	Y	Y	Y	100
5493	Y	Y	Y	Y	Y	Y	Y	Y	Y	Y	100
5494	Y	Y	Y	Y	N	Y	Y	Y	Y	Y	90
5495	Y	Y	Y	Y	Y	Y	Y	Y	Y	Y	100
5496	Y	Y	Y	Y	Y	Y	Y	Y	Y	Y	100
5497	Y	Y	Y	Y	Y	Y	Y	Y	Y	Y	100
5498	Y	Y	Y	Y	Y	Y	Y	Y	Y	Y	100
5499	Y	Y	Y	Y	Y	Y	Y	Y	Y	Y	100
5500	Y	Y	Y	Y	Y	Y	Y	Y	Y	Y	100
5501	Y	Y	Y	Y	Y	Y	Y	Y	Y	Y	100
5502	Y	Y	Y	Y	Y	Y	Y	Y	Y	Y	100
5503	Y	Y	Y	Y	Y	Y	Y	Y	Y	Y	100
5504	Y	Y	Y	Y	Y	Y	Y	Y	Y	Y	100
5505	Y	Y	Y	Y	Y	Y	Y	Y	Y	Y	100
5506	Y	Y	Y	Y	Y	Y	Y	Y	Y	Y	100
5507	Y	Y	Y	Y	Y	Y	Y	Y	Y	Y	100
5508	Y	Y	Y	Y	Y	Y	Y	Y	Y	Y	100
5509	Y	Y	Y	Y	Y	Y	Y	Y	Y	Y	100
5510	Y	Y	Y	Y	Y	Y	Y	Y	Y	Y	100
5511	Y	Y	Y	Y	Y	Y	Y	Y	Y	Y	100
5512	Y	Y	Y	Y	Y	Y	Y	Y	Y	Y	100
5513	Y	Y	Y	Y	Y	Y	Y	Y	Y	Y	100
5514	Y	Y	Y	Y	Y	Y	Y	Y	Y	Y	100
5515	Y	Y	Y	Y	Y	Y	Y	Y	Y	Y	100
5516	Y	Y	Y	Y	Y	Y	Y	Y	Y	Y	100
5517	Y	Y	Y	Y	Y	Y	Y	Y	Y	Y	100
5518	Y	Y	Y	Y	Y	Y	Y	Y	Y	Y	100
5519	Y	Y	Y	Y	Y	Y	Y	Y	Y	Y	100
5520	Y	Y	Y	Y	Y	Y	Y	Y	Y	Y	100
5521	Y	Y	Y	Y	Y	Y	Y	Y	Y	Y	100
5522	Y	Y	Y	Y	Y	Y	Y	Y	Y	Y	100
5523	Y	Y	Y	Y	Y	Y	Y	Y	Y	Y	100
5524	Y	Y	Y	Y	Y	Y	N	Y	Y	Y	90
5525	Y	Y	Y	Y	Y	Y	Y	Y	Y	Y	100
5526	Y	Y	Y	Y	Y	Y	Y	Y	Y	Y	100
5527	Y	Y	Y	Y	Y	Y	Y	Y	Y	Y	100
5528	Y	Y	Y	Y	Y	Y	Y	Y	Y	Y	100
5529(FH)	Y	Y	Y	Y	Y	Y	Y	Y	Y	Y	100
5530	N	N	N	N	N	N	N	N	N	N	0



Detection Bandwidth Test - IEEE 802.11ac 80MHz  
 Radar Type 0  
 EUT Frequency: 5530MHz  
 EUT 99% Power bandwidth: 75.8MHz  
 Detection bandwidth limit (100% of EUT 99% Power bandwidth): 75.8MHz  
 Detection bandwidth (5569(FH) – 5490(FL)) : 79MHz  
 Test Result : PASS

Radar Frequency (MHz)	Trial Number / Detection										Detection Rate (%)
	1	2	3	4	5	6	7	8	9	10	
5489	N	N	N	N	N	N	N	N	N	N	0
5490(FL)	Y	Y	Y	Y	Y	Y	Y	Y	Y	Y	100
5491	Y	Y	Y	Y	Y	Y	Y	Y	Y	Y	100
5492	Y	Y	Y	Y	Y	Y	Y	Y	Y	Y	100
5493	Y	Y	Y	Y	Y	Y	Y	Y	Y	Y	100
5494	Y	Y	Y	Y	Y	Y	Y	Y	Y	Y	100
5495	Y	Y	Y	Y	Y	Y	Y	Y	Y	Y	100
5496	Y	Y	Y	Y	Y	Y	Y	Y	Y	Y	100
5497	Y	Y	Y	Y	Y	Y	Y	Y	Y	Y	100
5498	Y	Y	Y	Y	Y	Y	Y	Y	Y	Y	100
5499	Y	Y	Y	Y	Y	Y	Y	Y	Y	Y	100
5500	Y	Y	Y	Y	Y	Y	Y	Y	Y	Y	100
5501	Y	Y	Y	Y	Y	Y	Y	Y	Y	Y	100
5502	Y	Y	Y	Y	Y	Y	Y	Y	Y	Y	100
5503	Y	Y	Y	Y	Y	Y	Y	Y	Y	Y	100
5504	Y	Y	Y	Y	Y	Y	Y	Y	Y	Y	100
5505	Y	Y	Y	Y	Y	Y	Y	Y	Y	Y	100
5506	Y	Y	Y	Y	Y	Y	Y	Y	Y	Y	100
5507	Y	Y	Y	Y	Y	Y	Y	Y	Y	Y	100
5508	Y	Y	Y	Y	Y	Y	Y	Y	Y	Y	100
5509	Y	Y	Y	Y	Y	Y	Y	Y	Y	Y	100
5510	Y	Y	Y	Y	Y	Y	Y	Y	Y	Y	100
5511	Y	Y	Y	Y	Y	Y	Y	Y	Y	Y	100
5512	Y	Y	Y	Y	Y	Y	Y	Y	Y	Y	100
5513	Y	Y	Y	Y	Y	Y	Y	Y	Y	Y	100
5514	Y	Y	Y	Y	Y	Y	Y	Y	Y	Y	100
5515	Y	Y	Y	Y	Y	Y	Y	Y	Y	Y	100
5516	Y	Y	Y	Y	Y	Y	Y	Y	Y	Y	100
5517	Y	Y	Y	Y	Y	Y	Y	Y	Y	Y	100
5518	Y	Y	Y	Y	Y	Y	Y	Y	Y	Y	100
5519	Y	Y	Y	Y	Y	Y	Y	Y	Y	Y	100
5520	Y	Y	Y	Y	Y	Y	Y	Y	Y	Y	100
5521	Y	Y	Y	Y	Y	Y	Y	Y	Y	Y	100
5522	Y	Y	Y	Y	Y	Y	Y	Y	Y	Y	100
5523	Y	Y	Y	Y	Y	Y	Y	Y	Y	Y	100
5524	Y	Y	Y	Y	Y	Y	Y	Y	Y	Y	100
5525	Y	Y	Y	Y	Y	Y	Y	Y	Y	Y	100
5526	Y	Y	Y	Y	Y	Y	Y	Y	Y	Y	100
5527	Y	Y	Y	Y	Y	Y	Y	Y	Y	Y	100
5528	Y	Y	Y	Y	Y	Y	Y	Y	Y	Y	100
5529	Y	Y	Y	Y	Y	Y	Y	Y	Y	Y	100
5530	Y	Y	Y	Y	Y	Y	Y	Y	Y	Y	100
5531	Y	Y	Y	Y	Y	Y	Y	Y	Y	Y	100



A D T

5532	Y	Y	Y	Y	Y	Y	Y	Y	Y	Y	100
5533	Y	Y	Y	Y	Y	Y	Y	Y	Y	Y	100
5534	Y	Y	Y	Y	Y	Y	Y	Y	Y	Y	100
5535	Y	Y	Y	Y	Y	Y	Y	Y	Y	Y	100
5536	Y	Y	Y	Y	Y	Y	Y	Y	Y	Y	100
5537	Y	Y	Y	Y	Y	Y	Y	Y	Y	Y	100
5538	Y	Y	Y	Y	Y	Y	Y	Y	Y	Y	100
5539	Y	Y	Y	Y	Y	Y	Y	Y	Y	Y	100
5540	Y	Y	Y	Y	Y	Y	Y	Y	Y	Y	100
5541	Y	Y	Y	Y	Y	Y	Y	Y	Y	Y	100
5542	Y	Y	Y	Y	Y	Y	Y	Y	Y	Y	100
5543	Y	Y	Y	Y	Y	Y	Y	Y	Y	Y	100
5544	Y	Y	Y	Y	Y	Y	Y	Y	Y	Y	100
5545	Y	Y	Y	Y	Y	Y	Y	Y	Y	Y	100
5546	Y	Y	Y	Y	Y	Y	Y	Y	Y	Y	100
5547	Y	Y	Y	Y	Y	Y	Y	Y	Y	Y	100
5548	Y	Y	Y	Y	Y	Y	Y	Y	Y	Y	100
5549	Y	Y	Y	Y	Y	Y	Y	Y	Y	Y	100
5550	Y	Y	Y	Y	Y	Y	Y	Y	Y	Y	100
5551	Y	Y	Y	Y	Y	Y	Y	Y	Y	Y	100
5552	Y	Y	Y	Y	Y	Y	Y	Y	Y	Y	100
5553	Y	Y	Y	Y	Y	Y	Y	Y	Y	Y	100
5554	Y	Y	Y	Y	Y	Y	Y	Y	Y	Y	100
5555	Y	Y	Y	Y	Y	Y	Y	Y	Y	Y	100
5556	Y	Y	Y	Y	Y	Y	Y	Y	Y	Y	100
5557	Y	Y	Y	Y	Y	Y	Y	Y	Y	Y	100
5558	Y	Y	Y	Y	Y	Y	Y	Y	Y	Y	100
5559	Y	Y	Y	Y	Y	Y	Y	Y	Y	Y	100
5560	Y	Y	Y	Y	Y	Y	Y	Y	Y	Y	100
5561	Y	Y	Y	Y	Y	Y	Y	Y	Y	Y	100
5562	Y	Y	Y	Y	Y	Y	Y	Y	Y	Y	100
5563	Y	Y	Y	Y	Y	Y	Y	Y	Y	Y	100
5564	Y	Y	Y	Y	Y	Y	Y	Y	Y	Y	100
5565	Y	Y	Y	Y	Y	Y	Y	Y	Y	Y	100
5566	Y	Y	Y	Y	Y	Y	Y	Y	Y	Y	100
5567	Y	Y	Y	Y	Y	Y	Y	Y	Y	Y	100
5568	Y	Y	Y	Y	Y	Y	Y	Y	Y	Y	100
5569(FH)	Y	Y	Y	Y	Y	Y	Y	Y	Y	Y	100
5570	Y	Y	Y	N	Y	N	Y	Y	N	Y	70
5571	N	N	N	N	N	N	N	N	N	N	0

### 6.2.3 CHANNEL AVAILABILITY CHECK TIME

If the EUT successfully detected the radar burst, it should be observed as the EUT has no transmissions occurred until the EUT starts transmitting on another channel.

Timing of Radar Signal	Observation	
	EUT	Spectrum Analyzer
Within 1 to 6 second	Detected	No transmissions
Within 54 to 60 second	Detected	No transmissions

#### Initial Channel Availability Check Time

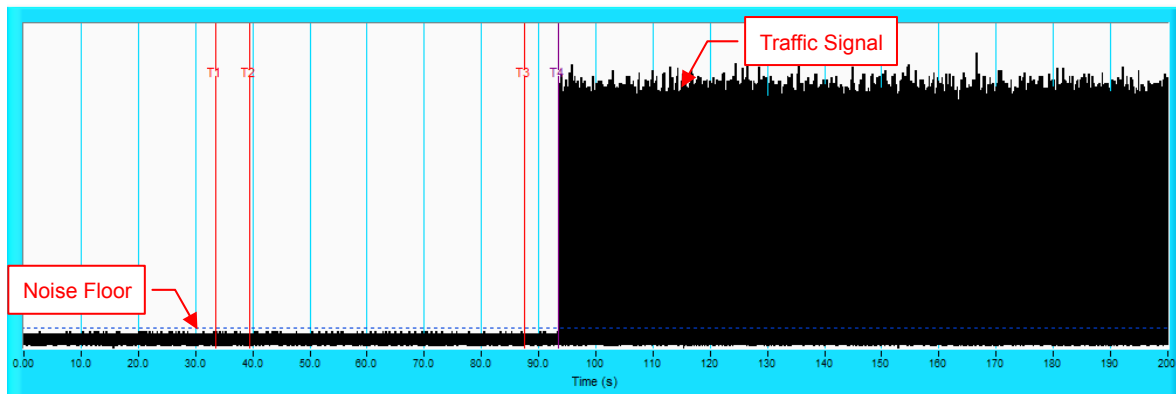

**NOTE:** T1 denotes the end of power-up time period is 33.5 second. T4 denotes the end of Channel Availability Check time is 93.5 second. Channel Availability Check time is equal to  $(T4 - T1)$  60 seconds.

### Radar Burst at the Beginning of the Channel Availability Check Time

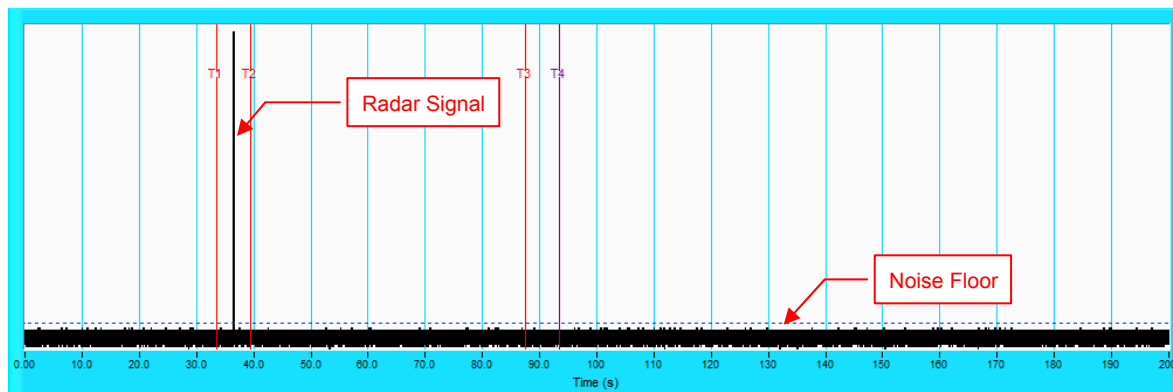

**NOTE:** T1 denotes the end of power up time period is 33.5 second. T2 denotes 39.5 second, the radar burst was commenced within a 6 second window starting from the end of power-up sequence. T4 denotes the 93.5 second.

### Radar Burst at the End of the Channel Availability Check Time

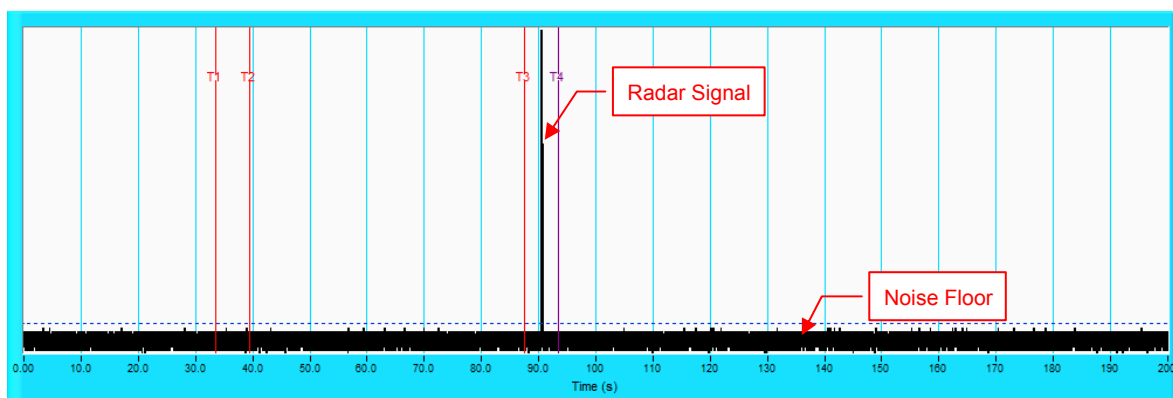

**NOTE:** T1 denotes the end of power up time period is 33.5 second. T3 denotes 87.5 second and radar burst was commenced within 54<sup>th</sup> second to 60<sup>th</sup> second window starting from the end of power-up sequence. T4 denotes the 93.5 second.

## 6.2.4 CHANNEL CLOSING TRANSMISSION AND CHANNEL MOVE TIME

### Wireless Traffic Loading IEEE 802.11ac 20MHz

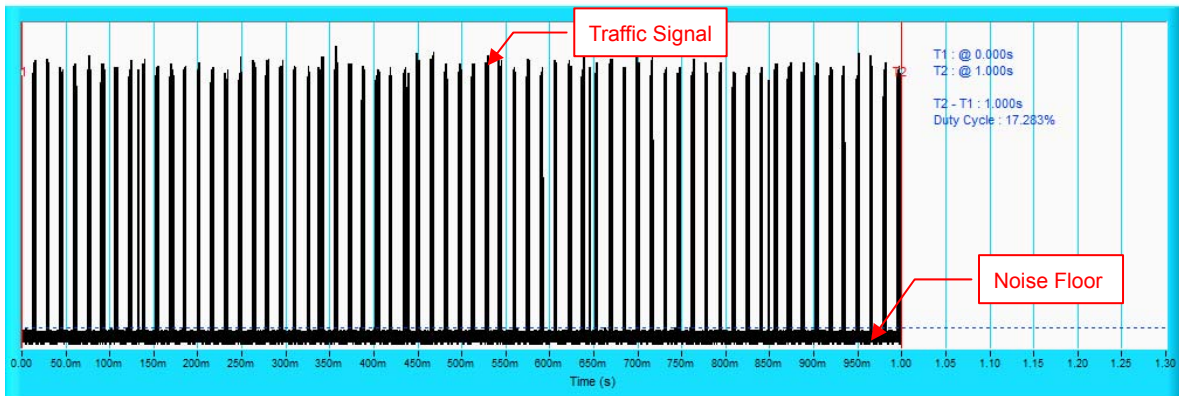

### IEEE 802.11ac 40MHz

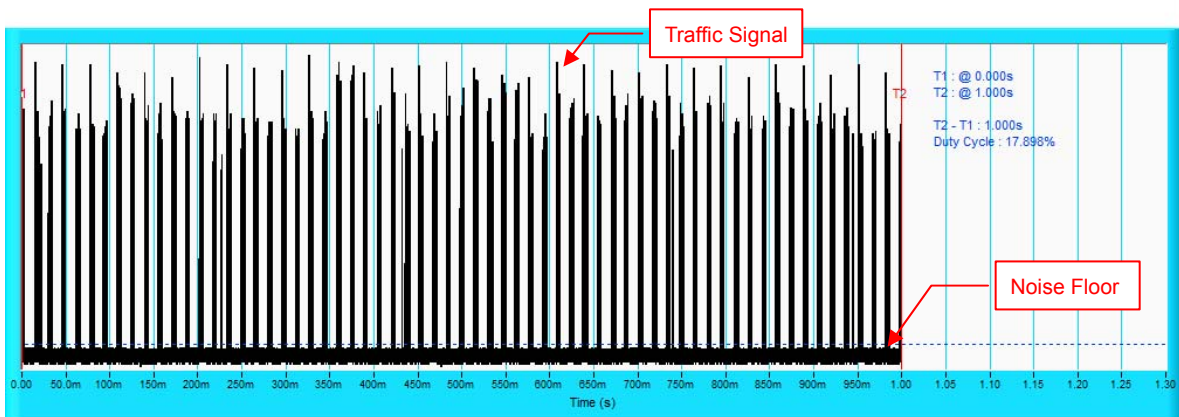

### IEEE 802.11ac 80MHz

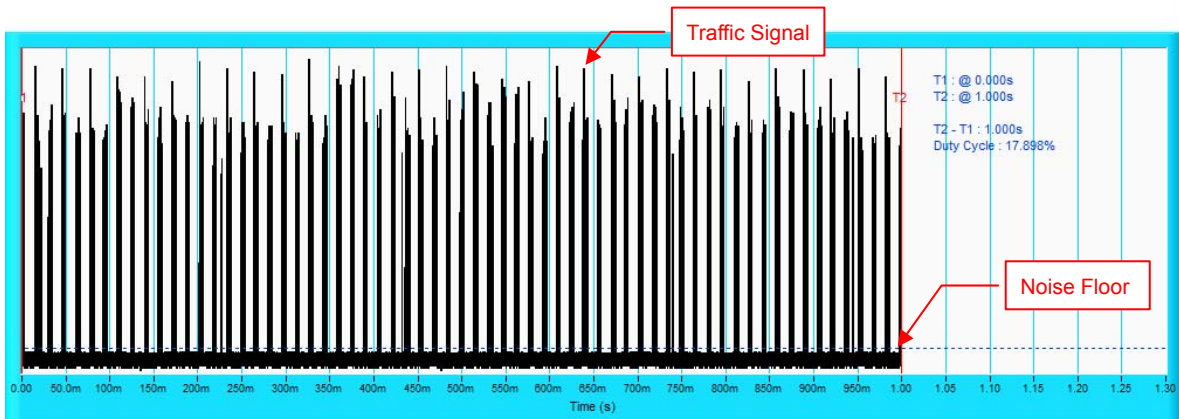





### IEEE 802.11ac 20MHz

**Table 1: Short Pulse Radar Test Waveforms.**

Radar Type	Pulse Width (µsec)	PRI (µsec)	Number of Pulses	Number of Trials(Times)	Percentage of Successful Detection (%)
1	1	1428	18	30	100
2	1-5	150-230	23-29	30	96.7
3	6-10	200-500	16-18	30	90
4	11-20	200-500	12-16	30	80
Aggregate (Radar Types 1-4)				120	91.675

**Table 2: Long Pulse Radar Test Waveform**

Radar Type	Pulse Width (µsec)	Chirp Width (MHz)	PRI (µsec)	Number of Pulses per Burst	Number of Bursts	Number of Trials(Times)	Percentage of Successful Detection (%)
5	50-100	5-20	1000-2000	1-3	8-20	30	100

**Table 3: Frequency Hopping Radar Test Waveform**

Radar Type	Pulse Width (µsec)	PRI (µsec)	Pulses per Hop	Hopping Rate (kHz)	Hopping Sequence Length (msec)	Number of Trials(Times)	Percentage of Successful Detection (%)
6	1	333	9	0.333	300	30	100

The Detailed Radar pattern and Statistical Performance showed in Annex A.



### IEEE 802.11ac 40MHz

**Table 1: Short Pulse Radar Test Waveforms.**

Radar Type	Pulse Width (µsec)	PRI (µsec)	Number of Pulses	Number of Trials(Times)	Percentage of Successful Detection (%)
1	1	1428	18	30	100
2	1-5	150-230	23-29	30	93.3
3	6-10	200-500	16-18	30	96.7
4	11-20	200-500	12-16	30	86.7
Aggregate (Radar Types 1-4)				120	94.175

**Table 2: Long Pulse Radar Test Waveform**

Radar Type	Pulse Width (µsec)	Chirp Width (MHz)	PRI (µsec)	Number of Pulses per Burst	Number of Bursts	Number of Trials(Times)	Percentage of Successful Detection (%)
5	50-100	5-20	1000-2000	1-3	8-20	30	86.7

**Table 3: Frequency Hopping Radar Test Waveform**

Radar Type	Pulse Width (µsec)	PRI (µsec)	Pulses per Hop	Hopping Rate (kHz)	Hopping Sequence Length (msec)	Number of Trials(Times)	Percentage of Successful Detection (%)
6	1	333	9	0.333	300	30	100

The Detailed Radar pattern and Statistical Performance showed in Annex A.



### IEEE 802.11ac 80MHz

**Table 1: Short Pulse Radar Test Waveforms.**

Radar Type	Pulse Width (µsec)	PRI (µsec)	Number of Pulses	Number of Trials(Times)	Percentage of Successful Detection (%)
1	1	1428	18	30	96.7
2	1-5	150-230	23-29	30	96.7
3	6-10	200-500	16-18	30	90
4	11-20	200-500	12-16	30	90
Aggregate (Radar Types 1-4)				120	93.35

**Table 2: Long Pulse Radar Test Waveform**

Radar Type	Pulse Width (µsec)	Chirp Width (MHz)	PRI (µsec)	Number of Pulses per Burst	Number of Bursts	Number of Trials(Times)	Percentage of Successful Detection (%)
5	50-100	5-20	1000-2000	1-3	8-20	30	96.7

**Table 3: Frequency Hopping Radar Test Waveform**

Radar Type	Pulse Width (µsec)	PRI (µsec)	Pulses per Hop	Hopping Rate (kHz)	Hopping Sequence Length (msec)	Number of Trials(Times)	Percentage of Successful Detection (%)
6	1	333	9	0.333	300	30	100

The Detailed Radar pattern and Statistical Performance showed in Annex A.

## Radar signal 0

IEEE 802.11ac 20MHz

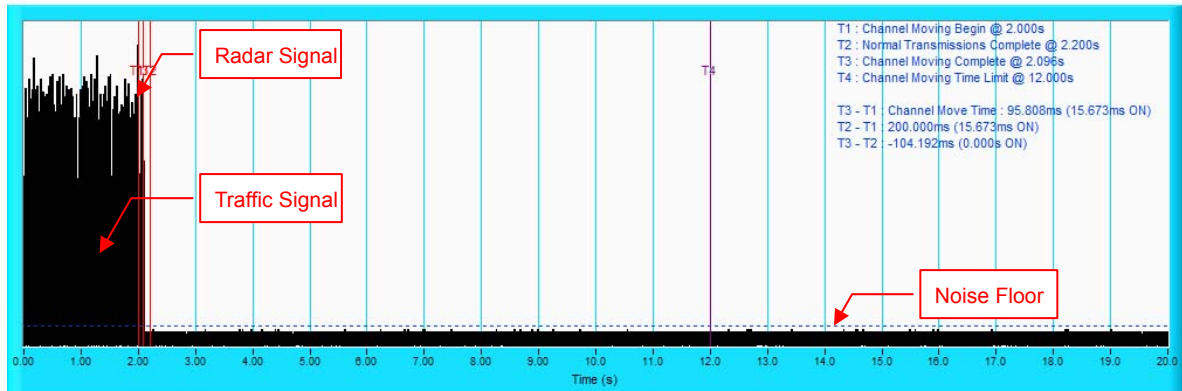

**NOTE:** T1 denotes the start of Channel Move Time upon the end of the last Radar burst. T2 denotes the data transmission time of 200ms from T1. T3 denotes the end of Channel Move Time. T4 denotes the 10 second from T1 to observe the aggregate duration of transmissions.

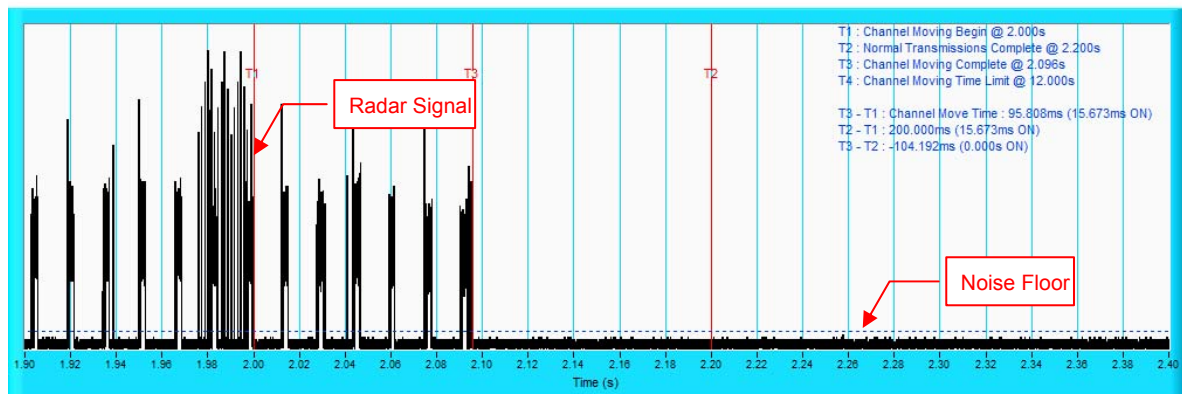

**NOTE:** Room-in of the first 500ms after radar signal applied.

# Radar signal 1

IEEE 802.11ac 20MHz

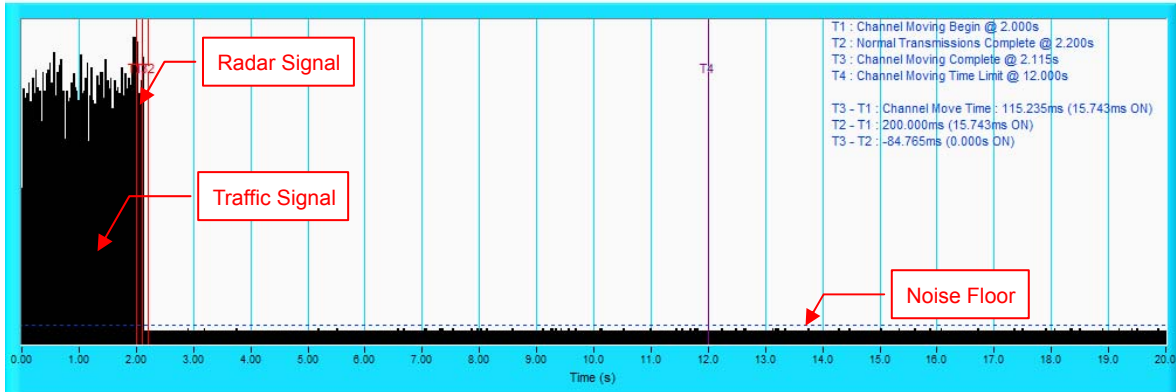

**NOTE:** T1 denotes the start of Channel Move Time upon the end of the last Radar burst. T2 denotes the data transmission time of 200ms from T1. T3 denotes the end of Channel Move Time. T4 denotes the 10 second from T1 to observe the aggregate duration of transmissions.

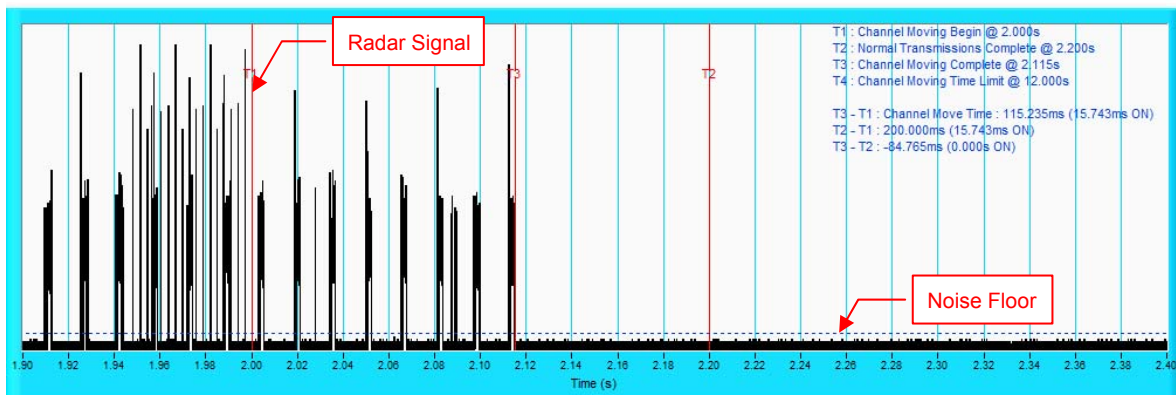

**NOTE:** Room-in of the first 500ms after radar signal applied.

## Radar signal 2

IEEE 802.11ac 20MHz

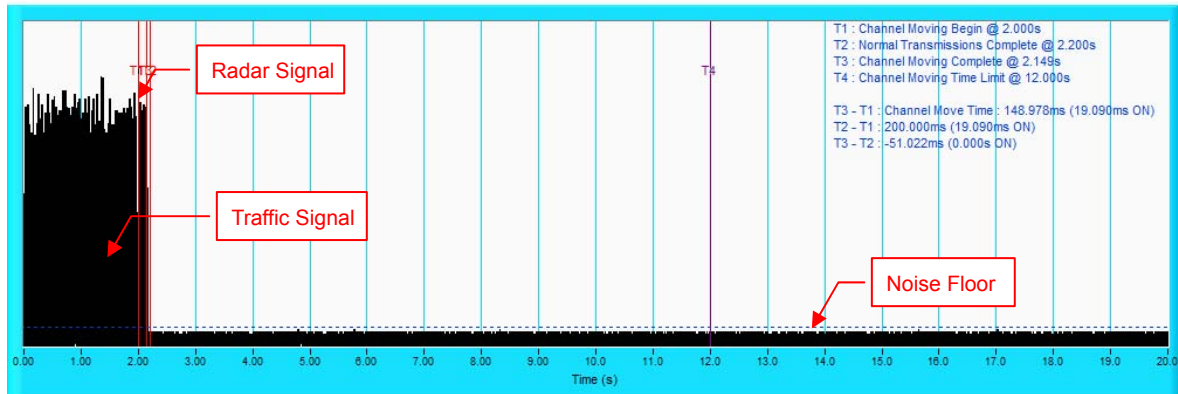

**NOTE:** T1 denotes the start of Channel Move Time upon the end of the last Radar burst. T2 denotes the data transmission time of 200ms from T1. T3 denotes the end of Channel Move Time. T4 denotes the 10 second from T1 to observe the aggregate duration of transmissions.

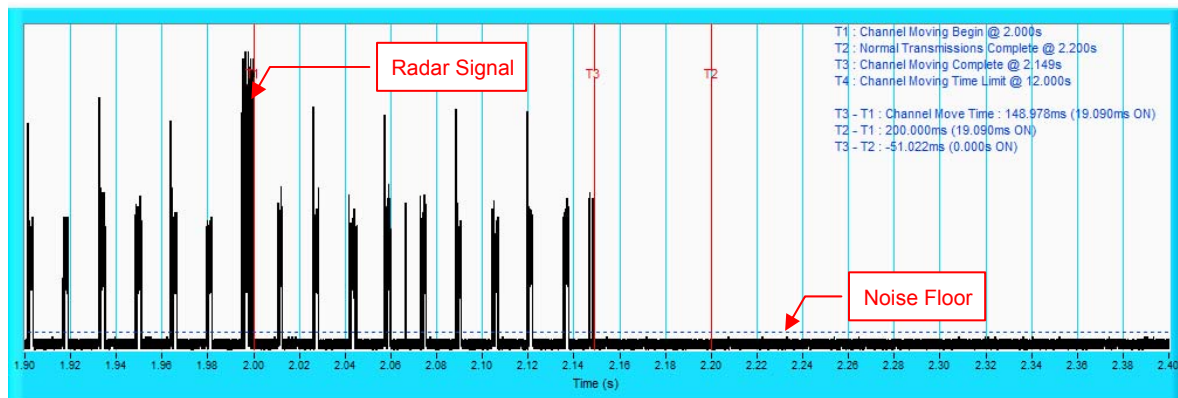

**NOTE:** Room-in of the first 500ms after radar signal applied.

### Radar signal 3

IEEE 802.11ac 20MHz

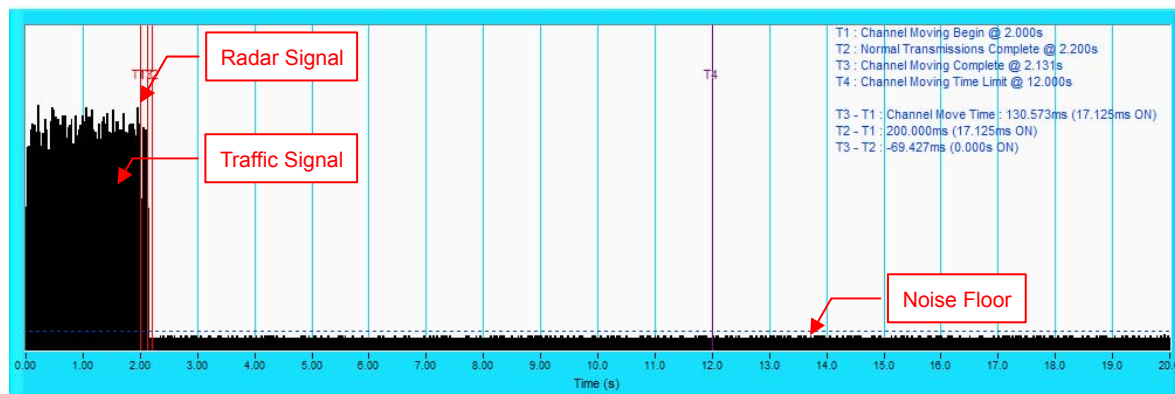

**NOTE:** T1 denotes the start of Channel Move Time upon the end of the last Radar burst. T2 denotes the data transmission time of 200ms from T1. T3 denotes the end of Channel Move Time. T4 denotes the 10 second from T1 to observe the aggregate duration of transmissions.

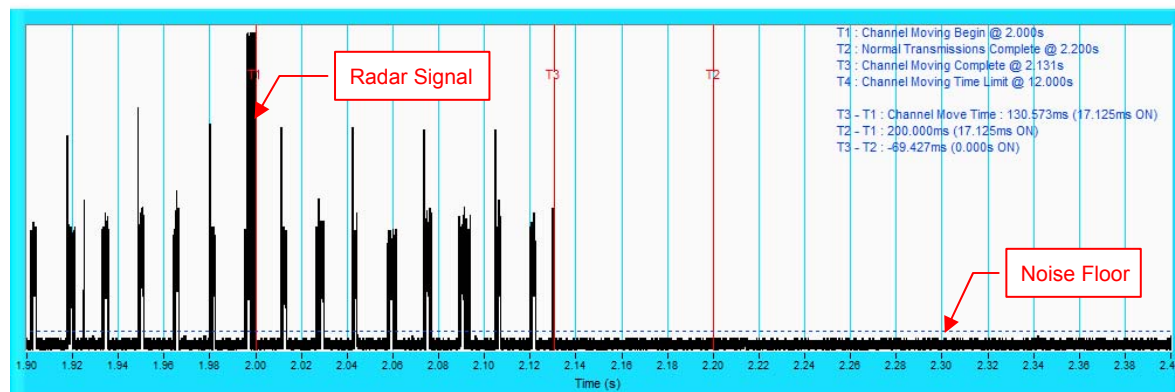

**NOTE:** Room-in of the first 500ms after radar signal applied.

## Radar signal 4

IEEE 802.11ac 20MHz

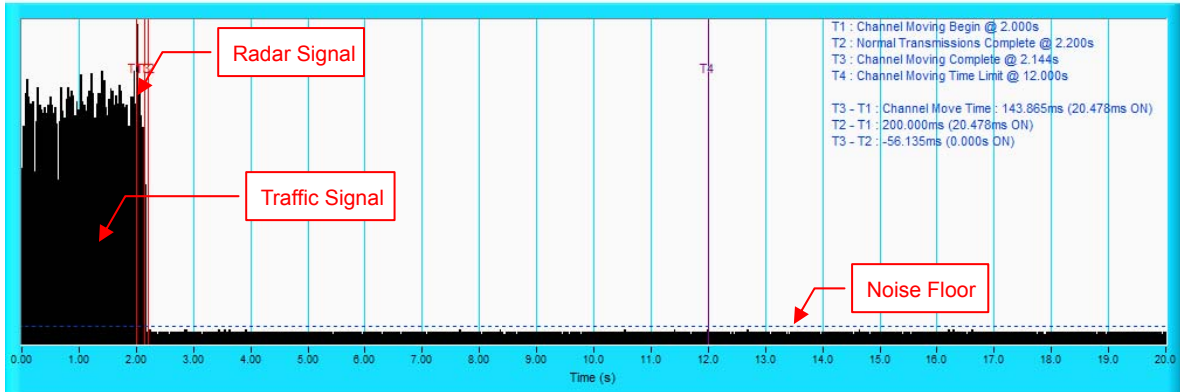

**NOTE:** T1 denotes the start of Channel Move Time upon the end of the last Radar burst. T2 denotes the data transmission time of 200ms from T1. T3 denotes the end of Channel Move Time. T4 denotes the 10 second from T1 to observe the aggregate duration of transmissions.

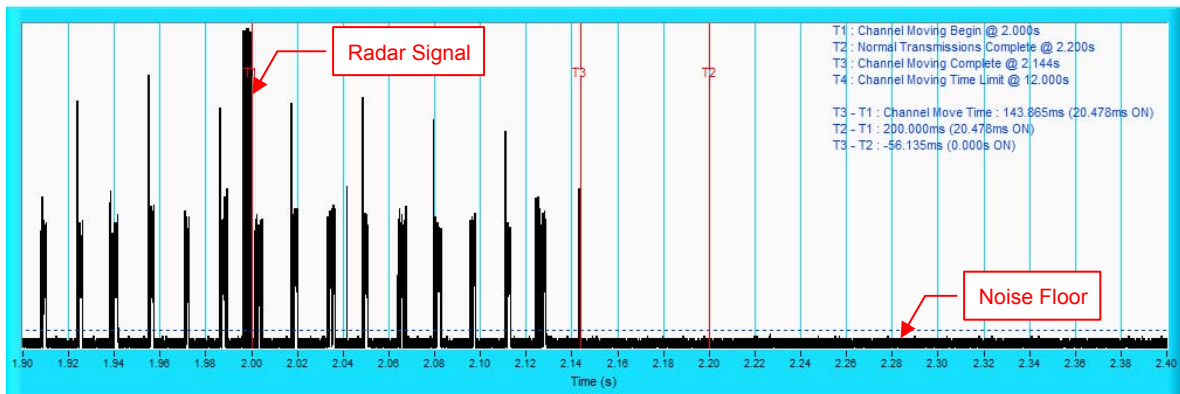

**NOTE:** Room-in of the first 500ms after radar signal applied.



## Radar signal 5

IEEE 802.11ac 20MHz

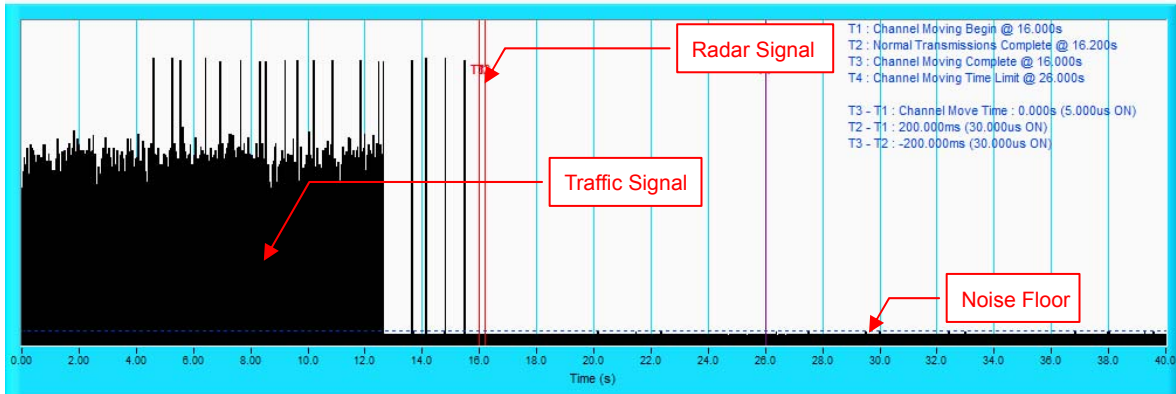

**NOTE:** T1 denotes the start of Channel Move Time upon the end of the last Radar burst. T2 denotes the data transmission time of 200ms from T1. T3 denotes the end of Channel Move Time. T4 denotes the 10 second from T1 to observe the aggregate duration of transmissions.

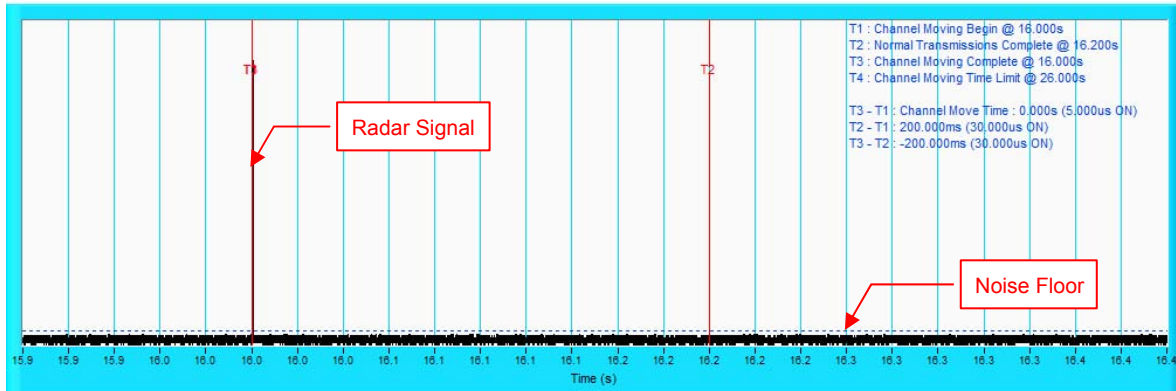

**NOTE:** Room-in of the first 500ms after radar signal applied.

## Radar signal 6

IEEE 802.11ac 20MHz

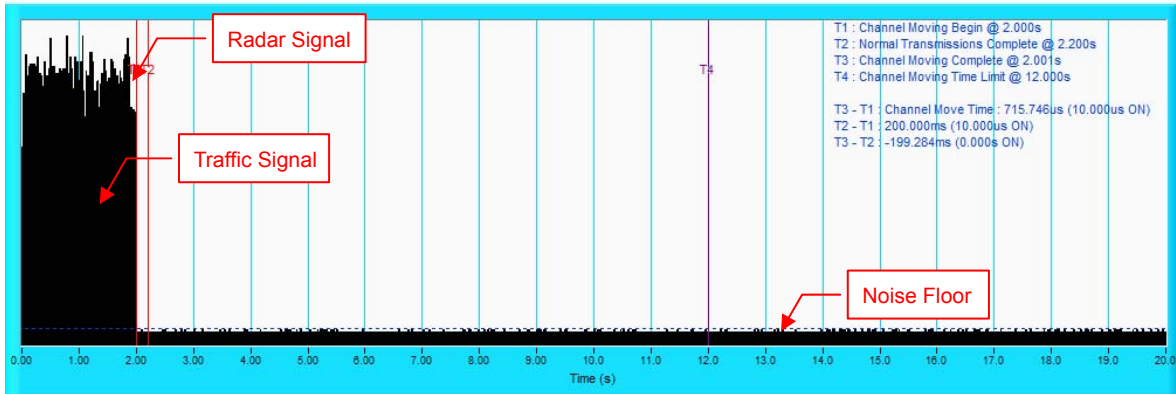

**NOTE:** T1 denotes the start of Channel Move Time upon the end of the last Radar burst. T2 denotes the data transmission time of 200ms from T1. T3 denotes the end of Channel Move Time. T4 denotes the 10 second from T1 to observe the aggregate duration of transmissions.

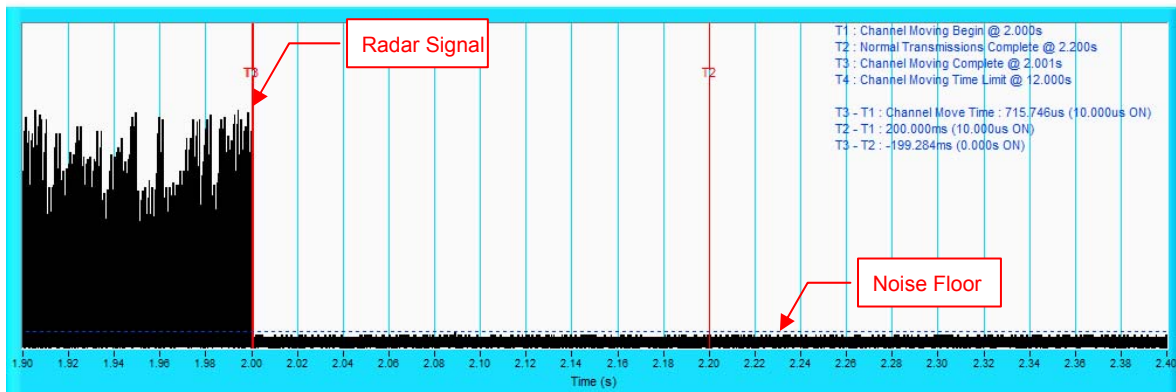

**NOTE:** Room-in of the first 500ms after radar signal applied.

## 6.2.5 NON- OCCUPANCY PERIOD

### Associate test:

During the 30 minutes observation time, UUT did not make any transmissions on a channel after a radar signal was detected on that channel by either the Channel Availability Check or the In-Service Monitoring.

- 1) EUT (Client) links with master on 5500MHz.

Waveform of EUT links up with Master

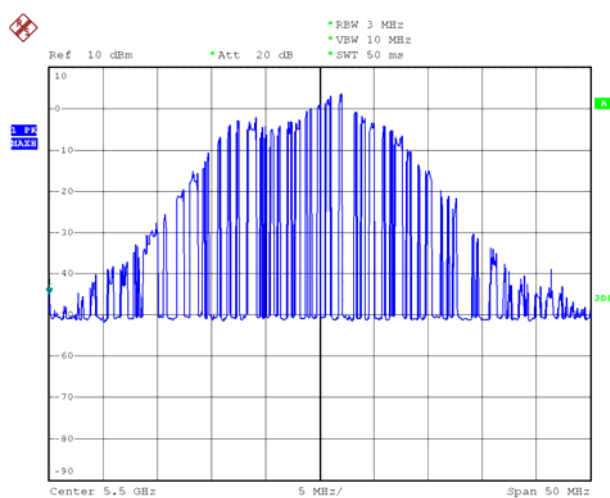

- 2) Client plays specified files via master.

Waveform of transmission

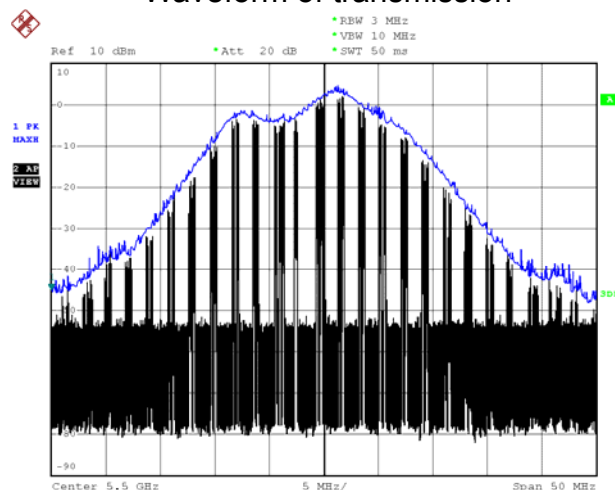

3) Radar signal is applied to the Master device and WiFi traffic signal stop immediately.

**Radar 0**



**Radar 1**

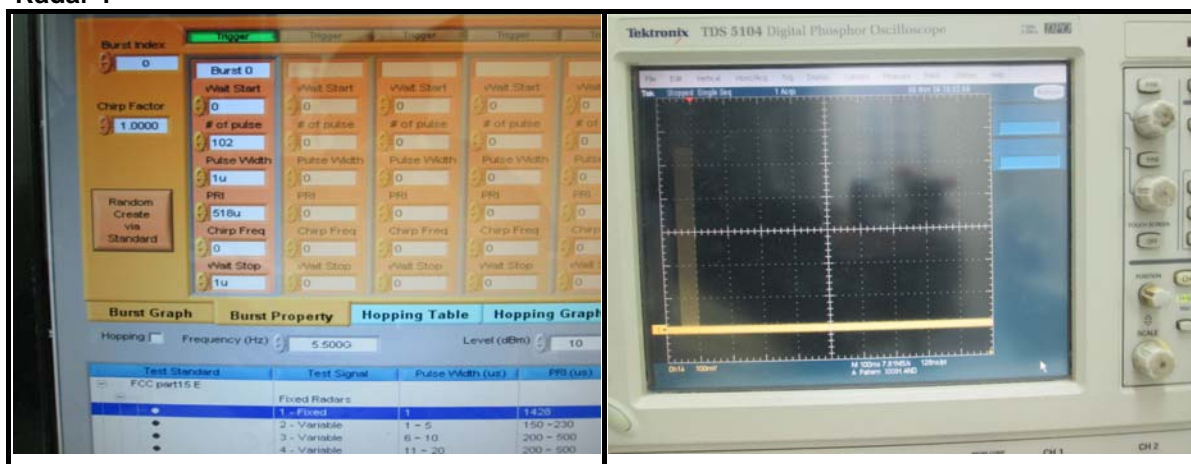

**Radar 2**



### Radar 3

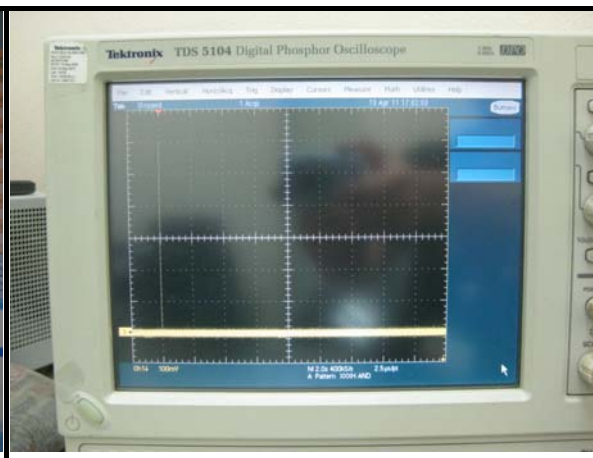

### Radar 4

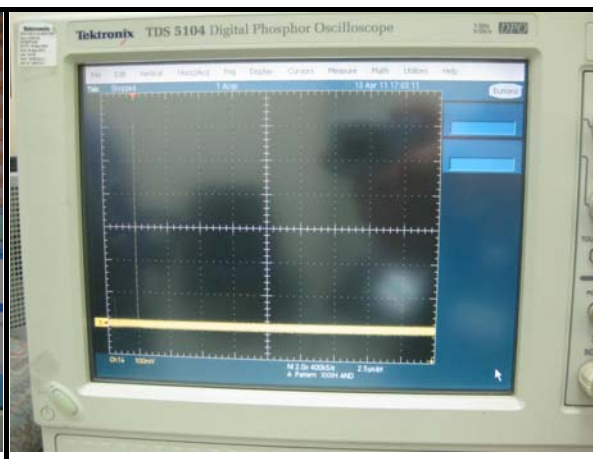
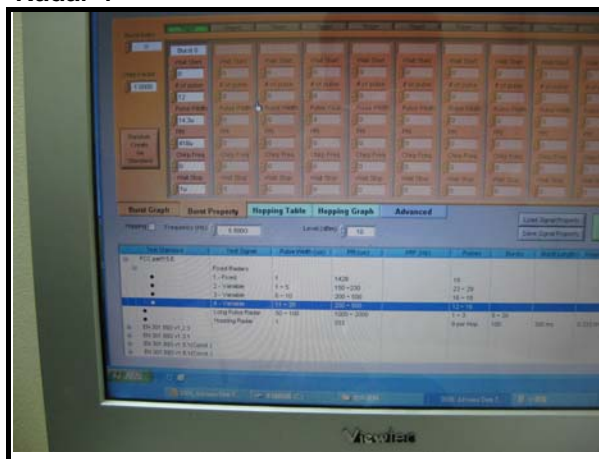

### Radar 5

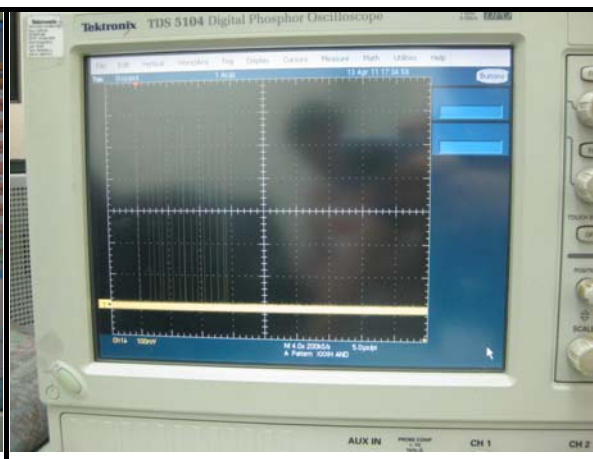

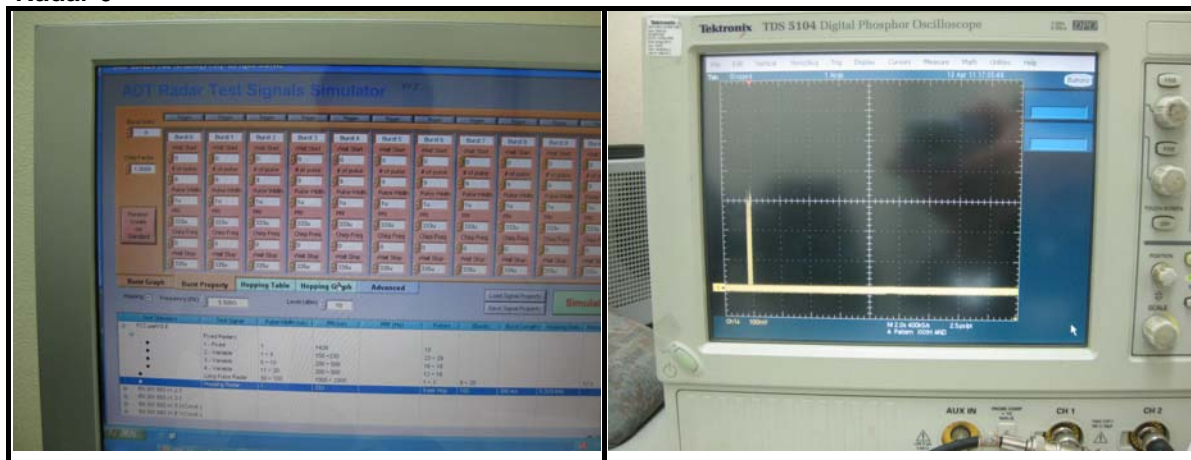
**Radar 6**

4) 5510MHz has been monitored in 30 minutes period. In this period, no any transmission occurs.

Plot of 30minutes period

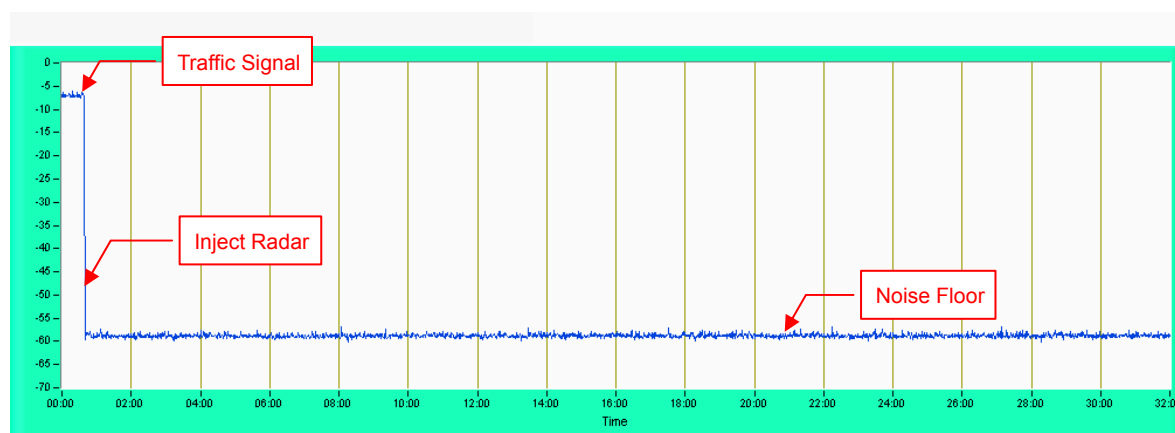
**802.11ac 20MHz**

**NOTE:** Test setup are shown on Test setup photo.pdf



## 6.2.6 UNIFORM SPREADING

The intention of the uniform spreading is to provide, on aggregate, a uniform loading of the spectrum. The EUT randomly select next output channel without any bias or fixed pattern, so that all channels in DFS bands (5250 to 5350MHz and 5470 to 5725 MHz) will be used equally.

## 6.2.7 TRANSMIT POWER CONTROL (TPC)

According to FCC 15.407(h)(1) the TPC mechanism is not required for system with an E.I.R.P. of less 500mW



## 7. INFORMATION ON THE TESTING LABORATORIES

We, Bureau Veritas Consumer Products Services (H.K.) Ltd., Taoyuan Branch, were founded in 1988 to provide our best service in EMC, Radio, Telecom and Safety consultation. Our laboratories are accredited and approved according to ISO/IEC 17025.

If you have any comments, please feel free to contact us at the following:

**Linko EMC/RF Lab**

Tel: 886-2-26052180

Fax: 886-2-26051924

**Hsin Chu EMC/RF/Telecom Lab**

Tel: 886-3-5935343

Fax: 886-3-5935342

**Hwa Ya EMC/RF/Safety Lab**

Tel: 886-3-3183232

Fax: 886-3-3270892

**Email:** [service.adt@tw.bureauveritas.com](mailto:service.adt@tw.bureauveritas.com)

**Web Site:** [www.bureauveritas-adt.com](http://www.bureauveritas-adt.com)

The address and road map of all our labs can be found in our web site also.





## **APPENDIX A - MODIFICATIONS RECORDERS FOR ENGINEERING CHANGES TO THE EUT BY THE LAB**

No modifications were made to the EUT by the lab during the test.

**---END---**

## Annex-A

### Annex A.1 : The Detailed Radar pattern and Statistical Performance

#### IEEE 802.11ac 20MHz

Type 1 Radar Statistical Performances				
Trial #	Pulses per Burst	Pulse Width (s)	PRI (s)	Detection
1	102	1.0u	518.0u	Yes
2	99	1.0u	538.0u	Yes
3	92	1.0u	578.0u	Yes
4	89	1.0u	598.0u	Yes
5	83	1.0u	638.0u	Yes
6	81	1.0u	658.0u	Yes
7	76	1.0u	698.0u	Yes
8	74	1.0u	718.0u	Yes
9	70	1.0u	758.0u	Yes
10	68	1.0u	778.0u	Yes
11	65	1.0u	818.0u	Yes
12	62	1.0u	858.0u	Yes
13	61	1.0u	878.0u	Yes
14	57	1.0u	938.0u	Yes
15	18	1.0u	3.066m	Yes
16	46	1.0u	1.152m	Yes
17	89	1.0u	599.0u	Yes
18	39	1.0u	1.365m	Yes
19	34	1.0u	1.577m	Yes
20	94	1.0u	563.0u	Yes
21	30	1.0u	1.790m	Yes
22	27	1.0u	2.002m	Yes
23	77	1.0u	687.0u	Yes
24	24	1.0u	2.215m	Yes
25	22	1.0u	2.428m	Yes
26	93	1.0u	571.0u	Yes
27	20	1.0u	2.640m	Yes
28	19	1.0u	2.853m	Yes
29	96	1.0u	555.0u	Yes
30	18	1.0u	3.065m	Yes
				Detection Rate: 100.0 %

Type 2 Radar Statistical Performances				
Trial #	Pulses per Burst	Pulse Width (s)	PRI (s)	Detection
1	23	2.3u	222.0u	Yes
2	28	1.8u	204.0u	Yes
3	26	1.6u	225.0u	Yes
4	27	3.8u	168.0u	Yes
5	27	1.1u	227.0u	Yes
6	27	2.6u	166.0u	Yes
7	24	4.7u	161.0u	Yes
8	28	1.9u	180.0u	Yes
9	29	1.3u	176.0u	Yes
10	23	1.8u	170.0u	Yes
11	29	1.4u	195.0u	Yes
12	25	3.4u	228.0u	Yes
13	26	2.3u	206.0u	Yes
14	27	4.5u	189.0u	Yes
15	25	3.9u	194.0u	Yes
16	25	3.0u	154.0u	No
17	23	3.6u	182.0u	Yes
18	26	3.4u	160.0u	Yes
19	25	3.3u	229.0u	Yes
20	23	1.9u	151.0u	Yes
21	25	1.8u	184.0u	Yes
22	28	2.3u	229.0u	Yes
23	29	1.1u	210.0u	Yes
24	26	2.2u	203.0u	Yes
25	25	2.9u	222.0u	Yes
26	28	1.4u	220.0u	Yes
27	26	1.8u	155.0u	Yes
28	29	3.4u	155.0u	Yes
29	28	3.1u	204.0u	Yes
30	26	4.4u	176.0u	Yes
			Detection Rate: 96.7 %	

Type 3 Radar Statistical Performances				
Trial #	Pulses per Burst	Pulse Width (s)	PRI (s)	Detection
1	18	7.8u	292.0u	Yes
2	18	7.0u	366.0u	Yes
3	18	9.2u	486.0u	Yes
4	17	6.8u	216.0u	Yes
5	18	7.3u	446.0u	Yes
6	16	6.6u	208.0u	Yes
7	17	6.8u	347.0u	Yes
8	17	9.6u	232.0u	Yes
9	17	6.2u	364.0u	No
10	16	7.1u	407.0u	Yes
11	18	6.6u	458.0u	No
12	17	9.1u	226.0u	Yes
13	16	6.9u	297.0u	Yes
14	18	9.8u	463.0u	Yes
15	17	6.1u	329.0u	Yes
16	17	10.0u	333.0u	Yes
17	18	8.5u	399.0u	No
18	17	8.7u	316.0u	Yes
19	16	9.9u	402.0u	Yes
20	17	6.9u	446.0u	Yes
21	16	6.6u	451.0u	Yes
22	16	8.2u	272.0u	Yes
23	17	8.5u	395.0u	Yes
24	17	8.4u	379.0u	Yes
25	16	7.4u	292.0u	Yes
26	16	9.8u	489.0u	Yes
27	17	7.7u	375.0u	Yes
28	16	7.7u	297.0u	Yes
29	18	9.2u	347.0u	Yes
30	16	6.9u	415.0u	Yes
			Detection Rate: 90.0 %	

Type 4 Radar Statistical Performances				
Trial #	Pulses per Burst	Pulse Width (s)	PRI (s)	Detection
1	14	18.2u	402.0u	No
2	13	14.5u	226.0u	No
3	15	13.7u	340.0u	Yes
4	16	12.2u	469.0u	Yes
5	12	14.6u	220.0u	No
6	15	17.0u	370.0u	Yes
7	15	11.4u	458.0u	Yes
8	13	11.6u	487.0u	Yes
9	16	16.2u	202.0u	Yes
10	15	19.8u	363.0u	Yes
11	14	11.8u	424.0u	No
12	14	18.0u	407.0u	Yes
13	16	17.8u	256.0u	Yes
14	16	13.1u	420.0u	Yes
15	13	18.6u	243.0u	Yes
16	14	13.4u	284.0u	Yes
17	12	17.7u	410.0u	Yes
18	15	19.3u	234.0u	Yes
19	14	11.9u	411.0u	No
20	16	13.4u	420.0u	Yes
21	14	19.2u	235.0u	Yes
22	14	15.2u	406.0u	Yes
23	15	18.7u	408.0u	Yes
24	13	16.1u	366.0u	Yes
25	13	11.3u	369.0u	No
26	14	17.1u	284.0u	Yes
27	13	13.5u	495.0u	Yes
28	15	16.8u	424.0u	Yes
29	14	16.3u	322.0u	Yes
30	13	13.0u	314.0u	Yes
			Detection Rate: 80.0 %	

Type 5 Radar Statistical Performances		
Trial #	Test Signal Name	Detection
1	LP_Signal_01	Yes
2	LP_Signal_02	Yes
3	LP_Signal_03	Yes
4	LP_Signal_04	Yes
5	LP_Signal_05	Yes
6	LP_Signal_06	Yes
7	LP_Signal_07	Yes
8	LP_Signal_08	Yes
9	LP_Signal_09	Yes
10	LP_Signal_10	Yes
11	LP_Signal_11	Yes
12	LP_Signal_12	Yes
13	LP_Signal_13	Yes
14	LP_Signal_14	Yes
15	LP_Signal_15	Yes
16	LP_Signal_16	Yes
17	LP_Signal_17	Yes
18	LP_Signal_18	Yes
19	LP_Signal_19	Yes
20	LP_Signal_20	Yes
21	LP_Signal_21	Yes
22	LP_Signal_22	Yes
23	LP_Signal_23	Yes
24	LP_Signal_24	Yes
25	LP_Signal_25	Yes
26	LP_Signal_26	Yes
27	LP_Signal_27	Yes
28	LP_Signal_28	Yes
29	LP_Signal_29	Yes
30	LP_Signal_30	Yes
		Detection Rate: 100.0 %

Long Pulse Radar Test Signal						
Test Signal Name: LP_Signal_01						
Number of Bursts in Trial: 12						
Burst	Pulses per Burst	Chrip (Hz)	Pulse Width (s)	Pulse 1 to 2 Spacing (s)	Pulse 2 to 3 Spacing (s)	Start Location (s)
1	3	16M	91.9u	1.625m	1.529m	565.7m
2	2	16M	75.9u	1.589m	-	811.7m
3	2	11M	72.4u	1.689m	-	197.9m
4	1	14M	78.5u	-	-	65.03m
5	2	14M	80.9u	1.448m	-	779.0m
6	2	8M	61.5u	1.571m	-	852.0m
7	3	15M	52.9u	1.290m	1.282m	234.1m
8	3	15M	75.5u	1.804m	1.084m	262.4m
9	3	15M	82.4u	1.423m	1.316m	906.2m
10	2	10M	84.4u	1.882m	-	1.690m
11	2	11M	52.5u	1.283m	-	898.7m
12	2	9M	64.3u	1.711m	-	288.9m

Long Pulse Radar Test Signal						
Test Signal Name: LP_Signal_02						
Number of Bursts in Trial: 16						
Burst	Pulses per Burst	Chrip (Hz)	Pulse Width (s)	Pulse 1 to 2 Spacing (s)	Pulse 2 to 3 Spacing (s)	Start Location (s)
1	1	18M	87.1u	-	-	77.85m
2	3	12M	58.5u	1.783m	1.204m	640.9m
3	1	11M	84.9u	-	-	735.5m
4	2	6M	83.9u	1.545m	-	703.0m
5	3	7M	51.1u	1.413m	1.106m	548.4m
6	2	16M	94.5u	1.739m	-	168.4m
7	2	15M	97.2u	1.433m	-	13.53m
8	2	12M	75.9u	1.034m	-	706.0m
9	1	6M	88.8u	-	-	300.3m
10	2	11M	85.2u	1.505m	-	402.0m
11	2	17M	95.6u	1.049m	-	67.26m

12	2	17M	57.8u	1.542m	-	264.6m
13	3	18M	56.3u	1.379m	1.142m	729.6m
14	1	14M	84.1u	-	-	237.0m
15	1	18M	61.0u	-	-	343.0m
16	2	9M	73.3u	1.850m	-	311.6m

Long Pulse Radar Test Signal						
Test Signal Name: LP_Signal_03						
Number of Bursts in Trial: 16						
Burst	Pulses per Burst	Chrip (Hz)	Pulse Width (s)	Pulse 1 to 2 Spacing (s)	Pulse 2 to 3 Spacing (s)	Start Location (s)
1	3	9M	59.2u	989.8u	1.578m	274.7m
2	1	17M	53.7u	-	-	586.8m
3	2	12M	65.5u	1.620m	-	127.3m
4	2	13M	76.5u	1.509m	-	615.0m
5	1	9M	82.3u	-	-	59.17m
6	2	11M	68.1u	978.9u	-	28.97m
7	3	16M	73.0u	1.071m	1.395m	385.9m
8	1	7M	67.5u	-	-	276.1m
9	2	9M	72.9u	1.557m	-	644.9m
10	2	16M	64.6u	1.935m	-	51.74m
11	3	16M	79.7u	1.340m	1.407m	166.1m
12	2	16M	57.8u	1.761m	-	136.2m
13	1	11M	94.9u	-	-	445.9m
14	2	10M	64.3u	943.7u	-	713.6m
15	2	15M	59.4u	1.679m	-	446.6m
16	1	9M	52.2u	-	-	687.9m

Long Pulse Radar Test Signal						
Test Signal Name: LP_Signal_04						
Number of Bursts in Trial: 20						
Burst	Pulses per Burst	Chrip (Hz)	Pulse Width (s)	Pulse 1 to 2 Spacing (s)	Pulse 2 to 3 Spacing (s)	Start Location (s)
1	2	15M	79.2u	1.618m	-	381.5m
2	1	18M	57.9u	-	-	328.1m



3	2	7M	76.5u	1.275m	-	11.12m
4	1	6M	92.9u	-	-	394.7m
5	3	9M	64.1u	1.573m	1.046m	193.1m
6	1	6M	66.2u	-	-	248.3m
7	3	18M	91.2u	1.187m	1.675m	125.8m
8	1	19M	83.8u	-	-	542.9m
9	1	8M	54.7u	-	-	524.7m
10	1	17M	60.6u	-	-	1.331m
11	1	7M	75.9u	-	-	52.21m
12	2	13M	51.7u	1.007m	-	202.1m
13	2	18M	55.4u	1.022m	-	485.8m
14	2	11M	78.5u	1.384m	-	395.1m
15	3	9M	71.6u	1.856m	1.109m	103.7m
16	3	16M	66.7u	1.669m	1.583m	399.4m
17	1	7M	73.3u	-	-	205.4m
18	1	12M	98.3u	-	-	394.4m
19	3	7M	76.5u	1.625m	1.562m	252.6m
20	1	19M	65.9u	-	-	169.7m

Long Pulse Radar Test Signal						
Test Signal Name: LP_Signal_05						
Number of Bursts in Trial: 19						
Burst	Pulses per Burst	Chrip (Hz)	Pulse Width (s)	Pulse 1 to 2 Spacing (s)	Pulse 2 to 3 Spacing (s)	Start Location (s)
1	2	17M	55.4u	1.110m	-	337.0m
2	2	14M	52.8u	1.275m	-	533.6m
3	2	8M	65.3u	1.283m	-	2.790m
4	2	20M	89.1u	1.137m	-	402.4m
5	1	8M	95.4u	-	-	502.0m
6	1	7M	74.0u	-	-	19.45m
7	2	18M	66.8u	1.161m	-	144.6m
8	3	16M	70.6u	1.445m	1.396m	430.1m
9	2	12M	80.1u	989.9u	-	208.7m
10	2	11M	66.2u	1.883m	-	472.7m
11	3	14M	60.6u	965.4u	1.125m	28.07m
12	3	6M	80.3u	1.518m	1.598m	247.2m

13	3	5M	91.8u	1.315m	1.502m	403.3m
14	2	5M	67.8u	1.877m	-	137.9m
15	2	6M	68.6u	1.718m	-	20.01m
16	1	10M	93.4u	-	-	335.4m
17	3	14M	86.8u	995.2u	1.865m	382.3m
18	3	17M	81.0u	1.452m	1.491m	456.4m
19	1	5M	80.0u	-	-	7.999m

Long Pulse Radar Test Signal						
Test Signal Name: LP_Signal_06						
Number of Bursts in Trial: 20						
Burst	Pulses per Burst	Chrip (Hz)	Pulse Width (s)	Pulse 1 to 2 Spacing (s)	Pulse 2 to 3 Spacing (s)	Start Location (s)
1	2	8M	72.0u	1.473m	-	596.6m
2	1	6M	92.3u	-	-	92.43m
3	2	8M	78.3u	1.799m	-	375.9m
4	2	16M	96.4u	1.171m	-	466.8m
5	2	16M	62.3u	1.297m	-	241.4m
6	1	5M	60.2u	-	-	406.2m
7	2	15M	74.7u	1.718m	-	552.6m
8	2	12M	96.3u	1.745m	-	563.0m
9	3	10M	55.6u	1.174m	1.232m	458.1m
10	2	6M	78.5u	1.458m	-	253.2m
11	2	6M	82.7u	1.734m	-	422.7m
12	2	17M	88.5u	1.560m	-	377.6m
13	3	12M	68.7u	1.891m	1.556m	482.5m
14	1	8M	50.9u	-	-	491.6m
15	1	12M	65.2u	-	-	396.6m
16	1	12M	61.8u	-	-	546.9m
17	3	12M	72.8u	1.299m	1.545m	548.2m
18	1	7M	67.7u	-	-	379.9m
19	2	15M	89.8u	1.514m	-	90.49m
20	2	8M	67.8u	1.367m	-	277.3m

Long Pulse Radar Test Signal						
Test Signal Name: LP_Signal_07						
Number of Bursts in Trial: 10						
Burst	Pulses per Burst	Chrip (Hz)	Pulse Width (s)	Pulse 1 to 2 Spacing (s)	Pulse 2 to 3 Spacing (s)	Start Location (s)
1	2	12M	97.9u	980.1u	-	735.2m
2	3	15M	84.1u	1.294m	1.781m	580.5m
3	2	19M	50.5u	1.063m	-	203.6m
4	3	6M	70.9u	1.325m	1.566m	478.5m
5	3	14M	80.4u	1.344m	1.635m	939.6m
6	2	13M	73.6u	1.612m	-	841.0m
7	3	8M	82.2u	1.809m	1.224m	403.8m
8	2	11M	54.3u	1.372m	-	1.112
9	1	7M	56.3u	-	-	360.8m
10	2	13M	57.5u	1.170m	-	880.8m

Long Pulse Radar Test Signal						
Test Signal Name: LP_Signal_08						
Number of Bursts in Trial: 11						
Burst	Pulses per Burst	Chrip (Hz)	Pulse Width (s)	Pulse 1 to 2 Spacing (s)	Pulse 2 to 3 Spacing (s)	Start Location (s)
1	2	8M	79.1u	1.701m	-	980.7m
2	2	6M	56.4u	1.454m	-	500.9m
3	3	13M	84.9u	1.586m	1.740m	875.6m
4	2	10M	65.8u	958.2u	-	299.7m
5	1	18M	79.6u	-	-	69.72m
6	3	18M	72.7u	1.000m	1.751m	882.4m
7	2	17M	63.7u	1.113m	-	743.8m
8	3	15M	98.6u	1.301m	1.364m	970.4m
9	2	14M	79.9u	1.042m	-	782.9m
10	2	9M	95.2u	1.243m	-	325.3m
11	1	11M	84.8u	-	-	399.2m

Long Pulse Radar Test Signal						
Test Signal Name: LP_Signal_09						
Number of Bursts in Trial: 15						
Burst	Pulses per Burst	Chrip (Hz)	Pulse Width (s)	Pulse 1 to 2 Spacing (s)	Pulse 2 to 3 Spacing (s)	Start Location (s)
1	2	7M	79.8u	1.015m	-	445.3m
2	2	10M	70.8u	1.078m	-	136.1m
3	1	14M	51.8u	-	-	591.2m
4	1	16M	67.2u	-	-	639.7m
5	3	20M	69.4u	1.798m	1.290m	602.8m
6	2	17M	71.1u	1.063m	-	257.6m
7	3	15M	66.2u	1.558m	1.463m	639.9m
8	2	8M	51.3u	1.625m	-	425.4m
9	1	12M	64.0u	-	-	635.1m
10	1	17M	57.8u	-	-	98.61m
11	2	15M	90.0u	1.492m	-	19.03m
12	2	12M	53.3u	1.359m	-	406.8m
13	2	14M	77.0u	1.230m	-	298.7m
14	3	14M	54.6u	1.070m	1.481m	35.97m
15	2	6M	95.1u	1.392m	-	199.0m

Long Pulse Radar Test Signal						
Test Signal Name: LP_Signal_10						
Number of Bursts in Trial: 14						
Burst	Pulses per Burst	Chrip (Hz)	Pulse Width (s)	Pulse 1 to 2 Spacing (s)	Pulse 2 to 3 Spacing (s)	Start Location (s)
1	3	20M	53.2u	1.370m	1.440m	847.0m
2	1	12M	57.8u	-	-	722.5m
3	3	18M	75.3u	1.665m	1.480m	270.6m
4	2	16M	73.4u	1.410m	-	211.4m
5	3	19M	76.1u	1.194m	1.901m	163.5m
6	2	11M	63.8u	1.894m	-	388.2m
7	1	14M	90.8u	-	-	754.6m
8	2	12M	57.3u	1.786m	-	643.1m

9	2	20M	80.7u	1.561m	-	177.8m
10	2	6M	55.3u	1.912m	-	516.7m
11	2	14M	54.7u	1.826m	-	563.2m
12	1	9M	53.2u	-	-	668.2m
13	3	14M	64.7u	1.691m	1.676m	345.0m
14	1	11M	83.4u	-	-	105.1m

Long Pulse Radar Test Signal						
Test Signal Name: LP_Signal_11						
Number of Bursts in Trial: 18						
Burst	Pulses per Burst	Chrip (Hz)	Pulse Width (s)	Pulse 1 to 2 Spacing (s)	Pulse 2 to 3 Spacing (s)	Start Location (s)
1	3	10M	87.7u	980.3u	1.107m	193.6m
2	2	13M	65.3u	1.296m	-	556.0m
3	2	18M	88.0u	967.0u	-	368.2m
4	2	14M	69.0u	1.807m	-	298.2m
5	1	11M	68.0u	-	-	386.0m
6	1	12M	95.5u	-	-	34.34m
7	3	17M	80.0u	1.655m	1.210m	210.0m
8	2	6M	72.7u	1.040m	-	176.6m
9	1	17M	59.5u	-	-	510.6m
10	2	9M	86.1u	1.833m	-	392.1m
11	2	20M	53.0u	1.253m	-	118.4m
12	2	19M	75.3u	1.439m	-	265.4m
13	2	11M	56.6u	1.085m	-	293.6m
14	1	17M	56.5u	-	-	550.0m
15	2	14M	60.7u	1.452m	-	223.8m
16	2	20M	82.6u	1.466m	-	285.0m
17	3	15M	89.3u	1.848m	1.844m	418.3m
18	2	11M	95.1u	1.119m	-	13.20m

Long Pulse Radar Test Signal						
Test Signal Name: LP_Signal_12						
Number of Bursts in Trial: 13						
Burst	Pulses per Burst	Chrip (Hz)	Pulse Width (s)	Pulse 1 to 2 Spacing (s)	Pulse 2 to 3 Spacing (s)	Start Location (s)
1	3	10M	99.4u	1.551m	999.6u	191.8m
2	3	12M	86.8u	1.344m	1.025m	149.3m
3	2	15M	66.1u	965.9u	-	156.3m
4	2	19M	80.9u	1.495m	-	621.3m
5	2	9M	85.1u	1.654m	-	693.2m
6	1	17M	82.1u	-	-	216.5m
7	2	12M	91.3u	1.796m	-	703.8m
8	2	16M	60.6u	1.377m	-	888.8m
9	1	15M	86.6u	-	-	31.13m
10	1	20M	58.2u	-	-	396.1m
11	2	17M	79.6u	1.899m	-	115.7m
12	3	9M	97.8u	1.524m	1.020m	331.7m
13	3	6M	59.2u	1.066m	1.132m	328.2m

Long Pulse Radar Test Signal						
Test Signal Name: LP_Signal_13						
Number of Bursts in Trial: 9						
Burst	Pulses per Burst	Chrip (Hz)	Pulse Width (s)	Pulse 1 to 2 Spacing (s)	Pulse 2 to 3 Spacing (s)	Start Location (s)
1	1	8M	84.6u	-	-	1.201
2	1	7M	82.9u	-	-	1.303
3	1	19M	59.0u	-	-	1.249
4	2	14M	72.5u	1.734m	-	978.3m
5	2	17M	56.3u	1.590m	-	77.31m
6	2	7M	67.1u	1.247m	-	9.363m
7	3	7M	94.5u	1.828m	1.190m	951.3m
8	1	20M	81.6u	-	-	119.8m
9	1	9M	52.3u	-	-	1.244

Long Pulse Radar Test Signal						
Test Signal Name: LP_Signal_14						
Number of Bursts in Trial: 19						
Burst	Pulses per Burst	Chrip (Hz)	Pulse Width (s)	Pulse 1 to 2 Spacing (s)	Pulse 2 to 3 Spacing (s)	Start Location (s)
1	3	6M	96.3u	986.7u	1.789m	115.1m
2	1	14M	73.1u	-	-	456.2m
3	2	8M	84.3u	1.302m	-	504.6m
4	3	13M	97.8u	1.856m	1.244m	477.8m
5	1	6M	87.7u	-	-	143.9m
6	2	6M	55.9u	1.597m	-	628.5m
7	3	9M	62.4u	1.661m	1.629m	258.8m
8	1	6M	98.4u	-	-	581.0m
9	3	5M	52.9u	1.388m	1.776m	75.02m
10	3	17M	92.1u	1.177m	1.871m	584.1m
11	2	13M	66.9u	1.549m	-	105.1m
12	1	10M	77.4u	-	-	582.8m
13	2	9M	66.0u	1.537m	-	346.2m
14	3	9M	76.8u	1.598m	1.020m	404.1m
15	2	16M	53.9u	1.377m	-	609.7m
16	3	6M	82.2u	1.780m	1.569m	566.8m
17	3	18M	98.9u	1.542m	1.695m	474.4m
18	1	18M	89.4u	-	-	544.6m
19	2	18M	78.3u	1.538m	-	417.0m

Long Pulse Radar Test Signal						
Test Signal Name: LP_Signal_15						
Number of Bursts in Trial: 17						
Burst	Pulses per Burst	Chrip (Hz)	Pulse Width (s)	Pulse 1 to 2 Spacing (s)	Pulse 2 to 3 Spacing (s)	Start Location (s)
1	2	12M	61.4u	1.820m	-	361.4m
2	2	5M	79.3u	1.561m	-	480.5m
3	2	8M	57.3u	1.014m	-	471.6m
4	3	12M	54.5u	1.506m	1.378m	103.6m
5	1	19M	81.3u	-	-	651.5m

6	1	18M	72.5u	-	-	5.587m
7	1	17M	83.9u	-	-	445.1m
8	2	16M	95.5u	939.5u	-	506.6m
9	3	14M	80.8u	1.659m	1.835m	229.8m
10	1	10M	74.7u	-	-	605.0m
11	3	19M	86.6u	1.813m	1.646m	333.9m
12	2	12M	52.7u	1.659m	-	571.8m
13	1	10M	77.9u	-	-	130.5m
14	1	11M	82.3u	-	-	461.2m
15	2	16M	61.2u	1.612m	-	53.40m
16	2	11M	64.1u	1.174m	-	189.1m
17	3	20M	51.9u	1.658m	1.249m	414.4m

Long Pulse Radar Test Signal						
Test Signal Name: LP_Signal_16						
Number of Bursts in Trial: 9						
Burst	Pulses per Burst	Chrip (Hz)	Pulse Width (s)	Pulse 1 to 2 Spacing (s)	Pulse 2 to 3 Spacing (s)	Start Location (s)
1	2	17M	89.6u	931.4u	-	83.32m
2	3	15M	92.8u	961.2u	1.382m	1.158
3	3	8M	84.8u	1.329m	1.350m	569.1m
4	2	15M	53.6u	975.4u	-	918.7m
5	2	13M	59.5u	1.818m	-	1.325
6	3	18M	78.0u	1.201m	1.352m	485.3m
7	2	14M	76.5u	1.556m	-	906.1m
8	3	18M	69.0u	1.076m	1.474m	243.8m
9	2	6M	99.6u	1.413m	-	1.151

Long Pulse Radar Test Signal						
Test Signal Name: LP_Signal_17						
Number of Bursts in Trial: 19						
Burst	Pulses per Burst	Chrip (Hz)	Pulse Width (s)	Pulse 1 to 2 Spacing (s)	Pulse 2 to 3 Spacing (s)	Start Location (s)
1	2	20M	76.2u	1.877m	-	592.2m
2	2	18M	50.9u	1.400m	-	403.4m



3	3	19M	79.0u	1.294m	1.378m	499.5m
4	2	14M	77.9u	1.200m	-	141.6m
5	2	8M	82.3u	1.745m	-	12.50m
6	2	11M	61.7u	1.821m	-	601.1m
7	2	10M	74.6u	1.309m	-	97.87m
8	2	19M	85.7u	1.383m	-	565.9m
9	1	11M	98.4u	-	-	162.8m
10	2	6M	81.9u	1.465m	-	393.8m
11	1	9M	79.1u	-	-	335.4m
12	3	14M	59.0u	997.0u	1.554m	561.7m
13	2	17M	94.4u	1.879m	-	388.9m
14	2	5M	69.0u	1.924m	-	117.1m
15	2	9M	70.6u	1.525m	-	197.4m
16	1	18M	95.3u	-	-	230.7m
17	2	20M	73.9u	1.627m	-	328.9m
18	3	14M	65.3u	1.687m	1.344m	200.3m
19	2	12M	69.7u	1.181m	-	563.6m

Long Pulse Radar Test Signal						
Test Signal Name: LP_Signal_18						
Number of Bursts in Trial: 11						
Burst	Pulses per Burst	Chrip (Hz)	Pulse Width (s)	Pulse 1 to 2 Spacing (s)	Pulse 2 to 3 Spacing (s)	Start Location (s)
1	3	10M	80.3u	1.555m	1.048m	707.2m
2	2	14M	98.5u	1.522m	-	81.83m
3	2	7M	99.1u	1.510m	-	522.1m
4	2	15M	68.3u	1.565m	-	925.9m
5	3	14M	59.2u	1.571m	1.736m	770.8m
6	2	18M	93.9u	1.058m	-	262.2m
7	2	19M	82.1u	1.238m	-	888.1m
8	2	11M	87.2u	1.427m	-	507.4m
9	2	17M	94.1u	1.672m	-	372.0m
10	2	13M	85.6u	1.259m	-	303.9m
11	1	16M	69.5u	-	-	558.0m

Long Pulse Radar Test Signal						
Test Signal Name: LP_Signal_19						
Number of Bursts in Trial: 18						
Burst	Pulses per Burst	Chrip (Hz)	Pulse Width (s)	Pulse 1 to 2 Spacing (s)	Pulse 2 to 3 Spacing (s)	Start Location (s)
1	2	11M	89.9u	952.1u	-	164.2m
2	2	12M	60.1u	1.101m	-	597.2m
3	2	18M	88.6u	1.621m	-	157.8m
4	2	15M	70.3u	1.101m	-	123.9m
5	1	9M	62.4u	-	-	527.6m
6	2	7M	62.0u	1.461m	-	563.3m
7	2	14M	91.8u	1.872m	-	134.8m
8	3	7M	94.7u	1.476m	1.570m	359.4m
9	3	7M	67.8u	1.913m	1.163m	553.5m
10	2	7M	58.1u	1.934m	-	189.3m
11	1	18M	86.2u	-	-	389.0m
12	2	13M	57.8u	988.2u	-	616.5m
13	1	19M	85.6u	-	-	229.1m
14	2	18M	79.3u	1.656m	-	319.5m
15	1	14M	66.5u	-	-	419.8m
16	3	17M	67.6u	1.854m	1.103m	488.8m
17	3	16M	72.2u	1.007m	1.589m	293.4m
18	3	17M	54.1u	1.398m	997.9u	338.1m

Long Pulse Radar Test Signal						
Test Signal Name: LP_Signal_20						
Number of Bursts in Trial: 17						
Burst	Pulses per Burst	Chrip (Hz)	Pulse Width (s)	Pulse 1 to 2 Spacing (s)	Pulse 2 to 3 Spacing (s)	Start Location (s)
1	2	18M	57.8u	1.348m	-	347.9m
2	2	5M	92.6u	1.007m	-	361.5m
3	1	12M	50.0u	-	-	148.3m
4	1	6M	59.6u	-	-	648.6m
5	2	11M	66.9u	1.700m	-	466.3m

6	2	10M	84.3u	1.715m	-	689.6m
7	2	14M	88.9u	1.080m	-	593.7m
8	2	13M	56.9u	1.343m	-	312.9m
9	2	18M	52.4u	1.103m	-	329.9m
10	2	20M	79.1u	1.789m	-	28.62m
11	1	18M	87.0u	-	-	205.1m
12	1	12M	78.8u	-	-	491.8m
13	3	12M	53.4u	1.690m	1.553m	155.3m
14	2	12M	56.9u	1.238m	-	451.4m
15	2	13M	81.0u	1.264m	-	146.1m
16	1	7M	61.3u	-	-	533.8m
17	1	16M	72.1u	-	-	519.9m

Long Pulse Radar Test Signal						
Test Signal Name: LP_Signal_21						
Number of Bursts in Trial: 10						
Burst	Pulses per Burst	Chrip (Hz)	Pulse Width (s)	Pulse 1 to 2 Spacing (s)	Pulse 2 to 3 Spacing (s)	Start Location (s)
1	1	13M	85.2u	-	-	932.9m
2	3	19M	78.5u	1.277m	1.808m	26.40m
3	2	6M	85.3u	928.7u	-	69.95m
4	3	18M	69.6u	1.726m	1.828m	338.9m
5	2	16M	87.5u	1.046m	-	871.4m
6	3	20M	92.5u	1.644m	1.680m	796.6m
7	2	8M	73.4u	1.619m	-	40.91m
8	2	5M	95.8u	1.204m	-	499.9m
9	2	17M	73.6u	1.056m	-	893.6m
10	3	10M	63.6u	1.211m	1.510m	361.8m

Long Pulse Radar Test Signal						
Test Signal Name: LP_Signal_22						
Number of Bursts in Trial: 10						
Burst	Pulses per Burst	Chrip (Hz)	Pulse Width (s)	Pulse 1 to 2 Spacing (s)	Pulse 2 to 3 Spacing (s)	Start Location (s)
1	2	20M	93.4u	1.624m	-	491.1m

2	2	13M	59.6u	1.070m	-	87.34m
3	2	14M	92.6u	1.847m	-	682.3m
4	1	20M	62.6u	-	-	234.9m
5	2	16M	69.6u	1.846m	-	262.3m
6	3	20M	84.8u	1.817m	1.228m	1.009
7	3	17M	79.0u	990.0u	1.506m	1.125
8	3	9M	54.3u	1.825m	1.661m	86.73m
9	1	15M	64.5u	-	-	720.1m
10	1	12M	76.6u	-	-	491.0m

Long Pulse Radar Test Signal						
Test Signal Name: LP_Signal_23						
Number of Bursts in Trial: 11						
Burst	Pulses per Burst	Chrip (Hz)	Pulse Width (s)	Pulse 1 to 2 Spacing (s)	Pulse 2 to 3 Spacing (s)	Start Location (s)
1	3	6M	79.1u	1.190m	1.551m	97.10m
2	2	7M	98.8u	1.656m	-	157.7m
3	2	17M	70.5u	1.391m	-	1.050
4	3	16M	90.9u	1.795m	1.519m	820.0m
5	2	14M	94.4u	1.667m	-	543.1m
6	2	7M	96.5u	1.138m	-	332.3m
7	2	19M	51.4u	1.873m	-	139.2m
8	2	17M	72.5u	1.185m	-	44.68m
9	1	14M	87.6u	-	-	888.5m
10	3	20M	78.4u	1.577m	1.873m	735.5m
11	2	16M	69.8u	1.813m	-	311.4m

Long Pulse Radar Test Signal						
Test Signal Name: LP_Signal_24						
Number of Bursts in Trial: 10						
Burst	Pulses per Burst	Chrip (Hz)	Pulse Width (s)	Pulse 1 to 2 Spacing (s)	Pulse 2 to 3 Spacing (s)	Start Location (s)
1	3	8M	78.7u	1.046m	948.3u	608.2m
2	2	14M	57.1u	1.899m	-	812.0m
3	1	18M	55.5u	-	-	248.1m

4	1	5M	51.9u	-	-	228.5m
5	2	9M	86.2u	1.624m	-	853.9m
6	2	11M	72.1u	1.041m	-	514.1m
7	1	6M	71.0u	-	-	189.6m
8	1	8M	81.6u	-	-	453.3m
9	2	19M	83.6u	1.334m	-	857.2m
10	2	15M	79.0u	1.859m	-	999.2m

Long Pulse Radar Test Signal						
Test Signal Name: LP_Signal_25						
Number of Bursts in Trial: 12						
Burst	Pulses per Burst	Chrip (Hz)	Pulse Width (s)	Pulse 1 to 2 Spacing (s)	Pulse 2 to 3 Spacing (s)	Start Location (s)
1	2	7M	82.1u	1.025m	-	526.8m
2	2	7M	55.4u	1.354m	-	809.5m
3	2	6M	73.4u	971.6u	-	250.0m
4	2	8M	55.5u	1.429m	-	641.1m
5	2	14M	92.6u	911.4u	-	606.6m
6	1	10M	64.3u	-	-	229.2m
7	3	12M	79.5u	1.496m	1.081m	570.3m
8	2	12M	94.7u	944.3u	-	174.9m
9	2	20M	53.6u	1.850m	-	324.0m
10	3	6M	92.7u	1.347m	1.407m	792.1m
11	2	11M	52.0u	1.335m	-	941.3m
12	2	16M	87.9u	1.494m	-	174.3m

Long Pulse Radar Test Signal						
Test Signal Name: LP_Signal_26						
Number of Bursts in Trial: 19						
Burst	Pulses per Burst	Chrip (Hz)	Pulse Width (s)	Pulse 1 to 2 Spacing (s)	Pulse 2 to 3 Spacing (s)	Start Location (s)
1	3	13M	75.5u	1.205m	1.014m	354.9m
2	2	6M	89.1u	1.643m	-	118.7m
3	3	18M	95.5u	956.5u	1.334m	253.2m
4	3	6M	84.0u	1.419m	956.0u	373.5m

5	1	15M	55.8u	-	-	257.9m
6	2	11M	63.6u	1.762m	-	50.20m
7	2	20M	64.2u	1.034m	-	32.33m
8	2	14M	88.1u	1.115m	-	465.5m
9	1	16M	62.9u	-	-	280.4m
10	3	16M	50.3u	1.296m	1.845m	460.1m
11	1	11M	85.1u	-	-	479.5m
12	3	7M	68.2u	1.277m	1.433m	377.3m
13	3	8M	96.5u	917.5u	1.584m	544.0m
14	3	12M	71.0u	1.814m	1.486m	9.113m
15	2	16M	51.6u	1.109m	-	569.8m
16	3	12M	52.3u	989.7u	1.699m	26.60m
17	2	9M	88.7u	1.816m	-	278.7m
18	3	17M	99.1u	1.795m	957.9u	625.2m
19	1	15M	91.5u	-	-	103.4m

Long Pulse Radar Test Signal						
Test Signal Name: LP_Signal_27						
Number of Bursts in Trial: 10						
Burst	Pulses per Burst	Chrip (Hz)	Pulse Width (s)	Pulse 1 to 2 Spacing (s)	Pulse 2 to 3 Spacing (s)	Start Location (s)
1	3	10M	81.2u	1.825m	1.586m	607.3m
2	2	8M	92.9u	918.1u	-	1.009
3	1	9M	75.1u	-	-	243.9m
4	2	13M	58.8u	1.554m	-	567.5m
5	3	12M	99.8u	1.355m	984.2u	530.6m
6	2	13M	88.7u	1.794m	-	402.4m
7	2	9M	71.3u	1.586m	-	623.1m
8	2	16M	62.0u	1.165m	-	869.4m
9	1	17M	88.5u	-	-	231.8m
10	3	10M	73.0u	1.901m	1.887m	904.7m

Long Pulse Radar Test Signal						
Test Signal Name: LP_Signal_28						
Number of Bursts in Trial: 17						
Burst	Pulses per Burst	Chrip (Hz)	Pulse Width (s)	Pulse 1 to 2 Spacing (s)	Pulse 2 to 3 Spacing (s)	Start Location (s)
1	1	10M	98.3u	-	-	95.77m
2	1	12M	53.2u	-	-	637.5m
3	1	11M	98.9u	-	-	416.2m
4	2	5M	52.6u	1.759m	-	391.4m
5	1	18M	71.1u	-	-	252.6m
6	2	17M	86.6u	1.261m	-	205.1m
7	1	6M	85.4u	-	-	105.6m
8	1	10M	80.2u	-	-	514.4m
9	2	15M	66.0u	1.398m	-	296.3m
10	2	5M	96.5u	1.342m	-	551.5m
11	3	5M	77.0u	1.431m	1.134m	265.3m
12	2	11M	68.8u	1.283m	-	610.8m
13	3	18M	80.4u	1.860m	1.671m	589.7m
14	1	15M	77.5u	-	-	627.0m
15	3	12M	94.2u	1.617m	1.847m	61.63m
16	2	12M	79.7u	1.730m	-	367.0m
17	2	17M	73.2u	1.843m	-	116.0m

Long Pulse Radar Test Signal						
Test Signal Name: LP_Signal_29						
Number of Bursts in Trial: 11						
Burst	Pulses per Burst	Chrip (Hz)	Pulse Width (s)	Pulse 1 to 2 Spacing (s)	Pulse 2 to 3 Spacing (s)	Start Location (s)
1	3	14M	90.4u	1.730m	1.159m	431.4m
2	1	11M	67.0u	-	-	878.3m
3	3	11M	74.7u	1.722m	1.229m	259.4m
4	2	17M	64.3u	1.103m	-	563.1m
5	3	19M	69.4u	1.399m	1.187m	190.0m
6	3	20M	74.3u	1.517m	1.637m	437.2m

7	2	12M	77.4u	1.001m	-	246.5m
8	1	14M	68.7u	-	-	331.5m
9	1	12M	50.5u	-	-	680.4m
10	2	11M	60.7u	1.470m	-	206.1m
11	1	14M	51.1u	-	-	437.4m

Long Pulse Radar Test Signal						
Test Signal Name: LP_Signal_30						
Number of Bursts in Trial: 11						
Burst	Pulses per Burst	Chrip (Hz)	Pulse Width (s)	Pulse 1 to 2 Spacing (s)	Pulse 2 to 3 Spacing (s)	Start Location (s)
1	2	8M	86.8u	1.424m	-	949.0m
2	2	14M	55.0u	1.151m	-	778.5m
3	2	8M	90.0u	1.684m	-	111.7m
4	1	13M	71.5u	-	-	18.00m
5	3	12M	65.9u	1.018m	1.571m	731.5m
6	1	12M	61.2u	-	-	29.55m
7	3	11M	98.2u	1.043m	1.626m	208.6m
8	2	6M	95.4u	1.418m	-	985.1m
9	2	19M	62.4u	1.386m	-	329.1m
10	3	13M	50.4u	1.845m	1.030m	665.9m
11	3	5M	65.7u	1.721m	1.927m	676.3m



Type 6 Radar Statistical Performances				
Trial #	Pulses per Burst	Pulse Width (s)	PRI (s)	Detection
1	9	1.0u	333.0u	Yes
2	9	1.0u	333.0u	Yes
3	9	1.0u	333.0u	Yes
4	9	1.0u	333.0u	Yes
5	9	1.0u	333.0u	Yes
6	9	1.0u	333.0u	Yes
7	9	1.0u	333.0u	Yes
8	9	1.0u	333.0u	Yes
9	9	1.0u	333.0u	Yes
10	9	1.0u	333.0u	Yes
11	9	1.0u	333.0u	Yes
12	9	1.0u	333.0u	Yes
13	9	1.0u	333.0u	Yes
14	9	1.0u	333.0u	Yes
15	9	1.0u	333.0u	Yes
16	9	1.0u	333.0u	Yes
17	9	1.0u	333.0u	Yes
18	9	1.0u	333.0u	Yes
19	9	1.0u	333.0u	Yes
20	9	1.0u	333.0u	Yes
21	9	1.0u	333.0u	Yes
22	9	1.0u	333.0u	Yes
23	9	1.0u	333.0u	Yes
24	9	1.0u	333.0u	Yes
25	9	1.0u	333.0u	Yes
26	9	1.0u	333.0u	Yes
27	9	1.0u	333.0u	Yes
28	9	1.0u	333.0u	Yes
29	9	1.0u	333.0u	Yes
30	9	1.0u	333.0u	Yes
			Detection Rate: 100.0 %	

Type 6 Radar Statistical Performances		
Trial #	Hopping Frequency Sequence Name	Detection
1	HOP_FREQ_SEQ_01	Yes
2	HOP_FREQ_SEQ_02	Yes
3	HOP_FREQ_SEQ_03	Yes
4	HOP_FREQ_SEQ_04	Yes
5	HOP_FREQ_SEQ_05	Yes
6	HOP_FREQ_SEQ_06	Yes
7	HOP_FREQ_SEQ_07	Yes
8	HOP_FREQ_SEQ_08	Yes
9	HOP_FREQ_SEQ_09	Yes
10	HOP_FREQ_SEQ_10	Yes
11	HOP_FREQ_SEQ_11	Yes
12	HOP_FREQ_SEQ_12	Yes
13	HOP_FREQ_SEQ_13	Yes
14	HOP_FREQ_SEQ_14	Yes
15	HOP_FREQ_SEQ_15	Yes
16	HOP_FREQ_SEQ_16	Yes
17	HOP_FREQ_SEQ_17	Yes
18	HOP_FREQ_SEQ_18	Yes
19	HOP_FREQ_SEQ_19	Yes
20	HOP_FREQ_SEQ_20	Yes
21	HOP_FREQ_SEQ_21	Yes
22	HOP_FREQ_SEQ_22	Yes
23	HOP_FREQ_SEQ_23	Yes
24	HOP_FREQ_SEQ_24	Yes
25	HOP_FREQ_SEQ_25	Yes
26	HOP_FREQ_SEQ_26	Yes
27	HOP_FREQ_SEQ_27	Yes
28	HOP_FREQ_SEQ_28	Yes
29	HOP_FREQ_SEQ_29	Yes
30	HOP_FREQ_SEQ_30	Yes
Detection Rate: 100.0 %		

Hopping Frequency Sequence Name: HOP_FREQ_SEQ_01							
SEQ#	Frequency (Hz)	SEQ#	Frequency (Hz)	SEQ#	Frequency (Hz)	SEQ#	Frequency (Hz)
1	5.420G	2	5.596G	3	5.663G	4	5.361G
5	5.479G	6	5.434G	7	5.621G	8	5.582G
9	5.398G	10	5.592G	11	5.618G	12	5.367G
13	5.515G	14	5.583G	15	5.551G	16	5.708G
17	5.393G	18	5.576G	19	5.403G	20	5.546G
21	5.432G	22	5.500G	23	5.584G	24	5.586G
25	5.542G	26	5.724G	27	5.458G	28	5.498G
29	5.686G	30	5.296G	31	5.378G	32	5.720G
33	5.537G	34	5.285G	35	5.286G	36	5.721G
37	5.412G	38	5.478G	39	5.391G	40	5.379G
41	5.629G	42	5.346G	43	5.275G	44	5.699G
45	5.464G	46	5.702G	47	5.632G	48	5.410G
49	5.317G	50	5.297G	51	5.495G	52	5.616G
53	5.474G	54	5.473G	55	5.422G	56	5.664G
57	5.411G	58	5.588G	59	5.408G	60	5.382G
61	5.417G	62	5.496G	63	5.696G	64	5.704G
65	5.639G	66	5.282G	67	5.562G	68	5.471G
69	5.662G	70	5.349G	71	5.570G	72	5.438G
73	5.627G	74	5.306G	75	5.587G	76	5.320G
77	5.547G	78	5.336G	79	5.314G	80	5.308G
81	5.540G	82	5.459G	83	5.435G	84	5.597G
85	5.685G	86	5.409G	87	5.513G	88	5.332G
89	5.625G	90	5.461G	91	5.620G	92	5.352G
93	5.487G	94	5.481G	95	5.612G	96	5.539G
97	5.491G	98	5.489G	99	5.407G	100	5.260G

Hopping Frequency Sequence Name: HOP_FREQ_SEQ_02							
SEQ#	Frequency (Hz)	SEQ#	Frequency (Hz)	SEQ#	Frequency (Hz)	SEQ#	Frequency (Hz)
1	5.300G	2	5.382G	3	5.289G	4	5.656G
5	5.461G	6	5.431G	7	5.366G	8	5.587G
9	5.390G	10	5.528G	11	5.512G	12	5.633G
13	5.264G	14	5.499G	15	5.398G	16	5.479G

17	5.582G	18	5.644G	19	5.482G	20	5.523G
21	5.364G	22	5.705G	23	5.283G	24	5.642G
25	5.513G	26	5.577G	27	5.615G	28	5.262G
29	5.317G	30	5.353G	31	5.414G	32	5.368G
33	5.610G	34	5.326G	35	5.282G	36	5.585G
37	5.428G	38	5.561G	39	5.329G	40	5.386G
41	5.692G	42	5.601G	43	5.302G	44	5.438G
45	5.323G	46	5.555G	47	5.526G	48	5.259G
49	5.597G	50	5.415G	51	5.556G	52	5.702G
53	5.399G	54	5.314G	55	5.655G	56	5.389G
57	5.630G	58	5.292G	59	5.459G	60	5.331G
61	5.628G	62	5.511G	63	5.580G	64	5.532G
65	5.621G	66	5.379G	67	5.544G	68	5.654G
69	5.273G	70	5.666G	71	5.454G	72	5.467G
73	5.707G	74	5.502G	75	5.546G	76	5.396G
77	5.496G	78	5.586G	79	5.284G	80	5.365G
81	5.419G	82	5.362G	83	5.638G	84	5.629G
85	5.278G	86	5.383G	87	5.494G	88	5.492G
89	5.448G	90	5.695G	91	5.722G	92	5.258G
93	5.509G	94	5.369G	95	5.531G	96	5.617G
97	5.391G	98	5.394G	99	5.708G	100	5.451G

Hopping Frequency Sequence Name: HOP_FREQ_SEQ_03							
SEQ#	Frequency (Hz)	SEQ#	Frequency (Hz)	SEQ#	Frequency (Hz)	SEQ#	Frequency (Hz)
1	5.638G	2	5.677G	3	5.585G	4	5.337G
5	5.583G	6	5.303G	7	5.605G	8	5.330G
9	5.645G	10	5.390G	11	5.705G	12	5.506G
13	5.608G	14	5.423G	15	5.715G	16	5.430G
17	5.457G	18	5.463G	19	5.622G	20	5.468G
21	5.521G	22	5.637G	23	5.599G	24	5.380G
25	5.441G	26	5.529G	27	5.592G	28	5.501G
29	5.541G	30	5.407G	31	5.634G	32	5.438G
33	5.523G	34	5.650G	35	5.651G	36	5.368G
37	5.292G	38	5.505G	39	5.253G	40	5.447G
41	5.593G	42	5.616G	43	5.576G	44	5.694G
45	5.567G	46	5.472G	47	5.283G	48	5.382G

49	5.398G	50	5.680G	51	5.504G	52	5.481G
53	5.687G	54	5.604G	55	5.271G	56	5.335G
57	5.317G	58	5.460G	59	5.693G	60	5.526G
61	5.686G	62	5.313G	63	5.385G	64	5.450G
65	5.290G	66	5.389G	67	5.478G	68	5.607G
69	5.565G	70	5.319G	71	5.374G	72	5.329G
73	5.392G	74	5.624G	75	5.556G	76	5.720G
77	5.373G	78	5.327G	79	5.298G	80	5.630G
81	5.307G	82	5.269G	83	5.412G	84	5.252G
85	5.387G	86	5.365G	87	5.612G	88	5.377G
89	5.257G	90	5.698G	91	5.658G	92	5.277G
93	5.326G	94	5.710G	95	5.305G	96	5.628G
97	5.288G	98	5.274G	99	5.590G	100	5.724G

Hopping Frequency Sequence Name: HOP_FREQ_SEQ_04							
SEQ#	Frequency (Hz)	SEQ#	Frequency (Hz)	SEQ#	Frequency (Hz)	SEQ#	Frequency (Hz)
1	5.518G	2	5.378G	3	5.332G	4	5.362G
5	5.400G	6	5.706G	7	5.705G	8	5.591G
9	5.287G	10	5.429G	11	5.257G	12	5.434G
13	5.563G	14	5.530G	15	5.528G	16	5.507G
17	5.554G	18	5.704G	19	5.419G	20	5.290G
21	5.542G	22	5.604G	23	5.368G	24	5.321G
25	5.406G	26	5.670G	27	5.603G	28	5.495G
29	5.423G	30	5.657G	31	5.722G	32	5.526G
33	5.685G	34	5.695G	35	5.464G	36	5.308G
37	5.677G	38	5.250G	39	5.573G	40	5.654G
41	5.313G	42	5.317G	43	5.687G	44	5.460G
45	5.384G	46	5.671G	47	5.413G	48	5.644G
49	5.510G	50	5.613G	51	5.509G	52	5.618G
53	5.480G	54	5.447G	55	5.666G	56	5.590G
57	5.367G	58	5.692G	59	5.676G	60	5.319G
61	5.382G	62	5.579G	63	5.371G	64	5.267G
65	5.458G	66	5.409G	67	5.354G	68	5.346G
69	5.566G	70	5.699G	71	5.642G	72	5.609G
73	5.571G	74	5.678G	75	5.586G	76	5.709G
77	5.669G	78	5.723G	79	5.393G	80	5.401G

81	5.682G	82	5.268G	83	5.585G	84	5.584G
85	5.649G	86	5.314G	87	5.614G	88	5.369G
89	5.576G	90	5.370G	91	5.479G	92	5.570G
93	5.453G	94	5.273G	95	5.375G	96	5.546G
97	5.253G	98	5.372G	99	5.560G	100	5.390G

Hopping Frequency Sequence Name: HOP_FREQ_SEQ_05							
SEQ#	Frequency (Hz)	SEQ#	Frequency (Hz)	SEQ#	Frequency (Hz)	SEQ#	Frequency (Hz)
1	5.325G	2	5.261G	3	5.344G	4	5.338G
5	5.686G	6	5.416G	7	5.502G	8	5.327G
9	5.573G	10	5.481G	11	5.493G	12	5.443G
13	5.683G	14	5.342G	15	5.305G	16	5.718G
17	5.639G	18	5.427G	19	5.714G	20	5.380G
21	5.511G	22	5.548G	23	5.324G	24	5.685G
25	5.638G	26	5.445G	27	5.591G	28	5.299G
29	5.627G	30	5.433G	31	5.589G	32	5.373G
33	5.291G	34	5.622G	35	5.554G	36	5.477G
37	5.303G	38	5.594G	39	5.713G	40	5.566G
41	5.408G	42	5.539G	43	5.560G	44	5.323G
45	5.471G	46	5.500G	47	5.644G	48	5.602G
49	5.332G	50	5.459G	51	5.395G	52	5.636G
53	5.366G	54	5.610G	55	5.372G	56	5.360G
57	5.447G	58	5.405G	59	5.620G	60	5.695G
61	5.648G	62	5.565G	63	5.312G	64	5.435G
65	5.680G	66	5.550G	67	5.403G	68	5.393G
69	5.277G	70	5.646G	71	5.559G	72	5.704G
73	5.590G	74	5.516G	75	5.578G	76	5.429G
77	5.418G	78	5.489G	79	5.684G	80	5.371G
81	5.421G	82	5.318G	83	5.466G	84	5.480G
85	5.598G	86	5.425G	87	5.253G	88	5.552G
89	5.286G	90	5.475G	91	5.410G	92	5.257G
93	5.269G	94	5.679G	95	5.315G	96	5.484G
97	5.483G	98	5.295G	99	5.355G	100	5.625G

Hopping Frequency Sequence Name: HOP_FREQ_SEQ_06							
SEQ#	Frequency (Hz)	SEQ#	Frequency (Hz)	SEQ#	Frequency (Hz)	SEQ#	Frequency (Hz)
1	5.588G	2	5.340G	3	5.597G	4	5.673G
5	5.263G	6	5.292G	7	5.301G	8	5.466G
9	5.273G	10	5.389G	11	5.671G	12	5.658G
13	5.577G	14	5.668G	15	5.267G	16	5.702G
17	5.682G	18	5.309G	19	5.721G	20	5.451G
21	5.462G	22	5.688G	23	5.297G	24	5.550G
25	5.482G	26	5.691G	27	5.441G	28	5.683G
29	5.311G	30	5.655G	31	5.522G	32	5.703G
33	5.520G	34	5.499G	35	5.532G	36	5.628G
37	5.638G	38	5.277G	39	5.716G	40	5.672G
41	5.418G	42	5.585G	43	5.705G	44	5.645G
45	5.409G	46	5.687G	47	5.307G	48	5.278G
49	5.558G	50	5.488G	51	5.650G	52	5.557G
53	5.692G	54	5.610G	55	5.464G	56	5.574G
57	5.595G	58	5.356G	59	5.271G	60	5.458G
61	5.452G	62	5.546G	63	5.542G	64	5.257G
65	5.260G	66	5.357G	67	5.533G	68	5.358G
69	5.433G	70	5.541G	71	5.707G	72	5.344G
73	5.320G	74	5.718G	75	5.584G	76	5.644G
77	5.283G	78	5.489G	79	5.639G	80	5.544G
81	5.363G	82	5.521G	83	5.279G	84	5.579G
85	5.252G	86	5.622G	87	5.393G	88	5.253G
89	5.366G	90	5.497G	91	5.456G	92	5.353G
93	5.398G	94	5.681G	95	5.373G	96	5.319G
97	5.473G	98	5.421G	99	5.652G	100	5.438G

Hopping Frequency Sequence Name: HOP_FREQ_SEQ_07							
SEQ#	Frequency (Hz)	SEQ#	Frequency (Hz)	SEQ#	Frequency (Hz)	SEQ#	Frequency (Hz)
1	5.458G	2	5.419G	3	5.485G	4	5.343G
5	5.412G	6	5.361G	7	5.478G	8	5.251G
9	5.268G	10	5.601G	11	5.433G	12	5.504G
13	5.586G	14	5.655G	15	5.656G	16	5.295G

17	5.673G	18	5.395G	19	5.443G	20	5.356G
21	5.720G	22	5.525G	23	5.367G	24	5.288G
25	5.393G	26	5.522G	27	5.391G	28	5.313G
29	5.261G	30	5.676G	31	5.536G	32	5.450G
33	5.332G	34	5.444G	35	5.631G	36	5.585G
37	5.371G	38	5.664G	39	5.680G	40	5.661G
41	5.611G	42	5.452G	43	5.491G	44	5.617G
45	5.351G	46	5.323G	47	5.286G	48	5.662G
49	5.691G	50	5.451G	51	5.545G	52	5.670G
53	5.693G	54	5.296G	55	5.513G	56	5.665G
57	5.481G	58	5.505G	59	5.657G	60	5.456G
61	5.409G	62	5.314G	63	5.320G	64	5.406G
65	5.418G	66	5.317G	67	5.319G	68	5.486G
69	5.369G	70	5.370G	71	5.595G	72	5.518G
73	5.714G	74	5.604G	75	5.447G	76	5.279G
77	5.423G	78	5.681G	79	5.280G	80	5.547G
81	5.539G	82	5.508G	83	5.571G	84	5.271G
85	5.612G	86	5.350G	87	5.588G	88	5.615G
89	5.629G	90	5.465G	91	5.594G	92	5.668G
93	5.321G	94	5.583G	95	5.353G	96	5.472G
97	5.671G	98	5.502G	99	5.546G	100	5.386G

Hopping Frequency Sequence Name: HOP_FREQ_SEQ_08							
SEQ#	Frequency (Hz)	SEQ#	Frequency (Hz)	SEQ#	Frequency (Hz)	SEQ#	Frequency (Hz)
1	5.281G	2	5.478G	3	5.644G	4	5.472G
5	5.576G	6	5.643G	7	5.286G	8	5.585G
9	5.636G	10	5.405G	11	5.634G	12	5.387G
13	5.483G	14	5.640G	15	5.629G	16	5.492G
17	5.344G	18	5.256G	19	5.700G	20	5.523G
21	5.444G	22	5.541G	23	5.624G	24	5.467G
25	5.639G	26	5.462G	27	5.494G	28	5.399G
29	5.408G	30	5.530G	31	5.515G	32	5.619G
33	5.696G	34	5.282G	35	5.607G	36	5.673G
37	5.397G	38	5.500G	39	5.568G	40	5.323G
41	5.542G	42	5.606G	43	5.427G	44	5.338G
45	5.507G	46	5.452G	47	5.504G	48	5.562G



49	5.633G	50	5.390G	51	5.703G	52	5.297G
53	5.457G	54	5.259G	55	5.653G	56	5.435G
57	5.406G	58	5.671G	59	5.412G	60	5.712G
61	5.498G	62	5.368G	63	5.436G	64	5.375G
65	5.538G	66	5.697G	67	5.471G	68	5.661G
69	5.574G	70	5.346G	71	5.637G	72	5.570G
73	5.333G	74	5.590G	75	5.680G	76	5.409G
77	5.676G	78	5.441G	79	5.695G	80	5.514G
81	5.324G	82	5.487G	83	5.681G	84	5.312G
85	5.391G	86	5.694G	87	5.370G	88	5.279G
89	5.550G	90	5.367G	91	5.687G	92	5.672G
93	5.304G	94	5.501G	95	5.557G	96	5.611G
97	5.342G	98	5.432G	99	5.266G	100	5.328G

Hopping Frequency Sequence Name: HOP_FREQ_SEQ_09							
SEQ#	Frequency (Hz)	SEQ#	Frequency (Hz)	SEQ#	Frequency (Hz)	SEQ#	Frequency (Hz)
1	5.720G	2	5.269G	3	5.324G	4	5.626G
5	5.260G	6	5.278G	7	5.536G	8	5.333G
9	5.424G	10	5.321G	11	5.647G	12	5.552G
13	5.325G	14	5.557G	15	5.345G	16	5.453G
17	5.594G	18	5.631G	19	5.506G	20	5.526G
21	5.482G	22	5.677G	23	5.298G	24	5.500G
25	5.464G	26	5.313G	27	5.662G	28	5.444G
29	5.584G	30	5.458G	31	5.597G	32	5.504G
33	5.620G	34	5.282G	35	5.581G	36	5.330G
37	5.296G	38	5.331G	39	5.286G	40	5.489G
41	5.469G	42	5.656G	43	5.525G	44	5.713G
45	5.407G	46	5.377G	47	5.346G	48	5.460G
49	5.468G	50	5.410G	51	5.253G	52	5.561G
53	5.580G	54	5.666G	55	5.533G	56	5.579G
57	5.672G	58	5.256G	59	5.582G	60	5.569G
61	5.388G	62	5.696G	63	5.455G	64	5.648G
65	5.527G	66	5.430G	67	5.630G	68	5.284G
69	5.379G	70	5.574G	71	5.537G	72	5.295G
73	5.558G	74	5.264G	75	5.384G	76	5.683G
77	5.717G	78	5.414G	79	5.405G	80	5.586G

81	5.258G	82	5.316G	83	5.715G	84	5.290G
85	5.589G	86	5.591G	87	5.291G	88	5.348G
89	5.390G	90	5.673G	91	5.391G	92	5.724G
93	5.370G	94	5.327G	95	5.350G	96	5.302G
97	5.560G	98	5.358G	99	5.603G	100	5.457G

Hopping Frequency Sequence Name: HOP_FREQ_SEQ_10							
SEQ#	Frequency (Hz)	SEQ#	Frequency (Hz)	SEQ#	Frequency (Hz)	SEQ#	Frequency (Hz)
1	5.375G	2	5.540G	3	5.475G	4	5.406G
5	5.693G	6	5.410G	7	5.625G	8	5.701G
9	5.617G	10	5.488G	11	5.472G	12	5.284G
13	5.273G	14	5.430G	15	5.604G	16	5.595G
17	5.351G	18	5.412G	19	5.311G	20	5.570G
21	5.630G	22	5.694G	23	5.597G	24	5.497G
25	5.466G	26	5.666G	27	5.445G	28	5.656G
29	5.521G	30	5.687G	31	5.618G	32	5.699G
33	5.382G	34	5.419G	35	5.579G	36	5.700G
37	5.674G	38	5.678G	39	5.320G	40	5.471G
41	5.305G	42	5.609G	43	5.450G	44	5.679G
45	5.698G	46	5.428G	47	5.451G	48	5.457G
49	5.429G	50	5.255G	51	5.349G	52	5.668G
53	5.632G	54	5.329G	55	5.504G	56	5.313G
57	5.621G	58	5.643G	59	5.366G	60	5.487G
61	5.315G	62	5.628G	63	5.438G	64	5.567G
65	5.395G	66	5.283G	67	5.257G	68	5.562G
69	5.707G	70	5.673G	71	5.659G	72	5.473G
73	5.663G	74	5.682G	75	5.390G	76	5.569G
77	5.717G	78	5.272G	79	5.360G	80	5.312G
81	5.444G	82	5.624G	83	5.675G	84	5.510G
85	5.684G	86	5.414G	87	5.452G	88	5.672G
89	5.664G	90	5.270G	91	5.526G	92	5.427G
93	5.281G	94	5.517G	95	5.515G	96	5.383G
97	5.346G	98	5.587G	99	5.347G	100	5.300G

Hopping Frequency Sequence Name: HOP_FREQ_SEQ_11							
SEQ#	Frequency (Hz)	SEQ#	Frequency (Hz)	SEQ#	Frequency (Hz)	SEQ#	Frequency (Hz)
1	5.533G	2	5.522G	3	5.624G	4	5.305G
5	5.361G	6	5.594G	7	5.464G	8	5.589G
9	5.558G	10	5.652G	11	5.722G	12	5.597G
13	5.336G	14	5.584G	15	5.445G	16	5.469G
17	5.282G	18	5.665G	19	5.556G	20	5.546G
21	5.547G	22	5.704G	23	5.252G	24	5.585G
25	5.598G	26	5.354G	27	5.626G	28	5.708G
29	5.529G	30	5.312G	31	5.562G	32	5.525G
33	5.472G	34	5.298G	35	5.416G	36	5.517G
37	5.346G	38	5.313G	39	5.693G	40	5.461G
41	5.602G	42	5.507G	43	5.250G	44	5.691G
45	5.527G	46	5.413G	47	5.648G	48	5.623G
49	5.552G	50	5.324G	51	5.660G	52	5.587G
53	5.670G	54	5.596G	55	5.615G	56	5.343G
57	5.293G	58	5.283G	59	5.645G	60	5.494G
61	5.698G	62	5.294G	63	5.456G	64	5.318G
65	5.449G	66	5.502G	67	5.255G	68	5.483G
69	5.301G	70	5.701G	71	5.663G	72	5.308G
73	5.658G	74	5.650G	75	5.256G	76	5.356G
77	5.340G	78	5.599G	79	5.579G	80	5.307G
81	5.339G	82	5.418G	83	5.303G	84	5.578G
85	5.352G	86	5.628G	87	5.721G	88	5.635G
89	5.367G	90	5.639G	91	5.388G	92	5.377G
93	5.380G	94	5.386G	95	5.678G	96	5.489G
97	5.521G	98	5.627G	99	5.568G	100	5.470G

Hopping Frequency Sequence Name: HOP_FREQ_SEQ_12							
SEQ#	Frequency (Hz)	SEQ#	Frequency (Hz)	SEQ#	Frequency (Hz)	SEQ#	Frequency (Hz)
1	5.274G	2	5.426G	3	5.553G	4	5.644G
5	5.668G	6	5.452G	7	5.334G	8	5.515G
9	5.724G	10	5.531G	11	5.302G	12	5.514G
13	5.543G	14	5.308G	15	5.519G	16	5.578G

17	5.263G	18	5.457G	19	5.267G	20	5.676G
21	5.581G	22	5.570G	23	5.464G	24	5.541G
25	5.689G	26	5.585G	27	5.605G	28	5.522G
29	5.634G	30	5.521G	31	5.438G	32	5.497G
33	5.503G	34	5.458G	35	5.488G	36	5.352G
37	5.599G	38	5.617G	39	5.466G	40	5.413G
41	5.646G	42	5.704G	43	5.381G	44	5.424G
45	5.642G	46	5.692G	47	5.595G	48	5.657G
49	5.315G	50	5.710G	51	5.341G	52	5.388G
53	5.714G	54	5.257G	55	5.306G	56	5.366G
57	5.318G	58	5.544G	59	5.316G	60	5.303G
61	5.663G	62	5.502G	63	5.468G	64	5.293G
65	5.565G	66	5.691G	67	5.384G	68	5.614G
69	5.276G	70	5.547G	71	5.722G	72	5.620G
73	5.255G	74	5.395G	75	5.678G	76	5.566G
77	5.596G	78	5.590G	79	5.336G	80	5.451G
81	5.511G	82	5.559G	83	5.480G	84	5.265G
85	5.610G	86	5.443G	87	5.484G	88	5.518G
89	5.279G	90	5.335G	91	5.358G	92	5.718G
93	5.435G	94	5.397G	95	5.477G	96	5.712G
97	5.527G	98	5.412G	99	5.619G	100	5.323G

Hopping Frequency Sequence Name: HOP_FREQ_SEQ_13							
SEQ#	Frequency (Hz)	SEQ#	Frequency (Hz)	SEQ#	Frequency (Hz)	SEQ#	Frequency (Hz)
1	5.511G	2	5.469G	3	5.478G	4	5.685G
5	5.693G	6	5.268G	7	5.499G	8	5.336G
9	5.608G	10	5.379G	11	5.675G	12	5.370G
13	5.356G	14	5.567G	15	5.333G	16	5.423G
17	5.432G	18	5.603G	19	5.324G	20	5.332G
21	5.467G	22	5.684G	23	5.479G	24	5.376G
25	5.485G	26	5.438G	27	5.407G	28	5.391G
29	5.430G	30	5.575G	31	5.254G	32	5.270G
33	5.371G	34	5.396G	35	5.372G	36	5.264G
37	5.563G	38	5.507G	39	5.715G	40	5.723G
41	5.386G	42	5.669G	43	5.256G	44	5.441G
45	5.635G	46	5.363G	47	5.578G	48	5.636G

49	5.296G	50	5.540G	51	5.300G	52	5.475G
53	5.428G	54	5.329G	55	5.445G	56	5.436G
57	5.690G	58	5.502G	59	5.286G	60	5.518G
61	5.546G	62	5.533G	63	5.606G	64	5.330G
65	5.665G	66	5.698G	67	5.553G	68	5.506G
69	5.382G	70	5.354G	71	5.266G	72	5.484G
73	5.721G	74	5.539G	75	5.568G	76	5.392G
77	5.672G	78	5.365G	79	5.614G	80	5.677G
81	5.713G	82	5.339G	83	5.486G	84	5.626G
85	5.400G	86	5.252G	87	5.548G	88	5.686G
89	5.334G	90	5.722G	91	5.405G	92	5.275G
93	5.343G	94	5.389G	95	5.349G	96	5.630G
97	5.494G	98	5.619G	99	5.309G	100	5.644G

Hopping Frequency Sequence Name: HOP_FREQ_SEQ_14							
SEQ#	Frequency (Hz)	SEQ#	Frequency (Hz)	SEQ#	Frequency (Hz)	SEQ#	Frequency (Hz)
1	5.412G	2	5.632G	3	5.614G	4	5.478G
5	5.381G	6	5.649G	7	5.502G	8	5.506G
9	5.555G	10	5.382G	11	5.612G	12	5.522G
13	5.631G	14	5.618G	15	5.420G	16	5.300G
17	5.558G	18	5.496G	19	5.299G	20	5.504G
21	5.530G	22	5.574G	23	5.521G	24	5.613G
25	5.414G	26	5.438G	27	5.705G	28	5.373G
29	5.330G	30	5.435G	31	5.715G	32	5.407G
33	5.703G	34	5.721G	35	5.560G	36	5.636G
37	5.526G	38	5.570G	39	5.253G	40	5.281G
41	5.437G	42	5.460G	43	5.366G	44	5.620G
45	5.476G	46	5.724G	47	5.699G	48	5.627G
49	5.588G	50	5.590G	51	5.465G	52	5.410G
53	5.284G	54	5.611G	55	5.320G	56	5.583G
57	5.276G	58	5.518G	59	5.577G	60	5.384G
61	5.461G	62	5.679G	63	5.665G	64	5.309G
65	5.372G	66	5.452G	67	5.624G	68	5.258G
69	5.711G	70	5.510G	71	5.313G	72	5.615G
73	5.527G	74	5.687G	75	5.523G	76	5.556G
77	5.520G	78	5.616G	79	5.497G	80	5.539G

81	5.404G	82	5.273G	83	5.671G	84	5.283G
85	5.716G	86	5.706G	87	5.589G	88	5.342G
89	5.505G	90	5.387G	91	5.328G	92	5.696G
93	5.255G	94	5.582G	95	5.305G	96	5.509G
97	5.418G	98	5.353G	99	5.673G	100	5.360G

Hopping Frequency Sequence Name: HOP_FREQ_SEQ_15							
SEQ#	Frequency (Hz)	SEQ#	Frequency (Hz)	SEQ#	Frequency (Hz)	SEQ#	Frequency (Hz)
1	5.469G	2	5.543G	3	5.676G	4	5.657G
5	5.528G	6	5.457G	7	5.608G	8	5.442G
9	5.668G	10	5.259G	11	5.361G	12	5.434G
13	5.269G	14	5.338G	15	5.362G	16	5.448G
17	5.655G	18	5.395G	19	5.530G	20	5.380G
21	5.402G	22	5.320G	23	5.595G	24	5.412G
25	5.498G	26	5.368G	27	5.573G	28	5.302G
29	5.628G	30	5.315G	31	5.314G	32	5.252G
33	5.398G	34	5.454G	35	5.639G	36	5.295G
37	5.503G	38	5.364G	39	5.647G	40	5.541G
41	5.556G	42	5.577G	43	5.658G	44	5.370G
45	5.456G	46	5.328G	47	5.579G	48	5.468G
49	5.617G	50	5.382G	51	5.724G	52	5.444G
53	5.713G	54	5.691G	55	5.694G	56	5.274G
57	5.619G	58	5.264G	59	5.342G	60	5.431G
61	5.621G	62	5.493G	63	5.420G	64	5.344G
65	5.574G	66	5.500G	67	5.677G	68	5.353G
69	5.430G	70	5.472G	71	5.388G	72	5.708G
73	5.329G	74	5.537G	75	5.695G	76	5.536G
77	5.372G	78	5.718G	79	5.311G	80	5.559G
81	5.345G	82	5.254G	83	5.490G	84	5.646G
85	5.614G	86	5.585G	87	5.701G	88	5.645G
89	5.385G	90	5.333G	91	5.538G	92	5.330G
93	5.672G	94	5.482G	95	5.566G	96	5.680G
97	5.698G	98	5.637G	99	5.702G	100	5.433G

Hopping Frequency Sequence Name: HOP_FREQ_SEQ_16							
SEQ#	Frequency	SEQ#	Frequency	SEQ#	Frequency	SEQ#	Frequency

	(Hz)		(Hz)		(Hz)		(Hz)
1	5.618G	2	5.552G	3	5.279G	4	5.703G
5	5.486G	6	5.687G	7	5.574G	8	5.433G
9	5.384G	10	5.562G	11	5.355G	12	5.689G
13	5.554G	14	5.283G	15	5.341G	16	5.657G
17	5.577G	18	5.567G	19	5.451G	20	5.586G
21	5.671G	22	5.620G	23	5.367G	24	5.400G
25	5.637G	26	5.723G	27	5.615G	28	5.455G
29	5.638G	30	5.276G	31	5.610G	32	5.390G
33	5.583G	34	5.382G	35	5.354G	36	5.699G
37	5.271G	38	5.659G	39	5.410G	40	5.280G
41	5.658G	42	5.709G	43	5.712G	44	5.445G
45	5.458G	46	5.592G	47	5.489G	48	5.463G
49	5.448G	50	5.314G	51	5.628G	52	5.258G
53	5.459G	54	5.547G	55	5.612G	56	5.481G
57	5.684G	58	5.485G	59	5.640G	60	5.526G
61	5.654G	62	5.373G	63	5.315G	64	5.579G
65	5.518G	66	5.385G	67	5.533G	68	5.595G
69	5.405G	70	5.284G	71	5.289G	72	5.551G
73	5.523G	74	5.299G	75	5.642G	76	5.683G
77	5.473G	78	5.372G	79	5.346G	80	5.503G
81	5.356G	82	5.409G	83	5.462G	84	5.318G
85	5.262G	86	5.641G	87	5.469G	88	5.500G
89	5.655G	90	5.348G	91	5.573G	92	5.505G
93	5.427G	94	5.664G	95	5.402G	96	5.467G
97	5.604G	98	5.268G	99	5.334G	100	5.446G

Hopping Frequency Sequence Name: HOP_FREQ_SEQ_17							
SEQ#	Frequency (Hz)	SEQ#	Frequency (Hz)	SEQ#	Frequency (Hz)	SEQ#	Frequency (Hz)
1	5.531G	2	5.397G	3	5.715G	4	5.314G
5	5.701G	6	5.489G	7	5.325G	8	5.659G
9	5.405G	10	5.657G	11	5.607G	12	5.526G
13	5.491G	14	5.327G	15	5.673G	16	5.602G
17	5.567G	18	5.623G	19	5.597G	20	5.395G
21	5.672G	22	5.505G	23	5.311G	24	5.288G
25	5.506G	26	5.346G	27	5.516G	28	5.508G

29	5.420G	30	5.578G	31	5.424G	32	5.317G
33	5.523G	34	5.529G	35	5.645G	36	5.307G
37	5.658G	38	5.541G	39	5.298G	40	5.585G
41	5.547G	42	5.363G	43	5.478G	44	5.421G
45	5.580G	46	5.336G	47	5.601G	48	5.297G
49	5.515G	50	5.389G	51	5.519G	52	5.694G
53	5.651G	54	5.705G	55	5.404G	56	5.486G
57	5.611G	58	5.366G	59	5.349G	60	5.698G
61	5.370G	62	5.339G	63	5.656G	64	5.630G
65	5.438G	66	5.610G	67	5.689G	68	5.431G
69	5.338G	70	5.318G	71	5.697G	72	5.497G
73	5.355G	74	5.382G	75	5.590G	76	5.386G
77	5.269G	78	5.422G	79	5.444G	80	5.690G
81	5.539G	82	5.702G	83	5.321G	84	5.703G
85	5.572G	86	5.309G	87	5.400G	88	5.435G
89	5.584G	90	5.331G	91	5.259G	92	5.509G
93	5.596G	94	5.669G	95	5.631G	96	5.718G
97	5.482G	98	5.682G	99	5.300G	100	5.423G

Hopping Frequency Sequence Name: HOP_FREQ_SEQ_18							
SEQ#	Frequency (Hz)	SEQ#	Frequency (Hz)	SEQ#	Frequency (Hz)	SEQ#	Frequency (Hz)
1	5.631G	2	5.330G	3	5.575G	4	5.584G
5	5.583G	6	5.257G	7	5.524G	8	5.340G
9	5.569G	10	5.316G	11	5.402G	12	5.410G
13	5.598G	14	5.686G	15	5.435G	16	5.682G
17	5.581G	18	5.486G	19	5.702G	20	5.288G
21	5.366G	22	5.708G	23	5.664G	24	5.572G
25	5.346G	26	5.320G	27	5.490G	28	5.568G
29	5.258G	30	5.459G	31	5.404G	32	5.301G
33	5.561G	34	5.546G	35	5.616G	36	5.278G
37	5.705G	38	5.359G	39	5.434G	40	5.474G
41	5.674G	42	5.436G	43	5.353G	44	5.441G
45	5.334G	46	5.562G	47	5.722G	48	5.423G
49	5.327G	50	5.463G	51	5.329G	52	5.425G
53	5.419G	54	5.551G	55	5.558G	56	5.287G
57	5.497G	58	5.522G	59	5.521G	60	5.370G



61	5.430G	62	5.536G	63	5.605G	64	5.269G
65	5.553G	66	5.310G	67	5.454G	68	5.411G
69	5.489G	70	5.683G	71	5.413G	72	5.467G
73	5.692G	74	5.445G	75	5.462G	76	5.335G
77	5.548G	78	5.533G	79	5.354G	80	5.703G
81	5.476G	82	5.392G	83	5.271G	84	5.619G
85	5.701G	86	5.685G	87	5.513G	88	5.443G
89	5.322G	90	5.395G	91	5.472G	92	5.653G
93	5.421G	94	5.585G	95	5.580G	96	5.349G
97	5.496G	98	5.648G	99	5.514G	100	5.711G

Hopping Frequency Sequence Name: HOP\_FREQ\_SEQ\_19

SEQ#	Frequency (Hz)	SEQ#	Frequency (Hz)	SEQ#	Frequency (Hz)	SEQ#	Frequency (Hz)
1	5.441G	2	5.475G	3	5.722G	4	5.267G
5	5.379G	6	5.698G	7	5.365G	8	5.573G
9	5.496G	10	5.706G	11	5.651G	12	5.286G
13	5.456G	14	5.270G	15	5.639G	16	5.433G
17	5.558G	18	5.660G	19	5.709G	20	5.413G
21	5.371G	22	5.463G	23	5.479G	24	5.634G
25	5.397G	26	5.633G	27	5.637G	28	5.609G
29	5.495G	30	5.313G	31	5.363G	32	5.666G
33	5.451G	34	5.258G	35	5.422G	36	5.385G
37	5.648G	38	5.613G	39	5.278G	40	5.464G
41	5.444G	42	5.546G	43	5.682G	44	5.302G
45	5.681G	46	5.515G	47	5.619G	48	5.336G
49	5.647G	50	5.641G	51	5.559G	52	5.551G
53	5.384G	54	5.373G	55	5.383G	56	5.288G
57	5.400G	58	5.548G	59	5.509G	60	5.589G
61	5.636G	62	5.517G	63	5.695G	64	5.646G
65	5.654G	66	5.393G	67	5.486G	68	5.307G
69	5.680G	70	5.419G	71	5.438G	72	5.388G
73	5.370G	74	5.355G	75	5.282G	76	5.665G
77	5.308G	78	5.402G	79	5.253G	80	5.518G
81	5.577G	82	5.261G	83	5.269G	84	5.428G
85	5.701G	86	5.377G	87	5.450G	88	5.295G
89	5.618G	90	5.689G	91	5.468G	92	5.594G

93	5.340G	94	5.553G	95	5.688G	96	5.304G
97	5.661G	98	5.649G	99	5.571G	100	5.696G

Hopping Frequency Sequence Name: HOP_FREQ_SEQ_20							
SEQ#	Frequency (Hz)	SEQ#	Frequency (Hz)	SEQ#	Frequency (Hz)	SEQ#	Frequency (Hz)
1	5.322G	2	5.266G	3	5.302G	4	5.406G
5	5.445G	6	5.455G	7	5.462G	8	5.284G
9	5.283G	10	5.539G	11	5.670G	12	5.681G
13	5.491G	14	5.476G	15	5.703G	16	5.708G
17	5.398G	18	5.352G	19	5.262G	20	5.454G
21	5.677G	22	5.257G	23	5.584G	24	5.509G
25	5.553G	26	5.543G	27	5.361G	28	5.271G
29	5.435G	30	5.586G	31	5.299G	32	5.516G
33	5.621G	34	5.713G	35	5.657G	36	5.692G
37	5.613G	38	5.340G	39	5.559G	40	5.453G
41	5.347G	42	5.341G	43	5.395G	44	5.672G
45	5.626G	46	5.608G	47	5.656G	48	5.386G
49	5.477G	50	5.712G	51	5.493G	52	5.301G
53	5.442G	54	5.334G	55	5.287G	56	5.717G
57	5.654G	58	5.576G	59	5.379G	60	5.659G
61	5.500G	62	5.480G	63	5.640G	64	5.463G
65	5.430G	66	5.575G	67	5.474G	68	5.267G
69	5.317G	70	5.544G	71	5.532G	72	5.633G
73	5.536G	74	5.443G	75	5.279G	76	5.297G
77	5.706G	78	5.683G	79	5.264G	80	5.688G
81	5.380G	82	5.718G	83	5.673G	84	5.325G
85	5.354G	86	5.332G	87	5.461G	88	5.396G
89	5.603G	90	5.619G	91	5.425G	92	5.597G
93	5.478G	94	5.594G	95	5.473G	96	5.365G
97	5.417G	98	5.641G	99	5.710G	100	5.620G

Hopping Frequency Sequence Name: HOP_FREQ_SEQ_21							
SEQ#	Frequency (Hz)	SEQ#	Frequency (Hz)	SEQ#	Frequency (Hz)	SEQ#	Frequency (Hz)
1	5.283G	2	5.634G	3	5.478G	4	5.460G
5	5.457G	6	5.445G	7	5.281G	8	5.256G

9	5.536G	10	5.692G	11	5.278G	12	5.397G
13	5.649G	14	5.601G	15	5.453G	16	5.600G
17	5.408G	18	5.353G	19	5.581G	20	5.253G
21	5.615G	22	5.419G	23	5.557G	24	5.517G
25	5.511G	26	5.442G	27	5.694G	28	5.683G
29	5.350G	30	5.563G	31	5.302G	32	5.286G
33	5.587G	34	5.598G	35	5.512G	36	5.358G
37	5.718G	38	5.537G	39	5.605G	40	5.497G
41	5.568G	42	5.654G	43	5.611G	44	5.575G
45	5.518G	46	5.295G	47	5.679G	48	5.472G
49	5.277G	50	5.431G	51	5.324G	52	5.257G
53	5.541G	54	5.348G	55	5.716G	56	5.508G
57	5.411G	58	5.501G	59	5.268G	60	5.695G
61	5.698G	62	5.475G	63	5.631G	64	5.272G
65	5.545G	66	5.462G	67	5.436G	68	5.481G
69	5.707G	70	5.337G	71	5.288G	72	5.525G
73	5.709G	74	5.490G	75	5.488G	76	5.360G
77	5.317G	78	5.661G	79	5.589G	80	5.313G
81	5.293G	82	5.427G	83	5.423G	84	5.374G
85	5.340G	86	5.484G	87	5.526G	88	5.543G
89	5.567G	90	5.355G	91	5.700G	92	5.396G
93	5.619G	94	5.651G	95	5.721G	96	5.538G
97	5.414G	98	5.706G	99	5.584G	100	5.251G

Hopping Frequency Sequence Name: HOP_FREQ_SEQ_22							
SEQ#	Frequency (Hz)	SEQ#	Frequency (Hz)	SEQ#	Frequency (Hz)	SEQ#	Frequency (Hz)
1	5.532G	2	5.359G	3	5.695G	4	5.627G
5	5.658G	6	5.578G	7	5.623G	8	5.456G
9	5.303G	10	5.649G	11	5.602G	12	5.322G
13	5.571G	14	5.459G	15	5.257G	16	5.468G
17	5.630G	18	5.462G	19	5.704G	20	5.373G
21	5.709G	22	5.541G	23	5.267G	24	5.609G
25	5.334G	26	5.567G	27	5.543G	28	5.655G
29	5.472G	30	5.447G	31	5.706G	32	5.325G
33	5.577G	34	5.424G	35	5.679G	36	5.558G
37	5.705G	38	5.299G	39	5.323G	40	5.574G

41	5.721G	42	5.607G	43	5.311G	44	5.634G
45	5.665G	46	5.273G	47	5.575G	48	5.682G
49	5.691G	50	5.426G	51	5.638G	52	5.385G
53	5.673G	54	5.579G	55	5.708G	56	5.432G
57	5.294G	58	5.603G	59	5.710G	60	5.608G
61	5.425G	62	5.434G	63	5.377G	64	5.324G
65	5.676G	66	5.674G	67	5.430G	68	5.712G
69	5.395G	70	5.620G	71	5.503G	72	5.671G
73	5.400G	74	5.411G	75	5.444G	76	5.340G
77	5.289G	78	5.448G	79	5.480G	80	5.266G
81	5.415G	82	5.605G	83	5.336G	84	5.549G
85	5.295G	86	5.317G	87	5.369G	88	5.694G
89	5.272G	90	5.436G	91	5.372G	92	5.306G
93	5.505G	94	5.261G	95	5.320G	96	5.316G
97	5.599G	98	5.331G	99	5.596G	100	5.483G

Hopping Frequency Sequence Name: HOP_FREQ_SEQ_23							
SEQ#	Frequency (Hz)	SEQ#	Frequency (Hz)	SEQ#	Frequency (Hz)	SEQ#	Frequency (Hz)
1	5.688G	2	5.550G	3	5.568G	4	5.350G
5	5.265G	6	5.375G	7	5.297G	8	5.382G
9	5.641G	10	5.580G	11	5.567G	12	5.695G
13	5.618G	14	5.395G	15	5.275G	16	5.689G
17	5.263G	18	5.387G	19	5.449G	20	5.335G
21	5.467G	22	5.511G	23	5.292G	24	5.490G
25	5.646G	26	5.432G	27	5.444G	28	5.665G
29	5.318G	30	5.679G	31	5.548G	32	5.505G
33	5.302G	34	5.494G	35	5.601G	36	5.420G
37	5.383G	38	5.675G	39	5.355G	40	5.514G
41	5.577G	42	5.698G	43	5.621G	44	5.429G
45	5.451G	46	5.598G	47	5.278G	48	5.654G
49	5.503G	50	5.269G	51	5.612G	52	5.365G
53	5.419G	54	5.421G	55	5.385G	56	5.280G
57	5.685G	58	5.538G	59	5.314G	60	5.326G
61	5.461G	62	5.562G	63	5.563G	64	5.282G
65	5.604G	66	5.307G	67	5.339G	68	5.397G
69	5.596G	70	5.589G	71	5.702G	72	5.671G

73	5.634G	74	5.518G	75	5.374G	76	5.553G
77	5.682G	78	5.656G	79	5.384G	80	5.264G
81	5.697G	82	5.462G	83	5.519G	84	5.424G
85	5.460G	86	5.623G	87	5.254G	88	5.527G
89	5.422G	90	5.489G	91	5.493G	92	5.515G
93	5.705G	94	5.687G	95	5.260G	96	5.434G
97	5.628G	98	5.672G	99	5.484G	100	5.259G

Hopping Frequency Sequence Name: HOP_FREQ_SEQ_24							
SEQ#	Frequency (Hz)	SEQ#	Frequency (Hz)	SEQ#	Frequency (Hz)	SEQ#	Frequency (Hz)
1	5.321G	2	5.327G	3	5.268G	4	5.701G
5	5.454G	6	5.572G	7	5.546G	8	5.331G
9	5.654G	10	5.443G	11	5.717G	12	5.697G
13	5.411G	14	5.605G	15	5.455G	16	5.580G
17	5.666G	18	5.567G	19	5.403G	20	5.279G
21	5.396G	22	5.555G	23	5.422G	24	5.659G
25	5.612G	26	5.298G	27	5.564G	28	5.484G
29	5.252G	30	5.601G	31	5.365G	32	5.524G
33	5.272G	34	5.586G	35	5.313G	36	5.591G
37	5.318G	38	5.438G	39	5.452G	40	5.251G
41	5.686G	42	5.515G	43	5.436G	44	5.562G
45	5.378G	46	5.398G	47	5.254G	48	5.301G
49	5.599G	50	5.719G	51	5.263G	52	5.670G
53	5.450G	54	5.471G	55	5.640G	56	5.476G
57	5.539G	58	5.400G	59	5.532G	60	5.487G
61	5.519G	62	5.689G	63	5.333G	64	5.425G
65	5.607G	66	5.648G	67	5.533G	68	5.473G
69	5.395G	70	5.419G	71	5.474G	72	5.470G
73	5.407G	74	5.431G	75	5.281G	76	5.266G
77	5.696G	78	5.326G	79	5.461G	80	5.343G
81	5.596G	82	5.651G	83	5.581G	84	5.479G
85	5.325G	86	5.589G	87	5.714G	88	5.346G
89	5.537G	90	5.481G	91	5.355G	92	5.501G
93	5.671G	94	5.655G	95	5.517G	96	5.394G
97	5.393G	98	5.613G	99	5.641G	100	5.679G

Hopping Frequency Sequence Name: HOP_FREQ_SEQ_25							
SEQ#	Frequency (Hz)	SEQ#	Frequency (Hz)	SEQ#	Frequency (Hz)	SEQ#	Frequency (Hz)
1	5.430G	2	5.629G	3	5.274G	4	5.660G
5	5.412G	6	5.669G	7	5.636G	8	5.297G
9	5.575G	10	5.259G	11	5.706G	12	5.673G
13	5.327G	14	5.591G	15	5.682G	16	5.643G
17	5.462G	18	5.621G	19	5.302G	20	5.539G
21	5.585G	22	5.683G	23	5.576G	24	5.379G
25	5.530G	26	5.620G	27	5.710G	28	5.387G
29	5.404G	30	5.594G	31	5.514G	32	5.548G
33	5.489G	34	5.344G	35	5.304G	36	5.381G
37	5.279G	38	5.316G	39	5.459G	40	5.272G
41	5.579G	42	5.371G	43	5.307G	44	5.616G
45	5.441G	46	5.287G	47	5.255G	48	5.450G
49	5.290G	50	5.373G	51	5.571G	52	5.699G
53	5.250G	54	5.670G	55	5.486G	56	5.391G
57	5.256G	58	5.300G	59	5.411G	60	5.561G
61	5.582G	62	5.627G	63	5.254G	64	5.420G
65	5.289G	66	5.436G	67	5.524G	68	5.559G
69	5.596G	70	5.553G	71	5.380G	72	5.416G
73	5.523G	74	5.335G	75	5.650G	76	5.577G
77	5.386G	78	5.438G	79	5.691G	80	5.566G
81	5.293G	82	5.395G	83	5.652G	84	5.504G
85	5.718G	86	5.709G	87	5.398G	88	5.421G
89	5.320G	90	5.499G	91	5.265G	92	5.317G
93	5.603G	94	5.544G	95	5.346G	96	5.547G
97	5.569G	98	5.268G	99	5.370G	100	5.507G

Hopping Frequency Sequence Name: HOP_FREQ_SEQ_26							
SEQ#	Frequency (Hz)	SEQ#	Frequency (Hz)	SEQ#	Frequency (Hz)	SEQ#	Frequency (Hz)
1	5.354G	2	5.651G	3	5.581G	4	5.722G
5	5.338G	6	5.325G	7	5.544G	8	5.401G
9	5.470G	10	5.703G	11	5.281G	12	5.571G
13	5.253G	14	5.342G	15	5.545G	16	5.617G
17	5.510G	18	5.344G	19	5.578G	20	5.588G

21	5.519G	22	5.308G	23	5.291G	24	5.469G
25	5.475G	26	5.333G	27	5.250G	28	5.328G
29	5.289G	30	5.646G	31	5.441G	32	5.496G
33	5.343G	34	5.654G	35	5.647G	36	5.451G
37	5.305G	38	5.403G	39	5.380G	40	5.667G
41	5.347G	42	5.307G	43	5.297G	44	5.418G
45	5.674G	46	5.686G	47	5.426G	48	5.438G
49	5.513G	50	5.449G	51	5.701G	52	5.678G
53	5.274G	54	5.688G	55	5.303G	56	5.517G
57	5.352G	58	5.563G	59	5.695G	60	5.267G
61	5.709G	62	5.290G	63	5.584G	64	5.715G
65	5.693G	66	5.261G	67	5.599G	68	5.613G
69	5.607G	70	5.417G	71	5.629G	72	5.302G
73	5.453G	74	5.568G	75	5.330G	76	5.714G
77	5.386G	78	5.657G	79	5.264G	80	5.498G
81	5.326G	82	5.478G	83	5.614G	84	5.394G
85	5.702G	86	5.602G	87	5.723G	88	5.433G
89	5.557G	90	5.295G	91	5.277G	92	5.474G
93	5.685G	94	5.260G	95	5.682G	96	5.619G
97	5.683G	98	5.671G	99	5.425G	100	5.361G

Hopping Frequency Sequence Name: HOP_FREQ_SEQ_27							
SEQ#	Frequency (Hz)	SEQ#	Frequency (Hz)	SEQ#	Frequency (Hz)	SEQ#	Frequency (Hz)
1	5.589G	2	5.355G	3	5.555G	4	5.484G
5	5.367G	6	5.651G	7	5.669G	8	5.487G
9	5.480G	10	5.543G	11	5.674G	12	5.261G
13	5.346G	14	5.724G	15	5.332G	16	5.639G
17	5.609G	18	5.482G	19	5.360G	20	5.493G
21	5.572G	22	5.465G	23	5.468G	24	5.621G
25	5.705G	26	5.405G	27	5.470G	28	5.416G
29	5.419G	30	5.548G	31	5.458G	32	5.314G
33	5.365G	34	5.342G	35	5.423G	36	5.664G
37	5.701G	38	5.677G	39	5.501G	40	5.354G
41	5.512G	42	5.492G	43	5.659G	44	5.274G
45	5.464G	46	5.665G	47	5.334G	48	5.343G
49	5.594G	50	5.561G	51	5.622G	52	5.335G

53	5.373G	54	5.319G	55	5.388G	56	5.694G
57	5.358G	58	5.363G	59	5.550G	60	5.268G
61	5.438G	62	5.597G	63	5.308G	64	5.286G
65	5.263G	66	5.719G	67	5.392G	68	5.399G
69	5.584G	70	5.442G	71	5.433G	72	5.591G
73	5.523G	74	5.634G	75	5.356G	76	5.703G
77	5.264G	78	5.673G	79	5.579G	80	5.348G
81	5.471G	82	5.295G	83	5.521G	84	5.383G
85	5.290G	86	5.656G	87	5.366G	88	5.429G
89	5.528G	90	5.638G	91	5.444G	92	5.527G
93	5.641G	94	5.466G	95	5.507G	96	5.626G
97	5.393G	98	5.545G	99	5.324G	100	5.452G

Hopping Frequency Sequence Name: HOP\_FREQ\_SEQ\_28

SEQ#	Frequency (Hz)	SEQ#	Frequency (Hz)	SEQ#	Frequency (Hz)	SEQ#	Frequency (Hz)
1	5.567G	2	5.598G	3	5.450G	4	5.662G
5	5.644G	6	5.340G	7	5.547G	8	5.566G
9	5.337G	10	5.678G	11	5.568G	12	5.671G
13	5.607G	14	5.292G	15	5.316G	16	5.353G
17	5.338G	18	5.581G	19	5.289G	20	5.572G
21	5.307G	22	5.402G	23	5.390G	24	5.609G
25	5.264G	26	5.371G	27	5.660G	28	5.540G
29	5.404G	30	5.341G	31	5.514G	32	5.589G
33	5.381G	34	5.522G	35	5.695G	36	5.465G
37	5.530G	38	5.256G	39	5.269G	40	5.591G
41	5.252G	42	5.577G	43	5.275G	44	5.389G
45	5.489G	46	5.263G	47	5.595G	48	5.537G
49	5.339G	50	5.637G	51	5.283G	52	5.355G
53	5.462G	54	5.407G	55	5.674G	56	5.603G
57	5.344G	58	5.531G	59	5.582G	60	5.259G
61	5.447G	62	5.702G	63	5.696G	64	5.349G
65	5.451G	66	5.576G	67	5.356G	68	5.519G
69	5.418G	70	5.397G	71	5.658G	72	5.617G
73	5.494G	74	5.689G	75	5.592G	76	5.476G
77	5.413G	78	5.335G	79	5.377G	80	5.473G
81	5.545G	82	5.722G	83	5.565G	84	5.688G



85	5.683G	86	5.429G	87	5.499G	88	5.369G
89	5.330G	90	5.308G	91	5.351G	92	5.505G
93	5.498G	94	5.667G	95	5.368G	96	5.448G
97	5.427G	98	5.320G	99	5.483G	100	5.657G

Hopping Frequency Sequence Name: HOP_FREQ_SEQ_29							
SEQ#	Frequency (Hz)	SEQ#	Frequency (Hz)	SEQ#	Frequency (Hz)	SEQ#	Frequency (Hz)
1	5.480G	2	5.391G	3	5.327G	4	5.379G
5	5.330G	6	5.704G	7	5.374G	8	5.303G
9	5.532G	10	5.607G	11	5.631G	12	5.276G
13	5.403G	14	5.679G	15	5.309G	16	5.542G
17	5.635G	18	5.627G	19	5.385G	20	5.525G
21	5.353G	22	5.572G	23	5.279G	24	5.326G
25	5.304G	26	5.294G	27	5.578G	28	5.431G
29	5.626G	30	5.486G	31	5.584G	32	5.565G
33	5.682G	34	5.586G	35	5.469G	36	5.520G
37	5.307G	38	5.660G	39	5.347G	40	5.521G
41	5.441G	42	5.338G	43	5.449G	44	5.465G
45	5.464G	46	5.599G	47	5.683G	48	5.405G
49	5.413G	50	5.570G	51	5.448G	52	5.362G
53	5.632G	54	5.600G	55	5.695G	56	5.564G
57	5.482G	58	5.634G	59	5.676G	60	5.388G
61	5.290G	62	5.383G	63	5.254G	64	5.392G
65	5.298G	66	5.544G	67	5.664G	68	5.277G
69	5.530G	70	5.613G	71	5.262G	72	5.698G
73	5.399G	74	5.658G	75	5.514G	76	5.597G
77	5.335G	78	5.451G	79	5.559G	80	5.280G
81	5.384G	82	5.450G	83	5.555G	84	5.412G
85	5.507G	86	5.574G	87	5.437G	88	5.567G
89	5.628G	90	5.583G	91	5.563G	92	5.602G
93	5.372G	94	5.619G	95	5.363G	96	5.271G
97	5.677G	98	5.331G	99	5.617G	100	5.491G

Hopping Frequency Sequence Name: HOP_FREQ_SEQ_30							
SEQ#	Frequency (Hz)	SEQ#	Frequency (Hz)	SEQ#	Frequency (Hz)	SEQ#	Frequency (Hz)
1	5.476G	2	5.502G	3	5.713G	4	5.709G
5	5.615G	6	5.655G	7	5.685G	8	5.377G
9	5.470G	10	5.489G	11	5.317G	12	5.335G
13	5.295G	14	5.371G	15	5.252G	16	5.320G
17	5.413G	18	5.354G	19	5.305G	20	5.482G
21	5.689G	22	5.326G	23	5.640G	24	5.306G
25	5.662G	26	5.462G	27	5.559G	28	5.528G
29	5.435G	30	5.698G	31	5.627G	32	5.553G
33	5.504G	34	5.266G	35	5.484G	36	5.428G
37	5.277G	38	5.328G	39	5.265G	40	5.510G
41	5.289G	42	5.336G	43	5.343G	44	5.459G
45	5.480G	46	5.261G	47	5.351G	48	5.487G
49	5.349G	50	5.344G	51	5.564G	52	5.303G
53	5.654G	54	5.518G	55	5.418G	56	5.602G
57	5.485G	58	5.703G	59	5.452G	60	5.263G
61	5.337G	62	5.255G	63	5.404G	64	5.661G
65	5.448G	66	5.283G	67	5.254G	68	5.719G
69	5.378G	70	5.548G	71	5.367G	72	5.392G
73	5.325G	74	5.490G	75	5.472G	76	5.577G
77	5.250G	78	5.724G	79	5.619G	80	5.665G
81	5.426G	82	5.563G	83	5.399G	84	5.474G
85	5.667G	86	5.352G	87	5.613G	88	5.338G
89	5.583G	90	5.347G	91	5.506G	92	5.491G
93	5.424G	94	5.260G	95	5.498G	96	5.692G
97	5.256G	98	5.464G	99	5.546G	100	5.645G

**IEEE 802.11ac 40MHz**

Type 1 Radar Statistical Performances				
Trial #	Pulses per Burst	Pulse Width (s)	PRI (s)	Detection
1	102	1.0u	518.0u	Yes
2	95	1.0u	558.0u	Yes
3	89	1.0u	598.0u	Yes
4	83	1.0u	638.0u	Yes
5	78	1.0u	678.0u	Yes
6	74	1.0u	718.0u	Yes
7	72	1.0u	738.0u	Yes
8	70	1.0u	758.0u	Yes
9	67	1.0u	798.0u	Yes
10	63	1.0u	838.0u	Yes
11	61	1.0u	878.0u	Yes
12	59	1.0u	898.0u	Yes
13	58	1.0u	918.0u	Yes
14	57	1.0u	938.0u	Yes
15	18	1.0u	3.066m	Yes
16	46	1.0u	1.152m	Yes
17	39	1.0u	1.365m	Yes
18	88	1.0u	601.0u	Yes
19	34	1.0u	1.577m	Yes
20	30	1.0u	1.790m	Yes
21	88	1.0u	605.0u	Yes
22	27	1.0u	2.002m	Yes
23	24	1.0u	2.215m	Yes
24	87	1.0u	609.0u	Yes
25	22	1.0u	2.428m	Yes
26	20	1.0u	2.640m	Yes
27	84	1.0u	633.0u	Yes
28	19	1.0u	2.853m	Yes
29	18	1.0u	3.065m	Yes
30	92	1.0u	577.0u	Yes
				Detection Rate: 100.0 %

Type 2 Radar Statistical Performances				
Trial #	Pulses per Burst	Pulse Width (s)	PRI (s)	Detection
1	25	4.6u	200.0u	Yes
2	27	2.8u	200.0u	Yes
3	27	1.7u	161.0u	Yes
4	28	2.6u	220.0u	Yes
5	27	2.6u	218.0u	Yes
6	27	1.7u	172.0u	Yes
7	26	1.6u	191.0u	Yes
8	25	3.7u	158.0u	Yes
9	28	1.5u	228.0u	Yes
10	26	4.9u	198.0u	Yes
11	28	1.3u	205.0u	Yes
12	29	2.6u	155.0u	Yes
13	28	4.9u	224.0u	Yes
14	24	2.9u	169.0u	Yes
15	28	4.1u	183.0u	Yes
16	27	1.7u	192.0u	Yes
17	24	2.6u	191.0u	Yes
18	27	4.6u	173.0u	Yes
19	28	3.4u	187.0u	Yes
20	27	4.3u	214.0u	Yes
21	29	1.2u	179.0u	Yes
22	25	1.1u	154.0u	Yes
23	25	4.1u	159.0u	No
24	28	2.9u	158.0u	Yes
25	25	2.8u	215.0u	Yes
26	27	4.0u	196.0u	Yes
27	27	4.5u	215.0u	Yes
28	27	2.9u	180.0u	Yes
29	27	1.5u	177.0u	No
30	28	1.6u	186.0u	Yes
			Detection Rate: 93.3 %	

Type 3 Radar Statistical Performances				
Trial #	Pulses per Burst	Pulse Width (s)	PRI (s)	Detection
1	17	9.6u	218.0u	Yes
2	18	8.4u	494.0u	Yes
3	17	8.7u	375.0u	Yes
4	18	7.0u	379.0u	Yes
5	17	8.9u	401.0u	Yes
6	17	8.3u	348.0u	Yes
7	16	6.2u	454.0u	Yes
8	18	9.2u	299.0u	Yes
9	16	9.6u	347.0u	Yes
10	16	7.0u	293.0u	Yes
11	17	9.7u	434.0u	Yes
12	16	9.5u	405.0u	Yes
13	17	9.0u	459.0u	Yes
14	18	6.2u	349.0u	Yes
15	17	7.9u	225.0u	Yes
16	18	8.0u	384.0u	Yes
17	17	6.5u	220.0u	Yes
18	16	8.4u	225.0u	Yes
19	17	6.1u	210.0u	Yes
20	16	6.0u	260.0u	Yes
21	18	9.1u	470.0u	Yes
22	16	7.1u	474.0u	Yes
23	18	9.1u	433.0u	Yes
24	18	9.1u	296.0u	Yes
25	16	8.5u	368.0u	Yes
26	16	6.4u	315.0u	No
27	17	6.9u	204.0u	Yes
28	18	6.8u	309.0u	Yes
29	17	9.2u	351.0u	Yes
30	17	9.0u	201.0u	Yes
			Detection Rate: 96.7 %	

Type 4 Radar Statistical Performances				
Trial #	Pulses per Burst	Pulse Width (s)	PRI (s)	Detection
1	14	14.3u	312.0u	Yes
2	13	18.3u	368.0u	Yes
3	13	18.4u	392.0u	Yes
4	16	14.9u	457.0u	Yes
5	13	15.9u	337.0u	Yes
6	14	13.7u	413.0u	No
7	13	13.6u	263.0u	Yes
8	14	11.2u	484.0u	No
9	12	11.6u	341.0u	Yes
10	14	18.2u	448.0u	Yes
11	14	14.2u	423.0u	Yes
12	14	12.4u	470.0u	Yes
13	13	18.0u	336.0u	Yes
14	15	17.8u	213.0u	Yes
15	14	11.8u	297.0u	Yes
16	15	16.6u	436.0u	Yes
17	15	16.8u	298.0u	Yes
18	13	14.9u	459.0u	Yes
19	14	19.5u	286.0u	Yes
20	16	18.4u	462.0u	Yes
21	15	19.0u	314.0u	Yes
22	15	16.2u	284.0u	Yes
23	13	16.9u	396.0u	Yes
24	15	14.9u	202.0u	Yes
25	14	17.8u	492.0u	Yes
26	12	14.2u	451.0u	Yes
27	12	18.2u	350.0u	No
28	15	14.7u	204.0u	Yes
29	12	16.6u	418.0u	Yes
30	13	14.1u	218.0u	No
			Detection Rate: 86.7 %	

Type 5 Radar Statistical Performances		
Trial #	Test Signal Name	Detection
1	LP_Signal_01	Yes
2	LP_Signal_02	Yes
3	LP_Signal_03	Yes
4	LP_Signal_04	Yes
5	LP_Signal_05	No
6	LP_Signal_06	Yes
7	LP_Signal_07	Yes
8	LP_Signal_08	Yes
9	LP_Signal_09	Yes
10	LP_Signal_10	No
11	LP_Signal_11	No
12	LP_Signal_12	Yes
13	LP_Signal_13	Yes
14	LP_Signal_14	Yes
15	LP_Signal_15	Yes
16	LP_Signal_16	Yes
17	LP_Signal_17	Yes
18	LP_Signal_18	Yes
19	LP_Signal_19	Yes
20	LP_Signal_20	Yes
21	LP_Signal_21	Yes
22	LP_Signal_22	Yes
23	LP_Signal_23	No
24	LP_Signal_24	Yes
25	LP_Signal_25	Yes
26	LP_Signal_26	Yes
27	LP_Signal_27	Yes
28	LP_Signal_28	Yes
29	LP_Signal_29	Yes
30	LP_Signal_30	Yes
		Detection Rate: 86.7 %

Long Pulse Radar Test Signal						
Test Signal Name: LP_Signal_01						
Number of Bursts in Trial: 16						
Burst	Pulses per Burst	Chrip (Hz)	Pulse Width (s)	Pulse 1 to 2 Spacing (s)	Pulse 2 to 3 Spacing (s)	Start Location (s)
1	2	8M	84.1u	1.706m	-	633.4m
2	2	19M	86.6u	1.265m	-	29.01m
3	2	19M	83.7u	1.208m	-	173.0m
4	2	16M	73.4u	1.102m	-	727.5m
5	3	10M	69.8u	1.589m	1.187m	272.9m
6	3	18M	78.9u	1.778m	923.1u	491.3m
7	1	12M	50.7u	-	-	179.1m
8	3	15M	75.2u	1.329m	1.086m	546.7m
9	2	15M	67.1u	1.104m	-	439.4m
10	2	5M	83.8u	1.674m	-	329.1m
11	2	17M	81.3u	1.875m	-	522.5m
12	2	15M	76.3u	1.289m	-	615.4m
13	1	19M	63.2u	-	-	449.1m
14	2	20M	69.7u	1.822m	-	536.3m
15	2	18M	66.5u	1.262m	-	72.80m
16	1	18M	67.4u	-	-	561.1m

Long Pulse Radar Test Signal						
Test Signal Name: LP_Signal_02						
Number of Bursts in Trial: 19						
Burst	Pulses per Burst	Chrip (Hz)	Pulse Width (s)	Pulse 1 to 2 Spacing (s)	Pulse 2 to 3 Spacing (s)	Start Location (s)
1	2	7M	73.1u	1.383m	-	495.3m
2	2	16M	96.5u	1.663m	-	441.1m
3	2	18M	54.4u	1.709m	-	417.2m
4	2	12M	88.0u	1.229m	-	481.5m
5	2	15M	70.0u	1.416m	-	595.1m
6	2	13M	81.9u	1.453m	-	408.8m



7	2	14M	98.3u	1.230m	-	59.31m
8	1	13M	74.9u	-	-	561.2m
9	2	7M	89.2u	1.110m	-	346.0m
10	1	6M	74.0u	-	-	307.3m
11	3	11M	52.8u	1.096m	1.240m	493.6m
12	3	19M	67.3u	1.285m	1.492m	415.9m
13	1	20M	61.2u	-	-	152.9m
14	1	10M	50.3u	-	-	135.2m
15	2	16M	90.0u	1.862m	-	38.81m
16	3	10M	60.1u	1.690m	1.236m	312.1m
17	2	19M	68.5u	1.740m	-	302.8m
18	2	10M	52.4u	1.853m	-	399.8m
19	2	9M	54.4u	1.379m	-	419.2m

Long Pulse Radar Test Signal						
Test Signal Name: LP_Signal_03						
Number of Bursts in Trial: 14						
Burst	Pulses per Burst	Chrip (Hz)	Pulse Width (s)	Pulse 1 to 2 Spacing (s)	Pulse 2 to 3 Spacing (s)	Start Location (s)
1	3	14M	77.4u	1.614m	1.917m	342.6m
2	2	6M	72.3u	1.664m	-	753.6m
3	1	20M	63.2u	-	-	145.3m
4	2	6M	70.7u	1.412m	-	35.96m
5	2	17M	62.8u	1.509m	-	132.7m
6	2	9M	81.6u	1.701m	-	375.0m
7	1	5M	56.4u	-	-	118.5m
8	2	6M	71.6u	1.447m	-	70.15m
9	1	16M	51.1u	-	-	330.9m
10	2	15M	93.4u	1.644m	-	521.0m
11	2	12M	64.4u	1.329m	-	335.3m
12	2	17M	59.6u	946.4u	-	562.3m
13	2	6M	80.1u	1.003m	-	289.9m
14	2	18M	82.5u	1.201m	-	639.5m

Long Pulse Radar Test Signal						
Test Signal Name: LP_Signal_04						
Number of Bursts in Trial: 19						
Burst	Pulses per Burst	Chrip (Hz)	Pulse Width (s)	Pulse 1 to 2 Spacing (s)	Pulse 2 to 3 Spacing (s)	Start Location (s)
1	1	7M	56.4u	-	-	558.3m
2	2	16M	99.6u	1.771m	-	296.2m
3	1	17M	71.0u	-	-	232.3m
4	2	10M	77.9u	935.1u	-	278.7m
5	2	8M	64.0u	1.132m	-	518.5m
6	2	11M	72.6u	1.479m	-	68.28m
7	3	12M	97.6u	1.294m	1.022m	522.7m
8	3	16M	52.8u	1.198m	1.493m	308.5m
9	2	12M	61.6u	1.570m	-	391.7m
10	2	13M	99.1u	1.058m	-	267.0m
11	1	7M	78.0u	-	-	156.1m
12	2	15M	64.7u	1.836m	-	516.6m
13	2	17M	97.1u	1.666m	-	32.94m
14	3	17M	71.2u	969.8u	1.406m	441.2m
15	3	19M	77.2u	1.527m	1.198m	347.3m
16	2	14M	74.9u	1.150m	-	353.8m
17	2	18M	66.3u	1.724m	-	530.9m
18	2	14M	51.8u	1.374m	-	102.1m
19	2	16M	97.0u	1.734m	-	362.0m

Long Pulse Radar Test Signal						
Test Signal Name: LP_Signal_05						
Number of Bursts in Trial: 10						
Burst	Pulses per Burst	Chrip (Hz)	Pulse Width (s)	Pulse 1 to 2 Spacing (s)	Pulse 2 to 3 Spacing (s)	Start Location (s)
1	2	15M	80.9u	1.555m	-	736.6m
2	1	8M	86.8u	-	-	887.7m
3	3	19M	51.5u	998.5u	1.798m	1.164

4	1	10M	76.9u	-	-	1.048
5	2	12M	77.8u	1.196m	-	1.134
6	2	17M	99.2u	1.489m	-	614.5m
7	2	14M	51.4u	1.147m	-	444.6m
8	2	14M	76.6u	1.055m	-	222.7m
9	2	7M	64.5u	1.913m	-	1.034
10	2	14M	64.4u	1.427m	-	657.7m

Long Pulse Radar Test Signal						
Test Signal Name: LP_Signal_06						
Number of Bursts in Trial: 18						
Burst	Pulses per Burst	Chrip (Hz)	Pulse Width (s)	Pulse 1 to 2 Spacing (s)	Pulse 2 to 3 Spacing (s)	Start Location (s)
1	2	11M	70.3u	1.340m	-	605.8m
2	1	12M	72.2u	-	-	594.0m
3	1	14M	97.1u	-	-	27.52m
4	2	18M	55.1u	1.732m	-	660.8m
5	3	10M	82.4u	1.830m	1.733m	74.47m
6	2	18M	59.9u	1.904m	-	451.4m
7	1	8M	76.6u	-	-	514.5m
8	1	13M	83.8u	-	-	417.3m
9	3	19M	81.3u	1.117m	1.440m	93.51m
10	2	12M	89.4u	1.207m	-	624.1m
11	2	17M	86.3u	1.548m	-	135.7m
12	2	19M	56.6u	1.463m	-	294.2m
13	3	18M	96.6u	1.813m	1.866m	500.8m
14	2	11M	67.4u	1.366m	-	325.1m
15	1	17M	94.7u	-	-	659.6m
16	2	12M	68.8u	996.2u	-	44.71m
17	2	12M	51.9u	1.069m	-	141.4m
18	3	6M	78.3u	1.398m	1.523m	327.3m

Long Pulse Radar Test Signal						
Test Signal Name: LP_Signal_07						
Number of Bursts in Trial: 9						
Burst	Pulses per Burst	Chrip (Hz)	Pulse Width (s)	Pulse 1 to 2 Spacing (s)	Pulse 2 to 3 Spacing (s)	Start Location (s)
1	1	18M	94.0u	-	-	1.172
2	2	12M	61.4u	1.813m	-	239.4m
3	1	18M	81.0u	-	-	566.3m
4	2	17M	92.8u	1.025m	-	88.48m
5	2	17M	66.6u	1.718m	-	934.9m
6	2	8M	72.1u	1.323m	-	1.063
7	3	10M	63.0u	1.441m	1.857m	559.8m
8	2	11M	63.2u	1.520m	-	192.7m
9	2	10M	96.6u	1.211m	-	297.7m

Long Pulse Radar Test Signal						
Test Signal Name: LP_Signal_08						
Number of Bursts in Trial: 14						
Burst	Pulses per Burst	Chrip (Hz)	Pulse Width (s)	Pulse 1 to 2 Spacing (s)	Pulse 2 to 3 Spacing (s)	Start Location (s)
1	2	12M	52.8u	1.473m	-	198.0m
2	1	10M	98.4u	-	-	854.6m
3	2	17M	81.3u	1.082m	-	655.3m
4	1	6M	99.6u	-	-	97.58m
5	2	9M	91.9u	1.046m	-	316.8m
6	2	11M	67.5u	1.840m	-	720.6m
7	1	5M	50.5u	-	-	210.9m
8	2	17M	86.4u	1.249m	-	647.7m
9	1	10M	72.5u	-	-	262.8m
10	3	10M	88.6u	1.012m	925.4u	498.2m
11	1	17M	70.1u	-	-	58.53m
12	3	13M	65.6u	1.035m	1.460m	792.3m
13	1	13M	70.2u	-	-	772.9m
14	1	6M	62.0u	-	-	225.1m

Long Pulse Radar Test Signal						
Test Signal Name: LP_Signal_09						
Number of Bursts in Trial: 12						
Burst	Pulses per Burst	Chrip (Hz)	Pulse Width (s)	Pulse 1 to 2 Spacing (s)	Pulse 2 to 3 Spacing (s)	Start Location (s)
1	3	20M	60.0u	1.932m	1.188m	976.2m
2	3	10M	80.0u	1.884m	1.117m	681.4m
3	2	16M	56.3u	1.719m	-	427.8m
4	1	6M	88.3u	-	-	981.4m
5	1	20M	62.5u	-	-	115.8m
6	2	5M	95.9u	1.768m	-	52.65m
7	3	11M	68.9u	1.512m	1.881m	301.1m
8	2	12M	89.4u	1.297m	-	581.7m
9	3	6M	67.0u	1.532m	1.167m	527.1m
10	1	6M	95.6u	-	-	952.8m
11	2	15M	58.4u	1.332m	-	516.9m
12	3	19M	95.3u	1.837m	1.896m	65.45m

Long Pulse Radar Test Signal						
Test Signal Name: LP_Signal_10						
Number of Bursts in Trial: 11						
Burst	Pulses per Burst	Chrip (Hz)	Pulse Width (s)	Pulse 1 to 2 Spacing (s)	Pulse 2 to 3 Spacing (s)	Start Location (s)
1	1	10M	77.0u	-	-	467.6m
2	1	18M	80.3u	-	-	818.5m
3	2	18M	51.6u	1.877m	-	65.48m
4	2	14M	94.3u	1.291m	-	461.3m
5	2	7M	58.3u	1.861m	-	331.1m
6	3	19M	93.6u	1.753m	1.339m	810.2m
7	3	9M	82.5u	1.766m	1.801m	665.6m
8	1	13M	64.7u	-	-	504.6m
9	2	17M	98.6u	1.589m	-	1.056
10	1	17M	94.5u	-	-	435.0m
11	2	13M	91.7u	915.3u	-	502.1m

Long Pulse Radar Test Signal						
Test Signal Name: LP_Signal_11						
Number of Bursts in Trial: 15						
Burst	Pulses per Burst	Chrip (Hz)	Pulse Width (s)	Pulse 1 to 2 Spacing (s)	Pulse 2 to 3 Spacing (s)	Start Location (s)
1	2	11M	66.5u	1.356m	-	53.39m
2	2	18M	67.9u	1.160m	-	521.1m
3	2	9M	73.8u	1.665m	-	615.9m
4	3	12M	93.4u	1.720m	1.445m	449.1m
5	3	10M	96.8u	1.448m	921.2u	450.6m
6	2	17M	81.1u	1.436m	-	453.1m
7	2	11M	55.5u	1.785m	-	491.6m
8	2	19M	94.7u	1.598m	-	115.7m
9	1	11M	95.1u	-	-	537.9m
10	2	15M	73.0u	1.916m	-	285.3m
11	3	9M	90.6u	1.095m	917.4u	202.3m
12	1	15M	91.0u	-	-	350.9m
13	2	7M	80.2u	1.527m	-	225.8m
14	3	11M	70.3u	963.7u	1.586m	676.1m
15	3	17M	96.3u	1.659m	936.7u	15.38m

Long Pulse Radar Test Signal						
Test Signal Name: LP_Signal_12						
Number of Bursts in Trial: 16						
Burst	Pulses per Burst	Chrip (Hz)	Pulse Width (s)	Pulse 1 to 2 Spacing (s)	Pulse 2 to 3 Spacing (s)	Start Location (s)
1	2	9M	54.4u	1.430m	-	664.4m
2	1	11M	70.3u	-	-	93.36m
3	2	15M	53.8u	1.549m	-	705.9m
4	1	19M	89.1u	-	-	737.9m
5	1	19M	78.1u	-	-	668.8m
6	1	17M	87.7u	-	-	49.92m
7	3	13M	74.5u	1.821m	1.395m	54.93m
8	1	5M	90.2u	-	-	697.7m
9	2	7M	65.2u	1.209m	-	199.5m

10	3	6M	64.3u	1.151m	1.895m	481.0m
11	2	16M	77.9u	1.130m	-	94.08m
12	1	20M	98.9u	-	-	245.6m
13	3	19M	92.4u	1.889m	918.6u	635.1m
14	3	15M	64.9u	1.890m	1.419m	655.7m
15	1	14M	56.3u	-	-	561.1m
16	1	19M	59.0u	-	-	161.1m

Long Pulse Radar Test Signal						
Test Signal Name: LP_Signal_13						
Number of Bursts in Trial: 20						
Burst	Pulses per Burst	Chrip (Hz)	Pulse Width (s)	Pulse 1 to 2 Spacing (s)	Pulse 2 to 3 Spacing (s)	Start Location (s)
1	2	13M	73.9u	1.119m	-	101.8m
2	2	15M	91.5u	1.534m	-	424.2m
3	3	19M	87.7u	1.721m	1.307m	525.9m
4	1	6M	94.9u	-	-	60.92m
5	3	20M	78.0u	1.024m	1.129m	421.7m
6	2	7M	88.0u	1.035m	-	62.16m
7	1	9M	56.2u	-	-	598.4m
8	3	18M	73.9u	932.1u	1.374m	44.11m
9	1	10M	97.2u	-	-	48.91m
10	2	6M	78.9u	1.240m	-	313.8m
11	3	7M	96.3u	964.7u	1.355m	255.7m
12	3	13M	68.5u	1.855m	1.277m	170.4m
13	1	15M	76.9u	-	-	208.1m
14	1	6M	57.2u	-	-	554.0m
15	1	7M	56.4u	-	-	516.0m
16	2	9M	81.0u	1.515m	-	480.4m
17	2	10M	63.3u	1.782m	-	407.6m
18	1	13M	93.4u	-	-	80.28m
19	2	13M	52.4u	1.651m	-	377.6m
20	3	10M	92.8u	1.473m	1.254m	117.3m

Long Pulse Radar Test Signal						
Test Signal Name: LP_Signal_14						
Number of Bursts in Trial: 11						
Burst	Pulses per Burst	Chrip (Hz)	Pulse Width (s)	Pulse 1 to 2 Spacing (s)	Pulse 2 to 3 Spacing (s)	Start Location (s)
1	2	18M	51.2u	1.182m	-	1.084
2	2	16M	77.0u	1.572m	-	821.9m
3	1	8M	96.7u	-	-	323.4m
4	1	19M	94.0u	-	-	332.0m
5	2	7M	98.5u	1.762m	-	380.0m
6	2	17M	65.5u	1.819m	-	613.3m
7	1	13M	52.4u	-	-	639.9m
8	2	9M	63.2u	1.569m	-	384.5m
9	1	7M	51.1u	-	-	635.9m
10	2	6M	78.1u	1.197m	-	188.3m
11	2	9M	84.8u	1.366m	-	466.0m

Long Pulse Radar Test Signal						
Test Signal Name: LP_Signal_15						
Number of Bursts in Trial: 10						
Burst	Pulses per Burst	Chrip (Hz)	Pulse Width (s)	Pulse 1 to 2 Spacing (s)	Pulse 2 to 3 Spacing (s)	Start Location (s)
1	1	8M	90.7u	-	-	315.2m
2	1	11M	93.9u	-	-	298.6m
3	3	12M	68.3u	1.217m	1.343m	173.0m
4	2	12M	51.7u	1.331m	-	408.7m
5	3	10M	67.0u	1.843m	1.753m	679.7m
6	2	17M	94.5u	909.5u	-	871.4m
7	3	19M	86.0u	1.694m	1.153m	1.162
8	3	17M	66.1u	1.309m	1.610m	969.2m
9	1	12M	90.0u	-	-	869.6m
10	2	5M	58.5u	1.328m	-	198.8m



Long Pulse Radar Test Signal						
Test Signal Name: LP_Signal_16						
Number of Bursts in Trial: 18						
Burst	Pulses per Burst	Chrip (Hz)	Pulse Width (s)	Pulse 1 to 2 Spacing (s)	Pulse 2 to 3 Spacing (s)	Start Location (s)
1	2	16M	64.8u	1.598m	-	343.1m
2	2	8M	51.8u	1.502m	-	14.63m
3	2	16M	87.7u	1.814m	-	92.68m
4	1	17M	95.2u	-	-	127.0m
5	2	15M	67.1u	1.701m	-	432.5m
6	1	10M	94.1u	-	-	5.004m
7	2	8M	73.3u	1.373m	-	113.1m
8	2	13M	58.0u	1.202m	-	160.7m
9	2	20M	70.0u	1.922m	-	476.2m
10	2	7M	86.1u	1.120m	-	159.4m
11	3	15M	86.6u	1.514m	1.782m	443.5m
12	2	18M	55.6u	1.196m	-	292.3m
13	3	5M	91.2u	1.027m	1.290m	67.44m
14	1	9M	76.1u	-	-	33.23m
15	1	10M	59.0u	-	-	630.8m
16	2	7M	50.1u	1.092m	-	558.5m
17	2	16M	77.0u	1.129m	-	224.0m
18	2	10M	62.1u	1.508m	-	93.29m

Long Pulse Radar Test Signal						
Test Signal Name: LP_Signal_17						
Number of Bursts in Trial: 11						
Burst	Pulses per Burst	Chrip (Hz)	Pulse Width (s)	Pulse 1 to 2 Spacing (s)	Pulse 2 to 3 Spacing (s)	Start Location (s)
1	1	12M	87.3u	-	-	1.023
2	2	6M	80.3u	1.615m	-	339.3m
3	2	8M	87.4u	1.662m	-	189.9m
4	3	19M	92.0u	1.003m	1.689m	230.4m
5	2	9M	57.4u	1.033m	-	656.2m
6	2	12M	59.8u	1.630m	-	679.6m

7	1	10M	68.2u	-	-	116.1m
8	3	10M	73.9u	1.516m	1.800m	1.042
9	2	17M	67.2u	1.650m	-	1.005
10	2	6M	80.1u	998.9u	-	380.6m
11	2	13M	94.1u	1.716m	-	237.8m

Long Pulse Radar Test Signal						
Test Signal Name: LP_Signal_18						
Number of Bursts in Trial: 15						
Burst	Pulses per Burst	Chrip (Hz)	Pulse Width (s)	Pulse 1 to 2 Spacing (s)	Pulse 2 to 3 Spacing (s)	Start Location (s)
1	2	13M	79.4u	1.841m	-	469.1m
2	2	6M	55.7u	1.813m	-	369.2m
3	2	8M	80.6u	1.405m	-	720.6m
4	2	16M	86.0u	916.0u	-	475.2m
5	2	18M	55.1u	1.291m	-	336.6m
6	2	10M	81.8u	1.835m	-	86.76m
7	1	19M	76.6u	-	-	68.14m
8	3	13M	99.4u	1.062m	1.753m	291.5m
9	2	8M	60.9u	1.647m	-	278.3m
10	2	16M	81.2u	1.487m	-	46.20m
11	3	11M	60.1u	1.690m	1.442m	184.9m
12	3	7M	61.3u	1.604m	1.882m	489.2m
13	3	19M	94.6u	1.000m	1.602m	648.4m
14	2	6M	65.4u	1.304m	-	134.5m
15	1	14M	76.4u	-	-	189.3m

Long Pulse Radar Test Signal						
Test Signal Name: LP_Signal_19						
Number of Bursts in Trial: 17						
Burst	Pulses per Burst	Chrip (Hz)	Pulse Width (s)	Pulse 1 to 2 Spacing (s)	Pulse 2 to 3 Spacing (s)	Start Location (s)
1	3	13M	96.1u	1.861m	1.786m	194.1m
2	1	8M	55.4u	-	-	56.81m
3	2	6M	94.3u	1.341m	-	504.7m

4	2	13M	68.3u	1.794m	-	50.09m
5	2	6M	56.8u	1.135m	-	468.8m
6	1	6M	84.4u	-	-	174.3m
7	2	6M	72.4u	1.854m	-	629.1m
8	3	7M	90.6u	1.174m	1.392m	325.9m
9	2	12M	66.8u	1.819m	-	394.9m
10	2	12M	91.1u	1.582m	-	451.7m
11	3	13M	91.8u	1.504m	1.649m	263.4m
12	3	14M	54.3u	1.486m	1.430m	470.4m
13	3	20M	50.6u	1.692m	1.295m	562.6m
14	2	17M	77.7u	1.034m	-	630.4m
15	1	8M	99.4u	-	-	470.6m
16	1	18M	50.1u	-	-	687.6m
17	3	11M	62.8u	1.820m	1.145m	369.7m

Long Pulse Radar Test Signal						
Test Signal Name: LP_Signal_20						
Number of Bursts in Trial: 17						
Burst	Pulses per Burst	Chrip (Hz)	Pulse Width (s)	Pulse 1 to 2 Spacing (s)	Pulse 2 to 3 Spacing (s)	Start Location (s)
1	3	15M	89.3u	1.058m	1.831m	421.7m
2	2	10M	83.9u	928.1u	-	217.5m
3	3	11M	76.0u	1.701m	1.612m	446.8m
4	2	12M	90.2u	1.674m	-	596.8m
5	1	16M	51.0u	-	-	325.8m
6	1	9M	52.5u	-	-	417.6m
7	3	12M	95.1u	1.447m	1.745m	569.2m
8	2	10M	71.7u	975.3u	-	596.8m
9	2	15M	66.8u	1.702m	-	162.6m
10	3	17M	91.8u	1.088m	1.289m	676.7m
11	2	18M	74.2u	1.696m	-	359.3m
12	1	12M	67.8u	-	-	383.9m
13	3	16M	87.6u	992.4u	1.706m	72.56m
14	2	17M	50.1u	967.9u	-	543.8m
15	3	14M	81.5u	1.515m	1.880m	352.0m
16	1	9M	76.6u	-	-	136.7m

17	2	14M	69.5u	1.763m	-	632.4m
----	---	-----	-------	--------	---	--------

Long Pulse Radar Test Signal						
Test Signal Name: LP_Signal_21						
Number of Bursts in Trial: 13						
Burst	Pulses per Burst	Chrip (Hz)	Pulse Width (s)	Pulse 1 to 2 Spacing (s)	Pulse 2 to 3 Spacing (s)	Start Location (s)
1	2	14M	99.7u	920.3u	-	86.60m
2	3	18M	52.9u	1.086m	1.162m	307.8m
3	1	15M	93.4u	-	-	381.4m
4	2	16M	66.6u	1.469m	-	17.24m
5	2	9M	59.8u	1.201m	-	12.65m
6	1	14M	73.5u	-	-	870.5m
7	2	10M	94.2u	1.123m	-	42.55m
8	2	14M	57.7u	1.830m	-	550.3m
9	2	13M	79.2u	1.354m	-	411.7m
10	3	8M	69.0u	997.0u	1.435m	453.9m
11	1	19M	87.7u	-	-	180.4m
12	1	11M	86.6u	-	-	878.0m
13	3	12M	77.8u	1.017m	1.251m	766.0m

Long Pulse Radar Test Signal						
Test Signal Name: LP_Signal_22						
Number of Bursts in Trial: 9						
Burst	Pulses per Burst	Chrip (Hz)	Pulse Width (s)	Pulse 1 to 2 Spacing (s)	Pulse 2 to 3 Spacing (s)	Start Location (s)
1	2	8M	84.9u	1.446m	-	476.0m
2	2	6M	50.3u	1.732m	-	542.2m
3	1	14M	53.0u	-	-	504.5m
4	2	9M	75.4u	1.454m	-	1.035
5	2	14M	60.6u	992.4u	-	731.7m
6	3	18M	64.0u	1.914m	1.691m	801.7m
7	3	13M	75.7u	1.885m	1.608m	737.4m
8	2	20M	78.9u	1.169m	-	62.91m
9	3	17M	81.8u	943.2u	1.342m	1.306

Long Pulse Radar Test Signal						
Test Signal Name: LP_Signal_23						
Number of Bursts in Trial: 19						
Burst	Pulses per Burst	Chrip (Hz)	Pulse Width (s)	Pulse 1 to 2 Spacing (s)	Pulse 2 to 3 Spacing (s)	Start Location (s)
1	3	16M	89.1u	966.9u	1.505m	438.7m
2	1	8M	94.3u	-	-	486.4m
3	2	13M	93.0u	1.414m	-	301.7m
4	2	11M	72.0u	1.314m	-	238.4m
5	2	17M	87.8u	1.623m	-	299.6m
6	2	16M	71.7u	1.869m	-	522.5m
7	3	15M	95.9u	1.087m	1.579m	42.20m
8	3	7M	62.8u	1.206m	967.2u	138.4m
9	1	14M	56.9u	-	-	122.8m
10	2	7M	70.5u	1.692m	-	456.8m
11	3	20M	86.0u	1.515m	1.485m	211.4m
12	2	16M	89.5u	1.004m	-	265.8m
13	3	9M	56.5u	1.065m	1.739m	253.8m
14	2	7M	64.5u	979.5u	-	9.909m
15	2	11M	73.3u	1.700m	-	113.6m
16	3	20M	58.2u	1.007m	1.790m	127.1m
17	2	20M	54.2u	1.889m	-	448.0m
18	2	14M	68.8u	1.360m	-	608.1m
19	3	17M	57.0u	1.937m	994.0u	233.2m

Long Pulse Radar Test Signal						
Test Signal Name: LP_Signal_24						
Number of Bursts in Trial: 16						
Burst	Pulses per Burst	Chrip (Hz)	Pulse Width (s)	Pulse 1 to 2 Spacing (s)	Pulse 2 to 3 Spacing (s)	Start Location (s)
1	2	8M	94.6u	1.268m	-	523.9m
2	1	12M	97.8u	-	-	104.6m
3	1	16M	83.0u	-	-	636.9m
4	2	5M	99.9u	1.829m	-	313.6m
5	2	10M	95.1u	1.023m	-	726.0m

6	2	15M	52.2u	1.097m	-	451.1m
7	2	17M	96.5u	947.5u	-	725.1m
8	3	7M	57.5u	1.839m	1.002m	306.8m
9	2	15M	74.5u	1.355m	-	458.1m
10	1	8M	77.7u	-	-	405.0m
11	2	12M	67.0u	1.875m	-	253.3m
12	3	13M	70.3u	1.828m	1.769m	574.9m
13	3	15M	80.7u	1.376m	1.639m	573.9m
14	3	18M	70.5u	1.868m	1.722m	299.5m
15	2	10M	95.3u	1.555m	-	307.8m
16	2	12M	77.3u	1.381m	-	225.0m

Long Pulse Radar Test Signal						
Test Signal Name: LP_Signal_25						
Number of Bursts in Trial: 19						
Burst	Pulses per Burst	Chrip (Hz)	Pulse Width (s)	Pulse 1 to 2 Spacing (s)	Pulse 2 to 3 Spacing (s)	Start Location (s)
1	3	9M	95.0u	1.018m	1.019m	229.9m
2	2	6M	86.5u	1.215m	-	348.2m
3	1	6M	78.6u	-	-	519.7m
4	1	17M	87.1u	-	-	468.9m
5	2	6M	50.6u	1.848m	-	19.81m
6	1	18M	93.3u	-	-	470.0m
7	2	8M	67.2u	1.374m	-	186.9m
8	3	18M	61.0u	1.520m	1.595m	173.8m
9	3	20M	63.6u	1.250m	1.784m	550.6m
10	3	9M	51.1u	949.9u	1.486m	180.0m
11	2	11M	56.8u	1.803m	-	324.5m
12	3	19M	77.6u	1.269m	962.4u	395.7m
13	2	7M	89.6u	984.4u	-	593.9m
14	1	6M	66.6u	-	-	159.7m
15	2	9M	73.4u	1.909m	-	52.42m
16	2	9M	54.6u	1.828m	-	56.08m
17	2	13M	58.6u	1.104m	-	176.9m
18	1	20M	72.4u	-	-	169.4m
19	2	8M	62.6u	1.046m	-	339.2m

Long Pulse Radar Test Signal						
Test Signal Name: LP_Signal_26						
Number of Bursts in Trial: 13						
Burst	Pulses per Burst	Chrip (Hz)	Pulse Width (s)	Pulse 1 to 2 Spacing (s)	Pulse 2 to 3 Spacing (s)	Start Location (s)
1	2	11M	75.6u	1.794m	-	12.48m
2	2	18M	92.5u	1.378m	-	737.1m
3	1	7M	58.1u	-	-	853.5m
4	2	13M	56.9u	1.090m	-	836.9m
5	1	6M	91.2u	-	-	344.9m
6	3	9M	80.8u	1.354m	1.472m	509.4m
7	2	19M	62.6u	1.618m	-	219.4m
8	2	6M	68.1u	1.446m	-	590.0m
9	2	9M	93.9u	1.085m	-	32.98m
10	1	7M	99.7u	-	-	698.6m
11	2	16M	69.3u	1.247m	-	269.3m
12	3	19M	63.8u	1.698m	1.670m	821.3m
13	2	7M	92.4u	1.835m	-	811.2m

Long Pulse Radar Test Signal						
Test Signal Name: LP_Signal_27						
Number of Bursts in Trial: 12						
Burst	Pulses per Burst	Chrip (Hz)	Pulse Width (s)	Pulse 1 to 2 Spacing (s)	Pulse 2 to 3 Spacing (s)	Start Location (s)
1	2	17M	99.0u	1.611m	-	688.2m
2	2	7M	86.0u	1.366m	-	62.34m
3	1	18M	76.8u	-	-	742.7m
4	1	12M	53.3u	-	-	702.9m
5	2	10M	61.3u	1.056m	-	963.1m
6	2	12M	92.1u	1.264m	-	523.9m
7	2	13M	71.9u	1.648m	-	228.1m
8	2	14M	50.9u	1.543m	-	132.5m
9	2	19M	82.8u	1.272m	-	404.6m
10	2	12M	54.3u	1.944m	-	608.1m

11	3	13M	83.8u	1.452m	1.636m	826.1m
12	2	15M	56.3u	1.499m	-	623.9m

Long Pulse Radar Test Signal						
Test Signal Name: LP_Signal_28						
Number of Bursts in Trial: 8						
Burst	Pulses per Burst	Chrip (Hz)	Pulse Width (s)	Pulse 1 to 2 Spacing (s)	Pulse 2 to 3 Spacing (s)	Start Location (s)
1	2	19M	68.8u	1.927m	-	1.385
2	1	19M	52.8u	-	-	580.2m
3	2	14M	57.0u	1.516m	-	986.0m
4	2	7M	66.1u	1.743m	-	467.6m
5	2	19M	57.5u	1.188m	-	1.044
6	3	19M	83.3u	928.7u	1.582m	842.1m
7	2	17M	72.0u	1.153m	-	1.214
8	3	5M	77.7u	1.249m	1.125m	723.3m

Long Pulse Radar Test Signal						
Test Signal Name: LP_Signal_29						
Number of Bursts in Trial: 12						
Burst	Pulses per Burst	Chrip (Hz)	Pulse Width (s)	Pulse 1 to 2 Spacing (s)	Pulse 2 to 3 Spacing (s)	Start Location (s)
1	1	11M	86.2u	-	-	13.85m
2	1	11M	86.6u	-	-	636.0m
3	1	9M	62.4u	-	-	264.7m
4	3	16M	96.9u	1.068m	1.642m	225.8m
5	2	16M	82.4u	1.474m	-	228.9m
6	1	9M	77.8u	-	-	113.5m
7	1	12M	68.0u	-	-	451.6m
8	2	5M	92.6u	1.650m	-	780.2m
9	1	18M	84.5u	-	-	367.4m
10	2	13M	98.1u	1.592m	-	865.2m
11	2	6M	89.6u	1.833m	-	563.1m
12	2	17M	66.1u	994.9u	-	912.8m



Long Pulse Radar Test Signal						
Test Signal Name: LP_Signal_30						
Number of Bursts in Trial: 14						
Burst	Pulses per Burst	Chrip (Hz)	Pulse Width (s)	Pulse 1 to 2 Spacing (s)	Pulse 2 to 3 Spacing (s)	Start Location (s)
1	3	12M	58.7u	1.625m	1.220m	521.4m
2	2	17M	76.1u	1.396m	-	610.0m
3	1	8M	86.3u	-	-	489.5m
4	3	19M	70.9u	1.508m	1.758m	325.5m
5	2	8M	70.0u	1.274m	-	705.7m
6	2	19M	75.9u	1.809m	-	247.5m
7	1	17M	81.2u	-	-	747.4m
8	2	8M	54.1u	1.498m	-	526.3m
9	3	17M	71.6u	1.521m	1.814m	636.4m
10	2	13M	97.7u	1.237m	-	220.0m
11	1	19M	87.0u	-	-	186.7m
12	2	7M	76.8u	1.736m	-	591.9m
13	2	20M	51.4u	1.174m	-	32.57m
14	1	7M	53.0u	-	-	516.1m

Type 6 Radar Statistical Performances				
Trial #	Pulses per Burst	Pulse Width (s)	PRI (s)	Detection
1	9	1.0u	333.0u	Yes
2	9	1.0u	333.0u	Yes
3	9	1.0u	333.0u	Yes
4	9	1.0u	333.0u	Yes
5	9	1.0u	333.0u	Yes
6	9	1.0u	333.0u	Yes
7	9	1.0u	333.0u	Yes
8	9	1.0u	333.0u	Yes
9	9	1.0u	333.0u	Yes
10	9	1.0u	333.0u	Yes
11	9	1.0u	333.0u	Yes
12	9	1.0u	333.0u	Yes
13	9	1.0u	333.0u	Yes
14	9	1.0u	333.0u	Yes
15	9	1.0u	333.0u	Yes
16	9	1.0u	333.0u	Yes
17	9	1.0u	333.0u	Yes
18	9	1.0u	333.0u	Yes
19	9	1.0u	333.0u	Yes
20	9	1.0u	333.0u	Yes
21	9	1.0u	333.0u	Yes
22	9	1.0u	333.0u	Yes
23	9	1.0u	333.0u	Yes
24	9	1.0u	333.0u	Yes
25	9	1.0u	333.0u	Yes
26	9	1.0u	333.0u	Yes
27	9	1.0u	333.0u	Yes
28	9	1.0u	333.0u	Yes
29	9	1.0u	333.0u	Yes
30	9	1.0u	333.0u	Yes
			Detection Rate: 100.0 %	

Type 6 Radar Statistical Performances		
Trial #	Hopping Frequency Sequence Name	Detection
1	HOP_FREQ_SEQ_01	Yes
2	HOP_FREQ_SEQ_02	Yes
3	HOP_FREQ_SEQ_03	Yes
4	HOP_FREQ_SEQ_04	Yes
5	HOP_FREQ_SEQ_05	Yes
6	HOP_FREQ_SEQ_06	Yes
7	HOP_FREQ_SEQ_07	Yes
8	HOP_FREQ_SEQ_08	Yes
9	HOP_FREQ_SEQ_09	Yes
10	HOP_FREQ_SEQ_10	Yes
11	HOP_FREQ_SEQ_11	Yes
12	HOP_FREQ_SEQ_12	Yes
13	HOP_FREQ_SEQ_13	Yes
14	HOP_FREQ_SEQ_14	Yes
15	HOP_FREQ_SEQ_15	Yes
16	HOP_FREQ_SEQ_16	Yes
17	HOP_FREQ_SEQ_17	Yes
18	HOP_FREQ_SEQ_18	Yes
19	HOP_FREQ_SEQ_19	Yes
20	HOP_FREQ_SEQ_20	Yes
21	HOP_FREQ_SEQ_21	Yes
22	HOP_FREQ_SEQ_22	Yes
23	HOP_FREQ_SEQ_23	Yes
24	HOP_FREQ_SEQ_24	Yes
25	HOP_FREQ_SEQ_25	Yes
26	HOP_FREQ_SEQ_26	Yes
27	HOP_FREQ_SEQ_27	Yes
28	HOP_FREQ_SEQ_28	Yes
29	HOP_FREQ_SEQ_29	Yes
30	HOP_FREQ_SEQ_30	Yes
		Detection Rate: 100.0 %

Hopping Frequency Sequence Name: HOP_FREQ_SEQ_01							
SEQ#	Frequency (Hz)	SEQ#	Frequency (Hz)	SEQ#	Frequency (Hz)	SEQ#	Frequency (Hz)
1	5.584G	2	5.650G	3	5.556G	4	5.372G
5	5.441G	6	5.637G	7	5.635G	8	5.288G
9	5.697G	10	5.412G	11	5.323G	12	5.452G
13	5.659G	14	5.460G	15	5.641G	16	5.681G
17	5.374G	18	5.301G	19	5.510G	20	5.468G
21	5.585G	22	5.486G	23	5.314G	24	5.677G
25	5.655G	26	5.570G	27	5.687G	28	5.675G
29	5.572G	30	5.583G	31	5.505G	32	5.698G
33	5.350G	34	5.551G	35	5.597G	36	5.707G
37	5.333G	38	5.617G	39	5.259G	40	5.663G
41	5.620G	42	5.398G	43	5.366G	44	5.685G
45	5.516G	46	5.630G	47	5.633G	48	5.445G
49	5.458G	50	5.345G	51	5.680G	52	5.592G
53	5.396G	54	5.463G	55	5.469G	56	5.672G
57	5.518G	58	5.648G	59	5.435G	60	5.297G
61	5.332G	62	5.526G	63	5.586G	64	5.609G
65	5.657G	66	5.430G	67	5.274G	68	5.471G
69	5.310G	70	5.504G	71	5.673G	72	5.281G
73	5.682G	74	5.498G	75	5.688G	76	5.544G
77	5.712G	78	5.634G	79	5.608G	80	5.282G
81	5.631G	82	5.415G	83	5.699G	84	5.360G
85	5.283G	86	5.316G	87	5.472G	88	5.449G
89	5.694G	90	5.269G	91	5.700G	92	5.294G
93	5.692G	94	5.286G	95	5.501G	96	5.689G
97	5.324G	98	5.588G	99	5.536G	100	5.579G

Hopping Frequency Sequence Name: HOP_FREQ_SEQ_02							
SEQ#	Frequency (Hz)	SEQ#	Frequency (Hz)	SEQ#	Frequency (Hz)	SEQ#	Frequency (Hz)
1	5.346G	2	5.501G	3	5.272G	4	5.295G
5	5.403G	6	5.712G	7	5.613G	8	5.429G
9	5.263G	10	5.351G	11	5.476G	12	5.323G
13	5.606G	14	5.355G	15	5.603G	16	5.402G

17	5.721G	18	5.330G	19	5.557G	20	5.354G
21	5.315G	22	5.465G	23	5.590G	24	5.704G
25	5.551G	26	5.303G	27	5.638G	28	5.493G
29	5.480G	30	5.709G	31	5.438G	32	5.255G
33	5.344G	34	5.256G	35	5.651G	36	5.460G
37	5.660G	38	5.343G	39	5.277G	40	5.436G
41	5.658G	42	5.370G	43	5.286G	44	5.446G
45	5.655G	46	5.517G	47	5.394G	48	5.360G
49	5.648G	50	5.425G	51	5.612G	52	5.620G
53	5.592G	54	5.570G	55	5.518G	56	5.298G
57	5.632G	58	5.600G	59	5.448G	60	5.258G
61	5.487G	62	5.701G	63	5.297G	64	5.449G
65	5.691G	66	5.450G	67	5.565G	68	5.348G
69	5.679G	70	5.629G	71	5.380G	72	5.453G
73	5.584G	74	5.335G	75	5.591G	76	5.705G
77	5.398G	78	5.270G	79	5.622G	80	5.514G
81	5.434G	82	5.369G	83	5.485G	84	5.301G
85	5.345G	86	5.618G	87	5.452G	88	5.441G
89	5.474G	90	5.250G	91	5.616G	92	5.710G
93	5.468G	94	5.513G	95	5.692G	96	5.334G
97	5.504G	98	5.347G	99	5.280G	100	5.400G

Hopping Frequency Sequence Name: HOP_FREQ_SEQ_03							
SEQ#	Frequency (Hz)	SEQ#	Frequency (Hz)	SEQ#	Frequency (Hz)	SEQ#	Frequency (Hz)
1	5.520G	2	5.463G	3	5.410G	4	5.684G
5	5.482G	6	5.448G	7	5.370G	8	5.610G
9	5.413G	10	5.667G	11	5.326G	12	5.381G
13	5.443G	14	5.583G	15	5.334G	16	5.642G
17	5.414G	18	5.457G	19	5.385G	20	5.412G
21	5.382G	22	5.578G	23	5.670G	24	5.465G
25	5.483G	26	5.257G	27	5.323G	28	5.674G
29	5.536G	30	5.384G	31	5.596G	32	5.722G
33	5.269G	34	5.643G	35	5.560G	36	5.628G
37	5.580G	38	5.415G	39	5.369G	40	5.636G
41	5.660G	42	5.477G	43	5.678G	44	5.492G
45	5.624G	46	5.337G	47	5.400G	48	5.698G

49	5.640G	50	5.260G	51	5.564G	52	5.403G
53	5.427G	54	5.627G	55	5.350G	56	5.611G
57	5.566G	58	5.691G	59	5.358G	60	5.648G
61	5.262G	62	5.429G	63	5.378G	64	5.590G
65	5.393G	66	5.278G	67	5.718G	68	5.312G
69	5.529G	70	5.305G	71	5.552G	72	5.650G
73	5.454G	74	5.330G	75	5.422G	76	5.341G
77	5.356G	78	5.485G	79	5.551G	80	5.588G
81	5.544G	82	5.716G	83	5.304G	84	5.659G
85	5.277G	86	5.703G	87	5.472G	88	5.575G
89	5.537G	90	5.294G	91	5.690G	92	5.380G
93	5.614G	94	5.362G	95	5.423G	96	5.311G
97	5.637G	98	5.540G	99	5.270G	100	5.302G

Hopping Frequency Sequence Name: HOP_FREQ_SEQ_04							
SEQ#	Frequency (Hz)	SEQ#	Frequency (Hz)	SEQ#	Frequency (Hz)	SEQ#	Frequency (Hz)
1	5.397G	2	5.383G	3	5.462G	4	5.338G
5	5.267G	6	5.261G	7	5.454G	8	5.500G
9	5.603G	10	5.568G	11	5.328G	12	5.467G
13	5.629G	14	5.612G	15	5.544G	16	5.375G
17	5.325G	18	5.507G	19	5.514G	20	5.433G
21	5.718G	22	5.526G	23	5.497G	24	5.520G
25	5.555G	26	5.389G	27	5.628G	28	5.511G
29	5.435G	30	5.424G	31	5.319G	32	5.453G
33	5.493G	34	5.311G	35	5.641G	36	5.415G
37	5.547G	38	5.655G	39	5.711G	40	5.579G
41	5.702G	42	5.260G	43	5.336G	44	5.278G
45	5.314G	46	5.587G	47	5.688G	48	5.598G
49	5.443G	50	5.719G	51	5.291G	52	5.428G
53	5.441G	54	5.377G	55	5.385G	56	5.315G
57	5.609G	58	5.274G	59	5.409G	60	5.546G
61	5.431G	62	5.288G	63	5.324G	64	5.341G
65	5.376G	66	5.689G	67	5.541G	68	5.422G
69	5.695G	70	5.679G	71	5.618G	72	5.465G
73	5.255G	74	5.590G	75	5.634G	76	5.388G
77	5.406G	78	5.420G	79	5.309G	80	5.362G

81	5.425G	82	5.605G	83	5.624G	84	5.374G
85	5.366G	86	5.360G	87	5.645G	88	5.297G
89	5.556G	90	5.554G	91	5.351G	92	5.596G
93	5.302G	94	5.470G	95	5.654G	96	5.299G
97	5.481G	98	5.606G	99	5.487G	100	5.343G

Hopping Frequency Sequence Name: HOP_FREQ_SEQ_05							
SEQ#	Frequency (Hz)	SEQ#	Frequency (Hz)	SEQ#	Frequency (Hz)	SEQ#	Frequency (Hz)
1	5.421G	2	5.644G	3	5.275G	4	5.412G
5	5.320G	6	5.350G	7	5.652G	8	5.620G
9	5.548G	10	5.601G	11	5.640G	12	5.450G
13	5.582G	14	5.702G	15	5.311G	16	5.349G
17	5.489G	18	5.605G	19	5.698G	20	5.407G
21	5.478G	22	5.545G	23	5.267G	24	5.658G
25	5.376G	26	5.707G	27	5.592G	28	5.696G
29	5.655G	30	5.504G	31	5.271G	32	5.416G
33	5.667G	34	5.673G	35	5.347G	36	5.700G
37	5.307G	38	5.723G	39	5.357G	40	5.522G
41	5.417G	42	5.257G	43	5.383G	44	5.419G
45	5.714G	46	5.393G	47	5.261G	48	5.508G
49	5.485G	50	5.260G	51	5.318G	52	5.628G
53	5.278G	54	5.430G	55	5.520G	56	5.392G
57	5.358G	58	5.270G	59	5.627G	60	5.557G
61	5.558G	62	5.305G	63	5.526G	64	5.314G
65	5.528G	66	5.555G	67	5.540G	68	5.380G
69	5.573G	70	5.268G	71	5.459G	72	5.482G
73	5.653G	74	5.353G	75	5.306G	76	5.324G
77	5.497G	78	5.693G	79	5.362G	80	5.514G
81	5.581G	82	5.415G	83	5.368G	84	5.599G
85	5.291G	86	5.704G	87	5.503G	88	5.564G
89	5.611G	90	5.634G	91	5.560G	92	5.300G
93	5.646G	94	5.561G	95	5.692G	96	5.633G
97	5.635G	98	5.492G	99	5.312G	100	5.690G

Hopping Frequency Sequence Name: HOP_FREQ_SEQ_06							
SEQ#	Frequency (Hz)	SEQ#	Frequency (Hz)	SEQ#	Frequency (Hz)	SEQ#	Frequency (Hz)
1	5.510G	2	5.475G	3	5.466G	4	5.512G
5	5.665G	6	5.493G	7	5.595G	8	5.412G
9	5.488G	10	5.435G	11	5.408G	12	5.263G
13	5.569G	14	5.713G	15	5.269G	16	5.687G
17	5.554G	18	5.392G	19	5.455G	20	5.592G
21	5.264G	22	5.670G	23	5.660G	24	5.614G
25	5.715G	26	5.560G	27	5.591G	28	5.461G
29	5.290G	30	5.278G	31	5.714G	32	5.365G
33	5.650G	34	5.307G	35	5.432G	36	5.641G
37	5.490G	38	5.417G	39	5.265G	40	5.457G
41	5.367G	42	5.598G	43	5.308G	44	5.669G
45	5.287G	46	5.413G	47	5.312G	48	5.389G
49	5.495G	50	5.530G	51	5.532G	52	5.525G
53	5.697G	54	5.619G	55	5.494G	56	5.577G
57	5.563G	58	5.342G	59	5.288G	60	5.313G
61	5.513G	62	5.636G	63	5.316G	64	5.428G
65	5.304G	66	5.326G	67	5.681G	68	5.584G
69	5.272G	70	5.363G	71	5.460G	72	5.468G
73	5.710G	74	5.362G	75	5.722G	76	5.262G
77	5.385G	78	5.482G	79	5.336G	80	5.390G
81	5.688G	82	5.277G	83	5.407G	84	5.393G
85	5.334G	86	5.372G	87	5.422G	88	5.322G
89	5.581G	90	5.559G	91	5.346G	92	5.380G
93	5.515G	94	5.258G	95	5.606G	96	5.406G
97	5.564G	98	5.444G	99	5.613G	100	5.526G

Hopping Frequency Sequence Name: HOP_FREQ_SEQ_07							
SEQ#	Frequency (Hz)	SEQ#	Frequency (Hz)	SEQ#	Frequency (Hz)	SEQ#	Frequency (Hz)
1	5.551G	2	5.676G	3	5.484G	4	5.572G
5	5.380G	6	5.718G	7	5.660G	8	5.644G
9	5.397G	10	5.438G	11	5.410G	12	5.256G



13	5.538G	14	5.542G	15	5.550G	16	5.480G
17	5.413G	18	5.461G	19	5.463G	20	5.369G
21	5.640G	22	5.383G	23	5.375G	24	5.488G
25	5.570G	26	5.281G	27	5.613G	28	5.282G
29	5.310G	30	5.273G	31	5.724G	32	5.622G
33	5.633G	34	5.267G	35	5.715G	36	5.523G
37	5.632G	38	5.620G	39	5.567G	40	5.589G
41	5.318G	42	5.263G	43	5.378G	44	5.716G
45	5.289G	46	5.568G	47	5.710G	48	5.516G
49	5.606G	50	5.337G	51	5.283G	52	5.717G
53	5.424G	54	5.651G	55	5.711G	56	5.707G
57	5.698G	58	5.462G	59	5.518G	60	5.445G
61	5.360G	62	5.653G	63	5.307G	64	5.341G
65	5.581G	66	5.457G	67	5.601G	68	5.345G
69	5.658G	70	5.431G	71	5.648G	72	5.253G
73	5.683G	74	5.384G	75	5.398G	76	5.459G
77	5.254G	78	5.607G	79	5.301G	80	5.417G
81	5.347G	82	5.643G	83	5.712G	84	5.514G
85	5.576G	86	5.610G	87	5.386G	88	5.381G
89	5.476G	90	5.680G	91	5.272G	92	5.477G
93	5.565G	94	5.450G	95	5.414G	96	5.343G
97	5.497G	98	5.405G	99	5.503G	100	5.577G

Hopping Frequency Sequence Name: HOP_FREQ_SEQ_08							
SEQ#	Frequency (Hz)	SEQ#	Frequency (Hz)	SEQ#	Frequency (Hz)	SEQ#	Frequency (Hz)
1	5.452G	2	5.443G	3	5.458G	4	5.492G
5	5.281G	6	5.280G	7	5.290G	8	5.685G
9	5.655G	10	5.636G	11	5.369G	12	5.320G
13	5.272G	14	5.644G	15	5.250G	16	5.695G
17	5.303G	18	5.268G	19	5.384G	20	5.351G
21	5.620G	22	5.588G	23	5.447G	24	5.283G
25	5.658G	26	5.566G	27	5.457G	28	5.476G
29	5.626G	30	5.325G	31	5.679G	32	5.590G
33	5.282G	34	5.538G	35	5.269G	36	5.539G
37	5.408G	38	5.400G	39	5.604G	40	5.371G
41	5.520G	42	5.499G	43	5.274G	44	5.352G

45	5.436G	46	5.505G	47	5.394G	48	5.617G
49	5.330G	50	5.652G	51	5.700G	52	5.317G
53	5.592G	54	5.473G	55	5.398G	56	5.573G
57	5.393G	58	5.674G	59	5.635G	60	5.546G
61	5.370G	62	5.542G	63	5.376G	64	5.561G
65	5.385G	66	5.606G	67	5.516G	68	5.613G
69	5.701G	70	5.510G	71	5.397G	72	5.332G
73	5.642G	74	5.651G	75	5.430G	76	5.551G
77	5.560G	78	5.316G	79	5.302G	80	5.382G
81	5.714G	82	5.341G	83	5.429G	84	5.693G
85	5.523G	86	5.470G	87	5.252G	88	5.420G
89	5.266G	90	5.563G	91	5.472G	92	5.601G
93	5.273G	94	5.340G	95	5.296G	96	5.333G
97	5.441G	98	5.550G	99	5.475G	100	5.678G

Hopping Frequency Sequence Name: HOP_FREQ_SEQ_09							
SEQ#	Frequency (Hz)	SEQ#	Frequency (Hz)	SEQ#	Frequency (Hz)	SEQ#	Frequency (Hz)
1	5.618G	2	5.628G	3	5.634G	4	5.468G
5	5.711G	6	5.257G	7	5.588G	8	5.445G
9	5.625G	10	5.675G	11	5.527G	12	5.470G
13	5.707G	14	5.438G	15	5.559G	16	5.499G
17	5.388G	18	5.662G	19	5.594G	20	5.394G
21	5.354G	22	5.678G	23	5.418G	24	5.332G
25	5.696G	26	5.716G	27	5.621G	28	5.450G
29	5.348G	30	5.434G	31	5.452G	32	5.368G
33	5.382G	34	5.254G	35	5.578G	36	5.377G
37	5.269G	38	5.554G	39	5.449G	40	5.430G
41	5.383G	42	5.623G	43	5.401G	44	5.399G
45	5.550G	46	5.586G	47	5.581G	48	5.308G
49	5.512G	50	5.275G	51	5.362G	52	5.363G
53	5.576G	54	5.671G	55	5.342G	56	5.381G
57	5.284G	58	5.390G	59	5.605G	60	5.455G
61	5.503G	62	5.547G	63	5.562G	64	5.429G
65	5.704G	66	5.426G	67	5.411G	68	5.613G
69	5.584G	70	5.311G	71	5.501G	72	5.537G
73	5.451G	74	5.717G	75	5.709G	76	5.695G

77	5.303G	78	5.369G	79	5.514G	80	5.570G
81	5.665G	82	5.592G	83	5.631G	84	5.253G
85	5.622G	86	5.463G	87	5.469G	88	5.518G
89	5.437G	90	5.642G	91	5.630G	92	5.398G
93	5.491G	94	5.367G	95	5.346G	96	5.425G
97	5.414G	98	5.640G	99	5.321G	100	5.393G

Hopping Frequency Sequence Name: HOP_FREQ_SEQ_10							
SEQ#	Frequency (Hz)	SEQ#	Frequency (Hz)	SEQ#	Frequency (Hz)	SEQ#	Frequency (Hz)
1	5.314G	2	5.430G	3	5.302G	4	5.313G
5	5.617G	6	5.493G	7	5.598G	8	5.300G
9	5.712G	10	5.573G	11	5.578G	12	5.340G
13	5.359G	14	5.593G	15	5.351G	16	5.451G
17	5.354G	18	5.389G	19	5.275G	20	5.625G
21	5.515G	22	5.574G	23	5.404G	24	5.552G
25	5.426G	26	5.561G	27	5.685G	28	5.555G
29	5.592G	30	5.363G	31	5.717G	32	5.347G
33	5.252G	34	5.701G	35	5.614G	36	5.608G
37	5.671G	38	5.449G	39	5.556G	40	5.371G
41	5.373G	42	5.652G	43	5.365G	44	5.304G
45	5.537G	46	5.634G	47	5.281G	48	5.647G
49	5.324G	50	5.544G	51	5.447G	52	5.437G
53	5.400G	54	5.289G	55	5.325G	56	5.505G
57	5.603G	58	5.279G	59	5.416G	60	5.446G
61	5.326G	62	5.419G	63	5.550G	64	5.409G
65	5.605G	66	5.316G	67	5.360G	68	5.540G
69	5.370G	70	5.495G	71	5.613G	72	5.467G
73	5.362G	74	5.514G	75	5.298G	76	5.559G
77	5.380G	78	5.636G	79	5.589G	80	5.470G
81	5.551G	82	5.428G	83	5.429G	84	5.716G
85	5.361G	86	5.330G	87	5.441G	88	5.402G
89	5.271G	90	5.297G	91	5.696G	92	5.691G
93	5.376G	94	5.424G	95	5.707G	96	5.307G
97	5.435G	98	5.385G	99	5.638G	100	5.563G

Hopping Frequency Sequence Name: HOP_FREQ_SEQ_11							
SEQ#	Frequency (Hz)	SEQ#	Frequency (Hz)	SEQ#	Frequency (Hz)	SEQ#	Frequency (Hz)
1	5.583G	2	5.494G	3	5.698G	4	5.598G
5	5.625G	6	5.370G	7	5.326G	8	5.606G
9	5.498G	10	5.328G	11	5.694G	12	5.709G
13	5.613G	14	5.481G	15	5.418G	16	5.677G
17	5.448G	18	5.343G	19	5.357G	20	5.554G
21	5.659G	22	5.396G	23	5.303G	24	5.419G
25	5.362G	26	5.428G	27	5.469G	28	5.268G
29	5.394G	30	5.492G	31	5.663G	32	5.720G
33	5.567G	34	5.356G	35	5.635G	36	5.372G
37	5.386G	38	5.345G	39	5.600G	40	5.412G
41	5.258G	42	5.411G	43	5.301G	44	5.618G
45	5.699G	46	5.604G	47	5.463G	48	5.542G
49	5.680G	50	5.670G	51	5.368G	52	5.589G
53	5.553G	54	5.515G	55	5.446G	56	5.304G
57	5.441G	58	5.424G	59	5.620G	60	5.263G
61	5.592G	62	5.629G	63	5.466G	64	5.556G
65	5.636G	66	5.722G	67	5.302G	68	5.656G
69	5.252G	70	5.286G	71	5.369G	72	5.723G
73	5.573G	74	5.569G	75	5.558G	76	5.250G
77	5.500G	78	5.457G	79	5.462G	80	5.562G
81	5.716G	82	5.614G	83	5.347G	84	5.565G
85	5.288G	86	5.627G	87	5.342G	88	5.696G
89	5.712G	90	5.337G	91	5.649G	92	5.538G
93	5.688G	94	5.549G	95	5.272G	96	5.447G
97	5.519G	98	5.323G	99	5.314G	100	5.706G

Hopping Frequency Sequence Name: HOP_FREQ_SEQ_12							
SEQ#	Frequency (Hz)	SEQ#	Frequency (Hz)	SEQ#	Frequency (Hz)	SEQ#	Frequency (Hz)
1	5.511G	2	5.597G	3	5.289G	4	5.670G
5	5.617G	6	5.438G	7	5.491G	8	5.682G
9	5.526G	10	5.298G	11	5.352G	12	5.714G

13	5.689G	14	5.688G	15	5.360G	16	5.431G
17	5.530G	18	5.549G	19	5.478G	20	5.411G
21	5.658G	22	5.356G	23	5.265G	24	5.345G
25	5.520G	26	5.624G	27	5.562G	28	5.674G
29	5.284G	30	5.707G	31	5.464G	32	5.502G
33	5.315G	34	5.297G	35	5.639G	36	5.469G
37	5.407G	38	5.353G	39	5.542G	40	5.458G
41	5.545G	42	5.367G	43	5.569G	44	5.687G
45	5.680G	46	5.722G	47	5.312G	48	5.465G
49	5.574G	50	5.319G	51	5.648G	52	5.702G
53	5.664G	54	5.515G	55	5.613G	56	5.504G
57	5.662G	58	5.251G	59	5.322G	60	5.448G
61	5.395G	62	5.582G	63	5.350G	64	5.563G
65	5.508G	66	5.261G	67	5.577G	68	5.393G
69	5.280G	70	5.374G	71	5.380G	72	5.519G
73	5.460G	74	5.587G	75	5.720G	76	5.653G
77	5.611G	78	5.657G	79	5.596G	80	5.642G
81	5.684G	82	5.604G	83	5.538G	84	5.415G
85	5.692G	86	5.423G	87	5.258G	88	5.336G
89	5.436G	90	5.349G	91	5.287G	92	5.427G
93	5.283G	94	5.711G	95	5.316G	96	5.638G
97	5.507G	98	5.691G	99	5.399G	100	5.610G

Hopping Frequency Sequence Name: HOP_FREQ_SEQ_13							
SEQ#	Frequency (Hz)	SEQ#	Frequency (Hz)	SEQ#	Frequency (Hz)	SEQ#	Frequency (Hz)
1	5.524G	2	5.546G	3	5.257G	4	5.323G
5	5.303G	6	5.498G	7	5.585G	8	5.653G
9	5.540G	10	5.413G	11	5.482G	12	5.462G
13	5.296G	14	5.656G	15	5.626G	16	5.631G
17	5.567G	18	5.711G	19	5.418G	20	5.374G
21	5.666G	22	5.623G	23	5.382G	24	5.408G
25	5.615G	26	5.394G	27	5.593G	28	5.657G
29	5.441G	30	5.395G	31	5.714G	32	5.607G
33	5.254G	34	5.612G	35	5.677G	36	5.717G
37	5.684G	38	5.660G	39	5.273G	40	5.415G
41	5.351G	42	5.484G	43	5.673G	44	5.610G

45	5.442G	46	5.478G	47	5.661G	48	5.563G
49	5.560G	50	5.617G	51	5.463G	52	5.459G
53	5.469G	54	5.417G	55	5.525G	56	5.555G
57	5.493G	58	5.371G	59	5.516G	60	5.663G
61	5.347G	62	5.288G	63	5.580G	64	5.350G
65	5.378G	66	5.700G	67	5.597G	68	5.324G
69	5.458G	70	5.471G	71	5.538G	72	5.599G
73	5.426G	74	5.310G	75	5.688G	76	5.333G
77	5.475G	78	5.258G	79	5.419G	80	5.701G
81	5.600G	82	5.590G	83	5.690G	84	5.528G
85	5.362G	86	5.342G	87	5.502G	88	5.414G
89	5.457G	90	5.297G	91	5.357G	92	5.509G
93	5.274G	94	5.451G	95	5.328G	96	5.539G
97	5.596G	98	5.479G	99	5.474G	100	5.284G

Hopping Frequency Sequence Name: HOP_FREQ_SEQ_14							
SEQ#	Frequency (Hz)	SEQ#	Frequency (Hz)	SEQ#	Frequency (Hz)	SEQ#	Frequency (Hz)
1	5.284G	2	5.688G	3	5.520G	4	5.344G
5	5.339G	6	5.657G	7	5.545G	8	5.607G
9	5.538G	10	5.297G	11	5.658G	12	5.600G
13	5.460G	14	5.285G	15	5.398G	16	5.264G
17	5.303G	18	5.465G	19	5.708G	20	5.443G
21	5.421G	22	5.630G	23	5.386G	24	5.357G
25	5.723G	26	5.684G	27	5.483G	28	5.551G
29	5.529G	30	5.275G	31	5.381G	32	5.444G
33	5.639G	34	5.345G	35	5.326G	36	5.506G
37	5.531G	38	5.679G	39	5.355G	40	5.649G
41	5.560G	42	5.377G	43	5.331G	44	5.428G
45	5.575G	46	5.500G	47	5.509G	48	5.656G
49	5.693G	50	5.376G	51	5.434G	52	5.327G
53	5.542G	54	5.368G	55	5.321G	56	5.349G
57	5.389G	58	5.353G	59	5.606G	60	5.494G
61	5.315G	62	5.568G	63	5.559G	64	5.278G
65	5.680G	66	5.288G	67	5.557G	68	5.405G
69	5.589G	70	5.634G	71	5.721G	72	5.350G
73	5.485G	74	5.481G	75	5.433G	76	5.296G

77	5.691G	78	5.544G	79	5.587G	80	5.599G
81	5.713G	82	5.632G	83	5.676G	84	5.307G
85	5.497G	86	5.328G	87	5.653G	88	5.578G
89	5.332G	90	5.608G	91	5.310G	92	5.445G
93	5.419G	94	5.576G	95	5.503G	96	5.549G
97	5.322G	98	5.683G	99	5.707G	100	5.698G

Hopping Frequency Sequence Name: HOP_FREQ_SEQ_15							
SEQ#	Frequency (Hz)	SEQ#	Frequency (Hz)	SEQ#	Frequency (Hz)	SEQ#	Frequency (Hz)
1	5.522G	2	5.425G	3	5.421G	4	5.722G
5	5.369G	6	5.553G	7	5.395G	8	5.265G
9	5.669G	10	5.543G	11	5.266G	12	5.490G
13	5.724G	14	5.250G	15	5.405G	16	5.579G
17	5.520G	18	5.608G	19	5.686G	20	5.404G
21	5.494G	22	5.560G	23	5.446G	24	5.367G
25	5.545G	26	5.388G	27	5.350G	28	5.402G
29	5.640G	30	5.286G	31	5.273G	32	5.680G
33	5.256G	34	5.292G	35	5.308G	36	5.481G
37	5.304G	38	5.600G	39	5.397G	40	5.299G
41	5.386G	42	5.586G	43	5.602G	44	5.444G
45	5.684G	46	5.505G	47	5.723G	48	5.613G
49	5.532G	50	5.319G	51	5.595G	52	5.370G
53	5.318G	54	5.314G	55	5.487G	56	5.531G
57	5.604G	58	5.272G	59	5.572G	60	5.598G
61	5.384G	62	5.591G	63	5.619G	64	5.695G
65	5.372G	66	5.452G	67	5.443G	68	5.269G
69	5.462G	70	5.568G	71	5.346G	72	5.422G
73	5.257G	74	5.523G	75	5.671G	76	5.307G
77	5.361G	78	5.416G	79	5.433G	80	5.617G
81	5.398G	82	5.351G	83	5.485G	84	5.650G
85	5.347G	86	5.334G	87	5.442G	88	5.276G
89	5.392G	90	5.360G	91	5.456G	92	5.468G
93	5.309G	94	5.328G	95	5.497G	96	5.337G
97	5.294G	98	5.261G	99	5.557G	100	5.665G

Hopping Frequency Sequence Name: HOP_FREQ_SEQ_16							
SEQ#	Frequency (Hz)	SEQ#	Frequency (Hz)	SEQ#	Frequency (Hz)	SEQ#	Frequency (Hz)
1	5.587G	2	5.395G	3	5.533G	4	5.319G
5	5.473G	6	5.361G	7	5.697G	8	5.549G
9	5.680G	10	5.507G	11	5.526G	12	5.374G
13	5.377G	14	5.723G	15	5.444G	16	5.457G
17	5.347G	18	5.517G	19	5.313G	20	5.412G
21	5.720G	22	5.719G	23	5.380G	24	5.410G
25	5.692G	26	5.323G	27	5.466G	28	5.506G
29	5.386G	30	5.286G	31	5.643G	32	5.681G
33	5.370G	34	5.333G	35	5.476G	36	5.498G
37	5.655G	38	5.368G	39	5.612G	40	5.254G
41	5.602G	42	5.627G	43	5.335G	44	5.404G
45	5.718G	46	5.656G	47	5.667G	48	5.431G
49	5.686G	50	5.651G	51	5.585G	52	5.649G
53	5.265G	54	5.474G	55	5.268G	56	5.631G
57	5.376G	58	5.260G	59	5.488G	60	5.521G
61	5.672G	62	5.618G	63	5.403G	64	5.610G
65	5.315G	66	5.556G	67	5.659G	68	5.420G
69	5.596G	70	5.270G	71	5.324G	72	5.546G
73	5.358G	74	5.675G	75	5.295G	76	5.568G
77	5.281G	78	5.630G	79	5.499G	80	5.263G
81	5.325G	82	5.541G	83	5.490G	84	5.371G
85	5.634G	86	5.464G	87	5.352G	88	5.326G
89	5.330G	90	5.606G	91	5.711G	92	5.381G
93	5.580G	94	5.280G	95	5.554G	96	5.362G
97	5.626G	98	5.510G	99	5.716G	100	5.441G

Hopping Frequency Sequence Name: HOP_FREQ_SEQ_17							
SEQ#	Frequency (Hz)	SEQ#	Frequency (Hz)	SEQ#	Frequency (Hz)	SEQ#	Frequency (Hz)
1	5.293G	2	5.283G	3	5.433G	4	5.556G
5	5.494G	6	5.344G	7	5.320G	8	5.656G
9	5.405G	10	5.606G	11	5.323G	12	5.358G
13	5.274G	14	5.521G	15	5.434G	16	5.546G



17	5.644G	18	5.487G	19	5.313G	20	5.676G
21	5.609G	22	5.297G	23	5.565G	24	5.377G
25	5.288G	26	5.397G	27	5.470G	28	5.299G
29	5.645G	30	5.292G	31	5.667G	32	5.473G
33	5.615G	34	5.513G	35	5.558G	36	5.447G
37	5.549G	38	5.362G	39	5.365G	40	5.465G
41	5.483G	42	5.370G	43	5.361G	44	5.702G
45	5.369G	46	5.723G	47	5.328G	48	5.278G
49	5.311G	50	5.539G	51	5.419G	52	5.554G
53	5.262G	54	5.379G	55	5.713G	56	5.493G
57	5.294G	58	5.603G	59	5.304G	60	5.340G
61	5.614G	62	5.350G	63	5.551G	64	5.626G
65	5.295G	66	5.671G	67	5.336G	68	5.694G
69	5.621G	70	5.540G	71	5.648G	72	5.391G
73	5.373G	74	5.682G	75	5.463G	76	5.672G
77	5.559G	78	5.477G	79	5.518G	80	5.607G
81	5.647G	82	5.442G	83	5.720G	84	5.590G
85	5.403G	86	5.580G	87	5.591G	88	5.637G
89	5.506G	90	5.411G	91	5.587G	92	5.543G
93	5.601G	94	5.455G	95	5.697G	96	5.668G
97	5.695G	98	5.271G	99	5.430G	100	5.514G

Hopping Frequency Sequence Name: HOP_FREQ_SEQ_18							
SEQ#	Frequency (Hz)	SEQ#	Frequency (Hz)	SEQ#	Frequency (Hz)	SEQ#	Frequency (Hz)
1	5.715G	2	5.594G	3	5.450G	4	5.473G
5	5.287G	6	5.338G	7	5.346G	8	5.288G
9	5.542G	10	5.306G	11	5.333G	12	5.472G
13	5.490G	14	5.551G	15	5.644G	16	5.651G
17	5.618G	18	5.434G	19	5.691G	20	5.666G
21	5.648G	22	5.558G	23	5.397G	24	5.316G
25	5.602G	26	5.545G	27	5.336G	28	5.701G
29	5.401G	30	5.582G	31	5.576G	32	5.429G
33	5.367G	34	5.527G	35	5.344G	36	5.286G
37	5.304G	38	5.660G	39	5.687G	40	5.631G
41	5.622G	42	5.677G	43	5.383G	44	5.296G
45	5.619G	46	5.503G	47	5.708G	48	5.482G

49	5.624G	50	5.599G	51	5.667G	52	5.298G
53	5.414G	54	5.349G	55	5.548G	56	5.615G
57	5.568G	58	5.424G	59	5.720G	60	5.271G
61	5.369G	62	5.559G	63	5.276G	64	5.356G
65	5.256G	66	5.681G	67	5.540G	68	5.263G
69	5.275G	70	5.629G	71	5.303G	72	5.433G
73	5.481G	74	5.523G	75	5.285G	76	5.407G
77	5.378G	78	5.512G	79	5.650G	80	5.278G
81	5.446G	82	5.546G	83	5.486G	84	5.564G
85	5.613G	86	5.390G	87	5.348G	88	5.468G
89	5.565G	90	5.518G	91	5.600G	92	5.311G
93	5.506G	94	5.484G	95	5.438G	96	5.381G
97	5.553G	98	5.364G	99	5.423G	100	5.343G

Hopping Frequency Sequence Name: HOP_FREQ_SEQ_19							
SEQ#	Frequency (Hz)	SEQ#	Frequency (Hz)	SEQ#	Frequency (Hz)	SEQ#	Frequency (Hz)
1	5.666G	2	5.487G	3	5.470G	4	5.359G
5	5.338G	6	5.472G	7	5.390G	8	5.708G
9	5.589G	10	5.366G	11	5.485G	12	5.519G
13	5.337G	14	5.659G	15	5.501G	16	5.405G
17	5.295G	18	5.369G	19	5.284G	20	5.425G
21	5.661G	22	5.447G	23	5.483G	24	5.267G
25	5.285G	26	5.549G	27	5.306G	28	5.473G
29	5.637G	30	5.578G	31	5.513G	32	5.605G
33	5.623G	34	5.573G	35	5.536G	36	5.663G
37	5.511G	38	5.479G	39	5.611G	40	5.510G
41	5.403G	42	5.301G	43	5.711G	44	5.706G
45	5.259G	46	5.554G	47	5.494G	48	5.254G
49	5.250G	50	5.497G	51	5.291G	52	5.543G
53	5.495G	54	5.376G	55	5.481G	56	5.325G
57	5.506G	58	5.697G	59	5.340G	60	5.378G
61	5.579G	62	5.558G	63	5.664G	64	5.364G
65	5.290G	66	5.467G	67	5.446G	68	5.417G
69	5.684G	70	5.700G	71	5.408G	72	5.545G
73	5.316G	74	5.305G	75	5.616G	76	5.329G
77	5.255G	78	5.601G	79	5.455G	80	5.486G

81	5.478G	82	5.383G	83	5.450G	84	5.358G
85	5.678G	86	5.407G	87	5.514G	88	5.718G
89	5.331G	90	5.468G	91	5.698G	92	5.507G
93	5.312G	94	5.719G	95	5.372G	96	5.570G
97	5.271G	98	5.528G	99	5.582G	100	5.644G

Hopping Frequency Sequence Name: HOP_FREQ_SEQ_20							
SEQ#	Frequency (Hz)	SEQ#	Frequency (Hz)	SEQ#	Frequency (Hz)	SEQ#	Frequency (Hz)
1	5.388G	2	5.645G	3	5.618G	4	5.275G
5	5.406G	6	5.363G	7	5.279G	8	5.639G
9	5.665G	10	5.617G	11	5.579G	12	5.691G
13	5.295G	14	5.602G	15	5.372G	16	5.484G
17	5.516G	18	5.345G	19	5.649G	20	5.597G
21	5.394G	22	5.404G	23	5.487G	24	5.483G
25	5.543G	26	5.722G	27	5.574G	28	5.353G
29	5.528G	30	5.522G	31	5.401G	32	5.467G
33	5.325G	34	5.585G	35	5.277G	36	5.264G
37	5.525G	38	5.586G	39	5.430G	40	5.350G
41	5.445G	42	5.635G	43	5.675G	44	5.285G
45	5.674G	46	5.307G	47	5.328G	48	5.338G
49	5.286G	50	5.540G	51	5.657G	52	5.313G
53	5.546G	54	5.370G	55	5.358G	56	5.611G
57	5.495G	58	5.410G	59	5.268G	60	5.640G
61	5.311G	62	5.513G	63	5.584G	64	5.562G
65	5.518G	66	5.572G	67	5.456G	68	5.680G
69	5.461G	70	5.348G	71	5.505G	72	5.340G
73	5.409G	74	5.699G	75	5.362G	76	5.714G
77	5.706G	78	5.684G	79	5.431G	80	5.463G
81	5.288G	82	5.418G	83	5.374G	84	5.270G
85	5.571G	86	5.414G	87	5.266G	88	5.322G
89	5.547G	90	5.272G	91	5.710G	92	5.327G
93	5.331G	94	5.282G	95	5.403G	96	5.560G
97	5.342G	98	5.321G	99	5.701G	100	5.504G

Hopping Frequency Sequence Name: HOP_FREQ_SEQ_21							
SEQ#	Frequency (Hz)	SEQ#	Frequency (Hz)	SEQ#	Frequency (Hz)	SEQ#	Frequency (Hz)
1	5.637G	2	5.337G	3	5.452G	4	5.302G
5	5.278G	6	5.606G	7	5.696G	8	5.579G
9	5.363G	10	5.285G	11	5.275G	12	5.484G
13	5.427G	14	5.468G	15	5.309G	16	5.607G
17	5.494G	18	5.684G	19	5.272G	20	5.697G
21	5.447G	22	5.367G	23	5.338G	24	5.504G
25	5.465G	26	5.381G	27	5.368G	28	5.471G
29	5.310G	30	5.455G	31	5.553G	32	5.626G
33	5.457G	34	5.420G	35	5.362G	36	5.621G
37	5.700G	38	5.599G	39	5.653G	40	5.615G
41	5.402G	42	5.379G	43	5.490G	44	5.715G
45	5.695G	46	5.595G	47	5.421G	48	5.609G
49	5.664G	50	5.642G	51	5.628G	52	5.674G
53	5.507G	54	5.617G	55	5.656G	56	5.493G
57	5.266G	58	5.714G	59	5.319G	60	5.441G
61	5.478G	62	5.444G	63	5.474G	64	5.575G
65	5.294G	66	5.282G	67	5.328G	68	5.462G
69	5.289G	70	5.724G	71	5.454G	72	5.306G
73	5.380G	74	5.332G	75	5.677G	76	5.374G
77	5.712G	78	5.387G	79	5.472G	80	5.542G
81	5.533G	82	5.426G	83	5.254G	84	5.669G
85	5.271G	86	5.577G	87	5.502G	88	5.403G
89	5.543G	90	5.571G	91	5.513G	92	5.479G
93	5.601G	94	5.482G	95	5.428G	96	5.614G
97	5.336G	98	5.372G	99	5.600G	100	5.470G

Hopping Frequency Sequence Name: HOP_FREQ_SEQ_22							
SEQ#	Frequency (Hz)	SEQ#	Frequency (Hz)	SEQ#	Frequency (Hz)	SEQ#	Frequency (Hz)
1	5.335G	2	5.570G	3	5.334G	4	5.433G
5	5.464G	6	5.451G	7	5.687G	8	5.586G
9	5.254G	10	5.634G	11	5.438G	12	5.722G
13	5.386G	14	5.607G	15	5.290G	16	5.262G

17	5.515G	18	5.441G	19	5.636G	20	5.270G
21	5.256G	22	5.279G	23	5.620G	24	5.447G
25	5.471G	26	5.417G	27	5.473G	28	5.708G
29	5.468G	30	5.362G	31	5.572G	32	5.563G
33	5.328G	34	5.601G	35	5.541G	36	5.629G
37	5.393G	38	5.667G	39	5.531G	40	5.313G
41	5.633G	42	5.403G	43	5.613G	44	5.553G
45	5.465G	46	5.716G	47	5.329G	48	5.356G
49	5.320G	50	5.391G	51	5.255G	52	5.276G
53	5.324G	54	5.271G	55	5.500G	56	5.646G
57	5.404G	58	5.265G	59	5.671G	60	5.616G
61	5.371G	62	5.606G	63	5.477G	64	5.467G
65	5.561G	66	5.359G	67	5.603G	68	5.407G
69	5.426G	70	5.715G	71	5.663G	72	5.680G
73	5.463G	74	5.274G	75	5.567G	76	5.721G
77	5.678G	78	5.657G	79	5.443G	80	5.338G
81	5.293G	82	5.325G	83	5.724G	84	5.402G
85	5.581G	86	5.478G	87	5.507G	88	5.669G
89	5.409G	90	5.495G	91	5.627G	92	5.519G
93	5.508G	94	5.322G	95	5.373G	96	5.382G
97	5.530G	98	5.589G	99	5.587G	100	5.580G

Hopping Frequency Sequence Name: HOP_FREQ_SEQ_23							
SEQ#	Frequency (Hz)	SEQ#	Frequency (Hz)	SEQ#	Frequency (Hz)	SEQ#	Frequency (Hz)
1	5.295G	2	5.251G	3	5.536G	4	5.257G
5	5.694G	6	5.615G	7	5.373G	8	5.529G
9	5.255G	10	5.542G	11	5.604G	12	5.280G
13	5.288G	14	5.479G	15	5.706G	16	5.600G
17	5.420G	18	5.640G	19	5.256G	20	5.260G
21	5.605G	22	5.349G	23	5.466G	24	5.576G
25	5.310G	26	5.696G	27	5.658G	28	5.284G
29	5.286G	30	5.651G	31	5.324G	32	5.570G
33	5.627G	34	5.610G	35	5.541G	36	5.505G
37	5.527G	38	5.481G	39	5.270G	40	5.301G
41	5.667G	42	5.516G	43	5.409G	44	5.299G
45	5.348G	46	5.482G	47	5.617G	48	5.586G

49	5.442G	50	5.297G	51	5.470G	52	5.296G
53	5.417G	54	5.282G	55	5.671G	56	5.676G
57	5.506G	58	5.421G	59	5.438G	60	5.345G
61	5.402G	62	5.350G	63	5.483G	64	5.577G
65	5.573G	66	5.537G	67	5.635G	68	5.426G
69	5.278G	70	5.303G	71	5.276G	72	5.591G
73	5.686G	74	5.568G	75	5.559G	76	5.712G
77	5.621G	78	5.414G	79	5.669G	80	5.398G
81	5.630G	82	5.521G	83	5.662G	84	5.619G
85	5.262G	86	5.578G	87	5.335G	88	5.401G
89	5.645G	90	5.312G	91	5.546G	92	5.292G
93	5.654G	94	5.663G	95	5.557G	96	5.628G
97	5.504G	98	5.305G	99	5.632G	100	5.624G

Hopping Frequency Sequence Name: HOP_FREQ_SEQ_24							
SEQ#	Frequency (Hz)	SEQ#	Frequency (Hz)	SEQ#	Frequency (Hz)	SEQ#	Frequency (Hz)
1	5.471G	2	5.508G	3	5.494G	4	5.442G
5	5.648G	6	5.621G	7	5.433G	8	5.405G
9	5.339G	10	5.302G	11	5.546G	12	5.502G
13	5.268G	14	5.607G	15	5.673G	16	5.406G
17	5.669G	18	5.307G	19	5.453G	20	5.670G
21	5.274G	22	5.570G	23	5.636G	24	5.484G
25	5.599G	26	5.458G	27	5.294G	28	5.595G
29	5.308G	30	5.606G	31	5.556G	32	5.402G
33	5.392G	34	5.626G	35	5.603G	36	5.416G
37	5.645G	38	5.709G	39	5.665G	40	5.407G
41	5.290G	42	5.298G	43	5.628G	44	5.314G
45	5.363G	46	5.366G	47	5.557G	48	5.321G
49	5.722G	50	5.525G	51	5.351G	52	5.390G
53	5.309G	54	5.614G	55	5.464G	56	5.281G
57	5.639G	58	5.293G	59	5.424G	60	5.413G
61	5.332G	62	5.478G	63	5.305G	64	5.398G
65	5.619G	66	5.507G	67	5.642G	68	5.299G
69	5.488G	70	5.480G	71	5.396G	72	5.682G
73	5.450G	74	5.592G	75	5.403G	76	5.374G
77	5.538G	78	5.287G	79	5.282G	80	5.537G

81	5.710G	82	5.641G	83	5.615G	84	5.358G
85	5.613G	86	5.438G	87	5.346G	88	5.386G
89	5.680G	90	5.255G	91	5.486G	92	5.379G
93	5.304G	94	5.320G	95	5.446G	96	5.720G
97	5.503G	98	5.690G	99	5.269G	100	5.306G

Hopping Frequency Sequence Name: HOP_FREQ_SEQ_25							
SEQ#	Frequency (Hz)	SEQ#	Frequency (Hz)	SEQ#	Frequency (Hz)	SEQ#	Frequency (Hz)
1	5.545G	2	5.281G	3	5.677G	4	5.635G
5	5.287G	6	5.663G	7	5.632G	8	5.290G
9	5.395G	10	5.614G	11	5.260G	12	5.396G
13	5.646G	14	5.538G	15	5.390G	16	5.611G
17	5.402G	18	5.647G	19	5.561G	20	5.397G
21	5.373G	22	5.444G	23	5.315G	24	5.300G
25	5.501G	26	5.407G	27	5.670G	28	5.514G
29	5.448G	30	5.343G	31	5.294G	32	5.382G
33	5.580G	34	5.606G	35	5.261G	36	5.329G
37	5.334G	38	5.527G	39	5.480G	40	5.666G
41	5.276G	42	5.422G	43	5.301G	44	5.639G
45	5.661G	46	5.684G	47	5.616G	48	5.369G
49	5.385G	50	5.317G	51	5.590G	52	5.253G
53	5.689G	54	5.375G	55	5.714G	56	5.693G
57	5.496G	58	5.596G	59	5.583G	60	5.529G
61	5.340G	62	5.477G	63	5.723G	64	5.656G
65	5.252G	66	5.662G	67	5.629G	68	5.622G
69	5.335G	70	5.592G	71	5.360G	72	5.333G
73	5.391G	74	5.603G	75	5.374G	76	5.665G
77	5.420G	78	5.681G	79	5.674G	80	5.368G
81	5.324G	82	5.312G	83	5.468G	84	5.319G
85	5.559G	86	5.518G	87	5.367G	88	5.275G
89	5.709G	90	5.262G	91	5.692G	92	5.582G
93	5.584G	94	5.473G	95	5.282G	96	5.331G
97	5.298G	98	5.565G	99	5.470G	100	5.626G

Hopping Frequency Sequence Name: HOP_FREQ_SEQ_26							
SEQ#	Frequency (Hz)	SEQ#	Frequency (Hz)	SEQ#	Frequency (Hz)	SEQ#	Frequency (Hz)
1	5.475G	2	5.337G	3	5.544G	4	5.723G
5	5.509G	6	5.506G	7	5.328G	8	5.327G
9	5.260G	10	5.716G	11	5.542G	12	5.256G
13	5.441G	14	5.349G	15	5.634G	16	5.680G
17	5.545G	18	5.661G	19	5.469G	20	5.704G
21	5.478G	22	5.446G	23	5.393G	24	5.521G
25	5.400G	26	5.306G	27	5.295G	28	5.280G
29	5.367G	30	5.557G	31	5.681G	32	5.471G
33	5.573G	34	5.637G	35	5.554G	36	5.444G
37	5.292G	38	5.552G	39	5.413G	40	5.588G
41	5.252G	42	5.447G	43	5.496G	44	5.582G
45	5.502G	46	5.373G	47	5.311G	48	5.415G
49	5.354G	50	5.412G	51	5.418G	52	5.685G
53	5.267G	54	5.483G	55	5.334G	56	5.626G
57	5.368G	58	5.600G	59	5.307G	60	5.498G
61	5.428G	62	5.341G	63	5.693G	64	5.569G
65	5.495G	66	5.647G	67	5.266G	68	5.481G
69	5.624G	70	5.477G	71	5.399G	72	5.422G
73	5.452G	74	5.689G	75	5.282G	76	5.296G
77	5.344G	78	5.333G	79	5.301G	80	5.595G
81	5.503G	82	5.501G	83	5.277G	84	5.358G
85	5.253G	86	5.419G	87	5.593G	88	5.456G
89	5.673G	90	5.629G	91	5.656G	92	5.671G
93	5.375G	94	5.650G	95	5.459G	96	5.678G
97	5.635G	98	5.615G	99	5.434G	100	5.575G

Hopping Frequency Sequence Name: HOP_FREQ_SEQ_27							
SEQ#	Frequency (Hz)	SEQ#	Frequency (Hz)	SEQ#	Frequency (Hz)	SEQ#	Frequency (Hz)
1	5.289G	2	5.560G	3	5.603G	4	5.697G
5	5.449G	6	5.529G	7	5.462G	8	5.262G
9	5.570G	10	5.701G	11	5.340G	12	5.274G
13	5.651G	14	5.673G	15	5.536G	16	5.712G



17	5.411G	18	5.566G	19	5.686G	20	5.376G
21	5.717G	22	5.531G	23	5.692G	24	5.295G
25	5.611G	26	5.719G	27	5.661G	28	5.667G
29	5.311G	30	5.470G	31	5.287G	32	5.561G
33	5.316G	34	5.517G	35	5.286G	36	5.604G
37	5.556G	38	5.398G	39	5.446G	40	5.350G
41	5.282G	42	5.380G	43	5.549G	44	5.480G
45	5.522G	46	5.408G	47	5.623G	48	5.416G
49	5.263G	50	5.352G	51	5.621G	52	5.674G
53	5.714G	54	5.644G	55	5.665G	56	5.412G
57	5.305G	58	5.315G	59	5.710G	60	5.251G
61	5.471G	62	5.302G	63	5.357G	64	5.575G
65	5.432G	66	5.630G	67	5.456G	68	5.720G
69	5.707G	70	5.513G	71	5.303G	72	5.330G
73	5.482G	74	5.296G	75	5.595G	76	5.457G
77	5.297G	78	5.371G	79	5.632G	80	5.643G
81	5.540G	82	5.687G	83	5.310G	84	5.684G
85	5.721G	86	5.658G	87	5.465G	88	5.341G
89	5.553G	90	5.506G	91	5.563G	92	5.463G
93	5.691G	94	5.417G	95	5.481G	96	5.472G
97	5.581G	98	5.500G	99	5.304G	100	5.568G

Hopping Frequency Sequence Name: HOP_FREQ_SEQ_28							
SEQ#	Frequency (Hz)	SEQ#	Frequency (Hz)	SEQ#	Frequency (Hz)	SEQ#	Frequency (Hz)
1	5.388G	2	5.252G	3	5.315G	4	5.290G
5	5.590G	6	5.638G	7	5.636G	8	5.550G
9	5.335G	10	5.642G	11	5.254G	12	5.566G
13	5.549G	14	5.640G	15	5.279G	16	5.499G
17	5.649G	18	5.267G	19	5.491G	20	5.587G
21	5.712G	22	5.309G	23	5.393G	24	5.260G
25	5.416G	26	5.271G	27	5.293G	28	5.366G
29	5.596G	30	5.446G	31	5.594G	32	5.624G
33	5.438G	34	5.343G	35	5.319G	36	5.313G
37	5.310G	38	5.341G	39	5.650G	40	5.263G
41	5.560G	42	5.403G	43	5.580G	44	5.508G
45	5.265G	46	5.272G	47	5.684G	48	5.479G

49	5.456G	50	5.701G	51	5.277G	52	5.620G
53	5.588G	54	5.289G	55	5.258G	56	5.611G
57	5.327G	58	5.300G	59	5.405G	60	5.564G
61	5.628G	62	5.409G	63	5.670G	64	5.255G
65	5.529G	66	5.497G	67	5.326G	68	5.496G
69	5.711G	70	5.717G	71	5.357G	72	5.724G
73	5.526G	74	5.618G	75	5.274G	76	5.441G
77	5.678G	78	5.544G	79	5.614G	80	5.418G
81	5.386G	82	5.721G	83	5.668G	84	5.379G
85	5.463G	86	5.396G	87	5.664G	88	5.353G
89	5.703G	90	5.298G	91	5.644G	92	5.307G
93	5.509G	94	5.553G	95	5.681G	96	5.589G
97	5.513G	98	5.547G	99	5.527G	100	5.295G

Hopping Frequency Sequence Name: HOP_FREQ_SEQ_29							
SEQ#	Frequency (Hz)	SEQ#	Frequency (Hz)	SEQ#	Frequency (Hz)	SEQ#	Frequency (Hz)
1	5.351G	2	5.612G	3	5.484G	4	5.268G
5	5.493G	6	5.636G	7	5.631G	8	5.693G
9	5.284G	10	5.413G	11	5.451G	12	5.706G
13	5.580G	14	5.382G	15	5.683G	16	5.344G
17	5.712G	18	5.288G	19	5.355G	20	5.361G
21	5.460G	22	5.305G	23	5.584G	24	5.594G
25	5.336G	26	5.358G	27	5.633G	28	5.335G
29	5.696G	30	5.386G	31	5.267G	32	5.517G
33	5.289G	34	5.489G	35	5.313G	36	5.568G
37	5.271G	38	5.514G	39	5.605G	40	5.511G
41	5.473G	42	5.270G	43	5.446G	44	5.626G
45	5.596G	46	5.378G	47	5.718G	48	5.582G
49	5.505G	50	5.297G	51	5.573G	52	5.672G
53	5.603G	54	5.639G	55	5.640G	56	5.346G
57	5.688G	58	5.678G	59	5.258G	60	5.657G
61	5.668G	62	5.512G	63	5.450G	64	5.254G
65	5.327G	66	5.308G	67	5.320G	68	5.434G
69	5.454G	70	5.495G	71	5.326G	72	5.457G
73	5.458G	74	5.577G	75	5.667G	76	5.622G
77	5.647G	78	5.274G	79	5.364G	80	5.628G

81	5.585G	82	5.620G	83	5.250G	84	5.609G
85	5.474G	86	5.420G	87	5.390G	88	5.638G
89	5.311G	90	5.463G	91	5.713G	92	5.412G
93	5.499G	94	5.306G	95	5.348G	96	5.279G
97	5.572G	98	5.559G	99	5.275G	100	5.680G

Hopping Frequency Sequence Name: HOP_FREQ_SEQ_30							
SEQ#	Frequency (Hz)	SEQ#	Frequency (Hz)	SEQ#	Frequency (Hz)	SEQ#	Frequency (Hz)
1	5.673G	2	5.315G	3	5.496G	4	5.668G
5	5.371G	6	5.565G	7	5.279G	8	5.577G
9	5.487G	10	5.664G	11	5.641G	12	5.649G
13	5.386G	14	5.545G	15	5.687G	16	5.393G
17	5.455G	18	5.467G	19	5.480G	20	5.642G
21	5.362G	22	5.602G	23	5.704G	24	5.499G
25	5.260G	26	5.591G	27	5.357G	28	5.605G
29	5.459G	30	5.403G	31	5.328G	32	5.586G
33	5.651G	34	5.520G	35	5.684G	36	5.384G
37	5.677G	38	5.601G	39	5.259G	40	5.251G
41	5.502G	42	5.432G	43	5.346G	44	5.648G
45	5.353G	46	5.612G	47	5.283G	48	5.718G
49	5.321G	50	5.349G	51	5.369G	52	5.627G
53	5.524G	54	5.708G	55	5.381G	56	5.274G
57	5.544G	58	5.409G	59	5.611G	60	5.380G
61	5.580G	62	5.498G	63	5.468G	64	5.257G
65	5.584G	66	5.266G	67	5.509G	68	5.629G
69	5.305G	70	5.324G	71	5.395G	72	5.676G
73	5.533G	74	5.688G	75	5.449G	76	5.388G
77	5.703G	78	5.603G	79	5.262G	80	5.686G
81	5.394G	82	5.661G	83	5.450G	84	5.342G
85	5.355G	86	5.483G	87	5.540G	88	5.538G
89	5.401G	90	5.276G	91	5.526G	92	5.400G
93	5.457G	94	5.654G	95	5.559G	96	5.377G
97	5.513G	98	5.678G	99	5.549G	100	5.301G

**IEEE 802.11ac 80MHz**

Type 1 Radar Statistical Performances				
Trial #	Pulses per Burst	Pulse Width (s)	PRI (s)	Detection
1	102	1.0u	518.0u	Yes
2	95	1.0u	558.0u	Yes
3	92	1.0u	578.0u	Yes
4	86	1.0u	618.0u	Yes
5	83	1.0u	638.0u	Yes
6	81	1.0u	658.0u	Yes
7	76	1.0u	698.0u	Yes
8	72	1.0u	738.0u	Yes
9	68	1.0u	778.0u	Yes
10	65	1.0u	818.0u	Yes
11	63	1.0u	838.0u	Yes
12	59	1.0u	898.0u	Yes
13	58	1.0u	918.0u	Yes
14	57	1.0u	938.0u	Yes
15	18	1.0u	3.066m	Yes
16	46	1.0u	1.152m	Yes
17	98	1.0u	539.0u	Yes
18	39	1.0u	1.365m	Yes
19	34	1.0u	1.577m	Yes
20	94	1.0u	563.0u	Yes
21	30	1.0u	1.790m	Yes
22	27	1.0u	2.002m	Yes
23	87	1.0u	607.0u	Yes
24	24	1.0u	2.215m	Yes
25	22	1.0u	2.428m	Yes
26	96	1.0u	551.0u	Yes
27	20	1.0u	2.640m	Yes
28	19	1.0u	2.853m	Yes
29	99	1.0u	535.0u	Yes
30	18	1.0u	3.065m	No
				Detection Rate: 96.7 %

Type 2 Radar Statistical Performances				
Trial #	Pulses per Burst	Pulse Width (s)	PRI (s)	Detection
1	25	4.6u	200.0u	Yes
2	27	2.8u	200.0u	Yes
3	27	1.7u	161.0u	No
4	28	2.6u	220.0u	Yes
5	27	2.6u	218.0u	Yes
6	27	1.7u	172.0u	Yes
7	26	1.6u	191.0u	Yes
8	25	3.7u	158.0u	Yes
9	28	1.5u	228.0u	Yes
10	26	4.9u	198.0u	Yes
11	28	1.3u	205.0u	Yes
12	29	2.6u	155.0u	Yes
13	28	4.9u	224.0u	Yes
14	24	2.9u	169.0u	Yes
15	28	4.1u	183.0u	Yes
16	27	1.7u	192.0u	Yes
17	24	2.6u	191.0u	Yes
18	27	4.6u	173.0u	Yes
19	28	3.4u	187.0u	Yes
20	27	4.3u	214.0u	Yes
21	29	1.2u	179.0u	Yes
22	25	1.1u	154.0u	Yes
23	25	4.1u	159.0u	Yes
24	28	2.9u	158.0u	Yes
25	25	2.8u	215.0u	Yes
26	27	4.0u	196.0u	Yes
27	27	4.5u	215.0u	Yes
28	27	2.9u	180.0u	Yes
29	27	1.5u	177.0u	Yes
30	28	1.6u	186.0u	Yes
				Detection Rate: 96.7 %

Type 3 Radar Statistical Performances				
Trial #	Pulses per Burst	Pulse Width (s)	PRI (s)	Detection
1	17	9.6u	218.0u	Yes
2	18	8.4u	494.0u	Yes
3	17	8.7u	375.0u	Yes
4	18	7.0u	379.0u	Yes
5	17	8.9u	401.0u	Yes
6	17	8.3u	348.0u	Yes
7	16	6.2u	454.0u	Yes
8	18	9.2u	299.0u	Yes
9	16	9.6u	347.0u	Yes
10	16	7.0u	293.0u	Yes
11	17	9.7u	434.0u	Yes
12	16	9.5u	405.0u	Yes
13	17	9.0u	459.0u	Yes
14	18	6.2u	349.0u	Yes
15	17	7.9u	225.0u	No
16	18	8.0u	384.0u	Yes
17	17	6.5u	220.0u	Yes
18	16	8.4u	225.0u	Yes
19	17	6.1u	210.0u	Yes
20	16	6.0u	260.0u	Yes
21	18	9.1u	470.0u	Yes
22	16	7.1u	474.0u	Yes
23	18	9.1u	433.0u	Yes
24	18	9.1u	296.0u	No
25	16	8.5u	368.0u	Yes
26	16	6.4u	315.0u	Yes
27	17	6.9u	204.0u	Yes
28	18	6.8u	309.0u	Yes
29	17	9.2u	351.0u	No
30	17	9.0u	201.0u	Yes
			Detection Rate: 90.0 %	

Type 4 Radar Statistical Performances				
Trial #	Pulses per Burst	Pulse Width (s)	PRI (s)	Detection
1	14	14.3u	312.0u	Yes
2	13	18.3u	368.0u	Yes
3	13	18.4u	392.0u	Yes
4	16	14.9u	457.0u	Yes
5	13	15.9u	337.0u	Yes
6	14	13.7u	413.0u	Yes
7	13	13.6u	263.0u	Yes
8	14	11.2u	484.0u	Yes
9	12	11.6u	341.0u	Yes
10	14	18.2u	448.0u	Yes
11	14	14.2u	423.0u	Yes
12	14	12.4u	470.0u	Yes
13	13	18.0u	336.0u	Yes
14	15	17.8u	213.0u	No
15	14	11.8u	297.0u	No
16	15	16.6u	436.0u	Yes
17	15	16.8u	298.0u	Yes
18	13	14.9u	459.0u	Yes
19	14	19.5u	286.0u	Yes
20	16	18.4u	462.0u	Yes
21	15	19.0u	314.0u	Yes
22	15	16.2u	284.0u	Yes
23	13	16.9u	396.0u	Yes
24	15	14.9u	202.0u	Yes
25	14	17.8u	492.0u	Yes
26	12	14.2u	451.0u	Yes
27	12	18.2u	350.0u	Yes
28	15	14.7u	204.0u	No
29	12	16.6u	418.0u	Yes
30	13	14.1u	218.0u	Yes
			Detection Rate: 90.0 %	

Type 5 Radar Statistical Performances		
Trial #	Test Signal Name	Detection
1	LP_Signal_01	Yes
2	LP_Signal_02	Yes
3	LP_Signal_03	Yes
4	LP_Signal_04	Yes
5	LP_Signal_05	Yes
6	LP_Signal_06	Yes
7	LP_Signal_07	Yes
8	LP_Signal_08	Yes
9	LP_Signal_09	Yes
10	LP_Signal_10	Yes
11	LP_Signal_11	Yes
12	LP_Signal_12	Yes
13	LP_Signal_13	Yes
14	LP_Signal_14	Yes
15	LP_Signal_15	Yes
16	LP_Signal_16	Yes
17	LP_Signal_17	Yes
18	LP_Signal_18	Yes
19	LP_Signal_19	Yes
20	LP_Signal_20	Yes
21	LP_Signal_21	No
22	LP_Signal_22	Yes
23	LP_Signal_23	Yes
24	LP_Signal_24	Yes
25	LP_Signal_25	Yes
26	LP_Signal_26	Yes
27	LP_Signal_27	Yes
28	LP_Signal_28	Yes
29	LP_Signal_29	Yes
30	LP_Signal_30	Yes
		Detection Rate: 96.7 %



Long Pulse Radar Test Signal						
Test Signal Name: LP_Signal_01						
Number of Bursts in Trial: 16						
Burst	Pulses per Burst	Chrip (Hz)	Pulse Width (s)	Pulse 1 to 2 Spacing (s)	Pulse 2 to 3 Spacing (s)	Start Location (s)
1	2	8M	84.1u	1.706m	-	633.4m
2	2	19M	86.6u	1.265m	-	29.01m
3	2	19M	83.7u	1.208m	-	173.0m
4	2	16M	73.4u	1.102m	-	727.5m
5	3	10M	69.8u	1.589m	1.187m	272.9m
6	3	18M	78.9u	1.778m	923.1u	491.3m
7	1	12M	50.7u	-	-	179.1m
8	3	15M	75.2u	1.329m	1.086m	546.7m
9	2	15M	67.1u	1.104m	-	439.4m
10	2	5M	83.8u	1.674m	-	329.1m
11	2	17M	81.3u	1.875m	-	522.5m
12	2	15M	76.3u	1.289m	-	615.4m
13	1	19M	63.2u	-	-	449.1m
14	2	20M	69.7u	1.822m	-	536.3m
15	2	18M	66.5u	1.262m	-	72.80m
16	1	18M	67.4u	-	-	561.1m

Long Pulse Radar Test Signal						
Test Signal Name: LP_Signal_02						
Number of Bursts in Trial: 19						
Burst	Pulses per Burst	Chrip (Hz)	Pulse Width (s)	Pulse 1 to 2 Spacing (s)	Pulse 2 to 3 Spacing (s)	Start Location (s)
1	2	7M	73.1u	1.383m	-	495.3m
2	2	16M	96.5u	1.663m	-	441.1m
3	2	18M	54.4u	1.709m	-	417.2m
4	2	12M	88.0u	1.229m	-	481.5m
5	2	15M	70.0u	1.416m	-	595.1m
6	2	13M	81.9u	1.453m	-	408.8m
7	2	14M	98.3u	1.230m	-	59.31m

8	1	13M	74.9u	-	-	561.2m
9	2	7M	89.2u	1.110m	-	346.0m
10	1	6M	74.0u	-	-	307.3m
11	3	11M	52.8u	1.096m	1.240m	493.6m
12	3	19M	67.3u	1.285m	1.492m	415.9m
13	1	20M	61.2u	-	-	152.9m
14	1	10M	50.3u	-	-	135.2m
15	2	16M	90.0u	1.862m	-	38.81m
16	3	10M	60.1u	1.690m	1.236m	312.1m
17	2	19M	68.5u	1.740m	-	302.8m
18	2	10M	52.4u	1.853m	-	399.8m
19	2	9M	54.4u	1.379m	-	419.2m

Long Pulse Radar Test Signal						
Test Signal Name: LP_Signal_03						
Number of Bursts in Trial: 14						
Burst	Pulses per Burst	Chrip (Hz)	Pulse Width (s)	Pulse 1 to 2 Spacing (s)	Pulse 2 to 3 Spacing (s)	Start Location (s)
1	3	14M	77.4u	1.614m	1.917m	342.6m
2	2	6M	72.3u	1.664m	-	753.6m
3	1	20M	63.2u	-	-	145.3m
4	2	6M	70.7u	1.412m	-	35.96m
5	2	17M	62.8u	1.509m	-	132.7m
6	2	9M	81.6u	1.701m	-	375.0m
7	1	5M	56.4u	-	-	118.5m
8	2	6M	71.6u	1.447m	-	70.15m
9	1	16M	51.1u	-	-	330.9m
10	2	15M	93.4u	1.644m	-	521.0m
11	2	12M	64.4u	1.329m	-	335.3m
12	2	17M	59.6u	946.4u	-	562.3m
13	2	6M	80.1u	1.003m	-	289.9m
14	2	18M	82.5u	1.201m	-	639.5m

Long Pulse Radar Test Signal						
Test Signal Name: LP_Signal_04						
Number of Bursts in Trial: 19						
Burst	Pulses per Burst	Chrip (Hz)	Pulse Width (s)	Pulse 1 to 2 Spacing (s)	Pulse 2 to 3 Spacing (s)	Start Location (s)
1	1	7M	56.4u	-	-	558.3m
2	2	16M	99.6u	1.771m	-	296.2m
3	1	17M	71.0u	-	-	232.3m
4	2	10M	77.9u	935.1u	-	278.7m
5	2	8M	64.0u	1.132m	-	518.5m
6	2	11M	72.6u	1.479m	-	68.28m
7	3	12M	97.6u	1.294m	1.022m	522.7m
8	3	16M	52.8u	1.198m	1.493m	308.5m
9	2	12M	61.6u	1.570m	-	391.7m
10	2	13M	99.1u	1.058m	-	267.0m
11	1	7M	78.0u	-	-	156.1m
12	2	15M	64.7u	1.836m	-	516.6m
13	2	17M	97.1u	1.666m	-	32.94m
14	3	17M	71.2u	969.8u	1.406m	441.2m
15	3	19M	77.2u	1.527m	1.198m	347.3m
16	2	14M	74.9u	1.150m	-	353.8m
17	2	18M	66.3u	1.724m	-	530.9m
18	2	14M	51.8u	1.374m	-	102.1m
19	2	16M	97.0u	1.734m	-	362.0m

Long Pulse Radar Test Signal						
Test Signal Name: LP_Signal_05						
Number of Bursts in Trial: 10						
Burst	Pulses per Burst	Chrip (Hz)	Pulse Width (s)	Pulse 1 to 2 Spacing (s)	Pulse 2 to 3 Spacing (s)	Start Location (s)
1	2	15M	80.9u	1.555m	-	736.6m
2	1	8M	86.8u	-	-	887.7m
3	3	19M	51.5u	998.5u	1.798m	1.164
4	1	10M	76.9u	-	-	1.048
5	2	12M	77.8u	1.196m	-	1.134

6	2	17M	99.2u	1.489m	-	614.5m
7	2	14M	51.4u	1.147m	-	444.6m
8	2	14M	76.6u	1.055m	-	222.7m
9	2	7M	64.5u	1.913m	-	1.034
10	2	14M	64.4u	1.427m	-	657.7m

Long Pulse Radar Test Signal						
Test Signal Name: LP_Signal_06						
Number of Bursts in Trial: 18						
Burst	Pulses per Burst	Chrip (Hz)	Pulse Width (s)	Pulse 1 to 2 Spacing (s)	Pulse 2 to 3 Spacing (s)	Start Location (s)
1	2	11M	70.3u	1.340m	-	605.8m
2	1	12M	72.2u	-	-	594.0m
3	1	14M	97.1u	-	-	27.52m
4	2	18M	55.1u	1.732m	-	660.8m
5	3	10M	82.4u	1.830m	1.733m	74.47m
6	2	18M	59.9u	1.904m	-	451.4m
7	1	8M	76.6u	-	-	514.5m
8	1	13M	83.8u	-	-	417.3m
9	3	19M	81.3u	1.117m	1.440m	93.51m
10	2	12M	89.4u	1.207m	-	624.1m
11	2	17M	86.3u	1.548m	-	135.7m
12	2	19M	56.6u	1.463m	-	294.2m
13	3	18M	96.6u	1.813m	1.866m	500.8m
14	2	11M	67.4u	1.366m	-	325.1m
15	1	17M	94.7u	-	-	659.6m
16	2	12M	68.8u	996.2u	-	44.71m
17	2	12M	51.9u	1.069m	-	141.4m
18	3	6M	78.3u	1.398m	1.523m	327.3m

Long Pulse Radar Test Signal						
Test Signal Name: LP_Signal_07						
Number of Bursts in Trial: 9						
Burst	Pulses per Burst	Chrip (Hz)	Pulse Width (s)	Pulse 1 to 2 Spacing (s)	Pulse 2 to 3 Spacing (s)	Start Location (s)
1	1	18M	94.0u	-	-	1.172
2	2	12M	61.4u	1.813m	-	239.4m
3	1	18M	81.0u	-	-	566.3m
4	2	17M	92.8u	1.025m	-	88.48m
5	2	17M	66.6u	1.718m	-	934.9m
6	2	8M	72.1u	1.323m	-	1.063
7	3	10M	63.0u	1.441m	1.857m	559.8m
8	2	11M	63.2u	1.520m	-	192.7m
9	2	10M	96.6u	1.211m	-	297.7m

Long Pulse Radar Test Signal						
Test Signal Name: LP_Signal_08						
Number of Bursts in Trial: 14						
Burst	Pulses per Burst	Chrip (Hz)	Pulse Width (s)	Pulse 1 to 2 Spacing (s)	Pulse 2 to 3 Spacing (s)	Start Location (s)
1	2	12M	52.8u	1.473m	-	198.0m
2	1	10M	98.4u	-	-	854.6m
3	2	17M	81.3u	1.082m	-	655.3m
4	1	6M	99.6u	-	-	97.58m
5	2	9M	91.9u	1.046m	-	316.8m
6	2	11M	67.5u	1.840m	-	720.6m
7	1	5M	50.5u	-	-	210.9m
8	2	17M	86.4u	1.249m	-	647.7m
9	1	10M	72.5u	-	-	262.8m
10	3	10M	88.6u	1.012m	925.4u	498.2m
11	1	17M	70.1u	-	-	58.53m
12	3	13M	65.6u	1.035m	1.460m	792.3m
13	1	13M	70.2u	-	-	772.9m
14	1	6M	62.0u	-	-	225.1m

Long Pulse Radar Test Signal						
Test Signal Name: LP_Signal_09						
Number of Bursts in Trial: 12						
Burst	Pulses per Burst	Chrip (Hz)	Pulse Width (s)	Pulse 1 to 2 Spacing (s)	Pulse 2 to 3 Spacing (s)	Start Location (s)
1	3	20M	60.0u	1.932m	1.188m	976.2m
2	3	10M	80.0u	1.884m	1.117m	681.4m
3	2	16M	56.3u	1.719m	-	427.8m
4	1	6M	88.3u	-	-	981.4m
5	1	20M	62.5u	-	-	115.8m
6	2	5M	95.9u	1.768m	-	52.65m
7	3	11M	68.9u	1.512m	1.881m	301.1m
8	2	12M	89.4u	1.297m	-	581.7m
9	3	6M	67.0u	1.532m	1.167m	527.1m
10	1	6M	95.6u	-	-	952.8m
11	2	15M	58.4u	1.332m	-	516.9m
12	3	19M	95.3u	1.837m	1.896m	65.45m

Long Pulse Radar Test Signal						
Test Signal Name: LP_Signal_10						
Number of Bursts in Trial: 11						
Burst	Pulses per Burst	Chrip (Hz)	Pulse Width (s)	Pulse 1 to 2 Spacing (s)	Pulse 2 to 3 Spacing (s)	Start Location (s)
1	1	10M	77.0u	-	-	467.6m
2	1	18M	80.3u	-	-	818.5m
3	2	18M	51.6u	1.877m	-	65.48m
4	2	14M	94.3u	1.291m	-	461.3m
5	2	7M	58.3u	1.861m	-	331.1m
6	3	19M	93.6u	1.753m	1.339m	810.2m
7	3	9M	82.5u	1.766m	1.801m	665.6m
8	1	13M	64.7u	-	-	504.6m
9	2	17M	98.6u	1.589m	-	1.056
10	1	17M	94.5u	-	-	435.0m
11	2	13M	91.7u	915.3u	-	502.1m

Long Pulse Radar Test Signal						
Test Signal Name: LP_Signal_11						
Number of Bursts in Trial: 15						
Burst	Pulses per Burst	Chrip (Hz)	Pulse Width (s)	Pulse 1 to 2 Spacing (s)	Pulse 2 to 3 Spacing (s)	Start Location (s)
1	2	11M	66.5u	1.356m	-	53.39m
2	2	18M	67.9u	1.160m	-	521.1m
3	2	9M	73.8u	1.665m	-	615.9m
4	3	12M	93.4u	1.720m	1.445m	449.1m
5	3	10M	96.8u	1.448m	921.2u	450.6m
6	2	17M	81.1u	1.436m	-	453.1m
7	2	11M	55.5u	1.785m	-	491.6m
8	2	19M	94.7u	1.598m	-	115.7m
9	1	11M	95.1u	-	-	537.9m
10	2	15M	73.0u	1.916m	-	285.3m
11	3	9M	90.6u	1.095m	917.4u	202.3m
12	1	15M	91.0u	-	-	350.9m
13	2	7M	80.2u	1.527m	-	225.8m
14	3	11M	70.3u	963.7u	1.586m	676.1m
15	3	17M	96.3u	1.659m	936.7u	15.38m

Long Pulse Radar Test Signal						
Test Signal Name: LP_Signal_12						
Number of Bursts in Trial: 16						
Burst	Pulses per Burst	Chrip (Hz)	Pulse Width (s)	Pulse 1 to 2 Spacing (s)	Pulse 2 to 3 Spacing (s)	Start Location (s)
1	2	9M	54.4u	1.430m	-	664.4m
2	1	11M	70.3u	-	-	93.36m
3	2	15M	53.8u	1.549m	-	705.9m
4	1	19M	89.1u	-	-	737.9m
5	1	19M	78.1u	-	-	668.8m
6	1	17M	87.7u	-	-	49.92m
7	3	13M	74.5u	1.821m	1.395m	54.93m
8	1	5M	90.2u	-	-	697.7m
9	2	7M	65.2u	1.209m	-	199.5m

10	3	6M	64.3u	1.151m	1.895m	481.0m
11	2	16M	77.9u	1.130m	-	94.08m
12	1	20M	98.9u	-	-	245.6m
13	3	19M	92.4u	1.889m	918.6u	635.1m
14	3	15M	64.9u	1.890m	1.419m	655.7m
15	1	14M	56.3u	-	-	561.1m
16	1	19M	59.0u	-	-	161.1m

Long Pulse Radar Test Signal						
Test Signal Name: LP_Signal_13						
Number of Bursts in Trial: 20						
Burst	Pulses per Burst	Chrip (Hz)	Pulse Width (s)	Pulse 1 to 2 Spacing (s)	Pulse 2 to 3 Spacing (s)	Start Location (s)
1	2	13M	73.9u	1.119m	-	101.8m
2	2	15M	91.5u	1.534m	-	424.2m
3	3	19M	87.7u	1.721m	1.307m	525.9m
4	1	6M	94.9u	-	-	60.92m
5	3	20M	78.0u	1.024m	1.129m	421.7m
6	2	7M	88.0u	1.035m	-	62.16m
7	1	9M	56.2u	-	-	598.4m
8	3	18M	73.9u	932.1u	1.374m	44.11m
9	1	10M	97.2u	-	-	48.91m
10	2	6M	78.9u	1.240m	-	313.8m
11	3	7M	96.3u	964.7u	1.355m	255.7m
12	3	13M	68.5u	1.855m	1.277m	170.4m
13	1	15M	76.9u	-	-	208.1m
14	1	6M	57.2u	-	-	554.0m
15	1	7M	56.4u	-	-	516.0m
16	2	9M	81.0u	1.515m	-	480.4m
17	2	10M	63.3u	1.782m	-	407.6m
18	1	13M	93.4u	-	-	80.28m
19	2	13M	52.4u	1.651m	-	377.6m
20	3	10M	92.8u	1.473m	1.254m	117.3m



Long Pulse Radar Test Signal						
Test Signal Name: LP_Signal_14						
Number of Bursts in Trial: 11						
Burst	Pulses per Burst	Chrip (Hz)	Pulse Width (s)	Pulse 1 to 2 Spacing (s)	Pulse 2 to 3 Spacing (s)	Start Location (s)
1	2	18M	51.2u	1.182m	-	1.084
2	2	16M	77.0u	1.572m	-	821.9m
3	1	8M	96.7u	-	-	323.4m
4	1	19M	94.0u	-	-	332.0m
5	2	7M	98.5u	1.762m	-	380.0m
6	2	17M	65.5u	1.819m	-	613.3m
7	1	13M	52.4u	-	-	639.9m
8	2	9M	63.2u	1.569m	-	384.5m
9	1	7M	51.1u	-	-	635.9m
10	2	6M	78.1u	1.197m	-	188.3m
11	2	9M	84.8u	1.366m	-	466.0m

Long Pulse Radar Test Signal						
Test Signal Name: LP_Signal_15						
Number of Bursts in Trial: 10						
Burst	Pulses per Burst	Chrip (Hz)	Pulse Width (s)	Pulse 1 to 2 Spacing (s)	Pulse 2 to 3 Spacing (s)	Start Location (s)
1	1	8M	90.7u	-	-	315.2m
2	1	11M	93.9u	-	-	298.6m
3	3	12M	68.3u	1.217m	1.343m	173.0m
4	2	12M	51.7u	1.331m	-	408.7m
5	3	10M	67.0u	1.843m	1.753m	679.7m
6	2	17M	94.5u	909.5u	-	871.4m
7	3	19M	86.0u	1.694m	1.153m	1.162
8	3	17M	66.1u	1.309m	1.610m	969.2m
9	1	12M	90.0u	-	-	869.6m
10	2	5M	58.5u	1.328m	-	198.8m

Long Pulse Radar Test Signal						
Test Signal Name: LP_Signal_16						
Number of Bursts in Trial: 18						
Burst	Pulses per Burst	Chrip (Hz)	Pulse Width (s)	Pulse 1 to 2 Spacing (s)	Pulse 2 to 3 Spacing (s)	Start Location (s)
1	2	16M	64.8u	1.598m	-	343.1m
2	2	8M	51.8u	1.502m	-	14.63m
3	2	16M	87.7u	1.814m	-	92.68m
4	1	17M	95.2u	-	-	127.0m
5	2	15M	67.1u	1.701m	-	432.5m
6	1	10M	94.1u	-	-	5.004m
7	2	8M	73.3u	1.373m	-	113.1m
8	2	13M	58.0u	1.202m	-	160.7m
9	2	20M	70.0u	1.922m	-	476.2m
10	2	7M	86.1u	1.120m	-	159.4m
11	3	15M	86.6u	1.514m	1.782m	443.5m
12	2	18M	55.6u	1.196m	-	292.3m
13	3	5M	91.2u	1.027m	1.290m	67.44m
14	1	9M	76.1u	-	-	33.23m
15	1	10M	59.0u	-	-	630.8m
16	2	7M	50.1u	1.092m	-	558.5m
17	2	16M	77.0u	1.129m	-	224.0m
18	2	10M	62.1u	1.508m	-	93.29m

Long Pulse Radar Test Signal						
Test Signal Name: LP_Signal_17						
Number of Bursts in Trial: 11						
Burst	Pulses per Burst	Chrip (Hz)	Pulse Width (s)	Pulse 1 to 2 Spacing (s)	Pulse 2 to 3 Spacing (s)	Start Location (s)
1	1	12M	87.3u	-	-	1.023
2	2	6M	80.3u	1.615m	-	339.3m
3	2	8M	87.4u	1.662m	-	189.9m
4	3	19M	92.0u	1.003m	1.689m	230.4m
5	2	9M	57.4u	1.033m	-	656.2m
6	2	12M	59.8u	1.630m	-	679.6m

7	1	10M	68.2u	-	-	116.1m
8	3	10M	73.9u	1.516m	1.800m	1.042
9	2	17M	67.2u	1.650m	-	1.005
10	2	6M	80.1u	998.9u	-	380.6m
11	2	13M	94.1u	1.716m	-	237.8m

Long Pulse Radar Test Signal						
Test Signal Name: LP_Signal_18						
Number of Bursts in Trial: 15						
Burst	Pulses per Burst	Chrip (Hz)	Pulse Width (s)	Pulse 1 to 2 Spacing (s)	Pulse 2 to 3 Spacing (s)	Start Location (s)
1	2	13M	79.4u	1.841m	-	469.1m
2	2	6M	55.7u	1.813m	-	369.2m
3	2	8M	80.6u	1.405m	-	720.6m
4	2	16M	86.0u	916.0u	-	475.2m
5	2	18M	55.1u	1.291m	-	336.6m
6	2	10M	81.8u	1.835m	-	86.76m
7	1	19M	76.6u	-	-	68.14m
8	3	13M	99.4u	1.062m	1.753m	291.5m
9	2	8M	60.9u	1.647m	-	278.3m
10	2	16M	81.2u	1.487m	-	46.20m
11	3	11M	60.1u	1.690m	1.442m	184.9m
12	3	7M	61.3u	1.604m	1.882m	489.2m
13	3	19M	94.6u	1.000m	1.602m	648.4m
14	2	6M	65.4u	1.304m	-	134.5m
15	1	14M	76.4u	-	-	189.3m

Long Pulse Radar Test Signal						
Test Signal Name: LP_Signal_19						
Number of Bursts in Trial: 17						
Burst	Pulses per Burst	Chrip (Hz)	Pulse Width (s)	Pulse 1 to 2 Spacing (s)	Pulse 2 to 3 Spacing (s)	Start Location (s)
1	3	13M	96.1u	1.861m	1.786m	194.1m
2	1	8M	55.4u	-	-	56.81m
3	2	6M	94.3u	1.341m	-	504.7m

4	2	13M	68.3u	1.794m	-	50.09m
5	2	6M	56.8u	1.135m	-	468.8m
6	1	6M	84.4u	-	-	174.3m
7	2	6M	72.4u	1.854m	-	629.1m
8	3	7M	90.6u	1.174m	1.392m	325.9m
9	2	12M	66.8u	1.819m	-	394.9m
10	2	12M	91.1u	1.582m	-	451.7m
11	3	13M	91.8u	1.504m	1.649m	263.4m
12	3	14M	54.3u	1.486m	1.430m	470.4m
13	3	20M	50.6u	1.692m	1.295m	562.6m
14	2	17M	77.7u	1.034m	-	630.4m
15	1	8M	99.4u	-	-	470.6m
16	1	18M	50.1u	-	-	687.6m
17	3	11M	62.8u	1.820m	1.145m	369.7m

Long Pulse Radar Test Signal						
Test Signal Name: LP_Signal_20						
Number of Bursts in Trial: 17						
Burst	Pulses per Burst	Chrip (Hz)	Pulse Width (s)	Pulse 1 to 2 Spacing (s)	Pulse 2 to 3 Spacing (s)	Start Location (s)
1	3	15M	89.3u	1.058m	1.831m	421.7m
2	2	10M	83.9u	928.1u	-	217.5m
3	3	11M	76.0u	1.701m	1.612m	446.8m
4	2	12M	90.2u	1.674m	-	596.8m
5	1	16M	51.0u	-	-	325.8m
6	1	9M	52.5u	-	-	417.6m
7	3	12M	95.1u	1.447m	1.745m	569.2m
8	2	10M	71.7u	975.3u	-	596.8m
9	2	15M	66.8u	1.702m	-	162.6m
10	3	17M	91.8u	1.088m	1.289m	676.7m
11	2	18M	74.2u	1.696m	-	359.3m
12	1	12M	67.8u	-	-	383.9m
13	3	16M	87.6u	992.4u	1.706m	72.56m
14	2	17M	50.1u	967.9u	-	543.8m
15	3	14M	81.5u	1.515m	1.880m	352.0m
16	1	9M	76.6u	-	-	136.7m

17	2	14M	69.5u	1.763m	-	632.4m
----	---	-----	-------	--------	---	--------

Long Pulse Radar Test Signal						
Test Signal Name: LP_Signal_21						
Number of Bursts in Trial: 13						
Burst	Pulses per Burst	Chrip (Hz)	Pulse Width (s)	Pulse 1 to 2 Spacing (s)	Pulse 2 to 3 Spacing (s)	Start Location (s)
1	2	14M	99.7u	920.3u	-	86.60m
2	3	18M	52.9u	1.086m	1.162m	307.8m
3	1	15M	93.4u	-	-	381.4m
4	2	16M	66.6u	1.469m	-	17.24m
5	2	9M	59.8u	1.201m	-	12.65m
6	1	14M	73.5u	-	-	870.5m
7	2	10M	94.2u	1.123m	-	42.55m
8	2	14M	57.7u	1.830m	-	550.3m
9	2	13M	79.2u	1.354m	-	411.7m
10	3	8M	69.0u	997.0u	1.435m	453.9m
11	1	19M	87.7u	-	-	180.4m
12	1	11M	86.6u	-	-	878.0m
13	3	12M	77.8u	1.017m	1.251m	766.0m

Long Pulse Radar Test Signal						
Test Signal Name: LP_Signal_22						
Number of Bursts in Trial: 9						
Burst	Pulses per Burst	Chrip (Hz)	Pulse Width (s)	Pulse 1 to 2 Spacing (s)	Pulse 2 to 3 Spacing (s)	Start Location (s)
1	2	8M	84.9u	1.446m	-	476.0m
2	2	6M	50.3u	1.732m	-	542.2m
3	1	14M	53.0u	-	-	504.5m
4	2	9M	75.4u	1.454m	-	1.035
5	2	14M	60.6u	992.4u	-	731.7m
6	3	18M	64.0u	1.914m	1.691m	801.7m
7	3	13M	75.7u	1.885m	1.608m	737.4m
8	2	20M	78.9u	1.169m	-	62.91m
9	3	17M	81.8u	943.2u	1.342m	1.306

Long Pulse Radar Test Signal						
Test Signal Name: LP_Signal_23						
Number of Bursts in Trial: 19						
Burst	Pulses per Burst	Chrip (Hz)	Pulse Width (s)	Pulse 1 to 2 Spacing (s)	Pulse 2 to 3 Spacing (s)	Start Location (s)
1	3	16M	89.1u	966.9u	1.505m	438.7m
2	1	8M	94.3u	-	-	486.4m
3	2	13M	93.0u	1.414m	-	301.7m
4	2	11M	72.0u	1.314m	-	238.4m
5	2	17M	87.8u	1.623m	-	299.6m
6	2	16M	71.7u	1.869m	-	522.5m
7	3	15M	95.9u	1.087m	1.579m	42.20m
8	3	7M	62.8u	1.206m	967.2u	138.4m
9	1	14M	56.9u	-	-	122.8m
10	2	7M	70.5u	1.692m	-	456.8m
11	3	20M	86.0u	1.515m	1.485m	211.4m
12	2	16M	89.5u	1.004m	-	265.8m
13	3	9M	56.5u	1.065m	1.739m	253.8m
14	2	7M	64.5u	979.5u	-	9.909m
15	2	11M	73.3u	1.700m	-	113.6m
16	3	20M	58.2u	1.007m	1.790m	127.1m
17	2	20M	54.2u	1.889m	-	448.0m
18	2	14M	68.8u	1.360m	-	608.1m
19	3	17M	57.0u	1.937m	994.0u	233.2m

Long Pulse Radar Test Signal						
Test Signal Name: LP_Signal_24						
Number of Bursts in Trial: 16						
Burst	Pulses per Burst	Chrip (Hz)	Pulse Width (s)	Pulse 1 to 2 Spacing (s)	Pulse 2 to 3 Spacing (s)	Start Location (s)
1	2	8M	94.6u	1.268m	-	523.9m
2	1	12M	97.8u	-	-	104.6m
3	1	16M	83.0u	-	-	636.9m
4	2	5M	99.9u	1.829m	-	313.6m
5	2	10M	95.1u	1.023m	-	726.0m

6	2	15M	52.2u	1.097m	-	451.1m
7	2	17M	96.5u	947.5u	-	725.1m
8	3	7M	57.5u	1.839m	1.002m	306.8m
9	2	15M	74.5u	1.355m	-	458.1m
10	1	8M	77.7u	-	-	405.0m
11	2	12M	67.0u	1.875m	-	253.3m
12	3	13M	70.3u	1.828m	1.769m	574.9m
13	3	15M	80.7u	1.376m	1.639m	573.9m
14	3	18M	70.5u	1.868m	1.722m	299.5m
15	2	10M	95.3u	1.555m	-	307.8m
16	2	12M	77.3u	1.381m	-	225.0m

Long Pulse Radar Test Signal						
Test Signal Name: LP_Signal_25						
Number of Bursts in Trial: 19						
Burst	Pulses per Burst	Chrip (Hz)	Pulse Width (s)	Pulse 1 to 2 Spacing (s)	Pulse 2 to 3 Spacing (s)	Start Location (s)
1	3	9M	95.0u	1.018m	1.019m	229.9m
2	2	6M	86.5u	1.215m	-	348.2m
3	1	6M	78.6u	-	-	519.7m
4	1	17M	87.1u	-	-	468.9m
5	2	6M	50.6u	1.848m	-	19.81m
6	1	18M	93.3u	-	-	470.0m
7	2	8M	67.2u	1.374m	-	186.9m
8	3	18M	61.0u	1.520m	1.595m	173.8m
9	3	20M	63.6u	1.250m	1.784m	550.6m
10	3	9M	51.1u	949.9u	1.486m	180.0m
11	2	11M	56.8u	1.803m	-	324.5m
12	3	19M	77.6u	1.269m	962.4u	395.7m
13	2	7M	89.6u	984.4u	-	593.9m
14	1	6M	66.6u	-	-	159.7m
15	2	9M	73.4u	1.909m	-	52.42m
16	2	9M	54.6u	1.828m	-	56.08m
17	2	13M	58.6u	1.104m	-	176.9m
18	1	20M	72.4u	-	-	169.4m
19	2	8M	62.6u	1.046m	-	339.2m

Long Pulse Radar Test Signal						
Test Signal Name: LP_Signal_26						
Number of Bursts in Trial: 13						
Burst	Pulses per Burst	Chrip (Hz)	Pulse Width (s)	Pulse 1 to 2 Spacing (s)	Pulse 2 to 3 Spacing (s)	Start Location (s)
1	2	11M	75.6u	1.794m	-	12.48m
2	2	18M	92.5u	1.378m	-	737.1m
3	1	7M	58.1u	-	-	853.5m
4	2	13M	56.9u	1.090m	-	836.9m
5	1	6M	91.2u	-	-	344.9m
6	3	9M	80.8u	1.354m	1.472m	509.4m
7	2	19M	62.6u	1.618m	-	219.4m
8	2	6M	68.1u	1.446m	-	590.0m
9	2	9M	93.9u	1.085m	-	32.98m
10	1	7M	99.7u	-	-	698.6m
11	2	16M	69.3u	1.247m	-	269.3m
12	3	19M	63.8u	1.698m	1.670m	821.3m
13	2	7M	92.4u	1.835m	-	811.2m

Long Pulse Radar Test Signal						
Test Signal Name: LP_Signal_27						
Number of Bursts in Trial: 12						
Burst	Pulses per Burst	Chrip (Hz)	Pulse Width (s)	Pulse 1 to 2 Spacing (s)	Pulse 2 to 3 Spacing (s)	Start Location (s)
1	2	17M	99.0u	1.611m	-	688.2m
2	2	7M	86.0u	1.366m	-	62.34m
3	1	18M	76.8u	-	-	742.7m
4	1	12M	53.3u	-	-	702.9m
5	2	10M	61.3u	1.056m	-	963.1m
6	2	12M	92.1u	1.264m	-	523.9m
7	2	13M	71.9u	1.648m	-	228.1m
8	2	14M	50.9u	1.543m	-	132.5m
9	2	19M	82.8u	1.272m	-	404.6m
10	2	12M	54.3u	1.944m	-	608.1m



11	3	13M	83.8u	1.452m	1.636m	826.1m
12	2	15M	56.3u	1.499m	-	623.9m

Long Pulse Radar Test Signal						
Test Signal Name: LP_Signal_28						
Number of Bursts in Trial: 8						
Burst	Pulses per Burst	Chrip (Hz)	Pulse Width (s)	Pulse 1 to 2 Spacing (s)	Pulse 2 to 3 Spacing (s)	Start Location (s)
1	2	19M	68.8u	1.927m	-	1.385
2	1	19M	52.8u	-	-	580.2m
3	2	14M	57.0u	1.516m	-	986.0m
4	2	7M	66.1u	1.743m	-	467.6m
5	2	19M	57.5u	1.188m	-	1.044
6	3	19M	83.3u	928.7u	1.582m	842.1m
7	2	17M	72.0u	1.153m	-	1.214
8	3	5M	77.7u	1.249m	1.125m	723.3m

Long Pulse Radar Test Signal						
Test Signal Name: LP_Signal_29						
Number of Bursts in Trial: 12						
Burst	Pulses per Burst	Chrip (Hz)	Pulse Width (s)	Pulse 1 to 2 Spacing (s)	Pulse 2 to 3 Spacing (s)	Start Location (s)
1	1	11M	86.2u	-	-	13.85m
2	1	11M	86.6u	-	-	636.0m
3	1	9M	62.4u	-	-	264.7m
4	3	16M	96.9u	1.068m	1.642m	225.8m
5	2	16M	82.4u	1.474m	-	228.9m
6	1	9M	77.8u	-	-	113.5m
7	1	12M	68.0u	-	-	451.6m
8	2	5M	92.6u	1.650m	-	780.2m
9	1	18M	84.5u	-	-	367.4m
10	2	13M	98.1u	1.592m	-	865.2m
11	2	6M	89.6u	1.833m	-	563.1m
12	2	17M	66.1u	994.9u	-	912.8m

Long Pulse Radar Test Signal						
Test Signal Name: LP_Signal_30						
Number of Bursts in Trial: 14						
Burst	Pulses per Burst	Chrip (Hz)	Pulse Width (s)	Pulse 1 to 2 Spacing (s)	Pulse 2 to 3 Spacing (s)	Start Location (s)
1	3	12M	58.7u	1.625m	1.220m	521.4m
2	2	17M	76.1u	1.396m	-	610.0m
3	1	8M	86.3u	-	-	489.5m
4	3	19M	70.9u	1.508m	1.758m	325.5m
5	2	8M	70.0u	1.274m	-	705.7m
6	2	19M	75.9u	1.809m	-	247.5m
7	1	17M	81.2u	-	-	747.4m
8	2	8M	54.1u	1.498m	-	526.3m
9	3	17M	71.6u	1.521m	1.814m	636.4m
10	2	13M	97.7u	1.237m	-	220.0m
11	1	19M	87.0u	-	-	186.7m
12	2	7M	76.8u	1.736m	-	591.9m
13	2	20M	51.4u	1.174m	-	32.57m
14	1	7M	53.0u	-	-	516.1m

Type 6 Radar Statistical Performances				
Trial #	Pulses per Burst	Pulse Width (s)	PRI (s)	Detection
1	9	1.0u	333.0u	Yes
2	9	1.0u	333.0u	Yes
3	9	1.0u	333.0u	Yes
4	9	1.0u	333.0u	Yes
5	9	1.0u	333.0u	Yes
6	9	1.0u	333.0u	Yes
7	9	1.0u	333.0u	Yes
8	9	1.0u	333.0u	Yes
9	9	1.0u	333.0u	Yes
10	9	1.0u	333.0u	Yes
11	9	1.0u	333.0u	Yes
12	9	1.0u	333.0u	Yes
13	9	1.0u	333.0u	Yes
14	9	1.0u	333.0u	Yes
15	9	1.0u	333.0u	Yes
16	9	1.0u	333.0u	Yes
17	9	1.0u	333.0u	Yes
18	9	1.0u	333.0u	Yes
19	9	1.0u	333.0u	Yes
20	9	1.0u	333.0u	Yes
21	9	1.0u	333.0u	Yes
22	9	1.0u	333.0u	Yes
23	9	1.0u	333.0u	Yes
24	9	1.0u	333.0u	Yes
25	9	1.0u	333.0u	Yes
26	9	1.0u	333.0u	Yes
27	9	1.0u	333.0u	Yes
28	9	1.0u	333.0u	Yes
29	9	1.0u	333.0u	Yes
30	9	1.0u	333.0u	Yes
			Detection Rate: 100.0 %	

Type 6 Radar Statistical Performances		
Trial #	Hopping Frequency Sequence Name	Detection
1	HOP_FREQ_SEQ_01	Yes
2	HOP_FREQ_SEQ_02	Yes
3	HOP_FREQ_SEQ_03	Yes
4	HOP_FREQ_SEQ_04	Yes
5	HOP_FREQ_SEQ_05	Yes
6	HOP_FREQ_SEQ_06	Yes
7	HOP_FREQ_SEQ_07	Yes
8	HOP_FREQ_SEQ_08	Yes
9	HOP_FREQ_SEQ_09	Yes
10	HOP_FREQ_SEQ_10	Yes
11	HOP_FREQ_SEQ_11	Yes
12	HOP_FREQ_SEQ_12	Yes
13	HOP_FREQ_SEQ_13	Yes
14	HOP_FREQ_SEQ_14	Yes
15	HOP_FREQ_SEQ_15	Yes
16	HOP_FREQ_SEQ_16	Yes
17	HOP_FREQ_SEQ_17	Yes
18	HOP_FREQ_SEQ_18	Yes
19	HOP_FREQ_SEQ_19	Yes
20	HOP_FREQ_SEQ_20	Yes
21	HOP_FREQ_SEQ_21	Yes
22	HOP_FREQ_SEQ_22	Yes
23	HOP_FREQ_SEQ_23	Yes
24	HOP_FREQ_SEQ_24	Yes
25	HOP_FREQ_SEQ_25	Yes
26	HOP_FREQ_SEQ_26	Yes
27	HOP_FREQ_SEQ_27	Yes
28	HOP_FREQ_SEQ_28	Yes
29	HOP_FREQ_SEQ_29	Yes
30	HOP_FREQ_SEQ_30	Yes
		Detection Rate: 100.0 %

Hopping Frequency Sequence Name: HOP_FREQ_SEQ_01							
SEQ#	Frequency (Hz)	SEQ#	Frequency (Hz)	SEQ#	Frequency (Hz)	SEQ#	Frequency (Hz)
1	5.584G	2	5.650G	3	5.556G	4	5.372G
5	5.441G	6	5.637G	7	5.635G	8	5.288G
9	5.697G	10	5.412G	11	5.323G	12	5.452G
13	5.659G	14	5.460G	15	5.641G	16	5.681G
17	5.374G	18	5.301G	19	5.510G	20	5.468G
21	5.585G	22	5.486G	23	5.314G	24	5.677G
25	5.655G	26	5.570G	27	5.687G	28	5.675G
29	5.572G	30	5.583G	31	5.505G	32	5.698G
33	5.350G	34	5.551G	35	5.597G	36	5.707G
37	5.333G	38	5.617G	39	5.259G	40	5.663G
41	5.620G	42	5.398G	43	5.366G	44	5.685G
45	5.516G	46	5.630G	47	5.633G	48	5.445G
49	5.458G	50	5.345G	51	5.680G	52	5.592G
53	5.396G	54	5.463G	55	5.469G	56	5.672G
57	5.518G	58	5.648G	59	5.435G	60	5.297G
61	5.332G	62	5.526G	63	5.586G	64	5.609G
65	5.657G	66	5.430G	67	5.274G	68	5.471G
69	5.310G	70	5.504G	71	5.673G	72	5.281G
73	5.682G	74	5.498G	75	5.688G	76	5.544G
77	5.712G	78	5.634G	79	5.608G	80	5.282G
81	5.631G	82	5.415G	83	5.699G	84	5.360G
85	5.283G	86	5.316G	87	5.472G	88	5.449G
89	5.694G	90	5.269G	91	5.700G	92	5.294G
93	5.692G	94	5.286G	95	5.501G	96	5.689G
97	5.324G	98	5.588G	99	5.536G	100	5.579G

Hopping Frequency Sequence Name: HOP_FREQ_SEQ_02							
SEQ#	Frequency (Hz)	SEQ#	Frequency (Hz)	SEQ#	Frequency (Hz)	SEQ#	Frequency (Hz)
1	5.346G	2	5.501G	3	5.272G	4	5.295G
5	5.403G	6	5.712G	7	5.613G	8	5.429G
9	5.263G	10	5.351G	11	5.476G	12	5.323G
13	5.606G	14	5.355G	15	5.603G	16	5.402G
17	5.721G	18	5.330G	19	5.557G	20	5.354G

21	5.315G	22	5.465G	23	5.590G	24	5.704G
25	5.551G	26	5.303G	27	5.638G	28	5.493G
29	5.480G	30	5.709G	31	5.438G	32	5.255G
33	5.344G	34	5.256G	35	5.651G	36	5.460G
37	5.660G	38	5.343G	39	5.277G	40	5.436G
41	5.658G	42	5.370G	43	5.286G	44	5.446G
45	5.655G	46	5.517G	47	5.394G	48	5.360G
49	5.648G	50	5.425G	51	5.612G	52	5.620G
53	5.592G	54	5.570G	55	5.518G	56	5.298G
57	5.632G	58	5.600G	59	5.448G	60	5.258G
61	5.487G	62	5.701G	63	5.297G	64	5.449G
65	5.691G	66	5.450G	67	5.565G	68	5.348G
69	5.679G	70	5.629G	71	5.380G	72	5.453G
73	5.584G	74	5.335G	75	5.591G	76	5.705G
77	5.398G	78	5.270G	79	5.622G	80	5.514G
81	5.434G	82	5.369G	83	5.485G	84	5.301G
85	5.345G	86	5.618G	87	5.452G	88	5.441G
89	5.474G	90	5.250G	91	5.616G	92	5.710G
93	5.468G	94	5.513G	95	5.692G	96	5.334G
97	5.504G	98	5.347G	99	5.280G	100	5.400G

Hopping Frequency Sequence Name: HOP_FREQ_SEQ_03							
SEQ#	Frequency (Hz)	SEQ#	Frequency (Hz)	SEQ#	Frequency (Hz)	SEQ#	Frequency (Hz)
1	5.520G	2	5.463G	3	5.410G	4	5.684G
5	5.482G	6	5.448G	7	5.370G	8	5.610G
9	5.413G	10	5.667G	11	5.326G	12	5.381G
13	5.443G	14	5.583G	15	5.334G	16	5.642G
17	5.414G	18	5.457G	19	5.385G	20	5.412G
21	5.382G	22	5.578G	23	5.670G	24	5.465G
25	5.483G	26	5.257G	27	5.323G	28	5.674G
29	5.536G	30	5.384G	31	5.596G	32	5.722G
33	5.269G	34	5.643G	35	5.560G	36	5.628G
37	5.580G	38	5.415G	39	5.369G	40	5.636G
41	5.660G	42	5.477G	43	5.678G	44	5.492G
45	5.624G	46	5.337G	47	5.400G	48	5.698G
49	5.640G	50	5.260G	51	5.564G	52	5.403G

53	5.427G	54	5.627G	55	5.350G	56	5.611G
57	5.566G	58	5.691G	59	5.358G	60	5.648G
61	5.262G	62	5.429G	63	5.378G	64	5.590G
65	5.393G	66	5.278G	67	5.718G	68	5.312G
69	5.529G	70	5.305G	71	5.552G	72	5.650G
73	5.454G	74	5.330G	75	5.422G	76	5.341G
77	5.356G	78	5.485G	79	5.551G	80	5.588G
81	5.544G	82	5.716G	83	5.304G	84	5.659G
85	5.277G	86	5.703G	87	5.472G	88	5.575G
89	5.537G	90	5.294G	91	5.690G	92	5.380G
93	5.614G	94	5.362G	95	5.423G	96	5.311G
97	5.637G	98	5.540G	99	5.270G	100	5.302G

Hopping Frequency Sequence Name: HOP_FREQ_SEQ_04							
SEQ#	Frequency (Hz)	SEQ#	Frequency (Hz)	SEQ#	Frequency (Hz)	SEQ#	Frequency (Hz)
1	5.397G	2	5.383G	3	5.462G	4	5.338G
5	5.267G	6	5.261G	7	5.454G	8	5.500G
9	5.603G	10	5.568G	11	5.328G	12	5.467G
13	5.629G	14	5.612G	15	5.544G	16	5.375G
17	5.325G	18	5.507G	19	5.514G	20	5.433G
21	5.718G	22	5.526G	23	5.497G	24	5.520G
25	5.555G	26	5.389G	27	5.628G	28	5.511G
29	5.435G	30	5.424G	31	5.319G	32	5.453G
33	5.493G	34	5.311G	35	5.641G	36	5.415G
37	5.547G	38	5.655G	39	5.711G	40	5.579G
41	5.702G	42	5.260G	43	5.336G	44	5.278G
45	5.314G	46	5.587G	47	5.688G	48	5.598G
49	5.443G	50	5.719G	51	5.291G	52	5.428G
53	5.441G	54	5.377G	55	5.385G	56	5.315G
57	5.609G	58	5.274G	59	5.409G	60	5.546G
61	5.431G	62	5.288G	63	5.324G	64	5.341G
65	5.376G	66	5.689G	67	5.541G	68	5.422G
69	5.695G	70	5.679G	71	5.618G	72	5.465G
73	5.255G	74	5.590G	75	5.634G	76	5.388G
77	5.406G	78	5.420G	79	5.309G	80	5.362G
81	5.425G	82	5.605G	83	5.624G	84	5.374G

85	5.366G	86	5.360G	87	5.645G	88	5.297G
89	5.556G	90	5.554G	91	5.351G	92	5.596G
93	5.302G	94	5.470G	95	5.654G	96	5.299G
97	5.481G	98	5.606G	99	5.487G	100	5.343G

Hopping Frequency Sequence Name: HOP_FREQ_SEQ_05							
SEQ#	Frequency (Hz)	SEQ#	Frequency (Hz)	SEQ#	Frequency (Hz)	SEQ#	Frequency (Hz)
1	5.421G	2	5.644G	3	5.275G	4	5.412G
5	5.320G	6	5.350G	7	5.652G	8	5.620G
9	5.548G	10	5.601G	11	5.640G	12	5.450G
13	5.582G	14	5.702G	15	5.311G	16	5.349G
17	5.489G	18	5.605G	19	5.698G	20	5.407G
21	5.478G	22	5.545G	23	5.267G	24	5.658G
25	5.376G	26	5.707G	27	5.592G	28	5.696G
29	5.655G	30	5.504G	31	5.271G	32	5.416G
33	5.667G	34	5.673G	35	5.347G	36	5.700G
37	5.307G	38	5.723G	39	5.357G	40	5.522G
41	5.417G	42	5.257G	43	5.383G	44	5.419G
45	5.714G	46	5.393G	47	5.261G	48	5.508G
49	5.485G	50	5.260G	51	5.318G	52	5.628G
53	5.278G	54	5.430G	55	5.520G	56	5.392G
57	5.358G	58	5.270G	59	5.627G	60	5.557G
61	5.558G	62	5.305G	63	5.526G	64	5.314G
65	5.528G	66	5.555G	67	5.540G	68	5.380G
69	5.573G	70	5.268G	71	5.459G	72	5.482G
73	5.653G	74	5.353G	75	5.306G	76	5.324G
77	5.497G	78	5.693G	79	5.362G	80	5.514G
81	5.581G	82	5.415G	83	5.368G	84	5.599G
85	5.291G	86	5.704G	87	5.503G	88	5.564G
89	5.611G	90	5.634G	91	5.560G	92	5.300G
93	5.646G	94	5.561G	95	5.692G	96	5.633G
97	5.635G	98	5.492G	99	5.312G	100	5.690G



Hopping Frequency Sequence Name: HOP_FREQ_SEQ_06							
SEQ#	Frequency (Hz)	SEQ#	Frequency (Hz)	SEQ#	Frequency (Hz)	SEQ#	Frequency (Hz)
1	5.510G	2	5.475G	3	5.466G	4	5.512G
5	5.665G	6	5.493G	7	5.595G	8	5.412G
9	5.488G	10	5.435G	11	5.408G	12	5.263G
13	5.569G	14	5.713G	15	5.269G	16	5.687G
17	5.554G	18	5.392G	19	5.455G	20	5.592G
21	5.264G	22	5.670G	23	5.660G	24	5.614G
25	5.715G	26	5.560G	27	5.591G	28	5.461G
29	5.290G	30	5.278G	31	5.714G	32	5.365G
33	5.650G	34	5.307G	35	5.432G	36	5.641G
37	5.490G	38	5.417G	39	5.265G	40	5.457G
41	5.367G	42	5.598G	43	5.308G	44	5.669G
45	5.287G	46	5.413G	47	5.312G	48	5.389G
49	5.495G	50	5.530G	51	5.532G	52	5.525G
53	5.697G	54	5.619G	55	5.494G	56	5.577G
57	5.563G	58	5.342G	59	5.288G	60	5.313G
61	5.513G	62	5.636G	63	5.316G	64	5.428G
65	5.304G	66	5.326G	67	5.681G	68	5.584G
69	5.272G	70	5.363G	71	5.460G	72	5.468G
73	5.710G	74	5.362G	75	5.722G	76	5.262G
77	5.385G	78	5.482G	79	5.336G	80	5.390G
81	5.688G	82	5.277G	83	5.407G	84	5.393G
85	5.334G	86	5.372G	87	5.422G	88	5.322G
89	5.581G	90	5.559G	91	5.346G	92	5.380G
93	5.515G	94	5.258G	95	5.606G	96	5.406G
97	5.564G	98	5.444G	99	5.613G	100	5.526G

Hopping Frequency Sequence Name: HOP_FREQ_SEQ_07							
SEQ#	Frequency (Hz)	SEQ#	Frequency (Hz)	SEQ#	Frequency (Hz)	SEQ#	Frequency (Hz)
1	5.551G	2	5.676G	3	5.484G	4	5.572G
5	5.380G	6	5.718G	7	5.660G	8	5.644G
9	5.397G	10	5.438G	11	5.410G	12	5.256G
13	5.538G	14	5.542G	15	5.550G	16	5.480G
17	5.413G	18	5.461G	19	5.463G	20	5.369G

21	5.640G	22	5.383G	23	5.375G	24	5.488G
25	5.570G	26	5.281G	27	5.613G	28	5.282G
29	5.310G	30	5.273G	31	5.724G	32	5.622G
33	5.633G	34	5.267G	35	5.715G	36	5.523G
37	5.632G	38	5.620G	39	5.567G	40	5.589G
41	5.318G	42	5.263G	43	5.378G	44	5.716G
45	5.289G	46	5.568G	47	5.710G	48	5.516G
49	5.606G	50	5.337G	51	5.283G	52	5.717G
53	5.424G	54	5.651G	55	5.711G	56	5.707G
57	5.698G	58	5.462G	59	5.518G	60	5.445G
61	5.360G	62	5.653G	63	5.307G	64	5.341G
65	5.581G	66	5.457G	67	5.601G	68	5.345G
69	5.658G	70	5.431G	71	5.648G	72	5.253G
73	5.683G	74	5.384G	75	5.398G	76	5.459G
77	5.254G	78	5.607G	79	5.301G	80	5.417G
81	5.347G	82	5.643G	83	5.712G	84	5.514G
85	5.576G	86	5.610G	87	5.386G	88	5.381G
89	5.476G	90	5.680G	91	5.272G	92	5.477G
93	5.565G	94	5.450G	95	5.414G	96	5.343G
97	5.497G	98	5.405G	99	5.503G	100	5.577G

Hopping Frequency Sequence Name: HOP_FREQ_SEQ_08							
SEQ#	Frequency (Hz)	SEQ#	Frequency (Hz)	SEQ#	Frequency (Hz)	SEQ#	Frequency (Hz)
1	5.452G	2	5.443G	3	5.458G	4	5.492G
5	5.281G	6	5.280G	7	5.290G	8	5.685G
9	5.655G	10	5.636G	11	5.369G	12	5.320G
13	5.272G	14	5.644G	15	5.250G	16	5.695G
17	5.303G	18	5.268G	19	5.384G	20	5.351G
21	5.620G	22	5.588G	23	5.447G	24	5.283G
25	5.658G	26	5.566G	27	5.457G	28	5.476G
29	5.626G	30	5.325G	31	5.679G	32	5.590G
33	5.282G	34	5.538G	35	5.269G	36	5.539G
37	5.408G	38	5.400G	39	5.604G	40	5.371G
41	5.520G	42	5.499G	43	5.274G	44	5.352G
45	5.436G	46	5.505G	47	5.394G	48	5.617G
49	5.330G	50	5.652G	51	5.700G	52	5.317G

53	5.592G	54	5.473G	55	5.398G	56	5.573G
57	5.393G	58	5.674G	59	5.635G	60	5.546G
61	5.370G	62	5.542G	63	5.376G	64	5.561G
65	5.385G	66	5.606G	67	5.516G	68	5.613G
69	5.701G	70	5.510G	71	5.397G	72	5.332G
73	5.642G	74	5.651G	75	5.430G	76	5.551G
77	5.560G	78	5.316G	79	5.302G	80	5.382G
81	5.714G	82	5.341G	83	5.429G	84	5.693G
85	5.523G	86	5.470G	87	5.252G	88	5.420G
89	5.266G	90	5.563G	91	5.472G	92	5.601G
93	5.273G	94	5.340G	95	5.296G	96	5.333G
97	5.441G	98	5.550G	99	5.475G	100	5.678G

Hopping Frequency Sequence Name: HOP_FREQ_SEQ_09							
SEQ#	Frequency (Hz)	SEQ#	Frequency (Hz)	SEQ#	Frequency (Hz)	SEQ#	Frequency (Hz)
1	5.618G	2	5.628G	3	5.634G	4	5.468G
5	5.711G	6	5.257G	7	5.588G	8	5.445G
9	5.625G	10	5.675G	11	5.527G	12	5.470G
13	5.707G	14	5.438G	15	5.559G	16	5.499G
17	5.388G	18	5.662G	19	5.594G	20	5.394G
21	5.354G	22	5.678G	23	5.418G	24	5.332G
25	5.696G	26	5.716G	27	5.621G	28	5.450G
29	5.348G	30	5.434G	31	5.452G	32	5.368G
33	5.382G	34	5.254G	35	5.578G	36	5.377G
37	5.269G	38	5.554G	39	5.449G	40	5.430G
41	5.383G	42	5.623G	43	5.401G	44	5.399G
45	5.550G	46	5.586G	47	5.581G	48	5.308G
49	5.512G	50	5.275G	51	5.362G	52	5.363G
53	5.576G	54	5.671G	55	5.342G	56	5.381G
57	5.284G	58	5.390G	59	5.605G	60	5.455G
61	5.503G	62	5.547G	63	5.562G	64	5.429G
65	5.704G	66	5.426G	67	5.411G	68	5.613G
69	5.584G	70	5.311G	71	5.501G	72	5.537G
73	5.451G	74	5.717G	75	5.709G	76	5.695G
77	5.303G	78	5.369G	79	5.514G	80	5.570G
81	5.665G	82	5.592G	83	5.631G	84	5.253G

85	5.622G	86	5.463G	87	5.469G	88	5.518G
89	5.437G	90	5.642G	91	5.630G	92	5.398G
93	5.491G	94	5.367G	95	5.346G	96	5.425G
97	5.414G	98	5.640G	99	5.321G	100	5.393G

Hopping Frequency Sequence Name: HOP_FREQ_SEQ_10							
SEQ#	Frequency (Hz)	SEQ#	Frequency (Hz)	SEQ#	Frequency (Hz)	SEQ#	Frequency (Hz)
1	5.314G	2	5.430G	3	5.302G	4	5.313G
5	5.617G	6	5.493G	7	5.598G	8	5.300G
9	5.712G	10	5.573G	11	5.578G	12	5.340G
13	5.359G	14	5.593G	15	5.351G	16	5.451G
17	5.354G	18	5.389G	19	5.275G	20	5.625G
21	5.515G	22	5.574G	23	5.404G	24	5.552G
25	5.426G	26	5.561G	27	5.685G	28	5.555G
29	5.592G	30	5.363G	31	5.717G	32	5.347G
33	5.252G	34	5.701G	35	5.614G	36	5.608G
37	5.671G	38	5.449G	39	5.556G	40	5.371G
41	5.373G	42	5.652G	43	5.365G	44	5.304G
45	5.537G	46	5.634G	47	5.281G	48	5.647G
49	5.324G	50	5.544G	51	5.447G	52	5.437G
53	5.400G	54	5.289G	55	5.325G	56	5.505G
57	5.603G	58	5.279G	59	5.416G	60	5.446G
61	5.326G	62	5.419G	63	5.550G	64	5.409G
65	5.605G	66	5.316G	67	5.360G	68	5.540G
69	5.370G	70	5.495G	71	5.613G	72	5.467G
73	5.362G	74	5.514G	75	5.298G	76	5.559G
77	5.380G	78	5.636G	79	5.589G	80	5.470G
81	5.551G	82	5.428G	83	5.429G	84	5.716G
85	5.361G	86	5.330G	87	5.441G	88	5.402G
89	5.271G	90	5.297G	91	5.696G	92	5.691G
93	5.376G	94	5.424G	95	5.707G	96	5.307G
97	5.435G	98	5.385G	99	5.638G	100	5.563G

Hopping Frequency Sequence Name: HOP_FREQ_SEQ_11							
SEQ#	Frequency (Hz)	SEQ#	Frequency (Hz)	SEQ#	Frequency (Hz)	SEQ#	Frequency (Hz)
1	5.583G	2	5.494G	3	5.698G	4	5.598G
5	5.625G	6	5.370G	7	5.326G	8	5.606G
9	5.498G	10	5.328G	11	5.694G	12	5.709G
13	5.613G	14	5.481G	15	5.418G	16	5.677G
17	5.448G	18	5.343G	19	5.357G	20	5.554G
21	5.659G	22	5.396G	23	5.303G	24	5.419G
25	5.362G	26	5.428G	27	5.469G	28	5.268G
29	5.394G	30	5.492G	31	5.663G	32	5.720G
33	5.567G	34	5.356G	35	5.635G	36	5.372G
37	5.386G	38	5.345G	39	5.600G	40	5.412G
41	5.258G	42	5.411G	43	5.301G	44	5.618G
45	5.699G	46	5.604G	47	5.463G	48	5.542G
49	5.680G	50	5.670G	51	5.368G	52	5.589G
53	5.553G	54	5.515G	55	5.446G	56	5.304G
57	5.441G	58	5.424G	59	5.620G	60	5.263G
61	5.592G	62	5.629G	63	5.466G	64	5.556G
65	5.636G	66	5.722G	67	5.302G	68	5.656G
69	5.252G	70	5.286G	71	5.369G	72	5.723G
73	5.573G	74	5.569G	75	5.558G	76	5.250G
77	5.500G	78	5.457G	79	5.462G	80	5.562G
81	5.716G	82	5.614G	83	5.347G	84	5.565G
85	5.288G	86	5.627G	87	5.342G	88	5.696G
89	5.712G	90	5.337G	91	5.649G	92	5.538G
93	5.688G	94	5.549G	95	5.272G	96	5.447G
97	5.519G	98	5.323G	99	5.314G	100	5.706G

Hopping Frequency Sequence Name: HOP_FREQ_SEQ_12							
SEQ#	Frequency (Hz)	SEQ#	Frequency (Hz)	SEQ#	Frequency (Hz)	SEQ#	Frequency (Hz)
1	5.511G	2	5.597G	3	5.289G	4	5.670G
5	5.617G	6	5.438G	7	5.491G	8	5.682G
9	5.526G	10	5.298G	11	5.352G	12	5.714G
13	5.689G	14	5.688G	15	5.360G	16	5.431G

17	5.530G	18	5.549G	19	5.478G	20	5.411G
21	5.658G	22	5.356G	23	5.265G	24	5.345G
25	5.520G	26	5.624G	27	5.562G	28	5.674G
29	5.284G	30	5.707G	31	5.464G	32	5.502G
33	5.315G	34	5.297G	35	5.639G	36	5.469G
37	5.407G	38	5.353G	39	5.542G	40	5.458G
41	5.545G	42	5.367G	43	5.569G	44	5.687G
45	5.680G	46	5.722G	47	5.312G	48	5.465G
49	5.574G	50	5.319G	51	5.648G	52	5.702G
53	5.664G	54	5.515G	55	5.613G	56	5.504G
57	5.662G	58	5.251G	59	5.322G	60	5.448G
61	5.395G	62	5.582G	63	5.350G	64	5.563G
65	5.508G	66	5.261G	67	5.577G	68	5.393G
69	5.280G	70	5.374G	71	5.380G	72	5.519G
73	5.460G	74	5.587G	75	5.720G	76	5.653G
77	5.611G	78	5.657G	79	5.596G	80	5.642G
81	5.684G	82	5.604G	83	5.538G	84	5.415G
85	5.692G	86	5.423G	87	5.258G	88	5.336G
89	5.436G	90	5.349G	91	5.287G	92	5.427G
93	5.283G	94	5.711G	95	5.316G	96	5.638G
97	5.507G	98	5.691G	99	5.399G	100	5.610G

Hopping Frequency Sequence Name: HOP_FREQ_SEQ_13							
SEQ#	Frequency (Hz)	SEQ#	Frequency (Hz)	SEQ#	Frequency (Hz)	SEQ#	Frequency (Hz)
1	5.524G	2	5.546G	3	5.257G	4	5.323G
5	5.303G	6	5.498G	7	5.585G	8	5.653G
9	5.540G	10	5.413G	11	5.482G	12	5.462G
13	5.296G	14	5.656G	15	5.626G	16	5.631G
17	5.567G	18	5.711G	19	5.418G	20	5.374G
21	5.666G	22	5.623G	23	5.382G	24	5.408G
25	5.615G	26	5.394G	27	5.593G	28	5.657G
29	5.441G	30	5.395G	31	5.714G	32	5.607G
33	5.254G	34	5.612G	35	5.677G	36	5.717G
37	5.684G	38	5.660G	39	5.273G	40	5.415G
41	5.351G	42	5.484G	43	5.673G	44	5.610G
45	5.442G	46	5.478G	47	5.661G	48	5.563G

49	5.560G	50	5.617G	51	5.463G	52	5.459G
53	5.469G	54	5.417G	55	5.525G	56	5.555G
57	5.493G	58	5.371G	59	5.516G	60	5.663G
61	5.347G	62	5.288G	63	5.580G	64	5.350G
65	5.378G	66	5.700G	67	5.597G	68	5.324G
69	5.458G	70	5.471G	71	5.538G	72	5.599G
73	5.426G	74	5.310G	75	5.688G	76	5.333G
77	5.475G	78	5.258G	79	5.419G	80	5.701G
81	5.600G	82	5.590G	83	5.690G	84	5.528G
85	5.362G	86	5.342G	87	5.502G	88	5.414G
89	5.457G	90	5.297G	91	5.357G	92	5.509G
93	5.274G	94	5.451G	95	5.328G	96	5.539G
97	5.596G	98	5.479G	99	5.474G	100	5.284G

Hopping Frequency Sequence Name: HOP_FREQ_SEQ_14							
SEQ#	Frequency (Hz)	SEQ#	Frequency (Hz)	SEQ#	Frequency (Hz)	SEQ#	Frequency (Hz)
1	5.284G	2	5.688G	3	5.520G	4	5.344G
5	5.339G	6	5.657G	7	5.545G	8	5.607G
9	5.538G	10	5.297G	11	5.658G	12	5.600G
13	5.460G	14	5.285G	15	5.398G	16	5.264G
17	5.303G	18	5.465G	19	5.708G	20	5.443G
21	5.421G	22	5.630G	23	5.386G	24	5.357G
25	5.723G	26	5.684G	27	5.483G	28	5.551G
29	5.529G	30	5.275G	31	5.381G	32	5.444G
33	5.639G	34	5.345G	35	5.326G	36	5.506G
37	5.531G	38	5.679G	39	5.355G	40	5.649G
41	5.560G	42	5.377G	43	5.331G	44	5.428G
45	5.575G	46	5.500G	47	5.509G	48	5.656G
49	5.693G	50	5.376G	51	5.434G	52	5.327G
53	5.542G	54	5.368G	55	5.321G	56	5.349G
57	5.389G	58	5.353G	59	5.606G	60	5.494G
61	5.315G	62	5.568G	63	5.559G	64	5.278G
65	5.680G	66	5.288G	67	5.557G	68	5.405G
69	5.589G	70	5.634G	71	5.721G	72	5.350G
73	5.485G	74	5.481G	75	5.433G	76	5.296G
77	5.691G	78	5.544G	79	5.587G	80	5.599G

81	5.713G	82	5.632G	83	5.676G	84	5.307G
85	5.497G	86	5.328G	87	5.653G	88	5.578G
89	5.332G	90	5.608G	91	5.310G	92	5.445G
93	5.419G	94	5.576G	95	5.503G	96	5.549G
97	5.322G	98	5.683G	99	5.707G	100	5.698G

Hopping Frequency Sequence Name: HOP_FREQ_SEQ_15							
SEQ#	Frequency (Hz)	SEQ#	Frequency (Hz)	SEQ#	Frequency (Hz)	SEQ#	Frequency (Hz)
1	5.522G	2	5.425G	3	5.421G	4	5.722G
5	5.369G	6	5.553G	7	5.395G	8	5.265G
9	5.669G	10	5.543G	11	5.266G	12	5.490G
13	5.724G	14	5.250G	15	5.405G	16	5.579G
17	5.520G	18	5.608G	19	5.686G	20	5.404G
21	5.494G	22	5.560G	23	5.446G	24	5.367G
25	5.545G	26	5.388G	27	5.350G	28	5.402G
29	5.640G	30	5.286G	31	5.273G	32	5.680G
33	5.256G	34	5.292G	35	5.308G	36	5.481G
37	5.304G	38	5.600G	39	5.397G	40	5.299G
41	5.386G	42	5.586G	43	5.602G	44	5.444G
45	5.684G	46	5.505G	47	5.723G	48	5.613G
49	5.532G	50	5.319G	51	5.595G	52	5.370G
53	5.318G	54	5.314G	55	5.487G	56	5.531G
57	5.604G	58	5.272G	59	5.572G	60	5.598G
61	5.384G	62	5.591G	63	5.619G	64	5.695G
65	5.372G	66	5.452G	67	5.443G	68	5.269G
69	5.462G	70	5.568G	71	5.346G	72	5.422G
73	5.257G	74	5.523G	75	5.671G	76	5.307G
77	5.361G	78	5.416G	79	5.433G	80	5.617G
81	5.398G	82	5.351G	83	5.485G	84	5.650G
85	5.347G	86	5.334G	87	5.442G	88	5.276G
89	5.392G	90	5.360G	91	5.456G	92	5.468G
93	5.309G	94	5.328G	95	5.497G	96	5.337G
97	5.294G	98	5.261G	99	5.557G	100	5.665G



Hopping Frequency Sequence Name: HOP_FREQ_SEQ_16							
SEQ#	Frequency (Hz)	SEQ#	Frequency (Hz)	SEQ#	Frequency (Hz)	SEQ#	Frequency (Hz)
1	5.587G	2	5.395G	3	5.533G	4	5.319G
5	5.473G	6	5.361G	7	5.697G	8	5.549G
9	5.680G	10	5.507G	11	5.526G	12	5.374G
13	5.377G	14	5.723G	15	5.444G	16	5.457G
17	5.347G	18	5.517G	19	5.313G	20	5.412G
21	5.720G	22	5.719G	23	5.380G	24	5.410G
25	5.692G	26	5.323G	27	5.466G	28	5.506G
29	5.386G	30	5.286G	31	5.643G	32	5.681G
33	5.370G	34	5.333G	35	5.476G	36	5.498G
37	5.655G	38	5.368G	39	5.612G	40	5.254G
41	5.602G	42	5.627G	43	5.335G	44	5.404G
45	5.718G	46	5.656G	47	5.667G	48	5.431G
49	5.686G	50	5.651G	51	5.585G	52	5.649G
53	5.265G	54	5.474G	55	5.268G	56	5.631G
57	5.376G	58	5.260G	59	5.488G	60	5.521G
61	5.672G	62	5.618G	63	5.403G	64	5.610G
65	5.315G	66	5.556G	67	5.659G	68	5.420G
69	5.596G	70	5.270G	71	5.324G	72	5.546G
73	5.358G	74	5.675G	75	5.295G	76	5.568G
77	5.281G	78	5.630G	79	5.499G	80	5.263G
81	5.325G	82	5.541G	83	5.490G	84	5.371G
85	5.634G	86	5.464G	87	5.352G	88	5.326G
89	5.330G	90	5.606G	91	5.711G	92	5.381G
93	5.580G	94	5.280G	95	5.554G	96	5.362G
97	5.626G	98	5.510G	99	5.716G	100	5.441G

Hopping Frequency Sequence Name: HOP_FREQ_SEQ_17							
SEQ#	Frequency (Hz)	SEQ#	Frequency (Hz)	SEQ#	Frequency (Hz)	SEQ#	Frequency (Hz)
1	5.293G	2	5.283G	3	5.433G	4	5.556G
5	5.494G	6	5.344G	7	5.320G	8	5.656G
9	5.405G	10	5.606G	11	5.323G	12	5.358G
13	5.274G	14	5.521G	15	5.434G	16	5.546G

17	5.644G	18	5.487G	19	5.313G	20	5.676G
21	5.609G	22	5.297G	23	5.565G	24	5.377G
25	5.288G	26	5.397G	27	5.470G	28	5.299G
29	5.645G	30	5.292G	31	5.667G	32	5.473G
33	5.615G	34	5.513G	35	5.558G	36	5.447G
37	5.549G	38	5.362G	39	5.365G	40	5.465G
41	5.483G	42	5.370G	43	5.361G	44	5.702G
45	5.369G	46	5.723G	47	5.328G	48	5.278G
49	5.311G	50	5.539G	51	5.419G	52	5.554G
53	5.262G	54	5.379G	55	5.713G	56	5.493G
57	5.294G	58	5.603G	59	5.304G	60	5.340G
61	5.614G	62	5.350G	63	5.551G	64	5.626G
65	5.295G	66	5.671G	67	5.336G	68	5.694G
69	5.621G	70	5.540G	71	5.648G	72	5.391G
73	5.373G	74	5.682G	75	5.463G	76	5.672G
77	5.559G	78	5.477G	79	5.518G	80	5.607G
81	5.647G	82	5.442G	83	5.720G	84	5.590G
85	5.403G	86	5.580G	87	5.591G	88	5.637G
89	5.506G	90	5.411G	91	5.587G	92	5.543G
93	5.601G	94	5.455G	95	5.697G	96	5.668G
97	5.695G	98	5.271G	99	5.430G	100	5.514G

Hopping Frequency Sequence Name: HOP_FREQ_SEQ_18							
SEQ#	Frequency (Hz)	SEQ#	Frequency (Hz)	SEQ#	Frequency (Hz)	SEQ#	Frequency (Hz)
1	5.715G	2	5.594G	3	5.450G	4	5.473G
5	5.287G	6	5.338G	7	5.346G	8	5.288G
9	5.542G	10	5.306G	11	5.333G	12	5.472G
13	5.490G	14	5.551G	15	5.644G	16	5.651G
17	5.618G	18	5.434G	19	5.691G	20	5.666G
21	5.648G	22	5.558G	23	5.397G	24	5.316G
25	5.602G	26	5.545G	27	5.336G	28	5.701G
29	5.401G	30	5.582G	31	5.576G	32	5.429G
33	5.367G	34	5.527G	35	5.344G	36	5.286G
37	5.304G	38	5.660G	39	5.687G	40	5.631G
41	5.622G	42	5.677G	43	5.383G	44	5.296G
45	5.619G	46	5.503G	47	5.708G	48	5.482G

49	5.624G	50	5.599G	51	5.667G	52	5.298G
53	5.414G	54	5.349G	55	5.548G	56	5.615G
57	5.568G	58	5.424G	59	5.720G	60	5.271G
61	5.369G	62	5.559G	63	5.276G	64	5.356G
65	5.256G	66	5.681G	67	5.540G	68	5.263G
69	5.275G	70	5.629G	71	5.303G	72	5.433G
73	5.481G	74	5.523G	75	5.285G	76	5.407G
77	5.378G	78	5.512G	79	5.650G	80	5.278G
81	5.446G	82	5.546G	83	5.486G	84	5.564G
85	5.613G	86	5.390G	87	5.348G	88	5.468G
89	5.565G	90	5.518G	91	5.600G	92	5.311G
93	5.506G	94	5.484G	95	5.438G	96	5.381G
97	5.553G	98	5.364G	99	5.423G	100	5.343G

Hopping Frequency Sequence Name: HOP_FREQ_SEQ_19							
SEQ#	Frequency (Hz)	SEQ#	Frequency (Hz)	SEQ#	Frequency (Hz)	SEQ#	Frequency (Hz)
1	5.666G	2	5.487G	3	5.470G	4	5.359G
5	5.338G	6	5.472G	7	5.390G	8	5.708G
9	5.589G	10	5.366G	11	5.485G	12	5.519G
13	5.337G	14	5.659G	15	5.501G	16	5.405G
17	5.295G	18	5.369G	19	5.284G	20	5.425G
21	5.661G	22	5.447G	23	5.483G	24	5.267G
25	5.285G	26	5.549G	27	5.306G	28	5.473G
29	5.637G	30	5.578G	31	5.513G	32	5.605G
33	5.623G	34	5.573G	35	5.536G	36	5.663G
37	5.511G	38	5.479G	39	5.611G	40	5.510G
41	5.403G	42	5.301G	43	5.711G	44	5.706G
45	5.259G	46	5.554G	47	5.494G	48	5.254G
49	5.250G	50	5.497G	51	5.291G	52	5.543G
53	5.495G	54	5.376G	55	5.481G	56	5.325G
57	5.506G	58	5.697G	59	5.340G	60	5.378G
61	5.579G	62	5.558G	63	5.664G	64	5.364G
65	5.290G	66	5.467G	67	5.446G	68	5.417G
69	5.684G	70	5.700G	71	5.408G	72	5.545G
73	5.316G	74	5.305G	75	5.616G	76	5.329G
77	5.255G	78	5.601G	79	5.455G	80	5.486G

81	5.478G	82	5.383G	83	5.450G	84	5.358G
85	5.678G	86	5.407G	87	5.514G	88	5.718G
89	5.331G	90	5.468G	91	5.698G	92	5.507G
93	5.312G	94	5.719G	95	5.372G	96	5.570G
97	5.271G	98	5.528G	99	5.582G	100	5.644G

Hopping Frequency Sequence Name: HOP_FREQ_SEQ_20							
SEQ#	Frequency (Hz)	SEQ#	Frequency (Hz)	SEQ#	Frequency (Hz)	SEQ#	Frequency (Hz)
1	5.388G	2	5.645G	3	5.618G	4	5.275G
5	5.406G	6	5.363G	7	5.279G	8	5.639G
9	5.665G	10	5.617G	11	5.579G	12	5.691G
13	5.295G	14	5.602G	15	5.372G	16	5.484G
17	5.516G	18	5.345G	19	5.649G	20	5.597G
21	5.394G	22	5.404G	23	5.487G	24	5.483G
25	5.543G	26	5.722G	27	5.574G	28	5.353G
29	5.528G	30	5.522G	31	5.401G	32	5.467G
33	5.325G	34	5.585G	35	5.277G	36	5.264G
37	5.525G	38	5.586G	39	5.430G	40	5.350G
41	5.445G	42	5.635G	43	5.675G	44	5.285G
45	5.674G	46	5.307G	47	5.328G	48	5.338G
49	5.286G	50	5.540G	51	5.657G	52	5.313G
53	5.546G	54	5.370G	55	5.358G	56	5.611G
57	5.495G	58	5.410G	59	5.268G	60	5.640G
61	5.311G	62	5.513G	63	5.584G	64	5.562G
65	5.518G	66	5.572G	67	5.456G	68	5.680G
69	5.461G	70	5.348G	71	5.505G	72	5.340G
73	5.409G	74	5.699G	75	5.362G	76	5.714G
77	5.706G	78	5.684G	79	5.431G	80	5.463G
81	5.288G	82	5.418G	83	5.374G	84	5.270G
85	5.571G	86	5.414G	87	5.266G	88	5.322G
89	5.547G	90	5.272G	91	5.710G	92	5.327G
93	5.331G	94	5.282G	95	5.403G	96	5.560G
97	5.342G	98	5.321G	99	5.701G	100	5.504G

Hopping Frequency Sequence Name: HOP_FREQ_SEQ_21							
SEQ#	Frequency (Hz)	SEQ#	Frequency (Hz)	SEQ#	Frequency (Hz)	SEQ#	Frequency (Hz)
1	5.637G	2	5.337G	3	5.452G	4	5.302G
5	5.278G	6	5.606G	7	5.696G	8	5.579G
9	5.363G	10	5.285G	11	5.275G	12	5.484G
13	5.427G	14	5.468G	15	5.309G	16	5.607G
17	5.494G	18	5.684G	19	5.272G	20	5.697G
21	5.447G	22	5.367G	23	5.338G	24	5.504G
25	5.465G	26	5.381G	27	5.368G	28	5.471G
29	5.310G	30	5.455G	31	5.553G	32	5.626G
33	5.457G	34	5.420G	35	5.362G	36	5.621G
37	5.700G	38	5.599G	39	5.653G	40	5.615G
41	5.402G	42	5.379G	43	5.490G	44	5.715G
45	5.695G	46	5.595G	47	5.421G	48	5.609G
49	5.664G	50	5.642G	51	5.628G	52	5.674G
53	5.507G	54	5.617G	55	5.656G	56	5.493G
57	5.266G	58	5.714G	59	5.319G	60	5.441G
61	5.478G	62	5.444G	63	5.474G	64	5.575G
65	5.294G	66	5.282G	67	5.328G	68	5.462G
69	5.289G	70	5.724G	71	5.454G	72	5.306G
73	5.380G	74	5.332G	75	5.677G	76	5.374G
77	5.712G	78	5.387G	79	5.472G	80	5.542G
81	5.533G	82	5.426G	83	5.254G	84	5.669G
85	5.271G	86	5.577G	87	5.502G	88	5.403G
89	5.543G	90	5.571G	91	5.513G	92	5.479G
93	5.601G	94	5.482G	95	5.428G	96	5.614G
97	5.336G	98	5.372G	99	5.600G	100	5.470G

Hopping Frequency Sequence Name: HOP_FREQ_SEQ_22							
SEQ#	Frequency (Hz)	SEQ#	Frequency (Hz)	SEQ#	Frequency (Hz)	SEQ#	Frequency (Hz)
1	5.335G	2	5.570G	3	5.334G	4	5.433G
5	5.464G	6	5.451G	7	5.687G	8	5.586G
9	5.254G	10	5.634G	11	5.438G	12	5.722G
13	5.386G	14	5.607G	15	5.290G	16	5.262G
17	5.515G	18	5.441G	19	5.636G	20	5.270G

21	5.256G	22	5.279G	23	5.620G	24	5.447G
25	5.471G	26	5.417G	27	5.473G	28	5.708G
29	5.468G	30	5.362G	31	5.572G	32	5.563G
33	5.328G	34	5.601G	35	5.541G	36	5.629G
37	5.393G	38	5.667G	39	5.531G	40	5.313G
41	5.633G	42	5.403G	43	5.613G	44	5.553G
45	5.465G	46	5.716G	47	5.329G	48	5.356G
49	5.320G	50	5.391G	51	5.255G	52	5.276G
53	5.324G	54	5.271G	55	5.500G	56	5.646G
57	5.404G	58	5.265G	59	5.671G	60	5.616G
61	5.371G	62	5.606G	63	5.477G	64	5.467G
65	5.561G	66	5.359G	67	5.603G	68	5.407G
69	5.426G	70	5.715G	71	5.663G	72	5.680G
73	5.463G	74	5.274G	75	5.567G	76	5.721G
77	5.678G	78	5.657G	79	5.443G	80	5.338G
81	5.293G	82	5.325G	83	5.724G	84	5.402G
85	5.581G	86	5.478G	87	5.507G	88	5.669G
89	5.409G	90	5.495G	91	5.627G	92	5.519G
93	5.508G	94	5.322G	95	5.373G	96	5.382G
97	5.530G	98	5.589G	99	5.587G	100	5.580G

Hopping Frequency Sequence Name: HOP_FREQ_SEQ_23							
SEQ#	Frequency (Hz)	SEQ#	Frequency (Hz)	SEQ#	Frequency (Hz)	SEQ#	Frequency (Hz)
1	5.295G	2	5.251G	3	5.536G	4	5.257G
5	5.694G	6	5.615G	7	5.373G	8	5.529G
9	5.255G	10	5.542G	11	5.604G	12	5.280G
13	5.288G	14	5.479G	15	5.706G	16	5.600G
17	5.420G	18	5.640G	19	5.256G	20	5.260G
21	5.605G	22	5.349G	23	5.466G	24	5.576G
25	5.310G	26	5.696G	27	5.658G	28	5.284G
29	5.286G	30	5.651G	31	5.324G	32	5.570G
33	5.627G	34	5.610G	35	5.541G	36	5.505G
37	5.527G	38	5.481G	39	5.270G	40	5.301G
41	5.667G	42	5.516G	43	5.409G	44	5.299G
45	5.348G	46	5.482G	47	5.617G	48	5.586G
49	5.442G	50	5.297G	51	5.470G	52	5.296G

53	5.417G	54	5.282G	55	5.671G	56	5.676G
57	5.506G	58	5.421G	59	5.438G	60	5.345G
61	5.402G	62	5.350G	63	5.483G	64	5.577G
65	5.573G	66	5.537G	67	5.635G	68	5.426G
69	5.278G	70	5.303G	71	5.276G	72	5.591G
73	5.686G	74	5.568G	75	5.559G	76	5.712G
77	5.621G	78	5.414G	79	5.669G	80	5.398G
81	5.630G	82	5.521G	83	5.662G	84	5.619G
85	5.262G	86	5.578G	87	5.335G	88	5.401G
89	5.645G	90	5.312G	91	5.546G	92	5.292G
93	5.654G	94	5.663G	95	5.557G	96	5.628G
97	5.504G	98	5.305G	99	5.632G	100	5.624G

Hopping Frequency Sequence Name: HOP_FREQ_SEQ_24							
SEQ#	Frequency (Hz)	SEQ#	Frequency (Hz)	SEQ#	Frequency (Hz)	SEQ#	Frequency (Hz)
1	5.471G	2	5.508G	3	5.494G	4	5.442G
5	5.648G	6	5.621G	7	5.433G	8	5.405G
9	5.339G	10	5.302G	11	5.546G	12	5.502G
13	5.268G	14	5.607G	15	5.673G	16	5.406G
17	5.669G	18	5.307G	19	5.453G	20	5.670G
21	5.274G	22	5.570G	23	5.636G	24	5.484G
25	5.599G	26	5.458G	27	5.294G	28	5.595G
29	5.308G	30	5.606G	31	5.556G	32	5.402G
33	5.392G	34	5.626G	35	5.603G	36	5.416G
37	5.645G	38	5.709G	39	5.665G	40	5.407G
41	5.290G	42	5.298G	43	5.628G	44	5.314G
45	5.363G	46	5.366G	47	5.557G	48	5.321G
49	5.722G	50	5.525G	51	5.351G	52	5.390G
53	5.309G	54	5.614G	55	5.464G	56	5.281G
57	5.639G	58	5.293G	59	5.424G	60	5.413G
61	5.332G	62	5.478G	63	5.305G	64	5.398G
65	5.619G	66	5.507G	67	5.642G	68	5.299G
69	5.488G	70	5.480G	71	5.396G	72	5.682G
73	5.450G	74	5.592G	75	5.403G	76	5.374G
77	5.538G	78	5.287G	79	5.282G	80	5.537G
81	5.710G	82	5.641G	83	5.615G	84	5.358G

85	5.613G	86	5.438G	87	5.346G	88	5.386G
89	5.680G	90	5.255G	91	5.486G	92	5.379G
93	5.304G	94	5.320G	95	5.446G	96	5.720G
97	5.503G	98	5.690G	99	5.269G	100	5.306G

Hopping Frequency Sequence Name: HOP_FREQ_SEQ_25							
SEQ#	Frequency (Hz)	SEQ#	Frequency (Hz)	SEQ#	Frequency (Hz)	SEQ#	Frequency (Hz)
1	5.545G	2	5.281G	3	5.677G	4	5.635G
5	5.287G	6	5.663G	7	5.632G	8	5.290G
9	5.395G	10	5.614G	11	5.260G	12	5.396G
13	5.646G	14	5.538G	15	5.390G	16	5.611G
17	5.402G	18	5.647G	19	5.561G	20	5.397G
21	5.373G	22	5.444G	23	5.315G	24	5.300G
25	5.501G	26	5.407G	27	5.670G	28	5.514G
29	5.448G	30	5.343G	31	5.294G	32	5.382G
33	5.580G	34	5.606G	35	5.261G	36	5.329G
37	5.334G	38	5.527G	39	5.480G	40	5.666G
41	5.276G	42	5.422G	43	5.301G	44	5.639G
45	5.661G	46	5.684G	47	5.616G	48	5.369G
49	5.385G	50	5.317G	51	5.590G	52	5.253G
53	5.689G	54	5.375G	55	5.714G	56	5.693G
57	5.496G	58	5.596G	59	5.583G	60	5.529G
61	5.340G	62	5.477G	63	5.723G	64	5.656G
65	5.252G	66	5.662G	67	5.629G	68	5.622G
69	5.335G	70	5.592G	71	5.360G	72	5.333G
73	5.391G	74	5.603G	75	5.374G	76	5.665G
77	5.420G	78	5.681G	79	5.674G	80	5.368G
81	5.324G	82	5.312G	83	5.468G	84	5.319G
85	5.559G	86	5.518G	87	5.367G	88	5.275G
89	5.709G	90	5.262G	91	5.692G	92	5.582G
93	5.584G	94	5.473G	95	5.282G	96	5.331G
97	5.298G	98	5.565G	99	5.470G	100	5.626G

Hopping Frequency Sequence Name: HOP_FREQ_SEQ_26							
SEQ#	Frequency (Hz)	SEQ#	Frequency (Hz)	SEQ#	Frequency (Hz)	SEQ#	Frequency (Hz)



1	5.475G	2	5.337G	3	5.544G	4	5.723G
5	5.509G	6	5.506G	7	5.328G	8	5.327G
9	5.260G	10	5.716G	11	5.542G	12	5.256G
13	5.441G	14	5.349G	15	5.634G	16	5.680G
17	5.545G	18	5.661G	19	5.469G	20	5.704G
21	5.478G	22	5.446G	23	5.393G	24	5.521G
25	5.400G	26	5.306G	27	5.295G	28	5.280G
29	5.367G	30	5.557G	31	5.681G	32	5.471G
33	5.573G	34	5.637G	35	5.554G	36	5.444G
37	5.292G	38	5.552G	39	5.413G	40	5.588G
41	5.252G	42	5.447G	43	5.496G	44	5.582G
45	5.502G	46	5.373G	47	5.311G	48	5.415G
49	5.354G	50	5.412G	51	5.418G	52	5.685G
53	5.267G	54	5.483G	55	5.334G	56	5.626G
57	5.368G	58	5.600G	59	5.307G	60	5.498G
61	5.428G	62	5.341G	63	5.693G	64	5.569G
65	5.495G	66	5.647G	67	5.266G	68	5.481G
69	5.624G	70	5.477G	71	5.399G	72	5.422G
73	5.452G	74	5.689G	75	5.282G	76	5.296G
77	5.344G	78	5.333G	79	5.301G	80	5.595G
81	5.503G	82	5.501G	83	5.277G	84	5.358G
85	5.253G	86	5.419G	87	5.593G	88	5.456G
89	5.673G	90	5.629G	91	5.656G	92	5.671G
93	5.375G	94	5.650G	95	5.459G	96	5.678G
97	5.635G	98	5.615G	99	5.434G	100	5.575G

Hopping Frequency Sequence Name: HOP_FREQ_SEQ_27							
SEQ#	Frequency (Hz)	SEQ#	Frequency (Hz)	SEQ#	Frequency (Hz)	SEQ#	Frequency (Hz)
1	5.289G	2	5.560G	3	5.603G	4	5.697G
5	5.449G	6	5.529G	7	5.462G	8	5.262G
9	5.570G	10	5.701G	11	5.340G	12	5.274G
13	5.651G	14	5.673G	15	5.536G	16	5.712G
17	5.411G	18	5.566G	19	5.686G	20	5.376G
21	5.717G	22	5.531G	23	5.692G	24	5.295G
25	5.611G	26	5.719G	27	5.661G	28	5.667G
29	5.311G	30	5.470G	31	5.287G	32	5.561G

33	5.316G	34	5.517G	35	5.286G	36	5.604G
37	5.556G	38	5.398G	39	5.446G	40	5.350G
41	5.282G	42	5.380G	43	5.549G	44	5.480G
45	5.522G	46	5.408G	47	5.623G	48	5.416G
49	5.263G	50	5.352G	51	5.621G	52	5.674G
53	5.714G	54	5.644G	55	5.665G	56	5.412G
57	5.305G	58	5.315G	59	5.710G	60	5.251G
61	5.471G	62	5.302G	63	5.357G	64	5.575G
65	5.432G	66	5.630G	67	5.456G	68	5.720G
69	5.707G	70	5.513G	71	5.303G	72	5.330G
73	5.482G	74	5.296G	75	5.595G	76	5.457G
77	5.297G	78	5.371G	79	5.632G	80	5.643G
81	5.540G	82	5.687G	83	5.310G	84	5.684G
85	5.721G	86	5.658G	87	5.465G	88	5.341G
89	5.553G	90	5.506G	91	5.563G	92	5.463G
93	5.691G	94	5.417G	95	5.481G	96	5.472G
97	5.581G	98	5.500G	99	5.304G	100	5.568G

Hopping Frequency Sequence Name: HOP_FREQ_SEQ_28							
SEQ#	Frequency (Hz)	SEQ#	Frequency (Hz)	SEQ#	Frequency (Hz)	SEQ#	Frequency (Hz)
1	5.388G	2	5.252G	3	5.315G	4	5.290G
5	5.590G	6	5.638G	7	5.636G	8	5.550G
9	5.335G	10	5.642G	11	5.254G	12	5.566G
13	5.549G	14	5.640G	15	5.279G	16	5.499G
17	5.649G	18	5.267G	19	5.491G	20	5.587G
21	5.712G	22	5.309G	23	5.393G	24	5.260G
25	5.416G	26	5.271G	27	5.293G	28	5.366G
29	5.596G	30	5.446G	31	5.594G	32	5.624G
33	5.438G	34	5.343G	35	5.319G	36	5.313G
37	5.310G	38	5.341G	39	5.650G	40	5.263G
41	5.560G	42	5.403G	43	5.580G	44	5.508G
45	5.265G	46	5.272G	47	5.684G	48	5.479G
49	5.456G	50	5.701G	51	5.277G	52	5.620G
53	5.588G	54	5.289G	55	5.258G	56	5.611G
57	5.327G	58	5.300G	59	5.405G	60	5.564G
61	5.628G	62	5.409G	63	5.670G	64	5.255G

65	5.529G	66	5.497G	67	5.326G	68	5.496G
69	5.711G	70	5.717G	71	5.357G	72	5.724G
73	5.526G	74	5.618G	75	5.274G	76	5.441G
77	5.678G	78	5.544G	79	5.614G	80	5.418G
81	5.386G	82	5.721G	83	5.668G	84	5.379G
85	5.463G	86	5.396G	87	5.664G	88	5.353G
89	5.703G	90	5.298G	91	5.644G	92	5.307G
93	5.509G	94	5.553G	95	5.681G	96	5.589G
97	5.513G	98	5.547G	99	5.527G	100	5.295G

Hopping Frequency Sequence Name: HOP_FREQ_SEQ_29							
SEQ#	Frequency (Hz)	SEQ#	Frequency (Hz)	SEQ#	Frequency (Hz)	SEQ#	Frequency (Hz)
1	5.351G	2	5.612G	3	5.484G	4	5.268G
5	5.493G	6	5.636G	7	5.631G	8	5.693G
9	5.284G	10	5.413G	11	5.451G	12	5.706G
13	5.580G	14	5.382G	15	5.683G	16	5.344G
17	5.712G	18	5.288G	19	5.355G	20	5.361G
21	5.460G	22	5.305G	23	5.584G	24	5.594G
25	5.336G	26	5.358G	27	5.633G	28	5.335G
29	5.696G	30	5.386G	31	5.267G	32	5.517G
33	5.289G	34	5.489G	35	5.313G	36	5.568G
37	5.271G	38	5.514G	39	5.605G	40	5.511G
41	5.473G	42	5.270G	43	5.446G	44	5.626G
45	5.596G	46	5.378G	47	5.718G	48	5.582G
49	5.505G	50	5.297G	51	5.573G	52	5.672G
53	5.603G	54	5.639G	55	5.640G	56	5.346G
57	5.688G	58	5.678G	59	5.258G	60	5.657G
61	5.668G	62	5.512G	63	5.450G	64	5.254G
65	5.327G	66	5.308G	67	5.320G	68	5.434G
69	5.454G	70	5.495G	71	5.326G	72	5.457G
73	5.458G	74	5.577G	75	5.667G	76	5.622G
77	5.647G	78	5.274G	79	5.364G	80	5.628G
81	5.585G	82	5.620G	83	5.250G	84	5.609G
85	5.474G	86	5.420G	87	5.390G	88	5.638G
89	5.311G	90	5.463G	91	5.713G	92	5.412G
93	5.499G	94	5.306G	95	5.348G	96	5.279G

97	5.572G	98	5.559G	99	5.275G	100	5.680G
----	--------	----	--------	----	--------	-----	--------

Hopping Frequency Sequence Name: HOP\_FREQ\_SEQ\_30

SEQ#	Frequency (Hz)	SEQ#	Frequency (Hz)	SEQ#	Frequency (Hz)	SEQ#	Frequency (Hz)
1	5.673G	2	5.315G	3	5.496G	4	5.668G
5	5.371G	6	5.565G	7	5.279G	8	5.577G
9	5.487G	10	5.664G	11	5.641G	12	5.649G
13	5.386G	14	5.545G	15	5.687G	16	5.393G
17	5.455G	18	5.467G	19	5.480G	20	5.642G
21	5.362G	22	5.602G	23	5.704G	24	5.499G
25	5.260G	26	5.591G	27	5.357G	28	5.605G
29	5.459G	30	5.403G	31	5.328G	32	5.586G
33	5.651G	34	5.520G	35	5.684G	36	5.384G
37	5.677G	38	5.601G	39	5.259G	40	5.251G
41	5.502G	42	5.432G	43	5.346G	44	5.648G
45	5.353G	46	5.612G	47	5.283G	48	5.718G
49	5.321G	50	5.349G	51	5.369G	52	5.627G
53	5.524G	54	5.708G	55	5.381G	56	5.274G
57	5.544G	58	5.409G	59	5.611G	60	5.380G
61	5.580G	62	5.498G	63	5.468G	64	5.257G
65	5.584G	66	5.266G	67	5.509G	68	5.629G
69	5.305G	70	5.324G	71	5.395G	72	5.676G
73	5.533G	74	5.688G	75	5.449G	76	5.388G
77	5.703G	78	5.603G	79	5.262G	80	5.686G
81	5.394G	82	5.661G	83	5.450G	84	5.342G
85	5.355G	86	5.483G	87	5.540G	88	5.538G
89	5.401G	90	5.276G	91	5.526G	92	5.400G
93	5.457G	94	5.654G	95	5.559G	96	5.377G
97	5.513G	98	5.678G	99	5.549G	100	5.301G