

RF Mode	TX 802.11ac 20MHz	Channel	CH 165 : 5825 MHz
Frequency Range	1GHz ~ 40GHz	Detector Function	Peak (PK) Average (AV)

Antenna Polarity & Test Distance : Vertical at 3 m

No	Frequency (MHz)	Emission Level (dBuV/m)	Limit (dBuV/m)	Margin (dB)	Antenna Height (m)	Table Angle (Degree)	Raw Value (dBuV)	Correction Factor (dB/m)
1	#5583.17	56.4 PK	68.2	-11.8	1.46 V	210	52.1	4.3
2	*5825.00	117.0 PK			1.46 V	210	112.3	4.7
3	*5825.00	107.1 AV			1.46 V	210	102.4	4.7
4	#5983.76	61.8 PK	68.2	-6.4	1.46 V	210	56.7	5.1

Remarks:

1. Emission Level(dBuV/m) = Raw Value(dBuV) + Correction Factor(dB/m)
2. Correction Factor(dB/m) = Antenna Factor(dB/m) + Cable Factor(dB) – Pre-Amplifier Factor(dB)
3. Margin value = Emission Level – Limit value
4. The other emission levels were very low against the limit.
5. " * ": Fundamental frequency.
6. " # ": The radiated frequency is out of the restricted band.

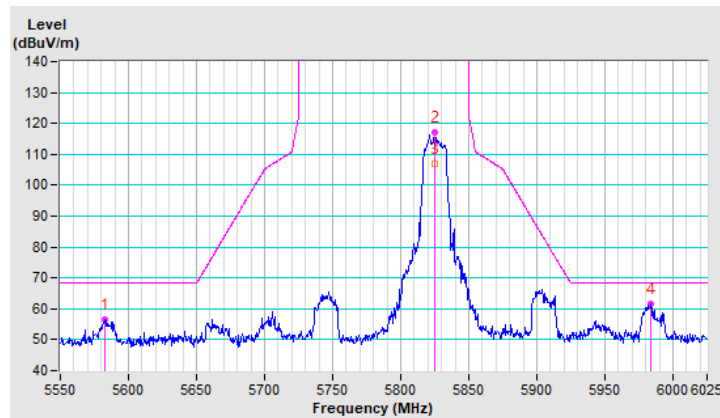

RF Mode	TX 802.11ac 40MHz	Channel	CH 38 : 5190 MHz
Frequency Range	1GHz ~ 40GHz	Detector Function	Peak (PK) Average (AV)

Antenna Polarity & Test Distance : Horizontal at 3 m

No	Frequency (MHz)	Emission Level (dBuV/m)	Limit (dBuV/m)	Margin (dB)	Antenna Height (m)	Table Angle (Degree)	Raw Value (dBuV)	Correction Factor (dB/m)
1	5150.00	60.1 PK	74.0	-13.9	1.31 H	200	55.9	4.2
2	5150.00	45.4 AV	54.0	-8.6	1.31 H	200	41.2	4.2
3	*5190.00	107.7 PK			1.31 H	200	103.7	4.0
4	*5190.00	97.9 AV			1.31 H	200	93.9	4.0

Remarks:

1. Emission Level(dBuV/m) = Raw Value(dBuV) + Correction Factor(dB/m)
2. Correction Factor(dB/m) = Antenna Factor(dB/m) + Cable Factor(dB) – Pre-Amplifier Factor(dB)
3. Margin value = Emission Level – Limit value
4. The other emission levels were very low against the limit.
5. " * ": Fundamental frequency.

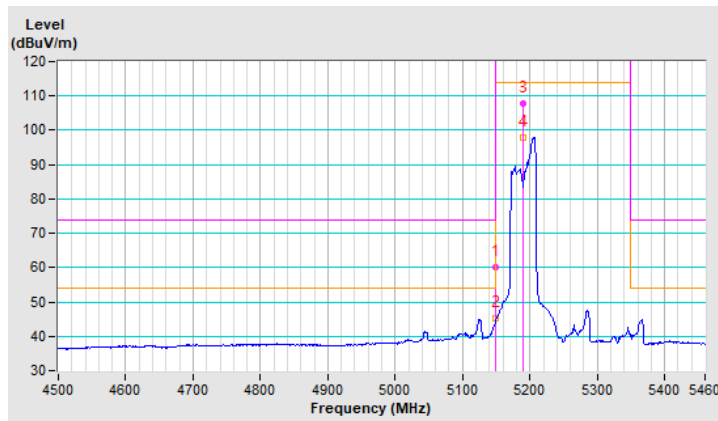

RF Mode	TX 802.11ac 40MHz	Channel	CH 38 : 5190 MHz
Frequency Range	1GHz ~ 40GHz	Detector Function	Peak (PK) Average (AV)

Antenna Polarity & Test Distance : Vertical at 3 m								
No	Frequency (MHz)	Emission Level (dBuV/m)	Limit (dBuV/m)	Margin (dB)	Antenna Height (m)	Table Angle (Degree)	Raw Value (dBuV)	Correction Factor (dB/m)
1	5150.00	64.4 PK	74.0	-9.6	1.49 V	349	60.2	4.2
2	5150.00	51.5 AV	54.0	-2.5	1.49 V	349	47.3	4.2
3	*5190.00	107.9 PK			1.49 V	349	103.9	4.0
4	*5190.00	99.4 AV			1.49 V	349	95.4	4.0

Remarks:

1. Emission Level(dBuV/m) = Raw Value(dBuV) + Correction Factor(dB/m)
2. Correction Factor(dB/m) = Antenna Factor(dB/m) + Cable Factor(dB) – Pre-Amplifier Factor(dB)
3. Margin value = Emission Level – Limit value
4. The other emission levels were very low against the limit.
5. " * ": Fundamental frequency.

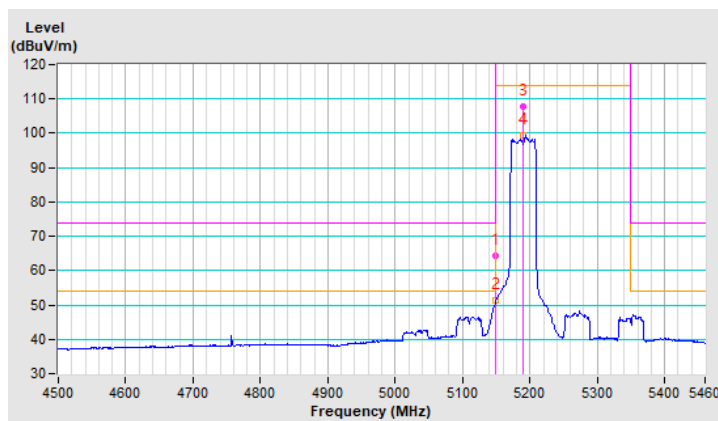

RF Mode	TX 802.11ac 40MHz	Channel	CH 46 : 5230 MHz
Frequency Range	1GHz ~ 40GHz	Detector Function	Peak (PK) Average (AV)

Antenna Polarity & Test Distance : Horizontal at 3 m								
No	Frequency (MHz)	Emission Level (dBuV/m)	Limit (dBuV/m)	Margin (dB)	Antenna Height (m)	Table Angle (Degree)	Raw Value (dBuV)	Correction Factor (dB/m)
1	5133.19	59.9 PK	74.0	-14.1	1.32 H	195	55.7	4.2
2	5133.19	49.9 AV	54.0	-4.1	1.32 H	195	45.7	4.2
3	*5230.00	112.1 PK			1.32 H	195	108.3	3.8
4	*5230.00	103.0 AV			1.32 H	195	99.2	3.8
5	5373.48	59.2 PK	74.0	-14.8	1.32 H	195	55.4	3.8
6	5373.48	48.9 AV	54.0	-5.1	1.32 H	195	45.1	3.8

Remarks:

1. Emission Level(dBuV/m) = Raw Value(dBuV) + Correction Factor(dB/m)
2. Correction Factor(dB/m) = Antenna Factor(dB/m) + Cable Factor(dB) – Pre-Amplifier Factor(dB)
3. Margin value = Emission Level – Limit value
4. The other emission levels were very low against the limit.
5. " * ": Fundamental frequency.

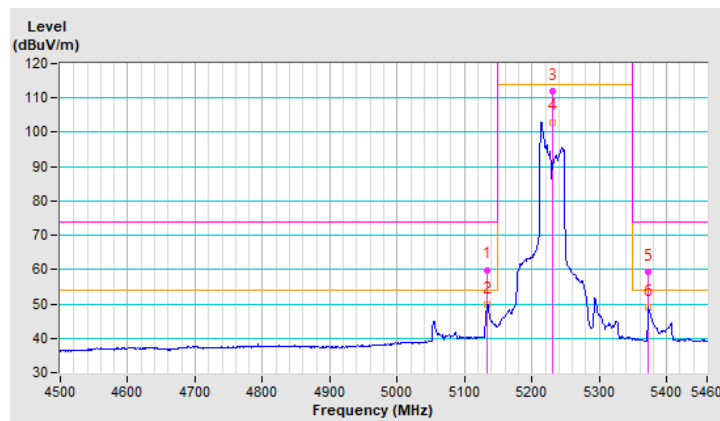

RF Mode	TX 802.11ac 40MHz	Channel	CH 46 : 5230 MHz
Frequency Range	1GHz ~ 40GHz	Detector Function	Peak (PK) Average (AV)

Antenna Polarity & Test Distance : Vertical at 3 m

No	Frequency (MHz)	Emission Level (dBuV/m)	Limit (dBuV/m)	Margin (dB)	Antenna Height (m)	Table Angle (Degree)	Raw Value (dBuV)	Correction Factor (dB/m)
1	5150.00	61.2 PK	74.0	-12.8	1.39 V	356	57.0	4.2
2	5150.00	50.4 AV	54.0	-3.6	1.39 V	356	46.2	4.2
3	*5230.00	112.7 PK			1.39 V	356	108.9	3.8
4	*5230.00	103.4 AV			1.39 V	356	99.6	3.8
5	5393.47	61.9 PK	74.0	-12.1	1.39 V	356	58.0	3.9
6	5393.47	51.2 AV	54.0	-2.8	1.39 V	356	47.3	3.9

Remarks:

1. Emission Level(dBuV/m) = Raw Value(dBuV) + Correction Factor(dB/m)
2. Correction Factor(dB/m) = Antenna Factor(dB/m) + Cable Factor(dB) – Pre-Amplifier Factor(dB)
3. Margin value = Emission Level – Limit value
4. The other emission levels were very low against the limit.
5. " * ": Fundamental frequency.

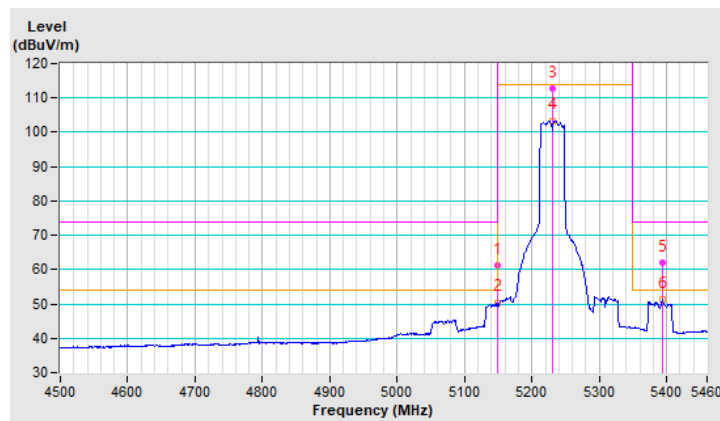

RF Mode	TX 802.11ac 40MHz	Channel	CH 151 : 5755 MHz
Frequency Range	1GHz ~ 40GHz	Detector Function	Peak (PK) Average (AV)

Antenna Polarity & Test Distance : Horizontal at 3 m								
No	Frequency (MHz)	Emission Level (dBuV/m)	Limit (dBuV/m)	Margin (dB)	Antenna Height (m)	Table Angle (Degree)	Raw Value (dBuV)	Correction Factor (dB/m)
1	#5605.72	58.2 PK	68.2	-10.0	1.55 H	174	54.0	4.2
2	*5755.00	110.6 PK			1.55 H	174	106.2	4.4
3	*5755.00	100.3 AV			1.55 H	174	95.9	4.4
4	#5930.95	55.0 PK	68.2	-13.2	1.55 H	174	50.1	4.9

Remarks:

1. Emission Level(dBuV/m) = Raw Value(dBuV) + Correction Factor(dB/m)
2. Correction Factor(dB/m) = Antenna Factor(dB/m) + Cable Factor(dB) – Pre-Amplifier Factor(dB)
3. Margin value = Emission Level – Limit value
4. The other emission levels were very low against the limit.
5. " * ": Fundamental frequency.
6. " # ": The radiated frequency is out of the restricted band.

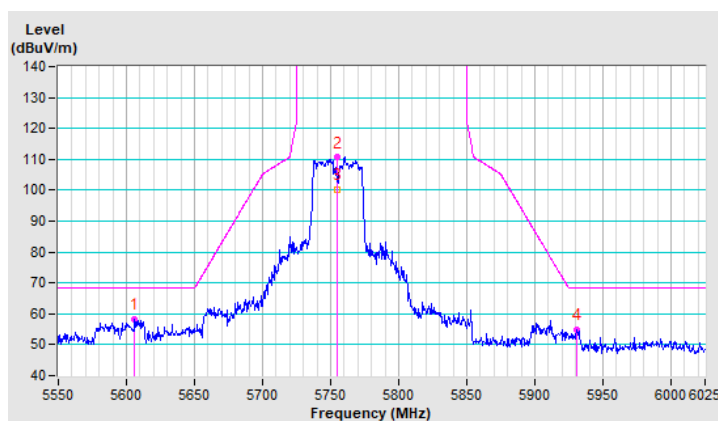

RF Mode	TX 802.11ac 40MHz	Channel	CH 151 : 5755 MHz
Frequency Range	1GHz ~ 40GHz	Detector Function	Peak (PK) Average (AV)

Antenna Polarity & Test Distance : Vertical at 3 m

No	Frequency (MHz)	Emission Level (dBuV/m)	Limit (dBuV/m)	Margin (dB)	Antenna Height (m)	Table Angle (Degree)	Raw Value (dBuV)	Correction Factor (dB/m)
1	#5585.57	56.8 PK	68.2	-11.4	1.48 V	302	52.5	4.3
2	*5755.00	114.8 PK			1.48 V	302	110.4	4.4
3	*5755.00	103.5 AV			1.48 V	302	99.1	4.4
4	#5932.48	57.9 PK	68.2	-10.3	1.48 V	302	53.0	4.9

Remarks:

1. Emission Level(dBuV/m) = Raw Value(dBuV) + Correction Factor(dB/m)
2. Correction Factor(dB/m) = Antenna Factor(dB/m) + Cable Factor(dB) – Pre-Amplifier Factor(dB)
3. Margin value = Emission Level – Limit value
4. The other emission levels were very low against the limit.
5. " * ": Fundamental frequency.
6. " # ": The radiated frequency is out of the restricted band.

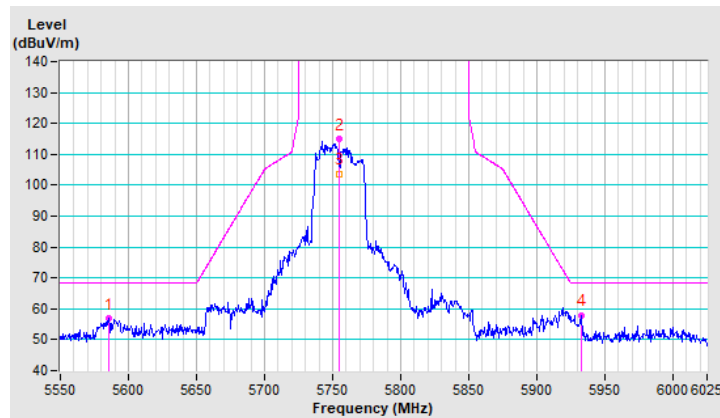

RF Mode	TX 802.11ac 40MHz	Channel	CH 159 : 5795 MHz
Frequency Range	1GHz ~ 40GHz	Detector Function	Peak (PK) Average (AV)

Antenna Polarity & Test Distance : Horizontal at 3 m								
No	Frequency (MHz)	Emission Level (dBuV/m)	Limit (dBuV/m)	Margin (dB)	Antenna Height (m)	Table Angle (Degree)	Raw Value (dBuV)	Correction Factor (dB/m)
1	#5628.90	59.3 PK	68.2	-8.9	1.53 H	171	55.0	4.3
2	*5795.00	110.8 PK			1.53 H	171	106.2	4.6
3	*5795.00	103.5 AV			1.53 H	171	98.9	4.6
4	#5943.48	55.1 PK	68.2	-13.1	1.53 H	171	50.2	4.9

Remarks:

1. Emission Level(dBuV/m) = Raw Value(dBuV) + Correction Factor(dB/m)
2. Correction Factor(dB/m) = Antenna Factor(dB/m) + Cable Factor(dB) – Pre-Amplifier Factor(dB)
3. Margin value = Emission Level – Limit value
4. The other emission levels were very low against the limit.
5. " * ": Fundamental frequency.
6. " # ": The radiated frequency is out of the restricted band.

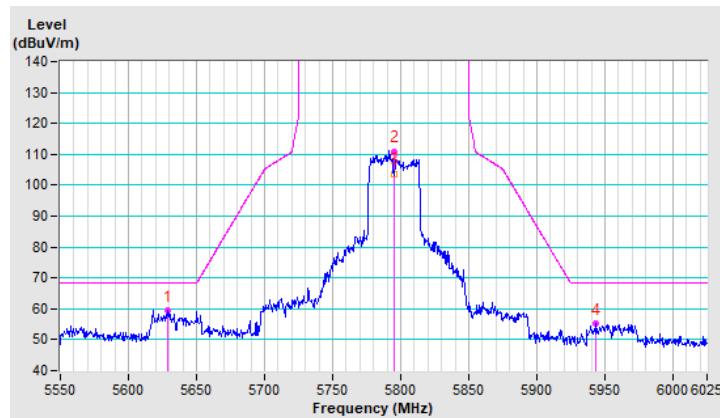

RF Mode	TX 802.11ac 40MHz	Channel	CH 159 : 5795 MHz
Frequency Range	1GHz ~ 40GHz	Detector Function	Peak (PK) Average (AV)

Antenna Polarity & Test Distance : Vertical at 3 m

No	Frequency (MHz)	Emission Level (dBuV/m)	Limit (dBuV/m)	Margin (dB)	Antenna Height (m)	Table Angle (Degree)	Raw Value (dBuV)	Correction Factor (dB/m)
1	#5637.43	58.9 PK	68.2	-9.3	1.50 V	306	54.6	4.3
2	*5795.00	114.4 PK			1.50 V	306	109.8	4.6
3	*5795.00	103.8 AV			1.50 V	306	99.2	4.6
4	#5943.30	58.3 PK	68.2	-9.9	1.50 V	306	53.4	4.9

Remarks:

1. Emission Level(dBuV/m) = Raw Value(dBuV) + Correction Factor(dB/m)
2. Correction Factor(dB/m) = Antenna Factor(dB/m) + Cable Factor(dB) – Pre-Amplifier Factor(dB)
3. Margin value = Emission Level – Limit value
4. The other emission levels were very low against the limit.
5. " * ": Fundamental frequency.
6. " # ": The radiated frequency is out of the restricted band.

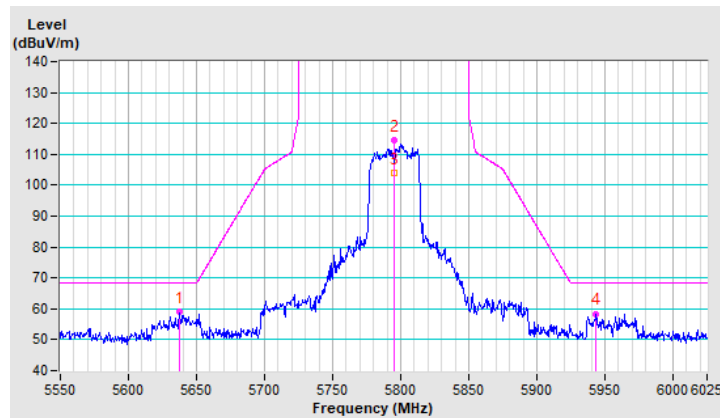

RF Mode	TX 802.11ac 80MHz	Channel	CH 42 : 5210 MHz
Frequency Range	1GHz ~ 40GHz	Detector Function	Peak (PK) Average (AV)

Antenna Polarity & Test Distance : Horizontal at 3 m								
No	Frequency (MHz)	Emission Level (dBuV/m)	Limit (dBuV/m)	Margin (dB)	Antenna Height (m)	Table Angle (Degree)	Raw Value (dBuV)	Correction Factor (dB/m)
1	5150.00	60.2 PK	74.0	-13.8	1.39 H	193	56.0	4.2
2	5150.00	46.1 AV	54.0	-7.9	1.39 H	193	41.9	4.2
3	*5210.00	102.6 PK			1.39 H	193	98.7	3.9
4	*5210.00	92.7 AV			1.39 H	193	88.8	3.9
5	5368.32	55.1 PK	74.0	-18.9	1.39 H	193	51.3	3.8
6	5368.32	41.2 AV	54.0	-12.8	1.39 H	193	37.4	3.8

Remarks:

1. Emission Level(dBuV/m) = Raw Value(dBuV) + Correction Factor(dB/m)
2. Correction Factor(dB/m) = Antenna Factor(dB/m) + Cable Factor(dB) – Pre-Amplifier Factor(dB)
3. Margin value = Emission Level – Limit value
4. The other emission levels were very low against the limit.
5. " * ": Fundamental frequency.

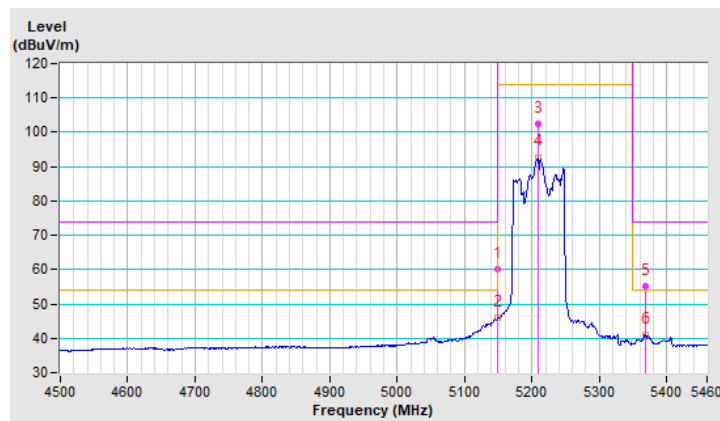

RF Mode	TX 802.11ac 80MHz	Channel	CH 42 : 5210 MHz
Frequency Range	1GHz ~ 40GHz	Detector Function	Peak (PK) Average (AV)

Antenna Polarity & Test Distance : Vertical at 3 m

No	Frequency (MHz)	Emission Level (dBuV/m)	Limit (dBuV/m)	Margin (dB)	Antenna Height (m)	Table Angle (Degree)	Raw Value (dBuV)	Correction Factor (dB/m)
1	5150.00	65.1 PK	74.0	-8.9	1.49 V	348	60.9	4.2
2	5150.00	51.5 AV	54.0	-2.5	1.49 V	348	47.3	4.2
3	*5210.00	105.6 PK			1.49 V	348	101.7	3.9
4	*5210.00	94.9 AV			1.49 V	348	91.0	3.9
5	5359.49	55.9 PK	74.0	-18.1	1.49 V	348	52.1	3.8
6	5359.49	44.4 AV	54.0	-9.6	1.49 V	348	40.6	3.8

Remarks:

1. Emission Level(dBuV/m) = Raw Value(dBuV) + Correction Factor(dB/m)
2. Correction Factor(dB/m) = Antenna Factor(dB/m) + Cable Factor(dB) – Pre-Amplifier Factor(dB)
3. Margin value = Emission Level – Limit value
4. The other emission levels were very low against the limit.
5. " * ": Fundamental frequency.

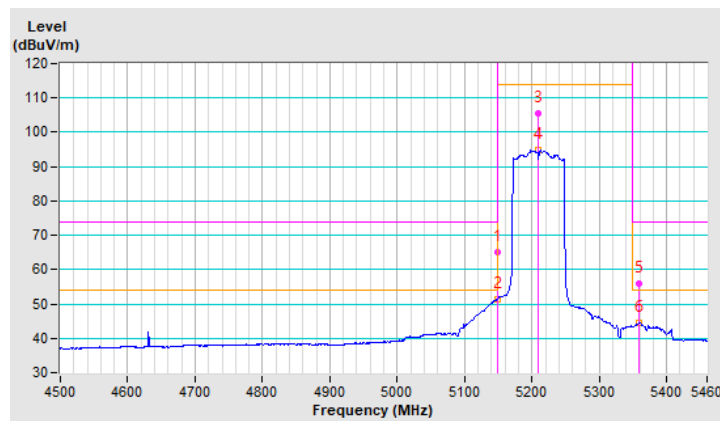

RF Mode	TX 802.11ac 80MHz	Channel	CH 155 : 5775 MHz
Frequency Range	1GHz ~ 40GHz	Detector Function	Peak (PK) Average (AV)

Antenna Polarity & Test Distance : Horizontal at 3 m								
No	Frequency (MHz)	Emission Level (dBuV/m)	Limit (dBuV/m)	Margin (dB)	Antenna Height (m)	Table Angle (Degree)	Raw Value (dBuV)	Correction Factor (dB/m)
1	#5647.12	67.0 PK	68.2	-1.2	1.49 H	169	62.6	4.4
2	*5775.00	109.2 PK			1.49 H	169	104.7	4.5
3	*5775.00	98.9 AV			1.49 H	169	94.4	4.5
4	#5927.87	58.6 PK	68.2	-9.6	1.49 H	169	53.7	4.9

Remarks:

1. Emission Level(dBuV/m) = Raw Value(dBuV) + Correction Factor(dB/m)
2. Correction Factor(dB/m) = Antenna Factor(dB/m) + Cable Factor(dB) – Pre-Amplifier Factor(dB)
3. Margin value = Emission Level – Limit value
4. The other emission levels were very low against the limit.
5. " * ": Fundamental frequency.
6. " # ": The radiated frequency is out of the restricted band.

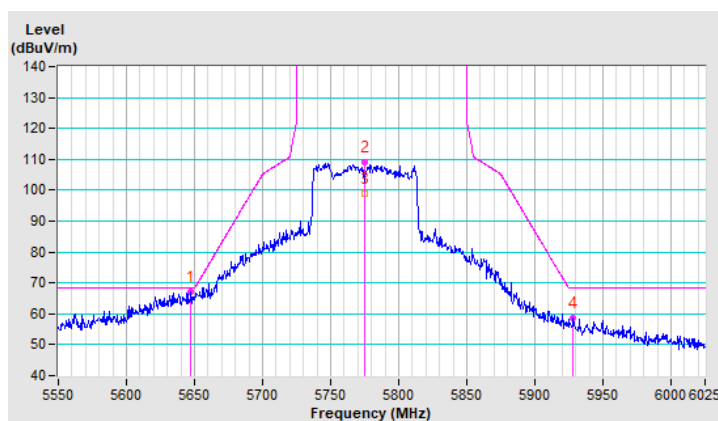

RF Mode	TX 802.11ac 80MHz	Channel	CH 155 : 5775 MHz
Frequency Range	1GHz ~ 40GHz	Detector Function	Peak (PK) Average (AV)

Antenna Polarity & Test Distance : Vertical at 3 m

No	Frequency (MHz)	Emission Level (dBuV/m)	Limit (dBuV/m)	Margin (dB)	Antenna Height (m)	Table Angle (Degree)	Raw Value (dBuV)	Correction Factor (dB/m)
1	#5647.61	63.5 PK	68.2	-4.7	1.51 V	301	59.1	4.4
2	*5775.00	112.8 PK			1.51 V	301	108.3	4.5
3	*5775.00	100.4 AV			1.51 V	301	95.9	4.5
4	#5925.01	59.6 PK	68.2	-8.6	1.51 V	301	54.7	4.9

Remarks:

1. Emission Level(dBuV/m) = Raw Value(dBuV) + Correction Factor(dB/m)
2. Correction Factor(dB/m) = Antenna Factor(dB/m) + Cable Factor(dB) – Pre-Amplifier Factor(dB)
3. Margin value = Emission Level – Limit value
4. The other emission levels were very low against the limit.
5. " * ": Fundamental frequency.
6. " # ": The radiated frequency is out of the restricted band.

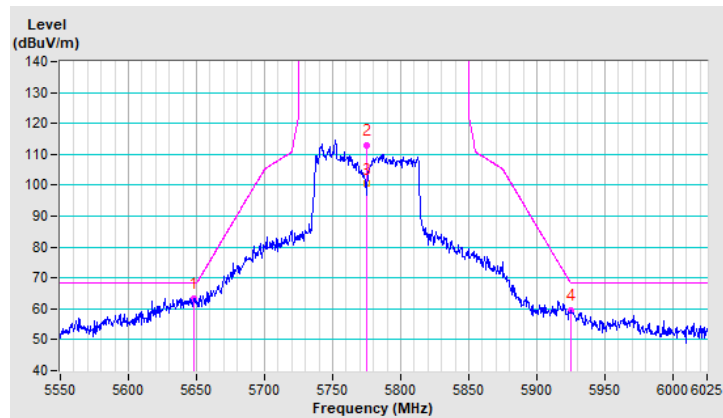

4.7 Frequency Stability Measurement

4.7.1 Limit

Manufacturers of U-NII devices are responsible for ensuring frequency stability such that an emissions is maintained within the band of operation under all conditions of normal operation as specified in the user's manual or ± 20 ppm (IEEE 802.11n specification).

4.7.2 Measuring Instruments and Setting

Please refer to section 5 of instruments list in this report. The following table is the setting of the spectrum analyzer and receiver.

Spectrum Parameter	Setting
Attenuation	Auto
Span Frequency	Entire absence of modulation emissions bandwidth
RB	10 kHz
VB	10 kHz
Sweep Time	Auto

4.7.3 Test Procedure

- 1 The EUT was placed inside the environmental test chamber and powered by nominal DC voltage.
- 2 The EUT was programmed to be in continuously un-modulation transmitting mode.
- 3 Set the spectrum analyzer span to view the entire un-modulation emissions bandwidth.
- 4 Turn the EUT on and couple its output to a spectrum analyzer.
- 5 Turn the EUT off and set the chamber to the highest temperature specified.
- 6 Allow sufficient time (approximately 30 min) for the temperature of the chamber to stabilize, turn the EUT on and measure the operating frequency after 2, 5, and 10 minutes.
- 7 Extreme temperature rule is $-30^{\circ}\text{C} \sim 50^{\circ}\text{C}$.
- 8 Repeat step 4 and 5 with the temperature chamber set to the lowest temperature.
- 9 The test chamber was allowed to stabilize at $+20$ degree C for a minimum of 30 minutes. The supply voltage was then adjusted on the EUT from 85% to 115% and the frequency record.

4.7.4 Test Setup Layout

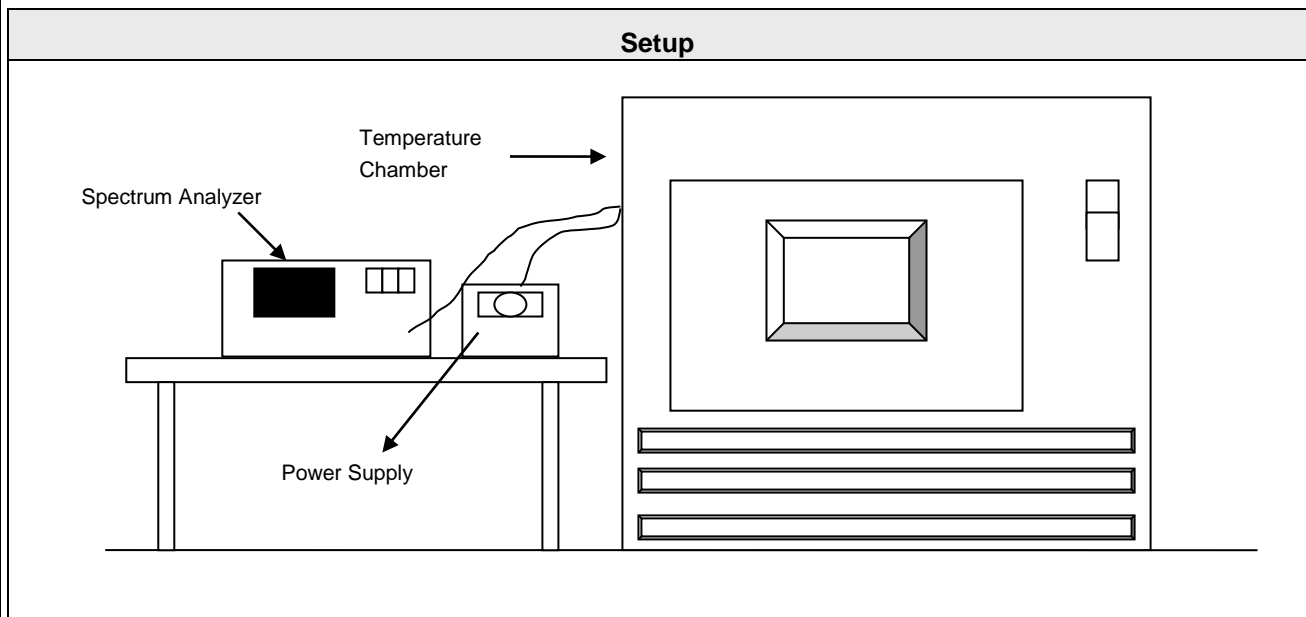

4.7.5 Test Deviation

There are no deviations with the original standard.

4.7.6 EUT Operating Conditions

The EUT was programmed to be in continuously un-modulation transmitting mode.

4.7.7 Test Results

Temperature	25°C	Humidity	60%
Test Engineer	Kevin Ko		

For 20MHz

Frequency Stability Versus Temp.									
Operating Frequency: 5180 MHz									
TEMP. (°C)	POWER SUPPLY (Vac)	0 MINUTE		2 MINUTES		5 MINUTES		10 MINUTES	
		Measured Frequency (MHz)	Pass/ Fail	Measured Frequency (MHz)	Pass/ Fail	Measured Frequency (MHz)	Pass/ Fail	Measured Frequency (MHz)	Pass/ Fail
45	120	5180.0086	PASS	5180.0086	PASS	5180.0081	PASS	5180.0085	PASS
40	120	5179.9797	PASS	5179.9807	PASS	5179.9813	PASS	5179.983	PASS
30	120	5180.0214	PASS	5180.0168	PASS	5180.0183	PASS	5180.0195	PASS
20	120	5180.0174	PASS	5180.0185	PASS	5180.0165	PASS	5180.0142	PASS
10	120	5180.0031	PASS	5180.0052	PASS	5180.0036	PASS	5180.0016	PASS
0	120	5180.018	PASS	5180.0206	PASS	5180.0185	PASS	5180.0214	PASS
-5	120	5180.0193	PASS	5180.0191	PASS	5180.0228	PASS	5180.0228	PASS
Max. Deviation (ppm)		4.131274	PASS	3.976834	PASS	4.401544	PASS	4.401544	PASS
IEEE Limit (ppm)		±20ppm							

Frequency Stability Versus Voltage									
Operating Frequency: 5180 MHz									
TEMP. (°C)	POWER SUPPLY (Vac)	0 MINUTE		2 MINUTES		5 MINUTES		10 MINUTES	
		Measured Frequency (MHz)	Pass/ Fail	Measured Frequency (MHz)	Pass/ Fail	Measured Frequency (MHz)	Pass/ Fail	Measured Frequency (MHz)	Pass/ Fail
20	138	5180.0178	PASS	5180.0187	PASS	5180.0167	PASS	5180.0142	PASS
	120	5180.0174	PASS	5180.0185	PASS	5180.0165	PASS	5180.0142	PASS
	102	5180.0178	PASS	5180.0194	PASS	5180.0159	PASS	5180.0137	PASS
Max. Deviation (ppm)		3.436293	PASS	3.745174	PASS	3.223938	PASS	2.741313	PASS
IEEE Limit (ppm)		±20ppm							

Frequency Stability Versus Temp.

Operating Frequency: 5200 MHz

TEMP. (°C)	POWER SUPPLY (Vac)	0 MINUTE		2 MINUTES		5 MINUTES		10 MINUTES	
		Measured Frequency (MHz)	Pass/ Fail	Measured Frequency (MHz)	Pass/ Fail	Measured Frequency (MHz)	Pass/ Fail	Measured Frequency (MHz)	Pass/ Fail
45	120	5200.0076	PASS	5200.0055	PASS	5200.0051	PASS	5200.0037	PASS
40	120	5199.991	PASS	5199.9948	PASS	5199.9917	PASS	5199.9915	PASS
30	120	5199.9778	PASS	5199.979	PASS	5199.9795	PASS	5199.977	PASS
20	120	5200.0107	PASS	5200.0073	PASS	5200.007	PASS	5200.0109	PASS
10	120	5200.0101	PASS	5200.0135	PASS	5200.0128	PASS	5200.0102	PASS
0	120	5199.9882	PASS	5199.9905	PASS	5199.9914	PASS	5199.991	PASS
-5	120	5200.0086	PASS	5200.0074	PASS	5200.0106	PASS	5200.0084	PASS
Max. Deviation (ppm)		-4.269231	PASS	-4.038462	PASS	-3.942308	PASS	-4.423077	PASS
IEEE Limit (ppm)		±20ppm							

Frequency Stability Versus Voltage

Operating Frequency: 5200 MHz

TEMP. (°C)	POWER SUPPLY (Vac)	0 MINUTE		2 MINUTES		5 MINUTES		10 MINUTES	
		Measured Frequency (MHz)	Pass/ Fail	Measured Frequency (MHz)	Pass/ Fail	Measured Frequency (MHz)	Pass/ Fail	Measured Frequency (MHz)	Pass/ Fail
20	138	5200.0112	PASS	5200.0082	PASS	5200.0078	PASS	5200.0101	PASS
	120	5200.0107	PASS	5200.0073	PASS	5200.007	PASS	5200.0109	PASS
	102	5200.0098	PASS	5200.0063	PASS	5200.0074	PASS	5200.0109	PASS
Max. Deviation (ppm)		2.153846	PASS	1.576923	PASS	1.500000	PASS	2.096154	PASS
IEEE Limit (ppm)		±20ppm							

Frequency Stability Versus Temp.

Operating Frequency: 5240 MHz

TEMP. (°C)	POWER SUPPLY (Vac)	0 MINUTE		2 MINUTES		5 MINUTES		10 MINUTES	
		Measured Frequency (MHz)	Pass/ Fail	Measured Frequency (MHz)	Pass/ Fail	Measured Frequency (MHz)	Pass/ Fail	Measured Frequency (MHz)	Pass/ Fail
45	120	5239.9789	PASS	5239.9822	PASS	5239.9799	PASS	5239.979	PASS
40	120	5240.005	PASS	5240.0049	PASS	5240.0028	PASS	5240.0017	PASS
30	120	5240.0036	PASS	5240.0021	PASS	5240.0038	PASS	5240.0042	PASS
20	120	5239.9802	PASS	5239.981	PASS	5239.9801	PASS	5239.9764	PASS
10	120	5240.016	PASS	5240.0159	PASS	5240.0178	PASS	5240.017	PASS
0	120	5240.0031	PASS	5240.0051	PASS	5240.0035	PASS	5240.0068	PASS
-5	120	5239.991	PASS	5239.9901	PASS	5239.9914	PASS	5239.9891	PASS
Max. Deviation (ppm)		-4.026718	PASS	-3.625954	PASS	-3.835878	PASS	-4.503817	PASS
IEEE Limit (ppm)		±20ppm							

Frequency Stability Versus Voltage

Operating Frequency: 5240 MHz

TEMP. (°C)	POWER SUPPLY (Vac)	0 MINUTE		2 MINUTES		5 MINUTES		10 MINUTES	
		Measured Frequency (MHz)	Pass/ Fail	Measured Frequency (MHz)	Pass/ Fail	Measured Frequency (MHz)	Pass/ Fail	Measured Frequency (MHz)	Pass/ Fail
20	138	5239.9795	PASS	5239.9811	PASS	5239.9811	PASS	5239.977	PASS
	120	5239.9802	PASS	5239.981	PASS	5239.9801	PASS	5239.9764	PASS
	102	5239.9804	PASS	5239.9809	PASS	5239.9802	PASS	5239.9767	PASS
Max. Deviation (ppm)		-3.912214	PASS	-3.645038	PASS	-3.797710	PASS	-4.503817	PASS
IEEE Limit (ppm)		±20ppm							

Frequency Stability Versus Temp.

Operating Frequency: 5745 MHz

TEMP. (°C)	POWER SUPPLY (Vac)	0 MINUTE		2 MINUTES		5 MINUTES		10 MINUTES	
		Measured Frequency (MHz)	Pass/ Fail	Measured Frequency (MHz)	Pass/ Fail	Measured Frequency (MHz)	Pass/ Fail	Measured Frequency (MHz)	Pass/ Fail
45	120	5744.9882	PASS	5744.991	PASS	5744.9872	PASS	5744.9857	PASS
40	120	5744.9712	PASS	5744.971	PASS	5744.9731	PASS	5744.9761	PASS
30	120	5744.976	PASS	5744.9812	PASS	5744.9816	PASS	5744.9816	PASS
20	120	5744.9891	PASS	5744.9855	PASS	5744.9904	PASS	5744.9869	PASS
10	120	5744.9965	PASS	5744.9963	PASS	5744.9928	PASS	5744.9932	PASS
0	120	5745.0105	PASS	5745.0095	PASS	5745.0064	PASS	5745.0074	PASS
-5	120	5745.0081	PASS	5745.0088	PASS	5745.0068	PASS	5745.0112	PASS
Max. Deviation (ppm)		-5.013055	PASS	-5.047868	PASS	-4.682332	PASS	-4.160139	PASS
IEEE Limit (ppm)		±20ppm							

Frequency Stability Versus Voltage

Operating Frequency: 5745 MHz

TEMP. (°C)	POWER SUPPLY (Vac)	0 MINUTE		2 MINUTES		5 MINUTES		10 MINUTES	
		Measured Frequency (MHz)	Pass/ Fail	Measured Frequency (MHz)	Pass/ Fail	Measured Frequency (MHz)	Pass/ Fail	Measured Frequency (MHz)	Pass/ Fail
20	138	5744.9889	PASS	5744.9853	PASS	5744.9905	PASS	5744.988	PASS
	120	5744.9891	PASS	5744.9855	PASS	5744.9904	PASS	5744.9869	PASS
	102	5744.9886	PASS	5744.9856	PASS	5744.9906	PASS	5744.988	PASS
Max. Deviation (ppm)		-1.984334	PASS	-2.558747	PASS	-1.671018	PASS	-2.280244	PASS
IEEE Limit (ppm)		±20ppm							

Frequency Stability Versus Temp.

Operating Frequency: 5785 MHz

TEMP. (°C)	POWER SUPPLY (Vac)	0 MINUTE		2 MINUTES		5 MINUTES		10 MINUTES	
		Measured Frequency (MHz)	Pass/ Fail	Measured Frequency (MHz)	Pass/ Fail	Measured Frequency (MHz)	Pass/ Fail	Measured Frequency (MHz)	Pass/ Fail
45	120	5785.0018	PASS	5784.9991	PASS	5785.0004	PASS	5785.002	PASS
40	120	5785.0193	PASS	5785.0224	PASS	5785.0193	PASS	5785.0196	PASS
30	120	5785.0192	PASS	5785.0172	PASS	5785.0196	PASS	5785.0168	PASS
20	120	5784.9967	PASS	5784.9998	PASS	5784.9996	PASS	5784.9977	PASS
10	120	5784.9719	PASS	5784.9744	PASS	5784.9724	PASS	5784.9759	PASS
0	120	5785.0292	PASS	5785.0278	PASS	5785.0259	PASS	5785.0307	PASS
-5	120	5785.0183	PASS	5785.019	PASS	5785.0218	PASS	5785.0213	PASS
Max. Deviation (ppm)		5.047537	PASS	4.805532	PASS	4.477096	PASS	5.306828	PASS
IEEE Limit (ppm)		±20ppm							

Frequency Stability Versus Voltage

Operating Frequency: 5785 MHz

TEMP. (°C)	POWER SUPPLY (Vac)	0 MINUTE		2 MINUTES		5 MINUTES		10 MINUTES	
		Measured Frequency (MHz)	Pass/ Fail	Measured Frequency (MHz)	Pass/ Fail	Measured Frequency (MHz)	Pass/ Fail	Measured Frequency (MHz)	Pass/ Fail
20	138	5784.9975	PASS	5785.0004	PASS	5784.9991	PASS	5784.9979	PASS
	120	5784.9967	PASS	5784.9998	PASS	5784.9996	PASS	5784.9977	PASS
	102	5784.9961	PASS	5785.0009	PASS	5784.9989	PASS	5784.9985	PASS
Max. Deviation (ppm)		-0.674157	PASS	0.155575	PASS	-0.190147	PASS	-0.397580	PASS
IEEE Limit (ppm)		±20ppm							

Frequency Stability Versus Temp.

Operating Frequency: 5825 MHz

TEMP. (°C)	POWER SUPPLY (Vac)	0 MINUTE		2 MINUTES		5 MINUTES		10 MINUTES	
		Measured Frequency (MHz)	Pass/ Fail	Measured Frequency (MHz)	Pass/ Fail	Measured Frequency (MHz)	Pass/ Fail	Measured Frequency (MHz)	Pass/ Fail
45	120	5824.9981	PASS	5824.994	PASS	5824.994	PASS	5824.9948	PASS
40	120	5824.9935	PASS	5824.9896	PASS	5824.9915	PASS	5824.9918	PASS
30	120	5824.9876	PASS	5824.9899	PASS	5824.9905	PASS	5824.9907	PASS
20	120	5825.0201	PASS	5825.0195	PASS	5825.018	PASS	5825.017	PASS
10	120	5824.9816	PASS	5824.9819	PASS	5824.9832	PASS	5824.982	PASS
0	120	5824.9952	PASS	5824.9923	PASS	5824.9934	PASS	5824.9952	PASS
-5	120	5824.9996	PASS	5825.0024	PASS	5825.0038	PASS	5825.0003	PASS
Max. Deviation (ppm)		3.450644	PASS	3.347639	PASS	3.090129	PASS	2.918455	PASS
IEEE Limit (ppm)		±20ppm							

Frequency Stability Versus Voltage

Operating Frequency: 5825 MHz

TEMP. (°C)	POWER SUPPLY (Vac)	0 MINUTE		2 MINUTES		5 MINUTES		10 MINUTES	
		Measured Frequency (MHz)	Pass/ Fail	Measured Frequency (MHz)	Pass/ Fail	Measured Frequency (MHz)	Pass/ Fail	Measured Frequency (MHz)	Pass/ Fail
20	138	5825.0195	PASS	5825.0189	PASS	5825.0169	PASS	5825.0168	PASS
	120	5825.0201	PASS	5825.0195	PASS	5825.018	PASS	5825.017	PASS
	102	5825.0192	PASS	5825.0205	PASS	5825.0171	PASS	5825.0179	PASS
Max. Deviation (ppm)		3.450644	PASS	3.519313	PASS	3.090129	PASS	3.072961	PASS
IEEE Limit (ppm)		±20ppm							

40MHz

Frequency Stability Versus Temp.									
Operating Frequency: 5190 MHz									
TEMP. (°C)	POWER SUPPLY (Vac)	0 MINUTE		2 MINUTES		5 MINUTES		10 MINUTES	
		Measured Frequency (MHz)	Pass/ Fail	Measured Frequency (MHz)	Pass/ Fail	Measured Frequency (MHz)	Pass/ Fail	Measured Frequency (MHz)	Pass/ Fail
45	120	5189.9782	PASS	5189.9776	PASS	5189.9779	PASS	5189.9809	PASS
40	120	5189.9773	PASS	5189.9755	PASS	5189.9745	PASS	5189.9766	PASS
30	120	5189.982	PASS	5189.9831	PASS	5189.9835	PASS	5189.984	PASS
20	120	5189.9795	PASS	5189.9827	PASS	5189.9812	PASS	5189.9806	PASS
10	120	5190.0175	PASS	5190.0179	PASS	5190.0198	PASS	5190.0202	PASS
0	120	5189.9862	PASS	5189.9855	PASS	5189.9879	PASS	5189.9857	PASS
-5	120	5189.9827	PASS	5189.9823	PASS	5189.9831	PASS	5189.9836	PASS
Max. Deviation (ppm)		-4.373796	PASS	-4.720617	PASS	-4.913295	PASS	-4.508671	PASS
IEEE Limit (ppm)		±20ppm							

Frequency Stability Versus Voltage									
Operating Frequency: 5190 MHz									
TEMP. (°C)	POWER SUPPLY (Vac)	0 MINUTE		2 MINUTES		5 MINUTES		10 MINUTES	
		Measured Frequency (MHz)	Pass/ Fail	Measured Frequency (MHz)	Pass/ Fail	Measured Frequency (MHz)	Pass/ Fail	Measured Frequency (MHz)	Pass/ Fail
20	138	5189.979	PASS	5189.9824	PASS	5189.9803	PASS	5189.9809	PASS
	120	5189.9795	PASS	5189.9827	PASS	5189.9812	PASS	5189.9806	PASS
	102	5189.9804	PASS	5189.9822	PASS	5189.982	PASS	5189.9801	PASS
Max. Deviation (ppm)		-4.046243	PASS	-3.429672	PASS	-3.795761	PASS	-3.834297	PASS
IEEE Limit (ppm)		±20ppm							

Frequency Stability Versus Temp.

Operating Frequency: 5230 MHz

TEMP. (°C)	POWER SUPPLY (Vac)	0 MINUTE		2 MINUTES		5 MINUTES		10 MINUTES	
		Measured Frequency (MHz)	Pass/ Fail	Measured Frequency (MHz)	Pass/ Fail	Measured Frequency (MHz)	Pass/ Fail	Measured Frequency (MHz)	Pass/ Fail
45	120	5229.9958	PASS	5229.9957	PASS	5229.9954	PASS	5229.994	PASS
40	120	5230.0142	PASS	5230.0171	PASS	5230.014	PASS	5230.014	PASS
30	120	5229.993	PASS	5229.9904	PASS	5229.9897	PASS	5229.9946	PASS
20	120	5230.0033	PASS	5229.9991	PASS	5230.0028	PASS	5230.0023	PASS
10	120	5229.9724	PASS	5229.977	PASS	5229.9755	PASS	5229.9751	PASS
0	120	5229.9807	PASS	5229.9795	PASS	5229.9819	PASS	5229.9808	PASS
-5	120	5230.0021	PASS	5230.0021	PASS	5229.9999	PASS	5230.0011	PASS
Max. Deviation (ppm)		-5.277247	PASS	-4.397706	PASS	-4.684512	PASS	-4.760994	PASS
IEEE Limit (ppm)		±20ppm							

Frequency Stability Versus Voltage

Operating Frequency: 5230 MHz

TEMP. (°C)	POWER SUPPLY (Vac)	0 MINUTE		2 MINUTES		5 MINUTES		10 MINUTES	
		Measured Frequency (MHz)	Pass/ Fail	Measured Frequency (MHz)	Pass/ Fail	Measured Frequency (MHz)	Pass/ Fail	Measured Frequency (MHz)	Pass/ Fail
20	138	5230.0041	PASS	5229.9999	PASS	5230.0036	PASS	5230.0013	PASS
	120	5230.0033	PASS	5229.9991	PASS	5230.0028	PASS	5230.0023	PASS
	102	5230.0034	PASS	5229.9994	PASS	5230.0036	PASS	5230.0015	PASS
Max. Deviation (ppm)		0.783939	PASS	-0.172084	PASS	0.688337	PASS	0.439771	PASS
IEEE Limit (ppm)		±20ppm							

Frequency Stability Versus Temp.

Operating Frequency: 5755 MHz

TEMP. (°C)	POWER SUPPLY (Vac)	0 MINUTE		2 MINUTES		5 MINUTES		10 MINUTES	
		Measured Frequency (MHz)	Pass/ Fail	Measured Frequency (MHz)	Pass/ Fail	Measured Frequency (MHz)	Pass/ Fail	Measured Frequency (MHz)	Pass/ Fail
45	120	5755.0088	PASS	5755.0054	PASS	5755.0087	PASS	5755.0099	PASS
40	120	5754.977	PASS	5754.9727	PASS	5754.9746	PASS	5754.9773	PASS
30	120	5754.983	PASS	5754.9841	PASS	5754.9831	PASS	5754.979	PASS
20	120	5754.9754	PASS	5754.9735	PASS	5754.9766	PASS	5754.9763	PASS
10	120	5755.0113	PASS	5755.0145	PASS	5755.0105	PASS	5755.0142	PASS
0	120	5755.0231	PASS	5755.0261	PASS	5755.0283	PASS	5755.0265	PASS
-5	120	5754.9741	PASS	5754.9699	PASS	5754.9703	PASS	5754.9713	PASS
Max. Deviation (ppm)		-4.500434	PASS	-5.230235	PASS	-5.160730	PASS	-4.986968	PASS
IEEE Limit (ppm)		±20ppm							

Frequency Stability Versus Voltage

Operating Frequency: 5755 MHz

TEMP. (°C)	POWER SUPPLY (Vac)	0 MINUTE		2 MINUTES		5 MINUTES		10 MINUTES	
		Measured Frequency (MHz)	Pass/ Fail	Measured Frequency (MHz)	Pass/ Fail	Measured Frequency (MHz)	Pass/ Fail	Measured Frequency (MHz)	Pass/ Fail
20	138	5754.9762	PASS	5754.9727	PASS	5754.9755	PASS	5754.9771	PASS
	120	5754.9754	PASS	5754.9735	PASS	5754.9766	PASS	5754.9763	PASS
	102	5754.9755	PASS	5754.9727	PASS	5754.9759	PASS	5754.9757	PASS
Max. Deviation (ppm)		-4.274544	PASS	-4.743701	PASS	-4.257168	PASS	-4.222415	PASS
IEEE Limit (ppm)		±20ppm							

Frequency Stability Versus Temp.

Operating Frequency: 5795 MHz

TEMP. (°C)	POWER SUPPLY (Vac)	0 MINUTE		2 MINUTES		5 MINUTES		10 MINUTES	
		Measured Frequency (MHz)	Pass/ Fail	Measured Frequency (MHz)	Pass/ Fail	Measured Frequency (MHz)	Pass/ Fail	Measured Frequency (MHz)	Pass/ Fail
45	120	5795.0011	PASS	5794.996	PASS	5794.9978	PASS	5794.9964	PASS
40	120	5795.0124	PASS	5795.0111	PASS	5795.0085	PASS	5795.0126	PASS
30	120	5795.0173	PASS	5795.0182	PASS	5795.019	PASS	5795.0189	PASS
20	120	5795.0079	PASS	5795.012	PASS	5795.0084	PASS	5795.0072	PASS
10	120	5795.011	PASS	5795.0078	PASS	5795.0071	PASS	5795.0093	PASS
0	120	5794.9813	PASS	5794.9806	PASS	5794.9842	PASS	5794.9859	PASS
-5	120	5795.0176	PASS	5795.0175	PASS	5795.0177	PASS	5795.0181	PASS
Max. Deviation (ppm)		-3.226920	PASS	-3.347714	PASS	3.278689	PASS	3.261432	PASS
IEEE Limit (ppm)		±20ppm							

Frequency Stability Versus Voltage

Operating Frequency: 5795 MHz

TEMP. (°C)	POWER SUPPLY (Vac)	0 MINUTE		2 MINUTES		5 MINUTES		10 MINUTES	
		Measured Frequency (MHz)	Pass/ Fail	Measured Frequency (MHz)	Pass/ Fail	Measured Frequency (MHz)	Pass/ Fail	Measured Frequency (MHz)	Pass/ Fail
20	138	5795.0083	PASS	5795.0131	PASS	5795.0074	PASS	5795.0068	PASS
	120	5795.0079	PASS	5795.012	PASS	5795.0084	PASS	5795.0072	PASS
	102	5795.008	PASS	5795.0128	PASS	5795.0082	PASS	5795.0083	PASS
Max. Deviation (ppm)		1.432269	PASS	2.260569	PASS	1.449525	PASS	1.432269	PASS
IEEE Limit (ppm)		±20ppm							

80MHz

Frequency Stability Versus Temp.									
Operating Frequency: 5210 MHz									
TEMP. (°C)	POWER SUPPLY (Vac)	0 MINUTE		2 MINUTES		5 MINUTES		10 MINUTES	
		Measured Frequency (MHz)	Pass/ Fail	Measured Frequency (MHz)	Pass/ Fail	Measured Frequency (MHz)	Pass/ Fail	Measured Frequency (MHz)	Pass/ Fail
45	120	5209.9954	PASS	5209.9917	PASS	5209.9953	PASS	5209.9954	PASS
40	120	5210.005	PASS	5210.0041	PASS	5210.0027	PASS	5210.0029	PASS
30	120	5210.0089	PASS	5210.0076	PASS	5210.0088	PASS	5210.0093	PASS
20	120	5209.995	PASS	5209.9932	PASS	5209.9929	PASS	5209.9927	PASS
10	120	5210.0177	PASS	5210.0159	PASS	5210.0166	PASS	5210.0167	PASS
0	120	5210.0162	PASS	5210.0163	PASS	5210.0192	PASS	5210.0159	PASS
-5	120	5209.9894	PASS	5209.9903	PASS	5209.9869	PASS	5209.9897	PASS
Max. Deviation (ppm)		3.397313	PASS	3.128599	PASS	3.685221	PASS	3.205374	PASS
IEEE Limit (ppm)		±20ppm							

Frequency Stability Versus Voltage									
Operating Frequency: 5210 MHz									
TEMP. (°C)	POWER SUPPLY (Vac)	0 MINUTE		2 MINUTES		5 MINUTES		10 MINUTES	
		Measured Frequency (MHz)	Pass/ Fail	Measured Frequency (MHz)	Pass/ Fail	Measured Frequency (MHz)	Pass/ Fail	Measured Frequency (MHz)	Pass/ Fail
20	138	5209.994	PASS	5209.9929	PASS	5209.9926	PASS	5209.9923	PASS
	120	5209.995	PASS	5209.9932	PASS	5209.9929	PASS	5209.9927	PASS
	102	5209.9956	PASS	5209.9926	PASS	5209.9925	PASS	5209.9919	PASS
Max. Deviation (ppm)		-1.151631	PASS	-1.420345	PASS	-1.439539	PASS	-1.554702	PASS
IEEE Limit (ppm)		±20ppm							

Frequency Stability Versus Temp.

Operating Frequency: 5775 MHz

TEMP. (°C)	POWER SUPPLY (Vac)	0 MINUTE		2 MINUTES		5 MINUTES		10 MINUTES	
		Measured Frequency (MHz)	Pass/ Fail	Measured Frequency (MHz)	Pass/ Fail	Measured Frequency (MHz)	Pass/ Fail	Measured Frequency (MHz)	Pass/ Fail
45	120	5775.0254	PASS	5775.0246	PASS	5775.0227	PASS	5775.0275	PASS
40	120	5775.0248	PASS	5775.0209	PASS	5775.0212	PASS	5775.0259	PASS
30	120	5775.0103	PASS	5775.0133	PASS	5775.0114	PASS	5775.0144	PASS
20	120	5774.986	PASS	5774.9856	PASS	5774.9846	PASS	5774.9849	PASS
10	120	5775.0056	PASS	5775.0082	PASS	5775.0051	PASS	5775.0038	PASS
0	120	5774.9856	PASS	5774.9873	PASS	5774.9902	PASS	5774.9861	PASS
-5	120	5775.0282	PASS	5775.0297	PASS	5775.0289	PASS	5775.0272	PASS
Max. Deviation (ppm)		4.883117	PASS	5.142857	PASS	5.004329	PASS	4.761905	PASS
IEEE Limit (ppm)		±20ppm							

Frequency Stability Versus Voltage

Operating Frequency: 5775 MHz

TEMP. (°C)	POWER SUPPLY (Vac)	0 MINUTE		2 MINUTES		5 MINUTES		10 MINUTES	
		Measured Frequency (MHz)	Pass/ Fail	Measured Frequency (MHz)	Pass/ Fail	Measured Frequency (MHz)	Pass/ Fail	Measured Frequency (MHz)	Pass/ Fail
20	138	5774.9863	PASS	5774.9854	PASS	5774.9845	PASS	5774.9856	PASS
	120	5774.986	PASS	5774.9856	PASS	5774.9846	PASS	5774.9849	PASS
	102	5774.9861	PASS	5774.9847	PASS	5774.9848	PASS	5774.9852	PASS
Max. Deviation (ppm)		-2.424242	PASS	-2.649351	PASS	-2.683983	PASS	-2.614719	PASS
IEEE Limit (ppm)		±20ppm							

5 Test Instruments

For conducted emission test:

DESCRIPTION & MANUFACTURER	MODEL NO.	SERIAL NO.	CALIBRATED DATE	CALIBRATED UNTIL
Test Receiver R&S	ESCS 30	847124/029	Oct. 20, 2020	Oct. 19, 2021
Line-Impedance Stabilization Network (for EUT) R&S	ESH3-Z5	848773/004	Oct. 27, 2020	Oct. 26, 2021
Line-Impedance Stabilization Network (for Peripheral) R&S	ESH3-Z5	835239/001	Mar. 19, 2020	Mar. 18, 2021
50 ohms Terminator	50	3	Oct. 26, 2020	Oct. 25, 2021
RF Cable	5D-FB	COCCAB-001	Sep. 26, 2020	Sep. 25, 2021
Fixed attenuator EMCI	STI02-2200-10	005	Aug. 29, 2020	Aug. 28, 2021
Software BVADT	BVADT_Cond_ V7.3.7.4	NA	NA	NA

Note:

1. The calibration interval of the above test instruments are 12 months and the calibrations are traceable to NML/ROC and NIST/USA.
2. The test was performed in Conduction 1.
3. Tested Date: Nov. 11, 2020

For radiated emission below 1GHz and 2S3T TxBF radiated emission above 1GHz test:

DESCRIPTION & MANUFACTURER	MODEL NO.	SERIAL NO.	CALIBRATED DATE	CALIBRATED UNTIL
Test Receiver Keysight	N9038A	MY54450088	July 06, 2020	July 05, 2021
Pre-Amplifier EMCI	EMC001340	980142	May 25, 2020	May 24, 2021
Loop Antenna Electro-Metrics	EM-6879	264	Feb. 18, 2020	Feb. 17, 2021
RF Cable	NA	LOOPCAB-001	Jan. 08, 2020	Jan. 07, 2021
RF Cable	NA	LOOPCAB-002	Jan. 08, 2020	Jan. 07, 2021
Pre-Amplifier Mini-Circuits	ZFL-1000VH2B	AMP-ZFL-05	Apr. 28, 2020	Apr. 27, 2021
Trilog Broadband Antenna SCHWARZBECK	VULB 9168	9168-361	Nov. 05, 2020	Nov. 04, 2021
RF Cable	8D	966-3-1	Mar. 17, 2020	Mar. 16, 2021
RF Cable	8D	966-3-2	Mar. 17, 2020	Mar. 16, 2021
RF Cable	8D	966-3-3	Mar. 17, 2020	Mar. 16, 2021
Fixed attenuator Mini-Circuits	UNAT-5+	PAD-3m-3-01	Sep. 24, 2020	Sep. 23, 2021
Software	ADT_Radiated_V8.7.08	NA	NA	NA
Antenna Tower & Turn Table Max-Full	MF-7802	MF780208406	NA	NA

Note:

1. The calibration interval of the above test instruments is 12 months and the calibrations are traceable to NML/ROC and NIST/USA.
2. The test was performed in 966 Chamber No. 3.
3. Tested Date: Nov. 26 to 27, 2020

For other radiated emission & Band Edge Emissions above 1GHz test:

DESCRIPTION & MANUFACTURER	MODEL NO.	SERIAL NO.	CALIBRATED DATE	CALIBRATED UNTIL
Test Receiver Keysight	N9038A	MY54450088	July 06, 2020	July 05, 2021
Horn_Antenna SCHWARZBECK	BBHA9120-D	9120D-406	Nov. 24, 2019	Nov. 23, 2020
Pre-Amplifier EMCI	EMC12630SE	980384	Jan. 15, 2020	Jan. 14, 2021
RF Cable	EMC104-SM-SM-1500	180504	Apr. 29, 2020	Apr. 28, 2021
RF Cable	EMC104-SM-SM-2000	180601	June 09, 2020	June 08, 2021
RF Cable	EMC104-SM-SM-6000	180602	June 09, 2020	June 08, 2021
Spectrum Analyzer Keysight	N9030A	MY54490679	July 13, 2020	July 12, 2021
Pre-Amplifier EMCI	EMC184045SE	980387	Jan. 15, 2020	Jan. 14, 2021
Horn_Antenna SCHWARZBECK	BBHA 9170	BBHA9170519	Nov. 24, 2019	Nov. 23, 2020
RF Cable	EMC102-KM-KM-1200	160924	Jan. 15, 2020	Jan. 14, 2021
RF Cable	EMC-KM-KM-4000	200214	Mar. 11, 2020	Mar. 10, 2021
Software	ADT_Radiated_V8.7.08	NA	NA	NA
Antenna Tower & Turn Table Max-Full	MF-7802	MF780208406	NA	NA
Boresight Antenna Fixture	FBA-01	FBA-SIP01	NA	NA

Note:

1. The calibration interval of the above test instruments is 12 months and the calibrations are traceable to NML/ROC and NIST/USA.
2. The test was performed in 966 Chamber No. 3.
3. Tested Date: Nov. 06 to 20, 2020

For other test items:

DESCRIPTION & MANUFACTURER	MODEL NO.	SERIAL NO.	CALIBRATED DATE	CALIBRATED UNTIL
Spectrum Analyzer R&S	FSV40	100964	May 29, 2020	May 28, 2021
Power meter Anritsu	ML2495A	1529002	July 22, 2020	July 21, 2021
Power sensor Anritsu	MA2411B	1339443	July 22, 2020	July 21, 2021
Fixed Attenuator Mini-Circuits	MDCS18N-10	MDCS18N-10-01	Apr. 14, 2020	Apr. 13, 2021
AC Power Source Extech Electronics	6205	1440452	NA	NA
DC Power Supply Topward	6603D	795558	NA	NA
Temperature & Humidity Chamber Giant Force	GTH-150-40-SP-AR	MAA0812-008	Jan. 16, 2020	Jan. 15, 2021
True RMS Clamp Meter FLUKE	325	31130711WS	June 06, 2020	June 05, 2021
Software	ADT_RF Test Software V6.6.5.4	NA	NA	NA

- NOTE:**
1. The test was performed in Oven room 2.
 2. The calibration interval of the above test instruments is 12 months and the calibrations are traceable to NML/ROC and NIST/USA.
 3. Tested Date: Nov. 25, 2020

Appendix - Information of the Testing Laboratories

We, Bureau Veritas Consumer Products Services (H.K.) Ltd., Taoyuan Branch, were founded in 1988 to provide our best service in EMC, Radio, Telecom and Safety consultation. Our laboratories are accredited and approved according to ISO/IEC 17025.

If you have any comments, please feel free to contact us at the following:

Lin Kou EMC/RF Lab

Tel: 886-2-26052180

Fax: 886-2-26051924

Hsin Chu EMC/RF/Telecom Lab

Tel: 886-3-6668565

Fax: 886-3-6668323

Hwa Ya EMC/RF/Safety

Tel: 886-3-3183232

Fax: 886-3-3270892

Email: service.adt@tw.bureauveritas.com

Web Site: www.bureauveritas-adt.com

The address and road map of all our labs can be found in our web site also.

--- END ---