



FCC TEST REPORT

REPORT NO.: RF960727L13

MODEL NO.: GTV-380

(Refer to item 3.1 for the more details)

RECEIVED: Jul. 27, 2007

TESTED: Oct. 01 ~ Oct. 15, 2007

ISSUED: Nov. 02, 2007

APPLICANT: GlobalSat Technology Corporation

ADDRESS: 2-1F, No.16, Chien 8 Road Far East Century Park,
Chung Ho City, Taipei Hsien 235, Taiwan

ISSUED BY: Advance Data Technology Corporation

LAB ADDRESS: No. 47, 14th Ling, Chia Pau Tsuen, Lin Kou Hsiang
244, Taipei Hsien, Taiwan, R.O.C.

TEST LOCATION: No. 19, Hwa Ya 2nd Rd., Wen Hwa Tsuen, Kwei
Shan Hsiang, Taoyuan Hsien 333, Taiwan, R.O.C.

This test report consists of 53 pages in total. It may be duplicated completely for legal use with the approval of the applicant. It should not be reproduced except in full, without the written approval of our laboratory. The client should not use it to claim product endorsement by TAF, A2LA or any government agencies. The test results in the report only apply to the tested sample.





TABLE OF CONTENTS

1.	CERTIFICATION.....	4
2.	SUMMARY OF TEST RESULTS.....	5
2.1	MEASUREMENT UNCERTAINTY.....	5
3.	GENERAL INFORMATION.....	6
3.1	GENERAL DESCRIPTION OF EUT	6
3.2	DESCRIPTION OF TEST MODES.....	7
3.2.1	CONFIGURATION OF SYSTEM UNDER TEST.....	8
3.2.2	TEST MODE APPLICABILITY AND TESTED CHANNEL DETAIL.....	9
3.3.3	GENERAL DESCRIPTION OF APPLIED STANDARDS.....	10
3.3.4	DESCRIPTION OF SUPPORT UNITS.....	11
4.	TEST TYPES AND RESULTS.....	12
4.1	RADIATED EMISSION MEASUREMENT	12
4.1.1	LIMITS OF RADIATED EMISSION MEASUREMENT	12
4.1.2	TEST INSTRUMENTS.....	13
4.1.3	TEST PROCEDURES	14
4.1.4	DEVIATION FROM TEST STANDARD	14
4.1.5	TEST SETUP.....	15
4.1.6	EUT OPERATING CONDITIONS	15
4.1.7	TEST RESULTS	16
4.2	CONDUCTED EMISSION MEASUREMENT	21
4.2.1	LIMITS OF CONDUCTED EMISSION MEASUREMENT	21
4.2.2	TEST INSTRUMENTS	21
4.2.3	TEST PROCEDURES.....	22
4.2.4	DEVIATION FROM TEST STANDARD	22
4.2.5	TEST SETUP.....	23
4.2.6	EUT OPERATING CONDITIONS	23
4.2.7	TEST RESULTS	24
4.3	NUMBER OF HOPPING FREQUENCY USED	26
4.3.1	LIMIT OF HOPPING FREQUENCY USED	26
4.3.2	TEST INSTRUMENTS.....	26
4.3.3	TEST PROCEDURES	26
4.3.4	DEVIATION FROM TEST STANDARD	27
4.3.5	TEST SETUP.....	27
4.3.6	TEST RESULTS	27
4.4	DWELL TIME ON EACH CHANNEL	29
4.4.1	LIMIT OF DWELL TIME USED.....	29
4.4.2	TEST INSTRUMENTS.....	29
4.4.3	TEST PROCEDURES	29
4.4.4	DEVIATION FROM TEST STANDARD	29



4.4.5	TEST SETUP	30
4.4.6	TEST RESULTS	30
4.5	CHANNEL BANDWIDTH	34
4.5.1	LIMITS OF CHANNEL BANDWIDTH	34
4.5.2	TEST INSTRUMENTS.....	34
4.5.3	TEST PROCEDURE.....	34
4.5.4	DEVIATION FROM TEST STANDARD	35
4.5.5	TEST SETUP.....	35
4.5.6	EUT OPERATING CONDITION	35
4.5.7	TEST RESULTS	35
4.6	HOPPING CHANNEL SEPARATION	38
4.6.1	LIMIT OF HOPPING CHANNEL SEPARATION	38
4.6.2	TEST INSTRUMENTS.....	38
4.6.3	TEST PROCEDURES	38
4.6.4	DEVIATION FROM TEST STANDARD	39
4.6.5	TEST SETUP.....	39
4.6.6	TEST RESULTS	39
4.7	MAXIMUM PEAK OUTPUT POWER	42
4.7.1	LIMITS OF MAXIMUM PEAK OUTPUT POWER MEASUREMENT	42
4.7.2	TEST INSTRUMENTS.....	42
4.7.3	TEST PROCEDURES	42
4.7.4	DEVIATION FROM TEST STANDARD	42
4.7.5	TEST SETUP.....	43
4.7.6	EUT OPERATING CONDITION	43
4.7.7	TEST RESULTS	43
4.8	BAND EDGES MEASUREMENT	46
4.8.1	LIMITS OF BAND EDGES MEASUREMENT	46
4.8.2	TEST INSTRUMENTS.....	46
4.8.3	TEST PROCEDURE.....	46
4.8.4	DEVIATION FROM TEST STANDARD	46
4.8.5	EUT OPERATING CONDITION	46
4.8.6	TEST RESULTS	47
4.9	ANTENNA REQUIREMENT	50
4.9.1	STANDARD APPLICABLE	50
4.9.2	ANTENNA CONNECTED CONSTRUCTION.....	50
5.	PHOTOGRAPHS OF THE TEST CONFIGURATION.....	51
6.	INFORMATION ON THE TESTING LABORATORIES.....	52
7.	APPENDIX-A MODIFICATIONS RECORDERS FOR ENGINEERING CHANGES TO THE EUT BY THE LAB.....	53

2. SUMMARY OF TEST RESULTS

The EUT has been tested according to the following specifications:

APPLIED STANDARD: FCC Part 15, Subpart C			
STANDARD SECTION	TEST TYPE AND LIMIT	RESULT	REMARK
15.207	AC Power Conducted Emission	PASS	Meet the requirement of limit. Minimum passing margin is -14.74dB at 0.713MHz.
15.247(a)(1)(iii)	Number of Hopping Frequency Used Spec.: At least 15 channels	PASS	Meet the requirement of limit.
15.247(a)(1)(iii)	Dwell Time on Each Channel Spec.: Max. 0.4 second within 31.6 second	PASS	Meet the requirement of limit.
15.247(a)(1)	1. Hopping Channel Separation Spec.: Min. 25 kHz or 20 dB bandwidth, whichever is greater 2. Spectrum Bandwidth of a Frequency Hopping Sequence Spread Spectrum System	PASS	Meet the requirement of limit.
15.247(b)	Maximum Peak Output Power Spec.: max. 30dBm	PASS	Meet the requirement of limit.
15.247(d)	Transmitter Radiated Emissions Spec.: Table 15.209	PASS	Meet the requirement of limit. Minimum passing margin is -0.20 dB at 179.61MHz.
15.247(d)	Band Edge Measurement	PASS	Meet the requirement of limit.

2.1 MEASUREMENT UNCERTAINTY

Where relevant, the following measurement uncertainty levels have been estimated for tests performed on the EUT as specified in CISPR 16-4-2:

MEASUREMENT	FREQUENCY	UNCERTAINTY
Conducted emissions	9kHz ~ 30MHz	2.44 dB
Radiated emissions	30MHz ~ 200MHz	2.93 dB
	200MHz ~ 1000MHz	2.95 dB
	1GHz ~ 18GHz	2.26 dB
	18GHz ~ 40GHz	1.94 dB

This uncertainty represents an expanded uncertainty expressed at approximately the 95% confidence level using a coverage factor of k=2.

3. GENERAL INFORMATION

3.1 GENERAL DESCRIPTION OF EUT

PRODUCT	Car Navigator
MODEL NO.	GTV-380 (Refer to Note for the more details)
FCC ID	RIDGTV-380
POWER SUPPLY	3.7Vdc from battery 5.0Vdc from adapter or car charger
MODULATION TYPE	GFSK
RADIO TECHNOLOGY	FHSS
TRANSFER RATE	723.2kbps
FREQUENCY RANGE	2400 ~ 2483.5 MHz
NUMBER OF CHANNEL	79
OUTPUT POWER	2.023mW
ANTENNA TYPE	Bluetooth PIFA antenna with 2.2dBi gain
DATA CABLE	NA
I/O PORTS	Refer to user's manual
ACCESSORY DEVICES	Adapter, car charger, battery, cradle (brand: GLOBALSAT, model: DVB-100), TV antenna(1.5m)

NOTE:

1. The models as below are identical to each other, except for their model designation due to marketing requirement.

BRAND	Model Name
Globalsat	GTV-380
Globalsat	GV-380

2. The EUT was powered by the following battery, adapter and car charger:

Battery:

Brand:	Welldone
Model:	BKE505280
Rating:	3.7Vdc, 2200mA

Adapter:

Brand:	PHIHONG
Model:	PSC11R-050
Input:	100~240Vac, 0.3A, 50~60Hz
Output:	5Vdc, 2A
Power Line:	1.8 m non-shielded cable without core

Car charger:

Brand:	Semdicar
Model:	IC-DX3-GPSR
Input:	12Vdc / 24Vdc, 1.2A
Output:	5Vdc, 2A
Power Line:	0.8 m non-shielded cable without core

Note: After pre-test, the EUT powered from 24Vdc car charger was the worst case and the test data were present in this report.

3. The above EUT information was declared by manufacturer and for more detailed features description, please refer to the manufacturer's specifications or User's Manual.

3.2 DESCRIPTION OF TEST MODES

79 channels are provided to this EUT:

CHANNEL	FREQ. (MHz)	CHANNEL	FREQ. (MHz)	CHANNEL	FREQ. (MHz)	CHANNEL	FREQ. (MHz)
0	2402	20	2422	40	2442	60	2462
1	2403	21	2423	41	2443	61	2463
2	2404	22	2424	42	2444	62	2464
3	2405	23	2425	43	2445	63	2465
4	2406	24	2426	44	2446	64	2466
5	2407	25	2427	45	2447	65	2467
6	2408	26	2428	46	2448	66	2468
7	2409	27	2429	47	2449	67	2469
8	2410	28	2430	48	2450	68	2470
9	2411	29	2431	49	2451	69	2471
10	2412	30	2431	50	2452	70	2472
11	2413	31	2433	51	2453	71	2473
12	2414	32	2434	52	2454	72	2474
13	2415	33	2435	53	2455	73	2475
14	2416	34	2436	54	2456	74	2476
15	2417	35	2437	55	2457	75	2477
16	2418	36	2438	56	2458	76	2478
17	2419	37	2439	57	2459	77	2479
18	2420	38	2440	58	2460	78	2480
19	2421	39	2441	59	2461		

3.2.1 CONFIGURATION OF SYSTEM UNDER TEST

Test Mode A

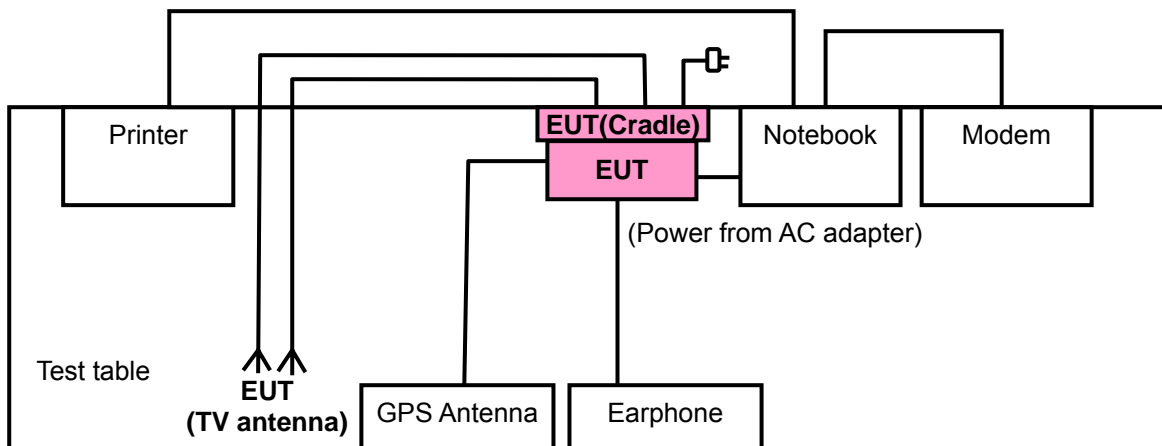

Test Mode B

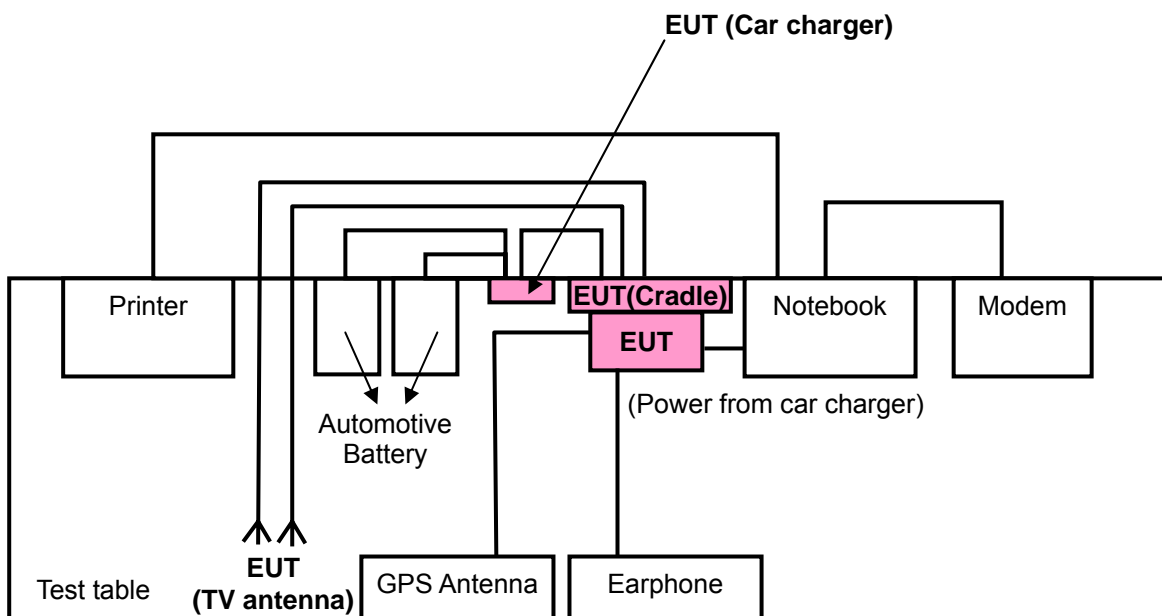

3.2.2 TEST MODE APPLICABILITY AND TESTED CHANNEL DETAIL

EUT CONFIGURE MODE	APPLICABLE TO				DESCRIPTION
	RE \geq 1G	RE $<$ 1G	PLC	APCM	
A	√	√	√	√	Power from adapter
B	-	√	-	-	Power from car charger

Where **PLC**: Power Line Conducted Emission
RE \geq 1G: Radiated Emission above 1GHz

RE $<$ 1G: Radiated Emission below 1GHz
APCM: Antenna Port Conducted Measurement

NOTE: “-“ means no effect.

RADIATED EMISSION TEST (ABOVE 1 GHz):

- Pre-Scan has been conducted to determine the worst-case mode from all possible combinations between available modulations and packet types, data rate and XYZ axis.
- Following channel(s) was (were) selected for the final test as listed below.

EUT CONFIGURE MODE	AVAILABLE CHANNEL	TESTED CHANNEL	MODULATION TECHNOLOGY	MODULATION TYPE	PACKET TYPE	AXIS
A	0 to 78	0, 39, 78	FHSS	GFSK	DH5	Z

RADIATED EMISSION TEST (BELOW 1 GHz):

- Pre-Scan has been conducted to determine the worst-case mode from all possible combinations between available modulations and packet types, data rate and XYZ axis.
- Following channel(s) was (were) selected for the final test as listed below.

EUT CONFIGURE MODE	AVAILABLE CHANNEL	TESTED CHANNEL	MODULATION TECHNOLOGY	MODULATION TYPE	PACKET TYPE	AXIS
A, B	0 to 78	78	FHSS	GFSK	DH5	Z

POWER LINE CONDUCTED EMISSION TEST:

- Pre-Scan has been conducted to determine the worst-case mode from all possible combinations between available modulations, antenna ports (if EUT with antenna diversity architecture), and packet types.
- Following channel(s) was (were) selected for the final test as listed below.

EUT CONFIGURE MODE	AVAILABLE CHANNEL	TESTED CHANNEL	MODULATION TECHNOLOGY	MODULATION TYPE	PACKET TYPE
A	0 to 78	0	FHSS	GFSK	DH5

BANDEDGE MEASUREMENT:

- Pre-Scan has been conducted to determine the worst-case mode from all possible combinations between available modulations and packet types.
- Following channel(s) was (were) selected for the final test as listed below.

EUT CONFIGURE MODE	AVAILABLE CHANNEL	TESTED CHANNEL	MODULATION TECHNOLOGY	MODULATION TYPE	PACKET TYPE
A	0 to 78	0, 78	FHSS	GFSK	DH5

ANTENNA PORT CONDUCTED MEASUREMENT:

- Pre-Scan has been conducted to determine the worst-case mode from all possible combinations between available modulations and packet types.
- Following channel(s) was (were) selected for the final test as listed below.

EUT CONFIGURE MODE	AVAILABLE CHANNEL	TESTED CHANNEL	MODULATION TECHNOLOGY	MODULATION TYPE	PACKET TYPE
A	0 to 78	0, 39, 78	GFSK	DH5	DH5

3.3.3 GENERAL DESCRIPTION OF APPLIED STANDARDS

The EUT is a RF Product. According to the specifications of the manufacturer, it must comply with the requirements of the following standards:

FCC Part 15, Subpart C. (15.247)

ANSI C63.4- 2003

All test items have been performed and recorded as per the above standards.

NOTE: The EUT is also considered as a kind of computer peripheral, because the connection to computer is necessary for typical use. It has been verified to comply with the requirements of FCC Part 15, Subpart B, Class B (DoC). The test report has been issued separately.



3.3.4 DESCRIPTION OF SUPPORT UNITS

The EUT has been tested as an independent unit together with other necessary accessories or support units. The following support units or accessories were used to form a representative test configuration during the tests.

NO.	PRODUCT	BRAND	MODEL NO.	SERIAL NO.	FCC ID
1	NOTEBOOK COMPUTER	DELL	PP05L	12130898320	E2K24CLNS
2	PRINTER	EPSON	LQ-300+	DCGY047265	FCC DoC Approved
3	MODEM	ACEEX	1414V/3	0401008248	IFAXDM1414
4	EARPHONE	PHILIPS	SBC HL125	N/A	NA
5	AUTOMOTIVE BATTERY	YUASA	36B20L	NA	NA
6	AUTOMOTIVE BATTERY	YUASA	36B20L	NA	NA
7	GPS ANTENNA	NA	AT-65	NA	NA

NO.	SIGNAL CABLE DESCRIPTION OF THE ABOVE SUPPORT UNITS
1	1.8m USB cable
2	1.8m braid shielded wire, DB25 connector, w/o core.
3	1.2m braid shielded wire, DB25 & DB9 connector, w/o core.
4	1.2 m wrapped shielded wire, terminated with 3.5mm phone plug via drain wire, w/o core.
5	NA
6	NA
7	2.0 m cable

NOTE:

1. All power cords of the above support units are non shielded (1.8m).
2. Item 7 was provided by client.

4. TEST TYPES AND RESULTS

4.1 RADIATED EMISSION MEASUREMENT

4.1.1 LIMITS OF RADIATED EMISSION MEASUREMENT

Emissions radiated outside of the specified bands, shall be according to the general radiated limits in 15.209 as following:

FREQUENCIES (MHz)	FIELD STRENGTH (microvolts/meter)	MEASUREMENT DISTANCE (meters)
0.009 ~ 0.490	2400/F(kHz)	300
0.490 ~ 1.705	24000/F(kHz)	30
1.705 ~ 30.0	30	30
30 ~ 88	100	3
88 ~ 216	150	3
216 ~ 960	200	3
Above 960	500	3

NOTE:

1. The lower limit shall apply at the transition frequencies.
2. Emission level (dBuV/m) = 20 log Emission level (uV/m).
3. As shown in 15.35(b), for frequencies above 1000MHz, the field strength limits are based on average detector, however, the peak field strength of any emission shall not exceed the maximum permitted average limits, specified above by more than 20dB under any condition of modulation.



4.1.2 TEST INSTRUMENTS

DESCRIPTION & MANUFACTURER	MODEL NO.	SERIAL NO.	CALIBRATED UNTIL
Test Receiver ROHDE & SCHWARZ	ESCI	100424	Jul. 27, 2008
Spectrum Analyzer ROHDE & SCHWARZ	FSP40	100269	Aug. 05, 2008
BILOG Antenna SCHWARZBECK	VULB9168	9168-153	Jan. 04, 2008
HORN Antenna SCHWARZBECK	BBHA 9120 D	9120D-563	Jul. 30, 2008
HORN Antenna SCHWARZBECK	BBHA 9170	BBHA9170242	Jan. 16, 2008
Preamplifier Agilent	8449B	3008A01910	Sep. 19, 2008
Preamplifier Agilent	8447D	2944A10638	Dec. 20, 2007
RF signal cable HUBER+SUHNNER	SUCOFLEX 104	218188/218189	Nov. 14, 2007
RF signal cable Worken	8D-FB	Cable-HYCH9-01	Aug. 09, 2008
Software	ADT_Radiated_V7.6	NA	NA
Antenna Tower EMCO	2070/2080	512.835.4684	NA
Turn Table EMCO	2087-2.03	NA	NA
Antenna Tower & Turn Table Controller EMCO	2090	NA	NA

- NOTE:**
1. The calibration interval of the above test instruments is 12 months and the calibrations are traceable to NML/ROC and NIST/USA.
 2. The test was performed in HwaYa Chamber 9.
 3. The horn antenna and HP preamplifier (model: 8449B) are used only for the measurement of emission frequency above 1GHz if tested.
 4. The IC Site Registration No. is IC3789B-9.

4.1.3 TEST PROCEDURES

- a. The EUT was placed on the top of a rotating table 0.8 meters above the ground at a 3 meter semi-anechoic chamber. The table was rotated 360 degrees to determine the position of the highest radiation.
- b. The EUT was set 3 meters away from the interference-receiving antenna, which was mounted on the top of a variable-height antenna tower.
- c. The antenna is a broadband antenna, and its height is varied from one meter to four meters above the ground to determine the maximum value of the field strength. Both horizontal and vertical polarizations of the antenna are set to make the measurement.
- d. For each suspected emission, the EUT was arranged to its worst case and then the antenna was tuned to heights from 1 meter to 4 meters and the rotatable table was turned from 0 degrees to 360 degrees to find the maximum reading.
- e. The test-receiver system was set to Peak Detect Function and Specified Bandwidth with Maximum Hold Mode.
- f. If the emission level of the EUT in peak mode was lower than the limit specified, then testing could be stopped and the peak values of the EUT would be reported. Otherwise the emissions would be re-tested one by one using peak, quasi-peak or average method as specified and then reported in a data sheet.

NOTE:

1. The resolution bandwidth and video bandwidth of test receiver/spectrum analyzer is 120kHz for Quasi-peak detection at frequency below 1GHz.
2. The resolution bandwidth of test receiver/spectrum analyzer is 1 MHz and video bandwidth is 3MHz for Peak detection at frequency above 1GHz.
3. All modes of operation were investigated and the worst-case emissions are reported.

4.1.4 DEVIATION FROM TEST STANDARD

No deviation

4.1.5 TEST SETUP

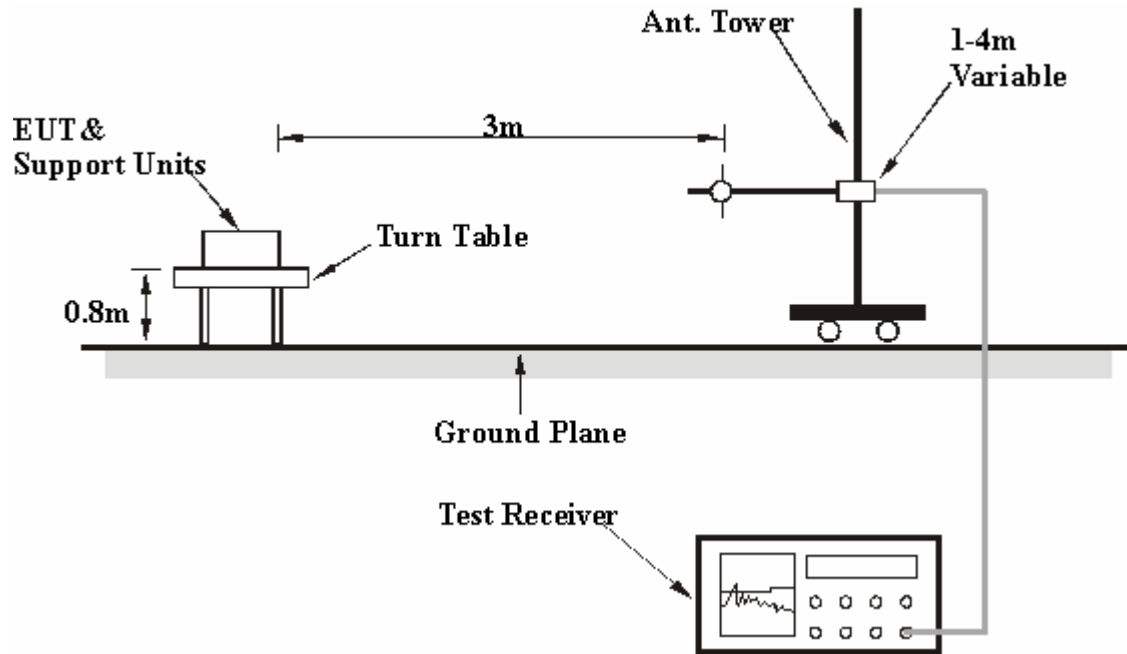

For the actual test configuration, please refer to the related item – Photographs of the Test Configuration.

4.1.6 EUT OPERATING CONDITIONS

- a. Connected EUT with notebook system via a USB cable and placed on a testing table.
- b. The notebook system ran a test program (provided by manufacturer) to enable EUT under transmitting condition continuously at specific channel frequency.
- c. The necessary accessories enable the system in full functions.

4.1.7 TEST RESULTS

RADIATED WORST CASE DATA: ABOVE 1GHz

EUT TEST CONDITION		MEASUREMENT DETAIL	
CHANNEL	Channel 0	FREQUENCY RANGE	1 ~ 25GHz
MODULATION TYPE	GFSK	DETECTOR FUNCTION	Peak (PK) Average (AV)
ENVIRONMENTAL CONDITIONS	25deg. C, 68%RH, 991hPa	INPUT POWER (SYSTEM)	120Vac, 60 Hz
TESTED BY	Morgan Chen	TEST MODE	A

ANTENNA POLARITY & TEST DISTANCE: HORIZONTAL AT 3 M								
No.	Freq. (MHz)	Emission Level (dBuV/m)	Limit (dBuV/m)	Margin (dB)	Antenna Height (m)	Table Angle (Degree)	Raw Value (dBuV)	Correction Factor (dB/m)
1	1602.00	45.36 PK	74.00	-28.64	1.19 H	269	15.37	29.98
2	1602.00	40.40 AV	54.00	-13.60	1.19 H	269	10.41	29.98
3	2390.00	44.85 PK	74.00	-29.15	1.31 H	62	12.62	32.23
4	2390.00	40.44 AV	54.00	-13.56	1.31 H	62	8.21	32.23
5	*2402.00	93.65 PK			1.31 H	62	61.37	32.28
6	*2402.00	63.55 AV			1.31 H	62	31.27	32.28
7	4804.00	62.84 PK	74.00	-11.16	1.55 H	243	24.43	38.41
8	4804.00	32.74 AV	54.00	-21.26	1.55 H	243	-5.67	38.41

ANTENNA POLARITY & TEST DISTANCE: VERTICAL AT 3 M								
No.	Freq. (MHz)	Emission Level (dBuV/m)	Limit (dBuV/m)	Margin (dB)	Antenna Height (m)	Table Angle (Degree)	Raw Value (dBuV)	Correction Factor (dB/m)
1	1602.00	44.25 PK	74.00	-29.75	1.00 V	3	14.27	29.98
2	1602.00	39.29 AV	54.00	-14.71	1.00 V	3	9.31	29.98
3	2390.00	40.65 PK	74.00	-33.35	1.51 V	7	8.42	32.23
4	2390.00	36.48 AV	54.00	-17.52	1.51 V	7	4.25	32.23
5	*2402.00	89.10 PK			1.51 V	7	56.82	32.28
6	*2402.00	59.00 AV			1.51 V	7	26.72	32.28
7	4804.00	57.37 PK	74.00	-16.63	1.00 V	322	18.96	38.41
8	4804.00	27.27 AV	54.00	-26.73	1.00 V	322	-11.14	38.41

- REMARKS:**
1. Emission level (dBuV/m) = Raw Value (dBuV) + Correction Factor (dB/m).
 2. Correction Factor (dB/m) = Antenna Factor (dB/m) + Cable Factor (dB).
 3. The other emission levels were very low against the limit.
 4. Margin value = Emission level – Limit value.
 5. The DH5 packet was the worse case duty cycle for a transmit dwell time on a channel, based upon bluetooth theory the transmitter is on 0.625 * 5 per 296.25 ms per channel. Therefore, the duty cycle correction factor be equal to: $20\log(3.125 / 100) = -30.1$ dB.
 6. Average value = peak reading + $20\log(\text{duty cycle})$.

EUT TEST CONDITION		MEASUREMENT DETAIL	
CHANNEL	Channel 39	FREQUENCY RANGE	1 ~ 25GHz
MODULATION TYPE	GFSK	DETECTOR FUNCTION	Peak (PK) Average (AV)
ENVIRONMENTAL CONDITIONS	25deg. C, 68%RH, 991hPa	INPUT POWER (SYSTEM)	120Vac, 60 Hz
TESTED BY	Morgan Chen	TEST MODE	A

ANTENNA POLARITY & TEST DISTANCE: HORIZONTAL AT 3 M								
No.	Freq. (MHz)	Emission Level (dBuV/m)	Limit (dBuV/m)	Margin (dB)	Antenna Height (m)	Table Angle (Degree)	Raw Value (dBuV)	Correction Factor (dB/m)
1	1628.00	45.01 PK	74.00	-28.99	1.10 H	271	14.98	30.03
2	1628.00	39.46 AV	54.00	-14.54	1.10 H	271	9.43	30.03
3	*2441.00	92.29 PK			1.08 H	4	59.86	32.43
4	*2441.00	62.19 AV			1.08 H	4	29.76	32.43
5	4882.00	62.56 PK	74.00	-11.44	1.58 H	266	23.83	38.73
6	4882.00	32.46 AV	54.00	-21.54	1.58 H	266	-6.27	38.73

ANTENNA POLARITY & TEST DISTANCE: VERTICAL AT 3 M								
No.	Freq. (MHz)	Emission Level (dBuV/m)	Limit (dBuV/m)	Margin (dB)	Antenna Height (m)	Table Angle (Degree)	Raw Value (dBuV)	Correction Factor (dB/m)
1	1628.00	44.55 PK	74.00	-29.45	1.08 V	26	14.52	30.03
2	1628.00	39.02 AV	54.00	-14.98	1.08 V	26	8.99	30.03
3	*2441.00	88.66 PK			1.25 V	19	56.23	32.43
4	*2441.00	58.56 AV			1.25 V	19	26.13	32.43
5	4882.00	57.22 PK	74.00	-16.78	1.00 V	311	18.49	38.73
6	4882.00	27.12 AV	54.00	-26.88	1.00 V	311	-11.61	38.73

- REMARKS:**
1. Emission level (dBuV/m) = Raw Value (dBuV) + Correction Factor (dB/m).
 2. Correction Factor (dB/m) = Antenna Factor (dB/m) + Cable Factor (dB).
 3. The other emission levels were very low against the limit.
 4. Margin value = Emission level – Limit value.
 5. The DH5 packet was the worse case duty cycle for a transmit dwell time on a channel, based upon bluetooth theory the transmitter is on 0.625 * 5 per 296.25 ms per channel. Therefore, the duty cycle correction factor be equal to: $20\log(3.125 / 100) = -30.1$ dB.
 6. Average value = peak reading + $20\log(\text{duty cycle})$.

EUT TEST CONDITION		MEASUREMENT DETAIL	
CHANNEL	Channel 78	FREQUENCY RANGE	1 ~ 25GHz
MODULATION TYPE	GFSK	DETECTOR FUNCTION	Peak (PK) Average (AV)
ENVIRONMENTAL CONDITIONS	25deg. C, 68%RH, 991hPa	INPUT POWER (SYSTEM)	120Vac, 60 Hz
TESTED BY	Morgan Chen	TEST MODE	A

ANTENNA POLARITY & TEST DISTANCE: HORIZONTAL AT 3 M								
No.	Freq. (MHz)	Emission Level (dBuV/m)	Limit (dBuV/m)	Margin (dB)	Antenna Height (m)	Table Angle (Degree)	Raw Value (dBuV)	Correction Factor (dB/m)
1	1654.00	45.98 PK	74.00	-28.02	1.12 H	275	15.90	30.08
2	1654.00	41.86 AV	54.00	-12.14	1.12 H	275	11.78	30.08
3	*2480.00	94.77 PK			1.05 H	342	62.20	32.57
4	*2480.00	64.67 AV			1.05 H	342	32.10	32.57
5	2483.50	46.56 PK	74.00	-27.44	1.05 H	342	13.97	32.59
6	2483.50	42.28 AV	54.00	-11.72	1.05 H	342	9.69	32.59
7	4960.00	62.35 PK	74.00	-11.65	1.46 H	255	23.44	38.91
8	4960.00	32.25 AV	54.00	-21.75	1.46 H	255	-6.66	38.91

ANTENNA POLARITY & TEST DISTANCE: VERTICAL AT 3 M								
No.	Freq. (MHz)	Emission Level (dBuV/m)	Limit (dBuV/m)	Margin (dB)	Antenna Height (m)	Table Angle (Degree)	Raw Value (dBuV)	Correction Factor (dB/m)
1	1654.00	45.42 PK	74.00	-28.58	1.00 V	8	15.34	30.08
2	1654.00	41.32 AV	54.00	-12.68	1.00 V	8	11.24	30.08
3	*2480.00	89.22 PK			1.23 V	19	56.65	32.57
4	*2480.00	59.12 AV			1.23 V	19	26.55	32.57
5	2483.50	42.89 PK	74.00	-31.11	1.23 V	19	10.30	32.59
6	2483.50	38.57 AV	54.00	-15.43	1.23 V	19	5.98	32.59
7	4960.00	56.89 PK	74.00	-17.11	1.00 V	318	17.98	38.91
8	4960.00	26.79 AV	54.00	-27.21	1.00 V	318	-12.12	38.91

- REMARKS:**
1. Emission level (dBuV/m) = Raw Value (dBuV) + Correction Factor (dB/m).
 2. Correction Factor (dB/m) = Antenna Factor (dB/m) + Cable Factor (dB).
 3. The other emission levels were very low against the limit.
 4. Margin value = Emission level – Limit value.
 5. The DH5 packet was the worse case duty cycle for a transmit dwell time on a channel, based upon bluetooth theory the transmitter is on 0.625 * 5 per 296.25 ms per channel. Therefore, the duty cycle correction factor be equal to: $20\log(3.125 / 100) = -30.1$ dB.
 6. Average value = peak reading + $20\log(\text{duty cycle})$.



RADIATED WORST CASE DATA: BELOW 1GHz

EUT TEST CONDITION		MEASUREMENT DETAIL	
CHANNEL	Channel 78	FREQUENCY RANGE	Below 1000MHz
MODULATION TYPE	GFSK	DETECTOR FUNCTION	Quasi-Peak
ENVIRONMENTAL CONDITIONS	25deg. C, 69%RH, 991hPa	INPUT POWER (SYSTEM)	120Vac, 60 Hz
TESTED BY	Lori Chiu	TEST MODE	A

ANTENNA POLARITY & TEST DISTANCE: HORIZONTAL AT 3 M								
No.	Freq. (MHz)	Emission Level (dBuV/m)	Limit (dBuV/m)	Margin (dB)	Antenna Height (m)	Table Angle (Degree)	Raw Value (dBuV)	Correction Factor (dB/m)
1	86.28	39.29 QP	40.00	-0.71	2.00 H	76	30.68	8.60
2	125.17	43.10 QP	43.50	-0.40	2.00 H	355	31.34	11.76
3	152.39	41.75 QP	43.50	-1.75	2.00 H	148	28.13	13.62
4	166.00	42.92 QP	43.50	-0.58	1.75 H	10	29.89	13.03
5	179.61	42.97 QP	43.50	-0.53	1.50 H	145	30.91	12.06
6	193.22	43.24 QP	43.50	-0.26	1.50 H	139	32.34	10.90
7	220.44	41.28 QP	46.00	-4.72	1.50 H	352	30.05	11.23
8	245.72	44.47 QP	46.00	-1.53	1.25 H	304	32.11	12.36
9	272.94	43.50 QP	46.00	-2.50	1.00 H	229	30.59	12.92
10	300.16	41.93 QP	46.00	-4.07	1.25 H	82	28.57	13.36
11	379.87	42.73 QP	46.00	-3.27	1.25 H	268	27.49	15.25
12	667.63	41.26 QP	46.00	-4.74	1.50 H	76	19.56	21.70

ANTENNA POLARITY & TEST DISTANCE: VERTICAL AT 3 M								
No.	Freq. (MHz)	Emission Level (dBuV/m)	Limit (dBuV/m)	Margin (dB)	Antenna Height (m)	Table Angle (Degree)	Raw Value (dBuV)	Correction Factor (dB/m)
1	125.17	42.42 QP	43.50	-1.08	1.75 V	337	30.66	11.76
2	138.78	34.19 QP	43.50	-9.31	1.50 V	148	21.93	12.26
3	179.61	42.63 QP	43.50	-0.87	1.75 V	118	30.57	12.06
4	379.87	35.71 QP	46.00	-10.29	1.25 V	172	20.46	15.25
5	407.09	35.21 QP	46.00	-10.79	1.00 V	208	19.29	15.92
6	533.47	38.52 QP	46.00	-7.48	1.50 V	226	18.98	19.54
7	667.63	41.22 QP	46.00	-4.78	1.75 V	52	19.52	21.70

- REMARKS:**
1. Emission level(dBuV/m)=Raw Value(dBuV) + Correction Factor(dB/m)
 2. Correction Factor(dB/m) = Antenna Factor (dB/m) + Cable Factor (dB)
 3. The other emission levels were very low against the limit.
 4. Margin value = Emission level – Limit value.



EUT TEST CONDITION		MEASUREMENT DETAIL	
CHANNEL	Channel 78	FREQUENCY RANGE	Below 1000MHz
MODULATION TYPE	GFSK	DETECTOR FUNCTION	Quasi-Peak
ENVIRONMENTAL CONDITIONS	25deg. C, 69%RH, 991hPa	INPUT POWER (SYSTEM)	120Vac, 60 Hz
TESTED BY	Lori Chiu	TEST MODE	B

ANTENNA POLARITY & TEST DISTANCE: HORIZONTAL AT 3 M								
No.	Freq. (MHz)	Emission Level (dBuV/m)	Limit (dBuV/m)	Margin (dB)	Antenna Height (m)	Table Angle (Degree)	Raw Value (dBuV)	Correction Factor (dB/m)
1	86.28	39.03 QP	40.00	-0.97	2.00 H	79	30.43	8.60
2	125.17	43.22 QP	43.50	-0.28	1.50 H	13	31.46	11.76
3	160.17	40.20 QP	43.50	-3.30	1.75 H	37	26.75	13.45
4	179.61	42.59 QP	43.50	-0.91	1.25 H	193	30.53	12.06
5	220.44	40.24 QP	46.00	-5.76	1.25 H	331	29.01	11.23
6	259.33	39.79 QP	46.00	-6.21	1.25 H	319	27.10	12.69
7	286.55	44.15 QP	46.00	-1.85	1.00 H	304	31.02	13.14
8	298.21	37.96 QP	46.00	-8.04	1.25 H	136	24.64	13.32
9	327.38	37.70 QP	46.00	-8.30	1.00 H	250	23.69	14.01
10	389.59	36.17 QP	46.00	-9.83	1.00 H	70	20.70	15.47
11	393.48	38.31 QP	46.00	-7.69	1.00 H	157	22.75	15.56
12	434.31	39.40 QP	46.00	-6.60	1.00 H	193	22.66	16.74
13	533.47	39.44 QP	46.00	-6.56	1.50 H	7	19.90	19.54

ANTENNA POLARITY & TEST DISTANCE: VERTICAL AT 3 M								
No.	Freq. (MHz)	Emission Level (dBuV/m)	Limit (dBuV/m)	Margin (dB)	Antenna Height (m)	Table Angle (Degree)	Raw Value (dBuV)	Correction Factor (dB/m)
1	94.06	31.36 QP	43.50	-12.14	2.00 V	340	22.29	9.07
2	125.17	40.89 QP	43.50	-2.61	1.75 V	304	29.13	11.76
3	138.78	34.74 QP	43.50	-8.76	1.75 V	148	22.48	12.26
4	179.61	43.30 QP	43.50	-0.20	2.00 V	265	31.24	12.06
5	286.55	33.19 QP	46.00	-12.81	1.50 V	67	20.05	13.14
6	407.09	37.38 QP	46.00	-8.62	1.25 V	250	21.46	15.92
7	434.31	33.88 QP	46.00	-12.12	1.75 V	157	17.14	16.74
8	492.64	33.12 QP	46.00	-12.88	1.75 V	277	14.60	18.53
9	533.47	33.14 QP	46.00	-12.86	1.00 V	10	13.60	19.54
10	667.63	37.97 QP	46.00	-8.03	1.25 V	298	16.26	21.70

- REMARKS:**
1. Emission level(dBuV/m)=Raw Value(dBuV) + Correction Factor(dB/m)
 2. Correction Factor(dB/m) = Antenna Factor (dB/m) + Cable Factor (dB)
 3. The other emission levels were very low against the limit.
 4. Margin value = Emission level – Limit value.

4.2 CONDUCTED EMISSION MEASUREMENT

4.2.1 LIMITS OF CONDUCTED EMISSION MEASUREMENT

FREQUENCY OF EMISSION (MHz)	CONDUCTED LIMIT (dB μ V)	
	Quasi-peak	Average
0.15 ~ 0.5	66 to 56	56 to 46
0.5 ~ 5	56	46
5 ~ 30	60	50

- NOTE:**
1. The lower limit shall apply at the transition frequencies.
 2. The limit decreases in line with the logarithm of the frequency in the range of 0.15 to 0.50 MHz.
 3. All emanations from a class A/B digital device or system, including any network of conductors and apparatus connected thereto, shall not exceed the level of field strengths specified above.

4.2.2 TEST INSTRUMENTS

DESCRIPTION & MANUFACTURER	MODEL NO.	SERIAL NO.	CALIBRATED UNTIL
Test Receiver ROHDE & SCHWARZ	ESCS30	100289	Dec. 08, 2007
RF signal cable Woken	5D-FB	Cable-HYCO3-01	Jan. 06, 2008
LISN ROHDE & SCHWARZ	ESH2-Z5	100100	Jan. 08, 2008
LISN ROHDE & SCHWARZ	ESH3-Z5	100311	Jan. 16, 2008
Software ADT	ADT_Cond_V3	NA	NA

- NOTE:**
1. The calibration interval of the above test instruments is 12 months and the calibrations are traceable to NML/ROC and NIST/USA.
 2. The test was performed in HwaYa Shielded Room 2.
 3. The VCCI Site Registration No. is C-2047.

4.2.3 TEST PROCEDURES

- a. The EUT was placed 0.4 meters from the conducting wall of the shielded room with EUT being connected to the power mains through a line impedance stabilization network (LISN). Other support units were connected to the power mains through another LISN. The two LISNs provide 50 ohm/ 50uH of coupling impedance for the measuring instrument.
- b. Both lines of the power mains connected to the EUT were checked for maximum conducted interference.
- c. The frequency range from 150kHz to 30MHz was searched. Emission levels under (Limit - 20dB) was not recorded.

NOTE: All modes of operation were investigated and the worst-case emissions are reported.

4.2.4 DEVIATION FROM TEST STANDARD

No deviation

4.2.5 TEST SETUP

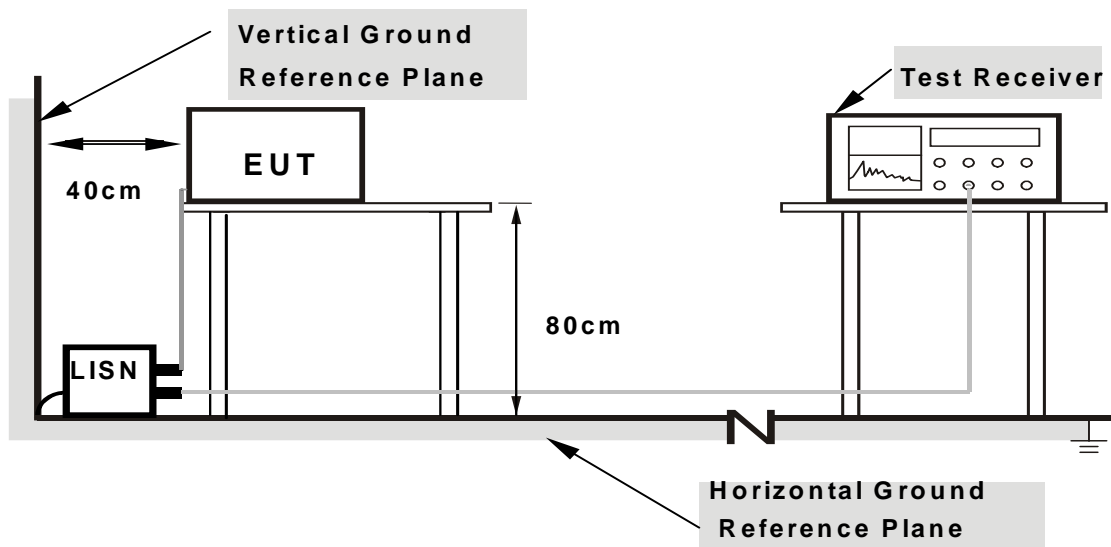

- Note:**
1. Support units were connected to second LISN.
 2. Both of LISNs (AMN) are 80 cm from EUT and at least 80 from other units and other metal planes

For the actual test configuration, please refer to the attached file (Test Setup Photo).

4.2.6 EUT OPERATING CONDITIONS

Same as item 4.1.6.

4.2.7 TEST RESULTS

CONDUCTED WORST CASE DATA

EUT TEST CONDITION		MEASUREMENT DETAIL	
CHANNEL	Channel 0	PHASE	Line 1
MODULATION TYPE	GFSK	6dB BANDWIDTH	9 kHz
ENVIRONMENTAL CONDITIONS	20deg. C, 60%RH, 991hPa	INPUT POWER (SYSTEM)	120Vac, 60 Hz
TEST MODE	A	TESTED BY	Match Tsui

No	Freq. [MHz]	Corr. Factor (dB)	Reading Value		Emission Level		Limit		Margin	
			[dB (uV)]		[dB (uV)]		[dB (uV)]		(dB)	
			Q.P.	AV.	Q.P.	AV.	Q.P.	AV.	Q.P.	AV.
1	0.177	0.10	48.97	-	49.07	-	64.61	54.61	-15.54	-
2	0.474	0.10	40.67	-	40.77	-	56.44	46.44	-15.67	-
3	0.713	0.11	41.15	-	41.26	-	56.00	46.00	-14.74	-
4	1.543	0.17	39.97	-	40.14	-	56.00	46.00	-15.86	-
5	4.570	0.28	40.28	-	40.56	-	56.00	46.00	-15.44	-
6	7.480	0.31	38.42	-	38.73	-	60.00	50.00	-21.27	-

- REMARKS:**
1. Q.P. and AV. are abbreviations of quasi-peak and average individually.
 2. "-": The Quasi-peak reading value also meets average limit and measurement with the average detector is unnecessary.
 3. The emission levels of other frequencies were very low against the limit.
 4. Margin value = Emission level - Limit value
 5. Correction factor = Insertion loss + Cable loss
 6. Emission Level = Correction Factor + Reading Value.

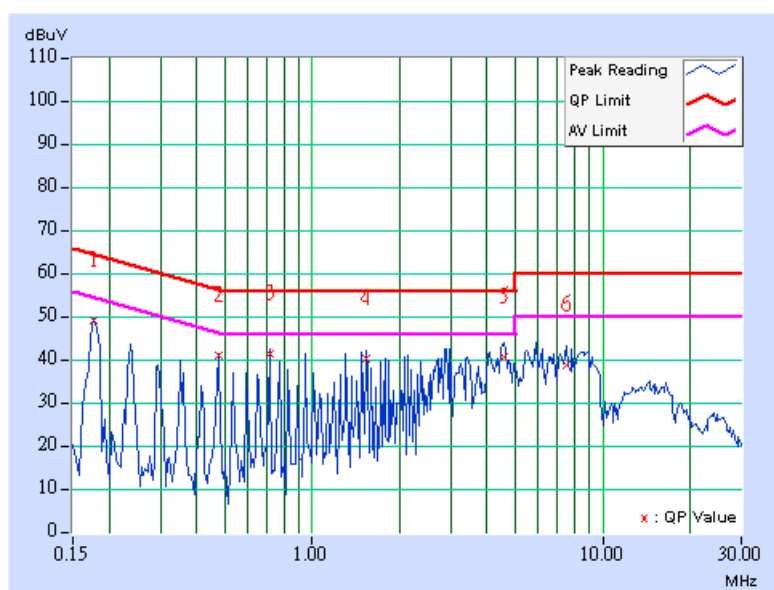

EUT TEST CONDITION		MEASUREMENT DETAIL	
CHANNEL	Channel 0	PHASE	Line 2
MODULATION TYPE	GFSK	6dB BANDWIDTH	9 kHz
ENVIRONMENTAL CONDITIONS	20deg. C, 60%RH, 991hPa	INPUT POWER (SYSTEM)	120Vac, 60 Hz
TEST MODE	A	TESTED BY	Match Tsui

No	Freq. [MHz]	Corr. Factor (dB)	Reading Value		Emission Level		Limit		Margin	
			[dB (uV)]		[dB (uV)]		[dB (uV)]		(dB)	
			Q.P.	AV.	Q.P.	AV.	Q.P.	AV.	Q.P.	AV.
1	0.177	0.10	47.24	-	47.34	-	64.61	54.61	-17.27	-
2	0.476	0.11	37.04	-	37.15	-	56.42	46.42	-19.26	-
3	0.709	0.16	35.98	-	36.14	-	56.00	46.00	-19.86	-
4	1.246	0.21	35.21	-	35.42	-	56.00	46.00	-20.58	-
5	4.508	0.29	35.91	-	36.20	-	56.00	46.00	-19.80	-
6	8.754	0.40	34.11	-	34.51	-	60.00	50.00	-25.49	-

- REMARKS:**
1. Q.P. and AV. are abbreviations of quasi-peak and average individually.
 2. "-": The Quasi-peak reading value also meets average limit and measurement with the average detector is unnecessary.
 3. The emission levels of other frequencies were very low against the limit.
 4. Margin value = Emission level - Limit value
 5. Correction factor = Insertion loss + Cable loss
 6. Emission Level = Correction Factor + Reading Value.

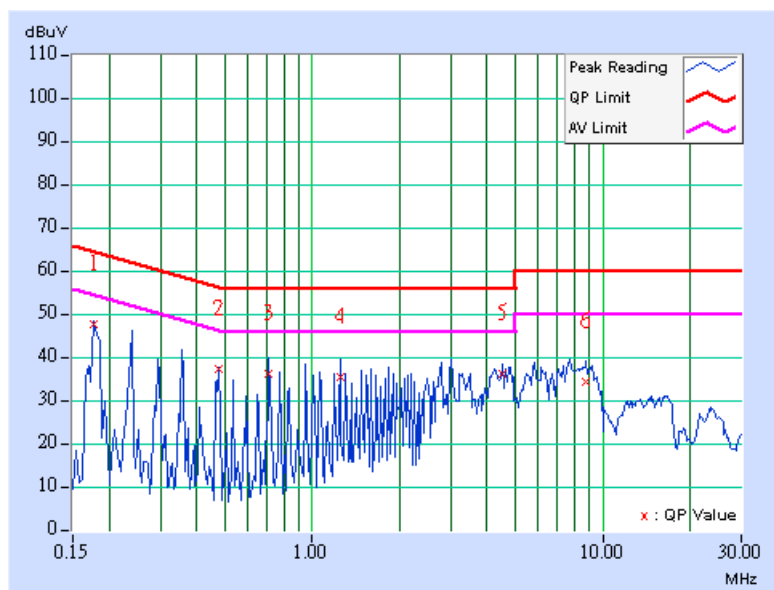



4.3 NUMBER OF HOPPING FREQUENCY USED

4.3.1 LIMIT OF HOPPING FREQUENCY USED

At least 15 channels frequencies, and should be equally spaced.

4.3.2 TEST INSTRUMENTS

DESCRIPTION & MANUFACTURER	MODEL NO.	SERIAL NO.	CALIBRATED UNTIL
SPECTRUM ANALYZER	FSP40	100040	Jun. 28, 2008

NOTE: The calibration interval of the above test instruments is 12 months. And the calibrations are traceable to NML/ROC and NIST/USA.

4.3.3 TEST PROCEDURES

- a. Check the calibration of the measuring instrument (SA) using either an internal calibrator or a known signal from an external generator.
- b. Turn on the EUT and connect its antenna terminal to measurement via a low loss cable. Then set it to any one measured frequency within its operating range and make sure the instrument is operated in its linear range.
- c. Set the SA on MaxHold Mode, and then keep the EUT in hopping mode. Record all the signals from each channel until each one has been recorded.
- d. Set the SA on View mode and then plot the result on SA screen.
- e. Repeat above procedures until all frequencies measured were complete.

4.3.4 DEVIATION FROM TEST STANDARD

No deviation.

4.3.5 TEST SETUP

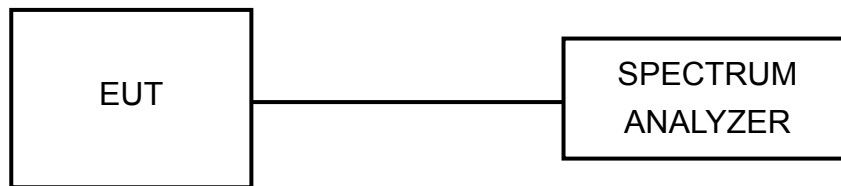

4.3.6 TEST RESULTS

There are 79 hopping frequencies in the hopping mode. Please refer to next two pages for the test result. On the plots, it shows that the hopping frequencies are equally spaced.

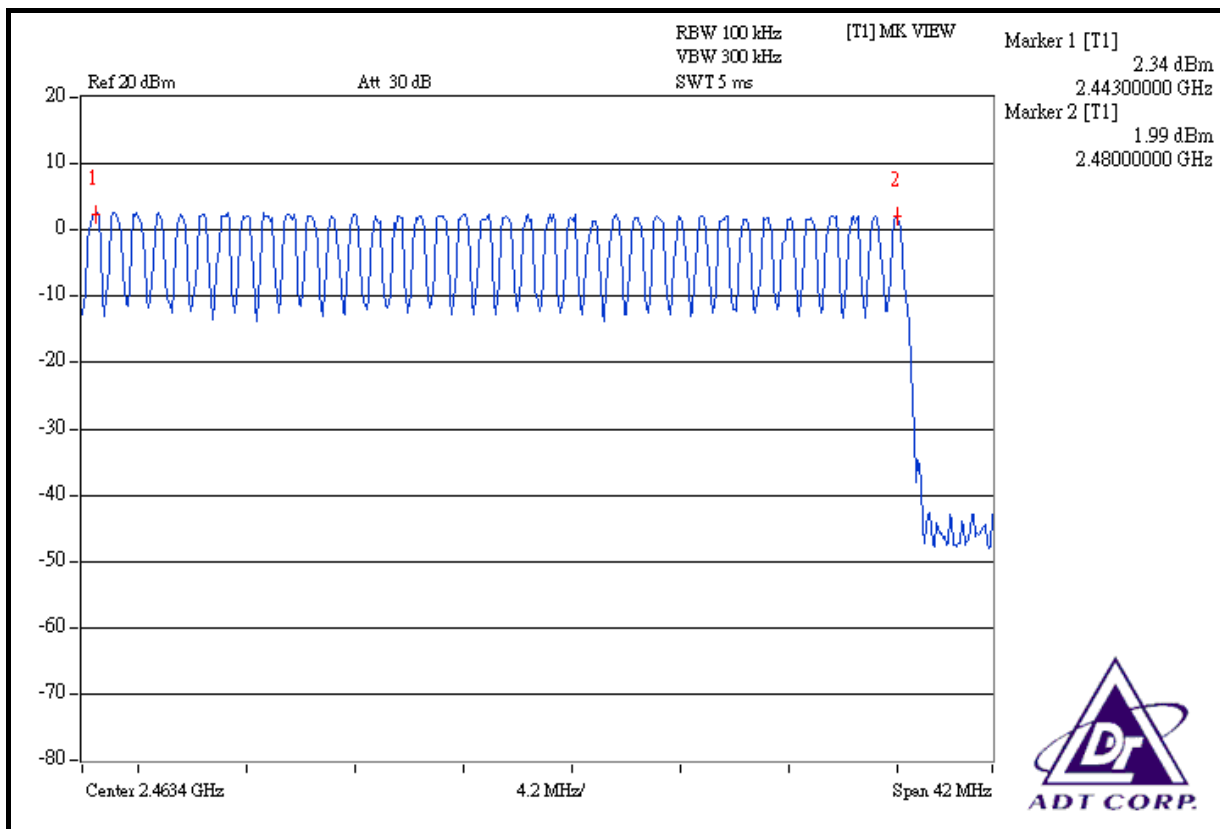
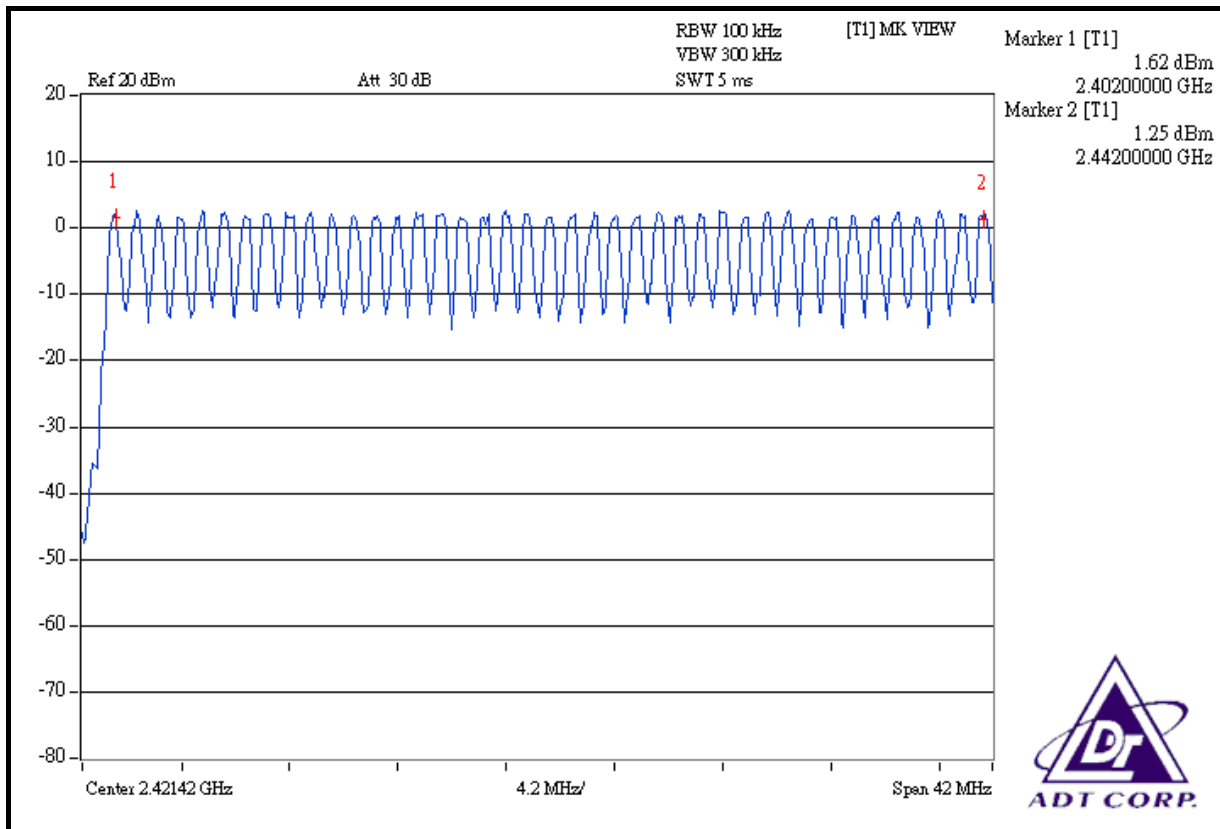



4.4 DWELL TIME ON EACH CHANNEL

4.4.1 LIMIT OF DWELL TIME USED

The average time of occupancy on any channel shall not be greater than 0.4 seconds within a period of 0.4 seconds multiplied by the number of hopping channels employed.

4.4.2 TEST INSTRUMENTS

DESCRIPTION & MANUFACTURER	MODEL NO.	SERIAL NO.	CALIBRATED UNTIL
SPECTRUM ANALYZER	FSP40	100040	Jun. 28, 2008

NOTES: The calibration interval of the above test instruments is 12 months. And the calibrations are traceable to NML/ROC and NIST/USA.

4.4.3 TEST PROCEDURES

- a. Check the calibration of the measuring instrument (SA) using either an internal calibrator or a known signal from an external generator.
- b. Turn on the EUT and connect its antenna terminal to measurement via a low loss cable. Then set it to any one measured frequency within its operating range and make sure the instrument is operated in its linear range.
- c. Adjust the center frequency of SA on any frequency be measured and set SA to zero span mode. And then, set RBW and VBW of spectrum analyzer to proper value.
- d. Measure the time duration of one transmission on the measured frequency. And then plot the result with time difference of this time duration.
- e. Repeat above procedures until all different time-slot modes have been completed.

4.4.4 DEVIATION FROM TEST STANDARD

No deviation.

4.4.5 TEST SETUP

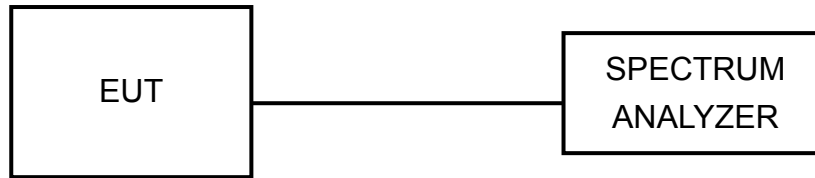

4.4.6 TEST RESULTS

Mode	Number of transmission in a 31.6 (79Hopping*0.4)	Length of transmission time (msec)	Result (msec)	Limit (msec)
DH1	50 (times / 5 sec) *6.32=316.00 times	0.463	146.308	400
DH3	25 (times / 5 sec) *6.32=158.00 times	1.714	270.812	400
DH5	17 (times / 5 sec) *6.32=107.44 times	2.990	321.246	400

NOTE: Test plots of the transmitting time slot are shown on next 3 pages.



DH1

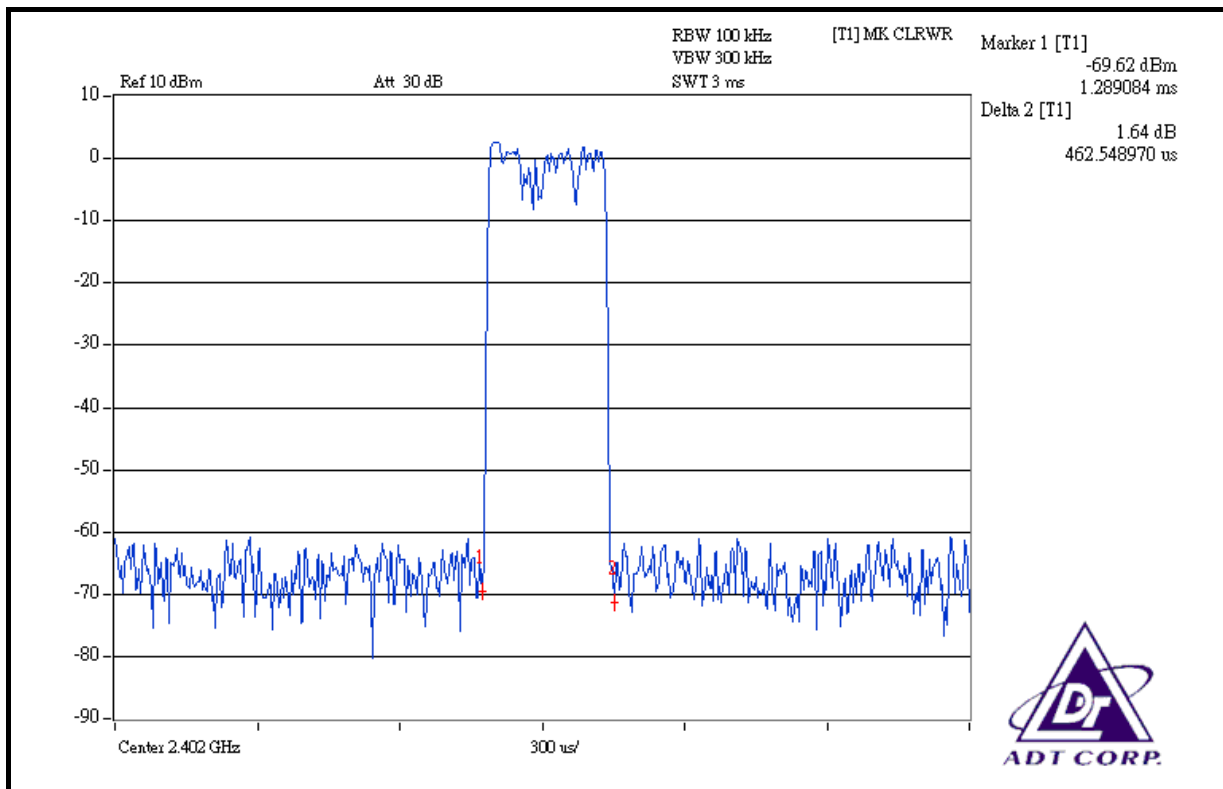
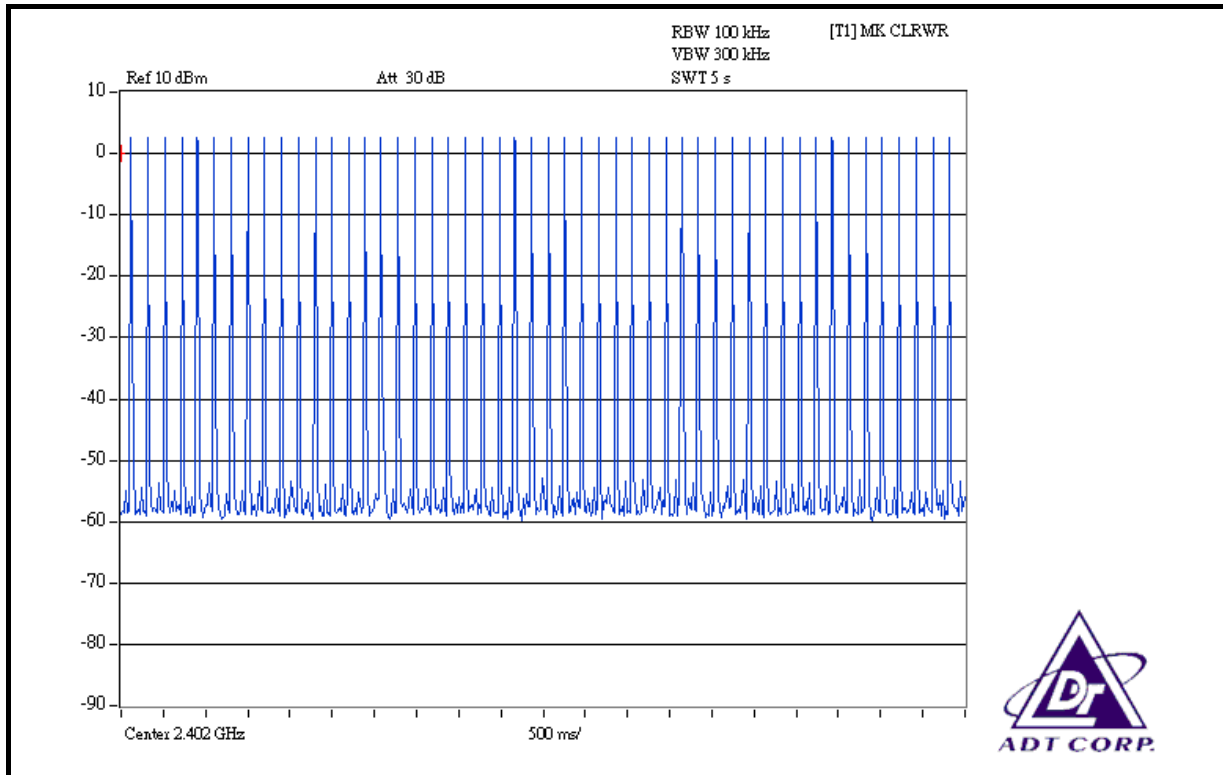



DH3

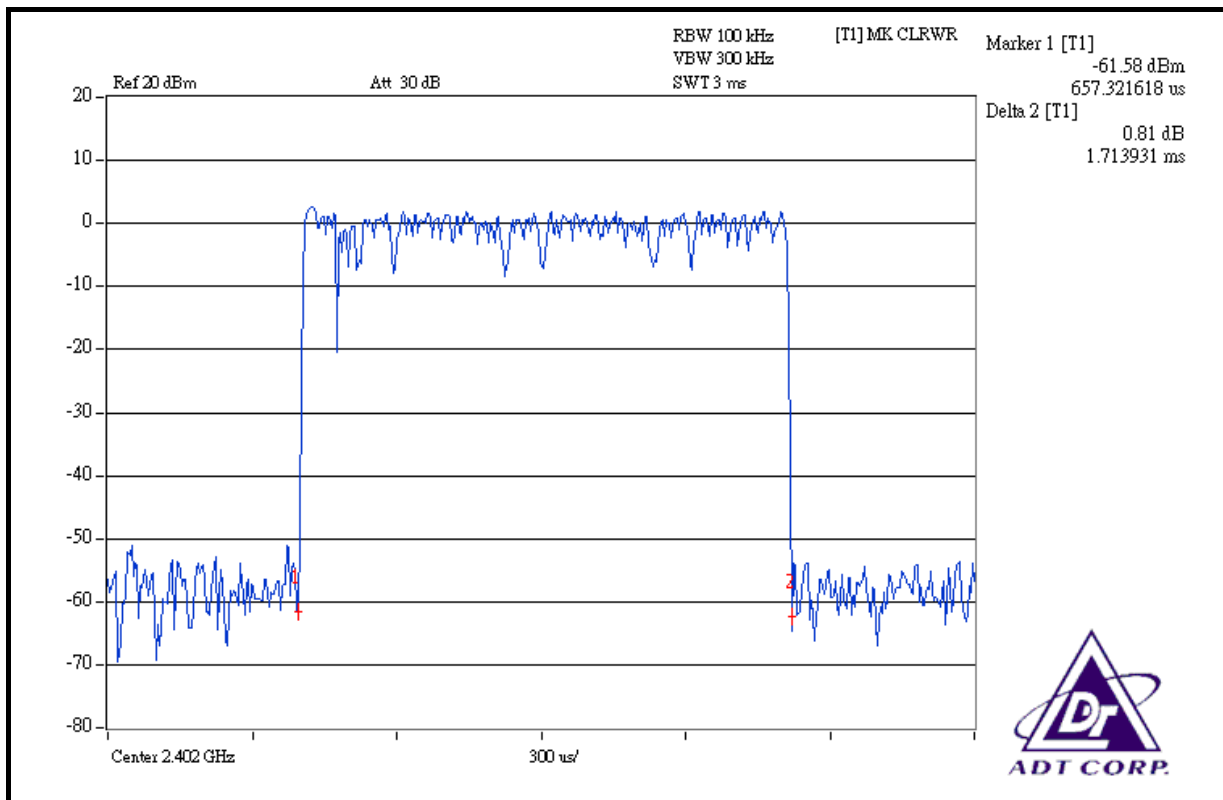
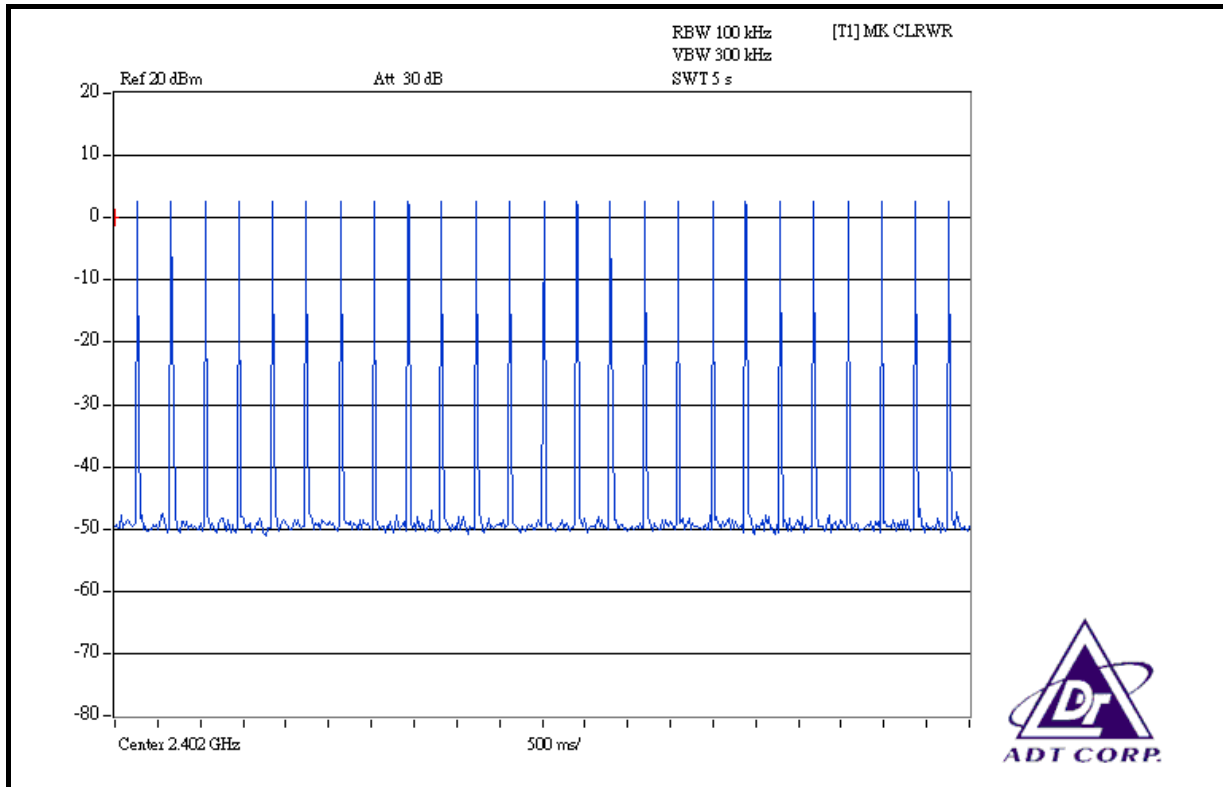

DH5

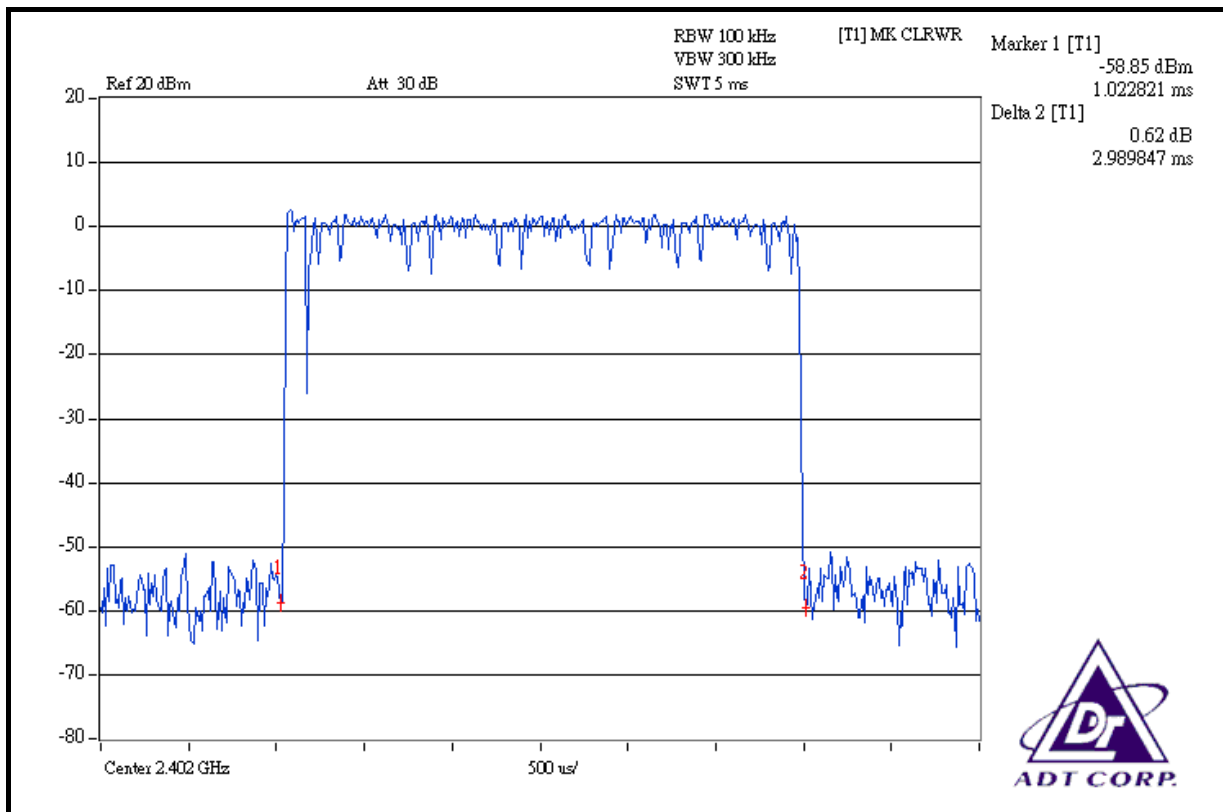
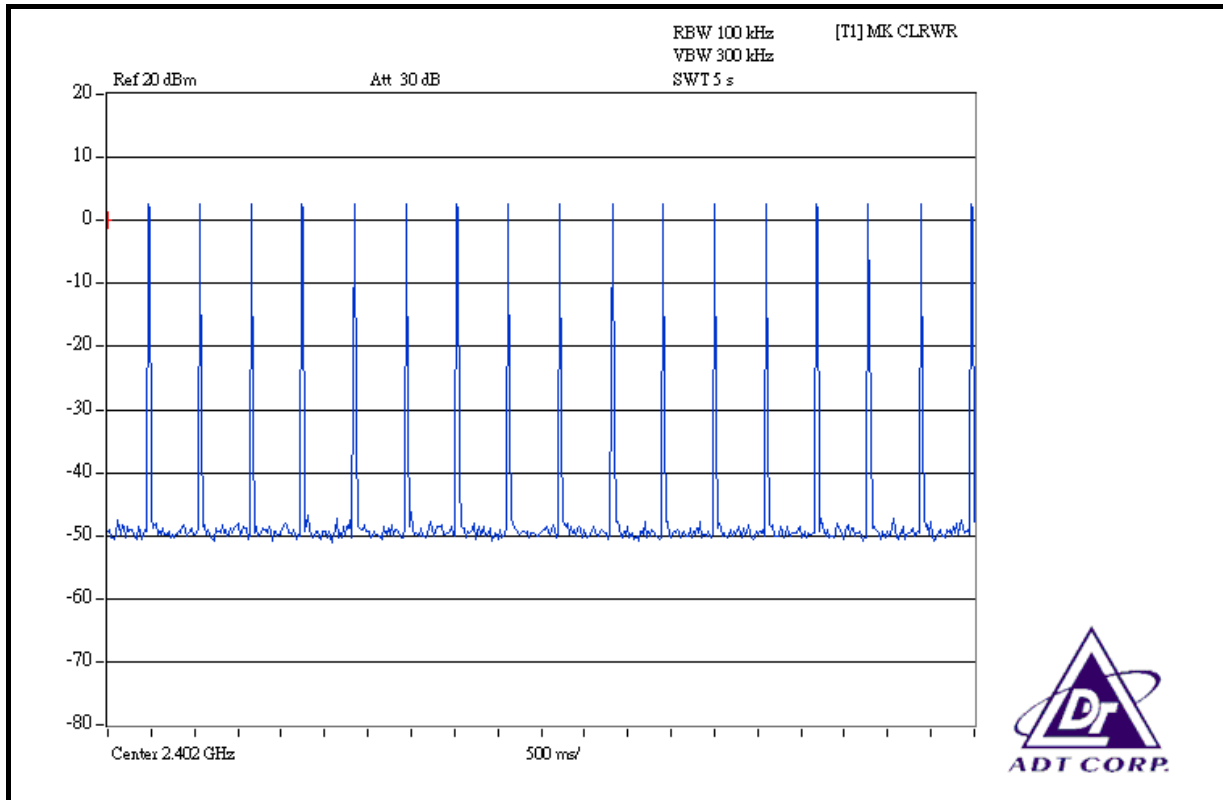



4.5 CHANNEL BANDWIDTH

4.5.1 LIMITS OF CHANNEL BANDWIDTH

For frequency hopping system operating in the 2400-2483.5MHz, If the 20dB bandwidth of hopping channel is greater than 25kHz, the 20dB bandwidth of hopping channel shall be a minimum limit for the hopping channel separation.

4.5.2 TEST INSTRUMENTS

DESCRIPTION & MANUFACTURER	MODEL NO.	SERIAL NO.	CALIBRATED UNTIL
SPECTRUM ANALYZER	FSP40	100040	Jun. 28, 2008

NOTE: The calibration interval of the above test instruments is 12 months. And the calibrations are traceable to NML/ROC and NIST/USA.

4.5.3 TEST PROCEDURE

- a. Check the calibration of the measuring instrument using either an internal calibrator or a known signal from an external generator.
- b. Turn on the EUT and connect it to measurement instrument. Then set it to any one convenient frequency within its operating range. Set a reference level on the measuring instrument equal to the highest peak value.
- c. Measure the frequency difference of two frequencies that were attenuated 20dB from the reference level. Record the frequency difference as the emission bandwidth.
- d. Repeat above procedures until all frequencies measured were complete.

4.5.4 DEVIATION FROM TEST STANDARD

No deviation.

4.5.5 TEST SETUP

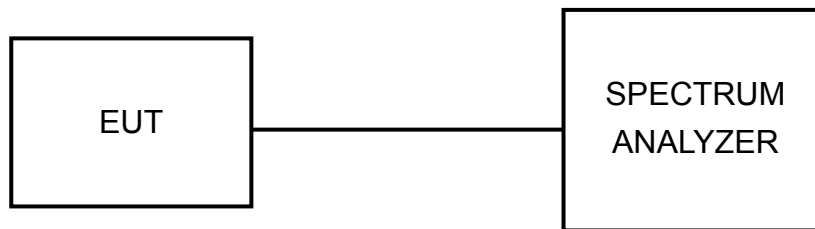

4.5.6 EUT OPERATING CONDITION

The software provided by client enabled the EUT to transmit and receive data at lowest, middle and highest channel frequencies individually.

4.5.7 TEST RESULTS

MODULATION TYPE	GFSK	ENVIRONMENTAL CONDITIONS	25deg. C, 65%RH, 991hPa
INPUT POWER (SYSTEM)	120Vac, 60 Hz	TESTED BY	Brad Wu

CHANNEL	CHANNEL FREQUENCY (MHz)	20dB BANDWIDTH (MHz)
0	2402	0.935
39	2441	0.835
78	2480	0.835



CH 0

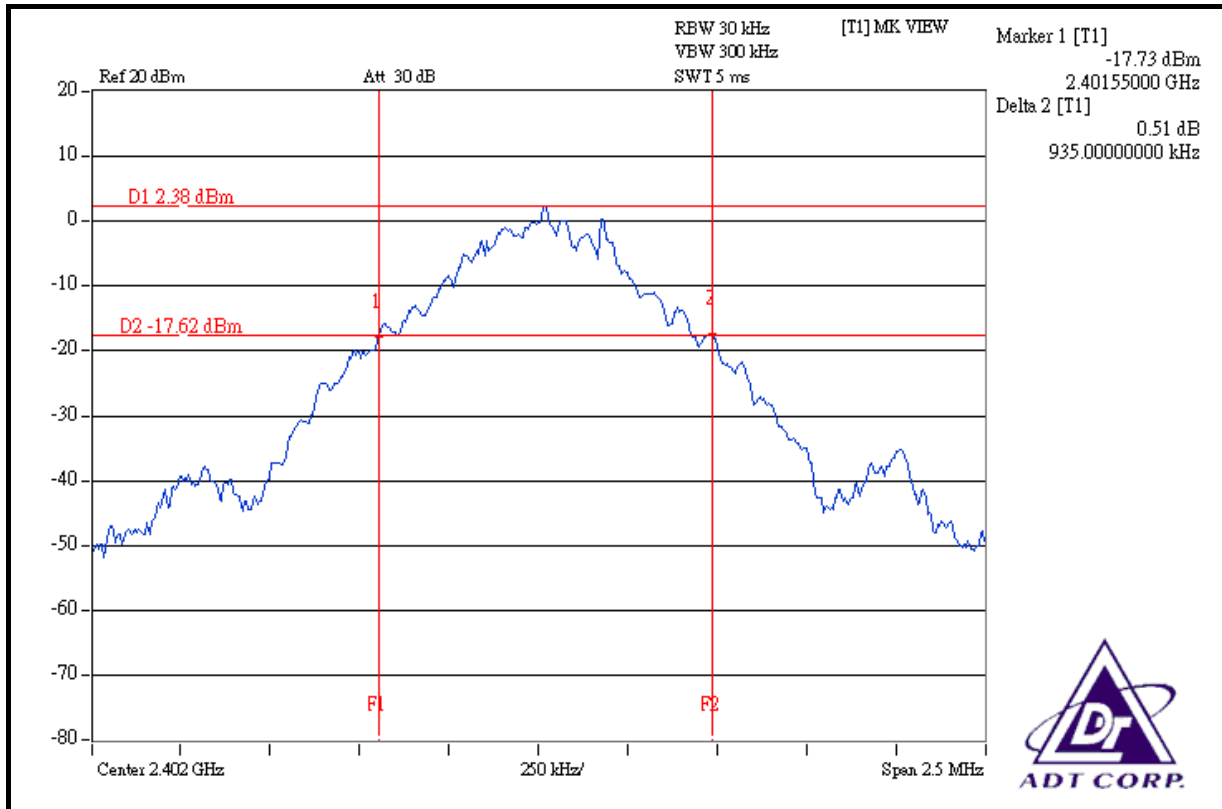

CH 39

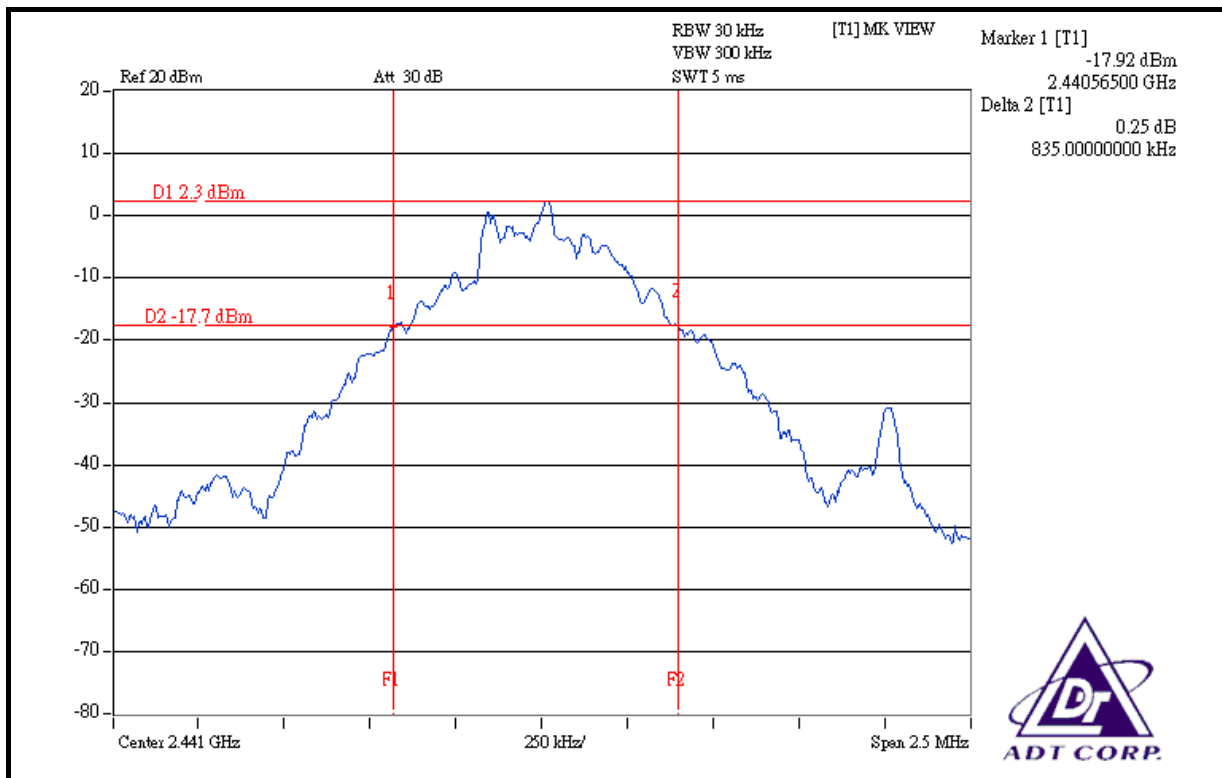

CH 78

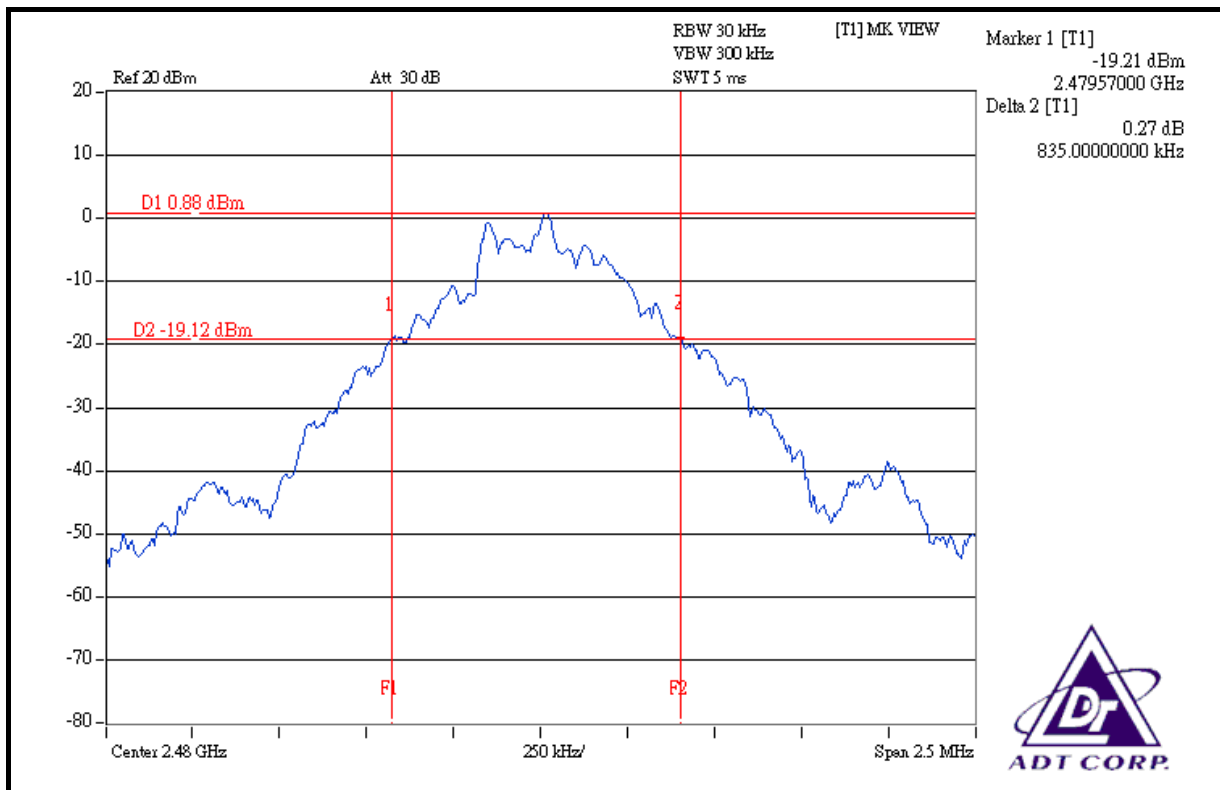



4.6 HOPPING CHANNEL SEPARATION

4.6.1 LIMIT OF HOPPING CHANNEL SEPARATION

At least 25kHz or 20dB hopping channel bandwidth (whichever is greater).

4.6.2 TEST INSTRUMENTS

DESCRIPTION & MANUFACTURER	MODEL NO.	SERIAL NO.	CALIBRATED UNTIL
SPECTRUM ANALYZER	FSP40	100040	Jun. 28, 2008

NOTES: The calibration interval of the above test instruments is 12 months. And the calibrations are traceable to NML/ROC and NIST/USA.

4.6.3 TEST PROCEDURES

1. Check the calibration of the measuring instrument using either an internal calibrator or a known signal from an external generator.
2. Turn on the EUT and connect it to measurement instrument. Then set it to any one convenient frequency within its operating range.
3. By using the MaxHold function record the separation of two adjacent channels.
4. Measure the frequency difference of these two adjacent channels by SA MARK function. And then plot the result on SA screen.
5. Repeat above procedures until all frequencies measured were complete.

4.6.4 DEVIATION FROM TEST STANDARD

No deviation.

4.6.5 TEST SETUP

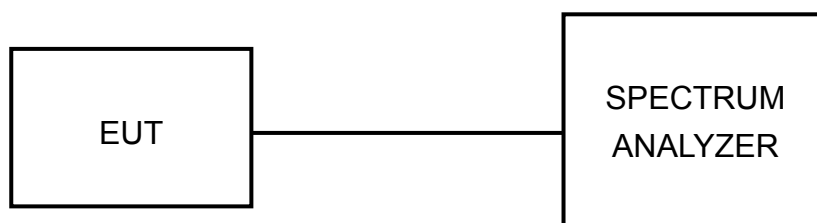

4.6.6 TEST RESULTS

MODULATION TYPE	GFSK	ENVIRONMENTAL CONDITIONS	25deg. C, 65%RH, 991hPa
INPUT POWER (SYSTEM)	120Vac, 60 Hz	TESTED BY	Brad Wu

CHANNEL	FREQUENCY (MHz)	ADJACENT CHANNEL SEPARATION (MHz)	20dB BANDWIDTH (MHz)	PASS / FAIL
0	2402	1.000	0.935	PASS
39	2441	1.001	0.835	PASS
78	2480	1.005	0.835	PASS

NOTE: The minimum limit is 20dB bandwidth. Test results please refer to next two pages.



CH 0

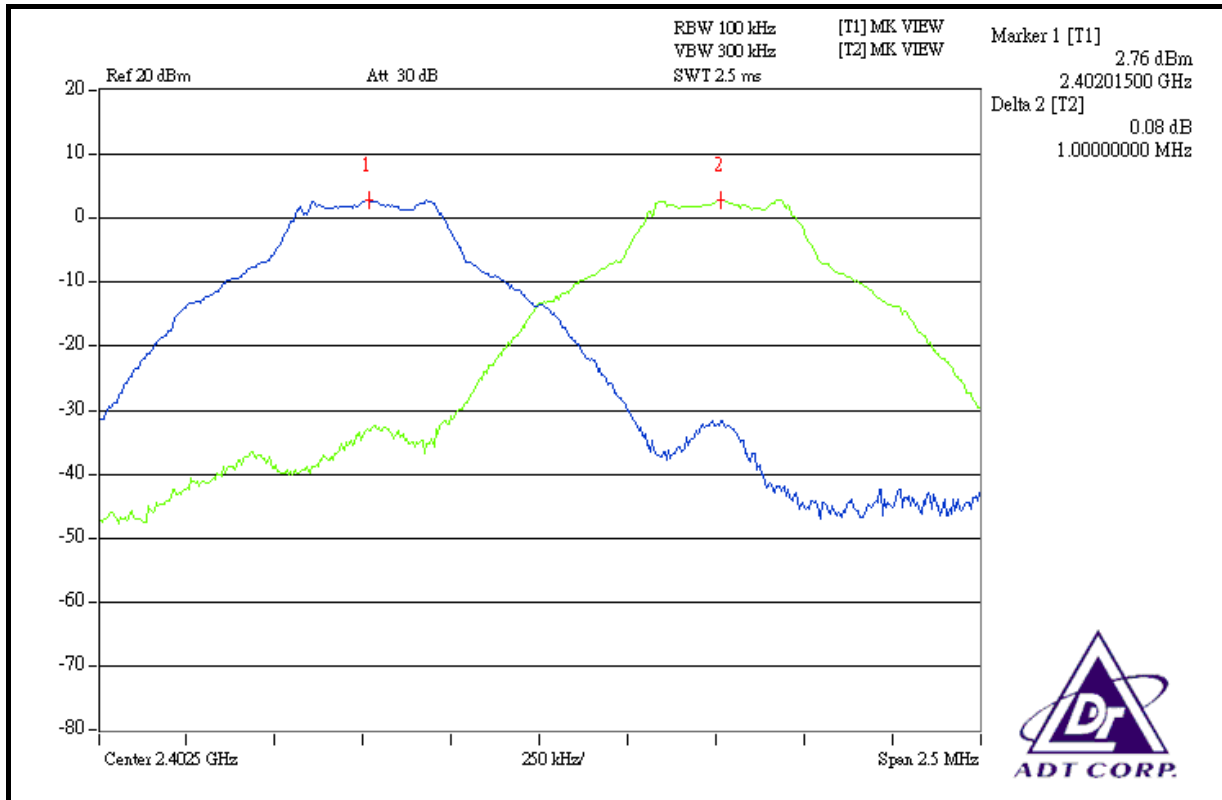

CH 39

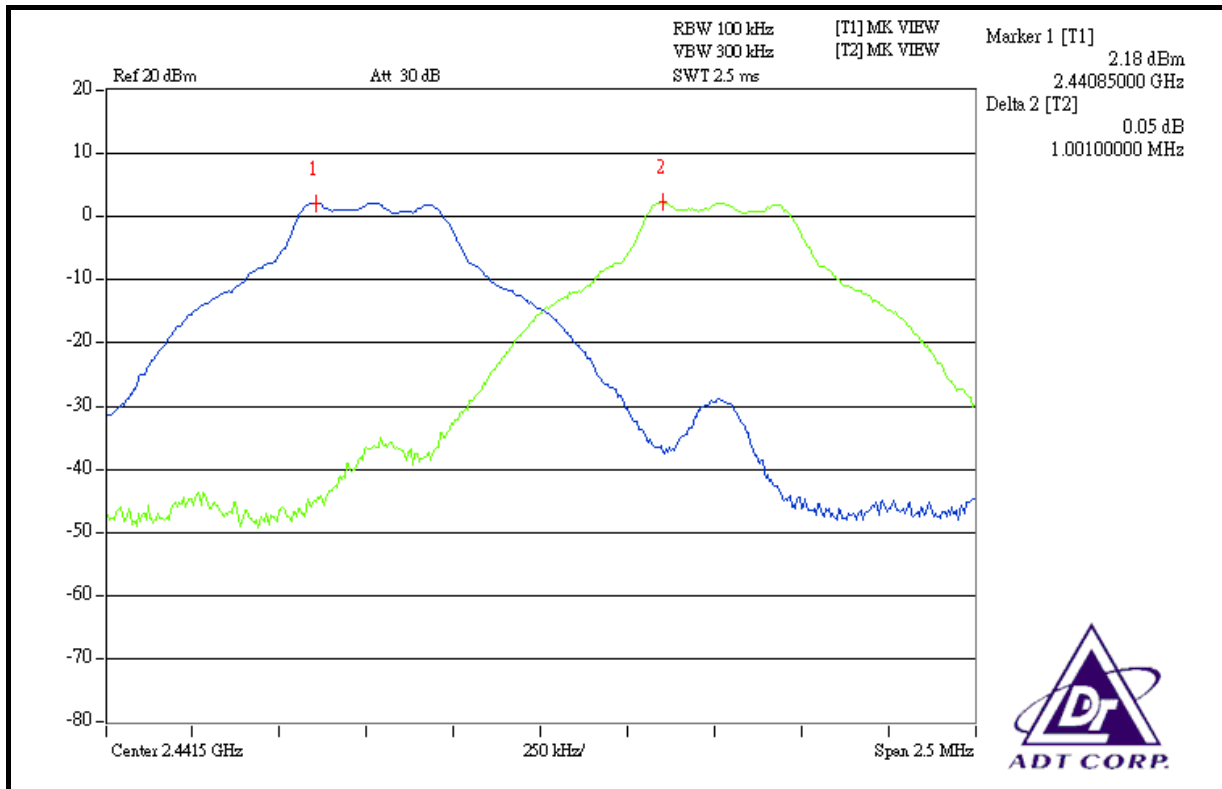



CH 78

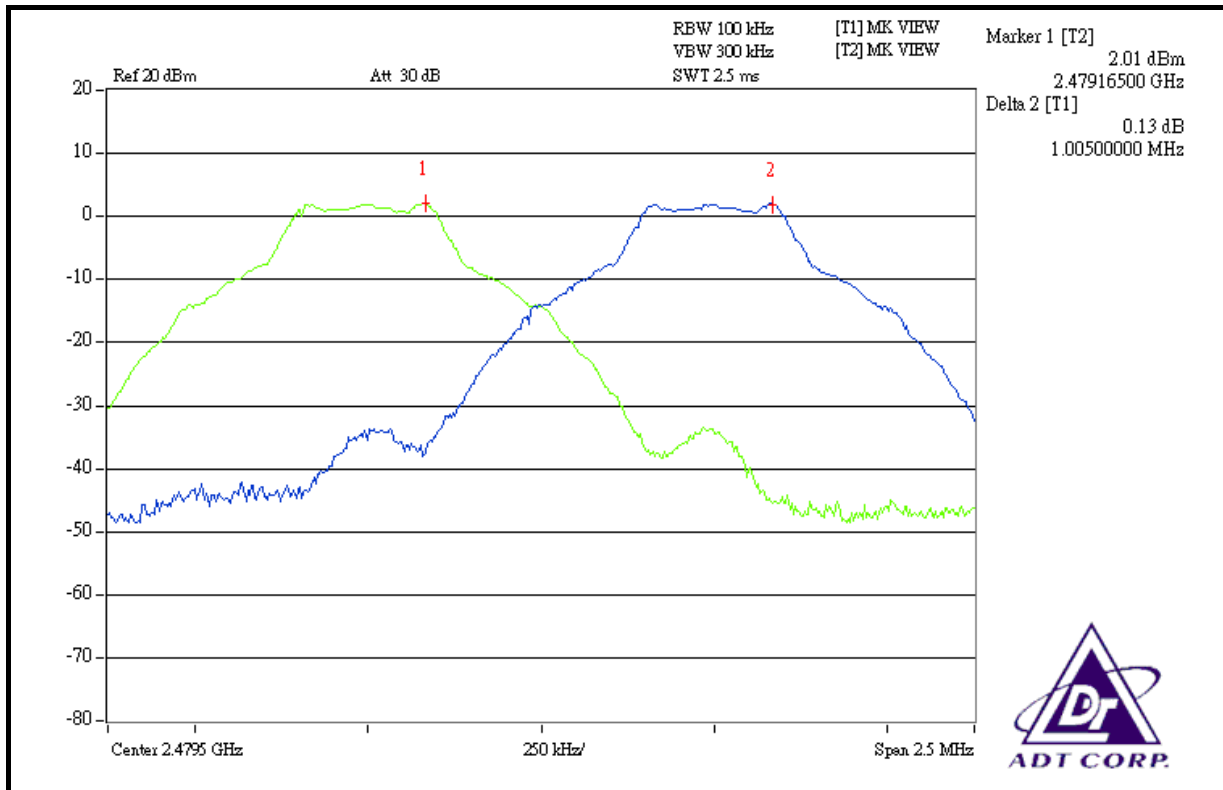



4.7 MAXIMUM PEAK OUTPUT POWER

4.7.1 LIMITS OF MAXIMUM PEAK OUTPUT POWER MEASUREMENT

The Maximum Peak Output Power Measurement is 30dBm.

4.7.2 TEST INSTRUMENTS

DESCRIPTION & MANUFACTURER	MODEL NO.	SERIAL NO.	CALIBRATED UNTIL
SPECTRUM ANALYEER	FSEK30	100049	Aug. 14, 2006

NOTE: The calibration interval of the above test instruments is 12 months and the calibrations are traceable to NML/ROC and NIST/USA.

4.7.3 TEST PROCEDURES

- a. Check the calibration of the measuring instrument using either an internal calibrator or a known signal from an external generator.
- b. Turn on the EUT and connect it to measurement instrument. Then set it to any one convenient frequency within its operating range. Set a reference level on the measuring instrument equal to the highest peak value.
- c. The center frequency of the spectrum analyzer is set to the fundamental frequency and using 3MHz RBW and 10 MHz VBW.
- d. Measure the captured power within the band and recording the plot.
- e. Repeat above procedures until all frequencies required were complete.

4.7.4 DEVIATION FROM TEST STANDARD

No deviation

4.7.5 TEST SETUP

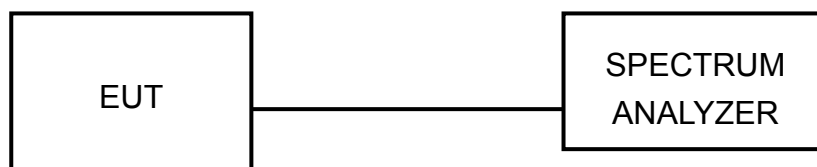

For the actual test configuration, please refer to the related Item – Photographs of the Test Configuration.

4.7.6 EUT OPERATING CONDITION

The software provided by client enabled the EUT to transmit and receive data at lowest, middle and highest channel frequencies individually.

4.7.7 TEST RESULTS

MODULATION TYPE	GFSK	ENVIRONMENTAL CONDITIONS	25deg. C, 65%RH, 991hPa
INPUT POWER (SYSTEM)	120Vac, 60 Hz	TESTED BY	Brad Wu

CHANNEL	CHANNEL FREQUENCY (MHz)	PEAK POWER OUTPUT (mW)	PEAK POWER OUTPUT (dBm)	PEAK POWER LIMIT (dBm)	PASS/FAIL
0	2402	2.023	3.06	30	PASS
39	2441	1.758	2.45	30	PASS
78	2480	2.000	3.01	30	PASS



CH 0

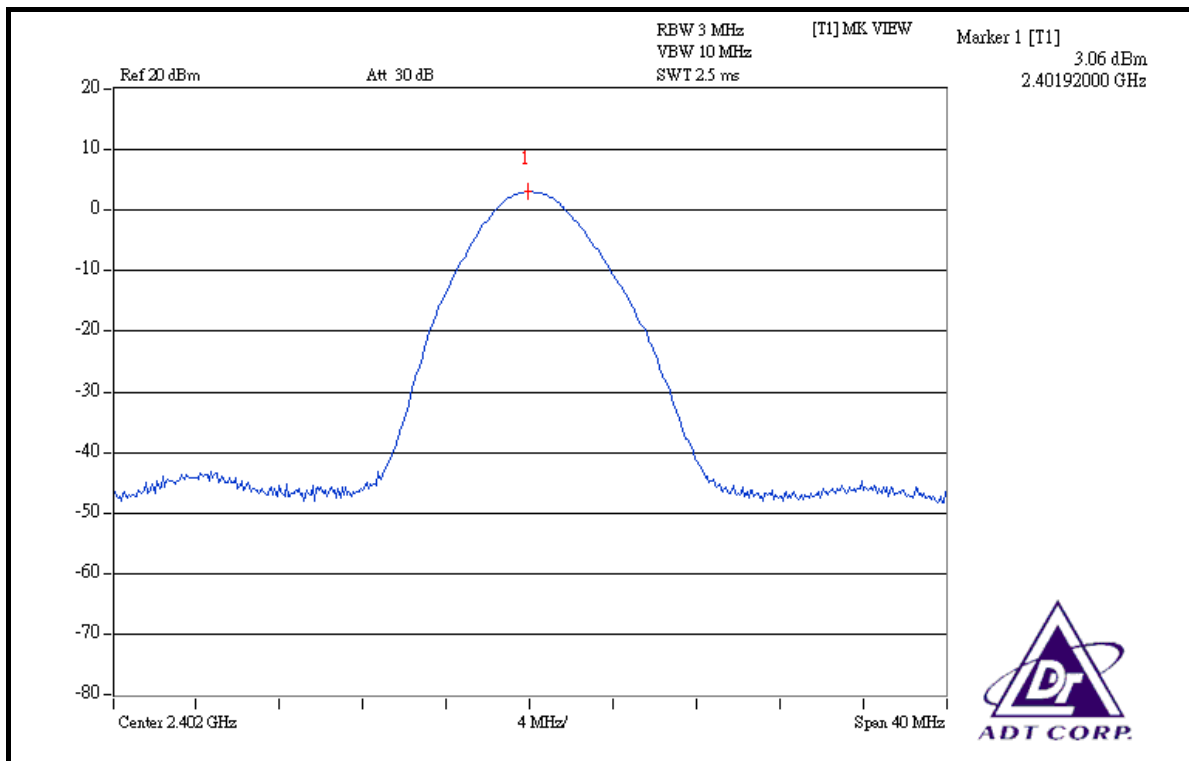

CH 39

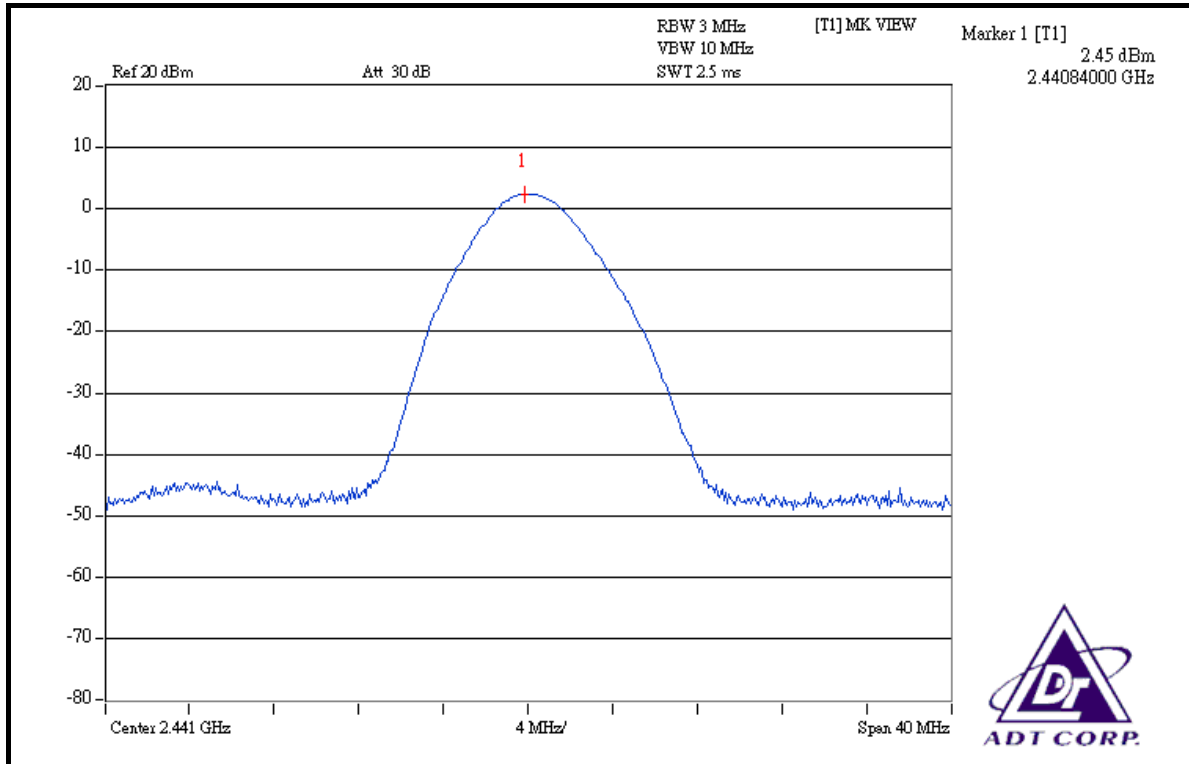

CH 78

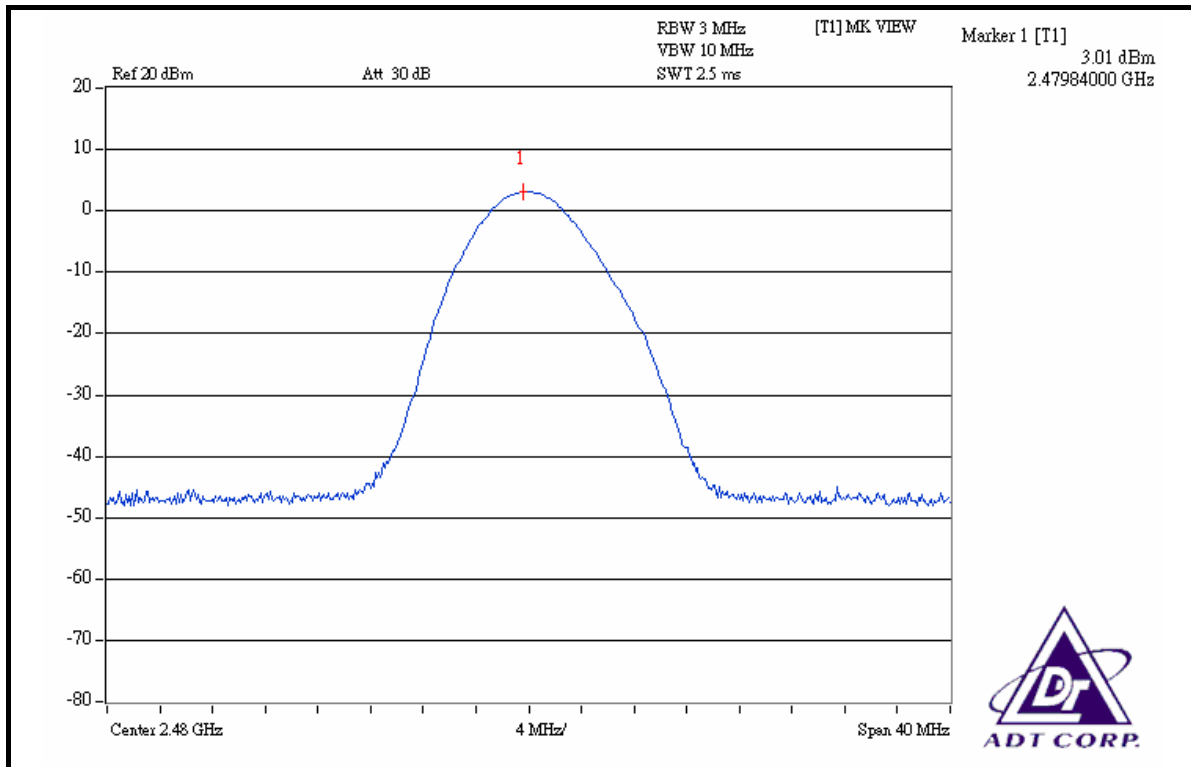



4.8 BAND EDGES MEASUREMENT

4.8.1 LIMITS OF BAND EDGES MEASUREMENT

Below -20dB of the highest emission level of operating band (in 100KHz RBW).

4.8.2 TEST INSTRUMENTS

DESCRIPTION & MANUFACTURER	MODEL NO.	SERIAL NO.	CALIBRATED UNTIL
SPECTRUM ANALYZER	FSP40	100040	Jun. 28, 2008

NOTES: The calibration interval of the above test instruments is 12 months. And the calibrations are traceable to NML/ROC and NIST/USA.

4.8.3 TEST PROCEDURE

The transmitter output was connected to the spectrum analyzer via a low loss cable. Set both RBW and VBW of spectrum analyzer to 100 kHz with suitable frequency span including 100 MHz bandwidth from band edge. The band edges was measured and recorded.

4.8.4 DEVIATION FROM TEST STANDARD

No deviation.

4.8.5 EUT OPERATING CONDITION

The software provided by client enabled the EUT to transmit and receive data at lowest, middle and highest channel frequencies individually.

4.8.6 TEST RESULTS

The spectrum plots are attached on the following 4 images. D1 line indicates the highest level, D2 line indicates the 20dB offset below D1. It shows compliance with the requirement in part 15.247(d).

NOTE 1:

The band edge emission plot on the next page shows 50.57dBc between carrier maximum power and local maximum emission in restrict band (2.3894GHz). The emission of carrier strength list in the test result of channel 0 at the item 4.2.7 is 93.65dBuV/m (Peak), so the maximum field strength in restrict band is $93.65 - 50.57 = 43.08$ dBuV/m, which is under 74 dBuV/m limit.

Average value = $43.08 - 30.10 = 12.98$ dBuV/m, which is under 54dBuV/m limit.

*The DH5 packet was the worse case duty cycle for a transmit dwell time on a channel, based upon bluetooth theory the transmitter is on $0.625 * 5$ per 296.25 ms per channel. Therefore, the duty cycle correction factor be equal to: $20\log(3.125/100) = -30.1$ dB.

Average value = peak reading – 30.1

NOTE 2:

The band edge emission plot on the next second page shows 48.27dBc between carrier maximum power and local maximum emission in restrict band (2.48440GHz). The emission of carrier strength list in the test result of channel 78 at the item 4.2.7 is 94.77dBuV/m (Peak), so the maximum field strength in restrict band is $94.77 - 48.27 = 46.50$ dBuV/m, which is under 74 dBuV/m limit.

Average value = $46.50 - 30.10 = 16.40$ dBuV/m, which is under 54dBuV/m limit.

*The DH5 packet was the worse case duty cycle for a transmit dwell time on a channel, based upon bluetooth theory the transmitter is on $0.625 * 5$ per 296.25 ms per channel. Therefore, the duty cycle correction factor be equal to: $20\log(3.125/100) = -30.1$ dB.

Average value = peak reading – 30.1

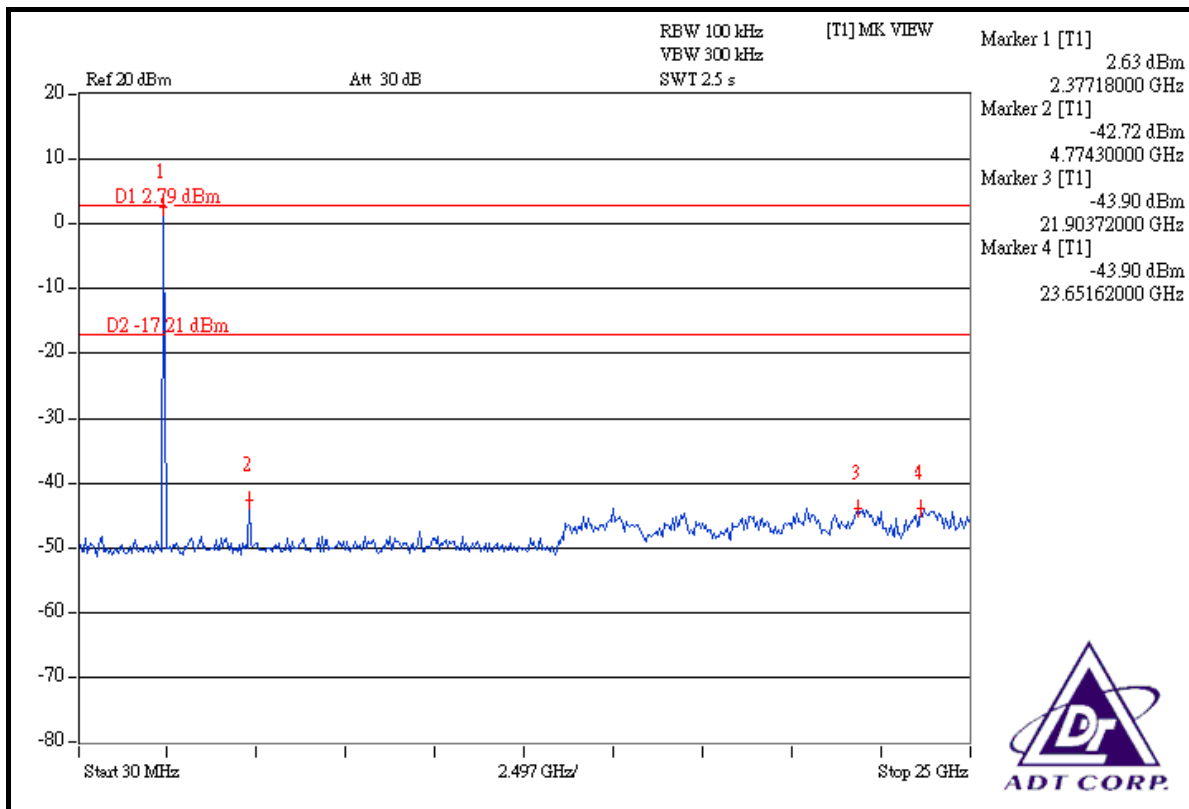
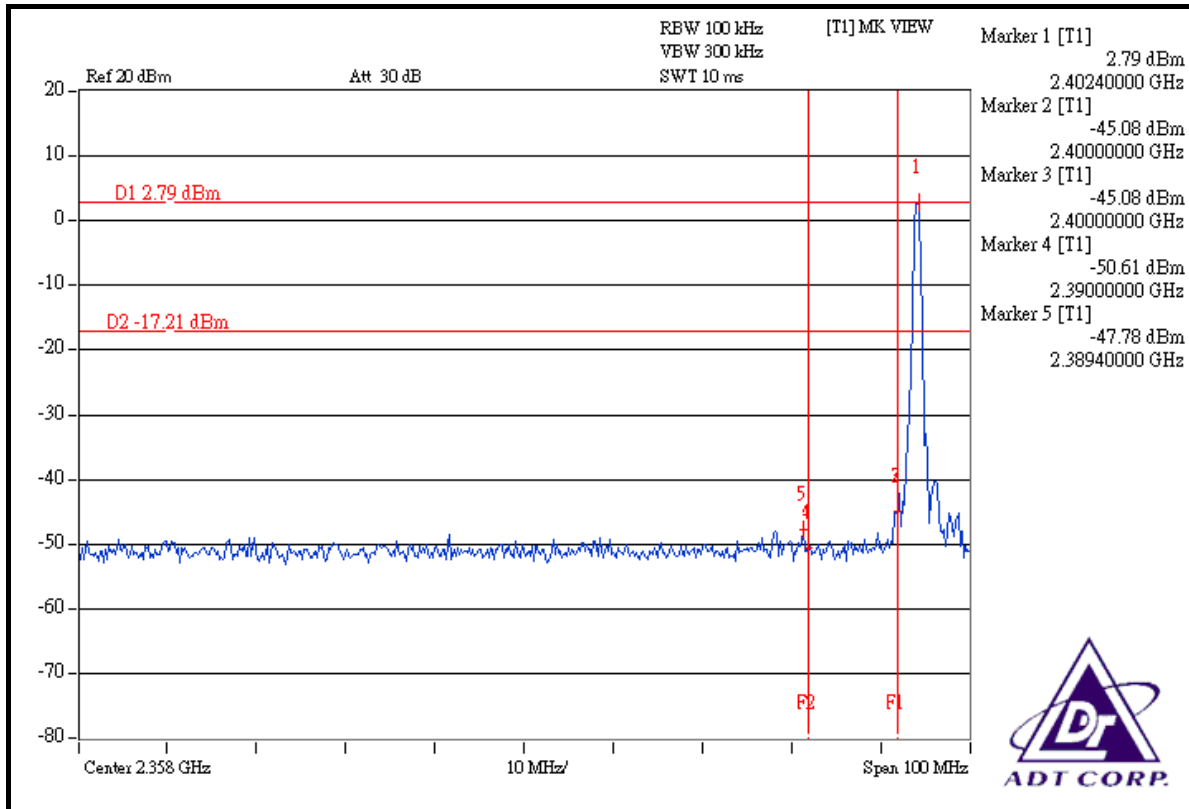

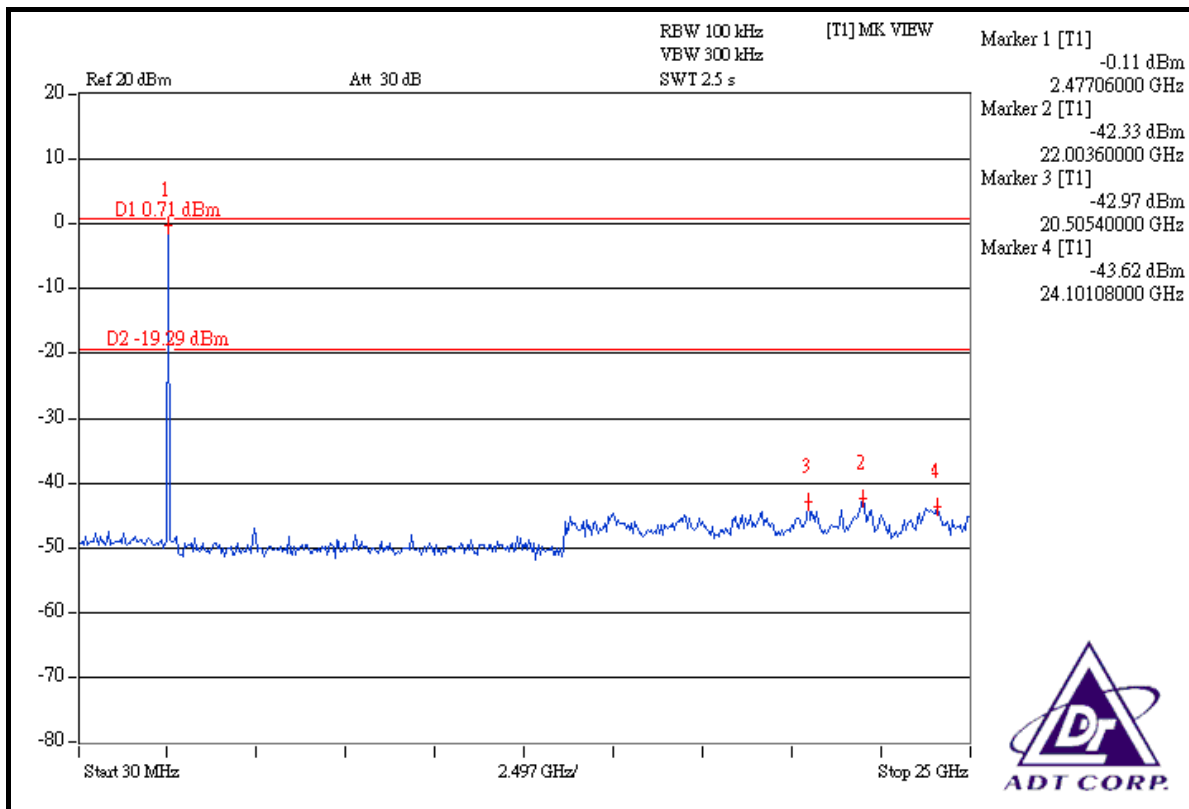
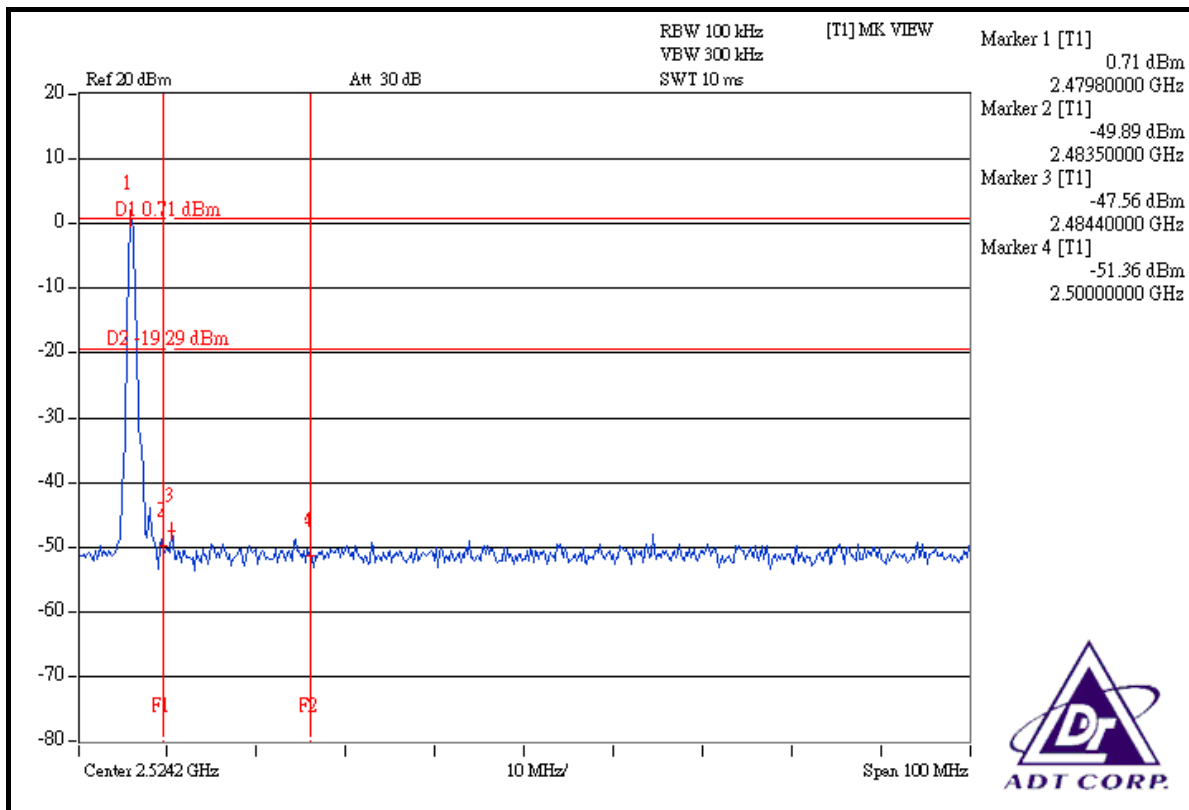

4.9 ANTENNA REQUIREMENT

4.9.1 STANDARD APPLICABLE

For intentional device, according to FCC 47 CFR Section 15.203, an intentional radiator shall be designed to ensure that no antenna other than that furnished by the responsible party shall be used with the device.

And according to FCC 47 CFR Section 15.247 (b), if transmitting antennas of directional gain greater than 6 dBi are used, the power shall be reduced by the amount in dB that the directional gain of the antenna exceeds 6 dBi.

4.9.2 ANTENNA CONNECTED CONSTRUCTION

The antenna used in this product is Bluetooth PIFA antenna without antenna connector. The maximum gain of this antenna is 2.2dBi.



5. PHOTOGRAPHS OF THE TEST CONFIGURATION

Please refer to the attached file (Test Setup Photo).



6. INFORMATION ON THE TESTING LABORATORIES

We, ADT Corp., were founded in 1988 to provide our best service in EMC, Radio, Telecom and Safety consultation. Our laboratories are accredited and approved by the following approval agencies according to ISO/IEC 17025.

USA	FCC, UL, A2LA
Germany	TUV Rheinland
Japan	VCCI
Norway	NEMKO
Canada	INDUSTRY CANADA, CSA
R.O.C.	TAF, BSMI, NCC
Netherlands	Telefication
Singapore	GOST-ASIA(MOU)
Russia	CERTIS(MOU)

Copies of accreditation certificates of our laboratories obtained from approval agencies can be downloaded from our web site:

www.adt.com.tw/index.5/phtml. If you have any comments, please feel free to contact us at the following:

Linko EMC/RF Lab:

Tel: 886-2-26052180

Fax: 886-2-26051924

Hsin Chu EMC/RF Lab:

Tel: 886-3-5935343

Fax: 886-3-5935342

Hwa Ya EMC/RF/Safety Telecom Lab:

Tel: 886-3-3183232

Fax: 886-3-3185050

Web Site: www.adt.com.tw

The address and road map of all our labs can be found in our web site also.



7. APPENDIX-A MODIFICATIONS RECORDERS FOR ENGINEERING CHANGES TO THE EUT BY THE LAB

No any modifications are made to the EUT by the lab during the test.