

FCC Test Report (PART 24)

Report No.: RF160421D16-2

FCC ID: RFHIKARPC07AA9

Test Model: IKARPC-07A-A9

Received Date: Apr. 21, 2016

Test Date: May 26 ~ 30, 2016

Issued Date: Jun. 14, 2016

Applicant: IEI Integration Corp.

Address: No.29, Zhongxing Rd., Xizhi Dist., New Taipei City 221, Taiwan, R.O.C.

Issued By: Bureau Veritas Consumer Products Services (H.K.) Ltd., Taoyuan Branch

Lab Address: No. 47-2, 14th Ling, Chia Pau Vil., Lin Kou Dist., New Taipei City, Taiwan (R.O.C.)



This report is for your exclusive use. Any copying or replication of this report to or for any other person or entity, or use of our name or trademark, is permitted only with our prior written permission. This report sets forth our findings solely with respect to the test samples identified herein. The results set forth in this report are not indicative or representative of the quality or characteristics of the lot from which a test sample was taken or any similar or identical product unless specifically and expressly noted. Our report includes all of the tests requested by you and the results thereof based upon the information that you provided to us. You have 60 days from date of issuance of this report to notify us of any material error or omission caused by our negligence, provided, however, that such notice shall be in writing and shall specifically address the issue you wish to raise. A failure to raise such issue within the prescribed time shall constitute your unqualified acceptance of the completeness of this report, the tests conducted and the correctness of the report contents. Unless specific mention, the uncertainty of measurement has been explicitly taken into account to declare the compliance or non-compliance to the specification. The report must not be used by the client to claim product certification, approval, or endorsement by TAF or any government agencies.

Table of Contents

Release Control Record	3
1 Certificate of Conformity	4
2 Summary of Test Results	5
2.1 Measurement Uncertainty	5
2.2 Test Site And Instruments	6
3 General Information	7
3.1 General Description of EUT	7
3.2 Configuration Of System Under Test.....	8
3.2.1 Description Of Support Units.....	9
3.3 Test Mode Applicability and Tested Channel Detail	10
3.4 EUT Operating Conditions	11
3.5 General Description of Applied Standards	11
4 Test Types and Results	12
4.1 Output Power Measurement	12
4.1.1 Limits of Output Power Measurement.....	12
4.1.2 Test Procedures.....	12
4.1.3 Test Setup.....	13
4.1.4 Test Results	14
4.2 Frequency Stability Measurement.....	17
4.2.1 Limits of Frequency Stability Measurement.....	17
4.2.2 Test Procedure	17
4.2.3 Test Setup.....	18
4.2.4 Test Results	18
4.3 Occupied Bandwidth Measurement	19
4.3.1 Test Procedure	19
4.3.2 Test Setup.....	19
4.3.3 Test Result.....	20
4.4 Band Edge Measurement	21
4.4.1 Limits of Band Edge Measurement.....	21
4.4.2 Test Setup.....	21
4.4.3 Test Procedures.....	21
4.4.4 Test Results	22
4.5 Peak To Average Ratio.....	24
4.5.1 Limits of Peak To Average Ratio Measurement	24
4.5.2 Test Setup.....	24
4.5.3 Test Procedures	24
4.5.4 Test Results	25
4.6 Conducted Spurious Emissions	26
4.6.1 Limits of Conducted Spurious Emissions Measurement.....	26
4.6.2 Test Setup.....	26
4.6.3 Test Procedure	26
4.6.4 Test Results	27
4.7 Radiated Emission Measurement	42
4.7.1 Limits of Radiated Emission Measurement.....	42
4.7.2 Test Procedure	42
4.7.3 Deviation from Test Standard	42
4.7.4 Test Setup.....	42
4.7.5 Test Results	43
5 Pictures of Test Arrangements	55
Appendix – Information on the Testing Laboratories	56

Release Control Record

Issue No.	Description	Date Issued
RF160421D16-2	Original release.	Jun. 14, 2016

1 Certificate of Conformity

Product: Panel PC
Brand: IEI
Test Model: IKARPC-07A-A9
Sample Status: Engineering sample
Applicant: IEI Integration Corp.
Test Date: May 26 ~ 30, 2016
Standards: FCC Part 24, Subpart E

The above equipment has been tested by **Bureau Veritas Consumer Products Services (H.K.) Ltd., Taoyuan Branch**, and found compliance with the requirement of the above standards. The test record, data evaluation & Equipment Under Test (EUT) configurations represented herein are true and accurate accounts of the measurements of the sample's EMC characteristics under the conditions specified in this report.

Prepared by : Annie Chang , **Date:** Jun. 14, 2016
Annie Chang / Senior Specialist

Approved by : Rex Lai , **Date:** Jun. 14, 2016
Rex Lai / Assistant Manager

2 Summary of Test Results

Applied Standard: FCC Part 24 & Part 2			
FCC Clause	Test Item	Result	Remarks
2.1046 24.232	Equivalent Isotropically radiated power	PASS	Meet the requirement of limit.
2.1046 24.232(d)	Peak To Average Ratio	PASS	Meet the requirement of limit.
2.1055 24.235	Frequency Stability	PASS	Meet the requirement of limit.
2.1049 24.238(b)	Occupied Bandwidth	PASS	Meet the requirement of limit.
24.238(b)	Band Edge Measurements	PASS	Meet the requirement of limit.
2.1051 24.238	Conducted Spurious Emissions	PASS	Meet the requirement of limit.
2.1053 24.238	Radiated Spurious Emissions	PASS	Meet the requirement of limit. Minimum passing margin is -19.15dB at 3759.93MHz.

2.1 Measurement Uncertainty

Where relevant, the following measurement uncertainty levels have been estimated for tests performed on the EUT as specified in CISPR 16-4-2:

Measurement	Expanded Uncertainty (k=2) (\pm)
Radiated Emissions up to 1 GHz	4.00 dB
Radiated Emissions above 1 GHz	3.36 dB

2.2 Test Site And Instruments

DESCRIPTION & MANUFACTURER	MODEL NO.	SERIAL NO.	CALIBRATED DATE	CALIBRATED UNTIL
HP Preamplifier	8447D	2432A03504	Feb. 26, 2016	Feb. 25, 2017
HP Preamplifier	8449B	3008A01201	Feb. 26, 2016	Feb. 25, 2017
MITEQ Preamplifier	AMF-6F-260400-33-8P	892164	Mar. 01, 2016	Feb. 28, 2017
Agilent TEST RECEIVER	N9038A	MY51210129	Feb. 02, 2016	Feb. 01, 2017
Schwarzbeck Antenna	VULB 9168	139	Jan. 04, 2016	Jan. 03, 2017
Schwarzbeck Antenna	VHBA 9123	480	May 29, 2015	May 28, 2017
Schwarzbeck Horn Antenna	BBHA-9170	212	Jan. 08, 2016	Jan. 07, 2017
Schwarzbeck Horn Antenna	BBHA 9120-D1	D130	Jan. 21, 2016	Jan. 20, 2017
ADT. Turn Table	TT100	0306	NA	NA
ADT. Tower	AT100	0306	NA	NA
Software	Radiated_V7.6.15.9.4	NA	NA	NA
SUHNER RF cable With 4dB PAD	SF104	CABLE-CH6	Aug. 15, 2015	Aug. 14, 2016
SUHNER RF cable With 3dB PAD	SF102	Cable-CH8-3.6m	Aug. 15, 2015	Aug. 14, 2016
KEYSIGHT Spectrum Analyzer	N9030A	MY54490260	Jul. 14, 2015	Jul. 13, 2016
Loop Antenna EMCI	LPA600	270	Aug. 20, 2015	Aug. 19, 2017
EMCO Horn Antenna	3115	00028257	Jan. 19, 2016	Jan. 18, 2017
Highpass filter Wainwright Instruments	WHK 3.1/18G-10SS	SN 8	NA	NA
ROHDE & SCHWARZ Spectrum Analyzer	FSV40	101042	Sep. 23, 2015	Sep. 22, 2016
Anritsu Power Sensor	MA2411B	0738404	Apr. 28, 2016	Apr. 27, 2017
Anritsu Power Meter	ML2495A	0842014	Apr. 28, 2016	Apr. 27, 2017
Temperature & Humidity Chamber	MHU-225AU	920409	May 25, 2016	May 24, 2017

- NOTE:**
1. The calibration interval of the above test instruments is 12/24 months. And the calibrations are traceable to NML/ROC and NIST/USA.
 2. The horn antenna and HP preamplifier (model: 8449B) are used only for the measurement of emission frequency above 1GHz if tested.
 3. The test was performed in Chamber No. 6.
 4. The Industry Canada Reference No. IC 7450E-6.
 5. The FCC Site Registration No. is 447212.

3 General Information

3.1 General Description of EUT

Product	Panel PC
Brand	IEi
Test Model	IKARPC-07A-A9
Status of EUT	Engineering sample
Power Supply Rating	12/24Vdc
Modulation Type	EGPRS, GPRS WCDMA, HSDPA, HSUPA
Operating Frequency	GPRS: 1850.2MHz ~ 1909.8MHz WCDMA: 1852.4MHz ~ 1907.6MHz
Max. EIRP Power	GPRS: 372.39mW (25.71dBm) WCDMA: 121.06mW (20.83dBm)
Emission Designator	GPRS: 250KG7W WCDMA: 4M10F9W
Antenna Type	External combo antenna with 0dBi gain
Antenna Connector	SMA
Accessory Device	N/A
Data Cable Supplied	I/O connector 1 cable (20-pin) I/O connector 2 cable (24-pin) Video In connector cable (8-pin)
SW version	A0-R1.1-B00-1510291641
HW version	V1.03

Note:

The above EUT information is declared by manufacturer and for more detailed features description, please refer to the manufacturer's specifications or User's Manual.

3.2 Configuration Of System Under Test

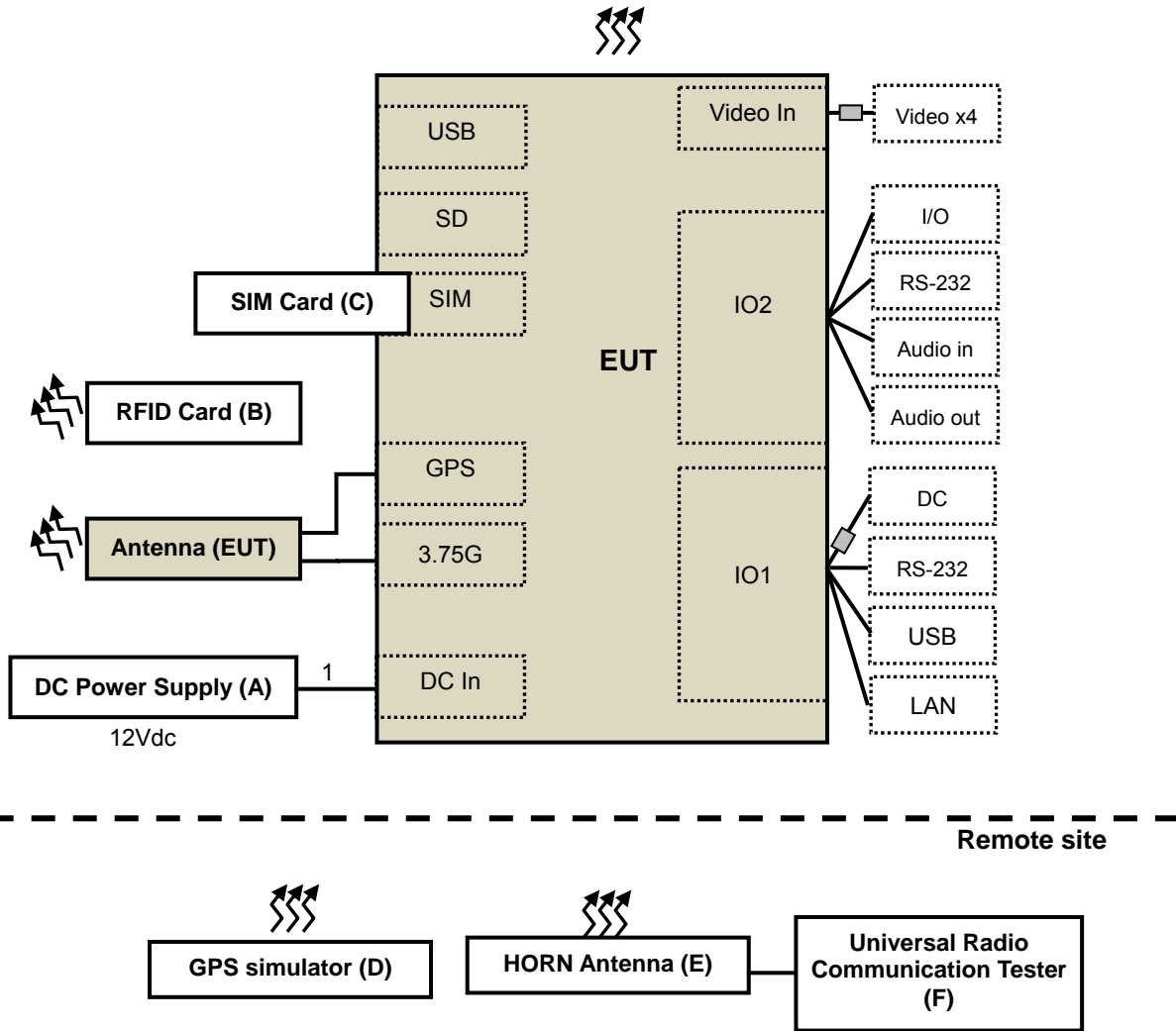

3.2.1 Description Of Support Units

The EUT has been tested as an independent unit together with other necessary accessories or support units. The following support units or accessories were used to form a representative test configuration during the tests.

ID	Product	Brand	Model No.	Serial No.	FCC ID	Remarks
A.	DC Power Supply	Topward	6303D	N/A	N/A	Provided by Lab
B.	RFID Card	N/A	N/A	N/A	N/A	Supplied by client
C.	SIM Card	N/A	N/A	N/A	N/A	Provided by Lab
D.	GPS simulator	PENDULUM	GSG-5	200447	N/A	Provided by Lab
E.	HORN Antenna	ETS	3117	00034127	N/A	Provided by Lab
F.	Radio Communication Analyzer	Anritsu	MT8820C	6201300640	N/A	Provided by Lab

Note:

1. All power cords of the above support units are non-shielded (1.8m).
2. Items D~F acted as communication partners to transfer data.

ID	Descriptions	Qty.	Length (m)	Shielding (Yes/No)	Cores (Qty.)	Remarks
1.	DC power cord	1	1.8	N	0	Provided by Lab

Note: The core(s) is(are) originally attached to the cable(s).

3.3 Test Mode Applicability and Tested Channel Detail

Pre-Scan has been conducted to determine the worst-case mode from all possible combinations between available modulations, data rates, XY axis and antenna ports

The worst case was found when positioned on X-plane. Following channel(s) was (were) selected for the final test as listed below:

GPRS MODE

EUT Configure Mode	Test Item	Available Channel	Tested Channel	Mode
-	EIRP	512 to 810	512, 661, 810	GPRS
-	Frequency Stability	512 to 810	512	GPRS
-	Occupied Bandwidth	512 to 810	512, 661, 810	GPRS, EGPRS
-	Band Edge	512 to 810	512, 810	GPRS, EGPRS
-	Peak To Average Ratio	512 to 810	512, 661, 810	GPRS, EGPRS
-	Condcudeted Emission	512 to 810	512, 661, 810	GPRS, EGPRS
-	Radiated Emission Below 1GHz	512 to 810	512, 661, 810	GPRS
-	Radiated Emission Above 1GHz	512 to 810	512, 661, 810	GPRS

WCDMA MODE

EUT Configure Mode	Test Item	Available Channel	Tested Channel	Mode
-	EIRP	9262 to 9538	9262, 9400, 9538	WCDMA
-	Frequency Stability	9262 to 9538	9262	WCDMA
-	Occupied Bandwidth	9262 to 9538	9262, 9400, 9538	WCDMA, HSDPA, HSUPA
-	Band Edge	9262 to 9538	9262, 9538	WCDMA, HSDPA, HSUPA
-	Peak To Average Ratio	9262 to 9538	9262, 9400, 9538	WCDMA, HSDPA, HSUPA
-	Condcudeted Emission	9262 to 9538	9262, 9400, 9538	WCDMA
-	Radiated Emission Below 1GHz	9262 to 9538	9262, 9400, 9538	WCDMA
-	Radiated Emission Above 1GHz	9262 to 9538	9262, 9400, 9538	WCDMA

Test Condition:

Test Item	Environmental Conditions	Input Power	Tested By
EIRP	27deg. C, 63%RH	12Vdc	Aaron You
Frequency Stability	25deg. C, 60%RH	12Vdc	Aaron You
Occupied Bandwidth	25deg. C, 60%RH	12Vdc	Aaron You
Band Edge	25deg. C, 60%RH	12Vdc	Aaron You
Peak To Average Ratio	25deg. C, 60%RH	12Vdc	Aaron You
Condcudeted Emission	25deg. C, 60%RH	12Vdc	Aaron You
Radiated Emission	26deg. C, 67%RH	12Vdc	Aaron You

3.4 EUT Operating Conditions

The EUT makes a call to the communication simulator. The communication simulator station system controlled a EUT to export maximum output power under transmission mode and specific channel frequency.

3.5 General Description of Applied Standards

The EUT is a RF Product. According to the specifications of the manufacturer, it must comply with the requirements of the following standards:

FCC 47 CFR Part 2

FCC 47 CFR Part 24

KDB 971168 D01 Power Meas License Digital Systems v02r02

ANSI/TIA/EIA-603-D 2010

NOTE: All test items have been performed and recorded as per the above standards.

4 Test Types and Results

4.1 Output Power Measurement

4.1.1 Limits of Output Power Measurement

Mobile / Portable station are limited to 2 watts e.i.r.p.

4.1.2 Test Procedures

EIRP / ERP Measurement:

- a. All measurements were done at low, middle and high operational frequency range. RBW and VBW is 1MHz for GPRS and 5MHz for WCDMA mode.
- b. Substitution method is used for E.I.R.P measurement. In the semi-anechoic chamber, EUT placed on the 0.8m height of Turn Table, rotated the table around 360 degrees to search the maximum radiation power and receiver antenna shall be rotated vertical and horizontal polarization and moved height from 1m to 4m to find the maximum polar radiated power. The "Read Value" is the spectrum reading the maximum power value.
- c. The substitution horn antenna is substituted for EUT at the same position and signals generator export the CW signal to the substitution antenna via a tx cable. Rotated the Turn Table and moved receiving antenna to find the maximum radiation power. Adjust output power level of S.G to get a Value of spectrum reading equal to "Read Value" of step b. Record the power level of S.G
- d. $EIRP = \text{Output power level of S.G} - \text{TX cable loss} + \text{Antenna gain of substitution horn}$. E.R.P power can be calculated form E.I.R.P power by subtracting the gain of dipole, $E.R.P \text{ power} = E.I.P.R \text{ power} - 2.15\text{dBi}$.

Conducted Power Measurement:

The EUT was set up for the maximum power with GPRS & WCDMA link data modulation and link up with simulator. Set the EUT to transmit under low, middle and high channel and record the power level shown on simulator.

4.1.3 Test Setup

EIRP / ERP MEASUREMENT:

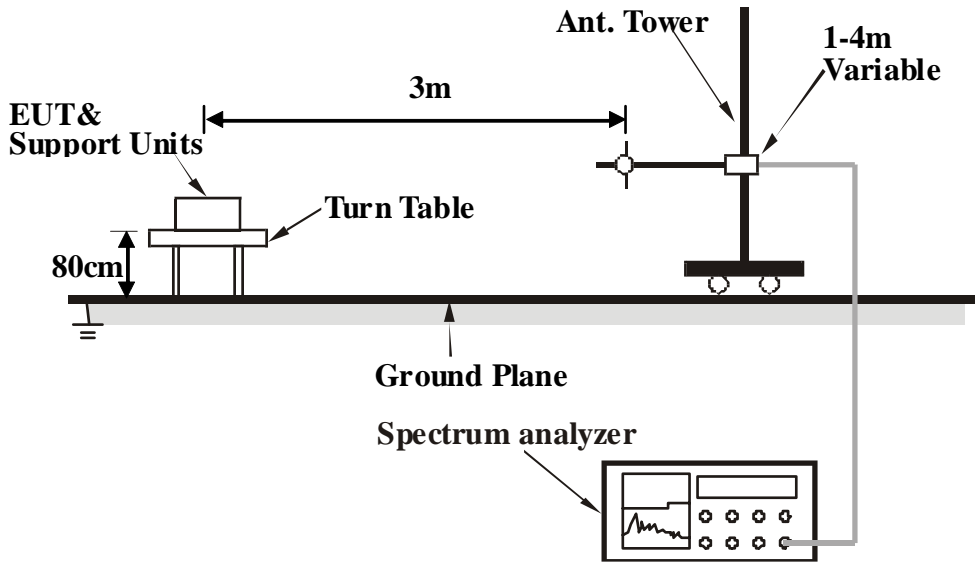

For the actual test configuration, please refer to the attached file (Test Setup Photo).

CONDUCTED POWER MEASUREMENT:



For the actual test configuration, please refer to the attached file (Test Setup Photo).

4.1.4 Test Results

CONDUCTED OUTPUT POWER (dBm)

Band	GPRS1900		
Channel	512	661	810
Frequency (MHz)	1850.2	1880.0	1909.8
GPRS 8	28.23	28.19	28.25
EGPRS 8 (MCS1)	28.06	28.06	27.71
EGPRS 8 (MCS9)	26.91	26.75	26.34

Band	WCDMA Band II		
Channel	9262	9400	9538
Frequency (MHz)	1852.4	1880.0	1907.6
RMC 12.2K	22.48	22.36	22.55
HSDPA Subtest-1	22.23	22.28	22.3
HSDPA Subtest-2	22.25	22.27	22.31
HSDPA Subtest-3	22.27	22.31	22.33
HSDPA Subtest-4	22.2	22.22	22.3
HSUPA Subtest-1	22.19	22.18	22.29
HSUPA Subtest-2	22.22	22.25	22.28
HSUPA Subtest-3	22.26	22.3	22.36
HSUPA Subtest-4	22.23	22.25	22.31
HSUPA Subtest-5	22.25	22.11	22.27

EIRP Power (dBm)

For GPRS Mode:

MODE		TX channel 512					
Antenna Polarity & Test Distance: Horizontal at 3 M							
No.	Freq. (MHz)	Reading (dBm)	S.G Power Value (dBm)	Correction Factor (dB)	EIRP (dBm)	Limit (dBm)	Margin (dB)
1	1850.20	22.10	12.33	12.01	24.34	33.00	-8.66
Antenna Polarity & Test Distance: Vertical at 3 M							
No.	Freq. (MHz)	Reading (dBm)	S.G Power Value (dBm)	Correction Factor (dB)	EIRP (dBm)	Limit (dBm)	Margin (dB)
1	1850.20	17.35	7.23	12.01	19.24	33.00	-13.76

MODE		TX channel 661					
Antenna Polarity & Test Distance: Horizontal at 3 M							
No.	Freq. (MHz)	Reading (dBm)	S.G Power Value (dBm)	Correction Factor (dB)	EIRP (dBm)	Limit (dBm)	Margin (dB)
1	1880.00	23.19	13.71	12.00	25.71	33.00	-7.29
Antenna Polarity & Test Distance: Vertical at 3 M							
No.	Freq. (MHz)	Reading (dBm)	S.G Power Value (dBm)	Correction Factor (dB)	EIRP (dBm)	Limit (dBm)	Margin (dB)
1	1880.00	18.13	8.07	12.00	20.07	33.00	-12.93

MODE		TX channel 810					
Antenna Polarity & Test Distance: Horizontal at 3 M							
No.	Freq. (MHz)	Reading (dBm)	S.G Power Value (dBm)	Correction Factor (dB)	EIRP (dBm)	Limit (dBm)	Margin (dB)
1	1909.80	22.40	13.02	11.99	25.01	33.00	-7.99
Antenna Polarity & Test Distance: Vertical at 3 M							
No.	Freq. (MHz)	Reading (dBm)	S.G Power Value (dBm)	Correction Factor (dB)	EIRP (dBm)	Limit (dBm)	Margin (dB)
1	1909.80	17.54	7.57	11.99	19.56	33.00	-13.44

NOTE: EIRP (dBm) = S.G Power Value (dBm) + Correction Factor (dB).

For WCDMA Mode:

MODE		TX channel 9262					
Antenna Polarity & Test Distance: Horizontal at 3 M							
No.	Freq. (MHz)	Reading (dBm)	S.G Power Value (dBm)	Correction Factor (dB)	EIRP (dBm)	Limit (dBm)	Margin (dB)
1	1852.40	18.22	8.48	12.00	20.48	33.00	-12.52
Antenna Polarity & Test Distance: Vertical at 3 M							
No.	Freq. (MHz)	Reading (dBm)	S.G Power Value (dBm)	Correction Factor (dB)	EIRP (dBm)	Limit (dBm)	Margin (dB)
1	1852.40	15.42	5.31	12.00	17.31	33.00	-15.69

MODE		TX channel 9400					
Antenna Polarity & Test Distance: Horizontal at 3 M							
No.	Freq. (MHz)	Reading (dBm)	S.G Power Value (dBm)	Correction Factor (dB)	EIRP (dBm)	Limit (dBm)	Margin (dB)
1	1880.00	18.31	8.83	12.00	20.83	33.00	-12.17
Antenna Polarity & Test Distance: Vertical at 3 M							
No.	Freq. (MHz)	Reading (dBm)	S.G Power Value (dBm)	Correction Factor (dB)	EIRP (dBm)	Limit (dBm)	Margin (dB)
1	1880.00	15.99	5.93	12.00	17.93	33.00	-15.07

MODE		TX channel 9538					
Antenna Polarity & Test Distance: Horizontal at 3 M							
No.	Freq. (MHz)	Reading (dBm)	S.G Power Value (dBm)	Correction Factor (dB)	EIRP (dBm)	Limit (dBm)	Margin (dB)
1	1907.60	18.06	8.70	11.99	20.69	33.00	-12.31
Antenna Polarity & Test Distance: Vertical at 3 M							
No.	Freq. (MHz)	Reading (dBm)	S.G Power Value (dBm)	Correction Factor (dB)	EIRP (dBm)	Limit (dBm)	Margin (dB)
1	1907.60	16.38	6.40	11.99	18.39	33.00	-14.61

NOTE: EIRP (dBm) = S.G Power Value (dBm) + Correction Factor (dB).

4.2 Frequency Stability Measurement

4.2.1 Limits of Frequency Stability Measurement

The frequency stability shall be sufficient to ensure that the fundamental emission stays within the authorized frequency block.

4.2.2 Test Procedure

- a. Device is placed at the oven room. The oven room could control the temperatures and humidity. Power warm up is at least 15 min and power applied should perform before recording frequency error.
- b. EUT is connected the external power supply to control the DC input power. The test voltage range is from minimum to maximum working voltage. Each step shall be record the frequency error rate.
- c. The temperature range step is 10 degrees in this test items. All temperature levels shall be hold the ± 0.5 °C during the measurement testing. The each temperature step shall be at least 0.5 hours, consider the EUT could be test under the stability condition.

NOTE: The frequency error was recorded frequency error from the communication simulator.

4.2.3 Test Setup

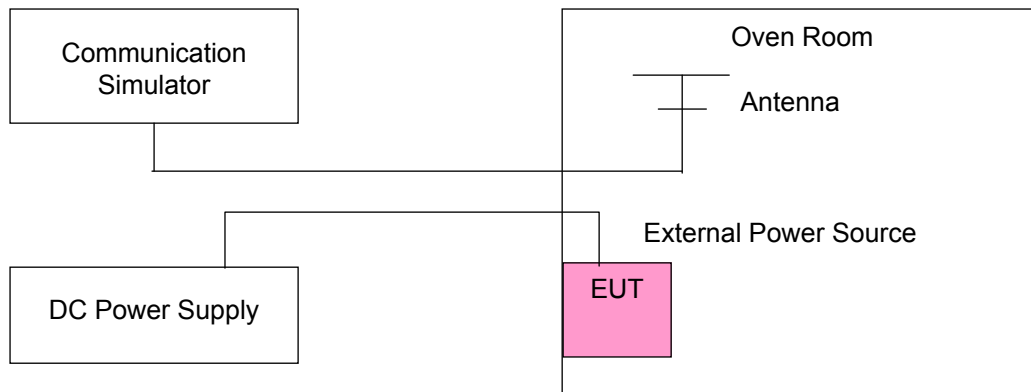

4.2.4 Test Results

Frequency Error vs. Voltage

Voltage (Volts)	Frequency Error (ppm)		Limit (ppm)
	GPRS	WCDMA	
126.5	0.0070262674	0.0086374433	2.5
120.0	0.0081072317	0.0080976031	2.5
93.5	0.0086477138	0.0075577629	2.5

NOTE: The applicant defined the normal working voltage of the battery is from 93.5Vac to 126.5Vac.

Frequency Error vs. Temperature.

TEMP. (°C)	Frequency Error (ppm)		Limit (ppm)
	GPRS	WCDMA	
60	0.0081072317	0.0086374433	2.5
50	0.0075667495	0.0080976031	2.5
40	0.0064857853	0.0080976031	2.5
30	0.0081072317	0.0070179227	2.5
20	0.0070262674	0.0064780825	2.5
10	0.0075667495	0.0064780825	2.5
0	0.0070262674	0.0053984021	2.5
-10	0.0064857853	0.0048585619	2.5
-20	0.0064857853	0.0048585619	2.5

4.3 Occupied Bandwidth Measurement

4.3.1 Test Procedure

The EUT makes a call to the communication simulator. All measurements were done at low, middle and high operational frequency range. The communication simulator station system controlled a EUT to export maximum output power under transmission mode and specific channel frequency. Use OBW measurement function of Spectrum analyzer to measure 99 % occupied bandwidth.

4.3.2 Test Setup

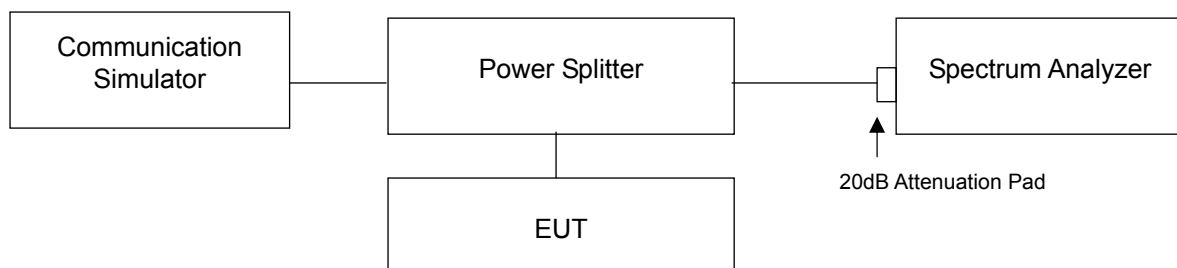

4.3.3 Test Result

Channel	Frequency (MHz)	99% Occupied Bandwidth (kHz)		Channel	FREQ. (MHz)	99% Occupied Bandwidth (MHz)		
		GPRS	EGPRS			WCDMA	HSDPA	HSUPA
512	1850.2	250	240	9262	1852.4	4.06	4.08	4.10
661	1880.0	248	248	9400	1880.0	4.10	4.10	4.08
810	1909.8	250	242	9538	1907.6	4.08	4.08	4.08

Spectrum Plot Of Worst Value

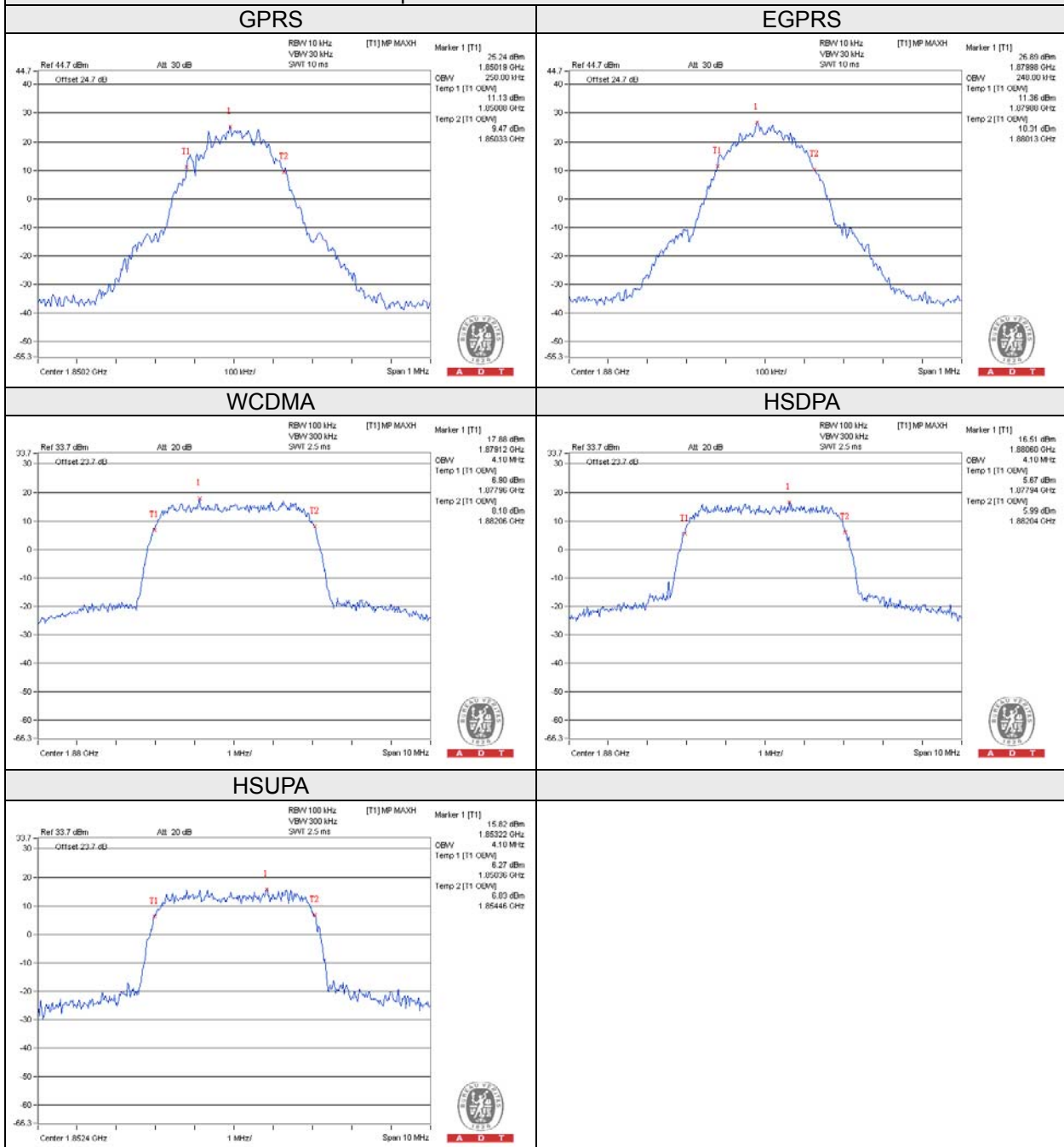

4.4 Band Edge Measurement

4.4.1 Limits of Band Edge Measurement

Power of any emission outside of the authorized operating frequency ranges must be attenuated below the transmitting power (P) by a factor of at least $43 + 10 \log(P)$ dB. In the 1 MHz bands immediately outside and adjacent to the frequency block a resolution bandwidth of at least one percent of the emission bandwidth of the fundamental emission of the transmitter may be employed.

4.4.2 Test Setup

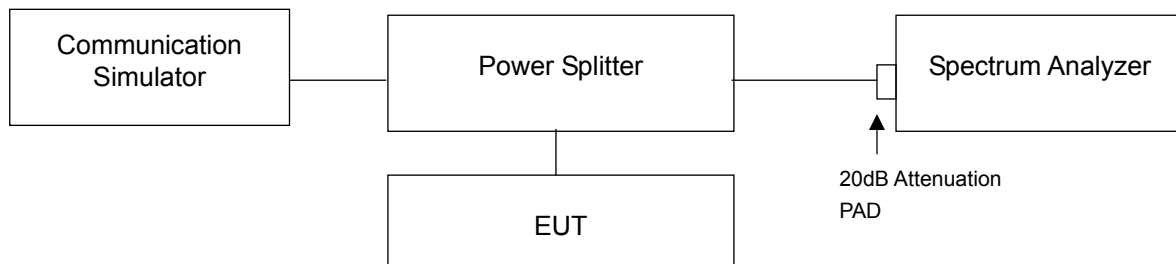

4.4.3 Test Procedures

- All measurements were done at low and high operational frequency range.
- The center frequency of spectrum is the band edge frequency and span is 1.5MHz. RB of the spectrum is 3kHz and VB of the spectrum is 10kHz (GPRS/EGPRS).
- The center frequency of spectrum is the band edge frequency and span is 10MHz. RB of the spectrum is 100kHz and VB of the spectrum is 300kHz (WCDMA/HSDPA/HSUPA).
- Record the max trace plot into the test report.



BUREAU
VERITAS

4.4.4 Test Results

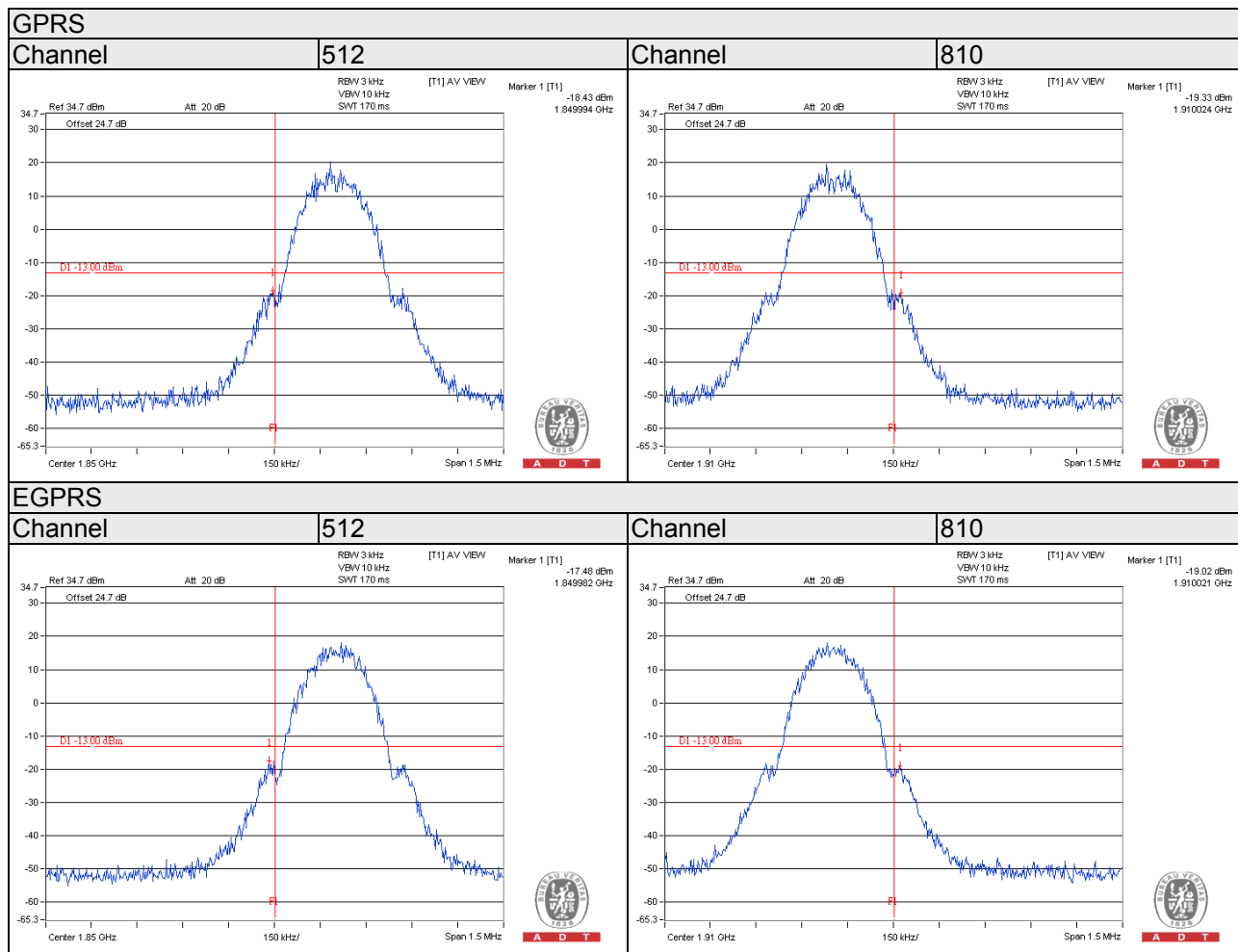



WCDMA

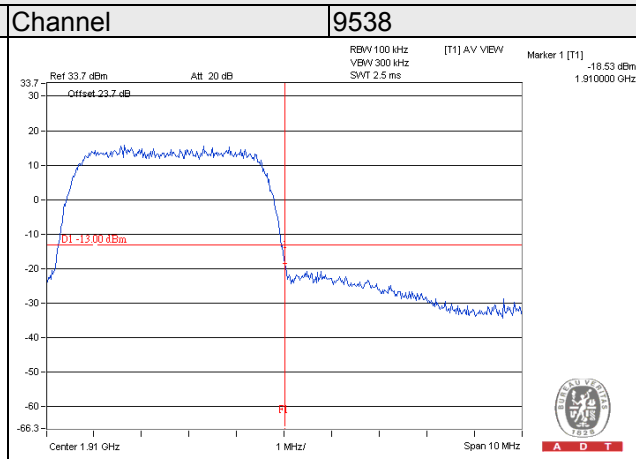
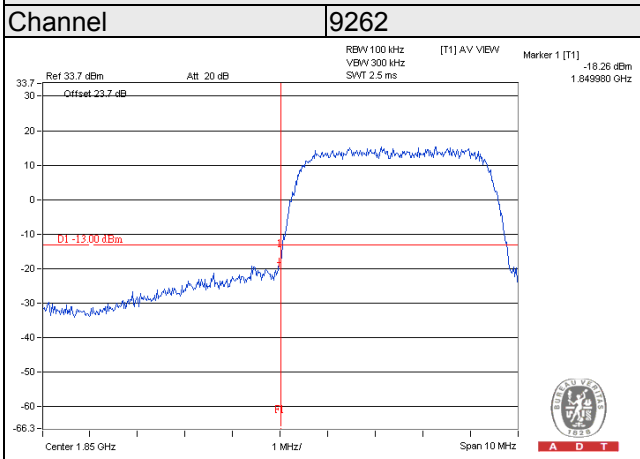

HSDPA

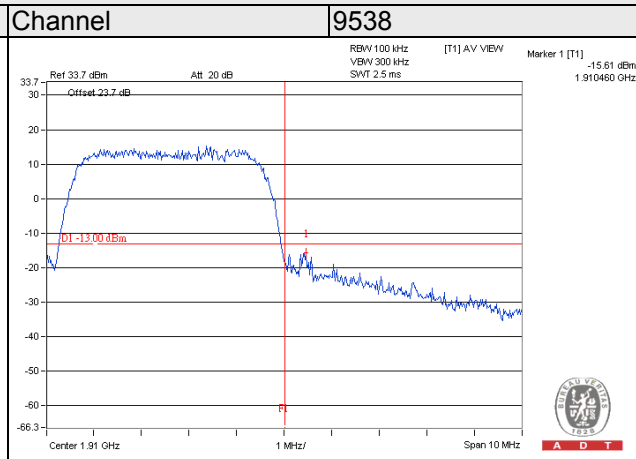
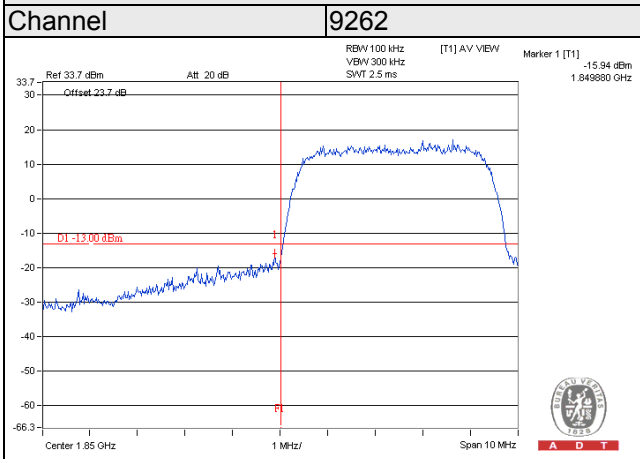

HSUPA

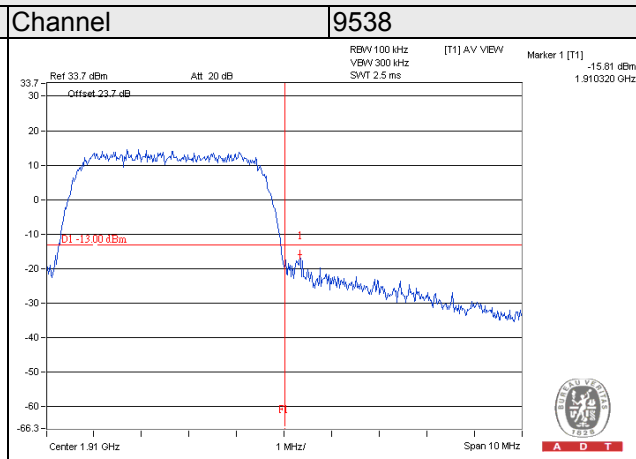
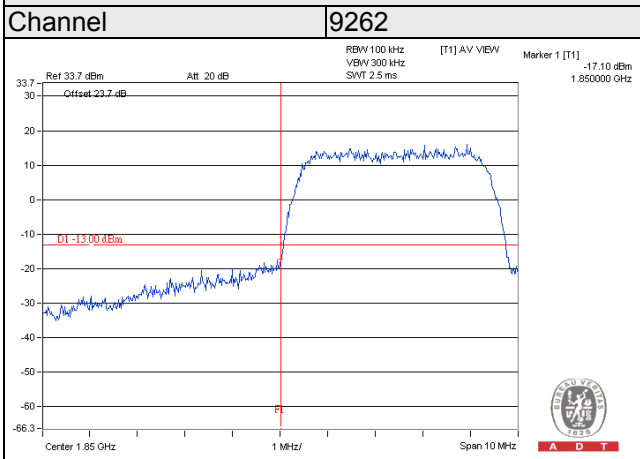

4.5 Peak To Average Ratio

4.5.1 Limits of Peak To Average Ratio Measurement

In measuring transmissions in this band using an average power technique, the peak to-average ratio (PAR) of the transmission may not exceed 13 dB

4.5.2 Test Setup

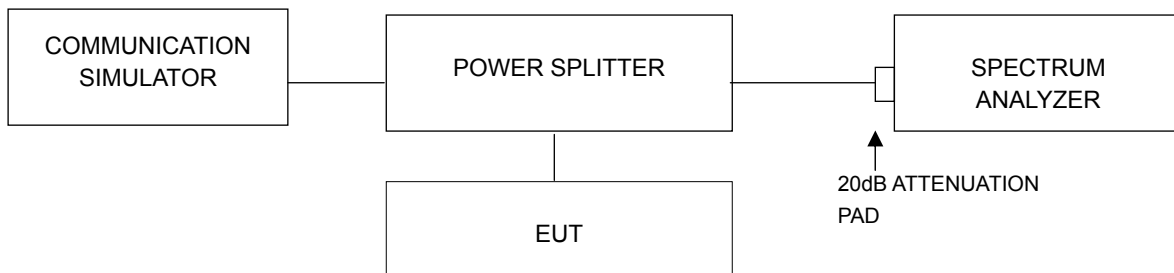

4.5.3 Test Procedures

1. Set resolution/measurement bandwidth \geq signal's occupied bandwidth;
2. Set the number of counts to a value that stabilizes the measured CCDF curve;
3. Record the maximum PAPR level associated with a probability of 0.1%.

4.5.4 Test Results

Channel	Frequency (MHz)	Peak To Average Ratio (dB)		Channel	Freq. (MHz)	Peak To Average Ratio (dB)		
		GPRS	EGPRS			WCDMA	HSDPA	HSUPA
512	1850.2	5.46	5.80	9262	1852.4	2.79	2.81	2.79
661	1880.0	5.11	6.75	9400	1880.0	2.79	2.76	2.78
810	1909.8	5.09	5.07	9538	1907.6	2.77	2.77	2.78

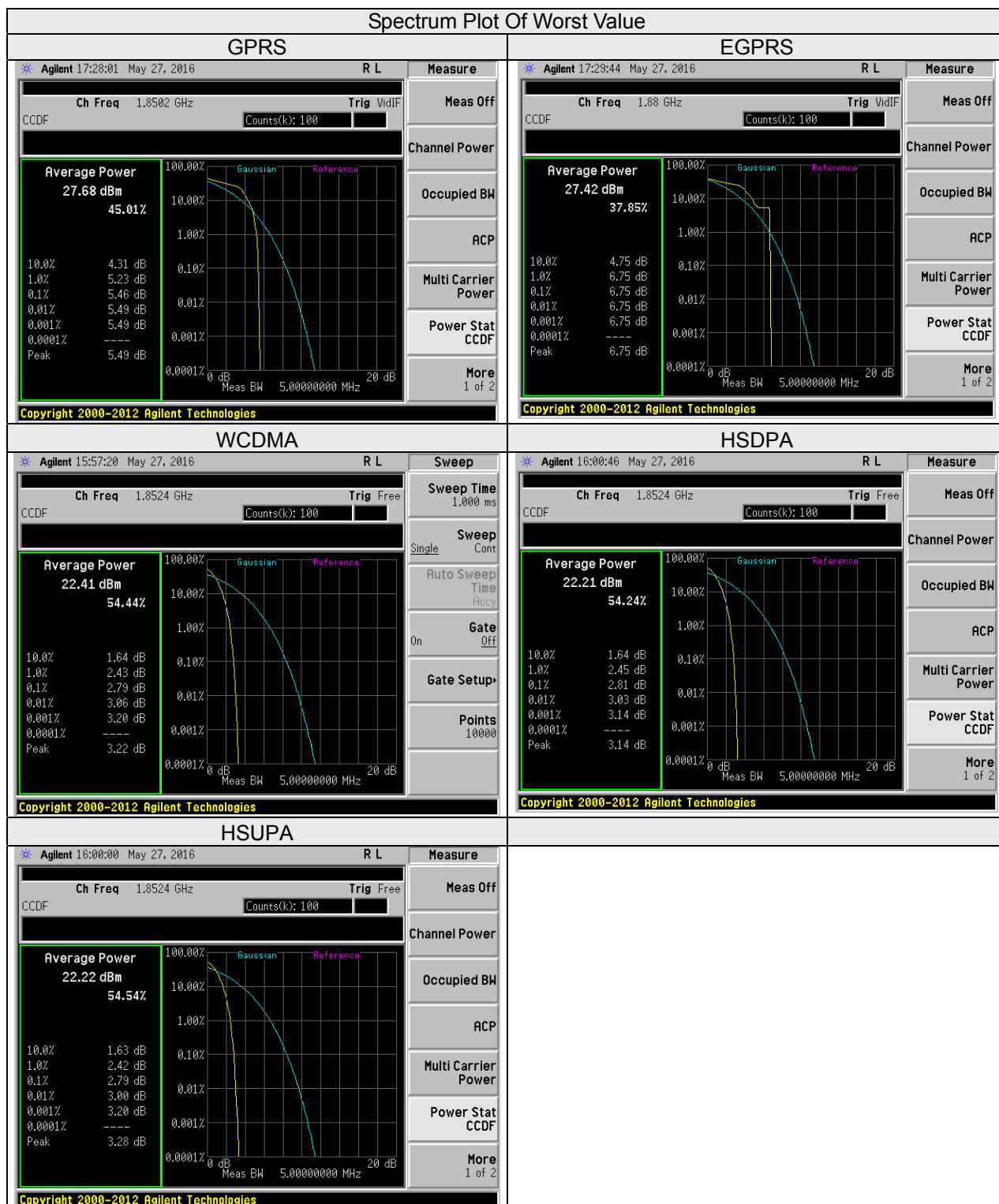

4.6 Conducted Spurious Emissions

4.6.1 Limits of Conducted Spurious Emissions Measurement

The power of any emission outside of the authorized operating frequency ranges must be attenuated below the transmitting power (P) by a factor of at least $43 + 10 \log(P)$ dB. The emission limit equal to -13dBm .

4.6.2 Test Setup

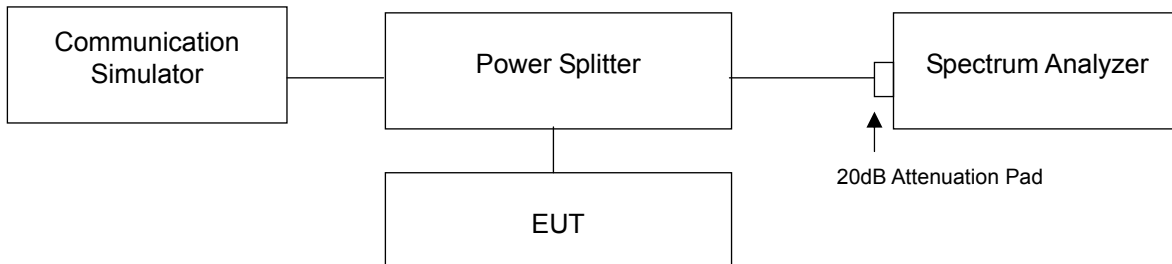

4.6.3 Test Procedure

- a. The EUT makes a phone call to the communication simulator. All measurements were done at low, middle and high operational frequency range.
- b. Measuring frequency range is from 9 kHz to 9GHz. 20dB attenuation pad is connected with spectrum. RBW=1MHz and VBW=3MHz is used for conducted emission measurement.

4.6.4 Test Results

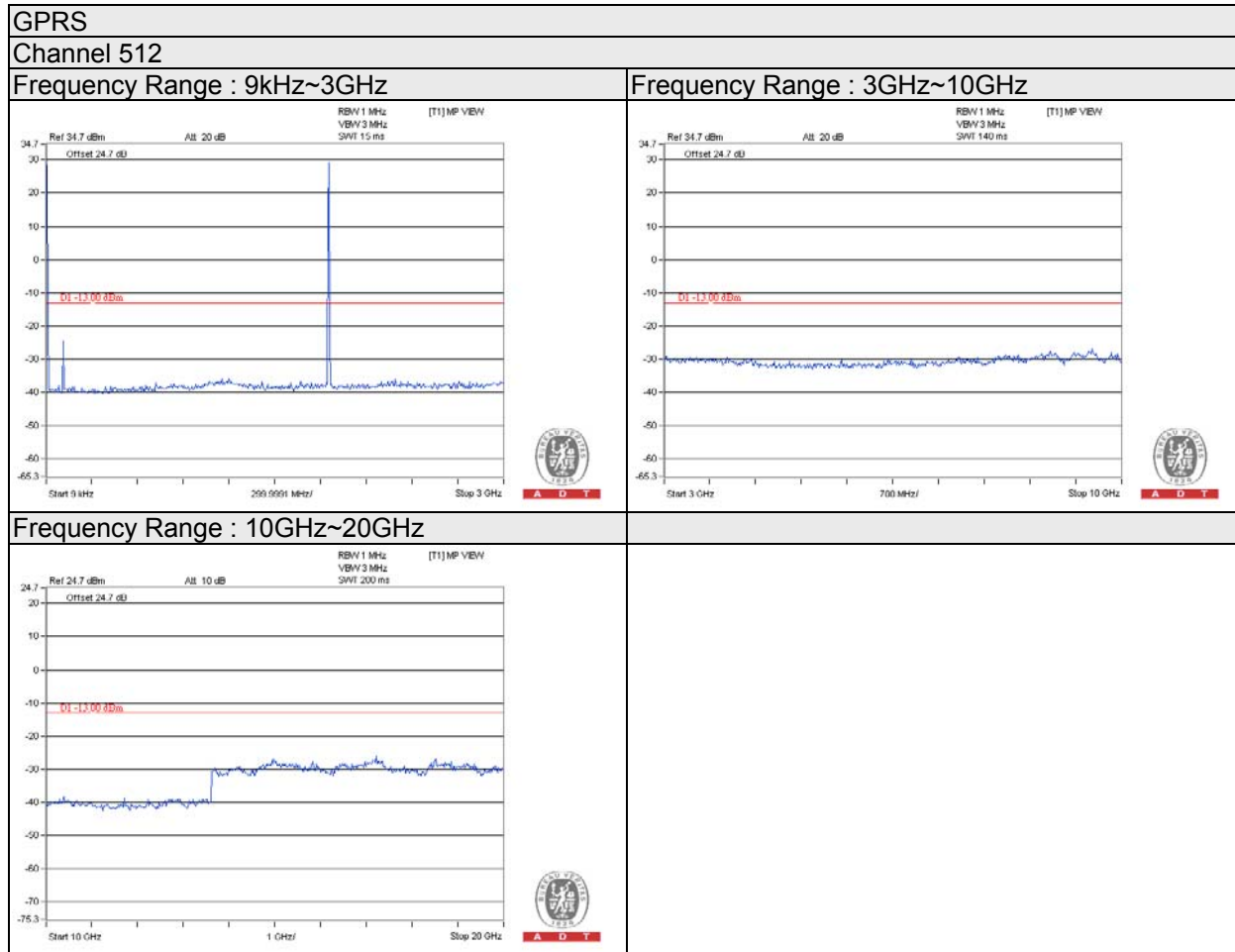

GPRS

Channel 661

Frequency Range : 9kHz~3GHz

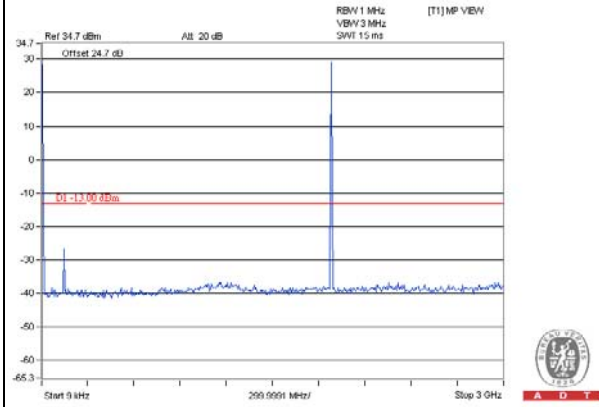

Frequency Range : 3GHz~10GHz

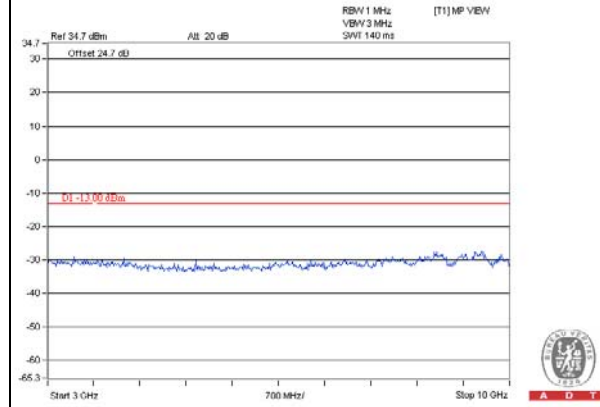

Frequency Range : 10GHz~20GHz

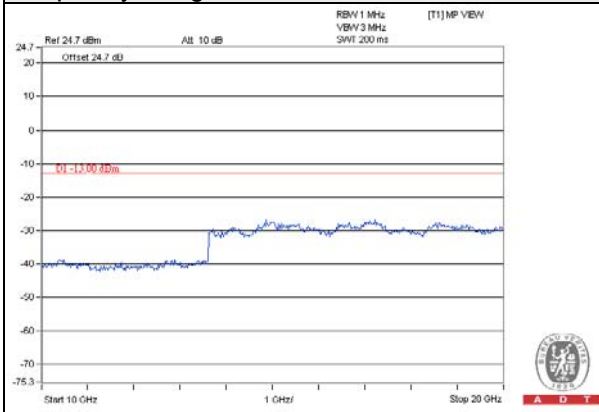

GPRS

Channel 810

Frequency Range : 9kHz~3GHz

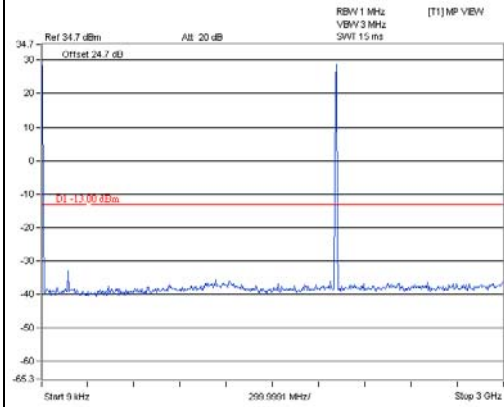

Frequency Range : 3GHz~10GHz

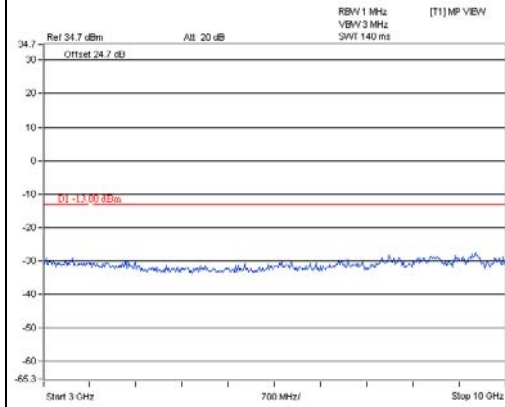

Frequency Range : 10GHz~20GHz

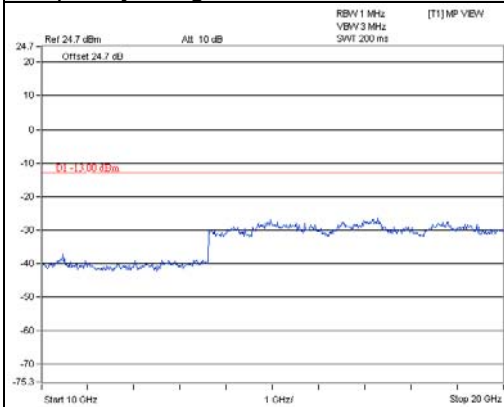

EGPRS

Channel 512

Frequency Range : 9kHz~3GHz

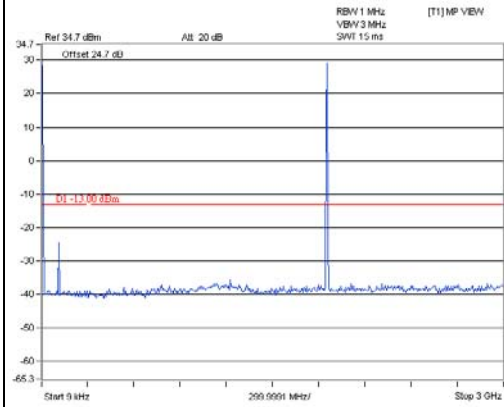

Frequency Range : 3GHz~10GHz

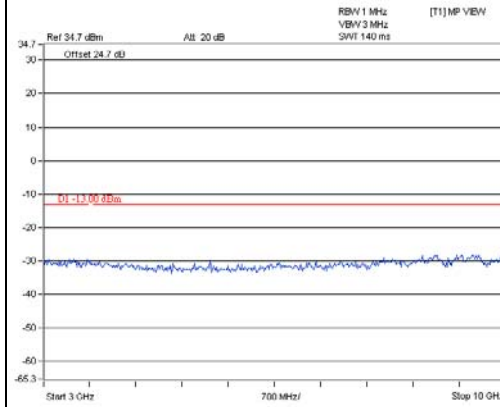

Frequency Range : 10GHz~20GHz

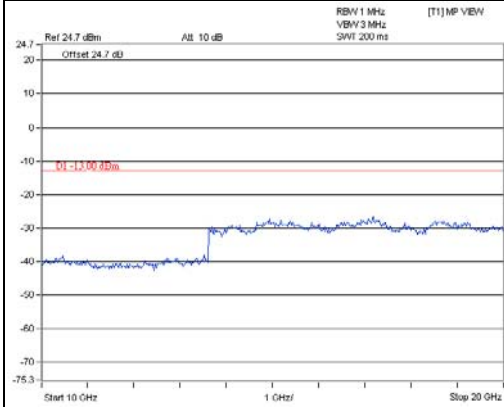

EGPRS

Channel 661

Frequency Range : 9kHz~3GHz

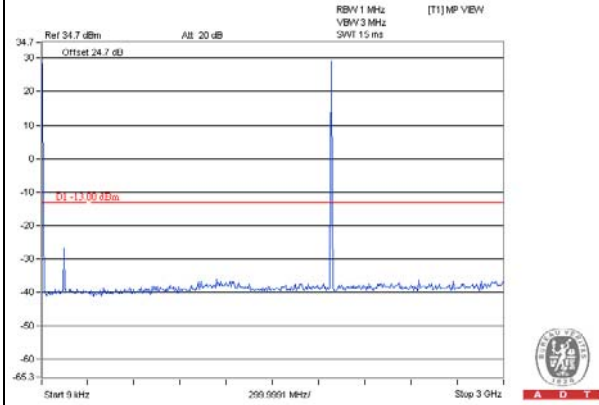

Frequency Range : 3GHz~10GHz

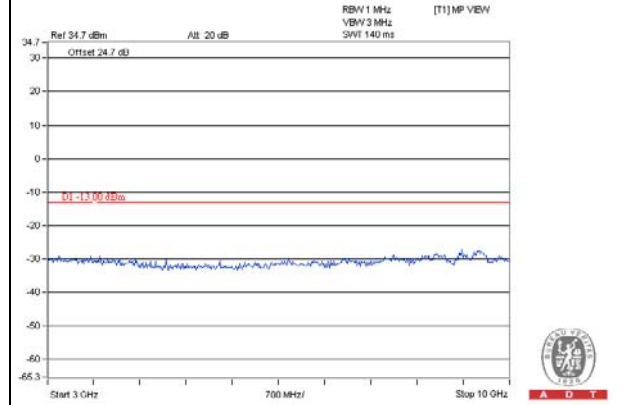

Frequency Range : 10GHz~20GHz

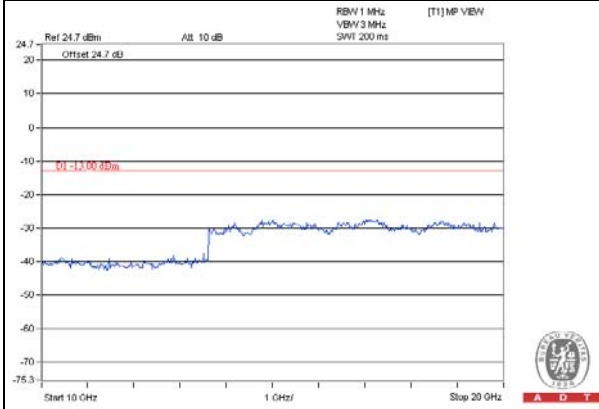

EGPRS

Channel 810

Frequency Range : 9kHz~3GHz

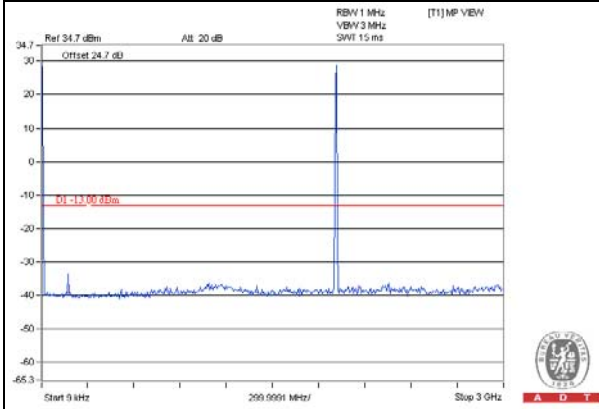

Frequency Range : 3GHz~10GHz

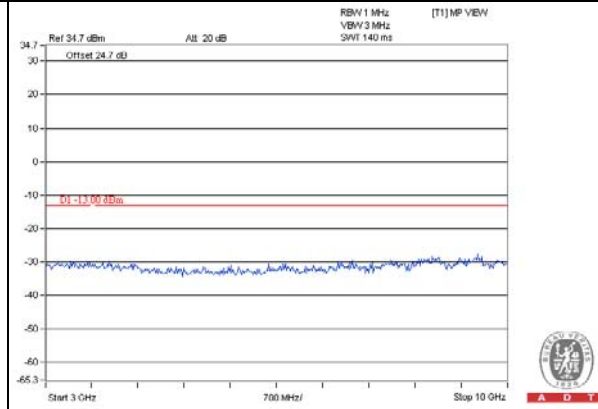

Frequency Range : 10GHz~20GHz

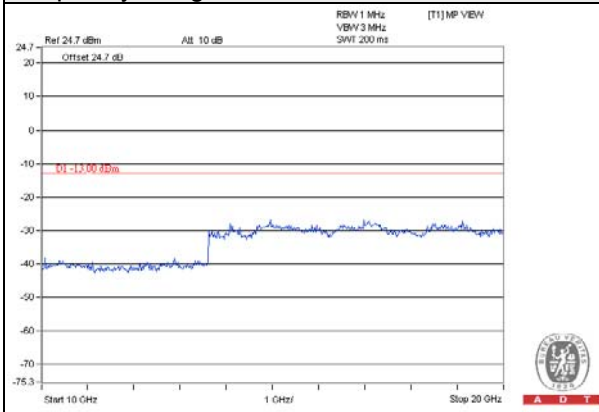

WCDMA

Channel 9262

Frequency Range : 9kHz~3GHz

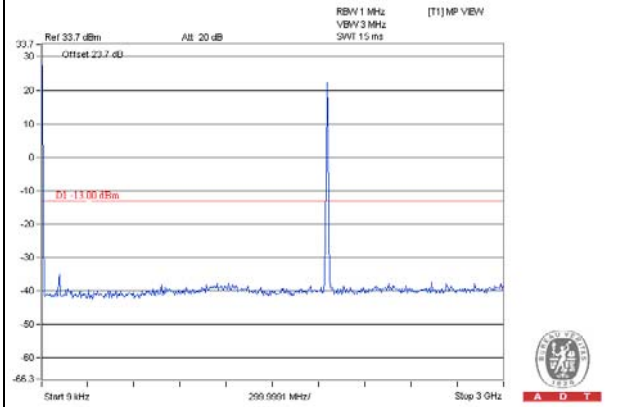

Frequency Range : 3GHz~10GHz

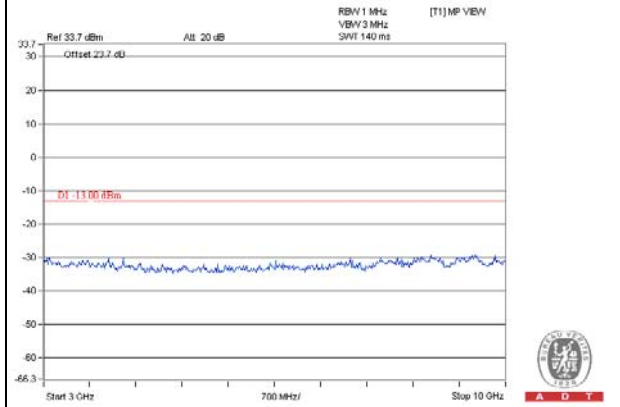

Frequency Range : 10GHz~20GHz

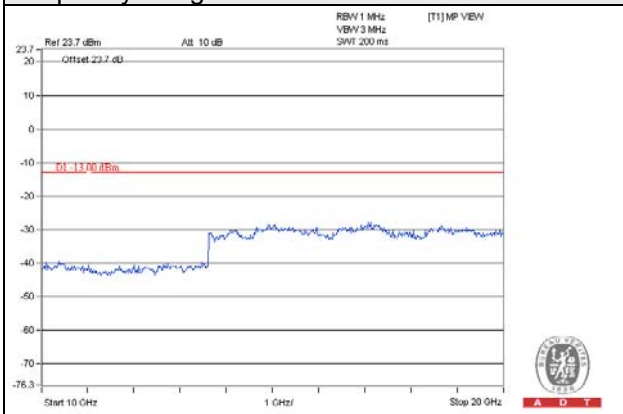

WCDMA

Channel 9400

Frequency Range : 9kHz~3GHz

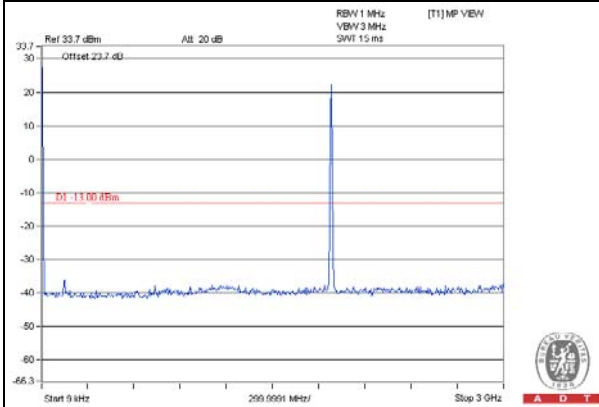

Frequency Range : 3GHz~10GHz

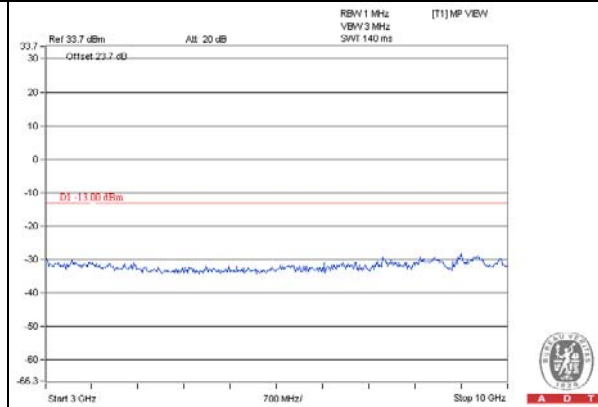

Frequency Range : 10GHz~20GHz

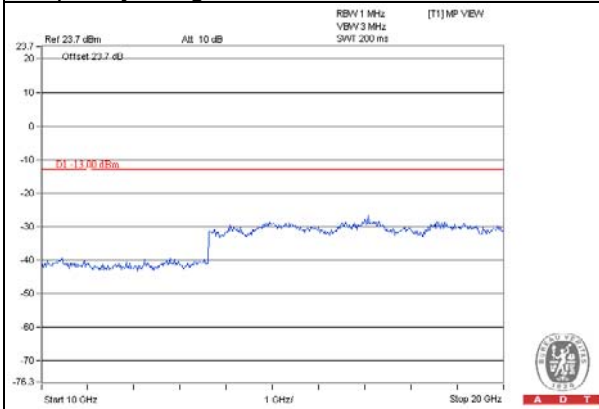

WCDMA

Channel 9538

Frequency Range : 9kHz~3GHz

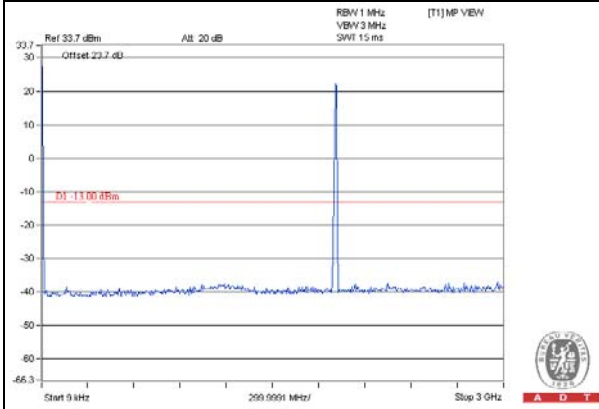

Frequency Range : 3GHz~10GHz

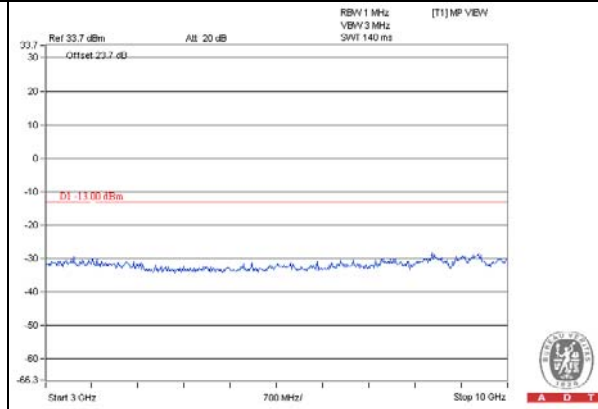

Frequency Range : 10GHz~20GHz

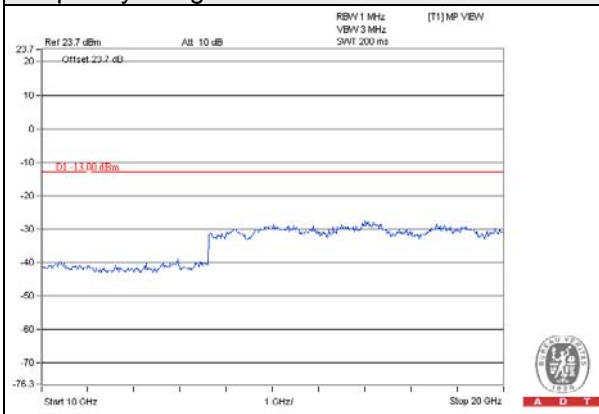

HSDPA

Channel 9262

Frequency Range : 9kHz~3GHz

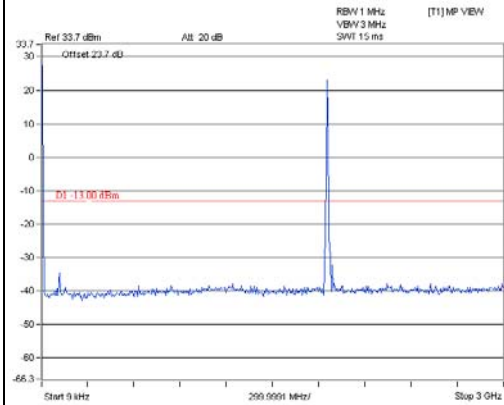

Frequency Range : 3GHz~10GHz

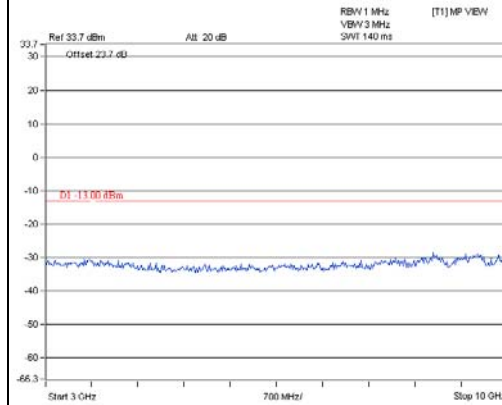

Frequency Range : 10GHz~20GHz



HSDPA

Channel 9400

Frequency Range : 9kHz~3GHz

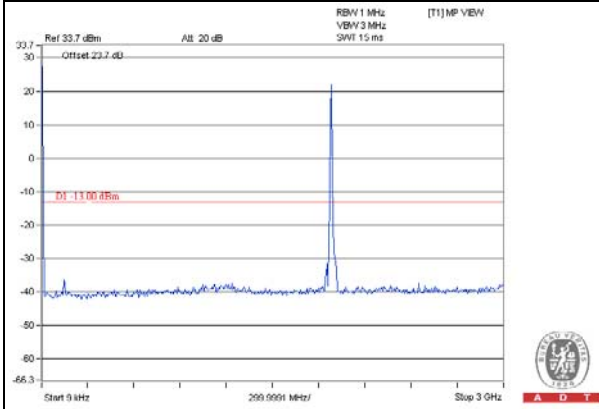

Frequency Range : 3GHz~10GHz

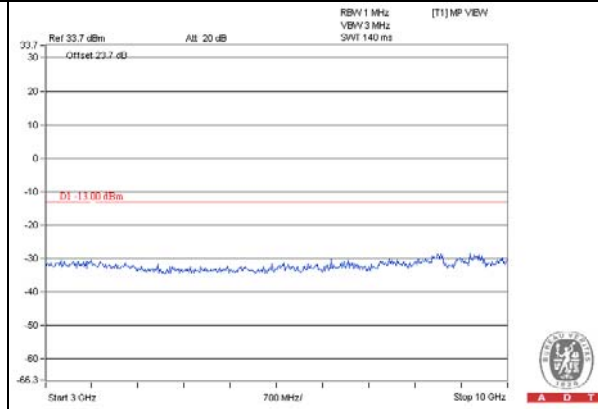

Frequency Range : 10GHz~20GHz

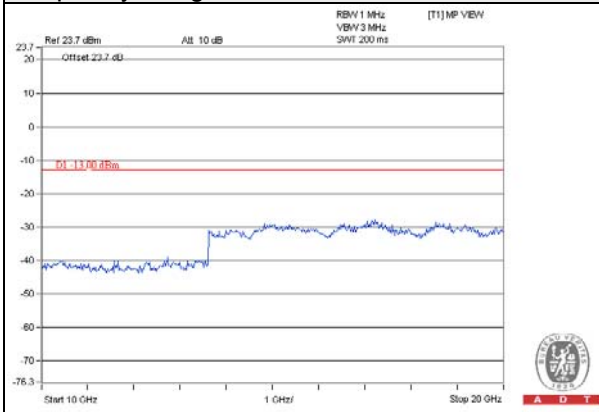

HSDPA

Channel 9538

Frequency Range : 9kHz~3GHz

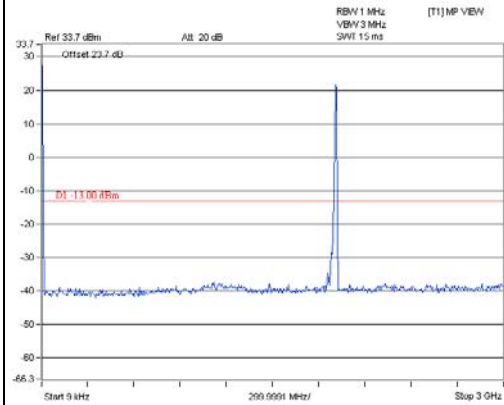

Frequency Range : 3GHz~10GHz

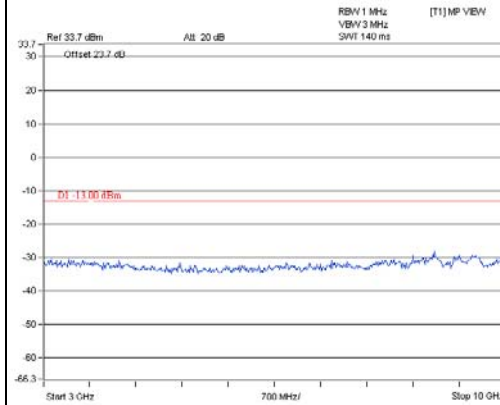

Frequency Range : 10GHz~20GHz



HSUPA

Channel 9262

Frequency Range : 9kHz~3GHz

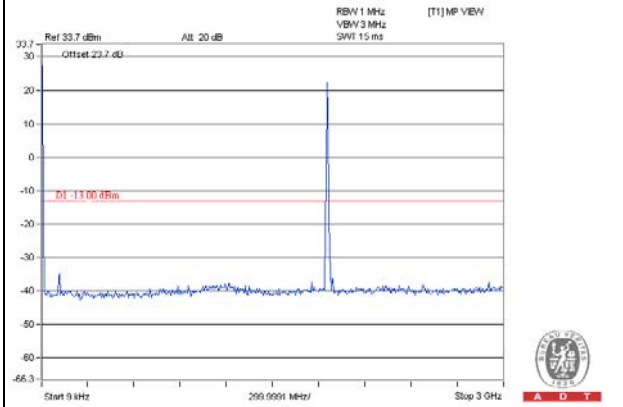

Frequency Range : 3GHz~10GHz

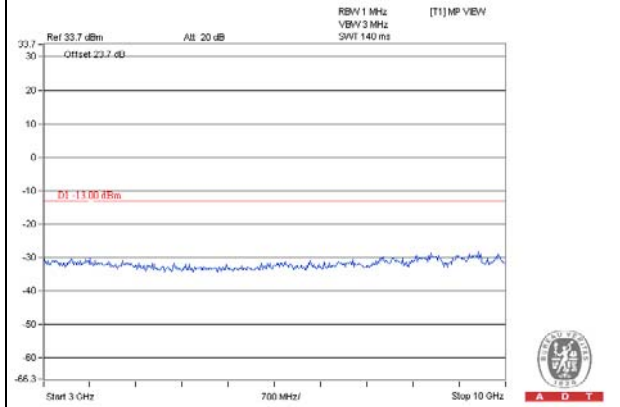

Frequency Range : 10GHz~20GHz

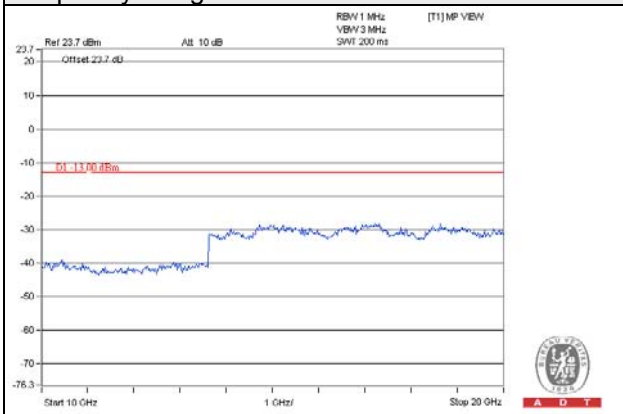

HSUPA

Channel 9400

Frequency Range : 9kHz~3GHz

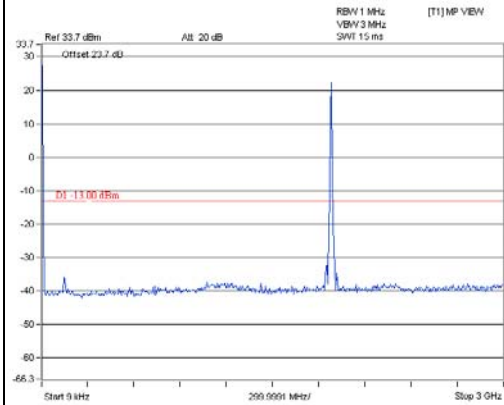

Frequency Range : 3GHz~10GHz

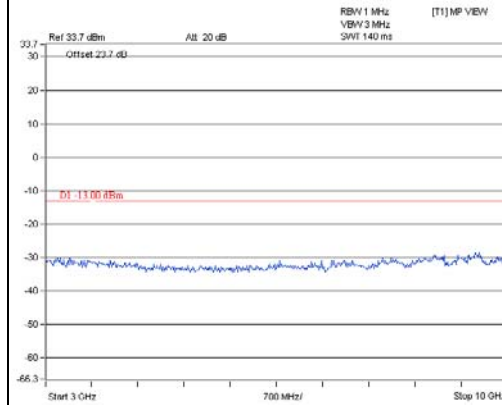

Frequency Range : 10GHz~20GHz



HSUPA

Channel 9538

Frequency Range : 9kHz~3GHz

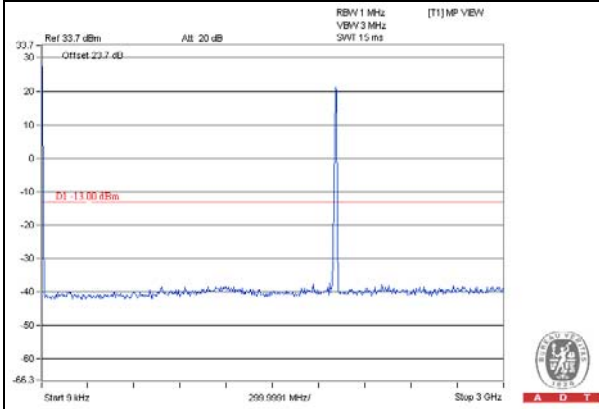

Frequency Range : 3GHz~10GHz

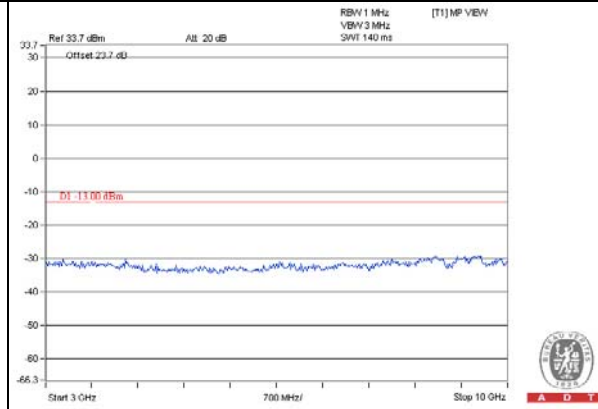

Frequency Range : 10GHz~20GHz

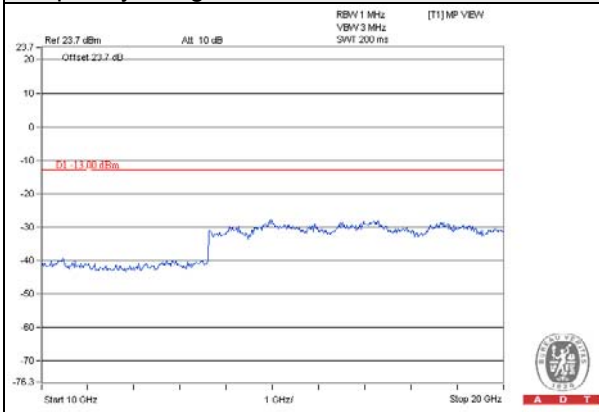

4.7 Radiated Emission Measurement

4.7.1 Limits of Radiated Emission Measurement

The power of any emission outside of the authorized operating frequency ranges must be attenuated below the transmitting power (P) by a factor of at least $43 + 10 \log(P)$ dB. The emission limit equal to -13dBm .

4.7.2 Test Procedure

- Substitution method is used for E.I.R.P measurement. In the semi-anechoic chamber, EUT placed on the 0.8m height of Turn Table, rotated the table around 360 degrees to search the maximum radiation power and receiver antenna shall be rotated vertical and horizontal polarization and moved height from 1m to 4m to find the maximum polar radiated power. The "Read Value" is the spectrum reading the maximum power value.
- The substitution horn antenna is substituted for EUT at the same position and signals generator export the CW signal to the substitution antenna via a TX cable. Rotated the Turn Table and moved receiving antenna to find the maximum radiation power. Adjust output power level of S.G to get a Value of spectrum reading equal to "Read Value" of step a. Record the power level of S.G
- $\text{EIRP} = \text{Output power level of S.G} - \text{TX cable loss} + \text{Antenna gain of substitution horn}$.
- E.R.P power can be calculated form E.I.R.P power by subtracting the gain of dipole, $\text{E.R.P power} = \text{E.I.P.R power} - 2.15\text{dBi}$.

NOTE: The resolution bandwidth and video bandwidth of test receiver/spectrum analyzer is 1MHz/3MHz.

4.7.3 Deviation from Test Standard

No deviation.

4.7.4 Test Setup

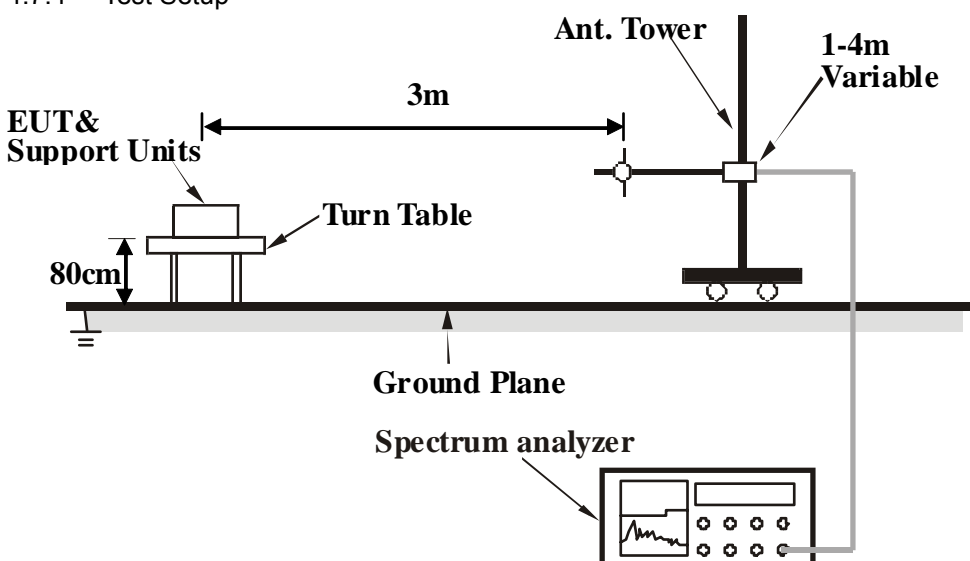

For the actual test configuration, please refer to the attached file (Test Setup Photo).

4.7.5 Test Results

BELOW 1GHz

GPRS:

Mode	TX channel 512	Frequency Range	Below 1000 MHz
------	----------------	-----------------	----------------

Antenna Polarity & Test Distance: Horizontal at 3 M							
No.	Freq. (MHz)	Reading (dBm)	S.G Power Value (dBm)	Correction Factor (dB)	EIRP (dBm)	Limit (dBm)	Margin (dB)
1	149.07	-73.40	-88.03	15.05	-72.98	-13.00	-59.98
2	249.95	-64.89	-82.63	14.22	-68.41	-13.00	-55.41
3	455.95	-69.70	-89.28	20.52	-68.76	-13.00	-55.76
4	503.97	-65.26	-84.55	21.38	-63.17	-13.00	-50.17
5	746.35	-76.38	-96.75	26.20	-70.55	-13.00	-57.55
6	1000.00	-77.96	-97.07	29.05	-68.02	-13.00	-55.02
Antenna Polarity & Test Distance: Vertical at 3 M							
No.	Freq. (MHz)	Reading (dBm)	S.G Power Value (dBm)	Correction Factor (dB)	EIRP (dBm)	Limit (dBm)	Margin (dB)
1	31.94	-69.43	-80.93	12.88	-68.05	-13.00	-55.05
2	131.49	-69.84	-84.77	13.35	-71.42	-13.00	-58.42
3	374.96	-70.51	-88.61	18.20	-70.41	-13.00	-57.41
4	503.97	-72.47	-92.29	21.38	-70.91	-13.00	-57.91
5	746.95	-68.67	-89.71	26.20	-63.51	-13.00	-50.51
6	895.12	-68.54	-88.61	27.84	-60.77	-13.00	-47.77

Remarks:

1. Output Power (dBm) = S.G Value (dBm) + Correction Factor (dB).
2. Correction Factor (dB) = Substitution Antenna Gain (dB) + Cable Loss (dB).

Mode	TX channel 661	Frequency Range	Below 1000 MHz
------	----------------	-----------------	----------------

Antenna Polarity & Test Distance: Horizontal at 3 M

No.	Freq. (MHz)	Reading (dBm)	S.G Power Value (dBm)	Correction Factor (dB)	EIRP (dBm)	Limit (dBm)	Margin (dB)
1	148.10	-73.47	-88.33	15.06	-73.27	-13.00	-60.27
2	249.95	-64.65	-82.39	14.22	-68.17	-13.00	-55.17
3	455.95	-69.31	-88.89	20.52	-68.37	-13.00	-55.37
4	503.97	-65.59	-84.88	21.38	-63.50	-13.00	-50.50
5	715.06	-69.36	-88.51	25.16	-63.35	-13.00	-50.35
6	1000.00	-77.77	-96.88	29.05	-67.83	-13.00	-54.83

Antenna Polarity & Test Distance: Vertical at 3 M

No.	Freq. (MHz)	Reading (dBm)	S.G Power Value (dBm)	Correction Factor (dB)	EIRP (dBm)	Limit (dBm)	Margin (dB)
1	32.30	-74.06	-85.65	12.93	-72.72	-13.00	-59.72
2	148.22	-76.15	-90.69	15.06	-75.63	-13.00	-62.63
3	249.95	-65.67	-81.70	14.22	-67.48	-13.00	-54.48
4	503.97	-68.53	-88.35	21.38	-66.97	-13.00	-53.97
5	600.00	-74.46	-94.50	23.63	-70.87	-13.00	-57.87
6	887.97	-76.71	-96.74	27.83	-68.91	-13.00	-55.91

Remarks:

1. Output Power (dBm) = S.G Value (dBm) + Correction Factor (dB).
2. Correction Factor (dB) = Substitution Antenna Gain (dB) + Cable Loss (dB).

Mode	TX channel 810	Frequency Range	Below 1000 MHz
------	----------------	-----------------	----------------

Antenna Polarity & Test Distance: Horizontal at 3 M

No.	Freq. (MHz)	Reading (dBm)	S.G Power Value (dBm)	Correction Factor (dB)	EIRP (dBm)	Limit (dBm)	Margin (dB)
1	147.25	-72.86	-87.87	15.01	-72.86	-13.00	-59.86
2	216.00	-64.95	-81.62	12.20	-69.42	-13.00	-56.42
3	249.95	-64.95	-82.69	14.22	-68.47	-13.00	-55.47
4	407.94	-71.26	-89.73	18.92	-70.81	-13.00	-57.81
5	503.97	-65.51	-84.80	21.38	-63.42	-13.00	-50.42
6	600.00	-72.30	-91.48	23.63	-67.85	-13.00	-54.85
7	1000.00	-78.02	-97.13	29.05	-68.08	-13.00	-55.08

Antenna Polarity & Test Distance: Vertical at 3 M

No.	Freq. (MHz)	Reading (dBm)	S.G Power Value (dBm)	Correction Factor (dB)	EIRP (dBm)	Limit (dBm)	Margin (dB)
1	149.79	-76.45	-90.62	15.06	-75.56	-13.00	-62.56
2	249.95	-65.88	-81.91	14.22	-67.69	-13.00	-54.69
3	455.95	-73.81	-93.57	20.52	-73.05	-13.00	-60.05
4	503.97	-68.51	-88.33	21.38	-66.95	-13.00	-53.95
5	715.18	-71.48	-91.45	25.16	-66.29	-13.00	-53.29
6	1000.00	-79.54	-99.24	29.05	-70.19	-13.00	-57.19

Remarks:

1. Output Power (dBm) = S.G Value (dBm) + Correction Factor (dB).
2. Correction Factor (dB) = Substitution Antenna Gain (dB) + Cable Loss (dB).

WCDMA:

Mode	TX channel 9262	Frequency Range	Below 1000 MHz
------	-----------------	-----------------	----------------

Antenna Polarity & Test Distance: Horizontal at 3 M

No.	Freq. (MHz)	Reading (dBm)	S.G Power Value (dBm)	Correction Factor (dB)	EIRP (dBm)	Limit (dBm)	Margin (dB)
1	216.00	-63.71	-80.38	12.20	-68.18	-13.00	-55.18
2	249.95	-64.28	-82.02	14.22	-67.80	-13.00	-54.80
3	374.96	-67.61	-85.97	18.20	-67.77	-13.00	-54.77
4	503.97	-66.24	-85.53	21.38	-64.15	-13.00	-51.15
5	551.98	-68.31	-88.36	22.26	-66.10	-13.00	-53.10
6	713.61	-76.07	-95.17	25.12	-70.05	-13.00	-57.05
7	935.98	-79.82	-99.20	28.54	-70.66	-13.00	-57.66

Antenna Polarity & Test Distance: Vertical at 3 M

No.	Freq. (MHz)	Reading (dBm)	S.G Power Value (dBm)	Correction Factor (dB)	EIRP (dBm)	Limit (dBm)	Margin (dB)
1	31.21	-73.90	-85.36	12.93	-72.43	-13.00	-59.43
2	147.01	-75.11	-89.88	15.00	-74.88	-13.00	-61.88
3	249.95	-64.86	-80.89	14.22	-66.67	-13.00	-53.67
4	290.93	-69.57	-87.13	15.88	-71.25	-13.00	-58.25
5	503.97	-68.87	-88.69	21.38	-67.31	-13.00	-54.31
6	551.98	-71.79	-91.22	22.26	-68.96	-13.00	-55.96
7	678.81	-73.23	-93.26	24.76	-68.50	-13.00	-55.50
8	935.98	-78.78	-98.89	28.54	-70.35	-13.00	-57.35

Remarks:

1. Output Power (dBm) = S.G Value (dBm) + Correction Factor (dB).
2. Correction Factor (dB) = Substitution Antenna Gain (dB) + Cable Loss (dB).

Mode	TX channel 9400	Frequency Range	Below 1000 MHz
------	-----------------	-----------------	----------------

Antenna Polarity & Test Distance: Horizontal at 3 M

No.	Freq. (MHz)	Reading (dBm)	S.G Power Value (dBm)	Correction Factor (dB)	EIRP (dBm)	Limit (dBm)	Margin (dB)
1	147.61	-73.09	-88.05	15.04	-73.01	-13.00	-60.01
2	249.95	-63.40	-81.14	14.22	-66.92	-13.00	-53.92
3	407.94	-69.58	-88.05	18.92	-69.13	-13.00	-56.13
4	551.98	-71.57	-91.62	22.26	-69.36	-13.00	-56.36
5	729.13	-74.22	-93.87	25.58	-68.29	-13.00	-55.29
6	775.81	-79.08	-98.77	26.30	-72.47	-13.00	-59.47
7	874.99	-74.68	-94.31	27.67	-66.64	-13.00	-53.64

Antenna Polarity & Test Distance: Vertical at 3 M

No.	Freq. (MHz)	Reading (dBm)	S.G Power Value (dBm)	Correction Factor (dB)	EIRP (dBm)	Limit (dBm)	Margin (dB)
1	31.09	-75.84	-87.29	12.94	-74.35	-13.00	-61.35
2	149.19	-75.36	-89.67	15.06	-74.61	-13.00	-61.61
3	249.95	-64.94	-80.97	14.22	-66.75	-13.00	-53.75
4	374.96	-70.59	-88.69	18.20	-70.49	-13.00	-57.49
5	503.97	-67.52	-87.34	21.38	-65.96	-13.00	-52.96
6	551.98	-71.73	-91.16	22.26	-68.90	-13.00	-55.90
7	678.81	-74.78	-94.81	24.76	-70.05	-13.00	-57.05
8	874.99	-75.20	-95.02	27.67	-67.35	-13.00	-54.35

Remarks:

1. Output Power (dBm) = S.G Value (dBm) + Correction Factor (dB).
2. Correction Factor (dB) = Substitution Antenna Gain (dB) + Cable Loss (dB).

Mode	TX channel 9538	Frequency Range	Below 1000 MHz
------	-----------------	-----------------	----------------

Antenna Polarity & Test Distance: Horizontal at 3 M

No.	Freq. (MHz)	Reading (dBm)	S.G Power Value (dBm)	Correction Factor (dB)	EIRP (dBm)	Limit (dBm)	Margin (dB)
1	149.67	-73.67	-88.17	15.06	-73.11	-13.00	-60.11
2	216.00	-63.73	-80.40	12.20	-68.20	-13.00	-55.20
3	374.96	-67.42	-85.78	18.20	-67.58	-13.00	-54.58
4	503.97	-65.80	-85.09	21.38	-63.71	-13.00	-50.71
5	551.98	-68.18	-88.23	22.26	-65.97	-13.00	-52.97
6	729.49	-65.36	-85.02	25.59	-59.43	-13.00	-46.43
7	1000.00	-77.14	-96.25	29.05	-67.20	-13.00	-54.20

Antenna Polarity & Test Distance: Vertical at 3 M

No.	Freq. (MHz)	Reading (dBm)	S.G Power Value (dBm)	Correction Factor (dB)	EIRP (dBm)	Limit (dBm)	Margin (dB)
1	31.09	-68.71	-80.16	12.94	-67.22	-13.00	-54.22
2	146.04	-74.67	-89.61	14.94	-74.67	-13.00	-61.67
3	249.95	-64.62	-80.65	14.22	-66.43	-13.00	-53.43
4	503.97	-67.81	-87.63	21.38	-66.25	-13.00	-53.25
5	678.81	-73.32	-93.35	24.76	-68.59	-13.00	-55.59
6	874.99	-75.27	-95.09	27.67	-67.42	-13.00	-54.42

Remarks:

1. Output Power (dBm) = S.G Value (dBm) + Correction Factor (dB).
2. Correction Factor (dB) = Substitution Antenna Gain (dB) + Cable Loss (dB).

ABOVE 1GHz

GPRS:

Mode	TX channel 512	Frequency Range	Above 1000MHz
------	----------------	-----------------	---------------

Antenna Polarity & Test Distance: Horizontal at 3 M

No.	Freq. (MHz)	Reading (dBm)	S.G Power Value (dBm)	Correction Factor (dB)	EIRP (dBm)	Limit (dBm)	Margin (dB)
1	2296.00	-63.14	-73.90	13.21	-60.69	-13.00	-47.69
2	3700.40	-45.39	-59.03	18.40	-40.63	-13.00	-27.63
3	5550.52	-70.19	-83.57	22.52	-61.05	-13.00	-48.05
4	7400.90	-71.54	-86.80	25.95	-60.85	-13.00	-47.85
5	9250.59	-70.49	-86.11	29.01	-57.10	-13.00	-44.10
6	11100.48	-72.26	-87.28	30.72	-56.56	-13.00	-43.56

Antenna Polarity & Test Distance: Vertical at 3 M

No.	Freq. (MHz)	Reading (dBm)	S.G Power Value (dBm)	Correction Factor (dB)	EIRP (dBm)	Limit (dBm)	Margin (dB)
1	2650.00	-66.58	-77.23	14.51	-62.72	-13.00	-49.72
2	3700.40	-45.82	-59.49	18.40	-41.09	-13.00	-28.09
3	5550.56	-71.58	-85.17	22.52	-62.65	-13.00	-49.65
4	7401.60	-73.29	-88.59	25.95	-62.64	-13.00	-49.64
5	9250.92	-72.67	-88.26	29.01	-59.25	-13.00	-46.25
6	11101.33	-75.59	-90.40	30.72	-59.68	-13.00	-46.68
7	11320.03	-58.35	-72.55	30.63	-41.92	-13.00	-28.92

Remarks:

1. Output Power (dBm) = S.G Value (dBm) + Correction Factor (dB).
2. Correction Factor (dB) = Substitution Antenna Gain (dB) + Cable Loss (dB).

Mode	TX channel 661	Frequency Range	Above 1000MHz
------	----------------	-----------------	---------------

Antenna Polarity & Test Distance: Horizontal at 3 M

No.	Freq. (MHz)	Reading (dBm)	S.G Power Value (dBm)	Correction Factor (dB)	EIRP (dBm)	Limit (dBm)	Margin (dB)
1	2638.00	-63.01	-73.53	14.47	-59.06	-13.00	-46.06
2	3759.93	-37.36	-50.69	18.54	-32.15	-13.00	-19.15
3	5640.04	-66.47	-79.75	22.60	-57.15	-13.00	-44.15
4	7520.03	-69.88	-85.14	26.21	-58.93	-13.00	-45.93
5	9399.93	-70.58	-86.27	29.22	-57.05	-13.00	-44.05
6	11279.02	-73.79	-88.46	30.60	-57.86	-13.00	-44.86

Antenna Polarity & Test Distance: Vertical at 3 M

No.	Freq. (MHz)	Reading (dBm)	S.G Power Value (dBm)	Correction Factor (dB)	EIRP (dBm)	Limit (dBm)	Margin (dB)
1	2602.00	-66.96	-77.41	14.37	-63.04	-13.00	-50.04
2	3759.98	-40.61	-54.00	18.54	-35.46	-13.00	-22.46
3	5639.95	-68.35	-81.82	22.60	-59.22	-13.00	-46.22
4	7518.38	-72.77	-88.07	26.21	-61.86	-13.00	-48.86
5	9400.00	-72.55	-88.20	29.22	-58.98	-13.00	-45.98
6	11278.52	-76.01	-90.37	30.60	-59.77	-13.00	-46.77

Remarks:

1. Output Power (dBm) = S.G Value (dBm) + Correction Factor (dB).
2. Correction Factor (dB) = Substitution Antenna Gain (dB) + Cable Loss (dB).

Mode	TX channel 810	Frequency Range	Above 1000MHz
------	----------------	-----------------	---------------

Antenna Polarity & Test Distance: Horizontal at 3 M							
No.	Freq. (MHz)	Reading (dBm)	S.G Power Value (dBm)	Correction Factor (dB)	EIRP (dBm)	Limit (dBm)	Margin (dB)
1	2659.00	-63.48	-74.04	14.53	-59.51	-13.00	-46.51
2	3819.75	-43.01	-56.28	18.69	-37.59	-13.00	-24.59
3	5729.53	-66.14	-79.32	22.68	-56.64	-13.00	-43.64
4	7637.24	-69.49	-84.68	26.48	-58.20	-13.00	-45.20
5	9548.98	-70.59	-86.17	29.24	-56.93	-13.00	-43.93
6	11459.82	-71.78	-86.44	30.82	-55.62	-13.00	-42.62
Antenna Polarity & Test Distance: Vertical at 3 M							
No.	Freq. (MHz)	Reading (dBm)	S.G Power Value (dBm)	Correction Factor (dB)	EIRP (dBm)	Limit (dBm)	Margin (dB)
1	3166.00	-66.35	-77.84	16.17	-61.67	-13.00	-48.67
2	3819.65	-47.89	-61.25	18.69	-42.56	-13.00	-29.56
3	5729.58	-69.06	-82.41	22.68	-59.73	-13.00	-46.73
4	7640.16	-72.36	-87.68	26.48	-61.20	-13.00	-48.20
5	9548.62	-73.84	-89.40	29.24	-60.16	-13.00	-47.16
6	11457.22	-75.59	-89.85	30.82	-59.03	-13.00	-46.03

Remarks:

1. Output Power (dBm) = S.G Value (dBm) + Correction Factor (dB).
2. Correction Factor (dB) = Substitution Antenna Gain (dB) + Cable Loss (dB).

WCDMA:

Mode	TX channel 9262	Frequency Range	Above 1000MHz
------	-----------------	-----------------	---------------

Antenna Polarity & Test Distance: Horizontal at 3 M

No.	Freq. (MHz)	Reading (dBm)	S.G Power Value (dBm)	Correction Factor (dB)	EIRP (dBm)	Limit (dBm)	Margin (dB)
1	2632.00	-63.37	-73.87	14.45	-59.42	-13.00	-46.42
2	3706.16	-51.18	-64.78	18.41	-46.37	-13.00	-33.37
3	5558.96	-69.01	-82.38	22.53	-59.85	-13.00	-46.85
4	7409.65	-70.02	-85.28	25.97	-59.31	-13.00	-46.31
5	9259.69	-70.72	-86.34	29.02	-57.32	-13.00	-44.32
6	11113.29	-74.65	-89.64	30.71	-58.93	-13.00	-45.93

Antenna Polarity & Test Distance: Vertical at 3 M

No.	Freq. (MHz)	Reading (dBm)	S.G Power Value (dBm)	Correction Factor (dB)	EIRP (dBm)	Limit (dBm)	Margin (dB)
1	2638.00	-66.06	-76.66	14.47	-62.19	-13.00	-49.19
2	3706.20	-54.37	-68.01	18.41	-49.60	-13.00	-36.60
3	5559.37	-71.55	-85.13	22.53	-62.60	-13.00	-49.60
4	7410.15	-73.31	-88.61	25.97	-62.64	-13.00	-49.64
5	9260.16	-73.13	-88.72	29.02	-59.70	-13.00	-46.70
6	11114.09	-76.17	-90.94	30.71	-60.23	-13.00	-47.23

Remarks:

1. Output Power (dBm) = S.G Value (dBm) + Correction Factor (dB).
2. Correction Factor (dB) = Substitution Antenna Gain (dB) + Cable Loss (dB).

Mode	TX channel 9400	Frequency Range	Above 1000MHz
------	-----------------	-----------------	---------------

Antenna Polarity & Test Distance: Horizontal at 3 M							
No.	Freq. (MHz)	Reading (dBm)	S.G Power Value (dBm)	Correction Factor (dB)	EIRP (dBm)	Limit (dBm)	Margin (dB)
1	2644.00	-63.04	-73.57	14.49	-59.08	-13.00	-46.08
2	3758.25	-48.88	-62.21	18.53	-43.68	-13.00	-30.68
3	5638.69	-68.91	-82.19	22.60	-59.59	-13.00	-46.59
4	7519.91	-70.43	-85.69	26.21	-59.48	-13.00	-46.48
5	9402.03	-70.78	-86.46	29.22	-57.24	-13.00	-44.24
6	11280.87	-73.58	-88.25	30.60	-57.65	-13.00	-44.65
Antenna Polarity & Test Distance: Vertical at 3 M							
No.	Freq. (MHz)	Reading (dBm)	S.G Power Value (dBm)	Correction Factor (dB)	EIRP (dBm)	Limit (dBm)	Margin (dB)
1	2638.00	-66.07	-76.67	14.47	-62.20	-13.00	-49.20
2	3758.45	-52.04	-65.43	18.53	-46.90	-13.00	-33.90
3	5642.24	-73.37	-86.84	22.61	-64.23	-13.00	-51.23
4	7522.49	-72.66	-87.96	26.22	-61.74	-13.00	-48.74
5	9401.62	-73.63	-89.28	29.22	-60.06	-13.00	-47.06
6	11279.84	-76.47	-90.83	30.60	-60.23	-13.00	-47.23

Remarks:

1. Output Power (dBm) = S.G Value (dBm) + Correction Factor (dB).
2. Correction Factor (dB) = Substitution Antenna Gain (dB) + Cable Loss (dB).

Mode	TX channel 9538	Frequency Range	Above 1000MHz
------	-----------------	-----------------	---------------

Antenna Polarity & Test Distance: Horizontal at 3 M							
No.	Freq. (MHz)	Reading (dBm)	S.G Power Value (dBm)	Correction Factor (dB)	EIRP (dBm)	Limit (dBm)	Margin (dB)
1	1813.00	-62.61	-72.75	12.02	-60.73	-13.00	-47.73
2	3813.42	-51.81	-65.03	18.67	-46.36	-13.00	-33.36
3	5720.82	-70.29	-83.47	22.67	-60.80	-13.00	-47.80
4	7628.36	-70.42	-85.62	26.46	-59.16	-13.00	-46.16
5	9537.99	-71.97	-87.54	29.22	-58.32	-13.00	-45.32
6	11445.51	-72.53	-87.20	30.81	-56.39	-13.00	-43.39
Antenna Polarity & Test Distance: Vertical at 3 M							
No.	Freq. (MHz)	Reading (dBm)	S.G Power Value (dBm)	Correction Factor (dB)	EIRP (dBm)	Limit (dBm)	Margin (dB)
1	1909.00	-64.55	-74.52	11.99	-62.53	-13.00	-49.53
2	3813.51	-54.62	-67.93	18.67	-49.26	-13.00	-36.26
3	5723.62	-72.25	-85.60	22.67	-62.93	-13.00	-49.93
4	7631.31	-72.02	-87.34	26.47	-60.87	-13.00	-47.87
5	9536.11	-73.74	-89.27	29.21	-60.06	-13.00	-47.06
6	11445.31	-75.47	-89.74	30.81	-58.93	-13.00	-45.93

Remarks:

1. Output Power (dBm) = S.G Value (dBm) + Correction Factor (dB).
2. Correction Factor (dB) = Substitution Antenna Gain (dB) + Cable Loss (dB).

5 Pictures of Test Arrangements

Please refer to the attached file (Test Setup Photo).

Appendix – Information on the Testing Laboratories

We, Bureau Veritas Consumer Products Services (H.K.) Ltd., Taoyuan Branch, were founded in 1988 to provide our best service in EMC, Radio, Telecom and Safety consultation. Our laboratories are accredited and approved according to ISO/IEC 17025.

If you have any comments, please feel free to contact us at the following:

Linko EMC/RF Lab

Tel: 886-2-26052180

Fax: 886-2-26051924

Hsin Chu EMC/RF/Telecom Lab

Tel: 886-3-6668565

Fax: 886-3-6668323

Hwa Ya EMC/RF/Safety

Tel: 886-3-3183232

Fax: 886-3-3270892

Email: service.adt@tw.bureauveritas.com

Web Site: www.bureauveritas-adt.com

The address and road map of all our labs can be found in our web site also.

--- END ---