



Leica iCON gps 60 User Manual

Version 1.0
English

- when it has to be **right**

Leica
Geosystems

Introduction

Purchase



Congratulations on the purchase of a Leica iCON gps 60 system.

This manual contains important safety directions as well as instructions for setting up the product and operating it. Refer to "7 Safety Directions" for further information.

Read carefully through the User Manual before you switch on the product.

Product identification





The type and serial number of your product are indicated on the type plate. Enter the type and serial number in your manual and always refer to this information when you need to contact your agency or Leica Geosystems authorised service workshop.

Type: _____

Serial No.: _____

Symbols

The symbols used in this manual have the following meanings:

Type	Description
 DANGER	Indicates an imminently hazardous situation which, if not avoided, will result in death or serious injury.
 WARNING	Indicates a potentially hazardous situation or an unintended use which, if not avoided, could result in death or serious injury.
 CAUTION	Indicates a potentially hazardous situation or an unintended use which, if not avoided, may result in minor or moderate injury and/or appreciable material, financial and environmental damage.
	Important paragraphs which must be adhered to in practice as they enable the product to be used in a technically correct and efficient manner.



Trademarks



- Windows is a registered trademark of Microsoft Corporation in the United States and other countries
 - CompactFlash and CF are trademarks of SanDisk Corporation
 - Bluetooth is a registered trademark of Bluetooth SIG, Inc.
- All other trademarks are the property of their respective owners.

Validity of this manual

This manual applies to the Leica iCON gps 60 SmartAntenna.

Available documentation

Name	Description/Format		
Leica iCON gps 60 User Manual	All instructions required in order to operate the product to a basic level are contained in the User Manual. Provides an overview of the product together with technical data and safety directions.		✓

Name	Description/Format		
Leica iCON gps 60 System Field Manual	Describes the general working of the product in standard use. Intended as a quick reference field guide.	✓	✓

Refer to the following resources for all Leica iCON documentation/software:

- the Leica iCON DVD.
- <https://myworld.leica-geosystems.com>

DVD-ROM contents The Leica iCON DVD contains software and documentation specific to Leica iCON gps 60:

Type	Description
Software	System software Software language files
Documentation	Leica gps 60 User Manual Leica gps 60 System Field Manual



myWorld@Leica Geosystems (<https://myworld.leica-geosystems.com>) offers a wide range of services, information and training material.

With direct access to myWorld, you are able to access all relevant services whenever it is convenient for you, 24 hours a day, 7 days per week. This increases your efficiency and keeps you and your equipment instantly updated with the latest information from Leica Geosystems.

Service	Description
myProducts	Simply add all Leica Geosystems products that you and your company own. View detailed information on your products, buy additional options or Customer Care Packages (CCPs), update your products with the latest software and keep up-to-date with the latest documentation.

Service	Description
myService	View the service history of your products in Leica Geosystems Service Centers and detailed information on the services performed on your products. For your products that are currently in Leica Geosystems Service Centers view the current service status and the expected end date of service.
mySupport	Create new support requests for your products that will be answered by your local Leica Geosystems Support Team. View the complete history of your Support and view detailed information on each request in case you want to refer to previous support requests.
myTraining	Enhance your product knowledge with the Leica Geosystems Campus - Information, Knowledge, Training. Study the latest online training material or download training material on your products. Keep up-to-date with the latest News on your products and register for Seminars or Courses in your country.

Table of Contents

In this manual	Chapter	Page
	1 Unpacking the Container	11
	1.1 Leica iCON gps 60 Container Contents	11
	1.2 Compatible Field Controllers	17
	1.2.1 iCON Series Field Software Overview	20
	1.3 Holder and Clamps for Field Controllers	22
	2 Using the iCON gps 60 SmartAntenna	24
	2.1 Installing the Internal Battery	24
	2.1.1 General Battery Handling	26
	2.2 Installing a SIM Card	27
	2.3 Understanding Antenna Heights	29
	2.4 The Mechanical Reference Plane, MRP	30
	2.5 Measuring the Antenna Height for a Pillar Setup	31
	2.6 Measuring the Antenna Height for a Tripod Setup	33
	2.7 Measuring the Antenna Height for a Pole Setup	34

3	Leica iCON gps 60 User Interface	35
3.1	Main Menu	38
3.1.1	Navigation in Sub Menus	45
3.1.2	Available Sub Menus	46
3.2	How to Change and Edit Values	52
4	Software Tools	56
4.1	Base Setup	56
4.1.1	Base Setup Functions	59
4.1.2	Raw Data Logging	65
4.2	Licensing	67
5	Setups with Controller and Accessories	68
5.1	Real-Time Base Setup	68
5.2	Base Station with MNA1202	71
5.3	Real-Time Base with Raw Data Logging	75
5.4	Raw Data Logging Setup	78
5.5	Real-Time Rover Setup	80
5.6	Establish Bluetooth Data Connection	84

6	Care and Transport	85
6.1	Transport	85
6.2	Storage	86
6.3	Cleaning and Drying	87
7	Safety Directions	88
7.1	General Introduction	88
7.2	Definition of Use	89
7.3	Limits of Use	91
7.4	Responsibilities	92
7.5	Hazards of Use	93
7.6	Electromagnetic Compatibility EMC	102
7.7	FCC Statement, Applicable in U.S.	105
8	Technical Data	107
8.1	Technical Data iCON gps 60 Antenna	107
8.1.1	Tracking Characteristics	112
8.1.2	Accuracy	114
8.2	Technical Data MNA1202 GG Antenna	116
8.3	Pin Assignments and Sockets	119
8.4	Conformity Declarations	121

iCON gps 60, Table of Contents	10
<hr/>	
9 International Limited Warranty, Software Licence Agreement	122
<hr/>	
Index	124
<hr/>	

1 Unpacking the Container

1.1 Leica iCON gps 60 Container Contents

Description

There are four different container configurations available to cover GNSS rover and reference setups.

**CTC1 Container
upper shell**

The large-size CTC1 container comprises all items for the rover setup. The content of the upper shell is the same for all available container configuration.

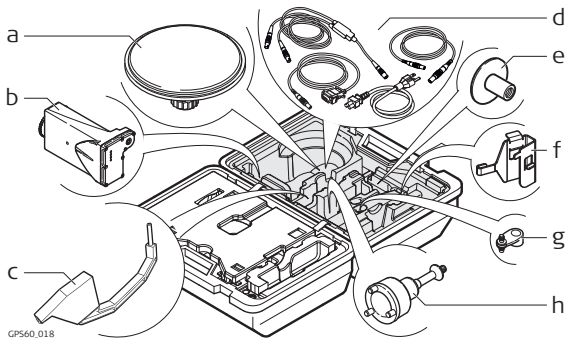

GPS60.018

- | | |
|-----------------------|---|
| a) MNA1202 GG antenna | e) GHT36 - base for telescopic rod |
| b) GFU modem | f) GHT58 - tripod bracket for GFU housing |
| c) Height hook | g) GAD34 arm 3 cm |
| d) Cable set | h) GRT146 carrier |

**CTC1 container
lower shell -
iCON CC60/CC61**

Large-size CTC1 container configuration with iCON CC60/CC61 controller.

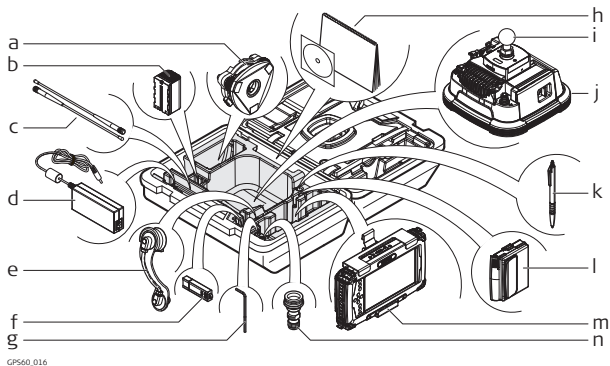

- a) Tribrach
- b) GEB221 battery
- c) Radio antennas
- d) AC-adaptor for controller
- e) GAD108 antenna arm
- f) USB flash drive
- g) Allen key
- h) Manuals
- i) Ball mount
- j) iCON gps 60 SmartAntenna
- k) Spare stylus for CC60/CC61
- l) Spare battery for CC60/CC61
- m) CC60/CC61
- n) QN/TNC adapter

CTC1 container lower shell - iCON CC50

Large-size CTC1 container configuration with iCON CC50 controller.

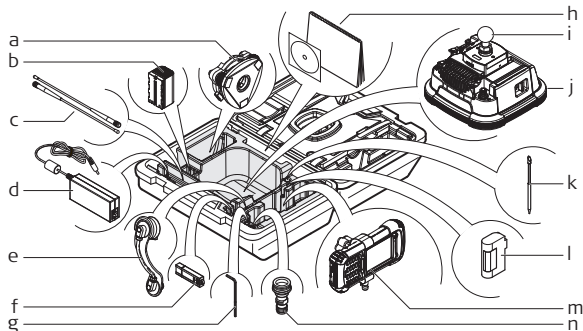

- | | |
|------------------------------|-----------------------------|
| a) Tribrach | h) Manuals and iCON DVD |
| b) GEB221 battery | i) Ball mount |
| c) Radio antennas | j) iCON gps 60 SmartAntenna |
| d) AC-adaptor for controller | k) Spare stylus for CC50 |
| e) GAD108 antenna arm | l) Spare battery for CC50 |
| f) USB flash drive | m) CC50 |
| g) Allen key | n) QN/TNC adapter |

CTC2 container - iCON gps 60

The small-size CTC2 container comprises the iCON gps 60 SmartAntenna and its accessories.

 The container can additionally hold a iCON CC50 controller with accessories.

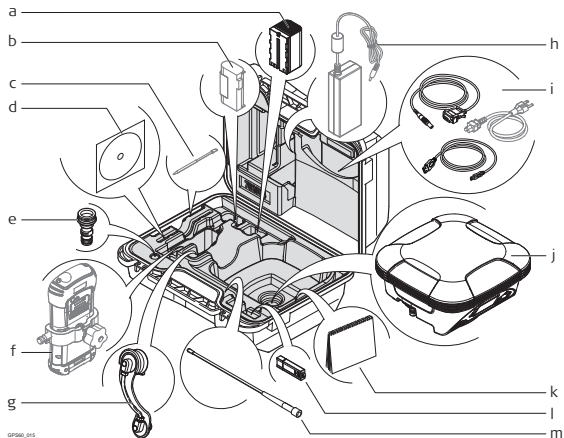

- a) GEB221 battery
 - b) Spare battery for CC50
 - c) Spare stylus for CC50
 - d) iCON DVD
 - e) QN/TNC adapter
 - f) Storage space for CC50
 - g) GAD108 antenna arm
 - h) AC-adapter
 - i) Cable set
 - j) iCON gps 60 SmartAntenna
 - k) Manuals
 - l) USB flash drive
 - m) Radio antenna
-

1.2

Compatible Field Controllers

About the controllers

 The iCON gps 60 SmartAntenna can be used as a standalone device or in combination with compatible controllers running iCON field software.

CC50 upside

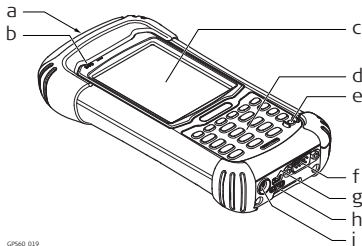

GPS60_019

- a) SD-card slot
- b) Status LEDs
- c) Screen
- d) Keyboard
- e) Power button
- f) Serial connector
- g) Mini-USB connector
- h) Docking connector
- i) Power connector

CC50 rear side

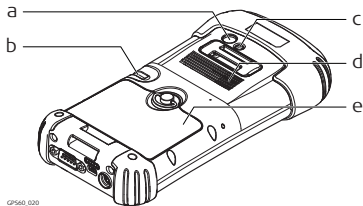

GPS60_020

- a) Camera lens
- b) Stylus
- c) Hand strap clip
- d) Speaker
- e) Battery and SIM-card compartment

CC60/CC61 upside

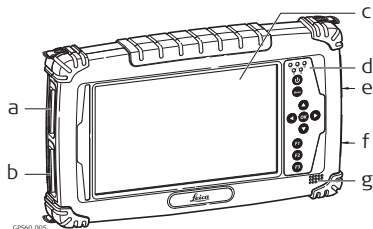

GPS60_005

- a) D-SUB 9 port
- b) USB host port for USB stick
- c) Screen
- d) Keyboard
- e) Micro in, Audio out and LAN
- f) Power socket and USB host port for USB stick
- g) Speaker

**CC60/CC61 rear
side**

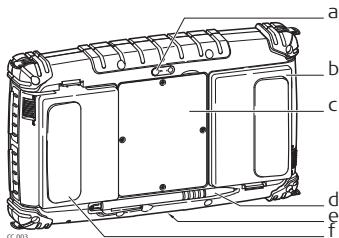

- a) Digital camera
- b) Battery compartment L
- c) SIM card slot
- d) Stylus
- e) Docking station contacts
- f) Battery compartment R

1.2.1

iCON Series Field Software Overview

iCON Site software -
main menu at a
glance



Refer to the iCON Site software on the
iCON DVD.

iCON Build software - main menu at a glance



Refer to the iCON Build software on the iCON DVD.

1.3

Holder and Clamps for Field Controllers

Holder for iCON CC50

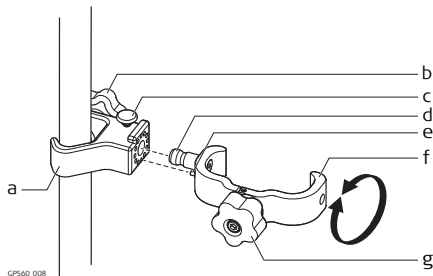

Clamp:

- a) Pole clamp
- b) Tightening screw
- c) Unlocking bolt

Holder:

- d) Mounting pin
 - e) Positioning pin
 - f) Instrument holder
 - g) Tightening screw
-

Holder for iCON CC60/CC61

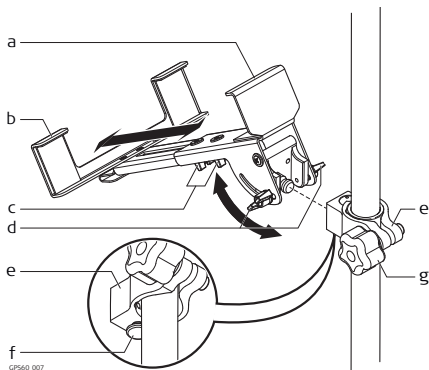

Holder:

- a) Upper holder (fixed)
- b) Lower holder (extendable)
- c) Fixation screws (size adjustment)
- d) Fixation screws (angle adjustment)

Clamp:

- e) Pole clamp
- f) Unlocking bolt
- g) Tightening screw

2 Using the iCON gps 60 SmartAntenna

2.1 Installing the Internal Battery

Insert and remove the battery step-by-step

Follow the step-by-step instructions to install the internal battery.



To remove the battery, first place the instrument on a stable surface. Then follow the following instructions in reverse.

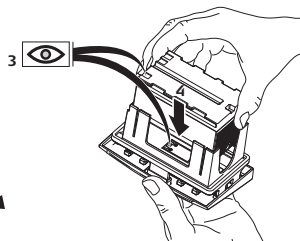
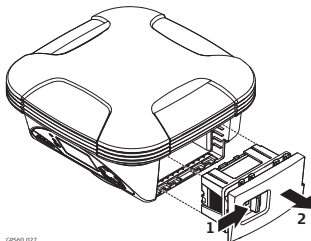



Place the instrument onto a stable surface. (Not illustrated)

Step	Description
1.	Push the slide fastener in the direction of the arrow with the open-lock symbol.
2.	Pull out the battery holder.
3.	Orientate the battery to match with the pictogram on the base of the holder!
4.	Insert the battery into the holder. Check that the battery is locked in!
5.	Push the holder with battery into the battery compartment.
6.	Close the battery compartment by pushing the slide fastener in the direction of the arrow with the close-lock symbol.

2.1.1 General Battery Handling

Charging / first-time use

- The battery must be charged prior to using it for the first time because it is delivered with an energy content as low as possible.
- The permissible temperature range for charging is between 0°C to +40°C/ +32°F to +104°F. For optimal charging, we recommend charging the batteries at a low ambient temperature of +10°C to +20°C/+50°F to +68°F if possible.
- It is normal for the battery to become warm during charging. Using the chargers recommended by Leica Geosystems, it is not possible to charge the battery if the temperature is too high.
- For new batteries or batteries that have been stored for a long time (> three months), it is effectual to make only one charge/discharge cycle.
- For Li-Ion batteries, a single discharging and charging cycle is sufficient. We recommend carrying out the process when the battery capacity indicated on the charger or on a Leica Geosystems product deviates significantly from the actual battery capacity available.

Operation / Discharging

- The batteries can be operated from -20°C to +55°C/-4°F to +131°F.
 - Low operating temperatures reduce the capacity that can be drawn; high operating temperatures reduce the service life of the battery.
-

2.2

Installing a SIM Card

Insert and remove the SIM card step-by-step

Follow the step-by-step instructions to install a SIM card.



To remove the SIM card place the instrument on a stable surface first. Then follow the following instructions in reverse order.

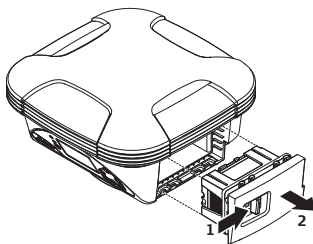

GPS60_028

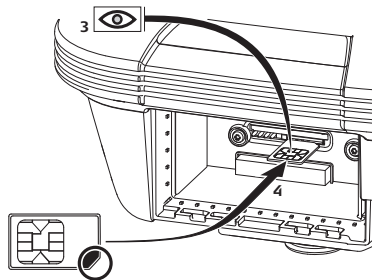



Place the instrument onto a stable surface. (Not illustrated)

Step	Description
1.	Push the slide fastener in the direction of the arrow with the open-lock symbol.
2.	Pull out the battery holder.
3.	Orientate the SIM card as illustrated.
4.	Insert the SIM card into the card slot and push it in until it locks in place.
5.	Insert the battery holder. Check for proper seating!
6.	Close the battery compartment by pushing the slide fastener in the direction of the arrow with the close-lock symbol.

2.3

Understanding Antenna Heights

Description

- The height of the GNSS SmartAntenna above the measured point consists of three components:
 - the vertical height reading,
 - the vertical offset,
 - the vertical phase centre variations.
 - For most operations, pre-configured antenna settings of Leica field controllers (i.e. CC60/CC61 or CC50) can be used. These settings take the vertical phase centre variations into account.
-

MRP

The antenna accepts vertical height readings to the **Mechanical Reference Plane**, MRP.

Vertical phase centre variations

These are handled automatically in the standard antenna records. The antenna calibrations to determine the phase centre variations were executed by Geo++® GmbH.



Pillar setup. For other than the GRT146 carrier, the dimensions must be determined and the vertical offset must be adapted.



Tripod setup. For height measurement devices other than the height hook, the dimensions must be determined and the vertical offset must be adapted.



Pole setup. For other than Leica poles, the dimensions must be determined.

2.4

The Mechanical Reference Plane, MRP

Description

The **Mechanical Reference Plane**:

- is where the antenna heights are measured to.
 - is where the phase centre variations refer to.
 - varies for different antennas.
-

MRP of the antenna

The MRP for the antenna is shown in the diagram.

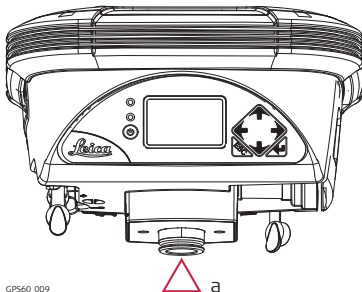

GPS60_009

- a) The mechanical reference plane is the underside of the threaded metal insert.
-

2.5

Measuring the Antenna Height for a Pillar Setup

Measuring the antenna height - pillar setup

Setup type	Antenna name	The required measurement
Pillar	iCON gps 60 Pillar	the vertical height reading to the MRP.

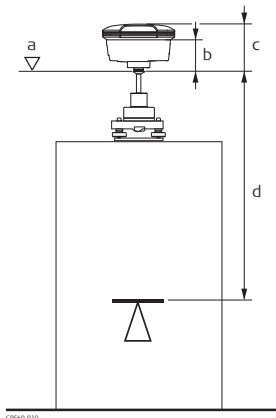

- a) Mechanical reference plane MRP
- b) Vertical phase centre offset for L1
- c) Vertical phase centre offset for L2
- d) **Vertical Height Reading**

No vertical offset.

Determining the antenna height with the GRT146 carrier step-by-step

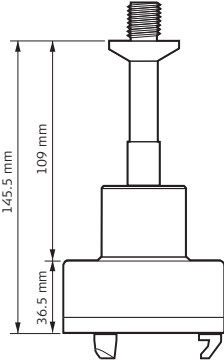
Step	Description
1.	<p>Measure a height from the pillar benchmark to a surface on the carrier.</p>  <p>The diagram shows a carrier assembly with a threaded antenna on top. Three vertical dimension lines are shown on the left side, indicating heights from the base of the carrier. The top dimension line is labeled '145.5 mm' and extends to the top of the antenna. The middle dimension line is labeled '109 mm' and extends to the top of the carrier's main body. The bottom dimension line is labeled '36.5 mm' and extends to the top of the carrier's main body. The carrier has two small feet at the bottom.</p> <p><small>CS_036</small></p>
2.	<p>Use the appropriate measurement from the diagram above. Determine the height difference between the measured surface on the carrier and where the MRP of the antenna sits on the carrier.</p>
3.	<p>The vertical height reading = adding the values in step 1. and step 2.</p>

2.6

Measuring the Antenna Height for a Tripod Setup

Measuring the antenna height - tripod setup

Setup Type	Antenna type	The required measurement
Tripod	iCON gps 60 Tripod	the vertical height reading from the height hook.

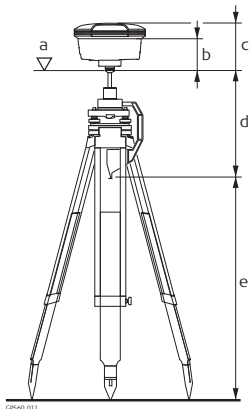

- a) Mechanical reference plane MRP
- b) Vertical phase centre offset for L1
- c) Vertical phase centre offset for L2
- d) Vertical offset
- e) **Vertical Height Reading**

Vertical offset = 0.36

Determining the antenna height with the height hook step-by-step

Step	Description
1.	<p>The vertical height reading = vertical height reading from the height hook.</p> <ul style="list-style-type: none"> The vertical height reading is the height difference between the ground mark and the bottom end of the height hook. The vertical offset of 0.36 m is automatically stored in the antenna setup record for a tripod setup and will automatically be taken into account. It does not need to be entered.

2.7**Measuring the Antenna Height for a Pole Setup****Measuring the antenna height - pole setup**

Setup Type	Antenna type	The required measurement
Pole	iCON gps 60 Pole	<ul style="list-style-type: none"> vertical height reading of the pole.

3 Leica iCON gps 60 User Interface

User Interface overview

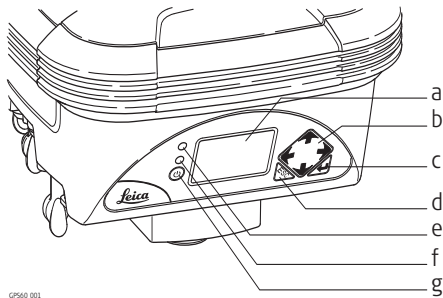





GPS60_001

- a) Display
- b) Navigation keys
- c) ENTER key
- d) ESC key
- e) Ambient light sensor
- f) Power and status LED
- g) ON/OFF key



User Interface elements



The instrument can be controlled and used as a stand-alone base point instrument via the user interface elements.

Element	Function
Navigation keys 	<ul style="list-style-type: none"> • 4-way navigation in the menus via left, right, up and down key.
Enter 	<ul style="list-style-type: none"> • To activate editing. • To accept changes. • To enter a menu or submenu.
ESC 	<ul style="list-style-type: none"> • To cancel operations. • To leave a menu.
ON/OFF key 	<ul style="list-style-type: none"> • Gives access to startup, shutdown and reset functions.
Graphical display	<ul style="list-style-type: none"> • Displays status informations and software functions.
Ambient light sensor	<ul style="list-style-type: none"> • Energy saving ambient light sensor.

Element		Function
Power LED	off	<ul style="list-style-type: none"> • Antenna switched off.
	continuously green	<ul style="list-style-type: none"> • Normal operation mode. • Battery level above 20%.
	continuously red	<ul style="list-style-type: none"> • Critical antenna error. • "!" shown in a main screen icon. • During bootup.

 Use the navigation keys to select a program icon and to navigate within submenus.

 Use the  key to enter a submenu and confirm settings.

 Use the  key to discard settings, cancel operations and to go back to the main menu.

3.1

Main Menu

Description

The Main Menu is the first screen displayed when the instrument is switched on.

Main menu on the display

The main menu features a matrix set of program icons.



The appearance of the program icon depends upon the current instrument status and setup.

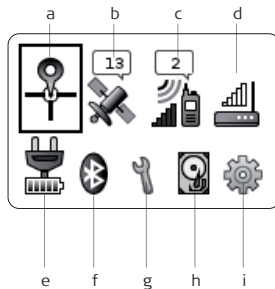









GPS60_003





- a) Position icon
- b) Satellite icon
- c) Radio icon
- d) Modem icon
- e) Battery/Power icon
- f) Bluetooth icon
- g) Construction telematics icon
- h) Memory and logging icon
- i) Settings icon





Additional icon information



The program icons on the display provides additional information related to basic instrument and sensor status.





Icon	Description
Position	<ul style="list-style-type: none">• Sensor has not obtained a position.
	
	<ul style="list-style-type: none">• Navigated position has been obtained.• Error ≤ 10 m.
	<ul style="list-style-type: none">• Float position has been obtained.• Error ≤ 0.5 m.
	<ul style="list-style-type: none">• High accuracy position has been obtained.• Error ≤ 0.05 m.
	<ul style="list-style-type: none">• iCON gps 60 is operating as a base.
	<ul style="list-style-type: none">• BasePilot setup in progress.
	<ul style="list-style-type: none">• BasePilot setup failed.

Icon	Description
	<ul style="list-style-type: none"> No satellites tracked.
	<ul style="list-style-type: none"> Number of tracked satellites.





Icon	Description
	<ul style="list-style-type: none"> Radio not in use.
	<ul style="list-style-type: none"> Radio set to receive correction data in rover mode. Active radio channel is displayed. Waves flash when correction data is received.
	<ul style="list-style-type: none"> Radio set to transmit correction data in base mode. Active radio channel is displayed. Waves flash when correction data is transmitted.
	<ul style="list-style-type: none"> Radio error.

Icon	Description
Modem 	<ul style="list-style-type: none"> Modem not in use.
	<ul style="list-style-type: none"> Modem connected to a cell phone network.
	<ul style="list-style-type: none"> Modem set to receive correction data in rover mode. Waves flash when correction data is received.
	<ul style="list-style-type: none"> Modem set to transmit correction data in base mode. Waves flash when correction data is transmitted.
	<ul style="list-style-type: none"> Modem error.

Icon	Description
Bluetooth 	<ul style="list-style-type: none">• Bluetooth OFF.
	<ul style="list-style-type: none">• Bluetooth ON.
	<ul style="list-style-type: none">• Bluetooth connection active.

Icon	Description
Battery / Power 	<ul style="list-style-type: none"> Internal battery in use. Bars indicate the battery power level.
	<ul style="list-style-type: none"> Internal battery low.
	<ul style="list-style-type: none"> External power is used. Internal battery is installed.
	<ul style="list-style-type: none"> External power is used. Internal battery is not installed.

Icon	Description
Construction telematics 	<ul style="list-style-type: none"> For future use.

Icon	Description
Storage	 <ul style="list-style-type: none">• Memory icon (internal memory).
	 <ul style="list-style-type: none">• USB flash drive inserted.
	 <ul style="list-style-type: none">• Raw data logging ongoing.
	 <ul style="list-style-type: none">• Memory error (internal memory). Can also occur in combination with USB flash drive and Raw data logging.

Icon	Description
Settings	 <ul style="list-style-type: none">• Settings icon.



3.1.1

Navigation in Sub Menu





Locked Submenus



Features that are not active due to a missing licence are marked with a "lock symbol".

	Satellites	
GPS	:	9 / 10
GLONASS	:	
Galileo	:	
Total	:	9 / 10
Cut-Off Angle	:	10 °



To enter a submenu, highlight a menu icon and press the  key. Use the  and  navigation keys to navigate through submenu with multiple pages. Use the  and  navigation keys to select a submenu entry.

- Small boxes at the bottom of a submenu page indicate the number pages within the submenu,
- while a solid black box indicates the current position within the submenu.

3.1.2 Available Sub Menus

Position Menu

Informs about:

- position quality
- position coordinates and coordinate systems
- active antenna and antenna height
- RTK mode
- date and time

Configurable values in submenus:

- antenna type (if external antenna is connected)
 - antenna height
 - measuring mode of antenna height
-

Satellite Menu

Informs about:

- number of tracked satellites if no position is given (no base correction data received)
- number of used satellites when position is available (with base correction data)
- number of reference satellites (rover mode only)
- Cut-Off angle

Configurable values in submenus:

- Cut-Off angle
-

Radio Menu

Informs about:

- radio status information
- connection details of the internal and / or external radio
- base station information

Configurable values in submenus:

- radio channel
 - radio ON/OFF
-

Modem Menu

Informs about:

- modem status information
- connection details of internal modem

Configurable values in submenus:

- modem ON/OFF
 - modem connect/disconnect
-

Battery Menu

Informs about:

- battery level of internal and / or external battery

Configurable values in submenus:

- none
-

Bluetooth Menu

Informs about:

- Bluetooth connection status

Configurable value in submenu:

- activate/deactivate Bluetooth
-

**Construction
telematics Menu**

Reserved for future use.

Configurable value in submenu:

- none
-

Storage Menu

Informs about the RawDataLogging storage status:

- RawDataLogging **active** or **inactive**

Configurable value in submenu:

- none
-

Settings Menu

Contains a set of four submenus.

List of available submenus:

- **Tools**
- **System Information**
- **System Configuration**
- **Service**

Tools submenu:

Functions	Description
Base setup	setup base station
Raw data logging	RINEX logging for post processing (see "Raw Data logging")
Import / Export / Delete	data transfer from / to USB flash drive / deletion of files
Licences	add / check licences

System Information submenu:

Functions	Description
System Information	<ul style="list-style-type: none">• sensor serial number• active firmware versions• other system related information

System Configuration submenu:

Functions	Description
Upload firmware	firmware file must be placed on a USB flash drive
Choose language	change system language
Reset options	multiple reset options given
Screen settings	set display backlight and power saving options
Start up & shut down	configure Start on pulse to port functionality
GNSS settings	configure GLONASS, Galileo and GPS L5 and L2C

Functions	Description
Time zone	define timezone, daylight saving and current time
Units & Formats	define units and their formats

Service Information submenu:

Functions	Description
Service	Password protected - for Service & Support staff only

Service Menu

Functions	Description
Service	Password protected - for Service & Support staff only

3.2 How to Change and Edit Values

Select and edit values in a submenu

Internal Radio (3)	
Model :	Satel M3-TR1
Channel :	2
Frequency :	433.700 MHz
Protocol :	Satel 3AS
Sign. Qual :	Very High
	■■■■■

Internal Radio (3)	
Model :	Satel M3-TR1
Channel :	+02
Frequency :	433.575 MHz
Protocol :	Satel 3AS
Sign. Quality :	Very High
	■■■■■

When entering a submenu the first editable value is automatically selected. This is indicated by a frame around the entry.



Use the **↑** and **↓** navigation keys to highlight the submenu entry of interest.

Press  key make a value editable. The value is displayed with the colours inverted when editable.

- Use the **↑** and **↓** navigation keys to change a value.
- Use the **←** and **→** navigation keys to select a character.

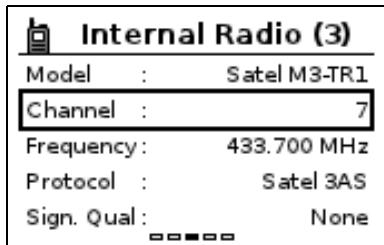



Press  key again to save the changes.
The reading switches back to non-inverted mode.



Check that the desired value is displayed.



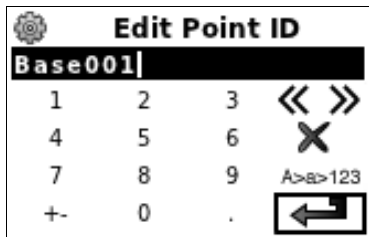

Enter numbers or text

The user interface is equipped with a virtual keyboard for alphanumerical typing.



 The virtual keyboard works similar to a mobile phone keyboard. Press  repeatedly to toggle between the different characters.



First select a submenu item, as shown in the example.

- Press  key to edit a number/text field.
- Use the navigation keys to select a key on the virtual keyboard.
- Press  key (if necessary repeatedly) to select a character.
- Highlight  and press  key to save the changes.

Special keys	Function
A>a>123	Switches between upper/lower case and the number keyboard.

Special keys	Function
	Moves the position of the cursor.
	Deletes the character left of the cursor (backspace functionality).
	Stores the current content of the textfield and ends the input mode.

4 Software Tools

4.1 Base Setup

Using the Base Point List

The Base Point List comprises a list of known base points with all corresponding base system configuration data. It is used with the BasePilot functionality for fast automatic base configuration.



The Base Point List can be exported, imported and deleted via the Import/Export/Delete submenu (refer to "Import / Export of data").







When using BasePilot, always check in the Position submenu that the SmartAntenna has selected the correct base point! **Using the wrong base point can lead to an error of more than 20 m for a rover!**

BasePilot setup

BasePilot is a feature which configures and starts the SmartAntenna running as a base when the SmartAntenna is setup over a known point. Predefined base configurations are automatical loaded without the need of a controller.

Step	Description
1.	Position the iCON gps 60 over a known base point.

Step	Description
2.	<p>Choose correct SmartAntenna mode:</p> <ul style="list-style-type: none"> • If iCON gps 60 is in base mode: <ul style="list-style-type: none"> - BasePilot starts up automatically. • If iCON gps 60 is in rover mode: <ul style="list-style-type: none"> - Go to Settings\Tools\Base Setup and choose Find Nearest and confirm selection with  key (refer also to "Function: Find Nearest step-by-step").
3.	<p>While BasePilot is setting up: The position icon  is displayed.</p> <p> On RTK Mode page, in the Position submenu the line BasePilot shows: Setting up.</p>
4.	<p>After the BasePilot has been completed: The position icon  is displayed. The radio/modem now starts transmitting corrections!</p> <p> On RTK Mode page, in the Position submenu the line BasePilot shows: Successful.</p>



When using BasePilot, always check in the Position submenu that the SmartAntenna has selected the correct base point! **Using the wrong base point can lead to an error of more than 20 m for a rover!**

Base setup

The instrument can be manually set up as a stand-alone base station without a controller. This can be done in three different ways using the Base Setup wizard. The wizard is accessible via **Settings>Tools>Base Setup**.

The first screen (**Position**) provides 3 functions to enter the position of the base point:

- **Get Here:**
Instrument determines position and **uses current position as a new base point**.
 - **Edit:**
Manual input of coordinates to **generate a new base point**.
 - **Find Nearest:**
Searches through the **Base Point List for a known base point** within a radius of 20 m of the current instrument position.
-

4.1.1

Base Setup Functions

Additional screens for all functions



At the end of all base setup functions the **Base Setup** wizard continues with a common set of configuration screens:

- **Communication:**
To configure parameters for communication with other devices.
 - **Antenna:**
To set Antenna **Type**, **Height** and **Measurement Method**.
 - **Confirmation:**
To save the current configuration to the Base Point List. Subsequently, the instrument will start transmitting.
-

Function: Get Here step-by-step

The **Get Here** function determines the current coordinates of the instrument and uses this position as the base point.

Step	Description
1.	Position the iCON gps 60 where the base point should be set up.
2.	Highlight Modify in the Position screen and confirm selection with  key.



Step	Description
3.	Select Get Here and confirm selection with  key.
4.	Optional for external antennas: Set the correct Antenna Type , Height and Measurement Method in the antenna screen.
5.	When ready to determine the current position, confirm with Continue .
6.	The instrument measures the current position. Subsequently it searches the Base Point List for stored base points in the vicinity.
7.	If no point is found within a 40m radius of the measured position <ul style="list-style-type: none"> • use measured position If there is already a point within a 40m radius of the measured point <ul style="list-style-type: none"> • use known point (use existing) OR • use measured position (overwrite)
8.	In case the existing point has been chosen, either the saved setup can be chosen OR the current setup.
9.	Back in the Position screen: Enter a Point ID in the Position screen and confirm with  key.
10.	Press right navigation key to continue with the Communication setup screen e.g. to establish a connection via radio.



When using BasePilot, always check in the Position submenu that the SmartAntenna has selected the correct base point! **Using the wrong base point can lead to an error of more than 20 m for a rover!**

Function: Edit step-by-step

The **Edit** function can be used to enter a set of coordinates manually.

Step	Description
1.	Position the iCON gps 60 where the base point should be set up.
2.	Select Modify and confirm selection with  key.
3.	Select Edit and confirm selection with  key.
4.	Enter the Point ID and a set of coordinates . Select and press Continue key.
5.	The instrument searches within the Base Point List for stored base points in the vicinity.
6.	Back in the Position screen, re-check the selected base point information. Use the manually entered base point OR choose a base point from the Base Point List if available.



Step	Description
7.	Press right navigation key to continue with the Communication setup screen e.g. to establish a connection via radio.
8.	In case the existing point has been chosen, either the saved setup can be chosen OR the current setup.



When using BasePilot, always check in the Position submenu that the SmartAntenna has selected the correct base point! **Using the wrong base point can lead to an error of more than 20 m for a rover!**

Function: Find Nearest step-by-step

The **Find Nearest** function searches through the Base Point List for base points in the vicinity.

Step	Description
1.	Position the iCON gps 60 where the base point should be set up.
2.	Select Modify and press  key.
3.	Select Find Nearest and confirm selection with  key.

Step	Description
4.	The instrument searches within the Base Point List for stored base points within a 20 m radius. The closest base point is selected automatically.
5.	Choose communication configuration: <ul style="list-style-type: none">• re-use configuration of found base point (saved setup) OR• define new configuration / use currently active configuration
6.	Back in the Position screen, re-check the selected base point information.
7.	Press right navigation key to continue with the Communication setup screen e.g. to establish a connection via radio.



When using BasePilot, always check in the Position submenu that the SmartAntenna has selected the correct base point! **Using the wrong base point can lead to an error of more than 20 m for a rover!**

No stored positions nearby

If no base point in the Base Point List is close to the current instrument position an information message shows up:

 Information <hr/> <p>There are no stored positions nearby!</p> <p>Continue</p>	<p>If this screen appears:</p> <ul style="list-style-type: none">• Choose Continue• Use Input or Get Here function to set up the base instead
--	---

4.1.2

Raw Data Logging

Raw Data logging

To log RINEX data the instrument must be configured for Raw Data logging. The settings are accessible via **Settings>Tools>Raw Data logging**.



RINEX is used for post processing when high accurate coordinates are required.

Import / Export of data

Import and export of data can be performed via the **Settings>Tools>Import/Export of data** menu with a USB flash drive as external storage device.

Import options from a USB flash drive to the instrument:

Import from USB	Description
Base Point List	imports a list of base points
Antenna List	imports a list of external antennas
Welcome Screen	imports a customisable welcome screen (e.g. a company logo)
System Configuration	overwrites the current system configuration (e.g. with a configuration backup from a file)

Export options from the instrument to a USB flash drive:

Export to USB	Description
Base Point List	exports a list of stored base points
System Configuration	makes a backup of the current system configuration (e.g. to restore or to share settings to other instruments)
Error Log File	instrument related error messages are stored in the log file and can be exported

Data delete options of the instrument:

Delete on ICON GPS 60	Description
Base Point List	deletes the list of stored base points
Antenna List	resets the list of external antennas to default values
Welcome Screen	deletes the customised welcome screen
Error Log File	removes all entries from the Error Log File

Raw Data logging

To log RINEX data the instrument must be configured for Raw Data logging. The settings are accessible via **Settings>Tools>Raw Data logging**.



RINEX is used for post processing when high accurate coordinates are required.

4.2

Licensing

Licence Status

In the Licence menu licenses can be uploaded, entered or deleted. The settings are accessible via **Settings>Tools>Licences**.

5 Setups with Controller and Accessories

5.1 Real-Time Base Setup

Real-time refer-
ence setup with
internal modem

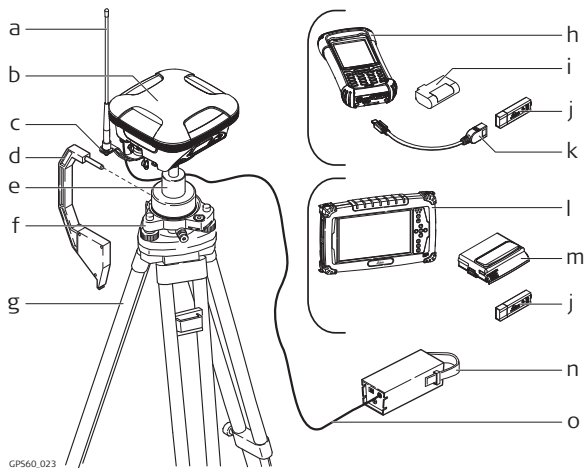

- | | |
|--------------------------|---|
| a) Radio antenna | i) Battery for CC50 field controller |
| b) iCON gps 60 antenna | j) USB flash drive |
| c) GAD108 | k) Mini-USB to USB cable |
| d) Height hook | l) CC60/CC61 field controller |
| e) GRT146 | m) Battery for CC60/CC61 field controller |
| f) Tribrach | n) GEB171 external battery |
| g) Tripod | o) GEV219 power cable |
| h) CC50 field controller | |

Real-time reference setup step-by-step

Step	Description
1.	Setting Up the Equipment
	• Set up the tripod, mount and level the tribrach onto the tripod.
	• Check that the tribrach is correctly centred over the marker.
	• Place and lock the carrier into the tribrach.
	• Screw the iCON gps 60 antenna onto the carrier.
	• Check that the tribrach is still correctly positioned and levelled.
	• Hang the external battery onto a tripod leg.
	• Take the GEV219.
• Attach the 8 pin plug connector to the iCON gps 60 antenna.	

Step	Description
	<ul style="list-style-type: none"><li data-bbox="474 184 1202 215">• Attach the 5 pin plug connector to the external battery.<li data-bbox="474 225 1035 256">• Insert the battery into the field controller.<li data-bbox="474 267 1006 298">• Turn on the antenna and the controller.
2.	Run the Reference Setup application of the iCON Site software <ul style="list-style-type: none"><li data-bbox="474 368 1212 399">• See iCON Site software manual on for more information.

5.2

Base Station with MNA1202

Base Station setup with external GNSS Antenna

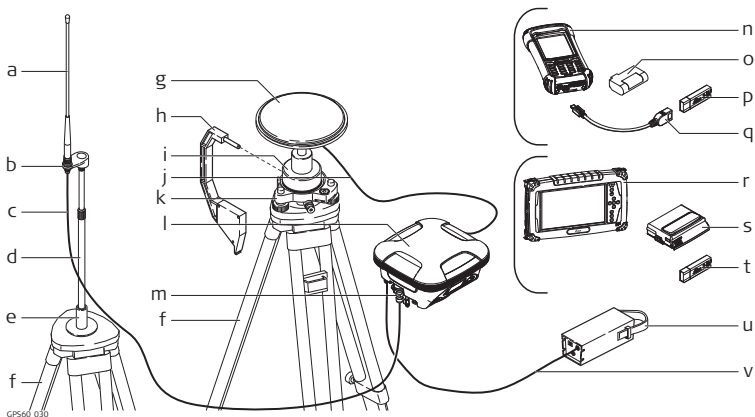

- | | |
|------------------------------------|---|
| a) Radio antenna | m) GAD109 QN/TNC adapter |
| b) GAD34 arm, 3 cm | n) CC50 field controller |
| c) GEV120 antenna cable | o) Battery for CC50 field controller |
| d) GAD32 telescopic rod | p) USB flash drive |
| e) GHT36 - base for telescopic rod | q) Mini-USB to USB cable |
| f) Tripod | r) CC60/CC61 field controller |
| g) MNA1202 GG antenna | s) Battery for CC60/CC61 field controller |
| h) Height hook | t) USB flash drive |
| i) GRT146 carrier | u) GEB171 external battery |
| j) GEV120 antenna cable | v) GEV219 power cable |
| k) Tribrach | |
| l) iCON gps 60 SmartAntenna | |

External GNSS antenna setup step-by-step

Step	Description
1.	Setting Up the MNA1202 GG and radio antenna:
	• Set up both tripods.
	• Mount and level the tribrach onto the tripod for the MNA1202 GG.
	• Check that the tribrach is correctly centred over the marker.
	• Place and lock the carrier into the tribrach.
	• Screw the MNA1202 GG antenna onto the carrier.

Step	Description
	<ul style="list-style-type: none"> • Check that the tribrach is still correctly positioned and levelled.
	<ul style="list-style-type: none"> • Mount the GHT36 on the 2nd tripod. Attach the telescopic rod and the GAD34 arm.
	<ul style="list-style-type: none"> • Screw the radio antenna onto the GAD34 arm.

Step	Description
2.	Setting Up the iCON gps 60:
	<ul style="list-style-type: none"> • Place the iCON gps 60 SmartAntenna e.g. in a container.
	<ul style="list-style-type: none"> • Attach the QN/TNC adapter to the QN port.
	<ul style="list-style-type: none"> • Connect the TNC cable to the QN/TNC adapter of the SmartAntenna and the GAD34 at the radio antenna.
	<ul style="list-style-type: none"> • Connect a second TNC cable to the SmartAntenna and the MNA1202 GG antenna.

Step	Description
	<ul style="list-style-type: none">Connect the iCON gps 60 via the 8-pin socket to an external power source.<ul style="list-style-type: none">Use the GEV219 cable to connect the external battery GEB171 using the 5-pin socket. <p>OR</p> <ul style="list-style-type: none">Use the GEV71 cable to connect i.e. a car battery with the free wire ends.
	<ul style="list-style-type: none">Insert the battery into the field controller.
	<ul style="list-style-type: none">Turn on the antenna and the controller.

Step	Description
3.	Run the Reference Setup application of the iCON Site software <ul style="list-style-type: none">See iCON Site software manual on for more information.



Connecting the GEV71 cable to an external power source (i.e. car battery) needs expert knowledge.

5.3

Real-Time Base with Raw Data Logging

Real-time reference setup for raw data logging

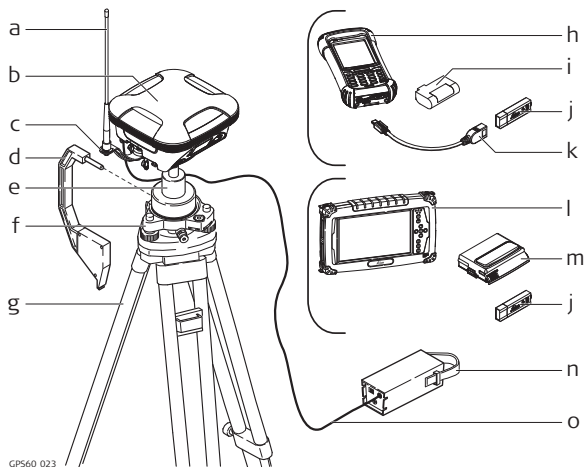

- | | |
|--------------------------|---|
| a) Radio antenna | i) Battery for CC50 field controller |
| b) iCON gps 60 antenna | j) USB flash drive |
| c) GAD108 | k) Mini-USB to USB cable |
| d) Height hook | l) CC60/CC61 field controller |
| e) GRT146 | m) Battery for CC60/CC61 field controller |
| f) Tribrach | n) GEB171 external battery |
| g) Tripod | o) GEV219 power cable |
| h) CC50 field controller | |

Real-time reference setup for raw data logging step-by-step

Step	Description
1.	Setting Up the Equipment
	• Set up the tripod, mount and level the tribrach onto the tripod.
	• Check that the tribrach is correctly centred over the marker.
	• Place and lock the carrier into the tribrach.
	• Screw the iCON gps 60 antenna onto the carrier.
	• Check that the tribrach is still correctly positioned and levelled.
	• Hang the external batteries onto the tripod legs.
	• Take the GEV219 cable.
	• Attach the connector with the 8 pin plug to the iCON gps 60 antenna.

Step	Description
	<ul style="list-style-type: none">• Attach the connector with the 5 pin plug to the external battery.• Turn on the antenna and the controller.
2.	Configuring the Raw Data Logging
	<ul style="list-style-type: none">• Refer to "Raw Data logging".
3.	Run iCON Site Base Setup application
	<ul style="list-style-type: none">• See iCON Site software manual for more information.

5.4 Raw Data Logging Setup

Raw data logging setup for post-processing

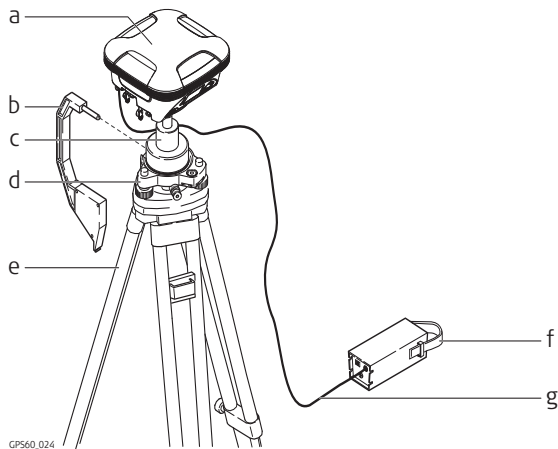

- a) iCON gps 60 antenna
- b) Height hook
- c) GRT146
- d) Tribrach
- e) Tripod
- f) GEB171 external battery
- g) GEV219 power cable

**Raw data logging
setup
step-by-step**

Step	Description	
1.	Setting Up the Equipment	
	<ul style="list-style-type: none"> • Set up the tripod, mount and level the tribrach onto the tripod. 	
	<ul style="list-style-type: none"> • Check that the tribrach is correctly centred over the marker. 	
	<ul style="list-style-type: none"> • Place and lock the carrier into the tribrach. 	
	<ul style="list-style-type: none"> • Screw iCON gps 60 antenna onto the carrier. 	
	<ul style="list-style-type: none"> • Check that the tribrach is still correctly positioned and levelled. 	
	If available:	Else:
	<ul style="list-style-type: none"> • Hang the external battery onto a tripod leg. • Take the GEV219. • Attach the connectors with the 8 pin plug to iCON gps 60 antenna. 	<ul style="list-style-type: none"> • Use internal batterie of the antenna without battery cabling.

Step	Description
	<ul style="list-style-type: none"><li data-bbox="460 179 914 288">• Attach the connector with the 5 pin plug to the external battery.<li data-bbox="460 288 1373 336">• Turn on the antenna.
2.	Configuring the Raw Data Logging <ul style="list-style-type: none"><li data-bbox="460 386 914 426">• Refer to "Raw Data logging".

5.5 Real-Time Rover Setup

Use

The following equipment setups are to be used for real-time rover with extended periods of use in the field.

Real-time rover setup with CC60/CC61

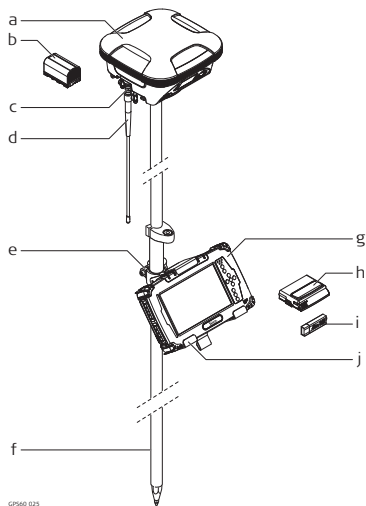

GPS60_025

- a) iCON gps 60 antenna
- b) GEB221 battery
- c) GAD109 QN/TNC adapter
- d) Radio antenna
- e) Pole clamp
- f) Pole
- g) CC60/CC61 field controller
- h) Battery for CC60/CC61 field controller
- i) USB flash drive
- j) Holder for CC60/CC61 field controller

Real-time rover setup with CC50

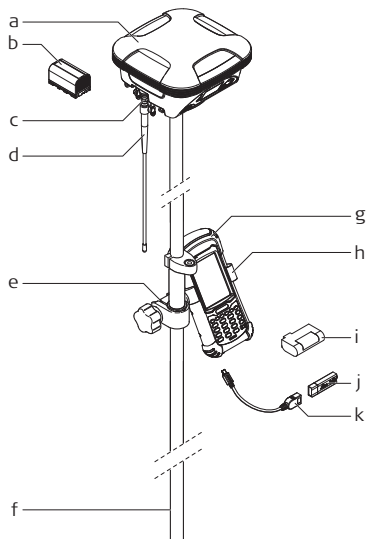

- a) iCON gps 60 antenna
- b) GEB221 battery
- c) GAD109 QN/TNC adapter
- d) Radio antenna
- e) Pole clamp
- f) Pole
- g) CC50 field controller
- h) Holder for CC50 field controller
- i) Battery for CC50 field controller
- j) USB flash drive
- k) Mini-USB to USB cable

**Real-time rover
setup
step-by-step**

Step	Description
1.	<p data-bbox="474 153 821 184">Setting Up the Equipment</p> <ul data-bbox="474 205 1373 800" style="list-style-type: none"><li data-bbox="474 205 1115 236">• Insert the battery into the iCON gps 60 antenna.<li data-bbox="474 246 1304 277">• Screw iCON gps 60 antenna onto the top of the telescopic pole.<li data-bbox="474 288 1122 319">• Ensure that the compression lock is not clamped.<li data-bbox="474 329 1373 438">• Extend the telescopic pole and ensure that the snap-lock clicks into its position. The snap-lock ensures that there is no slipping of the telescopic pole.<li data-bbox="474 448 1373 510">• Clamp the compression lock. The compression lock maintains straightness.<li data-bbox="474 521 1373 660">• Fix the holder to the clamp with the tightening screw. Before tightening, ensure that the holder is at a comfortable working height and angle. This can be achieved by sliding the clamp along the pole and rotating the holder about the clamp. Tighten the tightening screw.<li data-bbox="474 671 1035 702">• Insert the battery into the field controller.<li data-bbox="474 712 1275 743">• Clip the field controller onto the holder and lock into position.<li data-bbox="474 754 1006 785">• Turn on the antenna and the controller.

Step	Description
2.	Run the data collection or stake-out application of the iCON Site software
	<ul style="list-style-type: none">• See iCON Site software manual on for more information.

5.6

Establish Bluetooth Data Connection

Bluetooth connection setup

Activate the internal Bluetooth module of the iCON gps 60. See "Bluetooth Menu".

 Follow the instructions of the controller user manual about how establish a Bluetooth connection.

6

Care and Transport

6.1

Transport

Transport in the field

When transporting the equipment in the field, always make sure that you

- either carry the product in its original transport container,
 - or carry the tripod with its legs splayed across your shoulder, keeping the attached product upright.
-

Transport in a road vehicle

Never carry the product loose in a road vehicle, as it can be affected by shock and vibration. Always carry the product in its transport container and secure it.

Shipping

When transporting the product by rail, air or sea, always use the complete original Leica Geosystems packaging, transport container and cardboard box, or its equivalent, to protect against shock and vibration.

Shipping, transport of batteries

When transporting or shipping batteries, the person in charge of the product must ensure that the applicable national and international rules and regulations are observed. Before transportation or shipping, contact your local passenger or freight transport company.

6.2

Storage

Product

Respect the temperature limits when storing the equipment, particularly in summer if the equipment is inside a vehicle. Refer to " Environmental specifications" for information about temperature limits.

Li-Ion batteries

- Refer to " Internal battery" for information about storage temperature range.
 - At the recommended storage temperature range, batteries containing a 10% to 50% charge can be stored for up to one year. After this storage period the batteries must be recharged.
 - Remove batteries from the product and the charger before storing.
 - After storage recharge batteries before using.
 - Protect batteries from damp and wetness. Wet or damp batteries must be dried before storing or use.
 - A storage temperature range of -20°C to +30°C/-4°F to 86°F in a dry environment is recommended to minimise self-discharging of the battery.
-

6.3

Cleaning and Drying

Product and accessories

- Use only a clean, soft, lint-free cloth for cleaning. If necessary, moisten the cloth with water or pure alcohol. Do not use other liquids; these may attack the polymer components.
-

Damp products

Dry the product, the transport container, the foam inserts and the accessories at a temperature not greater than 40°C/104°F and clean them. Do not repack until everything is dry. Always close the transport container when using in the field.

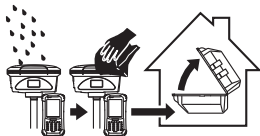

Cables and plugs

Keep plugs clean and dry. Blow away any dirt lodged in the plugs of the connecting cables.

Connectors with dust caps

Wet connectors must be dry before attaching the dust cap.

7 Safety Directions

7.1 General Introduction

Description

The following directions enable the person responsible for the product, and the person who actually uses the equipment, to anticipate and avoid operational hazards.

The person responsible for the product must ensure that all users understand these directions and adhere to them.

7.2

Definition of Use

Intended use

- Computing with software.
 - Carrying out measurement tasks using various GNSS measuring techniques.
 - Recording GNSS and point related data.
 - Remote control of product.
 - Data communication with external appliances.
 - Measuring raw data and computing coordinates using carrier phase and code signal from GNSS satellites.
-

Adverse use

- Use of the product without instruction.
- Use outside of the intended limits.
- Disabling safety systems.
- Removal of hazard notices.
- Opening the product using tools, for example screwdriver, unless this is permitted for certain functions.
- Modification or conversion of the product.
- Use after misappropriation.
- Use of products with recognisable damages or defects.
- Use with accessories from other manufacturers without the prior explicit approval of Leica Geosystems.
- Inadequate safeguards at the working site, for example when measuring on roads.
- Controlling of machines, moving objects or similar monitoring application without additional control- and safety installations.

**WARNING**

Adverse use can lead to injury, malfunction and damage.

It is the task of the person responsible for the equipment to inform the user about hazards and how to counteract them. The product is not to be operated until the user has been instructed on how to work with it.

7.3

Limits of Use

Environment

Suitable for use in an atmosphere appropriate for permanent human habitation: not suitable for use in aggressive or explosive environments.



DANGER

Local safety authorities and safety experts must be contacted before working in hazardous areas, or close to electrical installations or similar situations by the person in charge of the product.

7.4

Responsibilities

Manufacturer of the product

Leica Geosystems AG, CH-9435 Heerbrugg, hereinafter referred to as Leica Geosystems, is responsible for supplying the product, including the user manual and original accessories, in a safe condition.

Manufacturers of non Leica Geosystems accessories

The manufacturers of non Leica Geosystems accessories for the product are responsible for developing, implementing and communicating safety concepts for their products, and are also responsible for the effectiveness of those safety concepts in combination with the Leica Geosystems product.

Person in charge of the product

The person in charge of the product has the following duties:

- To understand the safety instructions on the product and the instructions in the user manual.
 - To be familiar with local regulations relating to safety and accident prevention.
 - To inform Leica Geosystems immediately if the product and the application becomes unsafe.
 - To ensure that the national laws, regulations and conditions for the operation of radio transmitters are respected.
-



WARNING

The person responsible for the product must ensure that it is used in accordance with the instructions. This person is also accountable for the training and the deployment of personnel who use the product and for the safety of the equipment in use.

7.5

Hazards of Use



WARNING

The absence of instruction, or the inadequate imparting of instruction, can lead to incorrect or adverse use, and can cause accidents with far-reaching human, material, financial and environmental consequences.

Precautions:

All users must follow the safety directions given by the manufacturer and the directions of the person responsible for the product.



CAUTION

Watch out for erroneous measurement results if the product has been dropped or has been misused, modified, stored for long periods or transported.

Precautions:

Periodically carry out test measurements and perform the field adjustments indicated in the user manual, particularly after the product has been subjected to abnormal use and before and after important measurements.

DANGER

Because of the risk of electrocution, it is dangerous to use poles and extensions in the vicinity of electrical installations such as power cables or electrical railways.

Precautions:

Keep at a safe distance from electrical installations. If it is essential to work in this environment, first contact the safety authorities responsible for the electrical installations and follow their instructions.

**CAUTION**

With the remote control of products, it is possible that extraneous targets will be picked out and measured.

Precautions:

When measuring in remote control mode, always check your results for plausibility.

WARNING

During dynamic applications, for example stakeout procedures there is a danger of accidents occurring if the user does not pay attention to the environmental conditions around, for example obstacles, excavations or traffic.

Precautions:

The person responsible for the product must make all users fully aware of the existing dangers.

 **WARNING**

Inadequate securing of the working site can lead to dangerous situations, for example in traffic, on building sites, and at industrial installations.

Precautions:

Always ensure that the working site is adequately secured. Adhere to the regulations governing safety and accident prevention and road traffic.

 **WARNING**

If computers intended for use indoors are used in the field there is a danger of electric shock.

Precautions:

Adhere to the instructions given by the computer manufacturer regarding field use with Leica Geosystems products.

 **CAUTION**

If the accessories used with the product are not properly secured and the product is subjected to mechanical shock, for example blows or falling, the product may be damaged or people can sustain injury.

Precautions:

When setting-up the product, make sure that the accessories are correctly adapted, fitted, secured, and locked in position.

Avoid subjecting the product to mechanical stress.

**WARNING**

If the product is used with accessories, for example masts, staffs, poles, you may increase the risk of being struck by lightning.

Precautions:

Do not use the product in a thunderstorm.

**DANGER**

If the product is used with accessories, for example on masts, staffs, poles, you may increase the risk of being struck by lightning. Danger from high voltages also exists near power lines. Lightning, voltage peaks, or the touching of power lines can cause damage, injury and death.

Precautions:

- Do not use the product in a thunderstorm as you can increase the risk of being struck by lightning.
- Be sure to remain at a safe distance from electrical installations. Do not use the product directly under or close to power lines. If it is essential to work in such an environment contact the safety authorities responsible for electrical installations and follow their instructions.
- If the product has to be permanently mounted in an exposed location, it is advisable to provide a lightning conductor system. A suggestion on how to design a lightning conductor for the product is given below. Always follow the regulations in force in your country regarding grounding antennas and masts. These installations must be carried out by an authorised specialist.
- To prevent damages due to indirect lightning strikes (voltage spikes) cables, for example for antenna, power source or modem should be protected with appro-

appropriate protection elements, like a lightning arrester. These installations must be carried out by an authorised specialist.

- If there is a risk of a thunderstorm, or if the equipment is to remain unused and unattended for a long period, protect your product additionally by unplugging all systems components and disconnecting all connecting cables and supply cables, for example, instrument - antenna.

Lightning conductors

Suggestion for design of a lightning conductor for a GNSS system:

1) On non-metallic structures

Protection by air terminals is recommended. An air terminal is a pointed solid or tubular rod of conducting material with proper mounting and connection to a conductor. The position of four air terminals can be uniformly distributed around the antenna at a distance equal to the height of the air terminal.

The air terminal diameter should be 12 mm for copper or 15 mm for aluminium. The height of the air terminals should be 25 cm to 50 cm. All air terminals should be connected to the down conductors. The diameter of the air terminal should be kept to a minimum to reduce GNSS signal shading.

2) On metallic structures

Protection is as described for non-metallic structures, but the air terminals can be connected directly to the conducting structure without the need for down conductors.

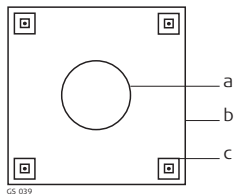
Air terminal arrangement, plan view

- a) Antenna
- b) Support structure
- c) Air terminal

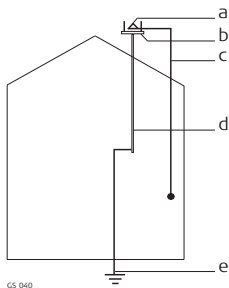
Grounding the instrument/antenna

- a) Antenna
- b) Lightning conductor array
- c) Antenna/instrument connection
- d) Metallic mast
- e) Connection to earth

 **WARNING** Using a battery charger not recommended by Leica Geosystems can destroy the batteries. This can cause fire or explosions.

Precautions:

Only use chargers recommended by Leica Geosystems to charge the batteries.

 **CAUTION** During the transport, shipping or disposal of batteries it is possible for inappropriate mechanical influences to constitute a fire hazard.

Precautions:

Before shipping the product or disposing of it, discharge the batteries by running the product until they are flat.

When transporting or shipping batteries, the person in charge of the product must ensure that the applicable national and international rules and regulations are observed. Before transportation or shipping contact your local passenger or freight transport company.

 **WARNING** High mechanical stress, high ambient temperatures or immersion into fluids can cause leakage, fire or explosions of the batteries.

Precautions:

Protect the batteries from mechanical influences and high ambient temperatures. Do not drop or immerse batteries into fluids.

**WARNING**

If battery terminals come in contact with jewellery, keys, metallised paper or other metals, short circuited battery terminals can overheat and cause injury or fire, for example by storing or transporting in pockets.

Precautions:

Make sure that the battery terminals do not come into contact with metallic objects.

**WARNING**

Incorrect fastening of the external antenna to vehicles or transporters poses the risk of the equipment being broken by mechanical influence, vibration or airstream. This may result in accident and physical injury.

Precautions:

Attach the external antenna professionally. The external antenna must be secured additionally, for example by use of a safety cord. Ensure that the mounting device is correctly mounted and able to carry the weight of the external antenna (>1 kg) safely.

**WARNING**

If the product is improperly disposed of, the following can happen:

- If polymer parts are burnt, poisonous gases are produced which may impair health.
- If batteries are damaged or are heated strongly, they can explode and cause poisoning, burning, corrosion or environmental contamination.
- By disposing of the product irresponsibly you may enable unauthorised persons to use it in contravention of the regulations, exposing themselves and third parties to the risk of severe injury and rendering the environment liable to contamination.

Precautions:

The product must not be disposed with household waste.
Dispose of the product appropriately in accordance with the national regulations in force in your country.
Always prevent access to the product by unauthorised personnel.

Product-specific treatment and waste management information can be downloaded from the Leica Geosystems home page at <http://www.leica-geosystems.com/treatment> or received from your Leica Geosystems dealer.

**WARNING**

Only Leica Geosystems authorised service workshops are entitled to repair these products.

7.6 Electromagnetic Compatibility EMC

Description

The term Electromagnetic Compatibility is taken to mean the capability of the product to function smoothly in an environment where electromagnetic radiation and electrostatic discharges are present, and without causing electromagnetic disturbances to other equipment.



WARNING

Electromagnetic radiation can cause disturbances in other equipment.

Although the product meets the strict regulations and standards which are in force in this respect, Leica Geosystems cannot completely exclude the possibility that other equipment may be disturbed.



CAUTION

There is a risk that disturbances may be caused in other equipment if the product is used with accessories from other manufacturers, for example field computers, personal computers, two-way radios, non-standard cables or external batteries.

Precautions:

Use only the equipment and accessories recommended by Leica Geosystems. When combined with the product, they meet the strict requirements stipulated by the guidelines and standards. When using computers and two-way radios, pay attention to the information about electromagnetic compatibility provided by the manufacturer.

 **CAUTION**

Disturbances caused by electromagnetic radiation can result in erroneous measurements.

Although the product meets the strict regulations and standards which are in force in this respect, Leica Geosystems cannot completely exclude the possibility that the product may be disturbed by intense electromagnetic radiation, for example, near radio transmitters, two-way radios or diesel generators.

Precautions:

Check the plausibility of results obtained under these conditions.

 **WARNING**

If the product is operated with connecting cables attached at only one of their two ends, for example external supply cables, interface cables, the permitted level of electromagnetic radiation may be exceeded and the correct functioning of other products may be impaired.

Precautions:

While the product is in use, connecting cables, for example product to external battery, product to computer, must be connected at both ends.

**Radios or digital
cellular phones**



WARNING

Use of product with radio or digital cellular phone devices:

Electromagnetic fields can cause disturbances in other equipment, in installations, in medical devices, for example pacemakers or hearing aids and in aircraft. It can also affect humans and animals.

Precautions:

Although the product meets the strict regulations and standards which are in force in this respect, Leica Geosystems cannot completely exclude the possibility that other equipment can be disturbed or that humans or animals can be affected.

- Do not operate the product with radio or digital cellular phone devices in the vicinity of filling stations or chemical installations, or in other areas where an explosion hazard exists.
 - Do not operate the product with radio or digital cellular phone devices near to medical equipment.
 - Do not operate the product with radio or digital cellular phone devices in aircraft.
-

7.7

FCC Statement, Applicable in U.S.



WARNING

The greyed paragraph below is only applicable for products without radio.

This equipment has been tested and found to comply with the limits for a Class B digital device, pursuant to part 15 of the FCC rules.

These limits are designed to provide reasonable protection against harmful interference in a residential installation.

This equipment generates, uses and can radiate radio frequency energy and, if not installed and used in accordance with the instructions, may cause harmful interference to radio communications. However, there is no guarantee that interference will not occur in a particular installation.

If this equipment does cause harmful interference to radio or television reception, which can be determined by turning the equipment off and on, the user is encouraged to try to correct the interference by one or more of the following measures:

- Reorient or relocate the receiving antenna.
 - Increase the separation between the equipment and the receiver.
 - Connect the equipment into an outlet on a circuit different from that to which the receiver is connected.
 - Consult the dealer or an experienced radio/TV technician for help.
-

⚠ WARNING

Changes or modifications not expressly approved by Leica Geosystems for compliance could void the user's authority to operate the equipment.

Labelling iCON gps 60

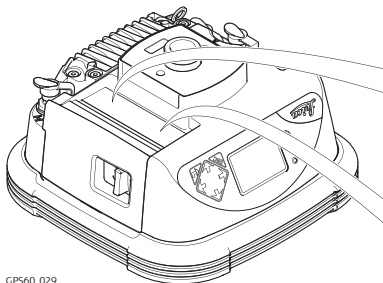

GPS60_029

Type: ICG60
 Equip. No.:
 S.No.:
 Art.No.:
 Power: 12V nominal/0.5A max.
 Leica Geosystems AG
 CH-9435 Heerbrugg
 Manufactured 2010
 Made in Switzerland

IC: 3177A-ICG6x
Contains transmitter module:
 FCC-ID: HFD-ICG6x
 Bluetooth QD ID: B010093

CE 0681

This device complies with part 15 of the FCC Rules. Operation is subject to the following two conditions:
 (1) This device may not cause harmful interference, and
 (2) this device must accept any interference received, including interference that may cause undesired operation.



Labelling internal battery GEB221, GEB222

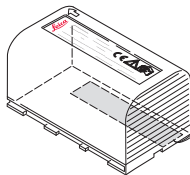

GEB_002

This device complies with part 15 of the FCC Rules. Operation is subject to the following two conditions: (1) This device may not cause harmful interference, and (2) this device must accept any interference received, including interference that may cause undesired operation.



8

Technical Data

8.1

Technical Data iCON gps 60 Antenna

Dimensions

The overall dimensions are given for the housing including the sockets.

Type	Length [mm]	Width [mm]	Thickness [mm]
iCON gps 60	197	197	130

Weight

Instrument weight without battery:

Type	Weight [kg]/[lbs]
iCON gps 60	1.45/3.20 (including internal HSPA modem)



The internal modem is installed by default.

Recording

Data (Leica GNSS raw data and RINEX data) can be recorded on the internal memory.

Capacity [MB]	Data capacity
<ul style="list-style-type: none"> 466 	<p>466 MB is typically sufficient for about GPS only (12 satellites)</p> <ul style="list-style-type: none"> 3600 h L1 + L2 + L5 data logging at 15 s rate 14000 h L1 + L2 + L5 data logging at 60 s rate <p>GPS + GLONASS (12/8 satellites)</p> <ul style="list-style-type: none"> 3100 h data logging at 15 s rate 12300 h data logging at 60 s rate <p>GPS + GLONASS + Galileo (12/8/10 satellites)</p> <ul style="list-style-type: none"> 1400 h data logging at 15 s rate 5800 h data logging at 60 s rate

Power

Power consumption: iCON gps 60, radio excluded: 6 W typically, 500 mA
 External supply voltage: Nominal 12 V DC (—, GEV71 car battery cable to a 12 V car battery), voltage range 9 V-28 V DC

Internal battery

Type: Li-Ion
 Voltage: 7.4 V
 Capacity: GEB221: 4.4 Ah

Battery external

Type:	NiMH
Voltage:	12 V
Capacity:	GEB171: 9.0 Ah

Operating times

The given operating times are valid for

- iCON gps 60: fully charged GEB221 battery.
- room temperature. Operating times will be shorter when working in cold weather.

Equipment			Operating time
Type	Radio	Digital cellular phone	
Static (iCON gps 60)	-	-	6 h continuously
Rover (iCON gps 60)	SATELLINE M3-TR1, receive (CCD7)	-	5 h continuously
Rover (iCON gps 60)	-	built-in HSPA Modem	4.75 h continuously

Electrical data

Type	iCON gps 60
Voltage	-
Current	-
Frequency	GPS L1 1575.42 MHz GPS L2 1227.60 MHz GPS L5 1176.45 MHz GLONASS L1 1602.5625 MHz-1611.5 MHz GLONASS L2 1246.4375 MHz-1254.3 MHz Galileo E1 1575.42 MHz Galileo E5a 1176.45 MHz Galileo E5b 1207.14 MHz Galileo Alt-BOC 1191.795 MHz
Gain	Typically 27 dBi
Noise Figure	Typically < 2 dBi



Galileo Alt-BOC covers bandwidth of Galileo E5a and E5b.

Environmental specifications

Temperature

Type	Operating temperature [°C]	Storage temperature [°C]
Instrument	-40 to +60	-40 to +80
UHF Tx 0.5 W	-30 to +55	-40 to +80
Battery internal	-20 to +55	-40 to +70

Protection against water, dust and sand

Type	Protection
Instrument	IP67 (IEC 60529) Dust tight Waterproof to 1 m temporary immersion

Humidity

Type	Protection
Instrument	Up to 100 % The effects of condensation are to be effectively counteracted by periodically drying out the instrument.

8.1.1 Tracking Characteristics

Instrument technology

SmartTrack+

Satellite reception

Triple frequency

Instrument channels and satellite tracking

iCON gps 60:

- Up to 16 satellites in continuous tracking on L1, L2 and L5 (GPS).
- Up to 14 satellites in continuous tracking on L1 and L2 (GLONASS).
- Up to 14 satellites in continuous tracking on E1, E5a, E5b and Alt-BOC (Galileo).
- Four satellites when tracking SBAS (EGNOS, WAAS, MSAS, GAGAN).



Depending on the satellite systems and signals configured, a maximum number of 120 channels is allocated.

Supported codes and phases

GPS

Type	L1	L2	L5
iCON gps 60	Carrier phase, C/A-code	Carrier phase, C code (L2C) and P2-code	Carrier phase, code

GLONASS

Type	L1	L2
iCON gps 60	Carrier phase, C/A-code	Carrier phase, P2-code

Galileo

Type	E1	E5a	E5b	Alt-BOC
iCON gps 60	Carrier phase, code	Carrier phase, code	Carrier phase, code	Carrier phase, code



Carrier phase and code measurements on L1, L2 and L5 (GPS) are fully independent with AS on or off.

Satellites tracked

Up to 16 simultaneously on L1, L2 and L5 (GPS) + up to 14 simultaneously on L1 and L2 (GLONASS) + up to 14 simultaneously on E1, E5a, E5b and Alt-BOC (Galileo) + up to four SBAS (EGNOS, WAAS, MSAS, GAGAN)

8.1.2

Accuracy

Accuracy is dependent upon various factors including the number of satellites tracked, constellation geometry, observation time, ephemeris accuracy, ionospheric disturbance, multipath and resolved ambiguities.

The following accuracies, given as **root mean square**, are based on measurements processed using LGO and on real-time measurements.

The use of multiple GNSS systems can increase accuracy by up to 30% relative to GPS only.

Differential code

The baseline precision of a differential code solution for static and kinematic surveys is 25 cm.

**Differential phase
in post-processing****Static and rapid static**

Static		Kinematic	
Horizontal	Vertical	Horizontal	Vertical
5 mm + 0.5 ppm	10 mm + 0.5 ppm	10 mm + 1 ppm	20 mm + 1 ppm

Static with long observations

Static		Kinematic	
Horizontal	Vertical	Horizontal	Vertical
3 mm + 0.5 ppm	6 mm + 0.5 ppm	10 mm + 1 ppm	20 mm + 1 ppm

Differential phase in real-time

Static		Kinematic	
Horizontal	Vertical	Horizontal	Vertical
5 mm + 0.5 ppm	10 mm + 0.5 ppm	10 mm + 1 ppm	20 mm + 1 ppm

8.2

Technical Data MNA1202 GG Antenna

Description and use

The GNSS antenna is selected for use based upon the application. The table gives a description and the intended use of the antenna.

Type	Description	Use
MNA1202 GG	GPS / GLONASS L1/L2 Smart-Track antenna with integrated baseplate.	Machine Control, RTK Base Station, RTK Rover and Network RTK applications.

Dimensions

Type	MNA1202 GG
Height	62 mm
Diameter	170 mm

Weight

MNA1202 GG 0.5 kg

Electrical data

Type	MNA1202 GG
Voltage	4.5 V to 18 V DC
Current	50 mA typical

Type	MNA1202 GG
Frequency	GPS: L1, L2 GLONASS: L1, L2
Gain	27 dBi
Noise Figure	< 2 dBi

Cable length

Separation distance from instrument ...	to antenna	Optional cable lengths [m]
iCON gps 60	MNA1202 GG	30

Connector

MNA1202 GG: TNC female

Mounting

MNA1202 GG: 5/8" Whitworth

Vibration/Shock

Type	MNA1202 GG
Vibration	8 - 500 Hz, ± 7.5 mm, 5 g
Shock	60 g, 6 ms

Environmental specifications**Temperature**

Type	Operating temperature [°C]	Storage temperature [°C]
MNA1202 GG	-40 to +70	-55 to +85

Protection against water, dust and sand

Type	Protection
MNA1202 GG	After IEC 60529: IP67 Dust tight Protected against water jets Waterproof to 1 m temporary immersion

Humidity

Type	Protection
MNA1202 GG	Up to 100 % The effects of condensation are to be effectively counteracted by periodically drying out the antenna.

8.3

Pin Assignments and Sockets

Expert knowledge required

Modification or adaption on base of the pin assignments and socket descriptions need expert knowledge.



WARNING

Changes or modifications not expressly approved by Leica Geosystems for compliance could void the user's authority to operate the equipment.

Port 1- Lemo

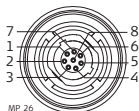

Pin	Name	Function	Direction
1	USB-	RS232, ready to send	Out
2	USB+	RS232, clear to send	In
3	GND	Ground	-
4	RxD	RS232, receive data	In
5	TxD	RS232, transmit data	Out
6	ID	Identification pin	In
7	PWR in	Power in 9-28VDC	In
8	+12V out	12V power supply out	Out

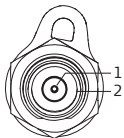
ANT

MP.25

Pin	Description
1	Antenna signal and antenna power
2	Shield/Ground

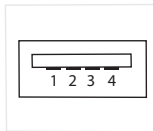
USB 2.0 host connector**Type: USB-A receptacle**

Pin	Name	Description	Direction
1	+5V	+5V Power supply	Out
2	D-	Data signal negative	In/Out
3	D+	Data signal positive	In/Out
4	GND	Power supply return and signals reference	In

Picture: Receptacle viewed from mating side.

8.4

Conformity Declarations

Conformity to national regulations

For products which do not fall under R&TTE directive:



Hereby, Leica Geosystems AG, declares that the product/s is/are in compliance with the essential requirements and other relevant provisions of the applicable European Directives. The declaration of conformity can be consulted at <http://www.leica-geosystems.com/ce>.

Conformity to national regulations

- FCC Part 15, 22 and 24 (applicable in US)
- Hereby, Leica Geosystems AG, declares that the product iCON gps 60 is in compliance with the essential requirements and other relevant provisions of Directive 1999/5/EC. The declaration of conformity can be consulted at <http://www.leica-geosystems.com/ce>.



Class 1 equipment according European Directive 1999/5/EC (R&TTE) can be placed on the market and be put into service without restrictions in any EEA member state.

- The conformity for countries with other national regulations not covered by the FCC part 15, 22 and 24 or European directive 1999/5/EC has to be approved prior to use and operation.
-

9 International Limited Warranty, Software Licence Agreement

International Limited Warranty

This product is subject to the terms and conditions set out in the International Limited Warranty which you can download from the Leica Geosystems home page at <http://www.leica-geosystems.com/internationalwarranty> or collect from your Leica Geosystems distributor. The foregoing warranty is exclusive and is in lieu of all other warranties, terms or conditions, expressed or implied, either in fact or by operation of law, statutory or otherwise, including warranties, terms or conditions of merchantability, fitness for a particular purpose, satisfactory quality and non-infringement, all which are expressly disclaimed.

Software Licence Agreement

This product contains software that is preinstalled on the product, or that is supplied to you on a data carrier medium, or that can be downloaded by you online according to prior authorisation from Leica Geosystems. Such software is protected by copyright and other laws and its use is defined and regulated by the Leica Geosystems Software Licence Agreement, which covers aspects such as, but not limited to, Scope of the Licence, Warranty, Intellectual Property Rights, Limitation of Liability, Exclusion of other Assurances, Governing Law and Place of Jurisdiction. Please make sure, that at any time you fully comply with the terms and conditions of the Leica Geosystems Software Licence Agreement.

Such agreement is provided together with all products and can also be referred to and downloaded at the Leica Geosystems home page at <http://www.leica-geosystems.com/swlicense> or collected from your Leica Geosystems distributor.

You must not install or use the software unless you have read and accepted the terms and conditions of the Leica Geosystems Software Licence Agreement. Installation or use of the software or any part thereof, is deemed to be an acceptance of all the terms and conditions of such Licence Agreement. If you do not agree to all or some of the terms of such Licence Agreement, you must not download, install or use the software and you must return the unused software together with its accompanying documentation and the purchase receipt to the distributor from whom you purchased the product within ten (10) days of purchase to obtain a full refund of the purchase price.

Index

A		
Antenna		
Calibration	29	
Antennas		
Type	116	
Available Sub Menus	46	
B		
Base setup	56	
Base Setup Functions	59	
Batteries		
Charging, first-time use	26	
Operation, Discharging	26	
Battery		
External, instrument	109	
Internal, instrument	108	
C		
Calibration, antennas	29	
Capacity, memory		
Instrument	108	
	CC50	
	Rear side	18
	Topview	17, 17
	CC60/CC61	
	Rear view	19
	Topview	18
	Connector, antennas	117
	Container contents	11
D		
Data recording		
Leica GNSS raw data	108	
RINEX	108	
Definition of Use	89	
Dimensions		
Antenna	116	
Instruments	107	
Documentation	4	

E		K	
Electrical data		Keys	
Antenna	116	Enter	36
iCON gps 60	110	ESC (Escape)	36
Environmental specifications		Navigation cross	36
Antenna	118	ON/OFF	36
Instrument	111		
F		L	
FCC Statement	105	Labelling	
		GEB221	106
		GEB222	106
		iCON gps 60	106
I		Licensing	67
Icon		Li-Ion battery	108
Battery / Power	43	Storage	86
Bluetooth	42	Locked Menus	45
Construction telematics	43		
Modem	41	M	
Position	39	Main menu	38
Radio	40	Mechanical Reference Plane	30
Satellite	40	Mount, antennas	117
Settings	44	MRP	30
Storage	44	MRP (mechanical reference plane)	30
Insert			
SIM card	27		
International Limited Warranty	122		

N		S	
Navigation in Sub Menus	45	Safety Directions	88
NiCd battery	109	Screen	
O		Graphical overview	21
Offset		iCON Site main menu	20
Antenna		Setups with Controller and Accessories	68
Vertical	29, 33	SIM card	
Operating times		Insert and remove	27
iCON gps 60	109	Socket	119
P		Software Licence Agreement	122
Phase center variations, vertical	29	Software Tools	56
Pin Assignment	119	Specifications, environmental	
Power LED	37	Antennas	118
Power, instruments	108	Instrument	111
R		Sub Menu	
Raw data logging		How to Change and Edit Values	52
Leica GNSS	108	T	
RINEX	108	Temperature	
Raw Data Logging	65	Antenna	
Recording	108	Operating	118
Responsibilities	92	Storage	118

Battery internal	
Operating	111
Storage	111
Instrument	
Operating	111
Storage	111, 111
Temperature range	
Product, drying	87
Temperature, charging internal battery	26
Time, operating	109

U

User Interface	
Additional icon information	39
Description of	36
iCON gps 60	35
User Manual	
Validity of	4

V

Vertical offset, antenna	29, 33
--------------------------------	--------

W

Weight	
Antennas	116
Instrument	107

Total Quality Management: Our commitment to total customer satisfaction.



Leica Geosystems AG, Heerbrugg, Switzerland, has been certified as being equipped with a quality system which meets the International Standards of Quality Management and Quality Systems (ISO standard 9001) and Environmental Management Systems (ISO standard 14001).

Ask your local Leica Geosystems dealer for more information about our TQM program.

Leica Geosystems AG

Heinrich-Wild-Strasse
CH-9435 Heerbrugg
Switzerland
Phone +41 71 727 31 31

www.leica-geosystems.com

- when it has to be **right**

Leica
Geosystems

793666-1.0.0en

Original text
Printed in Switzerland
© 2012 Leica Geosystems AG, Heerbrugg, Switzerland