



Scan to see website

VIA CONNECT 3 Quick Start Guide For Installer

This guide helps you install and use your VIA CONNECT 3 for the first time.

Connect to www.kramerav.com/product/VIA_CONNECT3 to download the latest user manual and check if firmware upgrades are available.



Scan to view this document online

Step 1: Check what's in the box

- ✓ VIA CONNECT 3 Collaboration Device
- ✓ 1 VESA mounting bracket
- ✓ 1 Quick start guide
- ✓ 1 Power cords for US and EU
- ✓ 1 VESA screw set

Step 2: Get to know your VIA CONNECT 3

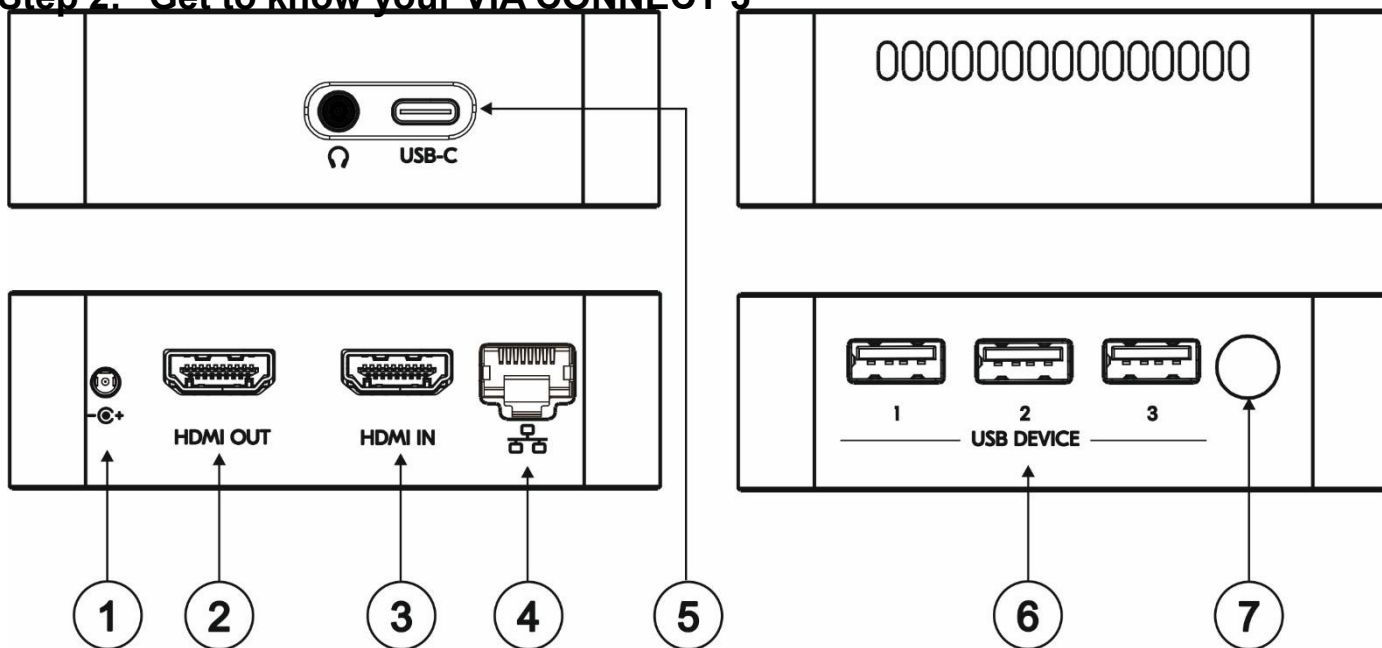

#	Feature	Function
1	Power Connector	Connect to the 12V DC power supply.
2	HDMI OUT Connector	Connect to an HDMI sink.
3	HDMI IN Connector	Connect to an HDMI source.
4	RJ-45 Connector	Connect to a LAN (default mode).
5	USB-C Connector	Connect to a USB-C source. Also used for Video Out.
6	3 x USB DEVICE 3.0 Connector	Connect to a USB device, for example, a USB speaker.
7	Power Button with LED	Press to power ON or turn OFF the device.



The analog audio port is unavailable and is covered by rubber.



Step 3: Mount VIA CONNECT 3

VIA CONNECT 3 can be installed on a flat surface / wall, rear of a monitor or rack mount using the included VESA mounting bracket and screw set:

Mount VIA CONNECT 3 to the Mounting Bracket

Attach the mounting bracket to the VIA CONNECT 3 with 2 screws.

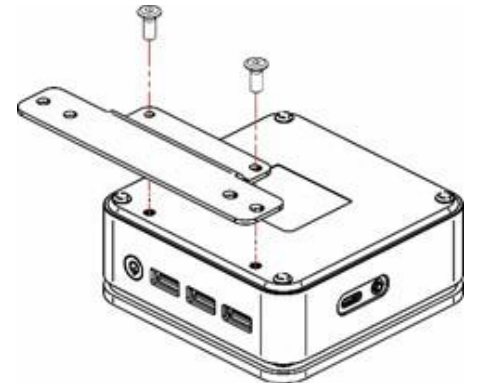

This step is required for all options detailed below.

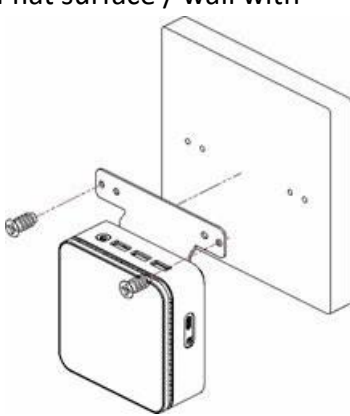
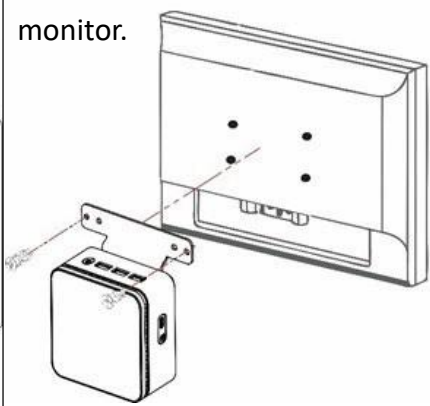
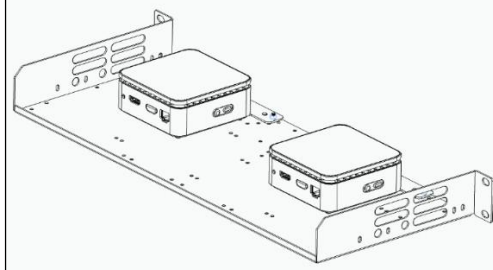
To Mount to a Flat Surface / Wall	To Mount to rear of monitor	To Mount to a Rack Mount
<p>Secure the mounting bracket to a flat surface / wall with</p>  <p>dedicated screws.</p>	<p>Secure the mounting bracket to monitor.</p>  <p>holes located on rear of</p>	<p>Secure the mounting bracket(s) to the rack mount with dedicated screws.</p>  <p>VESA</p>

Step 4: Connect inputs and outputs

Always switch OFF the power on each device before connecting it to your VIA CONNECT 3.

1. Connect a USB device.
2. Connect an HDMI display.

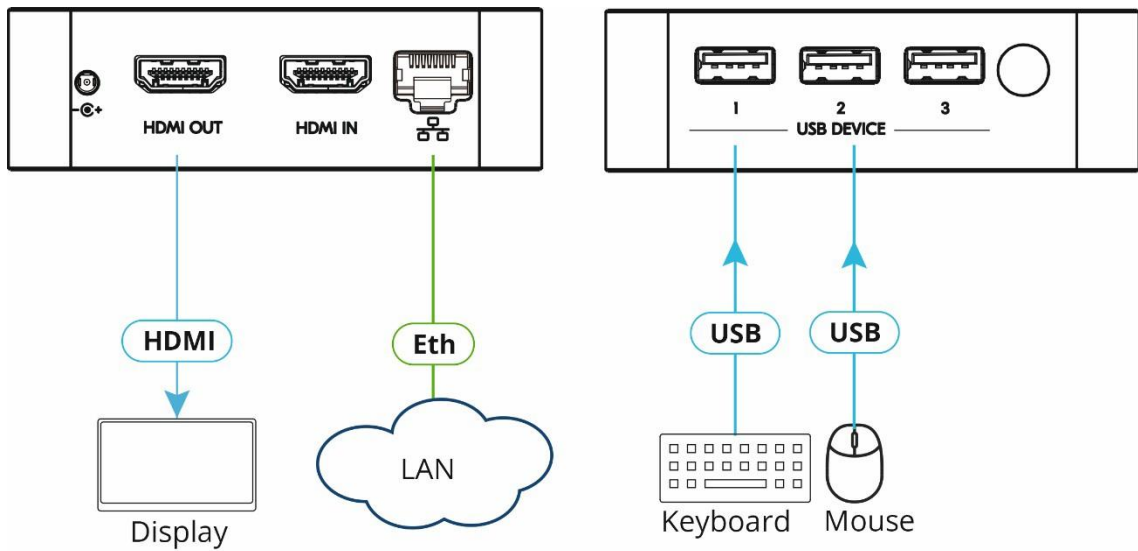

3. Connect to the LAN (default mode).



To use a Kramer active optical pluggable HDMI cable with your **VIA CONNECT 3**, contact your local Kramer office to assist in purchasing the correct cable.



To achieve specified extension distances, use the recommended Kramer cables available at www.kramerav.com/product/VIA_CONNECT3. Using third-party cables may cause damage!

Step 5: Connect power

Connect the 12V DC power adapter to **VIA CONNECT 3** and plug it into the mains electricity.



Caution: There are no operator serviceable parts inside the unit.

Caution: The device is intended to be installed at a height of 2 meters or less.

Warning: Use only the Kramer Electronics power adapter that is provided with the unit.

Warning: Disconnect the power and unplug the unit from the wall before installing.

See www.KramerAV.com for updated safety information.

Step 6: Configure VIA CONNECT 3

Connect your VIA Connect 3 to the local network to begin. Some settings may require initial adjustment. When the VIA is connected to a display, the display shows the VIA's IP address (this can be disabled in the web interface). To customize settings, log into the Gateway web interface by entering the VIA IP address in a browser connected to the same network. It may be necessary to customize settings according to network, customer, or IT requirements.

Login to VIA

1. Open a Chrome browser and browse to the CONNECT 3 IP address; the Welcome page will open.
2. Click **Manage Gateway Settings** in the upper right corner.



3. Enter the username and password (default = su / supass) and click **Login**.
4. After logging in, the VIA Dashboard will open. The Dashboard top has quick links for common tasks.

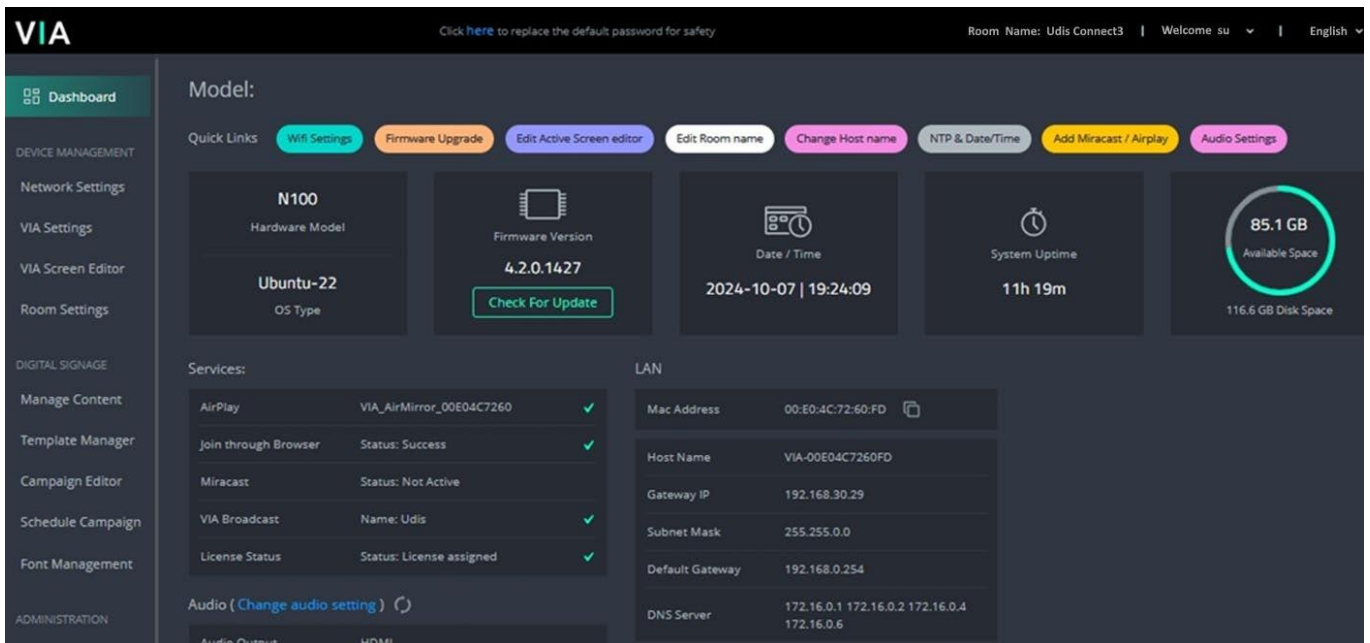
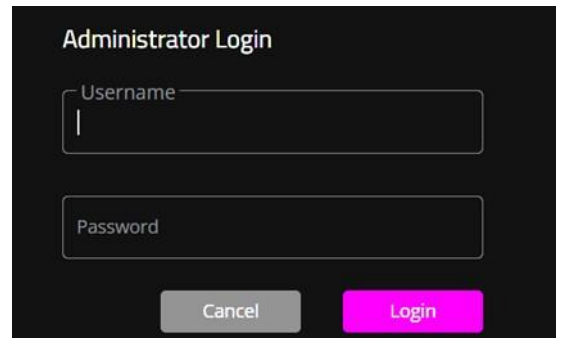
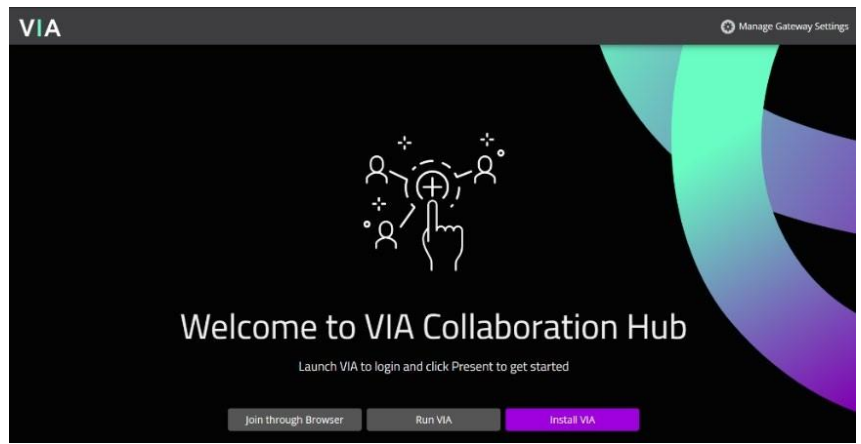

Configure VIA Network Settings

Change Hostname or Change network DHCP / Fixed IP

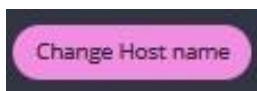

1. Click “Change Hostname” in the Dashboard’s Quick Links, or click **Network Settings** in the navigation pane on the left to open the **Network Settings > LAN Settings** screen.

2. Enter the hostname or the

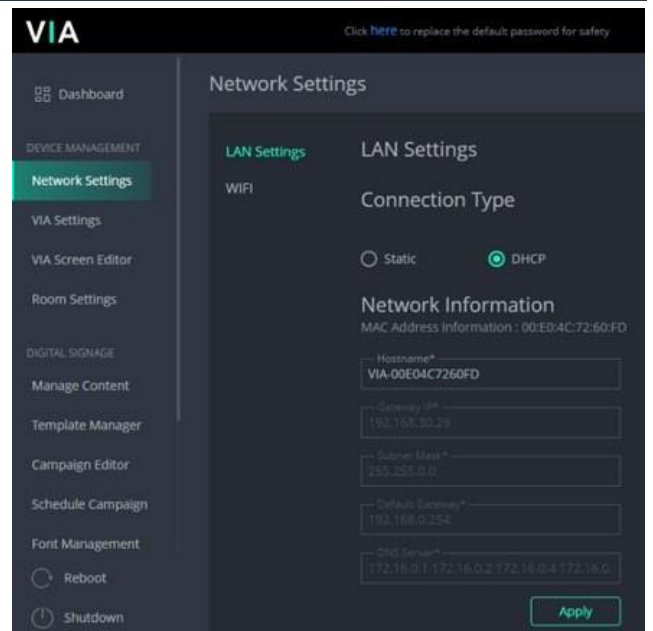

network IP information (select Static to enable the fields), then click **Apply**.

VIA will reboot to apply the changes.

Activate the VIA WIFI Access Point

1. If a WIFI access point is required, click “Wifi Settings” in the dashboard’s Quick Links, OR open **Network Settings > WIFI**.

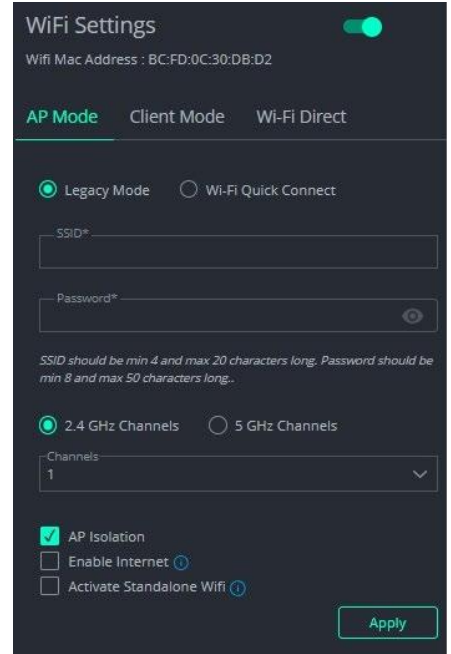
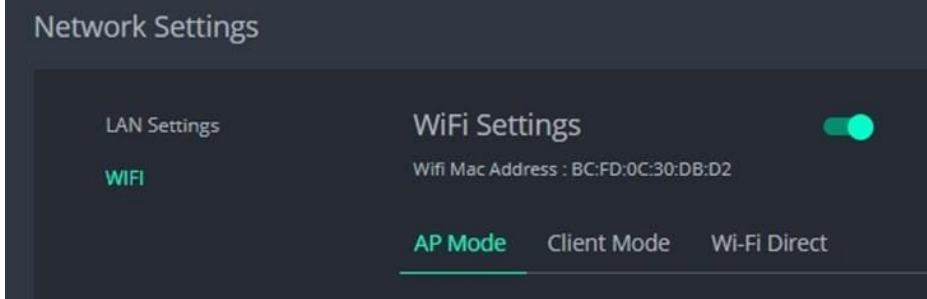

2. Activate the WIFI Settings slider (move to the right) to enable the Wi-Fi fields.

3. Once finished, click **Apply**. VIA will reboot to apply the settings.

VIA Settings

To personalize the VIA’s on-screen appearance, time zone, security, and more, adjust the VIA settings.

1. Click **VIA Settings** in the navigation panel on the left to open the VIA Settings screen.
2. Click the **Duplicate** icon on the default template.
3. Click **Publish** to set the duplicate template to “Active”.

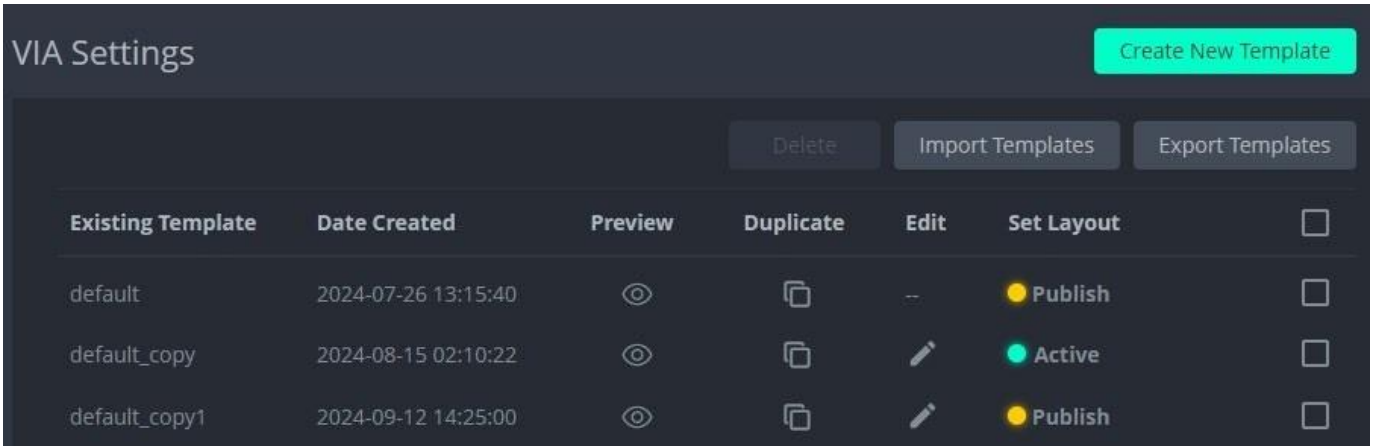

Common VIA Settings Changes

Change the Room name

1. Click “Edit Room name” in the Dashboard’s Quick Links OR open the **VIA Settings** screen and click the Edit icon on the “Active” template to open the default **VIA**

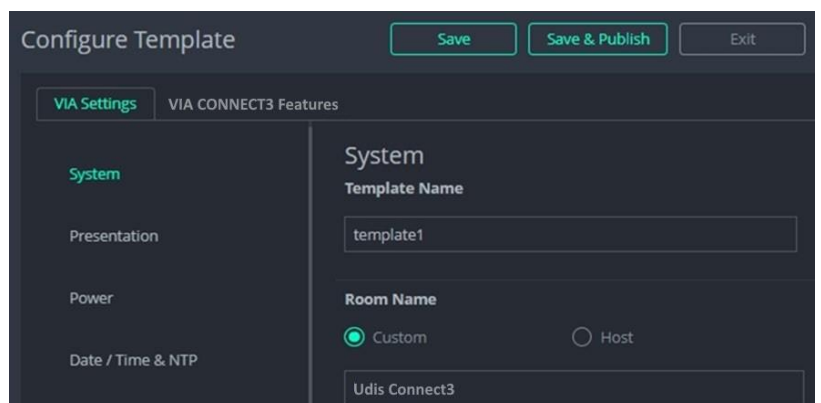
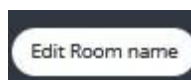

Settings > System tab.

- By default, the room name uses the Host name. To change the room name, click “Custom” and enter a new name.
- Click **Save & Publish**.

Set Audio Settings

- Click “Audio Settings” in the Dashboard’s Quick Links OR open **VIA Settings** and click the Edit icon on the “Active” template; then select the **VIA Settings > Audio** tab.

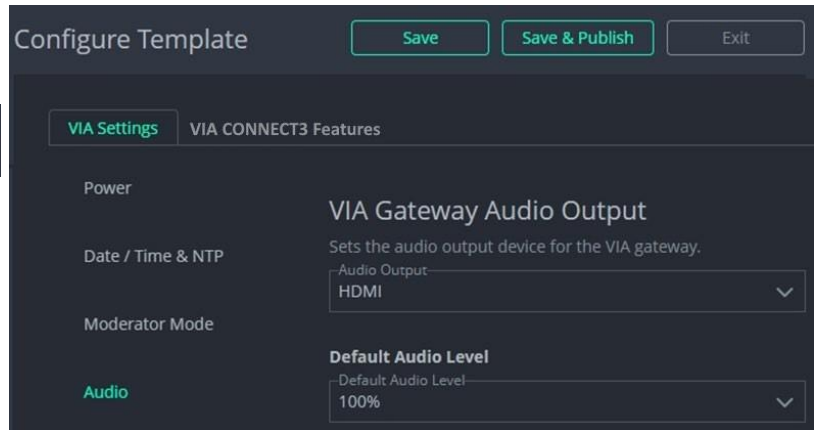
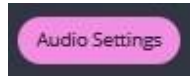

- Select the required “Audio Output” device and click **Save & Publish**.

Set Date / Time & NTP

- Click “NTP & Date/Time” in the Dashboard’s Quick Links.

OR open the **VIA Settings** screen and click the Edit icon next to the “Active” template; then select the **VIA Settings > Date / Time & NTP** tab.



- Select the required date format, time zone, enter the NTP Server’s IP and click **Save & Publish**.

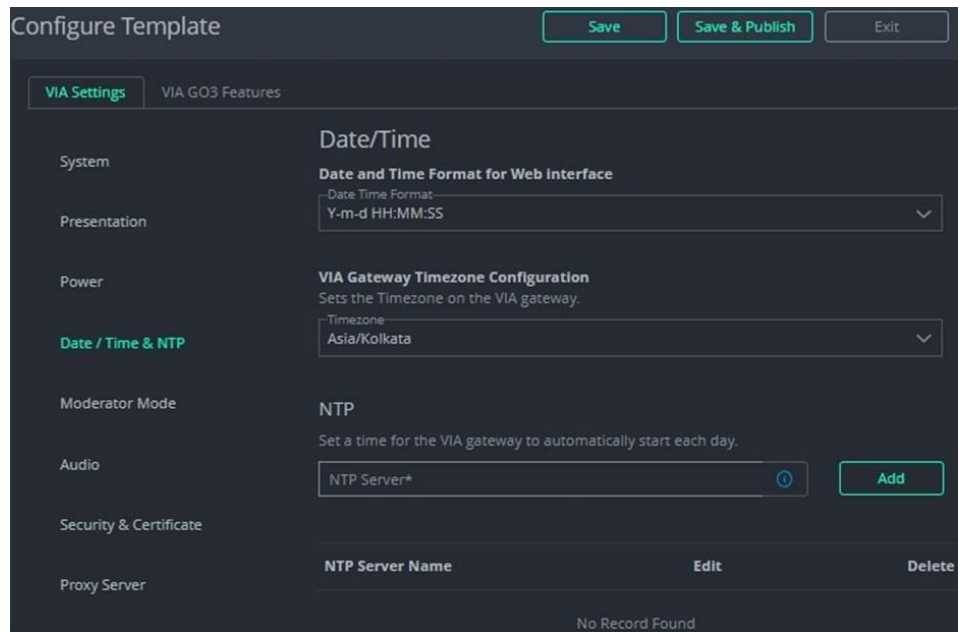

Set Miracast / Airplay

- Click on “Add Miracast / Airplay” in the Dashboard’s Quick Links OR open the **VIA Settings** screen and click the Edit icon next to the “Active” template; then select the **VIA Settings > Presentation** tab.



- Enable **Miracast Settings** by moving the slider right.
- Then click **Save & Publish**.

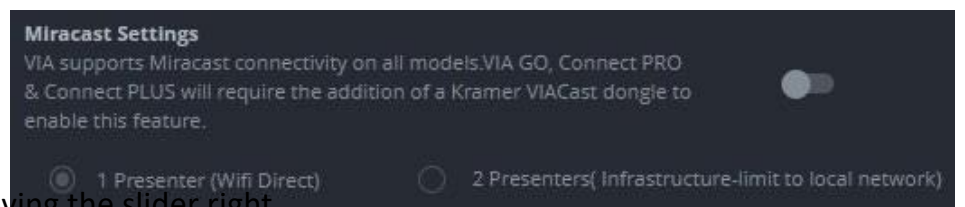

VIA Screen Editor

To create a personalized VIA Screen template, use the **Screen Editor**.

1. Click **VIA Screen Editor** in the navigation panel on the left to open the **Screen Editor's** layout list.

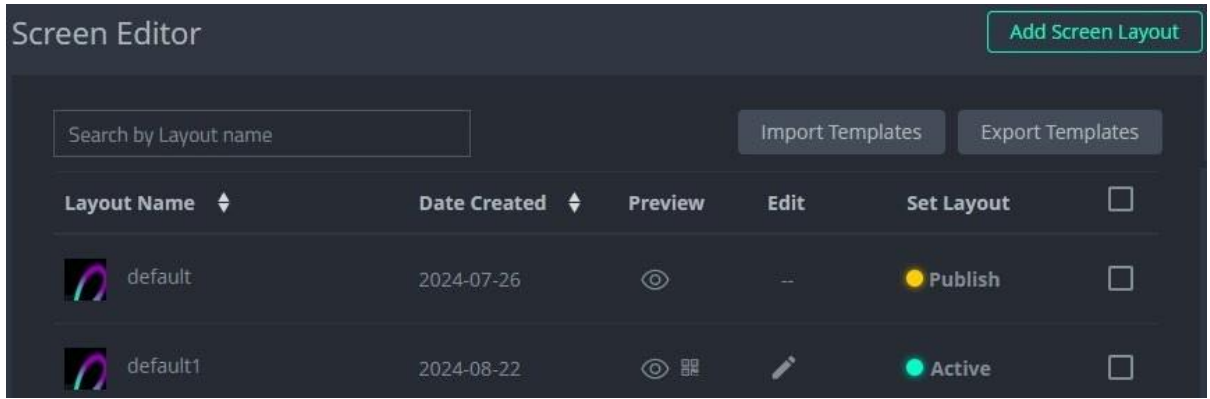

2. Click **Add Screen Layout** (top right) to start a new screen layout in the Screen Editor.

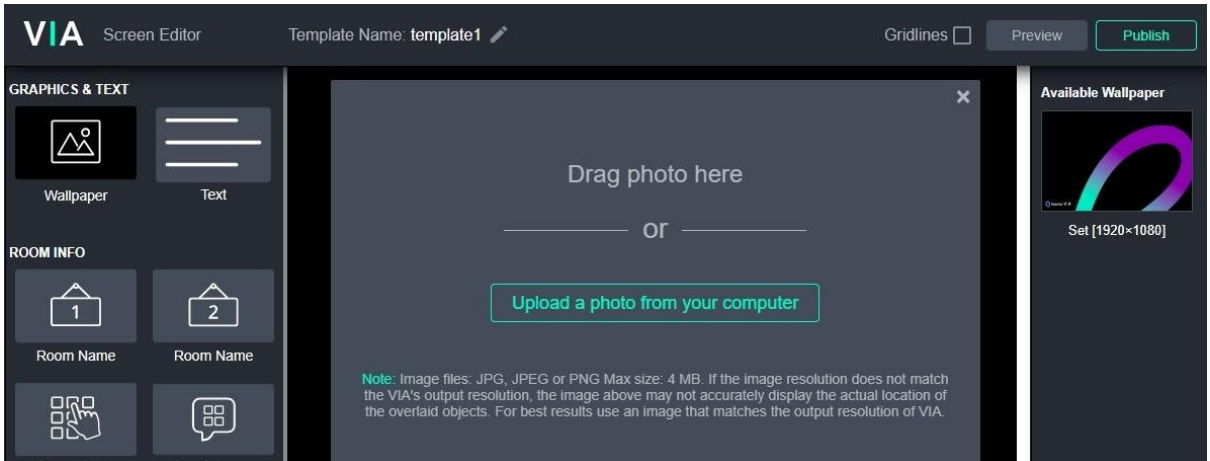

3. Drag and drop VIA default wallpaper or upload custom wallpaper.
4. Drag and drop widgets from the left widget panel to build the required display.
5. Click a dropped widget to open the Properties window on the right and adjust the widget's properties and colors.

Example of text widget PROPERTIES window and the COLORS tab:

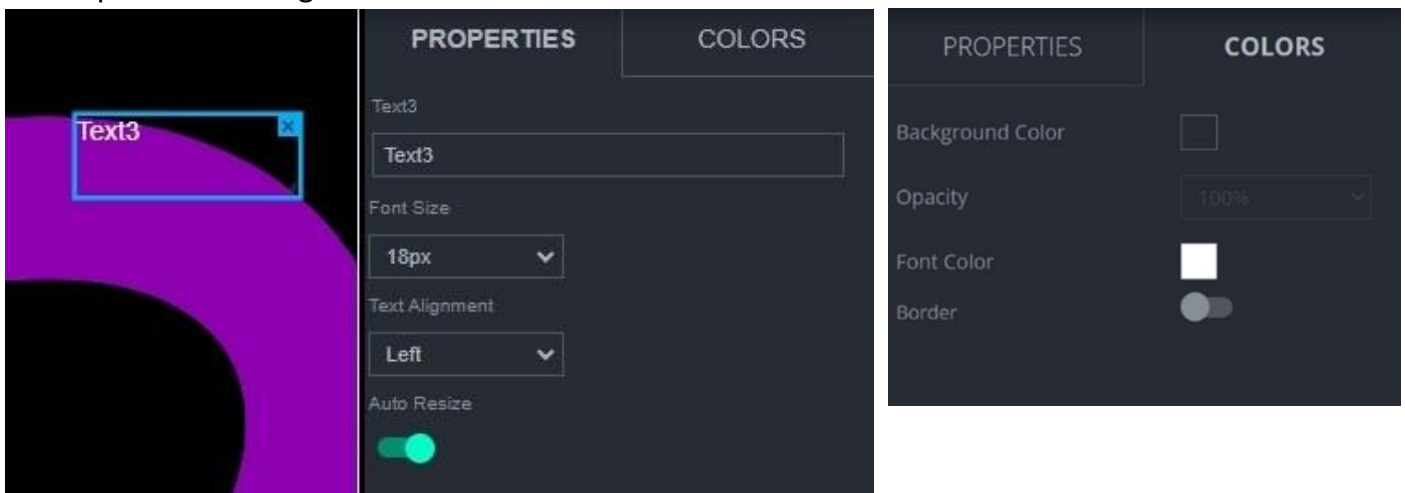

Specifications are subject to change without notice at www.kramerav.com

The terms HDMI, HDMI High-Definition Multimedia Interface, and the HDMI Connect are trademarks or registered trademarks of HDMI Licensing Administrator, Inc.

Step 1: Connect your personal device to the correct network

Connect your personal device to the same Wi-Fi or LAN network as the **VIA CONNECT 3**.

Step 2: Run or Download the Kramer VIA app

For Mac or PC:

1. Enter the Room Name or IP of the VIA CONNECT 3 in your computer's browser. The Welcome page of VIA CONNECT 3 appears.
2. Click **Run VIA** to execute the Kramer VIA app without downloading it.
Click **Install VIA** to download

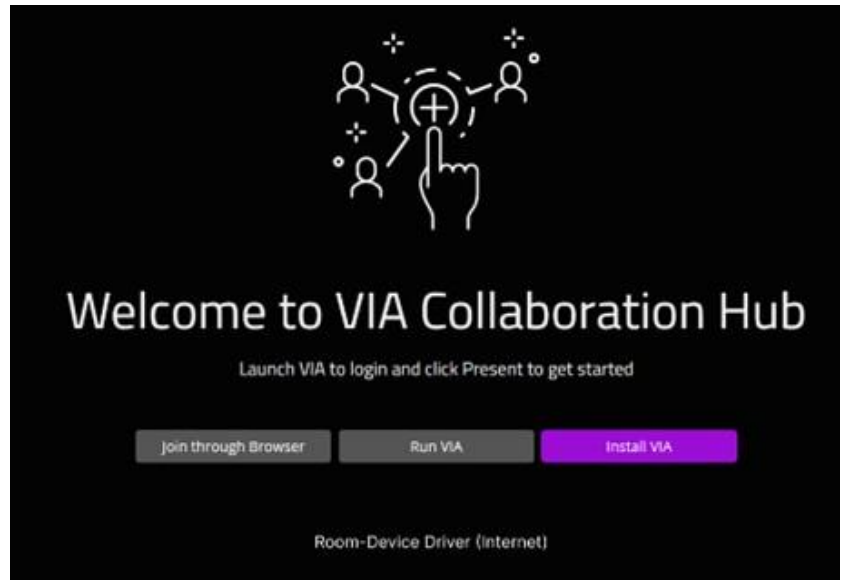

Scan to see website

VIA CONNECT 3 Quick Start Guide For User

This guide helps you install and use your **VIA CONNECT 3** for the first time.

See the latest user manuals at www.kramerav.com/product/VIA_CONNECT3.



Scan to view this document online

the Kramer VIA app onto your computer.

For iOS or Android devices: Download and install the free Kramer VIA app from Apple App Store or Google Play.

Step 3: Join the meeting using Kramer's VIA App

1. Open the Kramer VIA app and select the room or IP to which you want to connect: If your site requires a Room Code, the Room Code window will appear.
2. In the Room Code field, enter the 4-digit code that is shown on the Main Display.
3. You are logged into the VIA meeting.
The VIA App screen appears on your device screen (see next page).

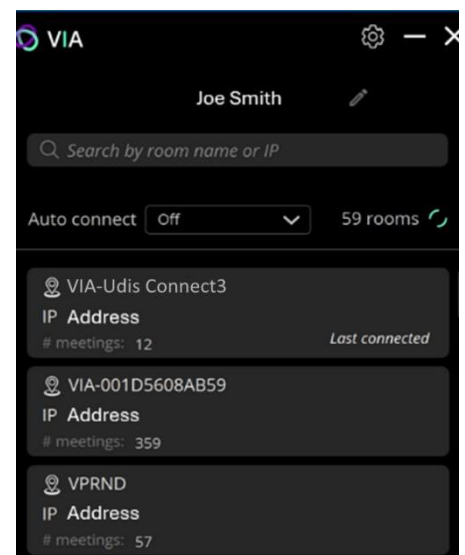

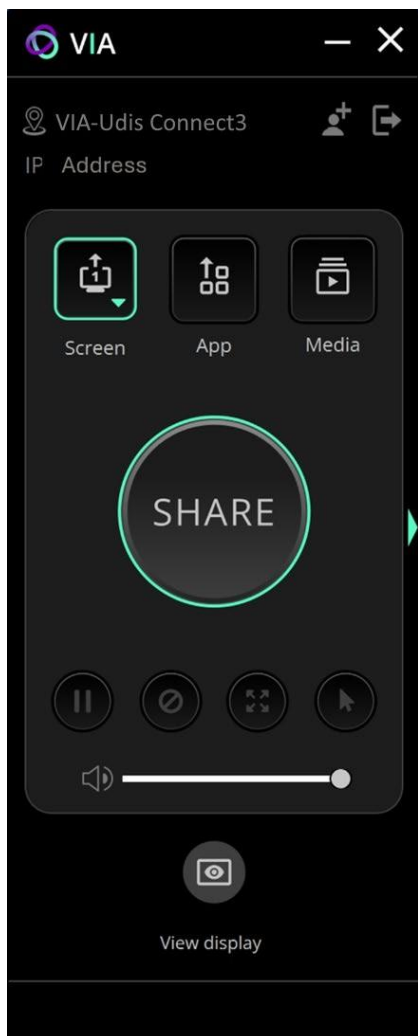

Step 4: Using VIA

1. Select what you want to share:

- **Screen** – Share your screen.
- **App** – Share a window or a third-party app.
- **Media** – Share (stream) a media file.

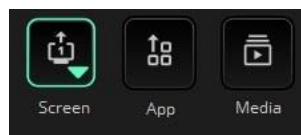

2. Click **SHARE**:

- The **SHARE** button becomes the **STOP** button.
- Your screen, app or media will be displayed to meeting participants (on the main display).

3. Click **STOP** to end sharing.

Step 5: VIA CONNECT 3 Features



Wireless Connection



Powerful Content Security



Video Streaming



Mobile Mirroring



VIA Site Management (VSM)



Digital Signage



Calendar Integration



VIA Pad Compatible



Integrated YouTube Player

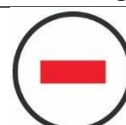

Do Not Disturb (DND)

SIMPLIFIED EU DECLARATION OF CONFORMITY

Hereby, Kramer Electronics declares that the radio equipment type VIA CONNECT3 is in compliance with

Directive 2014/53/EU.

The full text of the EU declaration of conformity is available via the Resources tab on the product page at the following internet address: www.kramerav.com/product/VIA_CONNECT3

FCC Statement

This equipment has been tested and found to comply with the limits for a Class B digital device, pursuant to part 15 of the FCC Rules. These limits are designed to provide reasonable protection against harmful interference in a residential installation. This equipment generates, uses and can radiate radio frequency energy and, if not installed and used in accordance with the instructions, may cause harmful interference to radio communications. However, there is no guarantee that interference will not occur in a particular installation. If this equipment does cause harmful interference to radio or television reception, which can be determined by turning the equipment off and on, the user is encouraged to try to correct the interference by one or more of the following measures:

- Reorient or relocate the receiving antenna.
- Increase the separation between the equipment and receiver.
- Connect the equipment into an outlet on a circuit different from that to which the receiver is connected.
- Consult the dealer or an experienced radio/TV technician for help.

Caution: Any changes or modifications to this device not explicitly approved by manufacturer could void your authority to operate this equipment.

This device complies with part 15 of the FCC Rules. Operation is subject to the following two conditions: (1) This device may not cause harmful interference, and (2) this device must accept any interference received, including interference that may cause undesired operation.

RF Exposure Information

This equipment complies with FCC radiation exposure limits set forth for an uncontrolled environment. This equipment should be installed and operated with minimum distance 20cm between the radiator and your body.

ISED Statement

English: This device contains licence-exempt transmitter(s)/receiver(s) that comply with Innovation, Science and Economic Development Canada's licence-exempt RSS(s). Operation is subject to the following two conditions:

- (1) This device may not cause interference.
- (2) This device must accept any interference, including interference that may cause undesired operation of the device.

The digital apparatus complies with Canadian CAN ICES-3 (B)/NMB-3(B).

French: Cet appareil contient des émetteurs/récepteurs exempts de licence qui sont conformes aux RSS exemptés de licence d'Innovation, Sciences et Développement économique Canada.

L'exploitation est soumise aux deux conditions suivantes :

- (1) Cet appareil ne doit pas provoquer d'interférences.
- (2) Cet appareil doit accepter toute interférence, y compris les interférences susceptibles de provoquer un fonctionnement indésirable de l'appareil.

L'appareil numérique du CIEM conforme canadien peut - 3 (b) / nmb - 3 (b).

This device meets the exemption from the routine evaluation limits in section 6.3 of RSS 102 and compliance with RSS 102 RF exposure, users can obtain Canadian information on RF exposure and compliance.

Cet appareil est conforme à l'exemption des limites d'évaluation courante dans la section 6.3 du CNR -

102 et conformité avec RSS 102 de l'exposition aux RF, les utilisateurs peuvent obtenir des données canadiennes sur l'exposition aux champs RF et la conformité.

This equipment complies with Canada radiation exposure limits set forth for an uncontrolled environment.

Cet équipement est conforme aux limites d'exposition aux rayonnements du Canada établies pour un environnement non contrôlé.

This equipment should be installed and operated with minimum distance 20cm between the radiator & your body.

Cet équipement doit être installé et utilisé à une distance minimale de 20 cm entre le radiateur et votre corps.