



# **FCC Part 90 & RSS-119 TEST REPORT**

*For*

**Two Way Radio**

**Model Name: TC-780U(2)**

**Trade Name: HYT**

**FCC ID: R74TC-780U2, IC: 5465A-TC780U2**

**Report No.: SZAGC003080402E6**

**Date of Issue: Apr.16, 2008**

*Prepared For*

**Shenzhen HYT Science & Technology Co., Ltd.**

**HYT Tower, Shenzhen Hi-Tech Industrial Park North, Beihuan Rd.,**

**Nanshan District, Shenzhen, P.R.C.**

Tel: 86-755-2697 2999

Fax: 86-755-8613 7130

*Prepared By*

**Shenzhen Attestation of Global Compliance Science & Technology Co., Ltd**

**Suite B11/B12, 4F, Huafeng Mall, Chuangye 2<sup>nd</sup> Road,**

**25 District, Bao'an, Shenzhen**

Tel: 86-755-2974 2358

Fax: 86-755-2600 8484

**VERIFICATION OF COMPLIANCE**

Applicant:	SHENZHEN HYT SCIENCE & TECHNOLOGY CO., LTD. HYT Tower, Shenzhen Hi-Tech Industrial Park North, Beihuan Rd., Nanshan District, Shenzhen, P.R.C.
Manufacturer:	SHENZHEN HYT SCIENCE & TECHNOLOGY CO., LTD. HYT Tower, Shenzhen Hi-Tech Industrial Park North, Beihuan Rd., Nanshan District, Shenzhen, P.R.C.
Product Description:	Two-way Radio
Brand Name:	HYT
Model Number:	TC-780U(2)
Serial Number:	N/A
File Number:	SZAGC003080402E6
Date of Test:	Apr.01, 2007 ~ Apr.16, 2007

**We hereby certify that:**

The above equipment was tested by Shenzhen Attestation of Global Compliance Science & Technology Co., Ltd. The data evaluation, test procedures, and equipment configurations shown in this report were made in accordance with the procedures given in ANSI C 63.4:2003 and TIA/EIA 603. The sample tested as described in this report is in compliance with the FCC Rules Part 90.

The test results of this report relate only to the tested sample identified in this report.

Prepared By: Tony Tian  
Tony Tian      Apr.16, 2008

Checked By: Randy He  
Randy He      Apr.16, 2008

Authorized By: King Zhang  
King Zhang      Apr.16, 2008

## TABLE OF CONTENTS

<b>1. GENERAL INFORMATION .....</b>	<b>4</b>
1.1 PRODUCT DESCRIPTION .....	4
1.2 RELATED SUBMITTAL(S) / GRANT (S).....	5
1.3 TEST METHODOLOGY .....	5
1.4 TEST FACILITY .....	5
1.5 SPECIAL ACCESSORIES .....	5
1.6 EQUIPMENT MODIFICATIONS .....	5
<b>2. SYSTEM TEST CONFIGURATION .....</b>	<b>6</b>
2.1 EUT CONFIGURATION .....	6
2.2 EUT EXERCISE .....	6
2.3 GENERAL TECHNICAL REQUIREMENTS .....	6
2.4 CONFIGURATION OF TESTED SYSTEM .....	6
<b>3. SUMMARY OF TEST RESULTS .....</b>	<b>7</b>
<b>4. DESCRIPTION OF TEST MODES.....</b>	<b>8</b>
<b>5. CONDUCTED LIMITS (NOT APPLICABLE).....</b>	<b>9</b>
5.1 PROVISIONS APPLICABLE .....	9
5.2 MEASUREMENT PROCEDURE .....	9
5.3 TEST SETUP BLOCK DIAGRAM.....	10
5.4 TEST EQUIPMENT USED.....	10
5.5 TEST RESULT .....	11
<b>6. FREQUENCY TOLERANCE.....</b>	<b>12</b>
6.1 PROVISIONS APPLICABLE .....	12
6.2 MEASUREMENT PROCEDURE .....	12
6.3 TEST SETUP BLOCK DIAGRAM .....	13
6.4 TEST EQUIPMENT USED:.....	13
6.5 TEST RESULT .....	13
<b>7. EMISSION BANDWIDTH .....</b>	<b>18</b>
7.1 PROVISIONS APPLICABLE .....	18
7.2 MEASUREMENT PROCEDURE .....	18
7.3 TEST SETUP BLOCK DIAGRAM.....	18
7.4 MEASUREMENT EQUIPMENT USED:.....	18
7.5 MEASUREMENT RESULT: .....	19
<b>8. UNWANTED RADIATION .....</b>	<b>20</b>
8.1 PROVISIONS APPLICABLE .....	21
8.2 MEASUREMENT PROCEDURE .....	21

8.3 TEST SETUP BLOCK DIAGRAM.....22

8.4 MEASUREMENT EQUIPMENT USED:.....24

8.5 MEASUREMENT RESULTS:.....24

8.6 EMISSION MASK PLOT.....27

**9. MODULATION CHARACTERISTICS .....29**

9.1 PROVISIONS APPLICABLE .....29

9.2 MEASUREMENT METHOD .....29

9.3 MEASUREMENT INSTRUMENTS .....29

9.4 MEASUREMENT RESULT .....30

**10. MAXIMUM TRANSMITTER POWER (CONDUCTED OUTPUT POWER).....37**

10.1 PROVISIONS APPLICABLE .....37

10.2 TEST PROCEDURE .....37

10.3 TEST INSTRUMENTS .....37

10.4 TEST RESULT .....37

10.5 CONDUCT SPURIOUS PLOT .....38

**11. TRANSMITTER FREQUENCY BEHAVIOR.....39**

11.1 PROVISIONS APPLICABLE .....40

11.2 TEST METHOD .....40

11.3 TEST INSTRUMENTS .....40

11.4 MEASURE RESULT .....40

**12. RADIATED EMISSION ON RECEIVING MODE.....42**

12.1 PROVISIONS APPLICABLE .....43

12.2 TEST METHOD .....43

12.3 TEST INSTRUMENTS .....43

12.4 MEASURE RESULT (MEASURED AT 3M USING FCC PART15 B LIMITS) .....44

**APPENDIX I PHOTOGRAPHS OF SETUP .....45**

**APPENDIX II EXTERNAL VIEW OF EUT .....47**

## 1. GENERAL INFORMATION

### 1.1 Product Description

The EUT is a single channel Two-way Radio designed for voice communication. It is designed by way of utilizing the FM modulation achieves the system operating.

A major technical description of EUT is described as following:

Communication Type	Voice / Tone only
Modulation	FM
Emission Type	11K0F3E (2M+2D, M=3, D=2.5, NB=11KHz for 12.5 KHz separation) 16K0F3E (2M+2D, M=3, D=5.0, NB=16KHz for 25.0 KHz separation)
Emission Bandwidth	10.26 KHz (Limit:11.25 KHz for 12.5 KHz channel separation)
	15.43 KHz (Limit: 20 KHz for 25 KHz channel Separation)
Peak Frequency Deviation	1.75 KHz for 12.5 KHz Channel Separation (Limit< $\pm$ 2.5 KHz)
	3.57 KHz for 25 KHz Channel Separation (Limit< $\pm$ 5 KHz)
Audio Frequency Response	2.80 KHz (Limit<3.125 KHz)
Maximum Transmitter Power	4.80 W(4.79 W) for 12.5 KHz (25.0 KHz) Channel Separation – 5W 0.93 W(0.93 W) for 12.5 KHz (25.0 KHz) Channel Separation – 1W
Output power Modification	Fixed can't be changed
Antenna Designation	Detachable
Power Supply	DC 7.4V by battery
Battery Endpoint	DC 6.1V
Operation Frequency Range and Channel	Frequency Range: 450 MHz to 512 MHz Channel Separation: 12.5KHz and 25KHz
	Top Channel: 519.975 MHz
	Centre Channel: 485.025 MHz
	Bottom Channel: 450.125 MHz
Frequency Tolerance	0.98 ppm for 12.5 KHz Channel Separation
	0.94 ppm for 25.0 KHz Channel Separation

## **1.2 Related Submittal(s) / Grant (s)**

This submittal(s) (test report) is intended for **FCC ID: R74TC-780U2** and **IC: 5465A-TC780U2** filing to comply with the FCC Part 90 requirements and RS-119 requirements.

## **1.3 Test Methodology**

The radiated emission testing was performed according to the procedures of ANSI C63.4 : 2003;TIA/EIA 603 and FCC CFR 47 Rules of 2.1046, 2.1047, 2.1049, 2.1051, 2.1053, 2.1055, 2.1057.

## **1.4 Test Facility**

The test site used to collect the radiated data is located on the address of Shenzhen Electronic Product Quality Testing Centre, Electronic Testing Building, Wenguang Road, Xili Town Shenzhen, China.. The test site is constructed and calibrated to meet the FCC requirements in documents ANSI C63.4: 2003 and IC requirements in documents RS212

FCC register No.: 261302

## **1.5 Special Accessories**

Not available for this EUT intended for grant.

## **1.6 Equipment Modifications**

Not available for this EUT intended for grant.

## 2. SYSTEM TEST CONFIGURATION

### 2.1 EUT Configuration

The EUT configuration for testing is installed on RF field strength measurement to meet the Commission's requirement and operating in a manner which intends to maximize its emission characteristics in a continuous normal application.

### 2.2 EUT Exercise

The Transmitter was operated in the normal operating mode. the TX frequency was fixed which was for the purpose of the measurements.

### 2.3 General technical requirements

- (1). Section 15.207: Conducted Limits (Not applicable)
- (2). Section 90.205: Maximum ERP is dependent upon the station's antenna HAAT and required service area
- (3). Section 90.207: Modulation Characteristic
- (4). Section 90.209: Occupied Bandwidth
- (5). Section 90.210: Emission Mask
- (6). Section 90.213: Frequency Tolerance
- (7). Section 90.214: Transient Frequency Behavior

### 2.4 Configuration of Tested System

Fig. 2-1 Configuration of Tested System



Table 2-1 Equipment Used in Tested System

Item	Equipment	Model No.	Identifier	Series No.	Note
1	Two way Radio	TC-780U(2)	FCC ID: R74TC-780U(2) IC:5465A-TC780U(2)	N/A	EUT
--	--	--	--	--	--
--	--	--	--	--	--

### 3. SUMMARY OF TEST RESULTS

<b>FCC Rules</b>	<b>RS-119</b>	<b>Description Of Test</b>	<b>Result</b>
§15.207	RS-Gen	Conducted Emission	N/A
§90.205	§5.4	Maximum Transmitter Power	Compliant
§90.207	§5.13	Modulation Characteristic	Compliant
§90.209	§5.5	Occupied Bandwidth	Compliant
§90.210	§5.8	Emission Mask	Compliant
§90.213	§5.3	Frequency Tolerance	Compliant
§90.214	§5.9	Transient Frequency Behavior	Compliant



## **4. DESCRIPTION OF TEST MODES**

The EUT (Two way Radio) has been tested under normal operating condition. Three channels (The top channel, the middle channel and the bottom channel) are chosen for testing at each channel separation (12.5 KHz/ 25 KHz).

## 5. CONDUCTED LIMITS (NOT APPLICABLE)

### 5.1 PROVISIONS APPLICABLE

For an intentional radiator that is designed to be connected to the public utility (AC) power line, the radio frequency voltage that is conducted back onto the AC power line on any frequencies within the band 150 KHz to 30 MHz shall not exceed the limits in the following table, as measured using a 50uH/50 ohms line impedance stabilization network (LISN). Compliance with the provisions of this paragraph shall be based on the measurement of the radio frequency voltage between each power line and ground at the power terminal. The lower limit applies at the boundary between the frequencies ranges.

Frequency of Emission (MHz)	Conducted Limit(dBuV)	
	Quasi-Peak	Average
0.15 – 0.5	66 to 56 *	56 to 46 *
0.5 – 5	56	46
5 – 30	60	50

\* Decreases with the logarithm of the frequency.

### 5.2 MEASUREMENT PROCEDURE

- (1) The equipment was set up as per the test configuration to simulate typical actual usage per the user's manual. When the EUT is a tabletop system, a wooden table with a height of 0.8 meters is used and is placed on the ground plane as per ANSI C63.4 (see Test Facility for the dimensions of the ground plane used). When the EUT is a floor-standing equipment, it is placed on the ground plane which has a 3-12 mm non-conductive covering to insulate the EUT from the ground plane.
- (2) Support equipment, if needed, was placed as per ANSI C63.4.
- (3) All I/O cables were positioned to simulate typical actual usage as per ANSI C63.4.
- (4) The EUT received AC120V/60Hz power through a Line Impedance Stabilization Network (LISN) which supplied power source and was grounded to the ground plane.
- (5) All support equipments received AC power from a second LISN, if any.
- (6) The EUT test program was started. Emissions were measured on each current carrying line of the EUT using a spectrum Analyzer / Receiver connected to the LISN powering the EUT. The LISN has two monitoring points: Line 1 (Hot Side) and Line 2 (Neutral Side). Two scans were taken: one with Line 1 connected to Analyzer / Receiver and Line 2 connected to a 50 ohm load; the second scan had Line 1 connected to a 50 ohm load and Line 2 connected to the Analyzer / Receiver.
- (7) Analyzer / Receiver scanned from 150kHz to 30MHz for emissions in each of the test modes. During the above scans, the emissions were maximized by cable manipulation.

### 5.3 TEST SETUP BLOCK DIAGRAM

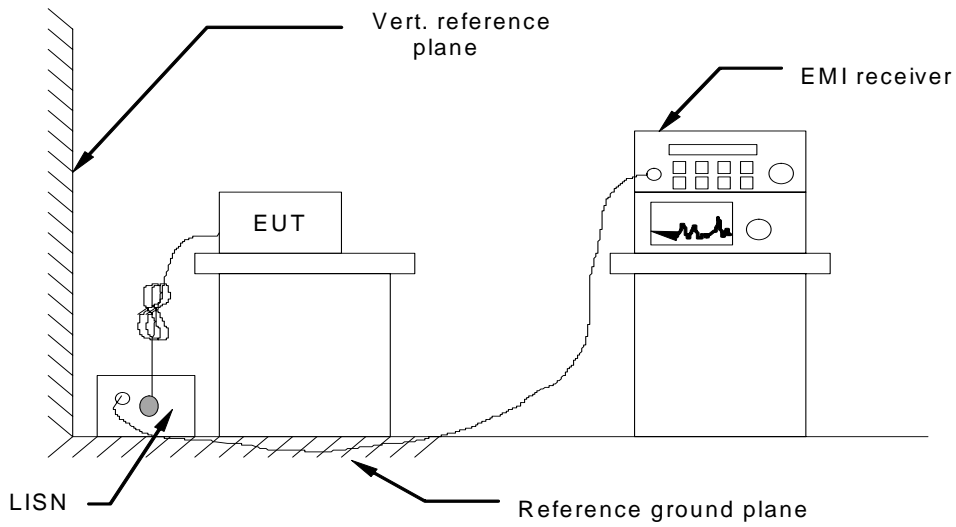

### 5.4 Test equipment used

Conducted Emission Test Site				
Name of Equipment	Manufacturer	Model	Serial Number	Calibration Due
--	--	--	--	--
--	--	--	--	--
--	--	--	--	--
--	--	--	--	--

**5.5 TEST RESULT**

LINE CONDUCTED EMISSION TEST

FREQ MHz	PEAK RAW dBuV	Q.P. RAW dBuV	AVG RAW dBuV	Q.P. Limit dBuV	AVG Limit dBuV	Q.P. Margin dB	AVG Margin dB	NOTE
---	---	---	---	---	---	---	---	---
---	---	---	---	---	---	---	---	---
---	---	---	---	---	---	---	---	---
---	---	---	---	---	---	---	---	---
---	---	---	---	---	---	---	---	---
---	---	---	---	---	---	---	---	---
---	---	---	---	---	---	---	---	---
---	---	---	---	---	---	---	---	---
---	---	---	---	---	---	---	---	---
---	---	---	---	---	---	---	---	---
---	---	---	---	---	---	---	---	---
---	---	---	---	---	---	---	---	---
---	---	---	---	---	---	---	---	---
---	---	---	---	---	---	---	---	---
---	---	---	---	---	---	---	---	---
---	---	---	---	---	---	---	---	---
---	---	---	---	---	---	---	---	---

**\*\*NOTE:**

“---” denotes the peak emission level was or more than 2dB below the Average limit, so no re-check anymore.

L1 = Line One (Hot side) / L2 = Line Two (Neutral side)

## 6. FREQUENCY TOLERANCE

### 6.1 Provisions Applicable

- a). According to FCC Part 2 Section 2.1055(a)(1), the frequency stability shall be measured with variation of ambient temperature from  $-30^{\circ}\text{C}$  to  $+60^{\circ}\text{C}$  centigrade.
- b). According to FCC Part 2 Section 2.1055(d)(2), for battery powered equipment, the frequency stability shall be measured with reducing primary supply voltage to the battery operating end point, which is specified by the manufacture.
- c). According to FCC Part 90 Section 90.213, the frequency tolerance must be maintained within 0.00025% for 12.5KHz channel separation and 0.0005% for 25KHz channel separation.

### 6.2 Measurement Procedure

#### 6.2.1 Frequency stability versus environmental temperature

1. Setup the configuration per figure 1 for frequencies measurement inside an environment chamber, Install new battery in the EUT.
2. Turn on EUT and set SA center frequency to the EUT radiated frequency. Set SA Resolution Bandwidth to 1KHz and Video Resolution Bandwidth to 1KHz and Frequency Span to 50KHz. Record this frequency as reference frequency.
3. Set the temperature of chamber to  $60^{\circ}\text{C}$ . Allow sufficient time (approximately 30 min) for the temperature of the chamber to stabilize. While maintaining a constant temperature inside the chamber, turn the EUT on and measure the EUT operating frequency.
4. Repeat step 2 with a  $10^{\circ}\text{C}$  decreased per stage until the lowest temperature  $-30^{\circ}\text{C}$  is measured, record all measured frequencies on each temperature step.

#### 6.2.2 Frequency stability versus input voltage

1. Setup the configuration per figure 1 for frequencies measured at temperature if it is within  $15^{\circ}\text{C}$  to  $25^{\circ}\text{C}$ . Otherwise, an environment chamber set for a temperature of  $20^{\circ}\text{C}$  shall be used. The EUT shall be powered by DC 13.8V
2. Set SA center frequency to the EUT radiated frequency. Set SA Resolution Bandwidth to 1KHz and Video Resolution Bandwidth to 1KHz. Record this frequency as reference frequency.
3. Supply the EUT primary voltage at the operating end point which is specified by manufacturer and record the frequency.

### 6.3 Test Setup Block Diagram

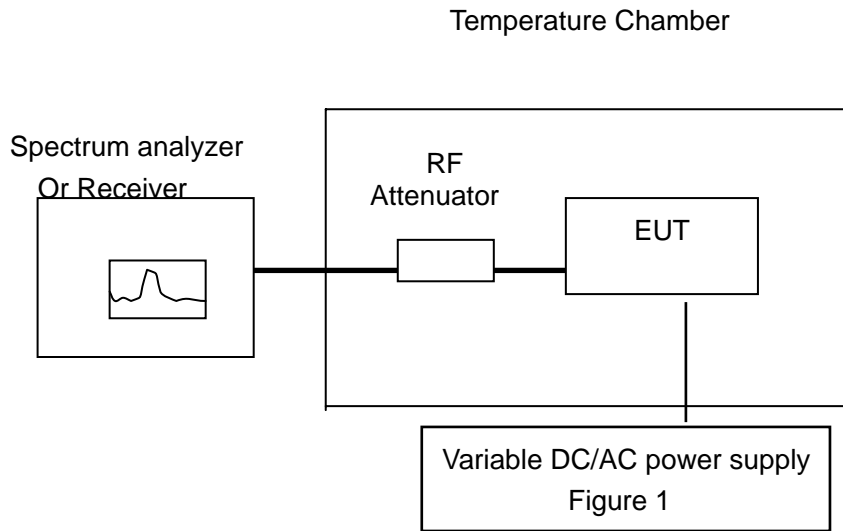

### 6.4 Test equipment used:

NAME OF EQUIPMENT	MANUFACTURER	MODEL	SERIAL NUMBER	CAL. DATE
SPECTRUM ANALYZER	AGILENT	E4446A	US44300399	2008-02-05
H & T CHAMBER	EXPERY	TN-440	TN2007SR038	2007-06-18

### 6.5 Test result

(1) Frequency stability versus input voltage (battery operation end point voltage is 6.1V)

#### Measurement Result for Channel Separation of 12.5 KHz

Channel	Reference Frequency (MHz)	Frequency Measured at end point voltage	Frequency Deviation (PPM)	Limit (PPM)
Top	519.975	519.974688	-0.60	2.5
Middle	485.025	485.024678	-0.66	2.5
Bottom	450.125	450.124686	-0.70	2.5

**Measurement Result for Channel Separation of 25KHz**

Channel	Reference Frequency (MHz)	Frequency Measured at end point voltage	Frequency Deviation (PPM)	Limit (PPM)
Top	519.975	519.974690	-0.60	5.0
Middle	485.025	485.024684	-0.65	5.0
Bottom	450.125	450.124692	-0.68	5.0

(2) Frequency stability versus ambient temperature

**Bottom Channel @ 12.5 KHz Channel Separations**

Reference Frequency: 450.125 MHz		Limit: 2.5PPM	
Environment Temperature (°C)	Power Supply (V)	Frequency deviation measured with time Elapse (10 minutes)	
		(MHz)	(PPM)
60	7.4	450.124557	-0.98
50	7.4	450.124583	-0.93
40	7.4	450.124616	-0.85
30	7.4	450.124651	-0.78
20	7.4	450.124686	-0.70
10	7.4	450.124711	-0.64
0	7.4	450.124743	-0.57
-10	7.4	450.124776	-0.50
-20	7.4	450.124802	-0.44
-30	7.4	450.124839	-0.36

**Middle Channel @ 12.5 KHz Channel Separations**

Reference Frequency: 485.025 MHz		Limit: 2.5PPM	
Environment Temperature (°C)	Power Supply (V)	Frequency deviation measured with time Elapse (10 minutes)	
		(MHz)	(PPM)
60	7.4	485.024536	-0.96
50	7.4	485.024578	-0.87
40	7.4	485.024609	-0.81
30	7.4	485.024646	-0.73
20	7.4	485.024678	-0.66
10	7.4	485.024713	-0.59
0	7.4	485.024751	-0.51
-10	7.4	485.024788	-0.44
-20	7.4	485.024816	-0.38
-30	7.4	485.024850	-0.31

**Top Channel @ 12.5KHz Channel Separation**

Reference Frequency: 519.975 MHz		Limit: 2.5PPM	
Environment Temperature (°C)	Power Supply (V)	Frequency deviation measured with time Elapse (10 minutes)	
		(MHz)	(PPM)
60	7.4	519.974561	-0.84
50	7.4	519.974596	-0.78
40	7.4	519.974629	-0.71
30	7.4	519.974652	-0.67
20	7.4	519.974688	-0.60
10	7.4	519.974723	-0.53
0	7.4	519.974757	-0.47
-10	7.4	519.974792	-0.40
-20	7.4	519.974838	-0.31
-30	7.4	519.974871	-0.25



**Bottom Channel @ 25 KHz Channel Separation**

Reference Frequency: 450.125 MHz		Limit: 5.0PPM	
Environment Temperature (°C)	Power Supply (V)	Frequency deviation measured with time Elapse (10 minutes)	
		(MHz)	(PPM)
60	7.4	485.024548	-0.93
50	7.4	485.024587	-0.85
40	7.4	485.024620	-0.78
30	7.4	485.024655	-0.71
20	7.4	485.024692	-0.64
10	7.4	485.024723	-0.57
0	7.4	485.024762	-0.49
-10	7.4	485.024797	-0.42
-20	7.4	485.024828	-0.35
-30	7.4	485.024869	-0.27

**Middle Channel @ 25 KHz Channel Separations**

Reference Frequency: 485.025 MHz		Limit: 5.0PPM	
Environment Temperature (°C)	Power Supply (V)	Frequency deviation measured with time Elapse (10 minutes)	
		(MHz)	(PPM)
60	7.4	485.024543	-0.94
50	7.4	485.024585	-0.86
40	7.4	485.024616	-0.79
30	7.4	485.024653	-0.72
20	7.4	485.024686	-0.65
10	7.4	485.024722	-0.57
0	7.4	485.024758	-0.50
-10	7.4	485.024791	-0.43
-20	7.4	485.024821	-0.37
-30	7.4	485.024857	-0.29

**Top Channel @ 25 KHz Channel Separation**

Reference Frequency: 173.975 MHz		Limit: 5.0PPM	
Environment Temperature (°C)	Power Supply (V)	Frequency deviation measured with time Elapse (10 minutes)	
		(MHz)	(PPM)
60	7.4	519.974567	-0.83
50	7.4	519.974599	-0.77
40	7.4	519.974634	-0.70
30	7.4	519.974658	-0.66
20	7.4	519.974693	-0.59
10	7.4	519.974729	-0.52
0	7.4	519.974762	-0.46
-10	7.4	519.974799	-0.39
-20	7.4	519.974842	-0.30
-30	7.4	519.974876	-0.24

## 7. EMISSION BANDWIDTH

### 7.1 Provisions Applicable

According to FCC Part 90 Section 90.209: The authorized bandwidth shall be 11.25 KHz for 12.5 KHz and 20 KHz for 25 KHz

### 7.2 Measurement Procedure

- 1). The EUT was placed on a turn table which is 0.8m above ground plane.
- 2). The EUT was modulated by 2.5 KHz Sine wave audio signal, The level of the audio signal employed is 16 dB greater than that necessary to produce 50% of rated system deviation. Rated system deviation is 2.5 kHz (12.5 kHz channel spacing) and 5 kHz (25 kHz channel spacing)
- 3). Set SPA Center Frequency = fundamental frequency, RBW=VBW= 300 Hz, Span =50 KHz.
- 4). Set SPA Max hold. Mark peak, -26 dB.

### 7.3 Test Setup Block Diagram

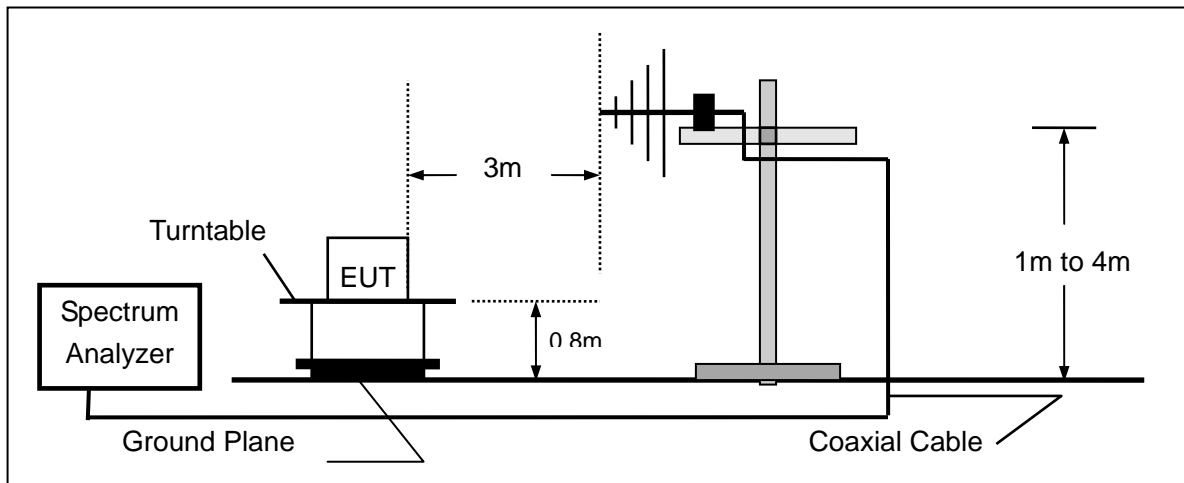

### 7.4 Measurement Equipment Used:

NAME OF EQUIPMENT	MANUFACTURER	MODEL	SERIAL NUMBER	CAL. DATE
SPECTRUM ANALYZER	AGILENT	E4446A	US44300399	2008-02-05
BROADBAND ANTENNA	R & S	HF562	10089	2007-06-09

**7.5 MEASUREMENT RESULT:**

26 dB Bandwidth Measurement Result						
Operating Frequency	12.5 KHz Channel Separation			25 KHz Channel Separation		
	Test Data	Limits	Result	Test Data	Limits	Result
Bottom Channel	10.17 KHz	11.25 KHz	Pass	15.41 KHz	20.00 KHz	Pass
Middle Channel	10.26 KHz	11.25 KHz	Pass	15.43 KHz	20.00 KHz	Pass
Top Channel	10.15 KHz	11.25 KHz	Pass	15.33 KHz	20.00 KHz	Pass

**Occupied bandwidth of Middle Channel @ 12.5KHz Channel Separation**

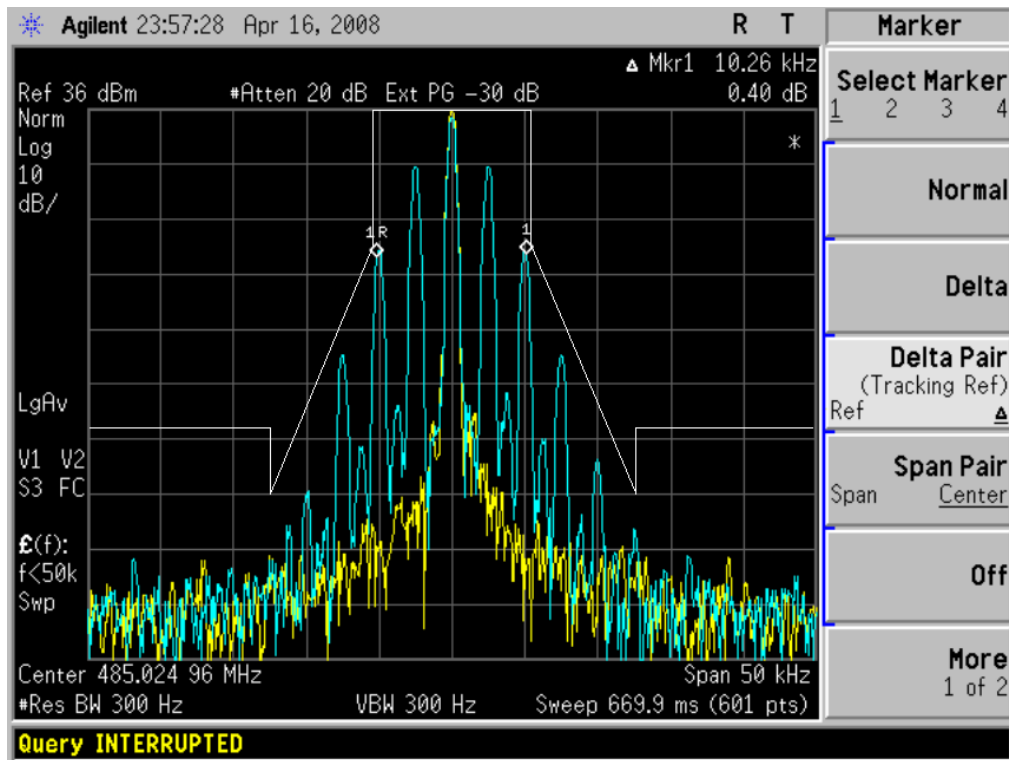

**Occupied bandwidth of Middle Channel @ 25 KHz Channel Separation**

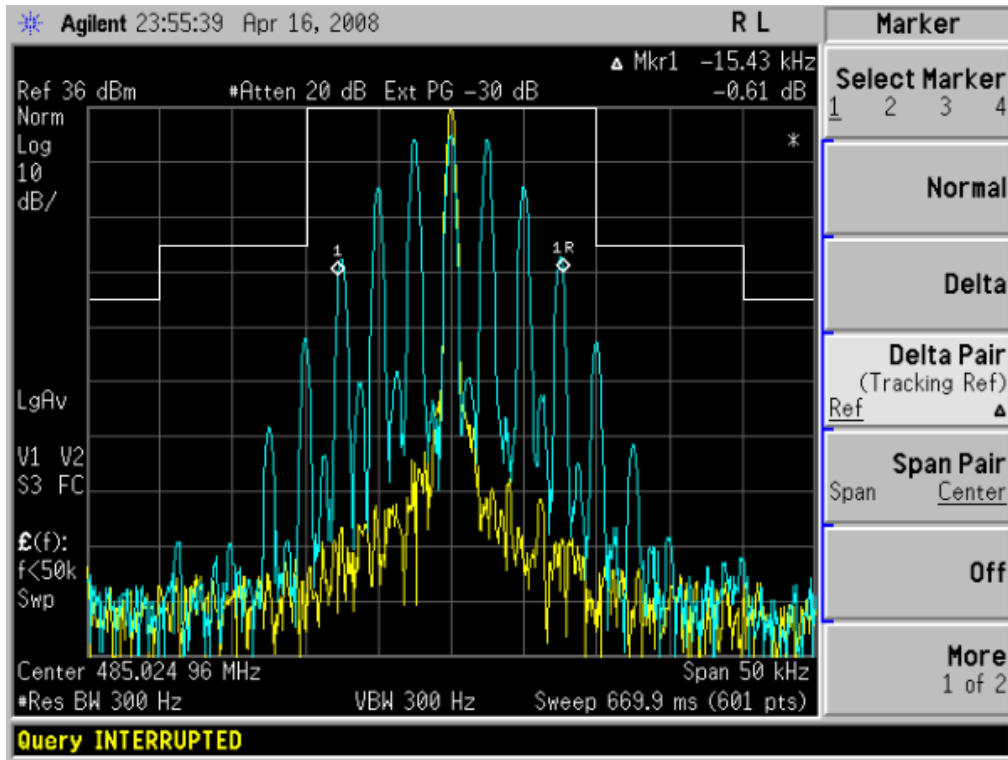

## 8. UNWANTED RADIATION

### 8.1 Provisions Applicable

8.1.1 According to Section 90.210, the power of each unwanted emission shall be less than Transmitted Power as specified below for transmitters designed to operate with 12.5 KHz channel bandwidth:

- (1). On any frequency removed from the center of the authorized bandwidth  $f_0$  to 5.625 KHz removed from  $f_0$ : Zero dB
- (2). On any frequency removed from the center of the authorized bandwidth by a displacement frequency  $(f_d \text{ in KHz})/f_0$  of more than 5.625 KHz but no more than 12.5 KHz: At least  $7.27(f_d - 2.88 \text{ KHz})$  dB
- (3). On any frequency removed from the center of the authorized bandwidth by a displacement Frequency  $(f_d \text{ in KHz})/f_0$  of more than 12.5 KHz: At least  $50 + 10 \log(P)$  dB or 70 dB, whichever is lesser attenuation.

8.1.2 According to Section 90.210, Emission mask B. For transmitters designed to transmit with 25KHz channel separation and equipped with an audio low-pass filter, the power of any emission must be attenuated below the unmodulated carrier power (P) as following:

- (1), On any frequency removed from the assigned frequency by more than 50 percent, but no more than 100 percent of the authorized bandwidth: At least 25 dB.
- (2), On any frequency removed from the assigned frequency by more than 100 percent, but no more than 250 percent of the authorized bandwidth: At least 35 dB.
- (3), On any frequency removed from the assigned frequency by more than 250 percent of the authorized bandwidth: At least  $43 + 10 \log(P)$  dB.

### 8.2 Measurement Procedure

- (1). On a test site, the EUT shall be placed on a turntable, and in the position closest to the normal use as declared by the user.
- (2). The test antenna shall be oriented initially for vertical polarization located 3m from the EUT to correspond to the transmitter.
- (3). The output of the antenna shall be connected to the measuring receiver and either a peak or quasi-peak detector was used for the measurement as indicated on the report. The detector selection is based on how close the emission level was approaching the limit.
- (4). The transmitter shall be switched on; if possible, without the modulation and the measurement receiver shall be tuned to the frequency of the transmitter under test.
- (5). The test antenna shall be raised and lowered through the specified range of height until the measuring receiver detects a maximum signal level.
- (6). The transmitter shall then be rotated through  $360^\circ$  in the horizontal plane, until the maximum signal level is detected by the measuring receiver.
- (7). The test antenna shall be raised and lowered again through the specified range of height until the measuring receiver detects a maximum signal level.
- (8). The maximum signal level detected by the measuring receiver shall be noted.
- (9). The measurement shall be repeated with the test antenna set to horizontal polarization.

- (10). Replace the antenna with a proper Antenna (substitution antenna).
- (11). The substitution antenna shall be oriented for vertical polarization and, if necessary, the length of the substitution antenna shall be adjusted to correspond to the frequency of transmitting.
- (12). The substitution antenna shall be connected to a calibrated signal generator.
- (13). If necessary, the input attenuator setting of the measuring receiver shall be adjusted in order to increase the sensitivity of the measuring receiver.
- (14). The test antenna shall be raised and lowered through the specified range of the height to ensure that the maximum signal is received.
- (15). The input signal to substitution antenna shall be adjusted to the level that produces a level detected by the measuring receiver, that is equal to the level noted while the transmitter radiated power was measured, corrected for the change of input attenuation setting of the measuring receiver.
- (16). The input level to the substitution antenna shall be recorded as power level in dBm, corrected for any change of input attenuator setting of the measuring receiver.
- (17). The measurement shall be repeated with the test antenna and the substitution antenna oriented for horizontal polarization.

### 8.3 Test Setup Block Diagram

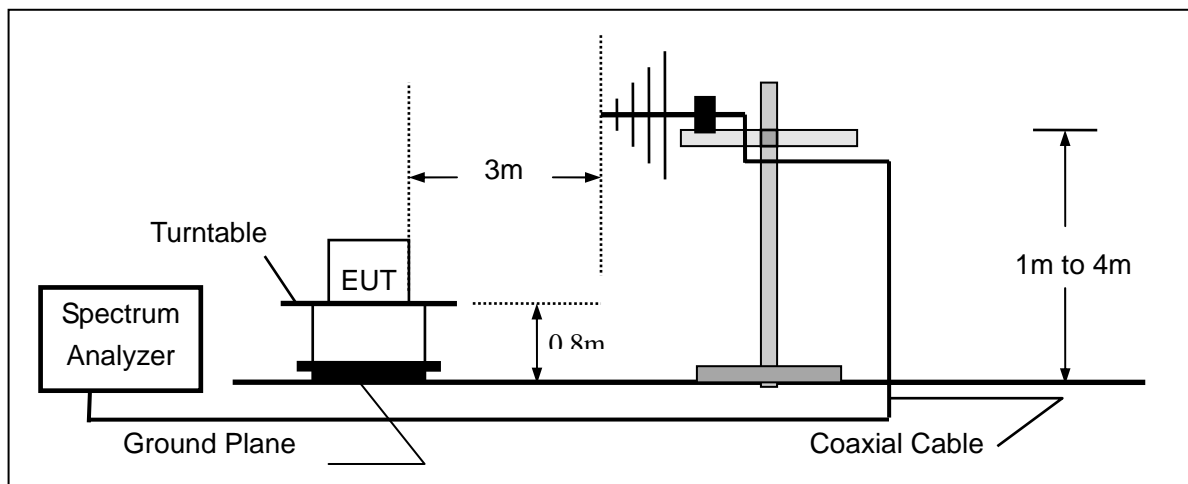

**SUBSTITUTION METHOD: (Radiated Emissions)**

**Radiated Below 1GHz**

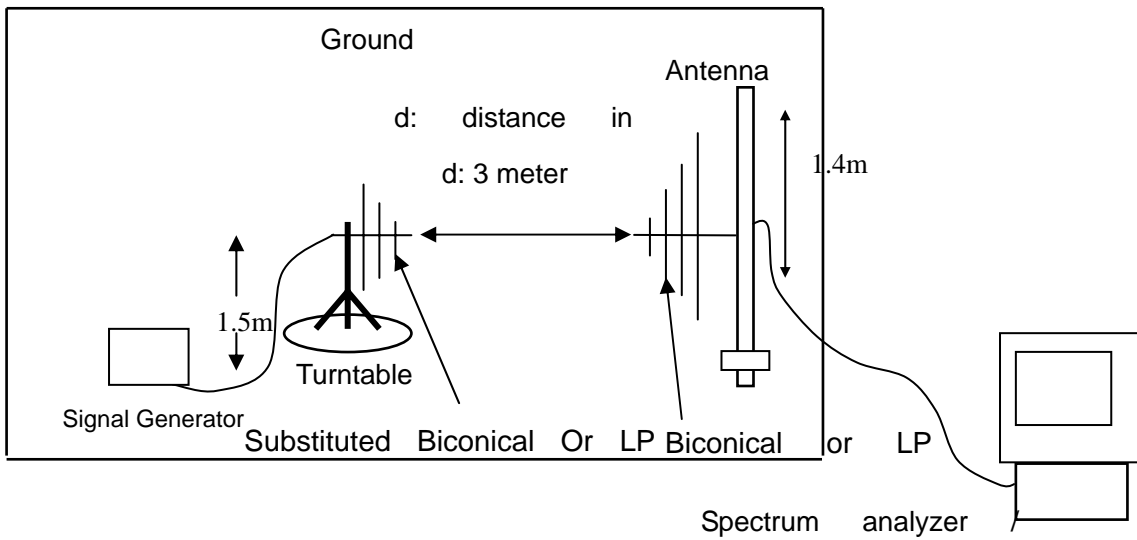

**Radiated Above 1 GHz**

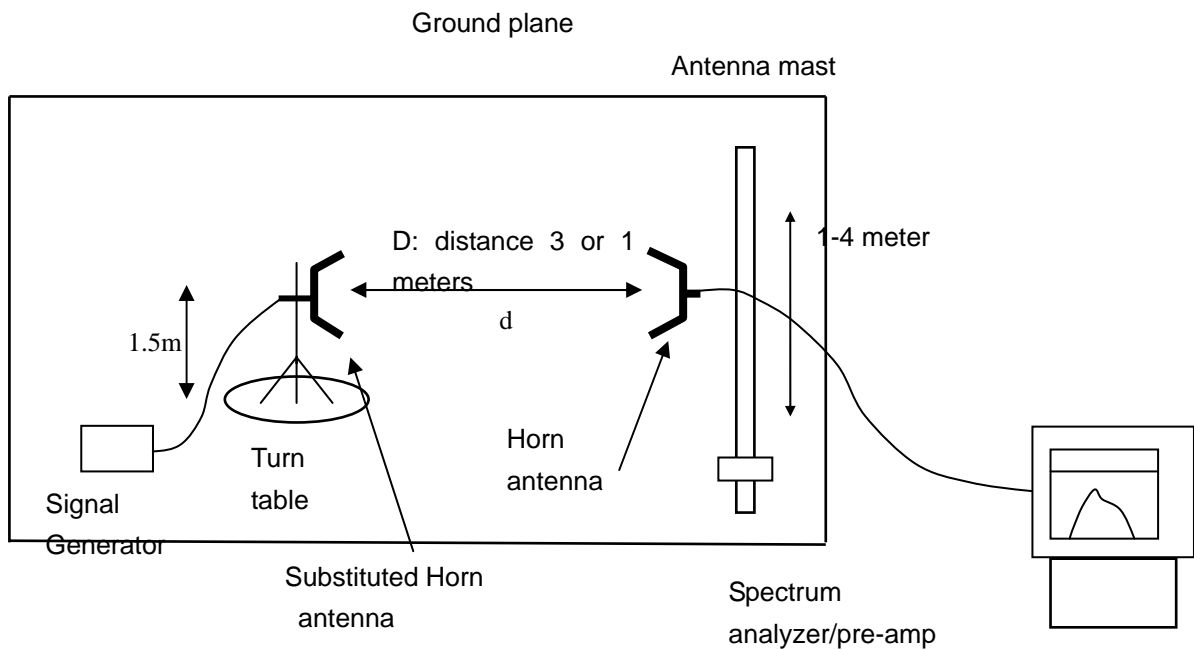



**8.4 Measurement Equipment Used:**

NAME OF EQUIPMENT	MANUFACTURER	MODEL	SERIAL NUMBER	CAL. DATE
BROADBAND ANTENNA	R & S	HF562	10089	2007-06-09
EMI TEST RECEIVER	R & S	ESIB26	100130/026	2007-06-10

**8.5 MEASUREMENT RESULTS:****Measurement Result for 12.5 KHz Channel Separation**

Calculation: Limit (dBm)= EL-50-10log<sub>10</sub> (TP)

Notes:

EL is the emission level of the Output Power expressed in dBm,, in this application, the EL is 36.99 dBm.

Limit (dBm)=36.99-50-10log<sub>10</sub> (5) = -20

**Bottom Channel**

Frequency (MHz)	Reading level (dBuV)	Antenna Polarization	S.G. (dBm)	Cable loss (dB)	Correction (dB)	Emission level (dBm)	Limit (dBm)	Margin (dB)
--	--	--	--	--	--	--	-20	--

**Middle Channel**

Frequency (MHz)	Reading level (dBuV)	Antenna Polarization	S.G. (dBm)	Cable loss (dB)	Correction (dB)	Emission level (dBm)	Limit (dBm)	Margin (dB)
--	--	--	--	--	--	--	-20	--

**Top Channel**

Frequency (MHz)	Reading level (dBuV)	Antenna Polarization	S.G. (dBm)	Cable loss (dB)	Correction (dB)	Emission level (dBm)	Limit (dBm)	Margin (dB)
--	--	--	--	--	--	--	-20	--

**Notes:**

“—” means that the emission level is too low to be measured or at least 20 dB down than the limit.

**Measurement Result For 25 KHz Channel Separation**

Calculation: Limit (dBm)= EL-43-10log10 (TP)

Notes: EL is the emission level of the Output Power expressed in dBm,, in this application, the EL is 10log10(P) dBm.

Limit (dBm)=10log10(P) - 43-10log 10 (P) = -13 dBm

**Bottom Channel**

Frequency (MHz)	Reading level (dBuV)	Antenna Polarization	S.G. (dBm)	Cable loss (dB)	Correction (dB)	Emission level (dBm)	Limit (dBm)	Margin (dB)
--	--	--	--	--	--	--	-13	--

**Middle Channel**

Frequency (MHz)	Reading level (dBuV)	Antenna Polarization	S.G. (dBm)	Cable loss (dB)	Correction (dB)	Emission level (dBm)	Limit (dBm)	Margin (dB)
--	--	--	--	--	--	--	-13	--

**Top Channel**

Frequency (MHz)	Reading level (dBuV)	Antenna Polarization	S.G. (dBm)	Cable loss (dB)	Correction (dB)	Emission level (dBm)	Limit (dBm)	Margin (dB)
--	--	--	--	--	--	--	-13	--

**Notes:**

“—“ means that the emission level is too low to be measured or at least 20 dB down than the limit.

### 8.6 Emission Mask Plot

The detailed procedure employed for Emission Mask measurements are specified as following:

- The transmitter shall be modulated by a 2.5 kHz audio signal,
- The level of the audio signal employed is 16 dB greater than that necessary to produce 50% of rated system deviation. Rated system deviation is 2.5 kHz (12.5 kHz channel spacing) and 5 kHz (25 kHz channel spacing)

#### The Worst Emission Mask for 12.5 KHz channel Separation

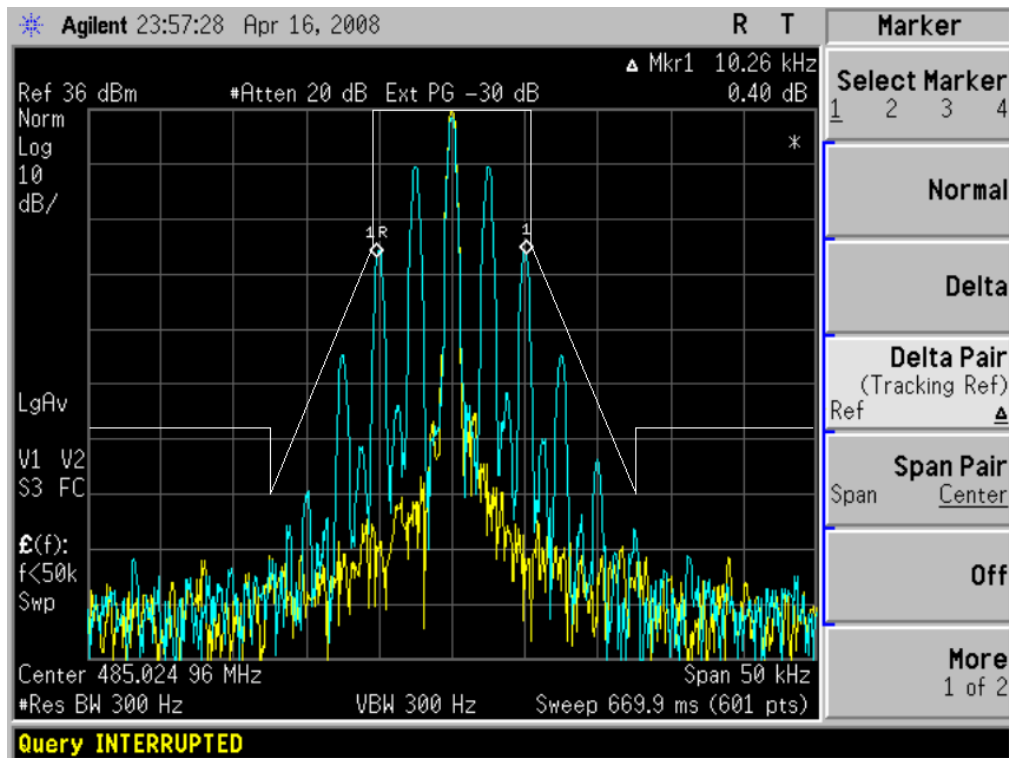

### The Worst Emission Mask for 25 KHz channel Separation

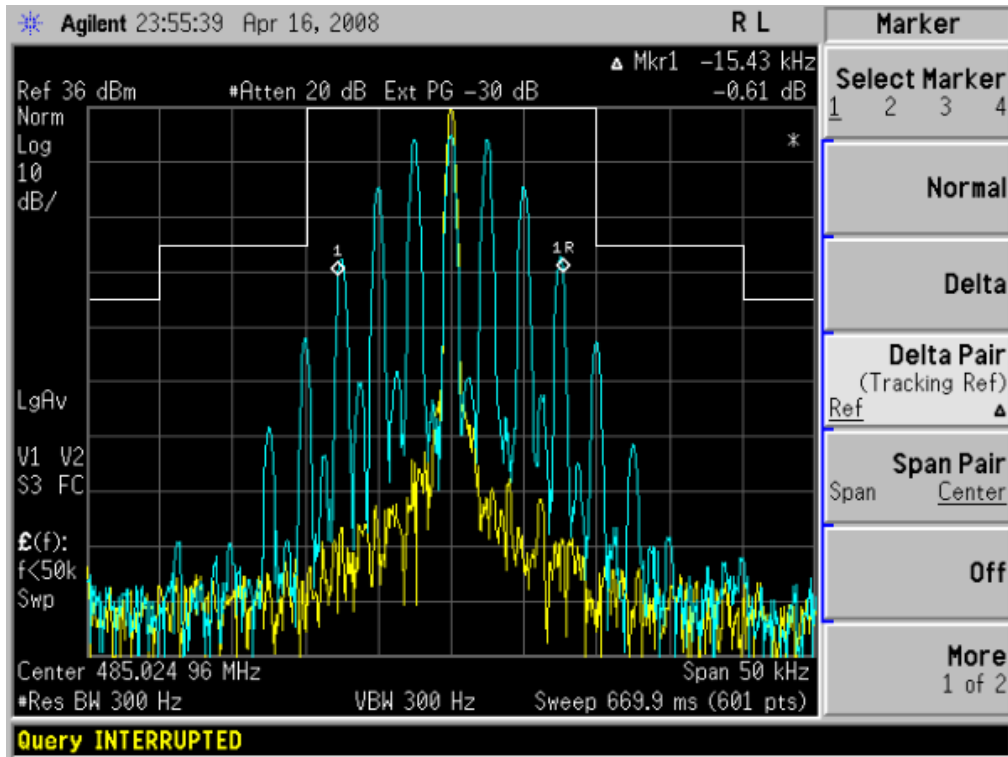

## 9. MODULATION CHARACTERISTICS

### 9.1 Provisions Applicable

According to CFR 47 section 2.1047(a), for Voice Modulation Communication Equipment, the frequency response of the audio modulation circuit over a range of 100 to 5000Hz shall be measured.

### 9.2 Measurement Method

#### 9.2.1 Modulation Limit

- (1). Configure the EUT as shown in figure 1, adjust the audio input for 60% of rated system deviation at 1KHz using this level as a reference (0dB) and vary the input level from -20 to +20dB. Record the frequency deviation obtained as a function of the input level.
- (2). Repeat step 1 with input frequency changing to 300, 1000, and 2500Hz in sequence.

#### 9.2.2 Audio Frequency Response

- (1). Configure the EUT as shown in figure 1.
- (2). Adjust the audio input for 20% of rated system deviation at 1 KHz using this level as a reference (0 dB).
- (3). Vary the Audio frequency from 100 Hz to 10 KHz and record the frequency deviation.
- (4). Audio Frequency Response =  $20\log_{10}$  (Deviation of test frequency/Deviation of 1KHz reference).

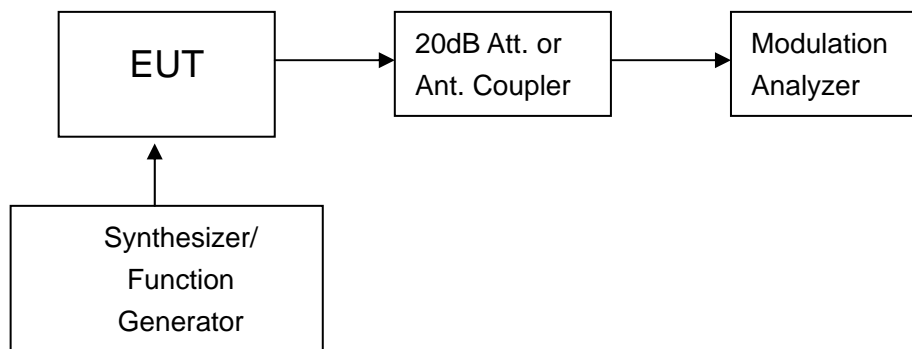

**Figure 1: Modulation characteristic measurement configuration**

### 9.3 Measurement Instruments

NAME OF EQUIPMENT	MANUFACTURER	MODEL	SERIAL NUMBER	CAL. DATE
RF COMMUNICATIONS TEST SET	HP	8920B	--	2008.02.10

**9.4 Measurement Result**

**(a). Modulation Limit:**

**Middle Channel @ 12.5 KHz Channel Separations**

Modulation Level (dB)	Peak Freq. Deviation At 300 Hz	Peak Freq. Deviation At 1000 Hz	Peak Freq. Deviation At 1500 Hz	Peak Freq. Deviation At 2500 Hz
-20	0.03	0.16	0.26	0.50
-15	0.06	0.29	0.47	0.89
-10	0.10	0.52	0.84	1.42
-5	0.19	0.93	1.47	1.56
0	0.33	1.50	1.69	1.59
+5	0.60	1.70	1.74	1.61
+10	0.81	1.63	1.75	1.61
+15	0.81	1.62	1.75	1.62
+20	0.82	1.63	1.75	1.62

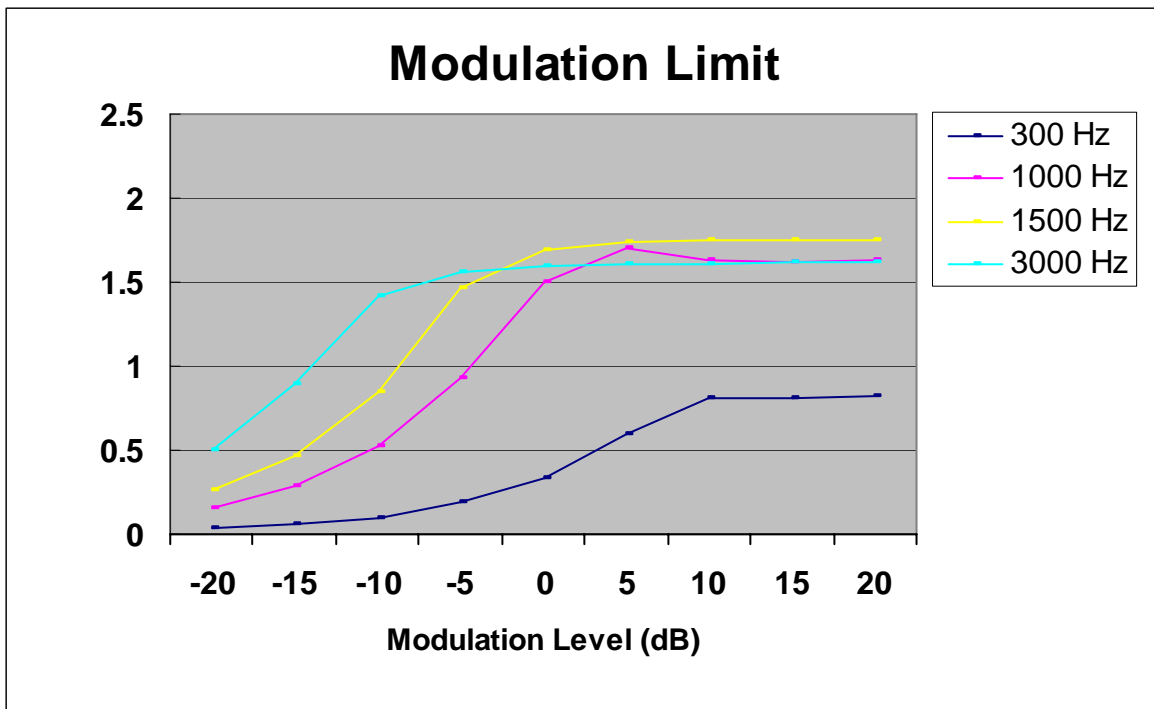

**Middle Channel @ 25KHz Channel Separation**

Modulation Level (dB)	Peak Freq. Deviation At 300 Hz	Peak Freq. Deviation At 1000 Hz	Peak Freq. Deviation At 1500 Hz	Peak Freq. Deviation At 2500 Hz
-20	0.08	0.31	0.48	0.89
-15	0.13	0.54	0.86	1.59
-10	0.24	0.97	1.53	2.72
-5	0.42	1.74	2.73	3.09
0	0.75	2.97	3.41	3.19
+5	1.35	3.45	3.55	3.21
+10	1.99	3.38	3.56	3.22
+15	1.95	3.35	3.57	3.22
+20	1.96	3.33	3.57	3.22

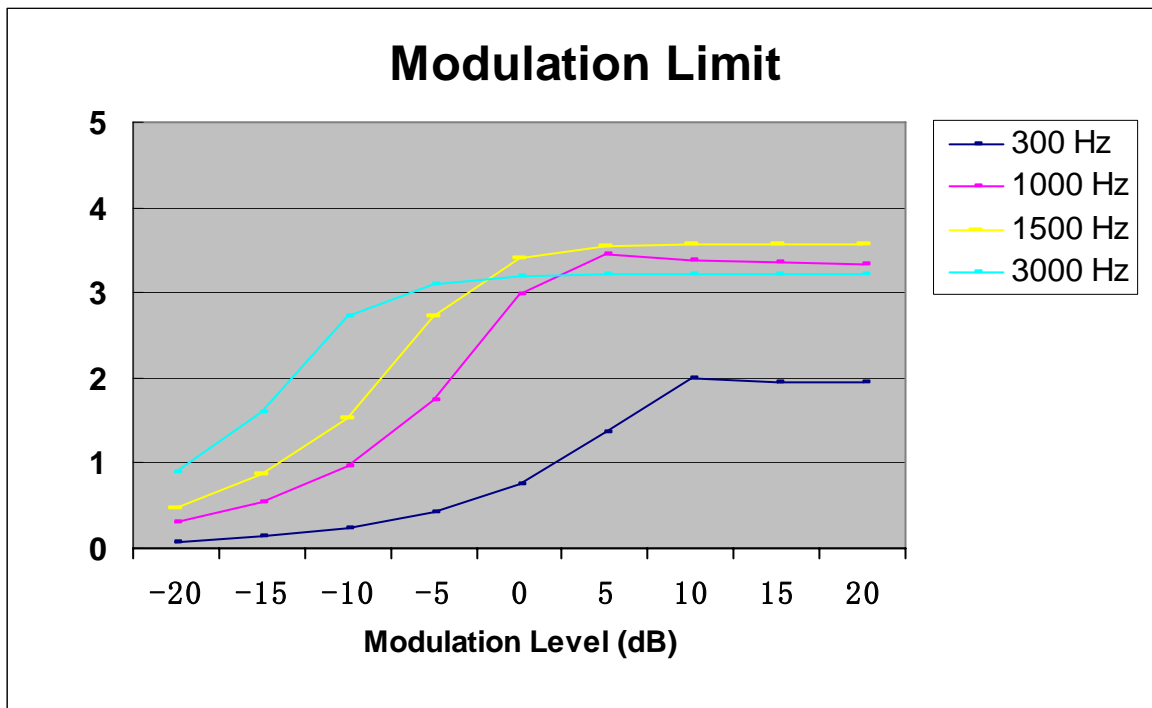



**AUDIO LOW PASS FILTER RESPONSE**

**Narrow band (12.5KHz Channel Separation)**

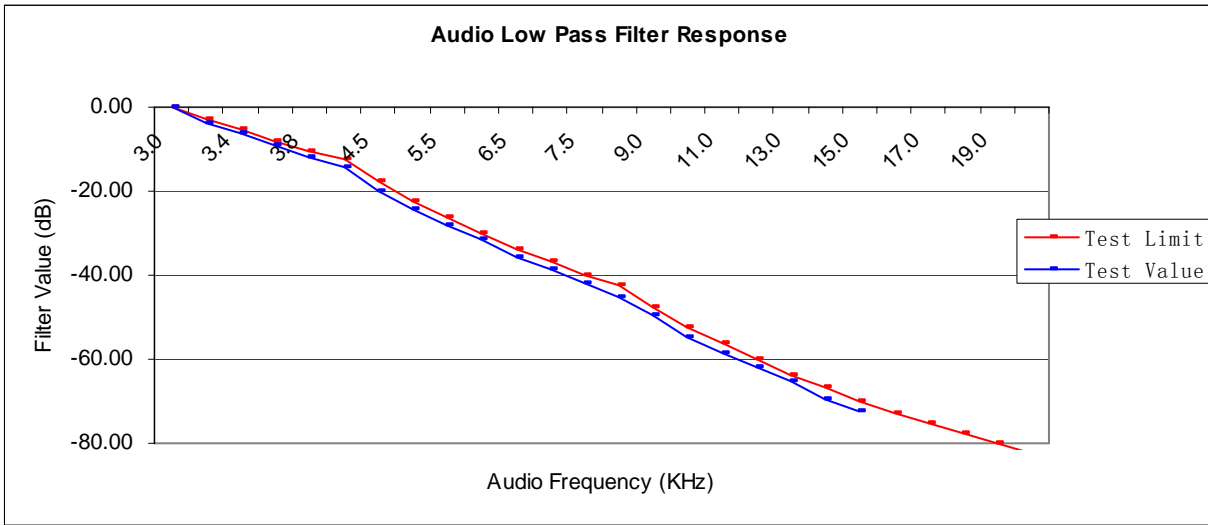

**Wide band (25.0 KHz Channel Separation)**

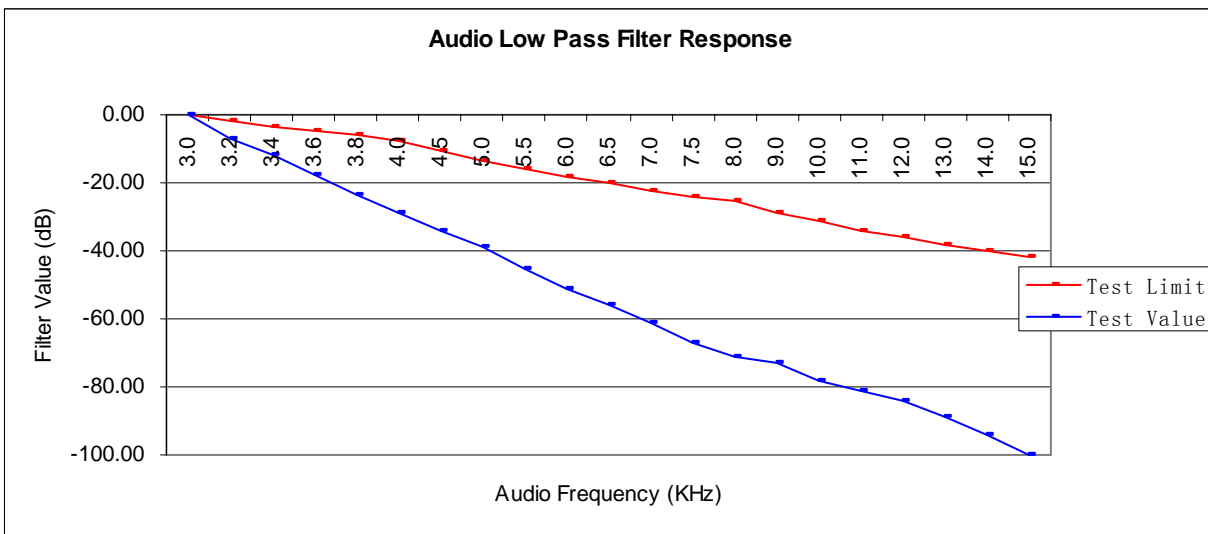

**(b). Audio Frequency Response:****25.0 KHz Channel Separations**

<b>Frequency (Hz)</b>	<b>Deviation (KHz)</b>
100	--
200	--
300	0.24
400	0.34
500	0.43
600	0.55
700	0.66
800	0.78
900	0.89
1000	1.00
1200	1.22
1400	1.45
1600	1.69
1800	1.93
2000	2.17
2200	2.42
2400	2.64
2600	2.82
2800	2.86
3000	2.74
3200	2.51
3400	2.18
3600	1.83
3800	1.50
4000	1.22
4500	0.70
5000	0.44
5500	0.28
6000	0.18
6500	0.11
7000	0.07
7500	0.04
8000	--
8500	--
9000	--
9500	--
10000	--

### Frequency Response of Middle Channel

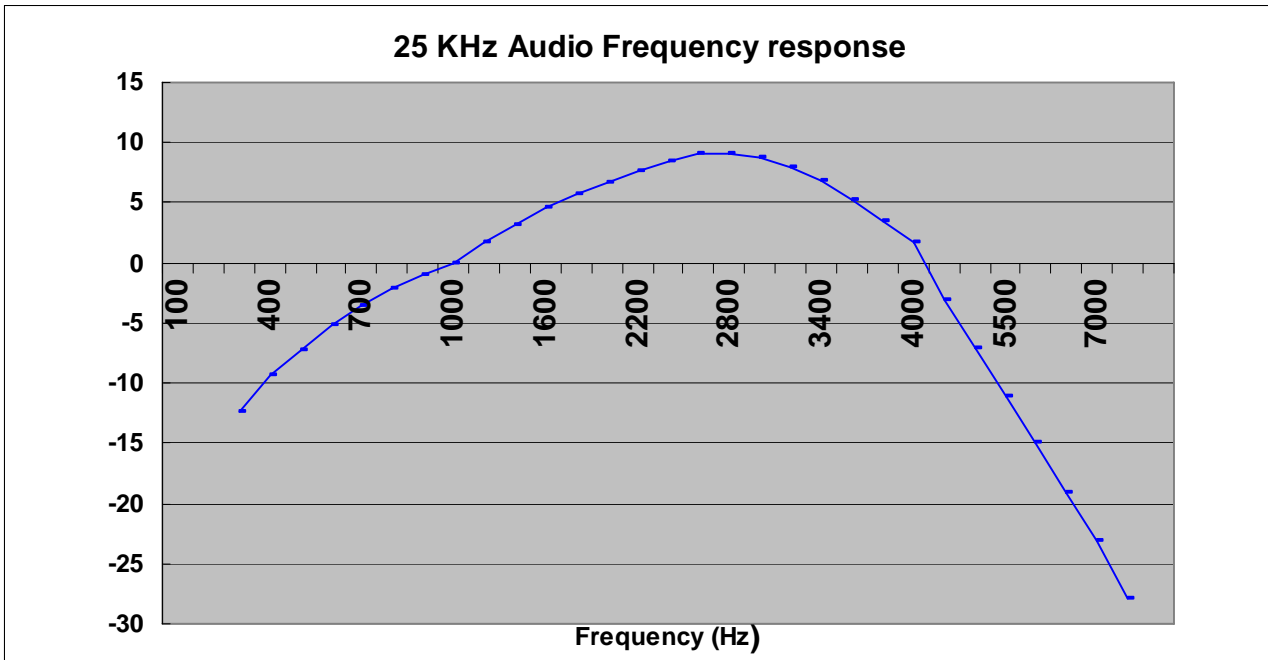

**12.5 KHz Channel Separation**

<b>Frequency (Hz)</b>	<b>Deviation (KHz)</b>
100	--
200	--
300	0.10
400	0.15
500	0.20
600	0.26
700	0.32
800	0.38
900	0.44
1000	0.50
1200	0.62
1400	0.74
1600	0.87
1800	1.00
2000	1.13
2200	1.25
2400	1.37
2600	1.45
2800	1.46
3000	1.40
3200	1.27
3400	1.11
3600	0.93
3800	0.76
4000	0.62
4500	0.36
5000	0.22
5500	0.14
6000	0.09
6500	0.06
7000	0.04
7500	--
8000	--
8500	--
9000	--
9500	--
10000	--

### Frequency Response of Middle Channel

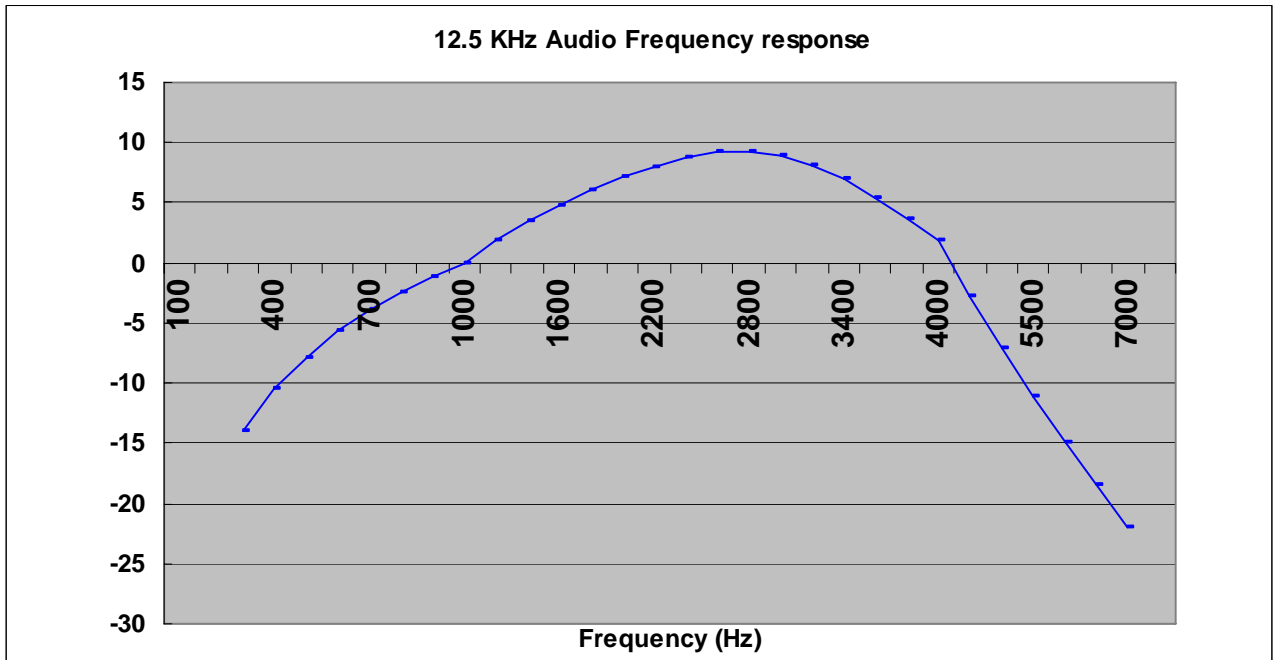

## 10. MAXIMUM TRANSMITTER POWER (CONDUCTED OUTPUT POWER)

### 10.1 Provisions Applicable

Per FCC §2.1046 and §90.205: Maximum ERP is dependent upon the station's antenna HAAT and required service area.

### 10.2 Test Procedure

The RF output of transceiver was conducted to a spectrum analyzer through an appropriate attenuator.

### 10.3 Test Instruments

NAME OF EQUIPMENT	MANUFACTURER	MODEL	SERIAL NUMBER	CAL. DATE
SPECTRUM ANALYZER	AGILENT	E4446A	US44300399	2008-02-05

### 10.4 Test Result

The maximum Conducted Power (CP) is

5W /1W for 12.5 KHz Channel Separation

5W /1W for 25.0 KHz Channel Separation

Calculation Formula:  $CP = R + A + L$

\* Note:

CP: The final Conducted Power

R : The reading value from spectrum analyzer

A : The attenuation value of the used attenuator

L : The loss of all connection cables

Conducted Power Measurement Results			
Channel Separation	Channel	Measurement Result	
12.5 KHZ	BOTTOM	36.81 dBm	29.68 dBm
	MIDDLE	36.73 dBm	29.64 dBm
	TOP	36.78 dBm	29.67 dBm
25 KHZ	BOTTOM	36.80 dBm	29.67 dBm
	MIDDLE	36.73 dBm	29.64 dBm
	TOP	36.77 dBm	29.67 dBm

### 10.5 Conduct spurious plot

#### The Worst Case(5w) of The Three Channels for Conduct Spurious Emission @ 12.5KHz

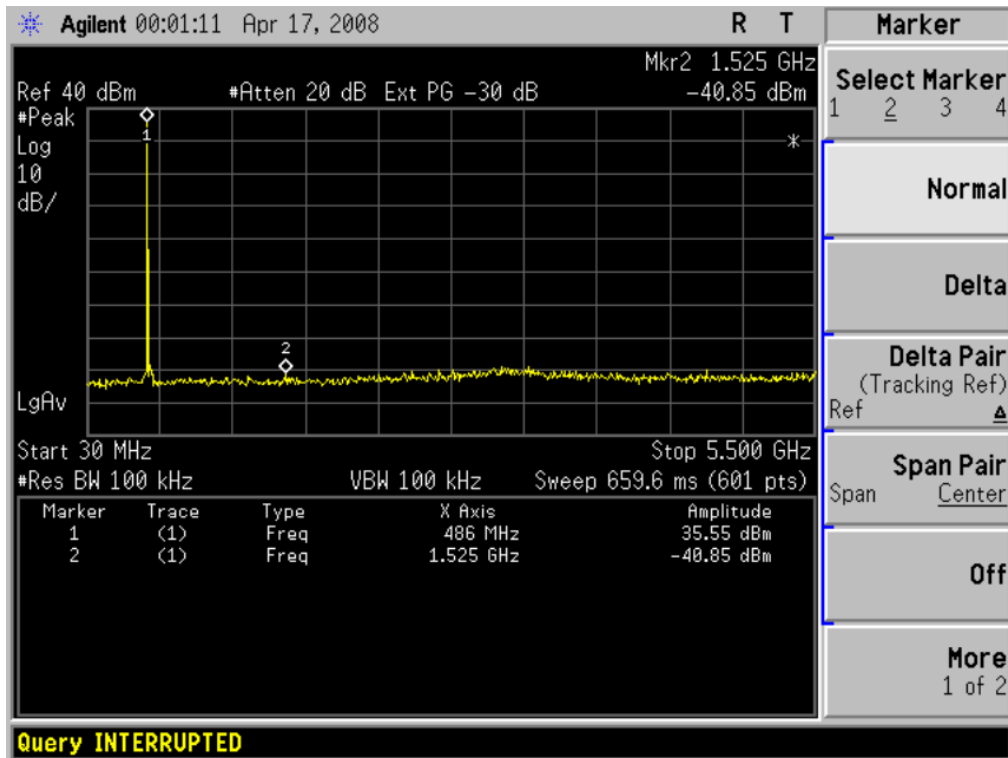

#### The Worst Case of The Three Channels for Conduct Spurious Emission @ 25KHz

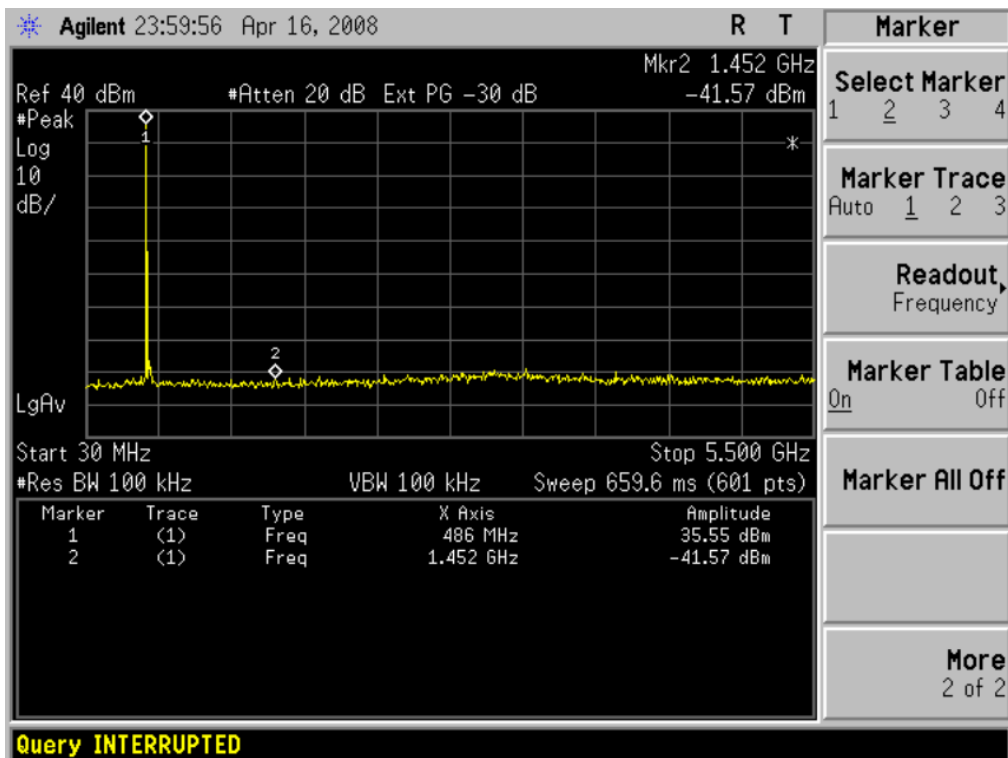

**The Worst Case(1w) of The Three Channels for Conduct Spurious Emission @ 12.5KHz**

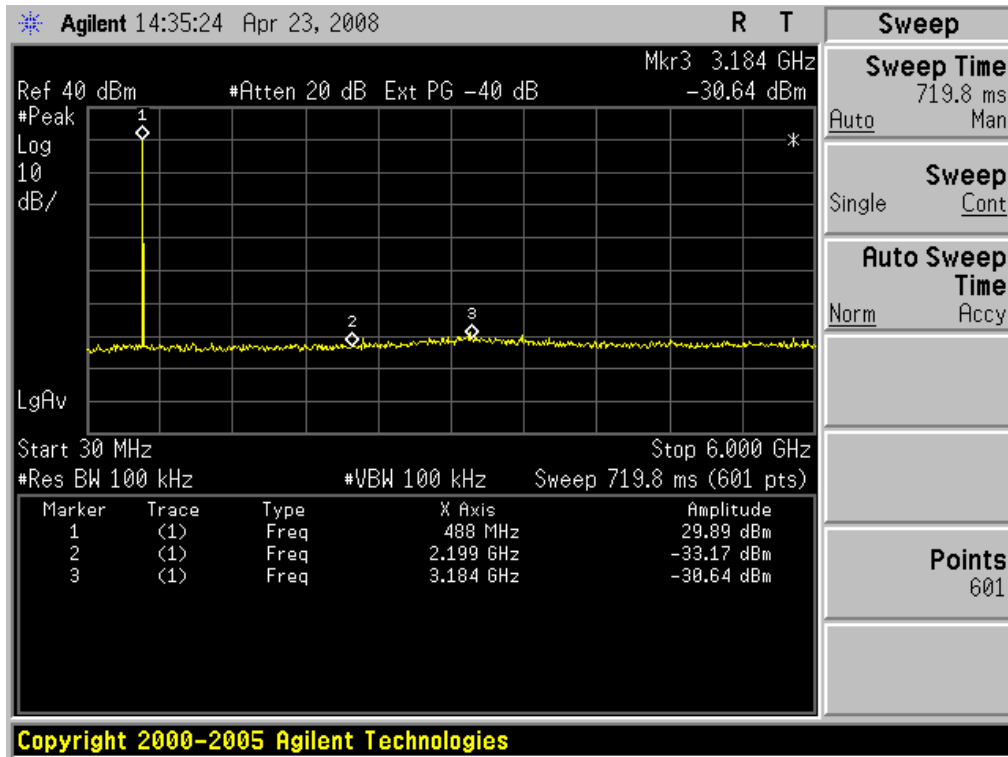

**The Worst Case(1w) of The Three Channels for Conduct Spurious Emission @ 25.0KHz**

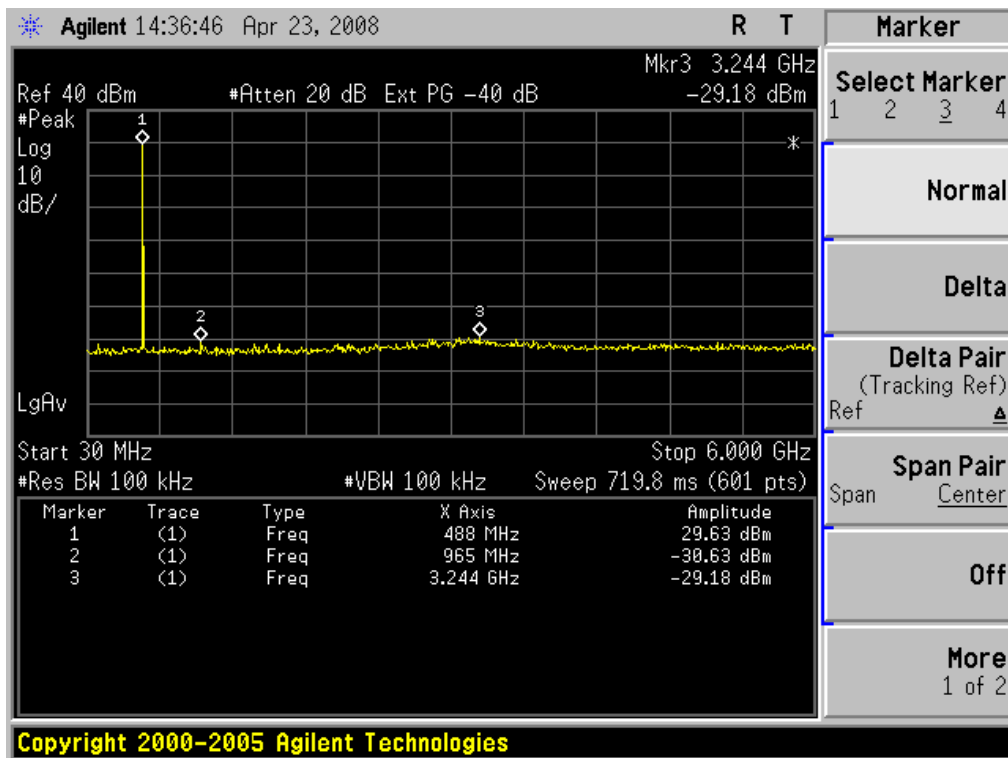



## 11.RANSMITTER FREQUENCY BEHAVIOR

### 11.1 Provisions Applicable

Section 90.214

### 11.2 Test Method

TIA/EIA-603 2.2.19

### 11.3 Test Instruments

NAME OF EQUIPMENT	MANUFACTURER	MODEL	SERIAL NUMBER	CAL. DATE
OSILLICOPE	TEKTRONIX	TDS3012B	B042290	2007-03-07
RF SIGNAL GENERATOR	IFA	2023B	202307/883	2007-03-07

### 11.4 Measure Result

Transmitter Frequency Behavior @ 25KHz Channel Separation-----Off to On

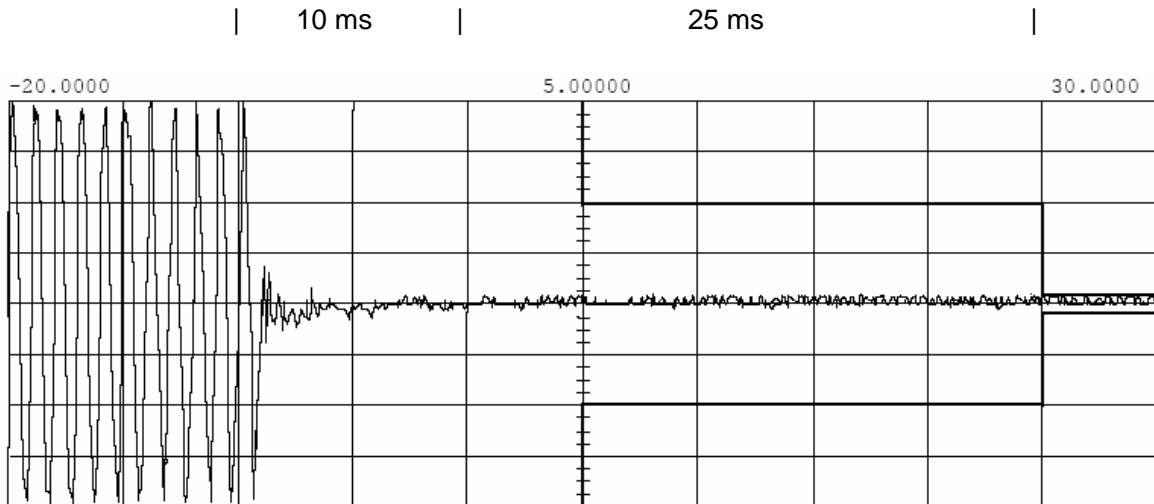

Main	Timebase 5.00 ms/div	Delay/Pos -20.0000 ms	Left	Measurements V p-p (c1) = 39.223 mV Frequency (c1) = 1.00000 kHz
Channel 1	Sensitivity 66.0 mV/div	Offset 0.00000 v	Probe 1.000 :1	

Trigger mode :  
On Negative Edge Of  
Trigger  
Chan2 = -440.000 mV (noise)  
Holdoff =-40.000

Transmitter Frequency Behaviour @ 25 KHz Channel Separation-----On to Off

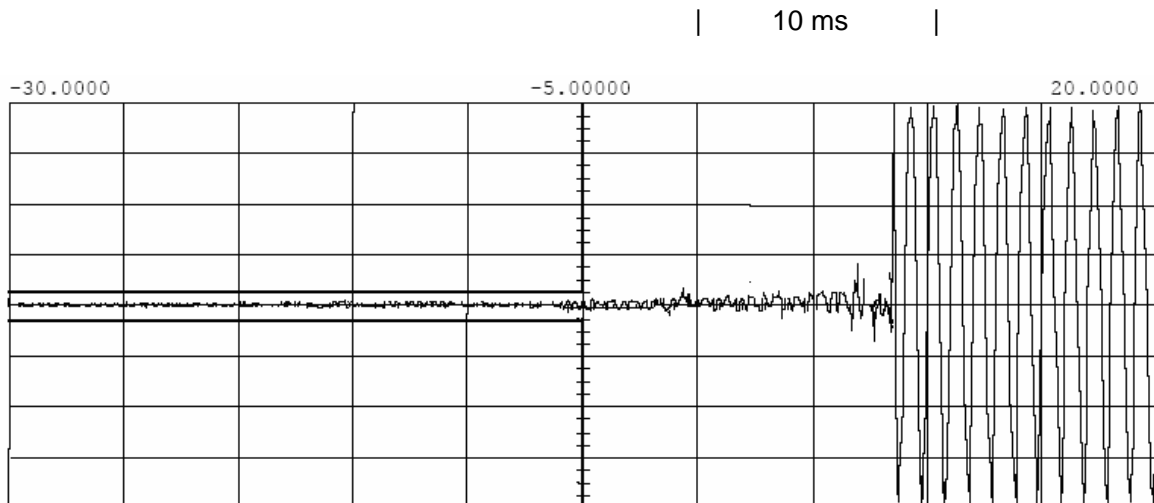

Main	Timebase 5.00 ms/div	Delay/Pos 20.0000 ms	Right	Measurements V p-p (c1) = 39.221 mV Frequency (c1) = 1.00000 kHz
Channel 1	Sensitivity 66.0 mV/div	Offset 0.00000 v	Probe 1.000 :1	

Trigger mode :  
On Positive Edge Of  
Trigger  
Chan2 = -100.000 mV (noise)  
Holdoff =-40.000

Transmitter Frequency Behaviour @ 12.5 KHz Channel Separation-----Off to On

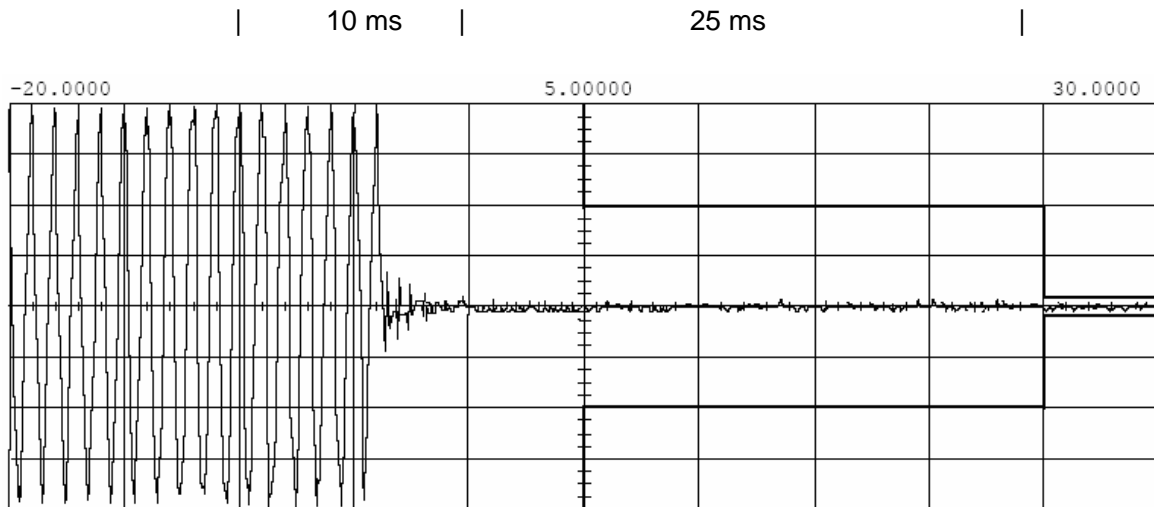

Main	Timebase 5.00 ms/div	Delay/Pos -20.0000 ms	Left	Measurements V p-p (c1) = 30.770 mV frequency (c1) = 1.00000 kHz
Channel 1	Sensitivity 122 mV/div	Offset 0.00000 V	Probe 1.000 :1	

Trigger mode :  
On Negative Edge Of  
Trigger  
Chan2 = -970.000 mV (noise)  
Holdoff =-40.000

Transmitter Frequency Behaviour @ 12.5 KHz Channel Separation-----On to Off

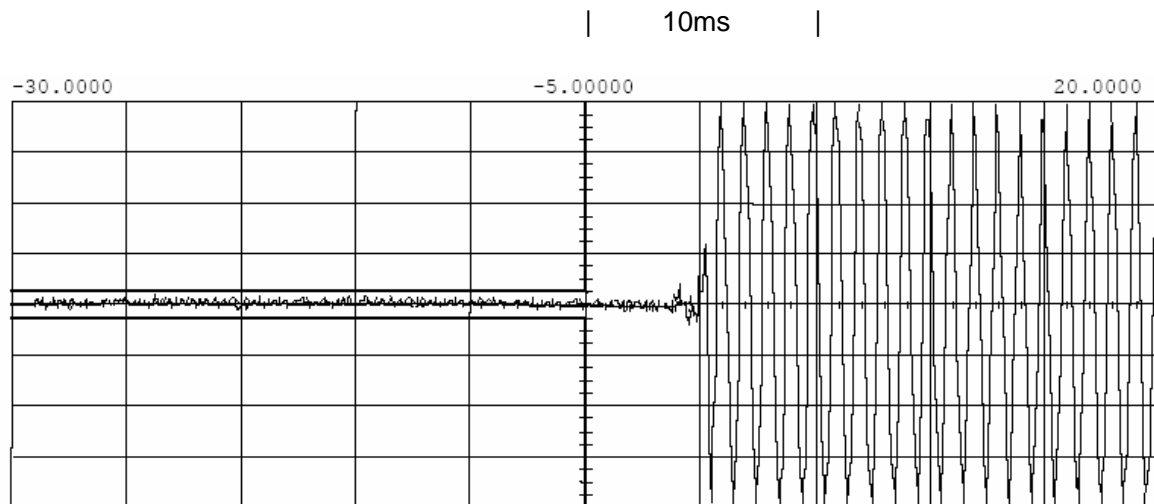

Main	Timebase 5.00 ms/div	Delay/Pos 20.0000 ms	Right	Measurements V p-p (c1) = 30.773 mV frequency (c1) = 1.00000 kHz
Channel 1	Sensitivity 122 mV/div	Offset 0.00000 V	Probe 1.000 :1	

Trigger mode :  
On Positive Edge Of  
Trigger  
Chan2 = -100.000 mV (noise)  
Holdoff =-40.000

## 12. Radiated Emission on Receiving Mode

### 12.1 Provisions Applicable

FCC Part 15 Subpart B Section 15.109

### 12.2 Test Method

ANSI C 63.4: 2003

### 12.3 Test Instruments

NAME OF EQUIPMENT	MANUFACTURER	MODEL	SERIAL NUMBER	CAL. DATE
BROADBAND ANTENNA	R & S	HF562	10089	2007-06-09
EMI TEST RECEIVER	R & S	ESIB26	100130/026	2006-06-10

### 12.4 Measure Result (Measured at 3m using FCC Part15 B Limits) RADIATED EMISSIONT – HORIZONTAL

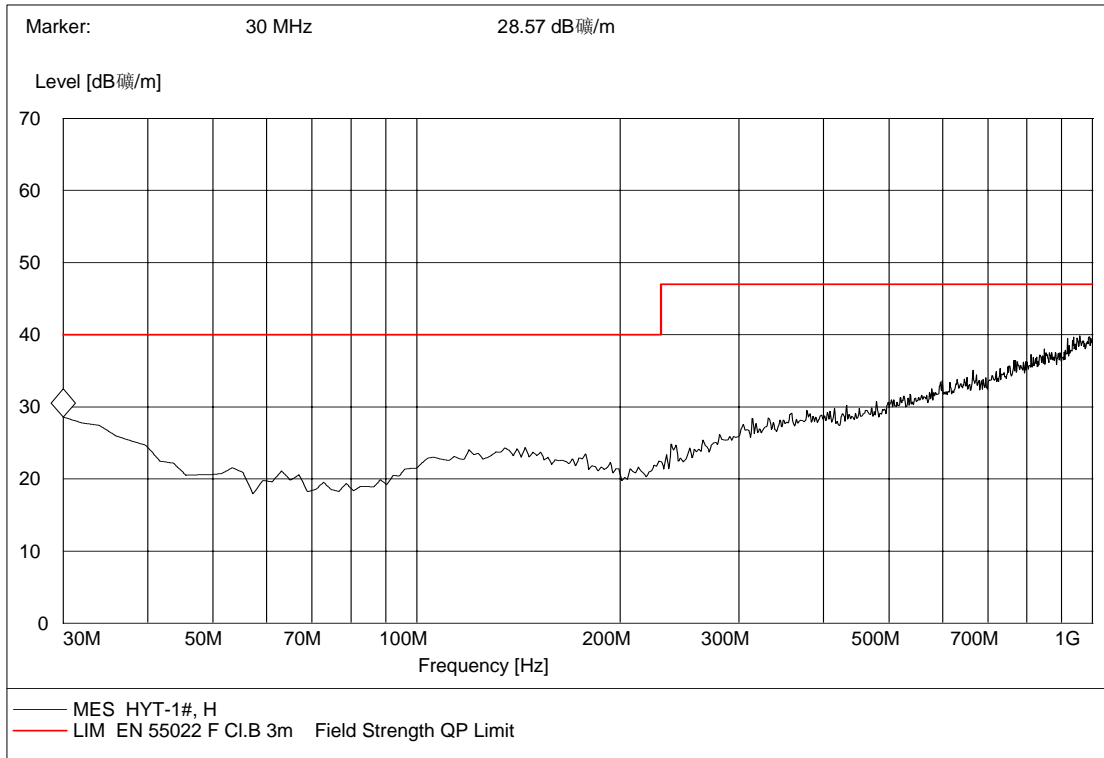

### RADIATED EMISSIONT – VERTICAL

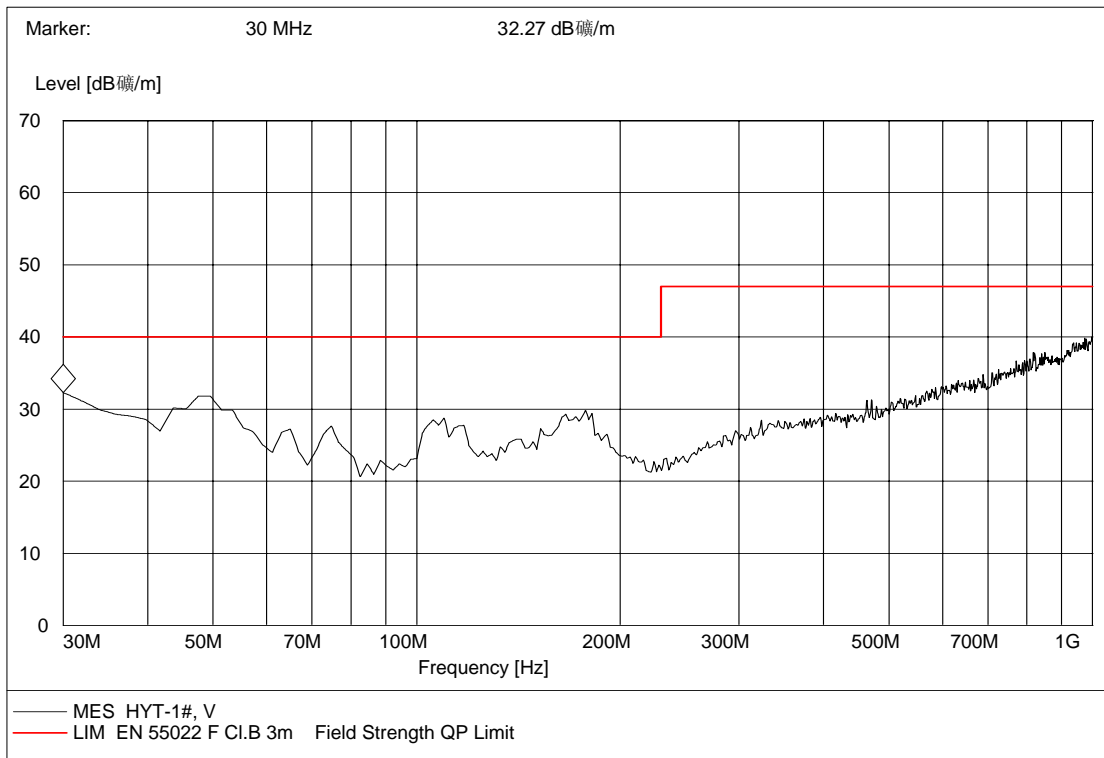

## **APPENDIX I PHOTOGRAPHS OF SETUP**

### RADIATED TEST SETUP



## **APPENDIX II EXTERNAL VIEW OF EUT**



TOP VIEW OF EUT



BOTTOM VIEW OF EUT



LEFT VIEW OF EUT



RIGHT VIEW OF EUT



FRONT VIEW OF EUT



BACK VIEW OF EUT



INTERNAL VIEW-1 OF EUT

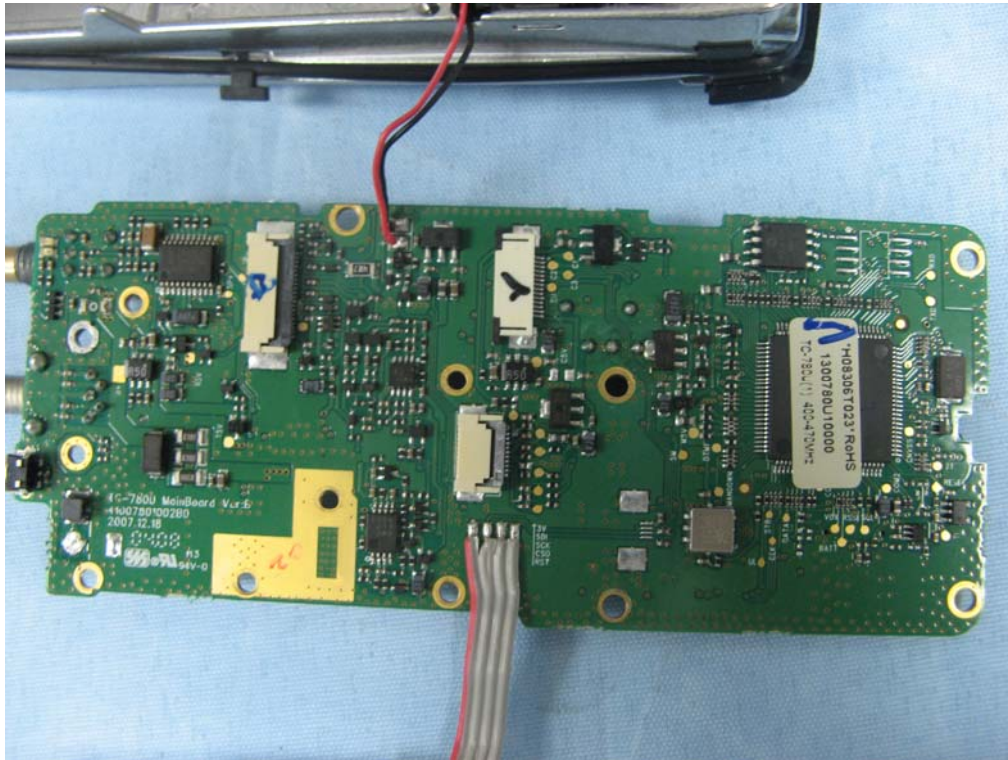

INTERNAL VIEW-2 OF EUT

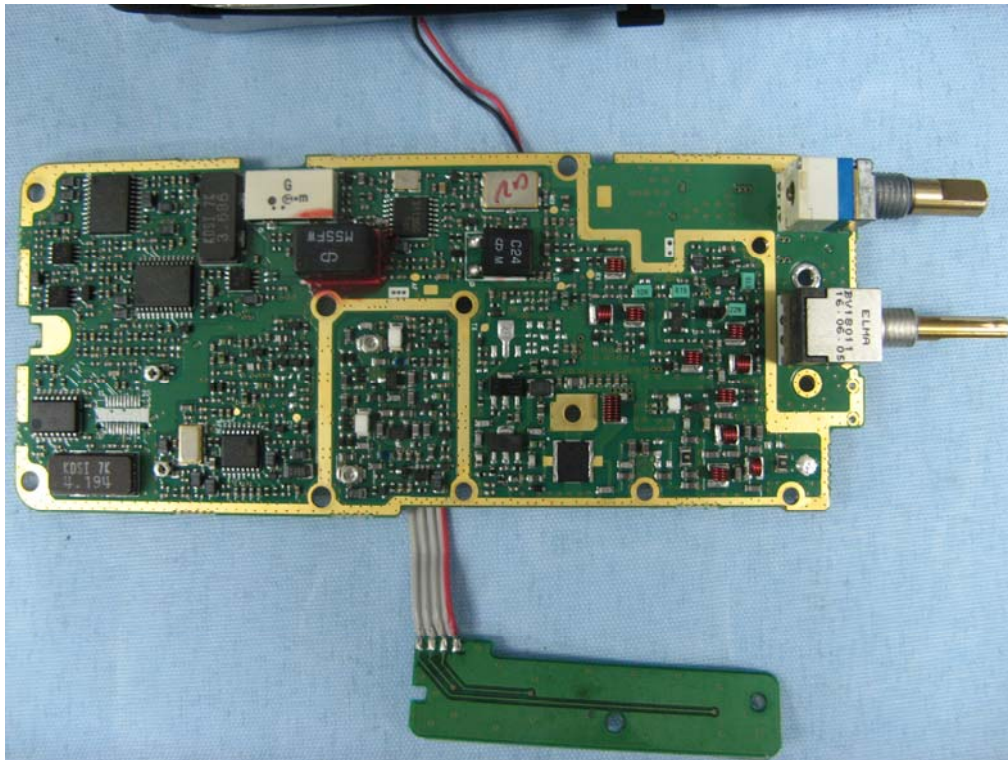

INTERNAL VIEW-3 OF EUT



INTERNAL VIEW-4 OF EUT

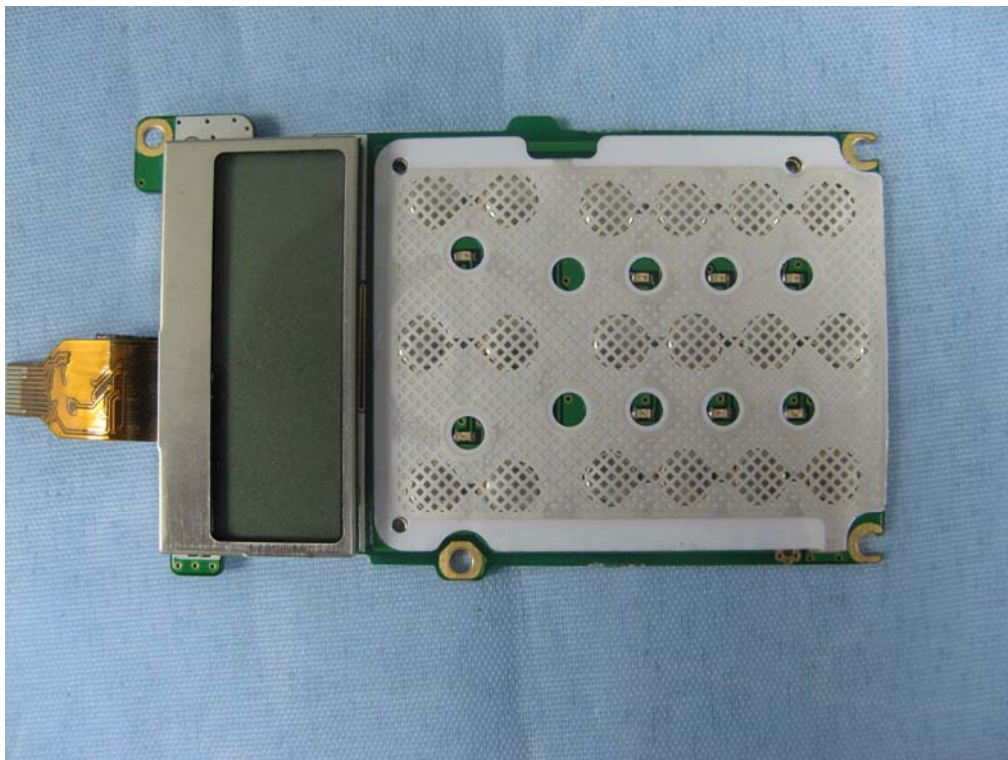

----END OF REPORT----