



RF TEST REPORT

Product Name: Smart Phone

Model Name: CP12p

FCC ID: R38YLCP12P

Issued For : Yulong Computer Telecommunication Scientific (Shenzhen) Co., Ltd
Floor 21, Block A, Coolpad Building, Intersection of Keyuan Avenue and Baoshen Road, North High-Tech Industrial Park, Nanshan District, Shenzhen, Guangdong, China

Issued By : Shenzhen LGT Test Service Co., Ltd.
Room 205, Building 13, Zone B, Chen Hsong Industrial Park, No.177 Renmin West Road, Jinsha Community, Kengzi Street, Pingshan New District, Shenzhen, China

Report Number: LGT23C004RF06

Sample Received Date: Mar. 02, 2023

Date of Test: Mar. 02, 2023 ~ Mar. 23, 2023

Date of Issue: Mar. 23, 2023

The test report is effective only with both signature and specialized stamp. This report shall not be reproduced except in full without the written approval of the Laboratory. The results in this report only apply to the tested sample.

TEST REPORT CERTIFICATION

Applicant Yulong Computer Telecommunication Scientific (Shenzhen) Co., Ltd
Address Floor 21, Block A, Coolpad Building, Intersection of Keyuan Avenue and Baoshen Road, North High-Tech Industrial Park, Nanshan District, Shenzhen, Guangdong, China

Manufacturer Yulong Computer Telecommunication Scientific (Shenzhen) Co., Ltd
Address Floor 21, Block A, Coolpad Building, Intersection of Keyuan Avenue and Baoshen Road, North High-Tech Industrial Park, Nanshan District, Shenzhen, Guangdong, China

Product Name Smart Phone
Trademark coolpad
Model Name CP12p
Sample Status: Normal

APPLICABLE STANDARDS	
STANDARD	TEST RESULTS
FCC Part 22H and 24E, 27, 90 KDB 971168 D01 v03r01, ANSI C63.26(2015)	PASS

Prepared by:

Zane Shan

Zane Shan
Engineer

Approved by:

Vita Li

Vita Li
Technical Director



Table of Contents

Page

1. TEST FACTORY & MEASUREMENT UNCERTAINTY	5
2. GENERAL INFORMATION	6
3. CONDUCTED OUTPUT POWER	13
4. PEAK-TO-AVERAGE RATIO	14
5. RADIATED POWER AND EFFECTIVE ISOTROPIC RADIATED POWER	15
6. OCCUPIED BANDWIDTH	17
7. CONDUCTED BAND EDGE	18
8. CONDUCTED SPURIOUS EMISSION	20
9. RADIATED SPURIOUS EMISSION	21
10. FREQUENCY STABILITY	23
APPENDIX I-PHOTOS OF TEST SETUP	24
APPENDIX II-TEST DATA	24
CONDUCTED OUTPUT POWER	24
FREQUENCY STABILITY	48
PEAK-TO-AVERAGE RATIO	49
OCCUPIED BANDWIDTH	119
BAND EDGE	189
OUT-OF-BAND EMISSIONS	236
RADIATED SPURIOUS EMISSION	306

Revision History

Rev.	Issue Date	Contents
00	Mar. 23, 2023	Initial Issue

1. TEST FACTORY & MEASUREMENT UNCERTAINTY

1.1 TEST FACTORY

Company Name:	Shenzhen LGT Test Service Co., Ltd.
Address:	Room 205, Building 13, Zone B, Chen Hsong Industrial Park, No.177 Renmin West Road, Jinsha Community, Kengzi Street, Pingshan New District, Shenzhen, China
Accreditation Certificate	FCC Registration No.: 746540
	A2LA Certificate No.: 6727.01

1.2 MEASUREMENT UNCERTAINTY

The reported uncertainty of measurement $y \pm U$, where expanded uncertainty U is based on a standard uncertainty multiplied by a coverage factor of $k=2$, providing a level of confidence of approximately 95 %.

Parameter	Uncertainty
Occupied Channel Bandwidth	$\pm 3.2\%$
RF Output Power, Conducted	$\pm 0.87\text{dB}$
Power Spectral Density, Conducted	$\pm 2.11\text{ dB}$
Unwanted Emission, Conducted	$\pm 0.86\text{dB}$
All Emissions, Radiated (Below 1GHz)	$\pm 3.54\text{dB}$
All Emissions, Radiated (1GHz-18GHz)	$\pm 4.22\text{dB}$
All Emissions, Radiated (18GHz-25GHz)	$\pm 4.81\text{dB}$
Temperature	$\pm 0.5^\circ\text{C}$
Humidity	$\pm 2\%$

2. GENERAL INFORMATION

2.1 TECHNICAL SPECIFICATIONS AND REGULATIONS

2.1.1 PRODUCT DESCRIPTION

A major technical description of EUT is described as following:

Product Name	Smart Phone
Trademark	coolpad
Model Name	CP12p
Series Model	N/A
Model Difference	N/A
Frequency Bands	U.S. Bands: LTE FDD Band 2 LTE FDD Band 4 LTE FDD Band 5 LTE FDD Band 7 LTE TDD Band 12 LTE TDD Band 13 LTE FDD Band 17 LTE FDD Band 66
SIM Card	SIM 1 and SIM 2 is a chipset unit and tested as single chipset, SIM 1 is used to tested.
Antenna	FPC
Antenna gain	LTE B2: -0.51dBi, LTE B4: 0.42dBi, LTE B5: -1.96dBi LTE B7: -1.85dBi, LTE B12: -1.94dBi, LTE B13: -2.03dBi LTE B17: -1.94dBi, LTE B66: 0.42dBi
Adapter	Input: 100-240V, 50/60Hz, 0.3A Output: 5V, 2A
Battery	Capacity: 4500mAh Rated Voltage: 3.85V
Extreme Vol. Limits	3.6V to 4.35V (Nominal 3.85V)
Extreme Temp. Tolerance	-20°C to +55°C
Hardware version	V1.0
Software version	CP12p.230327.0S.SE

Note: The antenna information refer the manufacturer provide report, applicable only to the tested sample identified in the report.

2.1.2 PRODUCT SPECIFICATION SUBJECTIVE TO THIS STANDARD

Product Specification Subjective To This Standard	
Tx Frequency	LTE Band 2:1850~1910MHz LTE Band 4:1710~1755MHz LTE Band 5: 824~849MHz LTE Band 7:2500~2570MHz LTE Band 12:699~716MHz LTE Band 13:777~787MHz LTE Band 17:704~716MHz LTE Band 66:1710~1780MHz
Rx Frequency	LTE Band 2: 1930-1990MHz LTE Band 4: 2110-2155MHz LTE Band 5: 869-894MHz LTE Band 7: 2620-2690MHz LTE Band 12:729~746MHz LTE Band 13:746~756MHz LTE Band 17:734~746MHz LTE Band 66:2110~2200MHz
Bandwidth	LTE Band 2: 1.4MHz / 3MHz / 5MHz / 10MHz / 15MHz / 20MHz LTE Band 4: 1.4MHz / 3MHz / 5MHz / 10MHz / 15MHz /20MHz LTE Band 5: 1.4MHz / 3MHz / 5MHz / 10MHz LTE Band 7: 5MHz / 10MHz / 15MHz /20MHz LTE Band 12: 1.4MHz / 3MHz / 5MHz / 10MHz LTE Band 13: 5MHz / 10MHz LTE Band 17: 5MHz / 10MHz LTE Band 66: 1.4MHz / 3MHz / 5MHz / 10MHz / 15MHz /20MHz
Type of Modulation	QPSK /16QAM

2.1.3 TEST CONFIGURATION OF EQUIPMENT UNDER TEST

Antenna port conducted and radiated test items listed below are performed according to KDB 971168 D01 v03r01 and ANSI C63.26 2015 Power Meas. License Digital Systems with maximum output power. Radiated measurements are performed by rotating the EUT in three different orthogonal test planes to find the maximum emission.

Remark:

1. The mark 'v' means that this configuration is chosen for testing
2. The mark '-' means that this bandwidth is not supported.
3. The device is investigated from 30MHz to 10 times of fundamental signal for radiated.

ITEMS	Band	Bandwidth (MHz)						Modulation		RB #			Test Channel		
		1.4	3	5	10	15	20	QPSK	16QAM	1	Half	Full	L	M	H
Max. Output Power	2	v	v	v	v	v	v	v	v	v	v	v	v	v	v
	4	v	v	v	v	v	v	v	v	v	v	v	v	v	v
	5	v	v	v	v			v	v	v	v	v	v	v	v
	7			v	v	v	v	v	v	v	v	v	v	v	v
	12	v	v	v	v			v	v	v	v	v	v	v	v
	13			v	v			v	v	v	v	v		v	
	17			v	v			v	v	v	v	v	v	v	v
	66	v	v	v	v	v	v	v	v	v	v	v	v	v	v
Peak&Avera Ratio	2						v	v	v	v		v	v	v	v
	4						v	v	v	v		v	v	v	v
	5				v			v	v	v		v	v	v	v
	7						v	v	v	v		v	v	v	v
	12				v			v	v	v		v	v	v	v
	13				v			v	v	v		v		v	
	17				v			v	v	v		v	v	v	v
	66						v	v	v	v		v	v	v	v

26dB&99% Bandwidth	2	v	v	v	v	v	v	v	v			v	v	v	v
	4	v	v	v	v	v	v	v	v			v	v	v	v
	5	v	v	v	v			v	v			v	v	v	v
	7			v	v	v	v	v	v			v	v	v	v
	12	v	v	v	v			v	v			v	v	v	v
	13			v	v			v	v			v		v	
	17			v	v			v	v			v	v	v	v
	66	v	v	v	v	v	v	v	v			v	v	v	v
Conducted Band Edge	2	v	v	v	v	v	v	v	v	v		v	v	v	v
	4	v	v	v	v	v	v	v	v	v		v	v	v	v
	5	v	v	v	v			v	v	v		v	v	v	v
	7			v	v	v	v	v	v	v		v	v	v	v
	12	v	v	v	v			v	v	v		v	v	v	v
	13			v	v			v	v	v		v		v	
	17			v	v			v	v	v		v	v	v	v
	66	v	v	v	v	v	v	v	v	v		v	v	v	v

Conducted Spurious Emission	2	v	v	v	v	v	v	v	v	v			v	v	v
	4	v	v	v	v	v	v	v	v	v			v	v	v
	5	v	v	v	v			v	v	v			v	v	v
	7			v	v	v	v	v	v	v			v	v	v
	12	v	v	v	v			v	v	v			v	v	v
	13			v	v			v	v	v				v	
	17			v	v			v	v	v			v	v	v
	66	v	v	v	v	v	v	v	v	v			v	v	v

Frequency Stability	2				v			v				v		v	
	4				v			v				v		v	
	5				v			v				v		v	
	7				v			v				v		v	
	12				v			v				v		v	
	13				v			v				v		v	
	17				v			v				v		v	
	66				v			v				v		v	

E.R.P.& E.I.R.P.	2	v	v	v	v	v	v	v	v	v	v	v	v	v	v
	4	v	v	v	v	v	v	v	v	v	v	v	v	v	v
	5	v	v	v	v			v	v	v	v	v	v	v	v
	7			v	v	v	v	v	v	v	v	v	v	v	v
	12	v	v	v	v			v	v	v	v	v	v	v	v
	13			v	v			v	v	v	v	v		v	
	17			v	v			v	v	v	v	v	v	v	v
	66	v	v	v	v	v	v	v	v	v	v	v	v	v	v

Radiated Spurious Emission	2	v	v	v	v	v	v	v		v			v	v	v
	4	v	v	v	v	v	v	v		v			v	v	v
	5	v	v	v	v			v		v			v	v	v
	7			v	v	v	v	v		v			v	v	v
	12	v	v	v	v			v		v			v	v	v
	13			v	v			v		v				v	
	17			v	v			v		v			v	v	v
	66	v	v	v	v	v	v	v		v			v	v	v

2.1.4 RELATED SUBMITTAL(S) / GRANT (S)

This submittal(s) (test report) is intended for filing to comply with the 47 CFR Part 2, 24(E), 27.

2.1.5 SPECIAL ACCESSORIES

The battery and the charger, earphone supplied by the applicant were used as accessories and being tested with eut intended for fcc grant together.

2.1.6 EUT CONFIGURATION

The EUT configuration for testing is installed on RF field strength measurement to meet the Commission's requirement and operating in a manner which intends to maximize its emission characteristics in a continuous normal application.

2.1.7 EUT EXERCISE

The Transmitter was operated in the maximum output power mode through Communication Tester. The TX frequency was fixed which was for the purpose of the measurements.

2.1.8 CONFIGURATION OF EUT SYSTEM

The EUT configuration for testing is installed on RF field strength measurement to meet the Commission's requirement and operating in a manner which intends to maximize its emission characteristics in a continuous normal application.



Table 2-1 Equipment Used in EUT System

Item	Equipment	Model No.	Length	Note
N/A				N/A

Note:

- (1) For detachable type I/O cable should be specified the length in cm in 『Length』 column.
- (2) “YES” is means “with core”; “NO” is means “without core”.

2.1.9 MEASUREMENT INSTRUMENTS

The radiated emission testing was performed according to the procedures of ANSI C63.26 2015 and FCC CFR 47 rules of 2.1046, 2.1047, 2.1049, 2.1051, 2.1053, 2.1055, 2.1057.

Radiated Test equipment					
Equipment	Manufacturer	Model No.	Serial No.	Cal. Date	Cal. Until
EMI Test Receiver	R&S	ESU8	100372	2022.04.12	2023.04.11
Active loop Antenna	R&S	HFH2-Z2	POS871398181	2022.06.02	2024.06.01
Spectrum Analyzer	Kesight	N9010B	MY60242508	2022.04.29	2023.04.28
Bilog Antenna	SCHAFFNER	CBL6112B	2705	2022.06.05	2024.06.04
Horn Antenna	SCHWARZBECK	3115	10SL0060	2022.06.02	2024.06.01
Pre-amplifier(0.1M-3GHz)	HP	8447D	2727A05655	2022.04.11	2023.04.10
Pre-amplifier(1-26.5G)	Agilent	8449B	3008A4722	2022.04.13	2023.04.12
RE Cable (9K-1G)	N.A	R01	N.A	2022.05.05	2023.05.04
RE Cable (1-26G)	N.A	R02	N.A	2022.05.05	2023.05.04
Wireless Communications Test Set	R&S	CMW 500	137737	2022.04.29	2023.04.28
Temperature & Humidity	KTJ	TA218B	N.A	2022.05.05	2023.05.04
Testing Software	EMC-I_V1.4.0.3_SKET				

Conducted Test equipment					
Equipment	Manufacturer	Model No.	Serial No.	Cal. Date	Cal. Until
Signal Analyzer	keysight	N9010B	MY60242508	2022.04.29	2023.04.28
Wireless Communications Test Set	R&S	CMW 500	137737	2022.04.29	2023.04.28
MXG Vector Signal Generator	keysight	N5182B	MY59100717	2022.06.02	2023.06.01
RF Automatic Test system	MW	MW100-RFCB	MW220324LG-33	2022.04.29	2023.04.28
Temperature & Humidity	KTJ	TA218B	N.A	2022.05.05	2023.05.04
Temperature & Humidity test chamber	AISRY	LX-1000L	171200018	2022.05.10	2023.05.09
Attenuator	eastsheep	90db	N.A	2022.04.29	2023.04.28
Testing Software	MTS8200_V2.0.0.0				

3. CONDUCTED OUTPUT POWER

3.1 DESCRIPTION OF THE CONDUCTED OUTPUT POWER MEASUREMENT

3.1.1 MEASUREMENT METHOD

A system simulator was used to establish communication with the eut. Its parameters were set to force the eut transmitting at maximum output power. The measured power in the radio frequency on the transmitter output terminals shall be reported.

Configuration follows KDB 971168 D01 v03r01.

3.1.2 TEST SETUP

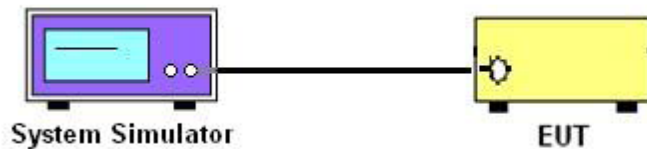

3.1.3 TEST PROCEDURES

1. The transmitter output port was connected to system simulator.
2. Set EUT at maximum power through the system simulator.
3. Select lowest/middle/highest channels for each band and different modulation.
4. Measure and record the power level from the system simulator.

3.1.4 TEST RESULTS

Note: Test chart See Appendix II

4. PEAK-TO-AVERAGE RATIO

4.1 DESCRIPTION OF THE CONDUCTED OUTPUT POWER MEASUREMENT

4.1.1 MEASUREMENT METHOD

Use one of the procedures presented in 4.1.3 to measure the total peak power and record as PPk. Use one of the applicable procedures presented 4.1.3 to measure the total average power and record as PAvg. Both the peak and average power levels must be expressed in the same logarithmic units (e.g., dBm). Determine the PAPR from:

$$\text{PAPR (dB)} = \text{PPk (dBm)} - \text{PAvg (dBm)}.$$

4.1.2 TEST SETUP

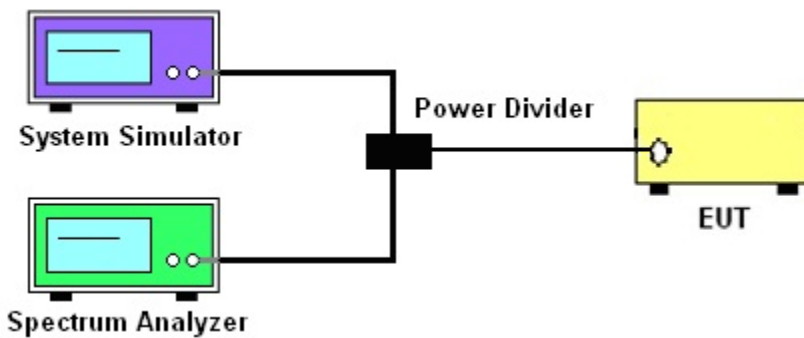

4.1.3 TEST PROCEDURES

1. The testing follows FCC KDB 971168 D01 v03r01 Section 5.7 and ANSI C63.26 2015 Section 5.2.6.
2. The EUT was connected to spectrum and system simulator via a power divider
3. Select lowest, middle, and highest channels for each band and different modulation.
4. Set the test probe and measure the peak and average power of the spectrum analyzer
5. Record the deviation as Peak to Average Ratio.

	LTE					
LTE BW	1.4M	3M	5M	10M	15M	20M
Span	3MHz	6MHz	10MHz	20MHz	30MHz	40MHz
RBW	30kHz	30kHz	100kHz	100kHz	300kHz	300kHz
VBW	100kHz	100kHz	300kHz	300kHz	1000kHz	1000kHz
Detector	PK/AVG	PK/AVG	PK/AVG	PK/AVG	PK/AVG	PK/AVG
Trace	Max	Max	Max	Max	Max	Max
Sweep Count	Auto	Auto	Auto	Auto	Auto	Auto

4.1.4 TEST RESULTS

Note: Test chart See Appendix II

5. RADIATED POWER AND EFFECTIVE ISOTROPIC RADIATED POWER

5.1 DESCRIPTION OF THE ERP/EIRP MEASUREMENT

5.1.1 MEASUREMENT METHOD

Effective radiated power output measurements by substitution method according to ANSI C63.26 2015, and the spectrum analyzer configuration follows KDB 971168 D01 Power Meas. License Digital Systems. Mobile and portable (hand-held) stations operating are limited to average ERP, Equivalent isotropic radiated power output measurements by substitution method according to ANSI C63.26 2015, and the spectrum analyzer configuration follows KDB 971168 D01 Power Meas, Mobile and portable (hand-held) stations operating are limited to average EIRP.

5.1.2 TEST SETUP

The procedure of radiated spurious emissions is as follows:

a) Pre-calibration With pre-calibration method, the Radiated Spurious Emissions(RSE) is calculated as, $RSE = R_x \text{ (dBuV)} + CL \text{ (dB)} + SA \text{ (dB)} + Gain \text{ (dBi)} - 107 \text{ (dBuV to dBm)}$ The SA is calibrated using following setup.

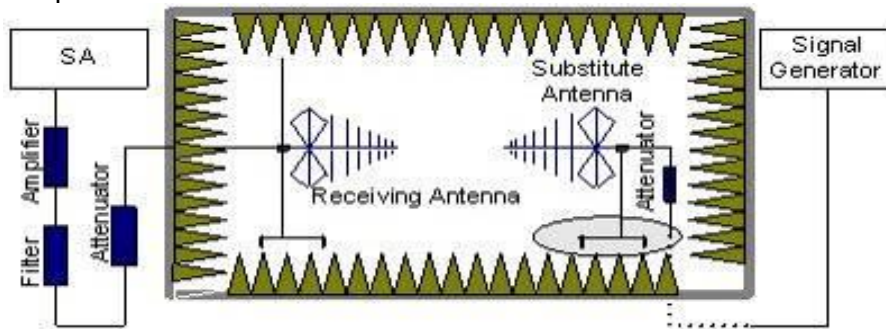

b) EUT was placed on a 1.5m non-conductive stand at a 3 m test distance from the receive antenna. A receiving antenna was placed on the antenna mast 3 m from the test item for emission measurements. The height of receiving antenna is 0.8m. The test setup refers to figure below. Detected emissions were maximized at each frequency by rotating the test item and adjusting the receiving antenna polarization. The radiated emission measurements of all non-harmonic and harmonics of the transmit frequency through the 10th harmonic measured with peak detector and 1MHz bandwidth.

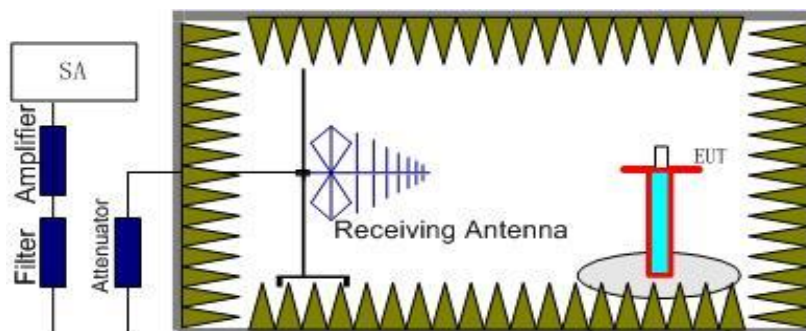

Radiated emissions measurements were made only at the upper, middle, and lower carrier frequencies. It was decided that measurements at these three carrier frequencies would be sufficient to demonstrate compliance with emissions limits because it was seen that all the significant spurs occur well outside the band and no radiation was seen from a carrier in one block of any band into any of the other blocks.

The substitution method is used. Substitution values at each frequency are measured before and saved to the test software. A "reference path loss" is established and the ARpl is the attenuation of "reference path loss", and including the gain of receive antenna, the gain of the preamplifier, the cable loss and the air loss. The measurement results are obtained as described below:

$Power = P_{Mea} + AR_{pl}$

5.1.3 TEST PROCEDURES

1. The testing follows FCC KDB 971168 D01v03r01 Section 5.6 and ANSI C63.26 2015 Section 5.2.
2. The EUT was placed on a non-conductive rotating platform 1.5 meters high in a semi-anechoic chamber. The radiated emission at the fundamental frequency was measured at 3 m with a test antenna and a spectrum analyzer with Peak detector.
3. During the measurement, the system simulator parameters were set to force the EUT transmitting at maximum output power. The maximum emission was recorded from analyzer power level (LVL) from the 360 degrees rotation of the turntable and the test antenna raised and lowered over a range from 1 to 4 m in both horizontally and vertically polarized orientations.
4. Effective Isotropic Radiated Power (EIRP) was measured by substitution method according to ANSI C63.26 2015. The EUT was replaced by dipole antenna (substitution antenna) at same location and then a known power from S.G. was applied into the dipole antenna through a Tx cable, and then recorded the maximum Analyzer reading through raised and lowered the test antenna. $EIRP = S.G \text{ Level} + \text{Gain} - \text{Cable loss}$; $ERP = S.G \text{ Level} + \text{Gain} - \text{Cable loss} - 2.15$.
5. RB Set greater than bandwidth, VB Set spectrum analyzer Maximum support.

5.1.4 TEST RESULTS

Note: Test is divided into three directions, X/Y/Z. X pattern for the worst.

Note: Test chart See Appendix II

6. OCCUPIED BANDWIDTH

6.1 DESCRIPTION OF OCCUPIED BANDWIDTH MEASUREMENT

6.1.1 MEASUREMENT METHOD

1. The occupied bandwidth is the width of a frequency band such that, below the lower and above the upper frequency limits, the mean powers emitted are each equal to a specified percentage 0.5% of the total mean transmitted power.

2. The 26 db emission bandwidth is defined as the frequency range between two points, one above and one below the carrier frequency, at which the spectral density of the emission is attenuated 26 db below the maximum in-band spectral density of the modulated signal. spectral density (power per unit bandwidth) is to be measured with a detector of resolution bandwidth equal to approximately 1.0% of the emission bandwidth.

6.1.2 TEST SETUP

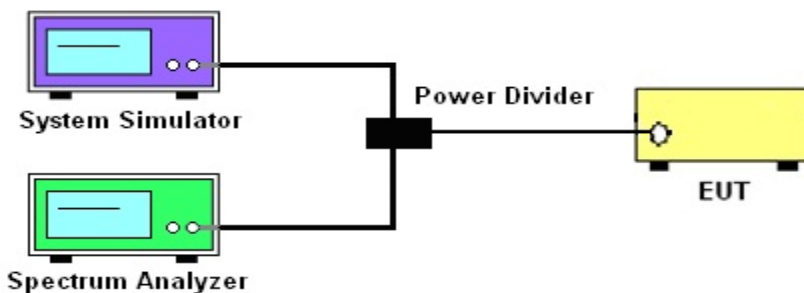

6.1.3 TEST PROCEDURES

1. The testing follows FCC KDB 971168 D01 v03r01 Section 4.2 and 4.3.
2. The EUT was connected to spectrum and system simulator via a power divider.
3. Select lowest, middle, and highest channels for each band and different modulation.
4. Set the test probe and measure the Occupied Bandwidth of the spectrum analyzer.
5. Measure and record the Occupied Bandwidth from the Spectrum Analyzer.

	LTE					
LTE BW	1.4M	3M	5M	10M	15M	20M
Span	3MHz	6MHz	10MHz	20MHz	30MHz	40MHz
RBW	30kHz	30kHz	100kHz	100kHz	300kHz	300kHz
VBW	100kHz	100kHz	300kHz	300kHz	1000kHz	1000kHz
Detector	PK	PK	PK	PK	PK	PK
Trace	Max	Max	Max	Max	Max	Max
Sweep Count	Auto	Auto	Auto	Auto	Auto	Auto

6.1.4 MEASUREMENT RESULT

Note: Test chart See Appendix II

7. CONDUCTED BAND EDGE

7.1 DESCRIPTION OF CONDUCTED BAND EDGE MEASUREMENT

7.1.1 MEASUREMENT METHOD

1. §22.917(a)

For operations in the 824 – 849 MHz band, the FCC limit is $43 + 10\log_{10}(P[\text{Watts}])$ dB below the transmitter power $P(\text{Watts})$ in a 100kHz bandwidth. However, in the 1MHz bands immediately outside and adjacent to the licensee's frequency block, a resolution bandwidth of at least one percent of the emission bandwidth of the fundamental emission of the transmitter may be employed.

2. §24.238 (a)

For operations in the 1850-1910 and 1930-1990 MHz band, the FCC limit is $43 + 10\log_{10}(P[\text{Watts}])$ dB below the transmitter power $P(\text{Watts})$ in a 1MHz bandwidth. However, in the 1 MHz bands immediately outside and adjacent to the frequency block a resolution bandwidth of at least one percent of the emission bandwidth of the fundamental emission of the transmitter may be employed

3. §27.53 (h)

For operations in the 1710 – 1755 MHz band, the FCC limit is $43 + 10\log_{10}(P[\text{Watts}])$ dB below the transmitter power $P(\text{Watts})$ in a 1 MHz bandwidth. However, in the 1MHz bands immediately outside and adjacent to the licensee's frequency block, a resolution bandwidth of at least one percent of the emission bandwidth of the fundamental emission of the transmitter may be employed.

4. §27.53(m)(4)

For operations in the 2500 MHz ~ 2570 MHz band this section, the attenuation factor shall be not less than $40 + 10 \log (P)$ dB on all frequencies between the channel edge and 5 megahertz from the channel edge, $43 + 10 \log (P)$ dB on all frequencies between 5 megahertz and X megahertz from the channel edge, and $55 + 10 \log (P)$ dB on all frequencies more than X megahertz from the channel edge, where X is the greater of 6 megahertz or the actual emission bandwidth as defined in paragraph (m)(6) of this section. In addition, the attenuation factor shall not be less that $43 + 10 \log (P)$ dB on all frequencies between 2490.5 MHz and 2496 MHz and $55 + 10 \log (P)$ dB at or below 2490.5 MHz. Mobile Satellite Service licensees operating on frequencies below 2495 MHz may also submit a documented interference complaint against BRS licensees operating on channel BRS Channel 1 on the same terms and conditions as adjacent channel BRS or EBS licensees.

5. §27.53 (g)

For operations in the 698 -746 MHz band, the FCC limit is $43 + 10\log_{10}(P[\text{Watts}])$ dB below the transmitter power $P(\text{Watts})$ in a 100 kHz bandwidth. However, in the 100 kilohertz bands immediately outside and adjacent to a licensee's frequency block, a resolution bandwidth of at least 30 kHz may be employed.

7.1.2 TEST SETUP

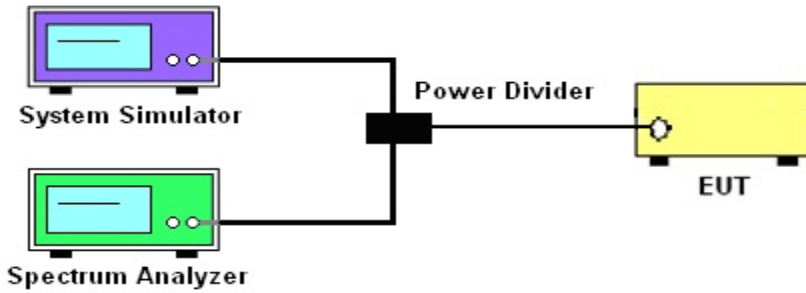

7.1.3 TEST PROCEDURES

1. The testing FCC KDB 971168 D01 v03r01 Section 6.0 and ANSI C63.26 2015 Section 5.7.
2. The EUT was connected to spectrum analyzer and system simulator via a power divider.
3. The band edges of low and high channels for the highest RF powers were measured. Set RBW \geq 1% EBW in the 1MHz band immediately outside and adjacent to the band edge.
4. Set spectrum analyzer with RMS/AVG detector.
5. The RF fundamental frequency should be excluded against the limit line in the operating frequency band.
6. The limit line is derived from $43 + 10\log(P)$ dB below the transmitter power P(Watts)
 - = $P(W) - [43 + 10\log(P)]$ (dB)
 - = $[30 + 10\log(P)]$ (dBm) - $[43 + 10\log(P)]$ (dB)
 - = -13dBm.

Band 7:

- = $P(W) - [55 + 10\log(P)]$ (dB)
- = $[30 + 10\log(P)]$ (dBm) - $[55 + 10\log(P)]$ (dB)
- = -25dBm.

	LTE					
LTE BW	1.4M	3M	5M	10M	15M	20M
Span	12MHz	13MHz	15MHz	20MHz	25MHz	30MHz
RBW	30kHz	30kHz	100kHz	100kHz	300kHz	300kHz
VBW	100kHz	100kHz	300kHz	300kHz	1000kHz	1000kHz
Detector	RMS	RMS	RMS	RMS	RMS	RMS
Trace	Max	Max	Max	Max	Max	Max
Sweep Count	Auto	Auto	Auto	Auto	Auto	Auto

7.1.4 MEASUREMENT RESULT

Note: Test chart See Appendix II

8. CONDUCTED SPURIOUS EMISSION

8.1 DESCRIPTION OF CONDUCTED SPURIOUS EMISSION MEASUREMENT

8.1.1 MEASUREMENT METHOD

The power of any emission outside of the authorized operating frequency ranges must be lower than the transmitter power (P) by a factor of at least $43 + 10 \log (P)$ dB.

For Band 7:

The power of any emission outside of the authorized operating frequency ranges must be lower than the transmitter power (P) by a factor of at least $55 + 10 \log (P)$ dB.

It is measured by means of a calibrated spectrum analyzer and scanned from 30 MHz up to a frequency including its 10th harmonic.

8.1.2 TEST SETUP

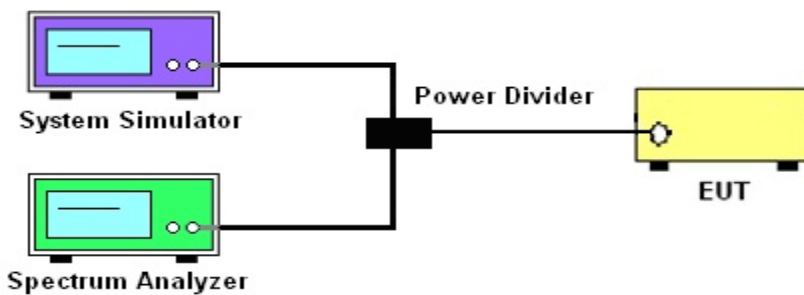

8.1.3 TEST PROCEDURES

1. The testing FCC KDB 971168 D01 v03r01 Section 6.0 and ANSI C63.26 2015 Section 5.7.
2. The EUT was connected to spectrum analyzer and system simulator via a power divider.
3. The RF output of EUT was connected to the spectrum analyzer by RF cable and attenuator. The path loss was compensated to the results for each measurement
4. Make the measurement with the spectrum analyzer's RBW = 1MHz, VBW = 3MHz, taking the record of maximum spurious emission.
5. The RF fundamental frequency should be excluded against the limit line in the operating frequency band.
6. The limit line is derived from $43 + 10\log(P)$ dB below the transmitter power P(Watts)
 $= P(W) - [43 + 10\log(P)] \text{ (dB)} = [30 + 10\log(P)] \text{ (dBm)} - [43 + 10\log(P)] \text{ (dB)}$
 $= -13\text{dBm}$.

For Band 7: $P(W) - [43 + 10\log(P)] \text{ (dB)} = -25\text{dBm}$

	LTE					
LTE BW	1.4M	3M	5M	10M	15M	20M
Span	Auto	Auto	Auto	Auto	Auto	Auto
RBW	1000kHz	1000kHz	1000kHz	1000kHz	1000kHz	1000kHz
VBW	3000kHz	3000kHz	3000kHz	3000kHz	3000kHz	3000kHz
Detector	PK	PK	PK	PK	PK	PK
Trace	Max	Max	Max	Max	Max	Max

8.1.4 TEST RESULTS

Note: Test chart See Appendix II