



# FCC RF Test Report

APPLICANT : Sierra Wireless, Inc.  
EQUIPMENT : Wireless Module  
BRAND NAME : AirPrime  
MODEL NAME : EM9190  
FCC ID : N7NEM91  
STANDARD : 47 CFR Part 2, Part 27 Subpart Q  
CLASSIFICATION : PCS Licensed Transmitter (PCB)  
TEST DATE(S) : Nov. 21, 2021 ~ Jan. 06, 2022

We, Sporton International Inc. (ShenZhen), would like to declare that the tested sample has been evaluated in accordance with the procedures given in ANSI C63.26-2015 and shown compliance with the applicable technical standards.

The test results in this report apply exclusively to the tested model / sample. Without written approval of Sporton International Inc. (ShenZhen), the test report shall not be reproduced except in full.

Reviewed by: Derreck Chen / Supervisor

Approved by: Eric Shih / Manager



**Sporton International Inc. (ShenZhen)**

**1/F, 2/F, Bldg 5, Shiling Industrial Zone, Xinwei Village, Xili, Nanshan, Shenzhen, 518055**

**People's Republic of China**



TABLE OF CONTENTS

REVISION HISTORY... 3
SUMMARY OF TEST RESULT ... 4
1 GENERAL DESCRIPTION ... 5
1.1 Applicant ... 5
1.2 Manufacturer ... 5
1.3 Product Feature of Equipment Under Test ... 5
1.4 Product Specification of Equipment Under Test ... 5
1.5 Modification of EUT ... 6
1.6 Maximum Conducted Power and Emission Designator ... 6
1.7 Testing Site ... 7
1.8 Test Software ... 7
1.9 Applied Standards ... 7
2 TEST CONFIGURATION OF EQUIPMENT UNDER TEST ... 8
2.1 Test Mode ... 8
2.2 Connection Diagram of Test System ... 9
2.3 Support Unit used in test configuration and system ... 9
2.4 Measurement Results Explanation Example ... 9
2.5 Frequency List of Low/Middle/High Channels ... 10
3 CONDUCTED TEST ITEMS ... 11
3.1 Measuring Instruments ... 11
3.2 Test Setup ... 11
3.3 Test Result of Conducted Test ... 11
3.4 Conducted Output Power Measurement ... 12
3.5 Peak-to-Average Ratio ... 13
3.6 Occupied Bandwidth ... 14
3.7 Conducted Band Edge Measurement ... 15
3.8 Conducted Spurious Emission Measurement ... 16
3.9 Frequency Stability Measurement ... 17
4 RADIATED TEST ITEMS ... 18
4.1 Measuring Instruments ... 18
4.2 Test Setup ... 18
4.3 Test Result of Radiated Test ... 19
4.4 Radiated Spurious Emission Measurement ... 20
5 LIST OF MEASURING EQUIPMENT ... 21
6 UNCERTAINTY OF EVALUATION ... 22
APPENDIX A. TEST RESULTS OF CONDUCTED TEST
APPENDIX B. TEST RESULTS OF RADIATED TEST
APPENDIX C. TEST SETUP PHOTOGRAPHS



### REVISION HISTORY

REPORT NO.	VERSION	DESCRIPTION	ISSUED DATE
FG1N1001B	Rev. 01	Initial issue of report	Feb. 17, 2022



### SUMMARY OF TEST RESULT

Report Section	FCC Rule	Description	Limit	Result	Remark
3.4	§2.1046	Conducted Output Power	—	Report Only	-
3.5	§27.50 (k)(4)	Peak-to-Average Ratio	<13dB	PASS	
3.6	§2.1049	Occupied Bandwidth	—	Report Only	-
3.7	§2.1051 §27.53 (n)(2)	Conducted Band Edge Measurement	-13dBm/MHz	PASS	-
3.8	§2.1051 §27.53 (n)(2)	Conducted Spurious Emission	-13dBm/MHz	PASS	-
3.9	§2.1055 §27.54	Frequency Stability Temperature & Voltage	Within the band	PASS	-
4.4	§2.1053 §27.53 (n)(2)	Radiated Spurious Emission	-13dBm/MHz	PASS	Under limit 36.28 dB at 14000.120 MHz

**Declaration of Conformity:**  
The test results with all measurement uncertainty excluded are presented in accordance with the regulation limits or requirements declared by manufacturers.

**Comments and Explanations:**  
The declared of product specification for EUT presented in the report are provided by the manufacturer, and the manufacturer takes all the responsibilities for the accuracy of product specification.



# 1 General Description

## 1.1 Applicant

Sierra Wireless, Inc.  
13811 Wireless Way, Richmond, BC, Canada V6A 3A4

## 1.2 Manufacturer

Sierra Wireless, Inc.  
13811 Wireless Way, Richmond, BC, Canada V6A 3A4

## 1.3 Product Feature of Equipment Under Test

Product Feature	
Equipment	Wireless Module
Brand Name	AirPrime
Model Name	EM9190
FCC ID	N7NEM91
IMEI Code	Conducted : 351735110008640 Radiation : N/A
HW Version	1.0
SW Version	00.15.01.00
EUT Stage	Identical Prototype

## 1.4 Product Specification of Equipment Under Test

Product Feature	
Tx/Rx Frequency	5G NR n77: 3450 MHz ~ 3550 MHz
Bandwidth	20MHz / 30MHz / 40MHz / 50MHz / 60MHz / 70MHz / 80MHz / 90MHz / 100MHz
SCS	30KHz
Maximum Output Power to Antenna	5G NR n77 : 23.17 dBm
Type of Modulation	CP-OFDM: QPSK / 16QAM / 64QAM / 256QAM DFT-s-OFDM: PI/2 BPSK / QPSK / 16QAM / 64QAM / 256QAM

**Remark:**

- 5G NR n77 supports SA and NSA mode, only NSA mode was required to be tested.
- The EN-DC combinations declared by the manufacturer are as follows:  
DC\_2A\_n77A, DC\_5A\_n77A, DC\_12A\_n77A, DC\_13A\_n77A, DC\_14A\_n77A, DC\_41A\_n77A and DC\_66A\_n77A.

### 1.5 Modification of EUT

No modifications are made to the EUT during all test items.

### 1.6 Maximum Conducted Power and Emission Designator

5G NR n77 EN-DC_5A-n77A		PI/2 BPSK / QPSK		16QAM/64QAM/256QAM	
BW (MHz)	Frequency Range (MHz)	Maximum Conducted power (W)	Emission Designator (99%OBW)	Maximum Conducted power (W)	Emission Designator (99%OBW)
20	3460.02 ~ 3540	0.1995	18M2G7D	0.1596	18M2W7D
30	3465 ~ 3534.99	0.2075	27M9G7D	0.1614	27M9W7D
40	3470.01 ~ 3529.98	0.2065	37M8G7D	0.1671	37M9W7D
50	3475.02 ~ 3525	0.1963	47M4G7D	0.1614	47M5W7D
60	3480 ~ 3519.99	0.2009	57M9G7D	0.1656	57M9W7D
70	3485.01 ~ 3514.98	0.1995	67M5G7D	0.1585	67M5W7D
80	3490.02 ~ 3510	0.2000	77M5G7D	0.1596	77M6W7D
90	3495 ~ 3504.99	0.2037	87M6G7D	0.1667	87M5W7D
100	3500.01 ~ 3500.01	0.2037	97M6G7D	0.1600	97M5W7D

**Note:** All modulations have been evaluation, only the worst test results of PSK & QAM are shown in the report

## 1.7 Testing Site

Sporton International Inc. (Shenzhen) is accredited to ISO/IEC 17025:2017 by American Association for Laboratory Accreditation with Certificate Number 5145.01.

<b>Test Firm</b>	Sporton International Inc. (Shenzhen)		
<b>Test Site Location</b>	1/F, 2/F, Bldg 5, Shiling Industrial Zone, Xinwei Village, Xili, Nanshan, Shenzhen, 518055 People's Republic of China TEL: +86-755-86379589 FAX: +86-755-86379595		
<b>Test Site No.</b>	<b>Sporton Site No.</b>	<b>FCC Designation No.</b>	<b>FCC Test Firm Registration No.</b>
	TH01-SZ	CN1256	421272

<b>Test Firm</b>	Sporton International Inc. (Shenzhen)		
<b>Test Site Location</b>	101, 1st Floor, Block B, Building 1, No. 2, Tengfeng 4th Road, Fenghuang Community, Fuyong Street, Baoan District, Shenzhen City Guangdong Province China 518103 TEL: +86-755-33202398		
<b>Test Site No.</b>	<b>Sporton Site No.</b>	<b>FCC Designation No.</b>	<b>FCC Test Firm Registration No.</b>
	03CH03-SZ	CN1256	421272

## 1.8 Test Software

Item	Site	Manufacturer	Name	Version
1.	03CH03-SZ	AUDIX	E3	6.2009-8-24

## 1.9 Applied Standards

According to the specifications of the manufacturer, the EUT must comply with the requirements of the following standards:

- ♦ 47 CFR Part 2, Part 27 Subpart Q
- ♦ ANSI C63.26-2015
- ♦ FCC KDB 971168 Power Meas License Digital Systems D01 v03r01
- ♦ FCC KDB 412172 D01 Determining ERP and EIRP v01r01

**Remark:** All test items were verified and recorded according to the standards and without any deviation during the test.

## 2 Test Configuration of Equipment Under Test

### 2.1 Test Mode

Antenna port conducted and radiated test items listed below are performed according to KDB 971168 D01 Power Meas. License Digital Systems v03r01 with maximum output power.

Radiated measurements are performed by rotating the EUT in three different orthogonal test planes to find the maximum emission.

Test Cases	Band	Bandwidth (MHz)	Modulation	RB #	Test Channel
		eg. 5M, 10M, 15M, 20M	eg. QPSK, 16QAM, 64QAM, 256QAM	1RB, Partial RB, Full RB	L/M/H
Max. Output Power	5G n77	20M, 30M, 40M, 50M, 60M, 70M, 80M, 90M ,100M	PI/2 BPSK, QPSK, 16QAM, 64QAM, 256QAM	1RB, Partial RB, Full RB	L, M, H
Peak-to-Average Ratio	5G n77	20M	PI/2 BPSK, QPSK	1RB, Full RB	L, M, H
26dB and 99% Bandwidth	5G n77	20M, 30M, 40M, 50M, 60M, 70M, 80M, 90M ,100M	PI/2 BPSK, QPSK, 16QAM, 64QAM, 256QAM	Full RB	M
Conducted Band Edge	5G n77	20M, 60M, 100M	PI/2 BPSK, QPSK	1RB, Full RB	L, H
Conducted Spurious Emission	5G n77	20M, 60M, 100M	PI/2 BPSK, QPSK	1RB	L, M, H
Frequency Stability	5G n77	20M	QPSK	Full RB	M
Radiated Spurious Emission	5G n77	Worst case from maximum power			M

**Note:**

1. The device is investigated from 30MHz to 10 times of fundamental signal for radiated spurious emission test under different RB size/offset and modulations in exploratory test. Subsequently, only the worst case emissions are reported.
2. Based on engineering evaluation, only the worst modulations test results are shown in the report.
3. Frequency Stability: Normal Voltage =3.3 V.; Low Voltage =3.135 V.; High Voltage =4.4 V



## 2.2 Connection Diagram of Test System

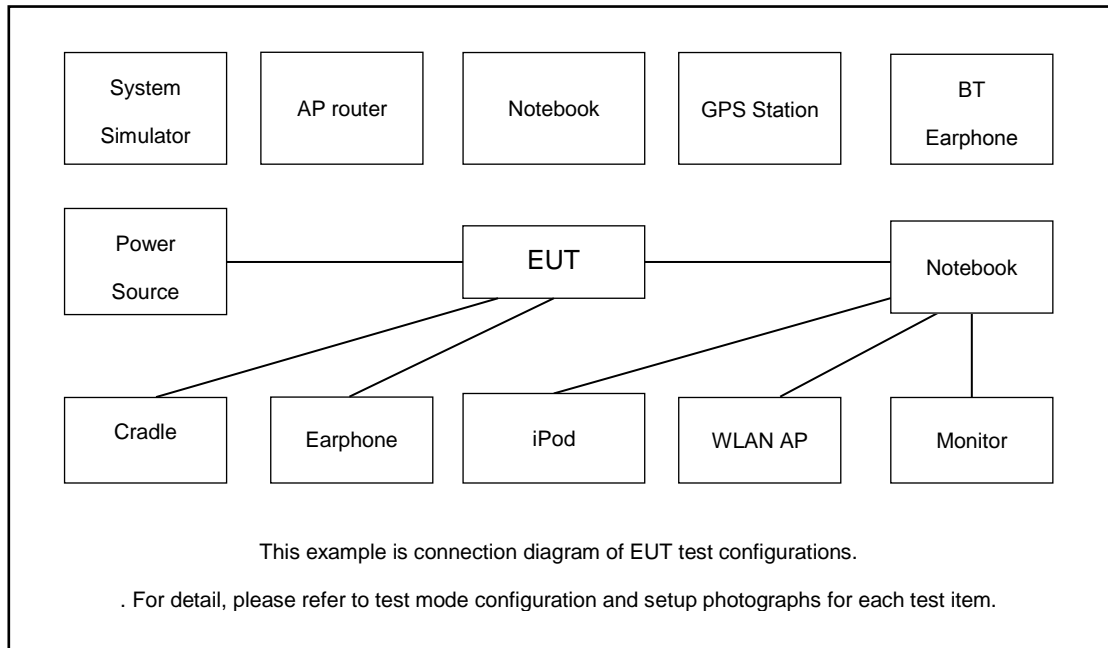

## 2.3 Support Unit used in test configuration and system

Item	Equipment	Trade Name	Model No.	FCC ID	Data Cable	Power Cord
1.	Base Station	Anritsu	MT8821C	N/A	N/A	Unshielded,1.8m
2.	Base Station	Anritsu	MT8000A	N/A	N/A	Unshielded,1.8m

## 2.4 Measurement Results Explanation Example

### For all conducted test items:

The offset level is set in the spectrum analyzer to compensate the RF cable loss and attenuator factor between EUT conducted output port and spectrum analyzer. With the offset compensation, the spectrum analyzer reading level is exactly the EUT RF output level.

The spectrum analyzer offset is derived from RF cable loss.

*Offset = RF cable loss.*

Following shows an offset computation example with cable loss 8 dB.

Example :

$$\begin{aligned} \text{Offset(dB)} &= \text{RF cable loss(dB)}. \\ &= 8 \text{ (dB)} \end{aligned}$$



### 2.5 Frequency List of Low/Middle/High Channels

5G n77 Channel and Frequency List				
BW [MHz]	Channel/Frequency(MHz)	Lowest	Middle	Highest
100	Channel	-	633334	-
	Frequency	-	3500.01	-
90	Channel	633000	633334	633666
	Frequency	3495	3500.01	3504.99
80	Channel	632668	633334	634000
	Frequency	3490.02	3500.01	3510
70	Channel	632334	633334	634332
	Frequency	3485.01	3500.01	3514.98
60	Channel	632000	633334	634666
	Frequency	3480	3500.01	3519.99
50	Channel	631668	633334	635000
	Frequency	3475.02	3500.01	3525
40	Channel	631334	633334	635332
	Frequency	3470.01	3500.01	3529.98
30	Channel	631000	633334	635666
	Frequency	3465	3500.01	3534.99
20	Channel	630668	633334	636000
	Frequency	3460.02	3500.01	3540

### 3 Conducted Test Items

#### 3.1 Measuring Instruments

See list of measuring instruments of this test report.

#### 3.2 Test Setup

##### 3.2.1 Conducted Output Power

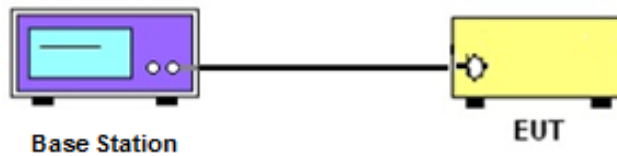

##### 3.2.2 Peak-to-Average Ratio, Occupied / 26dB Bandwidth ,Band-Edge and Conducted Spurious Emission

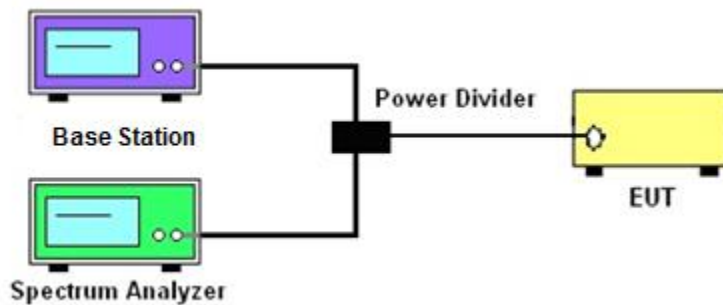

##### 3.2.3 Frequency Stability



### 3.3 Test Result of Conducted Test

Please refer to Appendix A.



## **3.4 Conducted Output Power Measurement**

### **3.4.1 Description of the Conducted Output Power Measurement**

A base station simulator was used to establish communication with the EUT. Its parameters were set to transmit the maximum power on the EUT. The measured power in the radio frequency on the transmitter output terminals shall be reported.

### **3.4.2 Test Procedures**

1. The testing follows ANSI C63.26 Section 5.2
2. The transmitter output port was connected to the system simulator.
3. Set EUT at maximum power through the system simulator.
4. Select lowest, middle, and highest channels for each band and different modulation.
5. Measure and record the power level from the system simulator.

## 3.5 Peak-to-Average Ratio

### 3.5.1 Description of the PAR Measurement

Power Complementary Cumulative Distribution Function (CCDF) curves provide a means for characterizing the power peaks of a digitally modulated signal on a statistical basis. A CCDF curve depicts the probability of the peak signal amplitude exceeding the average power level. Most contemporary measurement instrumentation include the capability to produce CCDF curves for an input signal provided that the instrument's resolution bandwidth can be set wide enough to accommodate the entire input signal bandwidth. In measuring transmissions in this band using an average power technique, the peak-to-average ratio (PAR) of the transmission may not exceed 13 dB.

### 3.5.2 Test Procedures

1. The testing follows ANSI C63.26 Section 5.2.3.4 (CCDF).
2. The EUT was connected to spectrum and system simulator via a power divider.
3. Set the CCDF (Complementary Cumulative Distribution Function) option in spectrum analyzer.
4. The highest RF powers were measured and recorded the maximum PAPR level associated with a probability of 0.1 %.
5. Record the deviation as Peak to Average Ratio.

## 3.6 Occupied Bandwidth

### 3.6.1 Description of Occupied Bandwidth Measurement

The occupied bandwidth is the width of a frequency band such that, below the lower and above the upper frequency limits, the mean powers emitted are each equal to a specified percentage 0.5% of the total mean transmitted power.

The 26 dB emission bandwidth is defined as the frequency range between two points, one above and one below the carrier frequency, at which the spectral density of the emission is attenuated 26 dB below the maximum in-band spectral density of the modulated signal. Spectral density (power per unit bandwidth) is to be measured with a detector of resolution bandwidth equal to approximately 1.0% of the emission bandwidth.

### 3.6.2 Test Procedures

1. The testing follows ANSI C63.26 Section 5.4
2. The EUT was connected to spectrum analyzer and system simulator via a power divider.
3. The spectrum analyzer center frequency is set to the nominal EUT channel center frequency. The span range for the spectrum analyzer shall be between two and five times the anticipated OBW.
4. The nominal resolution bandwidth (RBW) shall be in the range of 1 to 5 % of the anticipated OBW, and the VBW shall be at least 3 times the RBW.
5. Set the detection mode to peak, and the trace mode to max hold.
6. Determine the reference value: Set the EUT to transmit a modulated signal. Allow the trace to stabilize. Set the spectrum analyzer marker to the highest level of the displayed trace.  
(this is the reference value)
7. Determine the “-26 dB down amplitude” as equal to (Reference Value – X).
8. Place two markers, one at the lowest and the other at the highest frequency of the envelope of the spectral display such that each marker is at or slightly below the “-X dB down amplitude” determined in step 6. If a marker is below this “-X dB down amplitude” value it shall be placed as close as possible to this value. The OBW is the positive frequency difference between the two markers.
9. Use the 99 % power bandwidth function of the spectrum analyzer and report the measured bandwidth.

## 3.7 Conducted Band Edge Measurement

### 3.7.1 Description of Conducted Band Edge Measurement

#### § 27.53 (n)(2)

For mobile operations in the 3450-3550 MHz band, the conducted power of any emission outside the licensee's authorized bandwidth shall not exceed  $-13$  dBm/MHz.

Compliance with this paragraph is based on the use of measurement instrumentation employing a resolution bandwidth of 1 megahertz or greater. However, in the 1 megahertz bands immediately outside and adjacent to the licensee's frequency block, a resolution bandwidth of at least one percent of the emission bandwidth of the fundamental emission of the transmitter may be employed, but limited to a maximum of 200 kHz. In the bands between 1 and 5 MHz removed from the licensee's frequency block, the minimum resolution bandwidth for the measurement shall be 500 kHz.

### 3.7.2 Test Procedures

1. The testing follows ANSI C63.26 section 5.7
2. The EUT was connected to spectrum analyzer and system simulator via a power divider.
3. The band edges of low and high channels for the highest RF powers were measured.
4. Set RBW  $\geq$  1% EBW but limited to a maximum of 200 kHz in the 1MHz band immediately outside and adjacent to the band edge.
5. Beyond the 1 MHz and 5 MHz removed from the band edge, set RBW  $\geq$  500KHz.
6. Beyond the 5 MHz removed from the band edge, set RBW = 1MHz.
7. Set spectrum analyzer with RMS detector.
8. The RF fundamental frequency should be excluded against the limit line in the operating frequency band.
9. Checked that all the results comply with the emission limit line.

## 3.8 Conducted Spurious Emission Measurement

### 3.8.1 Description of Conducted Spurious Emission Measurement

The power of any emission outside of the authorized operating frequency ranges shall not exceed -13 dBm/MHz.

It is measured by means of a calibrated spectrum analyzer and scanned from 9 kHz up to a frequency including its 10<sup>th</sup> harmonic.

### 3.8.2 Test Procedures

1. The testing follows ANSI C63.26 section 5.7
2. The EUT was connected to spectrum analyzer and system simulator via a power divider.
3. The RF output of EUT was connected to the spectrum analyzer by RF cable and attenuator. The path loss was compensated to the results for each measurement.
4. The middle channel for the highest RF power within the transmitting frequency was measured.
5. The conducted spurious emission for the whole frequency range was taken.
6. Make the measurement with the spectrum analyzer's RBW = 1MHz, VBW = 3MHz.
7. Set spectrum analyzer with RMS detector.
8. Taking the record of maximum spurious emission.
9. The RF fundamental frequency should be excluded against the limit line in the operating frequency band.
10. Checked that all the results comply with the emission limit line.



## 3.9 Frequency Stability Measurement

### 3.9.1 Description of Frequency Stability Measurement

The frequency stability shall be measured by variation of ambient temperature and variation of primary supply voltage to ensure that the fundamental emission stays within the authorized frequency block.

### 3.9.2 Test Procedures for Temperature Variation

1. The testing follows ANSI C63.26 section 5.6.4
2. The EUT was set up in the thermal chamber and connected with the system simulator.
3. With power OFF, the temperature was decreased to  $-30^{\circ}\text{C}$  and the EUT was stabilized before testing. Power was applied and the maximum change in frequency was recorded within one minute.
4. With power OFF, the temperature was raised in  $10^{\circ}\text{C}$  step up to  $50^{\circ}\text{C}$ . The EUT was stabilized at each step for at least half an hour. Power was applied and the maximum frequency change was recorded within one minute.

### 3.9.3 Test Procedures for Voltage Variation

1. The testing follows ANSI C63.26 section 5.6.5.
2. The EUT was placed in a temperature chamber at  $20\pm 5^{\circ}\text{C}$  and connected with the system simulator.
3. The power supply voltage to the EUT was varied from 85% to 115% of the nominal value for other than hand carried battery equipment.
4. For hand carried, battery powered equipment, reduce the primary ac or dc supply voltage to the battery operating end point, which shall be specified by the manufacturer.
5. The variation in frequency was measured for the worst case.

## 4 Radiated Test Items

### 4.1 Measuring Instruments

See list of measuring instruments of this test report.

### 4.2 Test Setup

#### 4.2.1 For radiated test below 30MHz

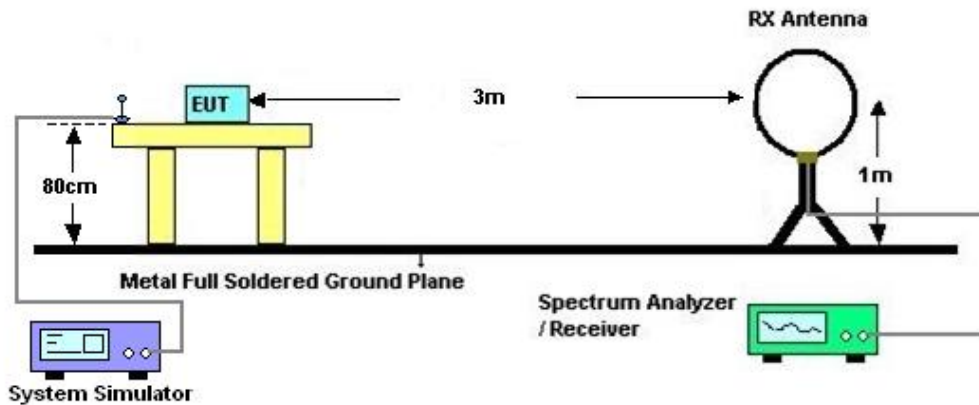

#### 4.2.2 For radiated test from 30MHz to 1GHz

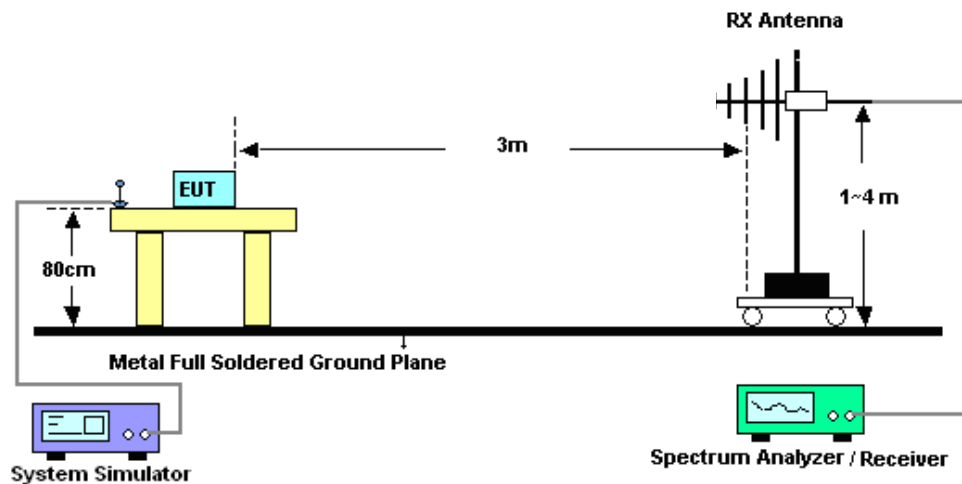

### 4.2.3 For radiated test above 1GHz

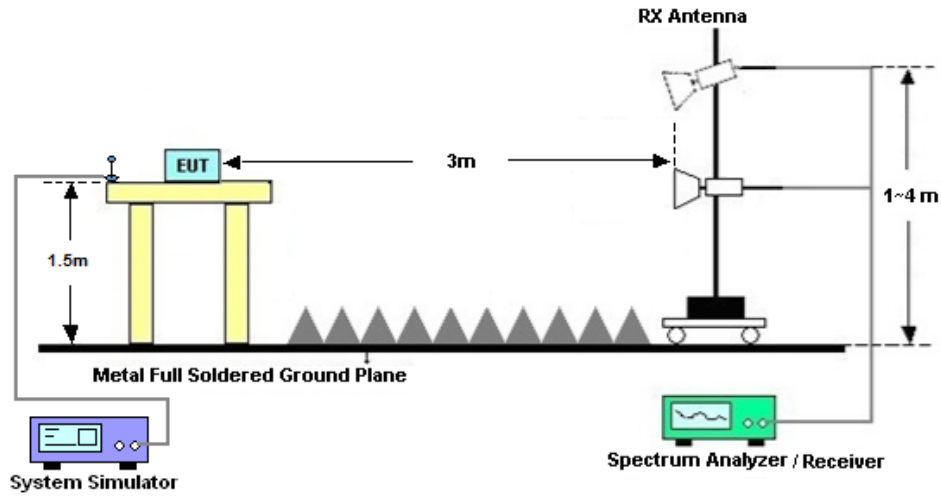

### 4.3 Test Result of Radiated Test

The low frequency, which started from 9 kHz to 30MHz, was pre-scanned and the result which was 20dB lower than the limit line was not reported.

Please refer to Appendix B.

## 4.4 Radiated Spurious Emission Measurement

### 4.4.1 Description of Radiated Spurious Emission

The radiated spurious emission was measured by substitution method according to ANSI/TIA-603-E. The power of any emission outside of the authorized operating frequency ranges shall not exceed -13 dBm/MHz.

The spectrum is scanned from 30 MHz up to a frequency including its 10th harmonic.

### 4.4.2 Test Procedures

1. The testing follows ANSI C63.26 Section 5.5
2. The EUT was placed on a turntable with 0.8 meter height for frequency below 1GHz and 1.5 meter height for frequency above 1GHz respectively above ground.
3. The EUT was set 3 meters from the receiving antenna mounted on the antenna tower.
4. The table was rotated 360 degrees to determine the position of the highest spurious emission.
5. The height of the receiving antenna is varied between 1m to 4m to search the maximum spurious emission for both horizontal and vertical polarizations.
6. During the measurement, the system simulator parameters were set to force the EUT transmitting at maximum output power.
7. Make the measurement with the spectrum analyzer's RBW = 1MHz, VBW = 3MHz, taking the record of maximum spurious emission.
8. A horn antenna was substituted in place of the EUT and was driven by a signal generator.
9. Tune the output power of signal generator to the same emission level with EUT maximum spurious emission.  
$$\text{EIRP (dBm)} = \text{S.G. Power} - \text{Tx Cable Loss} + \text{Tx Antenna Gain}$$
$$\text{ERP (dBm)} = \text{EIRP} - 2.15$$
10. The RF fundamental frequency should be excluded against the limit line in the operating frequency band.



## 5 List of Measuring Equipment

Instrument	Manufacturer	Model No.	Serial No.	Characteristics	Calibration Date	Test Date	Due Date	Remark
Spectrum Analyzer	R&S	FSV40	101078	10Hz~40GHz	Apr. 08, 2021	Nov. 21, 2021~ Dec. 29, 2021	Apr. 07, 2022	Conducted (TH01-SZ)
DC Power Supply	TTI	PL330P	290070	Max 32V , 3A	Oct. 25, 2021	Nov. 21, 2021~ Dec. 29, 2021	Oct. 24, 2022	Conducted (TH01-SZ)
Power Divider	TOJOIN	PS-2SM-04 265	60.06.020.007 7	0.4GHz~26.5GHz	Dec. 26, 2020	Nov. 21, 2021~ Dec. 29, 2021	Dec. 25, 2021	Conducted (TH01-SZ)
Power Divider	TOJOIN	PS-2SM-04 265	60.06.020.007 7	0.4GHz~26.5GHz	Dec. 25, 2021		Dec. 24, 2022	Conducted (TH01-SZ)
Thermal Chamber	Ten Billion Hongzhangroup	LP-150U	H2014081803	-40~+150°C	Jul. 14, 2021	Nov. 21, 2021~ Dec. 29, 2021	Jul. 13, 2022	Conducted (TH01-SZ)
EMI Test Receiver&SA	KEYSIGHT	N9038A	MY54450083	20Hz~8.4GHz	Apr. 07, 2021	Jan. 06, 2022	Apr. 06, 2022	Radiation (03CH03-SZ)
Loop Antenna	R&S	HFH2-Z2	100354	9kHz~30MHz	Jun. 22, 2020	Jan. 06, 2022	Jun. 21, 2022	Radiation (03CH03-SZ)
EXA Spectrum Analyzer	KEYSIGHT	N9010A	MY55150246	10Hz~44GHz;	Apr. 07, 2021	Jan. 06, 2022	Apr. 06, 2022	Radiation (03CH03-SZ)
Bilog Antenna	TeseQ	CBL6112D	35408	30MHz-2GHz	Jun. 22, 2020	Jan. 06, 2022	Jun. 21, 2022	Radiation (03CH03-SZ)
Double Ridge Horn Antenna	SCHWARZBECK	BBHA9120D	9120D-1355	1GHz~18GHz	Apr. 25, 2021	Jan. 06, 2022	Apr. 24, 2022	Radiation (03CH03-SZ)
Amplifier	Burgeon	BPA-530	102211	0.01Hz ~3000MHz	Oct. 22, 2021	Jan. 06, 2022	Oct. 21, 2022	Radiation (03CH03-SZ)
HF Amplifier	MITEQ	TTA1840-35 -HG	1871923	18GHz~40GHz	Oct. 22, 2021	Jan. 06, 2022	Oct. 21, 2022	Radiation (03CH03-SZ)
SHF-EHF Horn	com-power	AH-840	101071	18Ghz-40GHz	Apr. 11, 2021	Jan. 06, 2022	Apr. 10, 2022	Radiation (03CH03-SZ)
Amplifier	Agilent Technologies	83017A	MY39501302	500MHz~26.5GHz	Dec. 29, 2021	Jan. 06, 2022	Dec. 28, 2022	Radiation (03CH03-SZ)
AC Power Source	Chroma	61601	616010001985	N/A	NCR	Jan. 06, 2022	NCR	Radiation (03CH03-SZ)
Turn Table	EM	EM1000	N/A	0~360 degree	NCR	Jan. 06, 2022	NCR	Radiation (03CH03-SZ)
Antenna Mast	EM	EM1000	N/A	1 m~4 m	NCR	Jan. 06, 2022	NCR	Radiation (03CH03-SZ)

NCR: No Calibration Required



## 6 Uncertainty of Evaluation

The measurement uncertainties shown below were calculated in accordance with the requirements of ANSI 63.26-2015. All the measurement uncertainty value were shown with a coverage K=2 to indicate 95% level of confidence. The measurement data show herein meets or exceeds the CISPR measurement uncertainty values specified in CISPR 16-4-2 and can be compared directly to specified limit to determine compliance.

### Uncertainty of Radiated Emission Measurement (30 MHz ~ 1000 MHz)

Measuring Uncertainty for a Level of Confidence of 95% (U = 2Uc(y))	3dB
---	-----

### Uncertainty of Radiated Emission Measurement (1 GHz ~ 18 GHz)

Measuring Uncertainty for a Level of Confidence of 95% (U = 2Uc(y))	3.6dB
---	-------

### Uncertainty of Radiated Emission Measurement (18 GHz ~ 40 GHz)

Measuring Uncertainty for a Level of Confidence of 95% (U = 2Uc(y))	3.8dB
---	-------

----- THE END -----



## Appendix A. Test Results of Conducted Test

Test Engineer :	Jung Kuo	Temperature :	24~26°C
		Relative Humidity :	50~53%



Software Version: 21.02.111001

# FR1 N77

LTE Band: 5, LTE BW: 10M, LTE ARFCN: Mid

## Conducted Output Power

NR Band	SCS (kHz)	Bandwidth (MHz)	Arfcn	Freq (MHz)	Modulation	RB	Conducted Power(dBm)
77	30	20	630668	3460.02	DFT-s-OFDM PI/2 BPSK	25@12	22.84
77	30	20	630668	3460.02	DFT-s-OFDM PI/2 BPSK	1@1	22.98
77	30	20	630668	3460.02	DFT-s-OFDM PI/2 BPSK	1@49	22.79
77	30	20	630668	3460.02	DFT-s-OFDM QPSK	25@12	22.83
77	30	20	630668	3460.02	DFT-s-OFDM QPSK	1@1	22.99
77	30	20	630668	3460.02	DFT-s-OFDM QPSK	1@49	22.77
77	30	20	630668	3460.02	DFT-s-OFDM 16 QAM	25@12	21.84
77	30	20	630668	3460.02	DFT-s-OFDM 16 QAM	1@1	22.03
77	30	20	630668	3460.02	DFT-s-OFDM 16 QAM	1@49	21.8
77	30	20	630668	3460.02	DFT-s-OFDM 64 QAM	25@12	20.34
77	30	20	630668	3460.02	DFT-s-OFDM 64 QAM	1@1	20.45
77	30	20	630668	3460.02	DFT-s-OFDM 64 QAM	1@49	20.22
77	30	20	630668	3460.02	DFT-s-OFDM 256 QAM	25@12	18.31
77	30	20	630668	3460.02	DFT-s-OFDM 256 QAM	1@1	18.5
77	30	20	630668	3460.02	DFT-s-OFDM 256 QAM	1@49	18.16
77	30	20	630668	3460.02	CP-OFDM QPSK	25@12	21.35
77	30	20	630668	3460.02	CP-OFDM QPSK	1@1	21.61
77	30	20	630668	3460.02	CP-OFDM QPSK	1@49	21.41
77	30	20	633334	3500.01	DFT-s-OFDM PI/2 BPSK	25@12	22.9
77	30	20	633334	3500.01	DFT-s-OFDM PI/2 BPSK	1@1	22.97
77	30	20	633334	3500.01	DFT-s-OFDM PI/2 BPSK	1@49	22.76
77	30	20	633334	3500.01	DFT-s-OFDM QPSK	25@12	22.89
77	30	20	633334	3500.01	DFT-s-OFDM QPSK	1@1	23
77	30	20	633334	3500.01	DFT-s-OFDM QPSK	1@49	22.74
77	30	20	633334	3500.01	DFT-s-OFDM 16 QAM	25@12	21.89





77	30	20	633334	3500.01	DFT-s-OFDM 16 QAM	1@1	22.01
77	30	20	633334	3500.01	DFT-s-OFDM 16 QAM	1@49	21.75
77	30	20	633334	3500.01	DFT-s-OFDM 64 QAM	25@12	20.34
77	30	20	633334	3500.01	DFT-s-OFDM 64 QAM	1@1	20.51
77	30	20	633334	3500.01	DFT-s-OFDM 64 QAM	1@49	20.27
77	30	20	633334	3500.01	DFT-s-OFDM 256 QAM	25@12	18.37
77	30	20	633334	3500.01	DFT-s-OFDM 256 QAM	1@1	18.54
77	30	20	633334	3500.01	DFT-s-OFDM 256 QAM	1@49	18.21
77	30	20	633334	3500.01	CP-OFDM QPSK	25@12	21.42
77	30	20	633334	3500.01	CP-OFDM QPSK	1@1	21.58
77	30	20	633334	3500.01	CP-OFDM QPSK	1@49	21.33
77	30	20	636000	3540	DFT-s-OFDM PI/2 BPSK	25@12	22.75
77	30	20	636000	3540	DFT-s-OFDM PI/2 BPSK	1@1	22.7
77	30	20	636000	3540	DFT-s-OFDM PI/2 BPSK	1@49	22.61
77	30	20	636000	3540	DFT-s-OFDM QPSK	25@12	22.62
77	30	20	636000	3540	DFT-s-OFDM QPSK	1@1	22.77
77	30	20	636000	3540	DFT-s-OFDM QPSK	1@49	22.63
77	30	20	636000	3540	DFT-s-OFDM 16 QAM	25@12	21.66
77	30	20	636000	3540	DFT-s-OFDM 16 QAM	1@1	21.82
77	30	20	636000	3540	DFT-s-OFDM 16 QAM	1@49	21.65
77	30	20	636000	3540	DFT-s-OFDM 64 QAM	25@12	20.16
77	30	20	636000	3540	DFT-s-OFDM 64 QAM	1@1	20.27
77	30	20	636000	3540	DFT-s-OFDM 64 QAM	1@49	20.14
77	30	20	636000	3540	DFT-s-OFDM 256 QAM	25@12	18.07
77	30	20	636000	3540	DFT-s-OFDM 256 QAM	1@1	18.17
77	30	20	636000	3540	DFT-s-OFDM 256 QAM	1@49	18.15
77	30	20	636000	3540	CP-OFDM QPSK	25@12	21.11
77	30	20	636000	3540	CP-OFDM QPSK	1@1	21.35
77	30	20	636000	3540	CP-OFDM QPSK	1@49	21.24
77	30	30	631000	3465	DFT-s-OFDM PI/2 BPSK	36@18	22.94
77	30	30	631000	3465	DFT-s-OFDM PI/2 BPSK	1@1	23.17
77	30	30	631000	3465	DFT-s-OFDM PI/2 BPSK	1@76	22.99
77	30	30	631000	3465	DFT-s-OFDM QPSK	36@18	22.97
77	30	30	631000	3465	DFT-s-OFDM	1@1	23.16



QPSK							
77	30	30	631000	3465	DFT-s-OFDM QPSK	1@76	23.01
77	30	30	631000	3465	DFT-s-OFDM 16 QAM	36@18	21.98
77	30	30	631000	3465	DFT-s-OFDM 16 QAM	1@1	22.08
77	30	30	631000	3465	DFT-s-OFDM 16 QAM	1@76	22.08
77	30	30	631000	3465	DFT-s-OFDM 64 QAM	36@18	20.5
77	30	30	631000	3465	DFT-s-OFDM 64 QAM	1@1	20.51
77	30	30	631000	3465	DFT-s-OFDM 64 QAM	1@76	20.49
77	30	30	631000	3465	DFT-s-OFDM 256 QAM	36@18	18.44
77	30	30	631000	3465	DFT-s-OFDM 256 QAM	1@1	18.61
77	30	30	631000	3465	DFT-s-OFDM 256 QAM	1@76	18.4
77	30	30	631000	3465	CP-OFDM QPSK	39@19	21.48
77	30	30	631000	3465	CP-OFDM QPSK	1@1	21.82
77	30	30	631000	3465	CP-OFDM QPSK	1@76	21.51
77	30	30	633334	3500.01	DFT-s-OFDM PI/2 BPSK	36@18	23.05
77	30	30	633334	3500.01	DFT-s-OFDM PI/2 BPSK	1@1	23.17
77	30	30	633334	3500.01	DFT-s-OFDM PI/2 BPSK	1@76	22.9
77	30	30	633334	3500.01	DFT-s-OFDM QPSK	36@18	22.99
77	30	30	633334	3500.01	DFT-s-OFDM QPSK	1@1	23.14
77	30	30	633334	3500.01	DFT-s-OFDM QPSK	1@76	22.9
77	30	30	633334	3500.01	DFT-s-OFDM 16 QAM	36@18	21.98
77	30	30	633334	3500.01	DFT-s-OFDM 16 QAM	1@1	22.08
77	30	30	633334	3500.01	DFT-s-OFDM 16 QAM	1@76	21.78
77	30	30	633334	3500.01	DFT-s-OFDM 64 QAM	36@18	20.44
77	30	30	633334	3500.01	DFT-s-OFDM 64 QAM	1@1	20.61
77	30	30	633334	3500.01	DFT-s-OFDM 64 QAM	1@76	20.31
77	30	30	633334	3500.01	DFT-s-OFDM 256 QAM	36@18	18.45
77	30	30	633334	3500.01	DFT-s-OFDM 256 QAM	1@1	18.6
77	30	30	633334	3500.01	DFT-s-OFDM 256 QAM	1@76	18.31
77	30	30	633334	3500.01	CP-OFDM QPSK	39@19	21.44
77	30	30	633334	3500.01	CP-OFDM QPSK	1@1	21.69
77	30	30	633334	3500.01	CP-OFDM QPSK	1@76	21.34
77	30	30	635666	3534.99	DFT-s-OFDM PI/2 BPSK	36@18	22.85
77	30	30	635666	3534.99	DFT-s-OFDM PI/2 BPSK	1@1	22.91



77	30	30	635666	3534.99	DFT-s-OFDM PI/2 BPSK	1@76	22.83
77	30	30	635666	3534.99	DFT-s-OFDM QPSK	36@18	22.77
77	30	30	635666	3534.99	DFT-s-OFDM QPSK	1@1	22.88
77	30	30	635666	3534.99	DFT-s-OFDM QPSK	1@76	22.88
77	30	30	635666	3534.99	DFT-s-OFDM 16 QAM	36@18	21.77
77	30	30	635666	3534.99	DFT-s-OFDM 16 QAM	1@1	21.94
77	30	30	635666	3534.99	DFT-s-OFDM 16 QAM	1@76	21.86
77	30	30	635666	3534.99	DFT-s-OFDM 64 QAM	36@18	20.28
77	30	30	635666	3534.99	DFT-s-OFDM 64 QAM	1@1	20.41
77	30	30	635666	3534.99	DFT-s-OFDM 64 QAM	1@76	20.29
77	30	30	635666	3534.99	DFT-s-OFDM 256 QAM	36@18	18.26
77	30	30	635666	3534.99	DFT-s-OFDM 256 QAM	1@1	18.37
77	30	30	635666	3534.99	DFT-s-OFDM 256 QAM	1@76	18.37
77	30	30	635666	3534.99	CP-OFDM QPSK	39@19	21.36
77	30	30	635666	3534.99	CP-OFDM QPSK	1@1	21.38
77	30	30	635666	3534.99	CP-OFDM QPSK	1@76	21.4
77	30	40	631334	3470.01	DFT-s-OFDM PI/2 BPSK	50@25	22.97
77	30	40	631334	3470.01	DFT-s-OFDM PI/2 BPSK	1@1	23.15
77	30	40	631334	3470.01	DFT-s-OFDM PI/2 BPSK	1@104	23.01
77	30	40	631334	3470.01	DFT-s-OFDM QPSK	50@25	23.01
77	30	40	631334	3470.01	DFT-s-OFDM QPSK	1@1	23.13
77	30	40	631334	3470.01	DFT-s-OFDM QPSK	1@104	23.03
77	30	40	631334	3470.01	DFT-s-OFDM 16 QAM	50@25	21.96
77	30	40	631334	3470.01	DFT-s-OFDM 16 QAM	1@1	22.15
77	30	40	631334	3470.01	DFT-s-OFDM 16 QAM	1@104	22.07
77	30	40	631334	3470.01	DFT-s-OFDM 64 QAM	50@25	20.49
77	30	40	631334	3470.01	DFT-s-OFDM 64 QAM	1@1	20.55
77	30	40	631334	3470.01	DFT-s-OFDM 64 QAM	1@104	20.6
77	30	40	631334	3470.01	DFT-s-OFDM 256 QAM	50@25	18.48
77	30	40	631334	3470.01	DFT-s-OFDM 256 QAM	1@1	18.46
77	30	40	631334	3470.01	DFT-s-OFDM 256 QAM	1@104	18.47
77	30	40	631334	3470.01	CP-OFDM QPSK	53@26	21.5
77	30	40	631334	3470.01	CP-OFDM QPSK	1@1	21.69



77	30	40	631334	3470.01	CP-OFDM QPSK	1@104	21.63
77	30	40	633334	3500.01	DFT-s-OFDM PI/2 BPSK	50@25	23.01
77	30	40	633334	3500.01	DFT-s-OFDM PI/2 BPSK	1@1	23.14
77	30	40	633334	3500.01	DFT-s-OFDM PI/2 BPSK	1@104	22.86
77	30	40	633334	3500.01	DFT-s-OFDM QPSK	50@25	23
77	30	40	633334	3500.01	DFT-s-OFDM QPSK	1@1	23.14
77	30	40	633334	3500.01	DFT-s-OFDM QPSK	1@104	22.81
77	30	40	633334	3500.01	DFT-s-OFDM 16 QAM	50@25	22
77	30	40	633334	3500.01	DFT-s-OFDM 16 QAM	1@1	22.23
77	30	40	633334	3500.01	DFT-s-OFDM 16 QAM	1@104	21.92
77	30	40	633334	3500.01	DFT-s-OFDM 64 QAM	50@25	20.45
77	30	40	633334	3500.01	DFT-s-OFDM 64 QAM	1@1	20.57
77	30	40	633334	3500.01	DFT-s-OFDM 64 QAM	1@104	20.34
77	30	40	633334	3500.01	DFT-s-OFDM 256 QAM	50@25	18.49
77	30	40	633334	3500.01	DFT-s-OFDM 256 QAM	1@1	18.7
77	30	40	633334	3500.01	DFT-s-OFDM 256 QAM	1@104	18.32
77	30	40	633334	3500.01	CP-OFDM QPSK	53@26	21.45
77	30	40	633334	3500.01	CP-OFDM QPSK	1@1	21.64
77	30	40	633334	3500.01	CP-OFDM QPSK	1@104	21.45
77	30	40	635332	3529.98	DFT-s-OFDM PI/2 BPSK	50@25	22.87
77	30	40	635332	3529.98	DFT-s-OFDM PI/2 BPSK	1@1	23.03
77	30	40	635332	3529.98	DFT-s-OFDM PI/2 BPSK	1@104	22.85
77	30	40	635332	3529.98	DFT-s-OFDM QPSK	50@25	22.87
77	30	40	635332	3529.98	DFT-s-OFDM QPSK	1@1	23.02
77	30	40	635332	3529.98	DFT-s-OFDM QPSK	1@104	22.88
77	30	40	635332	3529.98	DFT-s-OFDM 16 QAM	50@25	21.86
77	30	40	635332	3529.98	DFT-s-OFDM 16 QAM	1@1	22.04
77	30	40	635332	3529.98	DFT-s-OFDM 16 QAM	1@104	21.91
77	30	40	635332	3529.98	DFT-s-OFDM 64 QAM	50@25	20.37
77	30	40	635332	3529.98	DFT-s-OFDM 64 QAM	1@1	20.45
77	30	40	635332	3529.98	DFT-s-OFDM 64 QAM	1@104	20.42
77	30	40	635332	3529.98	DFT-s-OFDM 256 QAM	50@25	18.35
77	30	40	635332	3529.98	DFT-s-OFDM 256 QAM	1@1	18.48



77	30	40	635332	3529.98	DFT-s-OFDM 256 QAM	1@104	18.37
77	30	40	635332	3529.98	CP-OFDM QPSK	53@26	21.33
77	30	40	635332	3529.98	CP-OFDM QPSK	1@1	21.66
77	30	40	635332	3529.98	CP-OFDM QPSK	1@104	21.46
77	30	50	631668	3475.02	DFT-s-OFDM PI/2 BPSK	64@32	22.77
77	30	50	631668	3475.02	DFT-s-OFDM PI/2 BPSK	1@1	22.93
77	30	50	631668	3475.02	DFT-s-OFDM PI/2 BPSK	1@131	22.64
77	30	50	631668	3475.02	DFT-s-OFDM QPSK	64@32	22.71
77	30	50	631668	3475.02	DFT-s-OFDM QPSK	1@1	22.91
77	30	50	631668	3475.02	DFT-s-OFDM QPSK	1@131	22.73
77	30	50	631668	3475.02	DFT-s-OFDM 16 QAM	64@32	21.72
77	30	50	631668	3475.02	DFT-s-OFDM 16 QAM	1@1	22.08
77	30	50	631668	3475.02	DFT-s-OFDM 16 QAM	1@131	21.84
77	30	50	631668	3475.02	DFT-s-OFDM 64 QAM	64@32	20.25
77	30	50	631668	3475.02	DFT-s-OFDM 64 QAM	1@1	20.39
77	30	50	631668	3475.02	DFT-s-OFDM 64 QAM	1@131	20.23
77	30	50	631668	3475.02	DFT-s-OFDM 256 QAM	64@32	18.19
77	30	50	631668	3475.02	DFT-s-OFDM 256 QAM	1@1	18.4
77	30	50	631668	3475.02	DFT-s-OFDM 256 QAM	1@131	18.18
77	30	50	631668	3475.02	CP-OFDM QPSK	67@33	21.21
77	30	50	631668	3475.02	CP-OFDM QPSK	1@1	21.5
77	30	50	631668	3475.02	CP-OFDM QPSK	1@131	21.22
77	30	50	633334	3500.01	DFT-s-OFDM PI/2 BPSK	64@32	22.79
77	30	50	633334	3500.01	DFT-s-OFDM PI/2 BPSK	1@1	22.82
77	30	50	633334	3500.01	DFT-s-OFDM PI/2 BPSK	1@131	22.37
77	30	50	633334	3500.01	DFT-s-OFDM QPSK	64@32	22.81
77	30	50	633334	3500.01	DFT-s-OFDM QPSK	1@1	22.8
77	30	50	633334	3500.01	DFT-s-OFDM QPSK	1@131	22.4
77	30	50	633334	3500.01	DFT-s-OFDM 16 QAM	64@32	21.8
77	30	50	633334	3500.01	DFT-s-OFDM 16 QAM	1@1	21.82
77	30	50	633334	3500.01	DFT-s-OFDM 16 QAM	1@131	21.43
77	30	50	633334	3500.01	DFT-s-OFDM 64 QAM	64@32	20.29
77	30	50	633334	3500.01	DFT-s-OFDM 64 QAM	1@1	20.33
77	30	50	633334	3500.01	DFT-s-OFDM 64 QAM	1@131	19.91



QAM								
77	30	50	633334	3500.01	DFT-s-OFDM 256 QAM	64@32	18.33	
77	30	50	633334	3500.01	DFT-s-OFDM 256 QAM	1@1	18.17	
77	30	50	633334	3500.01	DFT-s-OFDM 256 QAM	1@131	17.88	
77	30	50	633334	3500.01	CP-OFDM QPSK	67@33	21.29	
77	30	50	633334	3500.01	CP-OFDM QPSK	1@1	21.4	
77	30	50	633334	3500.01	CP-OFDM QPSK	1@131	20.98	
77	30	50	635000	3525	DFT-s-OFDM PI/2 BPSK	64@32	22.63	
77	30	50	635000	3525	DFT-s-OFDM PI/2 BPSK	1@1	22.87	
77	30	50	635000	3525	DFT-s-OFDM PI/2 BPSK	1@131	22.56	
77	30	50	635000	3525	DFT-s-OFDM QPSK	64@32	22.63	
77	30	50	635000	3525	DFT-s-OFDM QPSK	1@1	22.82	
77	30	50	635000	3525	DFT-s-OFDM QPSK	1@131	22.51	
77	30	50	635000	3525	DFT-s-OFDM 16 QAM	64@32	21.64	
77	30	50	635000	3525	DFT-s-OFDM 16 QAM	1@1	21.99	
77	30	50	635000	3525	DFT-s-OFDM 16 QAM	1@131	21.58	
77	30	50	635000	3525	DFT-s-OFDM 64 QAM	64@32	20.13	
77	30	50	635000	3525	DFT-s-OFDM 64 QAM	1@1	20.35	
77	30	50	635000	3525	DFT-s-OFDM 64 QAM	1@131	19.92	
77	30	50	635000	3525	DFT-s-OFDM 256 QAM	64@32	18.05	
77	30	50	635000	3525	DFT-s-OFDM 256 QAM	1@1	18.31	
77	30	50	635000	3525	DFT-s-OFDM 256 QAM	1@131	18.01	
77	30	50	635000	3525	CP-OFDM QPSK	67@33	21.13	
77	30	50	635000	3525	CP-OFDM QPSK	1@1	21.44	
77	30	50	635000	3525	CP-OFDM QPSK	1@131	21.12	
77	30	60	632000	3480	DFT-s-OFDM PI/2 BPSK	81@40	22.72	
77	30	60	632000	3480	DFT-s-OFDM PI/2 BPSK	1@1	22.96	
77	30	60	632000	3480	DFT-s-OFDM PI/2 BPSK	1@160	22.57	
77	30	60	632000	3480	DFT-s-OFDM QPSK	81@40	22.73	
77	30	60	632000	3480	DFT-s-OFDM QPSK	1@1	22.89	
77	30	60	632000	3480	DFT-s-OFDM QPSK	1@160	22.52	
77	30	60	632000	3480	DFT-s-OFDM 16 QAM	81@40	21.76	
77	30	60	632000	3480	DFT-s-OFDM 16 QAM	1@1	21.99	
77	30	60	632000	3480	DFT-s-OFDM 16 QAM	1@160	21.58	



77	30	60	632000	3480	DFT-s-OFDM 64 QAM	81@40	20.25
77	30	60	632000	3480	DFT-s-OFDM 64 QAM	1@1	20.47
77	30	60	632000	3480	DFT-s-OFDM 64 QAM	1@160	20
77	30	60	632000	3480	DFT-s-OFDM 256 QAM	81@40	18.27
77	30	60	632000	3480	DFT-s-OFDM 256 QAM	1@1	18.47
77	30	60	632000	3480	DFT-s-OFDM 256 QAM	1@160	18.02
77	30	60	632000	3480	CP-OFDM QPSK	81@40	21.23
77	30	60	632000	3480	CP-OFDM QPSK	1@1	21.47
77	30	60	632000	3480	CP-OFDM QPSK	1@160	21.15
77	30	60	633334	3500.01	DFT-s-OFDM PI/2 BPSK	81@40	22.74
77	30	60	633334	3500.01	DFT-s-OFDM PI/2 BPSK	1@1	22.78
77	30	60	633334	3500.01	DFT-s-OFDM PI/2 BPSK	1@160	22.42
77	30	60	633334	3500.01	DFT-s-OFDM QPSK	81@40	22.78
77	30	60	633334	3500.01	DFT-s-OFDM QPSK	1@1	22.76
77	30	60	633334	3500.01	DFT-s-OFDM QPSK	1@160	22.42
77	30	60	633334	3500.01	DFT-s-OFDM 16 QAM	81@40	21.82
77	30	60	633334	3500.01	DFT-s-OFDM 16 QAM	1@1	21.77
77	30	60	633334	3500.01	DFT-s-OFDM 16 QAM	1@160	21.57
77	30	60	633334	3500.01	DFT-s-OFDM 64 QAM	81@40	20.29
77	30	60	633334	3500.01	DFT-s-OFDM 64 QAM	1@1	20.26
77	30	60	633334	3500.01	DFT-s-OFDM 64 QAM	1@160	19.91
77	30	60	633334	3500.01	DFT-s-OFDM 256 QAM	81@40	18.28
77	30	60	633334	3500.01	DFT-s-OFDM 256 QAM	1@1	18.23
77	30	60	633334	3500.01	DFT-s-OFDM 256 QAM	1@160	17.78
77	30	60	633334	3500.01	CP-OFDM QPSK	81@40	21.29
77	30	60	633334	3500.01	CP-OFDM QPSK	1@1	21.4
77	30	60	633334	3500.01	CP-OFDM QPSK	1@160	21.04
77	30	60	634666	3519.99	DFT-s-OFDM PI/2 BPSK	81@40	22.69
77	30	60	634666	3519.99	DFT-s-OFDM PI/2 BPSK	1@1	23.01
77	30	60	634666	3519.99	DFT-s-OFDM PI/2 BPSK	1@160	22.51
77	30	60	634666	3519.99	DFT-s-OFDM QPSK	81@40	22.65
77	30	60	634666	3519.99	DFT-s-OFDM QPSK	1@1	23.03
77	30	60	634666	3519.99	DFT-s-OFDM QPSK	1@160	22.56
77	30	60	634666	3519.99	DFT-s-OFDM 16	81@40	21.7



QAM								
77	30	60	634666	3519.99	DFT-s-OFDM 16 QAM	1@1	22.19	
77	30	60	634666	3519.99	DFT-s-OFDM 16 QAM	1@160	21.64	
77	30	60	634666	3519.99	DFT-s-OFDM 64 QAM	81@40	20.16	
77	30	60	634666	3519.99	DFT-s-OFDM 64 QAM	1@1	20.48	
77	30	60	634666	3519.99	DFT-s-OFDM 64 QAM	1@160	20.09	
77	30	60	634666	3519.99	DFT-s-OFDM 256 QAM	81@40	18.14	
77	30	60	634666	3519.99	DFT-s-OFDM 256 QAM	1@1	18.5	
77	30	60	634666	3519.99	DFT-s-OFDM 256 QAM	1@160	18.04	
77	30	60	634666	3519.99	CP-OFDM QPSK	81@40	21.17	
77	30	60	634666	3519.99	CP-OFDM QPSK	1@1	21.54	
77	30	60	634666	3519.99	CP-OFDM QPSK	1@160	21.13	
77	30	70	632334	3485.01	DFT-s-OFDM PI/2 BPSK	90@45	22.71	
77	30	70	632334	3485.01	DFT-s-OFDM PI/2 BPSK	1@1	23	
77	30	70	632334	3485.01	DFT-s-OFDM PI/2 BPSK	1@187	22.38	
77	30	70	632334	3485.01	DFT-s-OFDM QPSK	90@45	22.76	
77	30	70	632334	3485.01	DFT-s-OFDM QPSK	1@1	22.92	
77	30	70	632334	3485.01	DFT-s-OFDM QPSK	1@187	22.36	
77	30	70	632334	3485.01	DFT-s-OFDM 16 QAM	90@45	21.79	
77	30	70	632334	3485.01	DFT-s-OFDM 16 QAM	1@1	22	
77	30	70	632334	3485.01	DFT-s-OFDM 16 QAM	1@187	21.44	
77	30	70	632334	3485.01	DFT-s-OFDM 64 QAM	90@45	20.25	
77	30	70	632334	3485.01	DFT-s-OFDM 64 QAM	1@1	20.46	
77	30	70	632334	3485.01	DFT-s-OFDM 64 QAM	1@187	19.89	
77	30	70	632334	3485.01	DFT-s-OFDM 256 QAM	90@45	18.26	
77	30	70	632334	3485.01	DFT-s-OFDM 256 QAM	1@1	18.5	
77	30	70	632334	3485.01	DFT-s-OFDM 256 QAM	1@187	17.82	
77	30	70	632334	3485.01	CP-OFDM QPSK	95@47	21.28	
77	30	70	632334	3485.01	CP-OFDM QPSK	1@1	21.6	
77	30	70	632334	3485.01	CP-OFDM QPSK	1@187	20.97	
77	30	70	633334	3500.01	DFT-s-OFDM PI/2 BPSK	90@45	22.75	
77	30	70	633334	3500.01	DFT-s-OFDM PI/2 BPSK	1@1	22.85	
77	30	70	633334	3500.01	DFT-s-OFDM PI/2 BPSK	1@187	22.42	
77	30	70	633334	3500.01	DFT-s-OFDM QPSK	90@45	22.8	





77	30	70	633334	3500.01	DFT-s-OFDM QPSK	1@1	22.85
77	30	70	633334	3500.01	DFT-s-OFDM QPSK	1@187	22.41
77	30	70	633334	3500.01	DFT-s-OFDM 16 QAM	90@45	21.79
77	30	70	633334	3500.01	DFT-s-OFDM 16 QAM	1@1	21.84
77	30	70	633334	3500.01	DFT-s-OFDM 16 QAM	1@187	21.43
77	30	70	633334	3500.01	DFT-s-OFDM 64 QAM	90@45	20.23
77	30	70	633334	3500.01	DFT-s-OFDM 64 QAM	1@1	20.38
77	30	70	633334	3500.01	DFT-s-OFDM 64 QAM	1@187	19.92
77	30	70	633334	3500.01	DFT-s-OFDM 256 QAM	90@45	18.27
77	30	70	633334	3500.01	DFT-s-OFDM 256 QAM	1@1	18.26
77	30	70	633334	3500.01	DFT-s-OFDM 256 QAM	1@187	17.82
77	30	70	633334	3500.01	CP-OFDM QPSK	95@47	21.27
77	30	70	633334	3500.01	CP-OFDM QPSK	1@1	21.33
77	30	70	633334	3500.01	CP-OFDM QPSK	1@187	21.03
77	30	70	634332	3514.98	DFT-s-OFDM PI/2 BPSK	90@45	22.71
77	30	70	634332	3514.98	DFT-s-OFDM PI/2 BPSK	1@1	22.92
77	30	70	634332	3514.98	DFT-s-OFDM PI/2 BPSK	1@187	22.46
77	30	70	634332	3514.98	DFT-s-OFDM QPSK	90@45	22.6
77	30	70	634332	3514.98	DFT-s-OFDM QPSK	1@1	22.94
77	30	70	634332	3514.98	DFT-s-OFDM QPSK	1@187	22.53
77	30	70	634332	3514.98	DFT-s-OFDM 16 QAM	90@45	21.65
77	30	70	634332	3514.98	DFT-s-OFDM 16 QAM	1@1	21.94
77	30	70	634332	3514.98	DFT-s-OFDM 16 QAM	1@187	21.54
77	30	70	634332	3514.98	DFT-s-OFDM 64 QAM	90@45	20.17
77	30	70	634332	3514.98	DFT-s-OFDM 64 QAM	1@1	20.45
77	30	70	634332	3514.98	DFT-s-OFDM 64 QAM	1@187	19.96
77	30	70	634332	3514.98	DFT-s-OFDM 256 QAM	90@45	18.16
77	30	70	634332	3514.98	DFT-s-OFDM 256 QAM	1@1	18.58
77	30	70	634332	3514.98	DFT-s-OFDM 256 QAM	1@187	17.92
77	30	70	634332	3514.98	CP-OFDM QPSK	95@47	21.11
77	30	70	634332	3514.98	CP-OFDM QPSK	1@1	21.52
77	30	70	634332	3514.98	CP-OFDM QPSK	1@187	21.07
77	30	80	632668	3490.02	DFT-s-OFDM PI/2 BPSK	108@54	22.74
77	30	80	632668	3490.02	DFT-s-OFDM PI/2	1@1	23.01



					BPSK			
77	30	80	632668	3490.02	DFT-s-OFDM PI/2 BPSK	1@215	22.32	
77	30	80	632668	3490.02	DFT-s-OFDM QPSK	108@54	22.71	
77	30	80	632668	3490.02	DFT-s-OFDM QPSK	1@1	23	
77	30	80	632668	3490.02	DFT-s-OFDM QPSK	1@215	22.35	
77	30	80	632668	3490.02	DFT-s-OFDM 16 QAM	108@54	21.75	
77	30	80	632668	3490.02	DFT-s-OFDM 16 QAM	1@1	22.03	
77	30	80	632668	3490.02	DFT-s-OFDM 16 QAM	1@215	21.37	
77	30	80	632668	3490.02	DFT-s-OFDM 64 QAM	108@54	20.23	
77	30	80	632668	3490.02	DFT-s-OFDM 64 QAM	1@1	20.59	
77	30	80	632668	3490.02	DFT-s-OFDM 64 QAM	1@215	19.78	
77	30	80	632668	3490.02	DFT-s-OFDM 256 QAM	108@54	18.21	
77	30	80	632668	3490.02	DFT-s-OFDM 256 QAM	1@1	18.46	
77	30	80	632668	3490.02	DFT-s-OFDM 256 QAM	1@215	17.87	
77	30	80	632668	3490.02	CP-OFDM QPSK	109@54	21.25	
77	30	80	632668	3490.02	CP-OFDM QPSK	1@1	21.53	
77	30	80	632668	3490.02	CP-OFDM QPSK	1@215	20.89	
77	30	80	633334	3500.01	DFT-s-OFDM PI/2 BPSK	108@54	22.75	
77	30	80	633334	3500.01	DFT-s-OFDM PI/2 BPSK	1@1	22.87	
77	30	80	633334	3500.01	DFT-s-OFDM PI/2 BPSK	1@215	22.41	
77	30	80	633334	3500.01	DFT-s-OFDM QPSK	108@54	22.77	
77	30	80	633334	3500.01	DFT-s-OFDM QPSK	1@1	22.88	
77	30	80	633334	3500.01	DFT-s-OFDM QPSK	1@215	22.41	
77	30	80	633334	3500.01	DFT-s-OFDM 16 QAM	108@54	21.78	
77	30	80	633334	3500.01	DFT-s-OFDM 16 QAM	1@1	21.91	
77	30	80	633334	3500.01	DFT-s-OFDM 16 QAM	1@215	21.5	
77	30	80	633334	3500.01	DFT-s-OFDM 64 QAM	108@54	20.26	
77	30	80	633334	3500.01	DFT-s-OFDM 64 QAM	1@1	20.38	
77	30	80	633334	3500.01	DFT-s-OFDM 64 QAM	1@215	19.95	
77	30	80	633334	3500.01	DFT-s-OFDM 256 QAM	108@54	18.26	
77	30	80	633334	3500.01	DFT-s-OFDM 256 QAM	1@1	18.37	
77	30	80	633334	3500.01	DFT-s-OFDM 256 QAM	1@215	17.92	
77	30	80	633334	3500.01	CP-OFDM QPSK	109@54	21.24	



77	30	80	633334	3500.01	CP-OFDM QPSK	1@1	21.53
77	30	80	633334	3500.01	CP-OFDM QPSK	1@215	20.98
77	30	80	634000	3510	DFT-s-OFDM PI/2 BPSK	108@54	22.6
77	30	80	634000	3510	DFT-s-OFDM PI/2 BPSK	1@1	22.9
77	30	80	634000	3510	DFT-s-OFDM PI/2 BPSK	1@215	22.4
77	30	80	634000	3510	DFT-s-OFDM QPSK	108@54	22.57
77	30	80	634000	3510	DFT-s-OFDM QPSK	1@1	22.88
77	30	80	634000	3510	DFT-s-OFDM QPSK	1@215	22.3
77	30	80	634000	3510	DFT-s-OFDM 16 QAM	108@54	21.62
77	30	80	634000	3510	DFT-s-OFDM 16 QAM	1@1	21.92
77	30	80	634000	3510	DFT-s-OFDM 16 QAM	1@215	21.38
77	30	80	634000	3510	DFT-s-OFDM 64 QAM	108@54	20.09
77	30	80	634000	3510	DFT-s-OFDM 64 QAM	1@1	20.52
77	30	80	634000	3510	DFT-s-OFDM 64 QAM	1@215	19.81
77	30	80	634000	3510	DFT-s-OFDM 256 QAM	108@54	18.11
77	30	80	634000	3510	DFT-s-OFDM 256 QAM	1@1	18.37
77	30	80	634000	3510	DFT-s-OFDM 256 QAM	1@215	17.98
77	30	80	634000	3510	CP-OFDM QPSK	109@54	21.07
77	30	80	634000	3510	CP-OFDM QPSK	1@1	21.41
77	30	80	634000	3510	CP-OFDM QPSK	1@215	20.93
77	30	90	633000	3495	DFT-s-OFDM PI/2 BPSK	120@60	22.76
77	30	90	633000	3495	DFT-s-OFDM PI/2 BPSK	1@1	23.09
77	30	90	633000	3495	DFT-s-OFDM PI/2 BPSK	1@243	22.45
77	30	90	633000	3495	DFT-s-OFDM QPSK	120@60	22.81
77	30	90	633000	3495	DFT-s-OFDM QPSK	1@1	23.08
77	30	90	633000	3495	DFT-s-OFDM QPSK	1@243	22.42
77	30	90	633000	3495	DFT-s-OFDM 16 QAM	120@60	21.79
77	30	90	633000	3495	DFT-s-OFDM 16 QAM	1@1	22.22
77	30	90	633000	3495	DFT-s-OFDM 16 QAM	1@243	21.43
77	30	90	633000	3495	DFT-s-OFDM 64 QAM	120@60	20.34
77	30	90	633000	3495	DFT-s-OFDM 64 QAM	1@1	20.58
77	30	90	633000	3495	DFT-s-OFDM 64 QAM	1@243	19.95
77	30	90	633000	3495	DFT-s-OFDM 256 QAM	120@60	18.26



77	30	90	633000	3495	DFT-s-OFDM 256 QAM	1@1	18.5
77	30	90	633000	3495	DFT-s-OFDM 256 QAM	1@243	18
77	30	90	633000	3495	CP-OFDM QPSK	123@61	21.28
77	30	90	633000	3495	CP-OFDM QPSK	1@1	21.74
77	30	90	633000	3495	CP-OFDM QPSK	1@243	20.93
77	30	90	633334	3500.01	DFT-s-OFDM PI/2 BPSK	120@60	22.77
77	30	90	633334	3500.01	DFT-s-OFDM PI/2 BPSK	1@1	23.06
77	30	90	633334	3500.01	DFT-s-OFDM PI/2 BPSK	1@243	22.39
77	30	90	633334	3500.01	DFT-s-OFDM QPSK	120@60	22.7
77	30	90	633334	3500.01	DFT-s-OFDM QPSK	1@1	22.94
77	30	90	633334	3500.01	DFT-s-OFDM QPSK	1@243	22.35
77	30	90	633334	3500.01	DFT-s-OFDM 16 QAM	120@60	21.66
77	30	90	633334	3500.01	DFT-s-OFDM 16 QAM	1@1	22.09
77	30	90	633334	3500.01	DFT-s-OFDM 16 QAM	1@243	21.45
77	30	90	633334	3500.01	DFT-s-OFDM 64 QAM	120@60	20.15
77	30	90	633334	3500.01	DFT-s-OFDM 64 QAM	1@1	20.4
77	30	90	633334	3500.01	DFT-s-OFDM 64 QAM	1@243	19.82
77	30	90	633334	3500.01	DFT-s-OFDM 256 QAM	120@60	18.13
77	30	90	633334	3500.01	DFT-s-OFDM 256 QAM	1@1	18.56
77	30	90	633334	3500.01	DFT-s-OFDM 256 QAM	1@243	17.87
77	30	90	633334	3500.01	CP-OFDM QPSK	123@61	21.25
77	30	90	633334	3500.01	CP-OFDM QPSK	1@1	21.69
77	30	90	633334	3500.01	CP-OFDM QPSK	1@243	20.96
77	30	90	633666	3504.99	DFT-s-OFDM PI/2 BPSK	120@60	22.71
77	30	90	633666	3504.99	DFT-s-OFDM PI/2 BPSK	1@1	22.97
77	30	90	633666	3504.99	DFT-s-OFDM PI/2 BPSK	1@243	22.35
77	30	90	633666	3504.99	DFT-s-OFDM QPSK	120@60	22.74
77	30	90	633666	3504.99	DFT-s-OFDM QPSK	1@1	22.95
77	30	90	633666	3504.99	DFT-s-OFDM QPSK	1@243	22.38
77	30	90	633666	3504.99	DFT-s-OFDM 16 QAM	120@60	21.72
77	30	90	633666	3504.99	DFT-s-OFDM 16 QAM	1@1	22
77	30	90	633666	3504.99	DFT-s-OFDM 16 QAM	1@243	21.39
77	30	90	633666	3504.99	DFT-s-OFDM 64 QAM	120@60	20.22
77	30	90	633666	3504.99	DFT-s-OFDM 64 QAM	1@1	20.39



QAM								
77	30	90	633666	3504.99	DFT-s-OFDM 64 QAM	1@243	19.83	
77	30	90	633666	3504.99	DFT-s-OFDM 256 QAM	120@60	18.21	
77	30	90	633666	3504.99	DFT-s-OFDM 256 QAM	1@1	18.4	
77	30	90	633666	3504.99	DFT-s-OFDM 256 QAM	1@243	17.83	
77	30	90	633666	3504.99	CP-OFDM QPSK	123@61	21.23	
77	30	90	633666	3504.99	CP-OFDM QPSK	1@1	21.69	
77	30	90	633666	3504.99	CP-OFDM QPSK	1@243	20.92	
77	30	100	633334	3500.01	DFT-s-OFDM PI/2 BPSK	135@67	22.72	
77	30	100	633334	3500.01	DFT-s-OFDM PI/2 BPSK	1@1	23.06	
77	30	100	633334	3500.01	DFT-s-OFDM PI/2 BPSK	1@271	22.39	
77	30	100	633334	3500.01	DFT-s-OFDM QPSK	135@67	22.72	
77	30	100	633334	3500.01	DFT-s-OFDM QPSK	1@1	23.09	
77	30	100	633334	3500.01	DFT-s-OFDM QPSK	1@271	22.4	
77	30	100	633334	3500.01	DFT-s-OFDM 16 QAM	135@67	21.76	
77	30	100	633334	3500.01	DFT-s-OFDM 16 QAM	1@1	22.04	
77	30	100	633334	3500.01	DFT-s-OFDM 16 QAM	1@271	21.46	
77	30	100	633334	3500.01	DFT-s-OFDM 64 QAM	135@67	20.23	
77	30	100	633334	3500.01	DFT-s-OFDM 64 QAM	1@1	20.59	
77	30	100	633334	3500.01	DFT-s-OFDM 64 QAM	1@271	19.93	
77	30	100	633334	3500.01	DFT-s-OFDM 256 QAM	135@67	18.24	
77	30	100	633334	3500.01	DFT-s-OFDM 256 QAM	1@1	18.47	
77	30	100	633334	3500.01	DFT-s-OFDM 256 QAM	1@271	17.95	
77	30	100	633334	3500.01	CP-OFDM QPSK	137@68	21.25	
77	30	100	633334	3500.01	CP-OFDM QPSK	1@1	21.62	
77	30	100	633334	3500.01	CP-OFDM QPSK	1@271	20.96	



### Frequency Stability

NR Band	SCS (kHz)	Bandwidth (MHz)	Arfcn	Freq (MHz)	Modulation	RB	Deviation (ppm)	Verdict	Environment
77	30	20	633334	3500.01	DFT-s-OFDM QPSK	50@0	0.0646	PASS	NV
77	30	20	633334	3500.01	DFT-s-OFDM QPSK	50@0	0.0347	PASS	LV
77	30	20	633334	3500.01	DFT-s-OFDM QPSK	50@0	0.0403	PASS	HV
77	30	20	633334	3500.01	DFT-s-OFDM QPSK	50@0	0.0209	PASS	-30°C
77	30	20	633334	3500.01	DFT-s-OFDM QPSK	50@0	0.0618	PASS	-20°C
77	30	20	633334	3500.01	DFT-s-OFDM QPSK	50@0	0.0487	PASS	-10°C
77	30	20	633334	3500.01	DFT-s-OFDM QPSK	50@0	0.0562	PASS	0°C
77	30	20	633334	3500.01	DFT-s-OFDM QPSK	50@0	0.0384	PASS	10°C
77	30	20	633334	3500.01	DFT-s-OFDM QPSK	50@0	0.0524	PASS	20°C
77	30	20	633334	3500.01	DFT-s-OFDM QPSK	50@0	0.0664	PASS	30°C
77	30	20	633334	3500.01	DFT-s-OFDM QPSK	50@0	0.0484	PASS	40°C
77	30	20	633334	3500.01	DFT-s-OFDM QPSK	50@0	0.0655	PASS	50°C



**Peak to Average Ratio**

NR Band	SCS (kHz)	Bandwidth (MHz)	Arfcn	Freq (MHz)	Modulation	RB	Result (dB)	Limit (dB)	Verdict
77	30	20	630668	3460.02	DFT-s-OFDM PI/2 BPSK	50@0	7.1	13	PASS
77	30	20	630668	3460.02	DFT-s-OFDM PI/2 BPSK	1@0	6.95	13	PASS
77	30	20	630668	3460.02	DFT-s-OFDM QPSK	50@0	8.05	13	PASS
77	30	20	630668	3460.02	DFT-s-OFDM QPSK	1@0	8.03	13	PASS
77	30	20	633334	3500.01	DFT-s-OFDM PI/2 BPSK	50@0	7.18	13	PASS
77	30	20	633334	3500.01	DFT-s-OFDM PI/2 BPSK	1@0	7.19	13	PASS
77	30	20	633334	3500.01	DFT-s-OFDM QPSK	50@0	8.39	13	PASS
77	30	20	633334	3500.01	DFT-s-OFDM QPSK	1@0	9.06	13	PASS
77	30	20	636000	3540.0	DFT-s-OFDM PI/2 BPSK	50@0	6.94	13	PASS
77	30	20	636000	3540.0	DFT-s-OFDM PI/2 BPSK	1@0	7.08	13	PASS
77	30	20	636000	3540.0	DFT-s-OFDM QPSK	50@0	8.42	13	PASS
77	30	20	636000	3540.0	DFT-s-OFDM QPSK	1@0	7.71	13	PASS



B5\_N77(20M)\_DFT-s-OFDM\_PI\_2-BPSK\_Outer\_Full\_Low\_CH

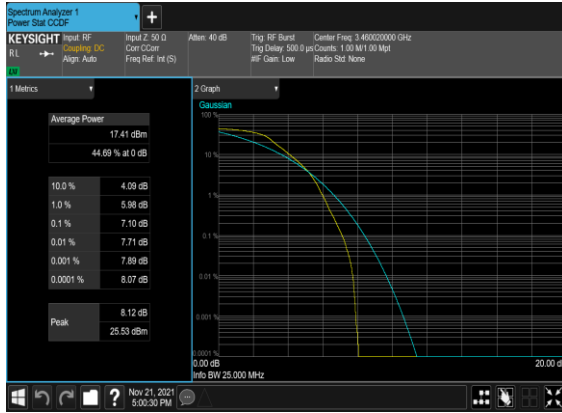

B5\_N77(20M)\_DFT-s-OFDM\_PI\_2-BPSK\_Edge\_1RB\_Left\_Low\_CH



B5\_N77(20M)\_DFT-s-OFDM\_QPSK\_Outer\_Full\_Low\_CH



B5\_N77(20M)\_DFT-s-OFDM\_QPSK\_Edge\_1RB\_Left\_Low\_CH

