



FCC RF Test Report

APPLICANT : Sierra Wireless, Inc.
EQUIPMENT : Wireless Module
BRAND NAME : AirPrime
MODEL NAME : EM9190
FCC ID : N7NEM91
STANDARD : 47 CFR Part 2, 96
CLASSIFICATION : Citizens Band End User Devices (CBE)
EQUIPMENT TYPE : End User Equipment
TEST DATE(S) : Feb. 08, 2022 ~ Aug. 01, 2022

We, Sporton International Inc. (ShenZhen), would like to declare that the tested sample has been evaluated in accordance with the procedures given in ANSI C63.26-2015 and shown compliance with the applicable technical standards.

The test results in this report apply exclusively to the tested model / sample. Without written approval of Sporton International Inc. (ShenZhen), the test report shall not be reproduced except in full.

Jason Jia

Approved by: Jason Jia



Sporton International Inc. (ShenZhen)

1/F, 2/F, Bldg 5, Shiling Industrial Zone, Xinwei Village, Xili, Nanshan, Shenzhen, 518055

People's Republic of China



Table of Contents

History of this test report.....	3
Summary of Test Result.....	4
1 General Description	5
1.1 Applicant.....	5
1.2 Manufacturer	5
1.3 Feature of Equipment Under Test.....	5
1.4 Maximum Conducted Power and Emission Designator	6
1.5 Testing Site.....	6
1.6 Test Software	6
1.7 Applied Standards	7
2 Test Configuration of Equipment Under Test	8
2.1 Test Mode.....	8
2.2 Connection Diagram of Test System	9
2.3 Support Unit used in test configuration	9
2.4 Measurement Results Explanation Example	9
2.5 Frequency List of Low/Middle/High Channels.....	10
3 Conducted Test Items.....	11
3.1 Measuring Instruments.....	11
3.2 Conducted Output Power	12
3.3 Occupied Bandwidth	13
3.4 Conducted Band Edge	14
3.5 Conducted Spurious Emission	15
3.6 Frequency Stability.....	16
4 Radiated Test Items	17
4.1 Measuring Instruments.....	17
4.2 Test Setup	17
4.3 Test Result of Radiated Test.....	18
4.4 Radiated Spurious Emission	19
5 List of Measuring Equipment.....	20
6 Uncertainty of Evaluation	21
Appendix A. Test Results of Conducted Test	
Appendix B. Test Results of Radiated Test	
Appendix C. Test Setup Photographs	



History of this test report

Report No.	Version	Description	Issued Date
FG1N1001-01	01	Initial issue of report	Aug. 12, 2022



Summary of Test Result

Report Clause	Ref Std. Clause	Test Items	Result (PASS/FAIL)	Remark
3.2	§2.1046	Conducted Output Power	Reporting only	-
3.3	§2.1049 §96.41	Occupied Bandwidth	Reporting only	-
3.4	§2.1051 §96.41	Conducted Band Edge Measurement Adjacent Channel Leakage Ratio	Pass	-
3.5	§2.1051 §96.41	Conducted Spurious Emission	Pass	-
3.6	§2.1055	Frequency Stability for Temperature & Voltage	Pass	-
4.4	§2.1051 §96.41	Radiated Spurious Emission	Pass	Under limit 13.64 dB at 10874.970 MHz

Declaration of Conformity:

The test results with all measurement uncertainty excluded are presented in accordance with the regulation limits or requirements declared by manufacturers.

Comments and Explanations:

The declared of product specification for EUT presented in the report are provided by the manufacturer, and the manufacturer takes all the responsibilities for the accuracy of product specification.



1 General Description

1.1 Applicant

Sierra Wireless, Inc.
13811 Wireless Way, Richmond, BC, Canada V6A 3A4

1.2 Manufacturer

Sierra Wireless, Inc.
13811 Wireless Way, Richmond, BC, Canada V6A 3A4

1.3 Feature of Equipment Under Test

Product Feature	
Equipment	Wireless Module
Brand Name	AirPrime
Model Name	EM9190
FCC ID	N7NEM91
Tx Frequency	5G NR n48: 3550 MHz ~ 3700 MHz
Rx Frequency	5G NR n48: 3550 MHz ~ 3700 MHz
SCS	30kHz
Bandwidth	10MHz / 20MHz / 40MHz
Type of Modulation	CP-OFDM: QPSK / 16QAM / 64QAM / 256QAM DFT-s-OFDM: PI/2 BPSK / QPSK / 16QAM / 64QAM / 256QAM
IMEI Code	Conducted : 351735110008640 Radiation : N/A
HW Version	1.0
SW Version	00.15.01.00
EUT Stage	Identical Prototype

Remark:

1. The above EUT's information was declared by manufacturer. Please refer to the specifications or user's manual for more detailed description.
2. 5G NR n48 supports SA and NSA mode, only NSA mode was required to be tested.
3. The EN-DC combinations declared by the manufacturer are as follows: DC_13A_n48A, DC_66A_n48A.
4. For NSA mode of all EN-DC combination, we only show the combination of the maximum power among all NSA combinations in the report.
5. For modulation of CP-OFDM and DFT-s-OFDM, the maximum power of CP-OFDM is lower than DFT-s-OFDM modulation, therefore, we chose higher power (DFT-s-OFDM modulation) to perform all tests and show in the report.



1.4 Maximum Conducted Power and Emission Designator

5G NR n48 EN-DC_13A-n48A		PI/2 BPSK / QPSK		16QAM/64QAM/256QAM	
BW (MHz)	Frequency Range (MHz)	Maximum Conducted power (W)	Emission Designator (99%OBW)	Maximum Conducted power (W)	Emission Designator (99%OBW)
10	3555.00~3694.98	0.1766	8M59G7D	0.1403	8M59W7D
20	3560.01~3690.00	0.1774	18M2G7D	0.1406	18M2W7D
40	3570.00~3679.98	0.1968	37M8G7D	0.1581	37M8W7D

Note: All modulations have been evaluation, only the worst test results of PSK & QAM are shown in the report.

1.5 Testing Site

Sporton International Inc. (Shenzhen) is accredited to ISO/IEC 17025:2017 by American Association for Laboratory Accreditation with Certificate Number 5145.01.

Test Firm	Sporton International Inc. (Shenzhen)		
Test Site Location	1/F, 2/F, Bldg 5, Shiling Industrial Zone, Xinwei Village, Xili, Nanshan, Shenzhen, 518055 People’s Republic of China TEL: +86-755-86379589 FAX: +86-755-86379595		
Test Site No.	Sporton Site No.	FCC Designation No.	FCC Test Firm Registration No.
	TH01-SZ	CN1256	421272

Test Firm	Sporton International Inc. (Shenzhen)		
Test Site Location	101, 1st Floor, Block B, Building 1, No. 2, Tengfeng 4th Road, Fenghuang Community, Fuyong Street, Baoan District, Shenzhen City Guangdong Province China 518103 TEL: +86-755-33202398		
Test Site No.	Sporton Site No.	FCC Designation No.	FCC Test Firm Registration No.
	03CH02-SZ	CN1256	421272

1.6 Test Software

Item	Site	Manufacturer	Name	Version
1.	03CH02-SZ	AUDIX	E3	6.2009-8-24a



1.7 Applied Standards

According to the specifications of the manufacturer, the EUT must comply with the requirements of the following standards:

- ♦ ANSI C63.26-2015
- ♦ ANSI / TIA-603-E
- ♦ 47 CFR Part 2, 96
- ♦ FCC KDB 971168 D01 Power Meas. License Digital Systems v03r01
- ♦ FCC KDB 940660 D01 Part 96 CBRS v03
- ♦ FCC KDB 412172 D01 Determining ERP and EIRP v01r01

Remark: All test items were verified and recorded according to the standards and without any deviation during the test.



2 Test Configuration of Equipment Under Test

2.1 Test Mode

Antenna port conducted and radiated test items listed below are performed according to KDB 971168 D01 Power Meas. License Digital Systems v03r01 with maximum output power.

For radiated measurement, pre-scanned in three orthogonal panels, X, Y, Z. The worst cases (Y plane) were recorded in this report.

Test Items	Band	Bandwidth (MHz)						Modulation					RB #		Test Channel			
		5	10	15	20	30	40	PI/2 BPSK	QPSK	16QAM	64QAM	256 QAM	1	Full	L	M	H	
Max. Output Power	n48	-	v	-	v	-	v	v	v	v	v	v	v	v	v	v	v	v
26dB and 99% Bandwidth	n48	-	v	-	v	-	v	v	v	v	v	v		v			v	
Adjacent Channel Leakage Ratio	n48	-	v	-	v	-	v	v	v				v	v	v	v	v	
Conducted Band Edge	n48	-	v	-	v	-	v	v	v				v	v	v			v
Conducted Spurious Emission	n48	-	v	-	v	-	v	v	v				v	v	v	v	v	v
Frequency Stability	n48	-		-	v	-			v					v			v	
Radiated Spurious Emission	n48	Worst Case															v	
Remark	<ol style="list-style-type: none"> The mark "v" means that this configuration is chosen for testing The mark "-" means that this bandwidth is not supported. The device is investigated from 30MHz to 10 times of fundamental signal for radiated spurious emission test under different RB size/offset and modulations in exploratory test. Subsequently, only the worst case emissions are reported. All test items are based on engineering evaluation. The RSE was pre-scanned L/M/H channels and the worst cases are middle channel which are reported only in this report. Frequency Stability: Normal Voltage =3.3 V.; Low Voltage =3.135 V.; High Voltage =4.4 V. 																	

2.2 Connection Diagram of Test System

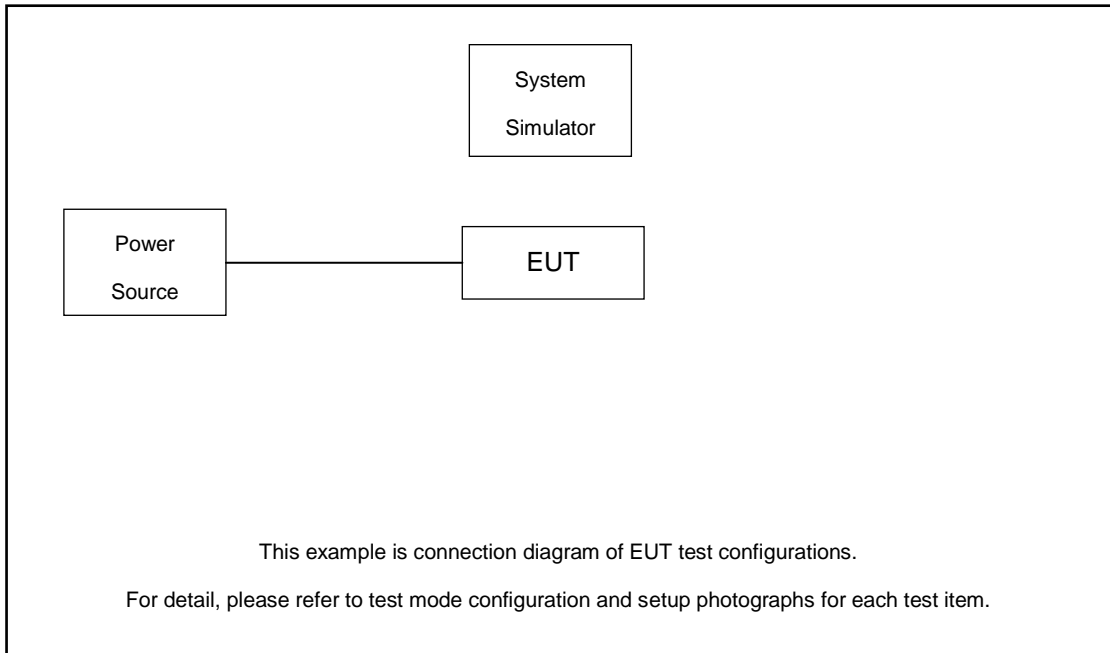

2.3 Support Unit used in test configuration

Item	Equipment	Trade Name	Model No.	FCC ID	Data Cable	Power Cord
1.	Power Supply	GWINSTEK	PSS-2002	N/A	N/A	Unshielded, 1.8 m
2.	LTE Base Station	Anritsu	MT8821C	N/A	N/A	Unshielded, 1.8 m
3.	NR Base Station	Anritsu	MT8000A	N/A	N/A	Unshielded, 1.8 m
4.	WWAN Antenna	N/A	N/A	N/A	N/A	N/A

2.4 Measurement Results Explanation Example

For all conducted test items:

The offset level is set in the spectrum analyzer to compensate the RF cable loss and attenuator factor between EUT conducted output port and spectrum analyzer. With the offset compensation, the spectrum analyzer reading level is exactly the EUT RF output level.

The spectrum analyzer offset is derived from RF cable loss and attenuator factor.

Offset = RF cable loss + attenuator factor.

Following shows an offset computation example with cable loss 5.58 dB and 10dB attenuator.

Example :

$$\begin{aligned} \text{Offset(dB)} &= \text{RF cable loss(dB)} + \text{attenuator factor(dB)} \\ &= 5.58 + 10 = 15.58 \text{ (dB)} \end{aligned}$$



2.5 Frequency List of Low/Middle/High Channels

5G NR n48 Channel and Frequency List				
BW [MHz]	Channel/Frequency(MHz)	Lowest	Middle	Highest
40	Channel	638000	641666	645332
	Frequency	3570	3624.99	3679.98
20	Channel	637334	641666	646000
	Frequency	3560.01	3624.99	3690
10	Channel	637000	641666	646332
	Frequency	3555	3624.99	3694.98

3 Conducted Test Items

3.1 Measuring Instruments

See list of measuring instruments of this test report.

3.1.1 Test Setup

3.1.2 Conducted Output Power



3.1.3 Occupied Bandwidth, Conducted Band-Edge and Conducted Spurious Emission

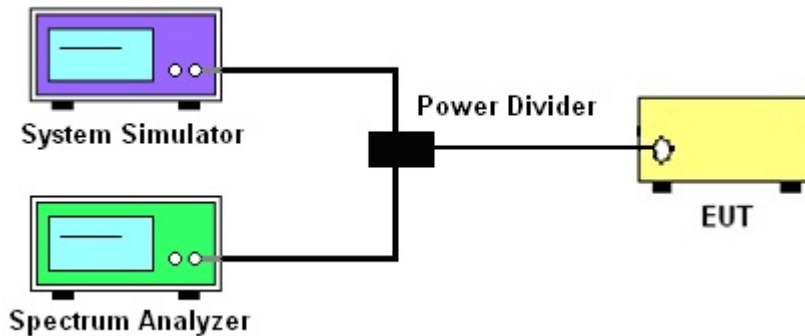

3.1.4 Frequency Stability

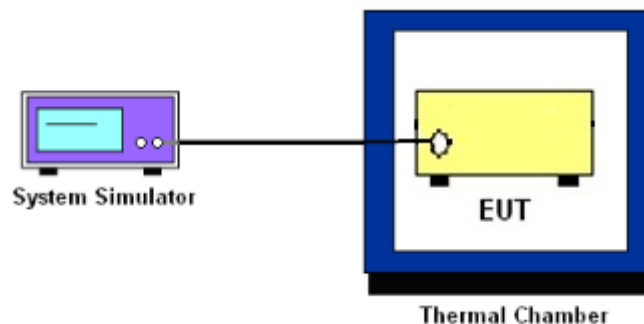

3.1.5 Test Result of Conducted Test

Please refer to Appendix A.



3.2 Conducted Output Power

3.2.1 Description of the Conducted Output Power Measurement

A system simulator was used to establish communication with the EUT. Its parameters were set to force the EUT transmitting at maximum output power. The measured power in the radio frequency on the transmitter output terminals shall be reported.

3.2.2 Test Procedures

1. The transmitter output port was connected to the system simulator.
2. Set EUT at maximum power through the system simulator.
3. Select lowest, middle, and highest channels for each band and different modulation.
4. Measure and record the power level from the system simulator.



3.3 Occupied Bandwidth

3.3.1 Description of Occupied Bandwidth Measurement

The occupied bandwidth is the width of a frequency band such that, below the lower and above the upper frequency limits, the mean powers emitted are each equal to a specified percentage 0.5% of the total mean transmitted power.

The 26 dB emission bandwidth is defined as the frequency range between two points, one above and one below the carrier frequency, at which the spectral density of the emission is attenuated 26 dB below the maximum in-band spectral density of the modulated signal. Spectral density (power per unit bandwidth) is to be measured with a detector of resolution bandwidth equal to approximately 1.0% of the emission bandwidth.

3.3.2 Test Procedures

The testing follows ANSI C63.26-2015 Section 5.4.3 (26dB) and Section 5.4.4 (99OB)

1. The EUT was connected to spectrum analyzer and system simulator via a power divider.
2. The spectrum analyzer center frequency is set to the nominal EUT channel center frequency. The span range for the spectrum analyzer shall be between two and five times the anticipated OBW.
3. The nominal resolution bandwidth (RBW) shall be in the range of 1 to 5 % of the anticipated OBW, and the VBW shall be at least 3 times the RBW.
4. Set the detection mode to peak, and the trace mode to max hold.
5. Determine the reference value: Set the EUT to transmit a modulated signal. Allow the trace to stabilize. Set the spectrum analyzer marker to the highest level of the displayed trace.
(this is the reference value)
6. Determine the “-26 dB down amplitude” as equal to (Reference Value – X).
7. Place two markers, one at the lowest and the other at the highest frequency of the envelope of the spectral display such that each marker is at or slightly below the “-X dB down amplitude” determined in step 6. If a marker is below this “-X dB down amplitude” value it shall be placed as close as possible to this value. The OBW is the positive frequency difference between the two markers.
8. Use the 99 % power bandwidth function of the spectrum analyzer and report the measured bandwidth.

3.4 Conducted Band Edge

3.4.1 Description of Conducted Band Edge Measurement

Part 96.41 (e) (1) (i)

For CBSD the emission limits outside the fundamental are as follows:

Within 0 MHz to 10 MHz above and below the assigned channel ≤ -13 dBm/MHz

Greater than 10 MHz above and below the assigned channel ≤ -25 dBm/MHz

Part 96.41 (e) (1) (ii)

For End User Devices the emission limits outside the fundamental are as follows:

Within 0 MHz to B MHz above and below the assigned channel ≤ -13 dBm/MHz

Greater than B MHz above and below the assigned channel ≤ -25 dBm/MHz

where B is the bandwidth in megahertz of the assigned channel or multiple contiguous channels of the End User Device.

Notwithstanding the emission limits in this paragraph, the Adjacent Channel Leakage Ratio for End User Devices shall be at least 30 dB.

Part 96.41 (e) (2)

For CBSDs and End User Devices, the conducted power of emissions below 3540 MHz or above 3710 MHz shall not exceed -25 dBm/MHz, and the conducted power of emissions below 3530 MHz or above 3720 MHz shall not exceed -40 dBm/MHz

3.4.2 Test Procedures

The testing follows FCC KDB 971168 D01 v03r01 Section 6.1.

1. The EUT was connected to spectrum analyzer and system simulator via a power divider.
2. The band edges of low and high channels for the highest RF powers were measured.
3. Set RBW $\geq 1\%$ EBW in the 1MHz band immediately outside and adjacent to the band edge.
4. Beyond the 1 MHz band from the band edge, RBW=1MHz was used
5. Offset has included the duty factor for Band n48. Duty factor $=10 \log (1/x)$, where x is the measured duty cycle.
6. Set spectrum analyzer with RMS detector.
7. The RF fundamental frequency should be excluded against the limit line in the operating frequency band.
8. When using the integration method, the starting frequency of the integration shall be centered at one-half of the RBW away from the band edge.



3.5 Conducted Spurious Emission

3.5.1 Description of Conducted Spurious Emission Measurement

96.41 (e)(2)

The conducted power of any emissions below 3530 MHz or above 3720 MHz shall not exceed -40dBm/MHz.

3.5.2 Test Procedures

The testing follows FCC KDB 971168 D01 v03r01 Section 6.1.

1. The EUT was connected to spectrum analyzer and system simulator via a power divider.
2. The RF output of EUT was connected to the spectrum analyzer by RF cable and attenuator. The path loss was compensated to the results for each measurement.
3. The middle channel for the highest RF power within the transmitting frequency was measured.
4. The conducted spurious emission for the whole frequency range was taken.
5. Make the measurement with the spectrum analyzer's RBW = 1MHz, VBW = 3MHz.
6. Set spectrum analyzer with RMS detector.
7. Taking the record of maximum spurious emission.
8. The RF fundamental frequency should be excluded against the limit line in the operating frequency band.
9. The limit line is -40dBm/MHz.



3.6 Frequency Stability

3.6.1 Description of Frequency Stability Measurement

The frequency stability shall be measured by variation of ambient temperature and variation of primary supply voltage to ensure that the fundamental emission stays within the authorized frequency block.

3.6.2 Test Procedures for Temperature Variation

The testing follows FCC KDB 971168 D01 v03r01 Section 9.0.

1. The EUT was set up in the thermal chamber and connected with the system simulator.
2. With power OFF, the temperature was decreased to -30°C and the EUT was stabilized before testing. Power was applied and the maximum change in frequency was recorded within one minute.
3. With power OFF, the temperature was raised in 10°C step up to 50°C . The EUT was stabilized at each step for at least half an hour. Power was applied and the maximum frequency change was recorded within one minute.

3.6.3 Test Procedures for Voltage Variation

The testing follows FCC KDB 971168 D01 v03r01 Section 9.0.

1. The EUT was placed in a temperature chamber at $25\pm 5^{\circ}\text{C}$ and connected with the system simulator.
2. The power supply voltage to the EUT was varied from 85% to 115% of the nominal value measured at the input to the EUT.
3. The variation in frequency was measured for the worst case.

4 Radiated Test Items

4.1 Measuring Instruments

See list of measuring instruments of this test report.

4.2 Test Setup

4.2.1 For radiated test below 30MHz

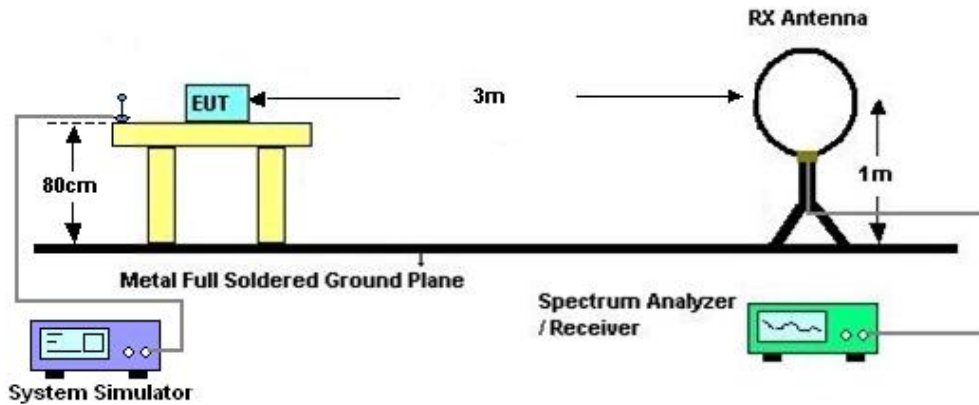

4.2.2 For radiated test from 30MHz to 1GHz

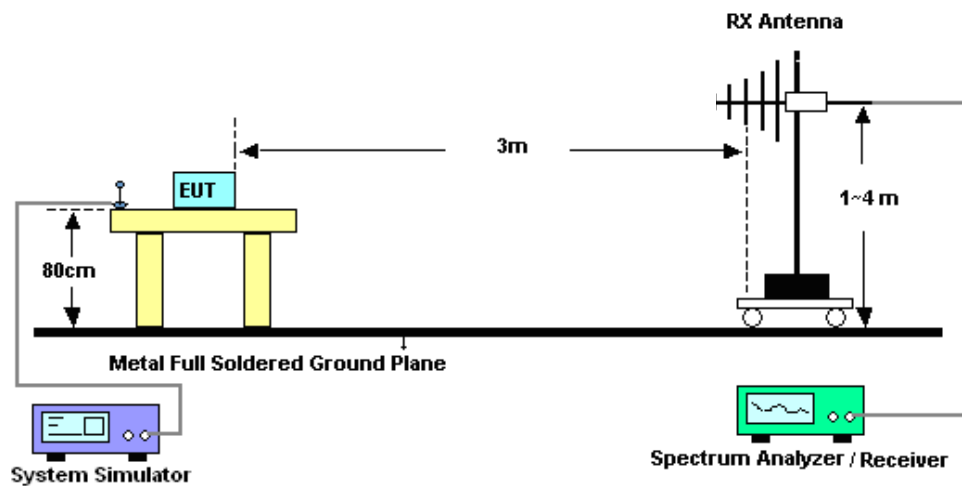

4.2.3 For radiated test above 1GHz

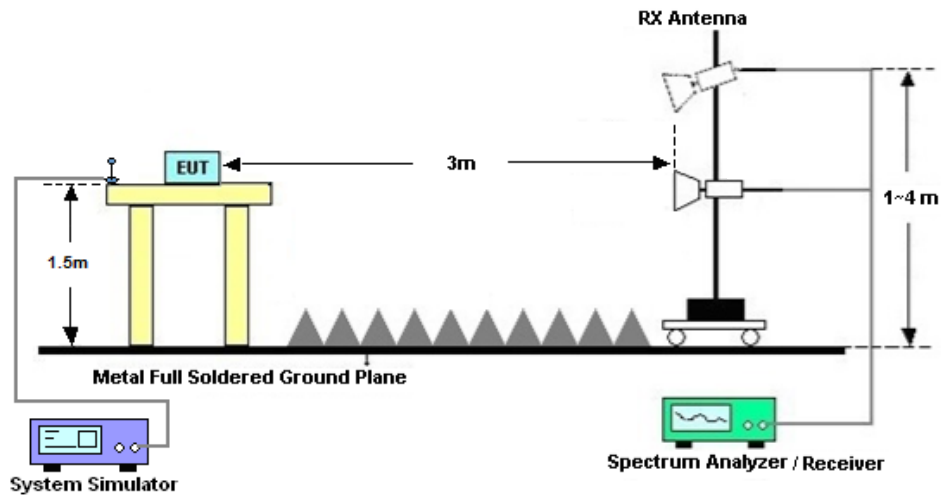

4.3 Test Result of Radiated Test

The low frequency, which started from 9 kHz to 30MHz, was pre-scanned and the result which was 20dB lower than the limit line was not reported.

Please refer to Appendix B.

4.4 Radiated Spurious Emission

4.4.1 Description of Radiated Spurious Emission Measurement

The radiated spurious emission was measured by substitution method according to ANSI / TIA-603-E. The power of any emission outside of the authorized operating frequency ranges must be attenuated below the transmitter power (P) by a factor of at least -40dBm / MHz.

The spectrum is scanned from 30 MHz up to a frequency including its 10th harmonic.

4.4.2 Test Procedures

1. The EUT was placed on a turntable with 0.8 meter height for frequency below 1GHz and 1.5 meter height for frequency above 1GHz respectively above ground.
2. The EUT was set 3 meters from the receiving antenna mounted on the antenna tower.
3. The table was rotated 360 degrees to determine the position of the highest spurious emission.
4. The height of the receiving antenna is varied between 1m to 4m to search the maximum spurious emission for both horizontal and vertical polarizations.
5. During the measurement, the system simulator parameters were set to force the EUT transmitting at maximum output power.
6. Make the measurement with the spectrum analyzer's RBW = 1MHz, VBW = 3MHz, taking the record of maximum spurious emission.
7. A horn antenna was substituted in place of the EUT and was driven by a signal generator. Tune the output power of signal generator to the same emission level with EUT maximum spurious emission.
EIRP (dBm) = S.G. Power – Tx Cable Loss + Tx Antenna Gain
ERP (dBm) = EIRP - 2.15
8. The RF fundamental frequency should be excluded against the limit line in the operating frequency band.

The limit line is -40dBm/MHz



5 List of Measuring Equipment

Instrument	Manufacturer	Model No.	Serial No.	Characteristics	Calibration Date	Test Date	Due Date	Remark
EXA Spectrum Analyzer	KEYSIGHT	N9010A	MY55150213	10Hz~44GHz	Jul. 08, 2021	Feb. 08, 2022~ Aug. 01, 2022	Jul. 07, 2022	Conducted (TH01-SZ)
EXA Spectrum Analyzer	KEYSIGHT	N9010A	MY55150213	10Hz~44GHz	Jul. 07, 2022		Jul. 06, 2023	Conducted (TH01-SZ)
Power Divider	TOJOIN	PS-2SM-04265	60.06.020.0077	0.4GHz~26.5GHz	Dec. 25, 2021	Feb. 08, 2022~ Aug. 01, 2022	Dec. 24, 2022	Conducted (TH01-SZ)
Thermal Chamber	Ten Billion Hongzhangroup	LP-150U	H2014081803	-40~+150°C	Jul. 14, 2021	Feb. 08, 2022~ Aug. 01, 2022	Jul. 13, 2022	Conducted (TH01-SZ)
Thermal Chamber	Ten Billion Hongzhangroup	LP-150U	H2014081803	-40~+150°C	Jul. 13, 2022		Jul. 12, 2023	Conducted (TH01-SZ)
EXA Spectrum Analyzer	KEYSIGHT	N9010A	MY55150213	10Hz~44GHz	Jul. 07, 2022	Jul. 14, 2022	Jul. 06, 2023	Radiation (03CH02-SZ)
Loop Antenna	R&S	HFH2-Z2	100354	9kHz~30MHz	Jun. 21, 2022	Jul. 14, 2022	Jun. 20, 2023	Radiation (03CH02-SZ)
Bilog Antenna	TeseQ	CBL6112D	49922	30MHz-2GHz	Oct. 22, 2021	Jul. 14, 2022	Oct. 21, 2022	Radiation (03CH02-SZ)
Double Ridge Horn Antenna	ETS-Lindgren	3117	00119436	1GHz~18GHz	Jul. 07, 2022	Jul. 14, 2022	Jul. 06, 2023	Radiation (03CH02-SZ)
HF Amplifier	MITEQ	TTA1840-35-HG	1871923	18GHz~40GHz	Jul. 06, 2022	Jul. 14, 2022	Jul. 05, 2023	Radiation (03CH02-SZ)
SHF-EHF Horn	com-power	AH-840	101071	18Ghz-40GHz	Apr. 11, 2022	Jul. 14, 2022	Apr. 10, 2023	Radiation (03CH02-SZ)
LF Amplifier	Burgeon	BPA-530	102211	0.01~3000Mhz	Oct. 22, 2021	Jul. 14, 2022	Oct. 21, 2022	Radiation (03CH02-SZ)
HF Amplifier	KEYSIGHT	83017A	MY53270105	0.5GHz~26.5GHz	Oct. 22, 2021	Jul. 14, 2022	Oct. 21, 2022	Radiation (03CH02-SZ)
AC Power Source	Chroma	61601	616010002470	N/A	NCR	Jul. 14, 2022	NCR	Radiation (03CH02-SZ)
Turn Table	Chaintek	T-200	N/A	0~360 degree	NCR	Jul. 14, 2022	NCR	Radiation (03CH02-SZ)
Antenna Mast	Chaintek	MBS-400	N/A	1 m~4 m	NCR	Jul. 14, 2022	NCR	Radiation (03CH02-SZ)

NCR: No Calibration Required



6 Uncertainty of Evaluation

Uncertainty of Conducted Measurement

Test Item	Uncertainty
Conducted Power	±1.34 dB
Conducted Emissions	±1.34 dB
Occupied Channel Bandwidth	±0.13 %

Uncertainty of Radiated Emission Measurement (30 MHz ~ 1000 MHz)

Measuring Uncertainty for a Level of Confidence of 95% (U = 2Uc(y))	2.47dB
---	--------

Uncertainty of Radiated Emission Measurement (1 GHz ~ 18 GHz)

Measuring Uncertainty for a Level of Confidence of 95% (U = 2Uc(y))	3.31dB
---	--------

Uncertainty of Radiated Emission Measurement (18 GHz ~ 40 GHz)

Measuring Uncertainty for a Level of Confidence of 95% (U = 2Uc(y))	3.72dB
---	--------

----- THE END -----



Appendix A. Test Results of Conducted Test

Test Engineer :	Jung Guo	Temperature :	22~23°C
		Relative Humidity :	40~42%



Software Version: 22.02.012801

FR1 N48

LTE Band: 13, LTE BW: 10M, LTE ARFCN: Low

Conducted Output Power

NR Band	SCS (kHz)	Bandwidth (MHz)	Arfcn	Freq (MHz)	Modulation	RB	Conducted Power(dBm)
48	30	10	637000	3555	DFT-s-OFDM QPSK	1@1	22.2
48	30	10	637000	3555	DFT-s-OFDM 16 QAM	1@1	21.14
48	30	10	641666	3624.99	DFT-s-OFDM QPSK	1@1	22.47
48	30	10	641666	3624.99	DFT-s-OFDM 16 QAM	1@1	21.47
48	30	10	646332	3694.98	DFT-s-OFDM QPSK	1@1	22.13
48	30	10	646332	3694.98	DFT-s-OFDM 16 QAM	1@1	21.09
48	30	20	637334	3560.01	DFT-s-OFDM QPSK	1@1	22.33
48	30	20	637334	3560.01	DFT-s-OFDM 16 QAM	1@1	21.38
48	30	20	641666	3624.99	DFT-s-OFDM QPSK	1@1	22.49
48	30	20	641666	3624.99	DFT-s-OFDM 16 QAM	1@1	21.48
48	30	20	646000	3690	DFT-s-OFDM QPSK	1@1	22.29
48	30	20	646000	3690	DFT-s-OFDM 16 QAM	1@1	21.19
48	30	40	638000	3570	DFT-s-OFDM PI/2 BPSK	50@25	22.66
48	30	40	638000	3570	DFT-s-OFDM PI/2 BPSK	1@1	22.72
48	30	40	638000	3570	DFT-s-OFDM PI/2 BPSK	1@104	22.72
48	30	40	638000	3570	DFT-s-OFDM QPSK	50@25	22.6
48	30	40	638000	3570	DFT-s-OFDM QPSK	1@1	22.71
48	30	40	638000	3570	DFT-s-OFDM QPSK	1@104	22.7
48	30	40	638000	3570	DFT-s-OFDM 16 QAM	50@25	21.63
48	30	40	638000	3570	DFT-s-OFDM 16 QAM	1@1	21.71
48	30	40	638000	3570	DFT-s-OFDM 16 QAM	1@104	21.74
48	30	40	638000	3570	DFT-s-OFDM 64 QAM	50@25	20.14
48	30	40	638000	3570	DFT-s-OFDM 64 QAM	1@1	20.23
48	30	40	638000	3570	DFT-s-OFDM 64 QAM	1@104	20.29



48	30	40	638000	3570	DFT-s-OFDM 256 QAM	50@25	18.13
48	30	40	638000	3570	DFT-s-OFDM 256 QAM	1@1	18.16
48	30	40	638000	3570	DFT-s-OFDM 256 QAM	1@104	18.16
48	30	40	638000	3570	CP-OFDM QPSK	53@26	21.13
48	30	40	638000	3570	CP-OFDM QPSK	1@1	21.24
48	30	40	638000	3570	CP-OFDM QPSK	1@104	21.28
48	30	40	641666	3624.99	DFT-s-OFDM PI/2 BPSK	50@25	22.81
48	30	40	641666	3624.99	DFT-s-OFDM PI/2 BPSK	1@1	22.94
48	30	40	641666	3624.99	DFT-s-OFDM PI/2 BPSK	1@104	22.88
48	30	40	641666	3624.99	DFT-s-OFDM QPSK	50@25	22.86
48	30	40	641666	3624.99	DFT-s-OFDM QPSK	1@1	22.9
48	30	40	641666	3624.99	DFT-s-OFDM QPSK	1@104	22.76
48	30	40	641666	3624.99	DFT-s-OFDM 16 QAM	50@25	21.86
48	30	40	641666	3624.99	DFT-s-OFDM 16 QAM	1@1	21.99
48	30	40	641666	3624.99	DFT-s-OFDM 16 QAM	1@104	21.94
48	30	40	641666	3624.99	DFT-s-OFDM 64 QAM	50@25	20.37
48	30	40	641666	3624.99	DFT-s-OFDM 64 QAM	1@1	20.46
48	30	40	641666	3624.99	DFT-s-OFDM 64 QAM	1@104	20.21
48	30	40	641666	3624.99	DFT-s-OFDM 256 QAM	50@25	18.36
48	30	40	641666	3624.99	DFT-s-OFDM 256 QAM	1@1	18.4
48	30	40	641666	3624.99	DFT-s-OFDM 256 QAM	1@104	18.4
48	30	40	641666	3624.99	CP-OFDM QPSK	53@26	21.32
48	30	40	641666	3624.99	CP-OFDM QPSK	1@1	21.44
48	30	40	641666	3624.99	CP-OFDM QPSK	1@104	21.39
48	30	40	645332	3679.98	DFT-s-OFDM PI/2 BPSK	50@25	22.55
48	30	40	645332	3679.98	DFT-s-OFDM PI/2 BPSK	1@1	22.85
48	30	40	645332	3679.98	DFT-s-OFDM PI/2 BPSK	1@104	22.51
48	30	40	645332	3679.98	DFT-s-OFDM QPSK	50@25	22.56
48	30	40	645332	3679.98	DFT-s-OFDM QPSK	1@1	22.85
48	30	40	645332	3679.98	DFT-s-OFDM QPSK	1@104	22.5
48	30	40	645332	3679.98	DFT-s-OFDM 16 QAM	50@25	21.57
48	30	40	645332	3679.98	DFT-s-OFDM	1@1	21.89



					16 QAM		
48	30	40	645332	3679.98	DFT-s-OFDM 16 QAM	1@104	21.61
48	30	40	645332	3679.98	DFT-s-OFDM 64 QAM	50@25	20.06
48	30	40	645332	3679.98	DFT-s-OFDM 64 QAM	1@1	20.31
48	30	40	645332	3679.98	DFT-s-OFDM 64 QAM	1@104	19.99
48	30	40	645332	3679.98	DFT-s-OFDM 256 QAM	50@25	18.04
48	30	40	645332	3679.98	DFT-s-OFDM 256 QAM	1@1	18.37
48	30	40	645332	3679.98	DFT-s-OFDM 256 QAM	1@104	18.05
48	30	40	645332	3679.98	CP-OFDM QPSK	53@26	21.04
48	30	40	645332	3679.98	CP-OFDM QPSK	1@1	21.43
48	30	40	645332	3679.98	CP-OFDM QPSK	1@104	21.07



Frequency Stability

NR Band	SCS (kHz)	Bandwidth (MHz)	Arfcn	Freq (MHz)	Modulation	RB	Deviation (ppm)	Verdict	Environment
48	30	20	641666	3624.99	DFT-s-OFDM QPSK	50@0	0.0026	PASS	NV
48	30	20	641666	3624.99	DFT-s-OFDM QPSK	50@0	0.0068	PASS	LV
48	30	20	641666	3624.99	DFT-s-OFDM QPSK	50@0	0.0057	PASS	HV
48	30	20	641666	3624.99	DFT-s-OFDM QPSK	50@0	0.0040	PASS	-30°C
48	30	20	641666	3624.99	DFT-s-OFDM QPSK	50@0	0.0037	PASS	-20°C
48	30	20	641666	3624.99	DFT-s-OFDM QPSK	50@0	0.0030	PASS	-10°C
48	30	20	641666	3624.99	DFT-s-OFDM QPSK	50@0	0.0060	PASS	0°C
48	30	20	641666	3624.99	DFT-s-OFDM QPSK	50@0	0.0037	PASS	10°C
48	30	20	641666	3624.99	DFT-s-OFDM QPSK	50@0	0.0026	PASS	20°C
48	30	20	641666	3624.99	DFT-s-OFDM QPSK	50@0	0.0044	PASS	30°C
48	30	20	641666	3624.99	DFT-s-OFDM QPSK	50@0	0.0054	PASS	40°C
48	30	20	641666	3624.99	DFT-s-OFDM QPSK	50@0	0.0067	PASS	50°C



Occupied Bandwidth

NR Band	SCS (kHz)	Bandwidth (MHz)	Arfcn	Freq (MHz)	Modulation	RB	OBW (MHz)	26dB OBW (MHz)
48	30	10	641666	3624.99	DFT-s-OFDM PI/2 BPSK	24@0	8.5916	9.451
48	30	10	641666	3624.99	DFT-s-OFDM QPSK	24@0	8.5918	9.275
48	30	10	641666	3624.99	CP-OFDM QPSK	24@0	8.5892	9.666
48	30	10	641666	3624.99	CP-OFDM 16 QAM	24@0	8.5863	10.27
48	30	10	641666	3624.99	CP-OFDM 64 QAM	24@0	8.5924	9.591
48	30	10	641666	3624.99	CP-OFDM 256 QAM	24@0	8.5904	9.579
48	30	20	641666	3624.99	DFT-s-OFDM PI/2 BPSK	50@0	17.806	18.99
48	30	20	641666	3624.99	DFT-s-OFDM QPSK	50@0	17.859	18.99
48	30	20	641666	3624.99	CP-OFDM QPSK	51@0	18.195	19.38
48	30	20	641666	3624.99	CP-OFDM 16 QAM	51@0	18.227	19.39
48	30	20	641666	3624.99	CP-OFDM 64 QAM	51@0	18.21	19.56
48	30	20	641666	3624.99	CP-OFDM 256 QAM	51@0	18.206	19.45
48	30	40	641666	3624.99	DFT-s-OFDM PI/2 BPSK	100@0	35.719	37.22
48	30	40	641666	3624.99	DFT-s-OFDM QPSK	100@0	35.754	37.23
48	30	40	641666	3624.99	CP-OFDM QPSK	106@0	37.779	39.46
48	30	40	641666	3624.99	CP-OFDM 16 QAM	106@0	37.834	39.58
48	30	40	641666	3624.99	CP-OFDM 64 QAM	106@0	37.815	39.44
48	30	40	641666	3624.99	CP-OFDM 256 QAM	106@0	37.816	39.39



B13_N48(10M)_DFT-s-OFDM_PI_2-BPSK_Outer_Full_Mid_CH

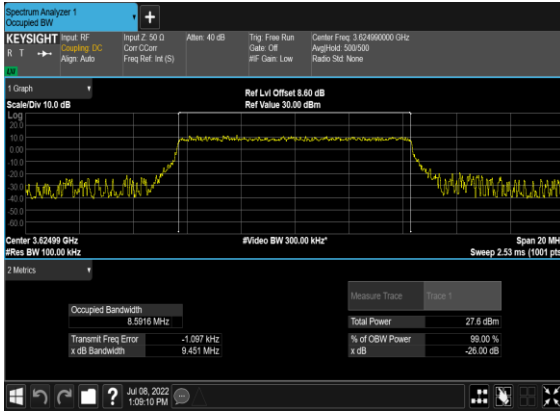

B13_N48(10M)_DFT-s-OFDM_QPSK_Outer_Full_Mid_CH

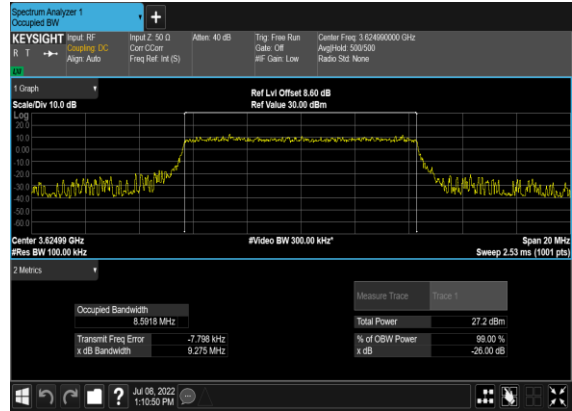

B13_N48(10M)_CP-OFDM_QPSK_Outer_Full_Mid_CH



B13_N48(10M)_CP-OFDM_16QAM_Outer_Full_Mid_CH



B13_N48(10M)_CP-OFDM_64QAM_Outer_Full_Mid_CH



B13_N48(10M)_CP-OFDM_256QAM_Outer_Full_Mid_CH





B13_N48(20M)_DFT-s-OFDM_PI_2-BPSK_Outer_Full_Mid_CH

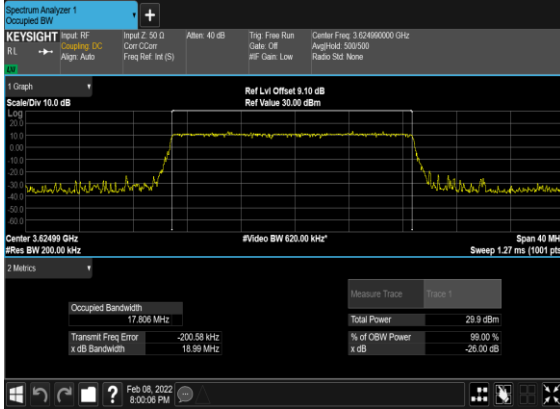

B13_N48(20M)_DFT-s-OFDM_QPSK_Outer_Full_Mid_CH



B13_N48(20M)_CP-OFDM_QPSK_Outer_Full_Mid_CH

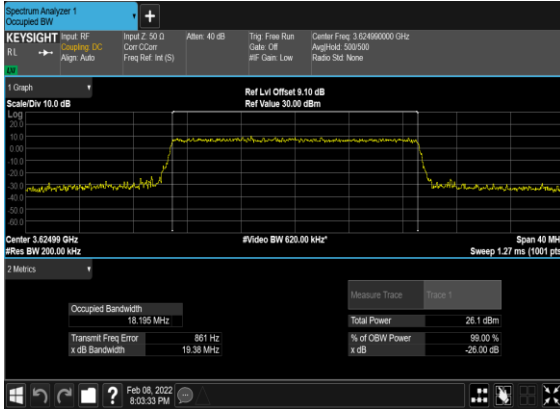

B13_N48(20M)_CP-OFDM_16QAM_Outer_Full_Mid_CH

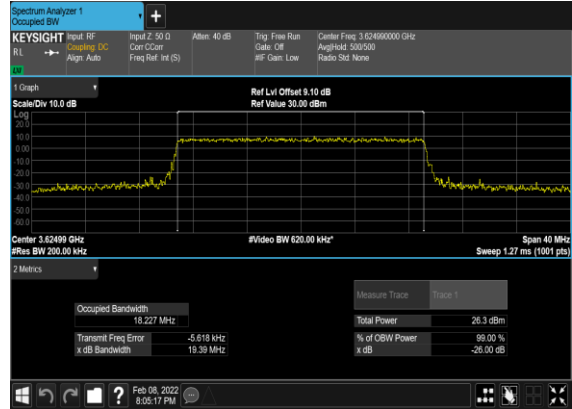

B13_N48(20M)_CP-OFDM_64QAM_Outer_Full_Mid_CH

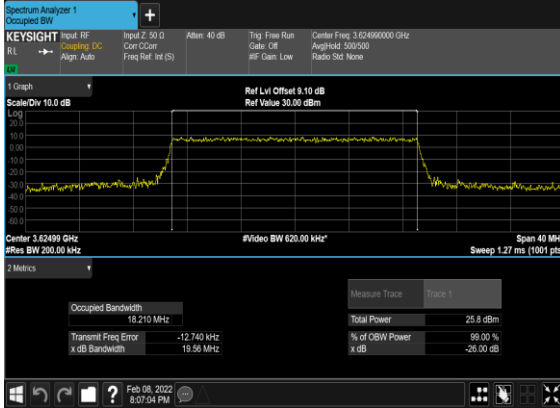

B13_N48(20M)_CP-OFDM_256QAM_Outer_Full_Mid_CH

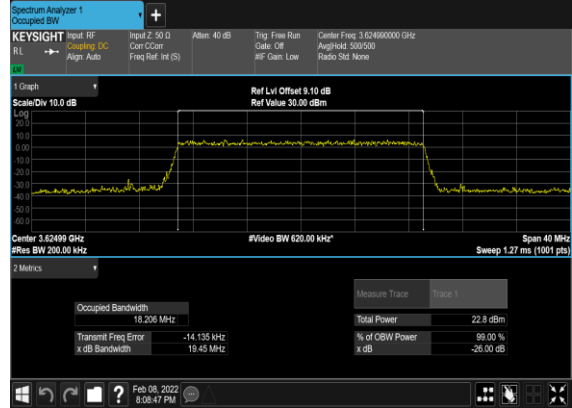



B13_N48(40M)_DFT-s-OFDM_PI_2-BPSK_Outer_Full_Mid_CH

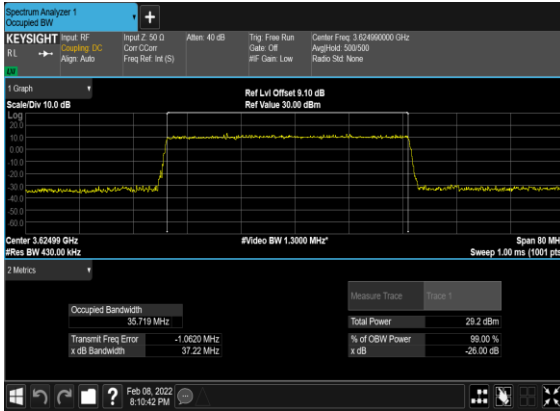

B13_N48(40M)_DFT-s-OFDM_QPSK_Outer_Full_Mid_CH

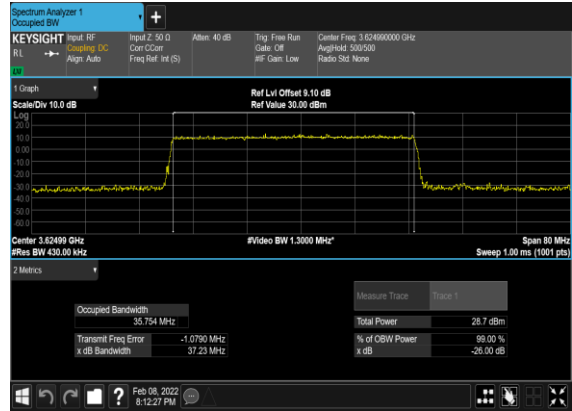

B13_N48(40M)_CP-OFDM_QPSK_Outer_Full_Mid_CH

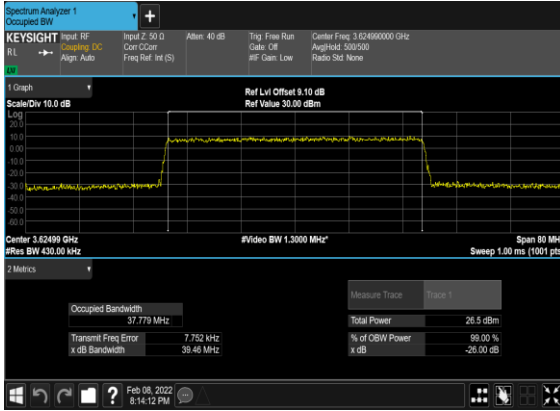

B13_N48(40M)_CP-OFDM_16QAM_Outer_Full_Mid_CH

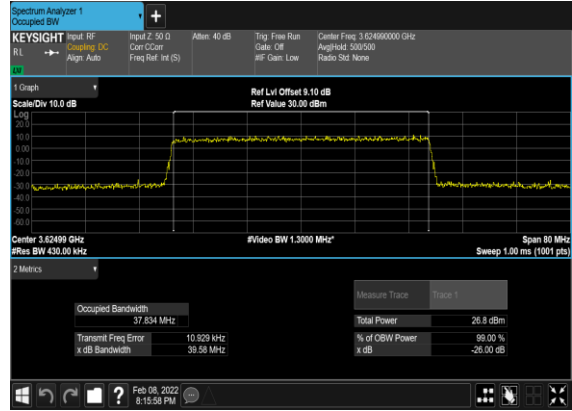

B13_N48(40M)_CP-OFDM_64QAM_Outer_Full_Mid_CH



B13_N48(40M)_CP-OFDM_256QAM_Outer_Full_Mid_CH

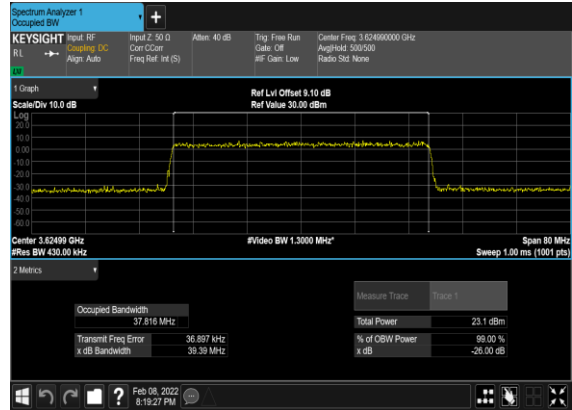



Adjacent Channel Leakage Ratio

NR Band	SCS (kHz)	Bandwidth (MHz)	Arfcn	Freq (MHz)	Modulation	RB	Lower Margin	Upper Margin	Result	Verdict
48	30	10	637000	3555.0	DFT-s-OFDM PI/2 BPSK	24@0	-16.54	-16.53	see graph	PASS
48	30	10	637000	3555.0	DFT-s-OFDM PI/2 BPSK	1@0	-8.52	-23.29	see graph	PASS
48	30	10	637000	3555.0	DFT-s-OFDM PI/2 BPSK	1@23	-23.39	-12.01	see graph	PASS
48	30	10	637000	3555.0	DFT-s-OFDM QPSK	24@0	-15.13	-14.92	see graph	PASS
48	30	10	637000	3555.0	DFT-s-OFDM QPSK	1@0	-10.04	-23.54	see graph	PASS
48	30	10	637000	3555.0	DFT-s-OFDM QPSK	1@23	-22.99	-10.79	see graph	PASS
48	30	10	641666	3624.99	DFT-s-OFDM PI/2 BPSK	24@0	-16.32	-15.45	see graph	PASS
48	30	10	641666	3624.99	DFT-s-OFDM PI/2 BPSK	1@0	-11.53	-23.56	see graph	PASS
48	30	10	641666	3624.99	DFT-s-OFDM PI/2 BPSK	1@23	-20.24	-11.36	see graph	PASS
48	30	10	641666	3624.99	DFT-s-OFDM QPSK	24@0	-14.87	-14.28	see graph	PASS
48	30	10	641666	3624.99	DFT-s-OFDM QPSK	1@0	-10.79	-21.37	see graph	PASS
48	30	10	641666	3624.99	DFT-s-OFDM QPSK	1@23	-23.97	-12.09	see graph	PASS
48	30	10	646332	3694.98	DFT-s-OFDM PI/2 BPSK	24@0	-15.97	-15.7	see graph	PASS
48	30	10	646332	3694.98	DFT-s-OFDM PI/2 BPSK	1@0	-7.86	-19.52	see graph	PASS
48	30	10	646332	3694.98	DFT-s-OFDM PI/2 BPSK	1@23	-20.44	-10.58	see graph	PASS
48	30	10	646332	3694.98	DFT-s-OFDM QPSK	24@0	-14.78	-14.34	see graph	PASS
48	30	10	646332	3694.98	DFT-s-OFDM QPSK	1@0	-10.0	-20.42	see graph	PASS
48	30	10	646332	3694.98	DFT-s-OFDM QPSK	1@23	-20.53	-10.48	see graph	PASS
48	30	20	637334	3560.01	DFT-s-OFDM PI/2 BPSK	50@0	-17.83	-17.87	see graph	PASS
48	30	20	637334	3560.01	DFT-s-OFDM PI/2 BPSK	1@0	-13.91	-24.52	see graph	PASS



48	30	20	637334	3560.01	DFT-s-OFDM PI/2 BPSK	1@50	-23.11	-12.47	see graph	PASS
48	30	20	637334	3560.01	DFT-s-OFDM QPSK	50@0	-16.11	-15.98	see graph	PASS
48	30	20	637334	3560.01	DFT-s-OFDM QPSK	1@0	-11.68	-23.6	see graph	PASS
48	30	20	637334	3560.01	DFT-s-OFDM QPSK	1@50	-21.75	-11.5	see graph	PASS
48	30	20	641666	3624.99	DFT-s-OFDM PI/2 BPSK	50@0	-16.73	-16.27	see graph	PASS
48	30	20	641666	3624.99	DFT-s-OFDM PI/2 BPSK	1@0	-11.35	-19.54	see graph	PASS
48	30	20	641666	3624.99	DFT-s-OFDM PI/2 BPSK	1@50	-19.85	-10.96	see graph	PASS
48	30	20	641666	3624.99	DFT-s-OFDM QPSK	50@0	-15.4	-15.04	see graph	PASS
48	30	20	641666	3624.99	DFT-s-OFDM QPSK	1@0	-10.96	-18.77	see graph	PASS
48	30	20	641666	3624.99	DFT-s-OFDM QPSK	1@50	-19.99	-12.34	see graph	PASS
48	30	20	646000	3690.0	DFT-s-OFDM PI/2 BPSK	50@0	-16.09	-15.36	see graph	PASS
48	30	20	646000	3690.0	DFT-s-OFDM PI/2 BPSK	1@0	-10.79	-19.13	see graph	PASS
48	30	20	646000	3690.0	DFT-s-OFDM PI/2 BPSK	1@50	-18.55	-11.63	see graph	PASS
48	30	20	646000	3690.0	DFT-s-OFDM QPSK	50@0	-14.88	-14.48	see graph	PASS
48	30	20	646000	3690.0	DFT-s-OFDM QPSK	1@0	-12.38	-18.94	see graph	PASS
48	30	20	646000	3690.0	DFT-s-OFDM QPSK	1@50	-18.28	-10.92	see graph	PASS
48	30	40	638000	3570.0	DFT-s-OFDM PI/2 BPSK	100@0	-16.12	-15.06	see graph	PASS
48	30	40	638000	3570.0	DFT-s-OFDM PI/2 BPSK	1@0	-13.38	-17.31	see graph	PASS
48	30	40	638000	3570.0	DFT-s-OFDM PI/2 BPSK	1@105	-18.36	-14.57	see graph	PASS
48	30	40	638000	3570.0	DFT-s-OFDM QPSK	100@0	-14.41	-13.87	see graph	PASS
48	30	40	638000	3570.0	DFT-s-OFDM QPSK	1@0	-12.87	-16.8	see graph	PASS
48	30	40	638000	3570.0	DFT-s-OFDM QPSK	1@105	-17.49	-13.54	see graph	PASS



48	30	40	641666	3624.99	DFT-s-OFDM PI/2 BPSK	100@0	-15.99	-14.86	see graph	PASS
48	30	40	641666	3624.99	DFT-s-OFDM PI/2 BPSK	1@0	-14.29	-17.36	see graph	PASS
48	30	40	641666	3624.99	DFT-s-OFDM PI/2 BPSK	1@105	-17.54	-13.02	see graph	PASS
48	30	40	641666	3624.99	DFT-s-OFDM QPSK	100@0	-14.22	-13.55	see graph	PASS
48	30	40	641666	3624.99	DFT-s-OFDM QPSK	1@0	-13.58	-16.74	see graph	PASS
48	30	40	641666	3624.99	DFT-s-OFDM QPSK	1@105	-18.78	-15.1	see graph	PASS
48	30	40	645332	3679.98	DFT-s-OFDM PI/2 BPSK	100@0	-15.39	-13.72	see graph	PASS
48	30	40	645332	3679.98	DFT-s-OFDM PI/2 BPSK	1@0	-14.44	-16.6	see graph	PASS
48	30	40	645332	3679.98	DFT-s-OFDM PI/2 BPSK	1@105	-17.72	-13.58	see graph	PASS
48	30	40	645332	3679.98	DFT-s-OFDM QPSK	100@0	-13.77	-12.7	see graph	PASS
48	30	40	645332	3679.98	DFT-s-OFDM QPSK	1@0	-12.68	-15.81	see graph	PASS
48	30	40	645332	3679.98	DFT-s-OFDM QPSK	1@105	-16.32	-12.63	see graph	PASS



B13_N48(10M)_DFT-s-OFDM_PI_2-BPSK_Outer_Full_Low_CH



B13_N48(10M)_DFT-s-OFDM_PI_2-BPSK_Edge_1RB_Left_Low_CH

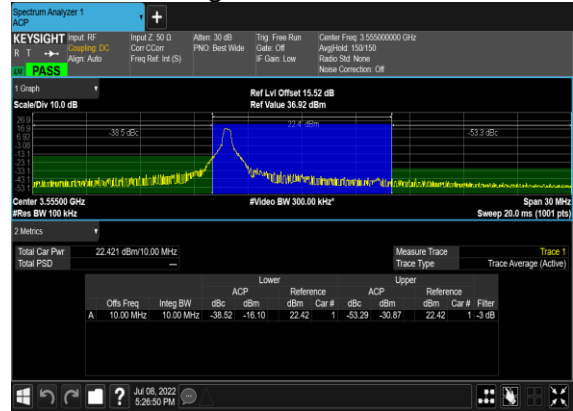

B13_N48(10M)_DFT-s-OFDM_PI_2-BPSK_Edge_1RB_Right_Low_CH

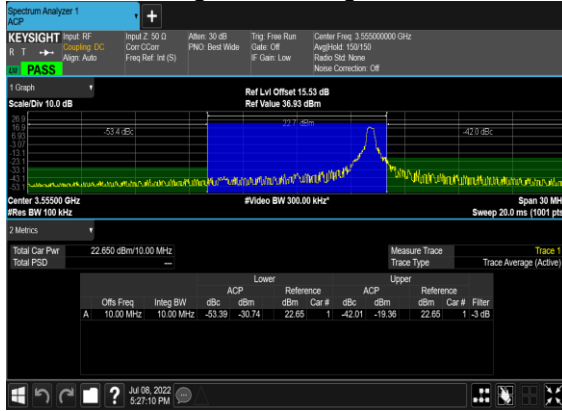

B13_N48(10M)_DFT-s-OFDM_QPSK_Outer_Full_Low_CH

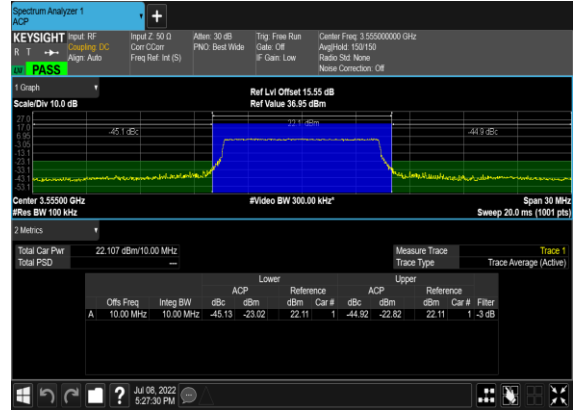

B13_N48(10M)_DFT-s-OFDM_QPSK_Edge_1RB_Left_Low_CH

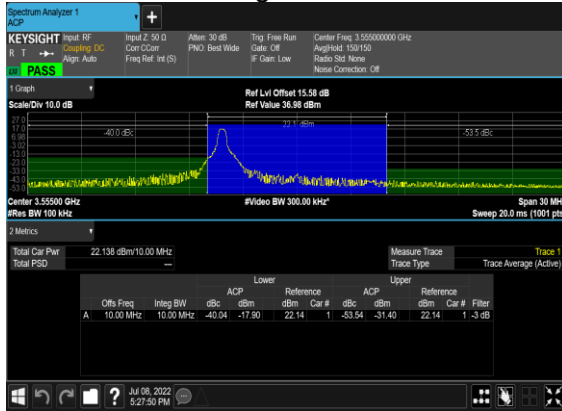

B13_N48(10M)_DFT-s-OFDM_QPSK_Edge_1RB_Right_Low_CH

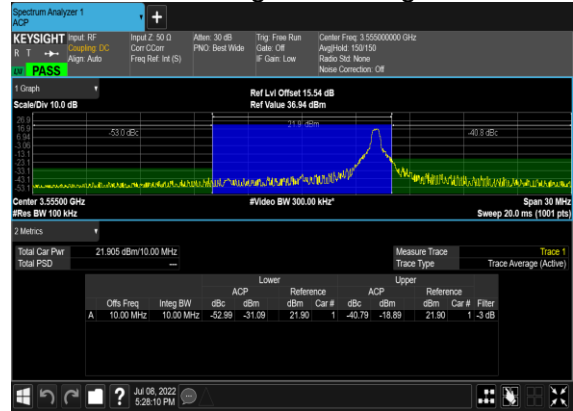



B13_N48(10M)_DFT-s-OFDM_PI_2-BPSK_Outer_Full_Mid_CH

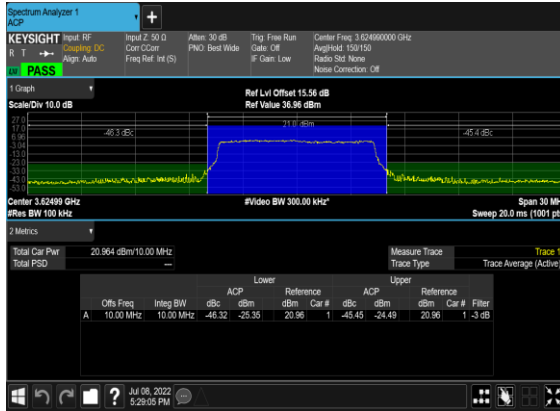

B13_N48(10M)_DFT-s-OFDM_PI_2-BPSK_Edge_1RB_Left_Mid_CH

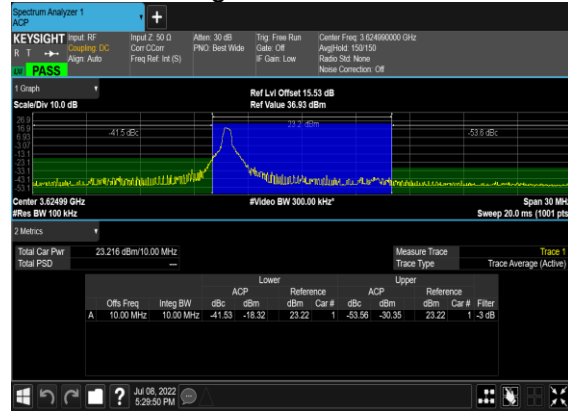

B13_N48(10M)_DFT-s-OFDM_PI_2-BPSK_Edge_1RB_Right_Mid_CH



B13_N48(10M)_DFT-s-OFDM_QPSK_Outer_Full_Mid_CH



B13_N48(10M)_DFT-s-OFDM_QPSK_Edge_1RB_Left_Mid_CH

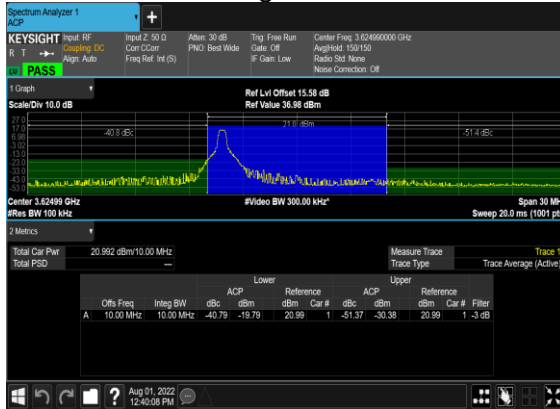

B13_N48(10M)_DFT-s-OFDM_QPSK_Edge_1RB_Right_Mid_CH

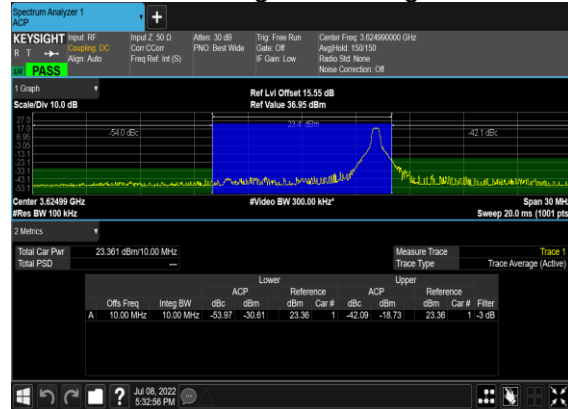



B13_N48(10M)_DFT-s-OFDM_PI_2-BPSK_Outer_Full_High_CH

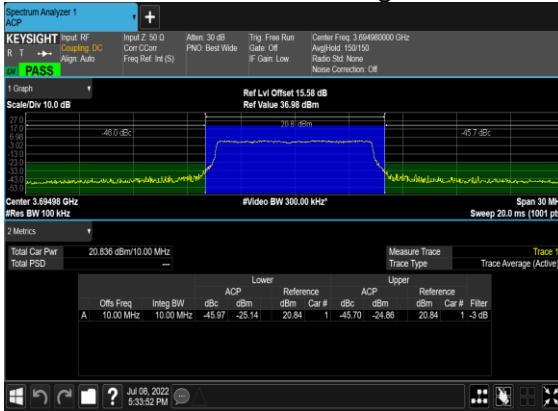

B13_N48(10M)_DFT-s-OFDM_PI_2-BPSK_Edge_1RB_Left_High_CH

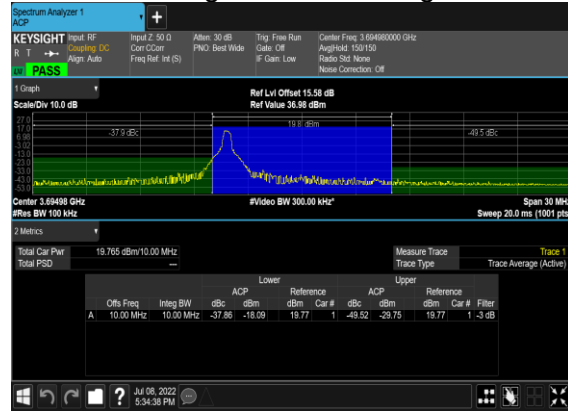

B13_N48(10M)_DFT-s-OFDM_PI_2-BPSK_Edge_1RB_Right_High_CH

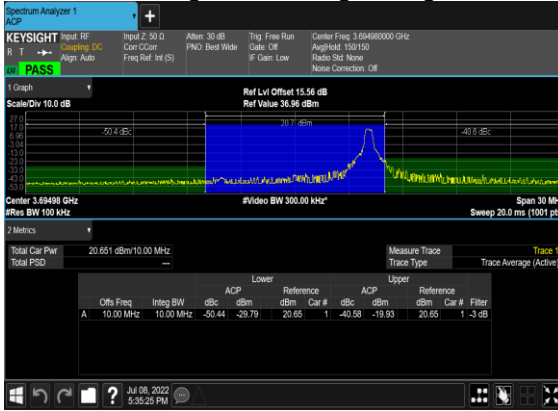

B13_N48(10M)_DFT-s-OFDM_QPSK_Outer_Full_High_CH

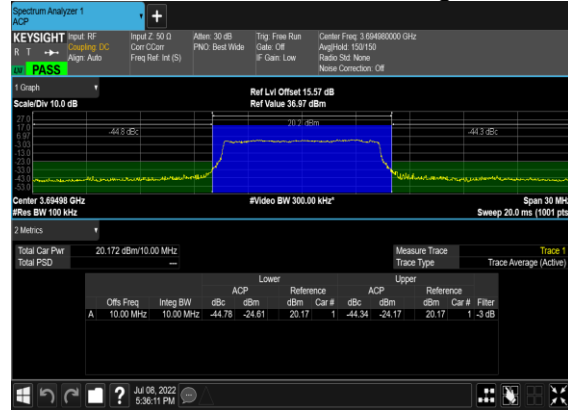

B13_N48(10M)_DFT-s-OFDM_QPSK_Edge_1RB_Left_High_CH

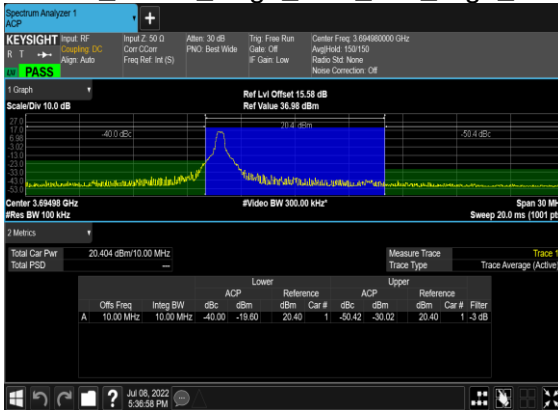

B13_N48(10M)_DFT-s-OFDM_QPSK_Edge_1RB_Right_High_CH

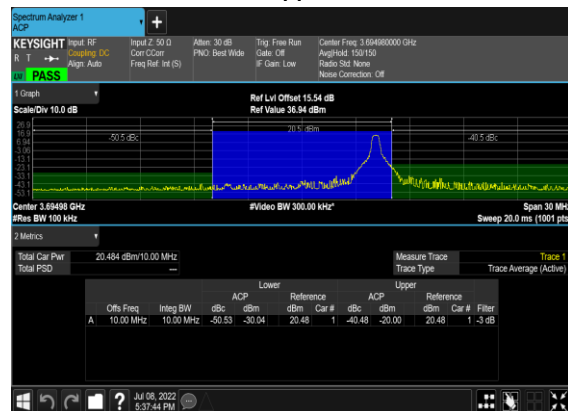



B13_N48(20M)_DFT-s-OFDM_PI_2-BPSK_Outer_Full_Low_CH

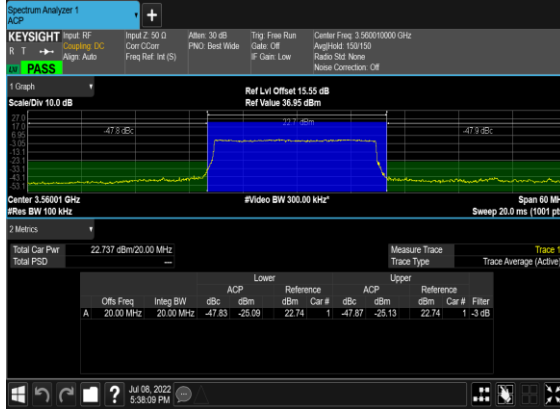

B13_N48(20M)_DFT-s-OFDM_PI_2-BPSK_Edge_1RB_Left_Low_CH

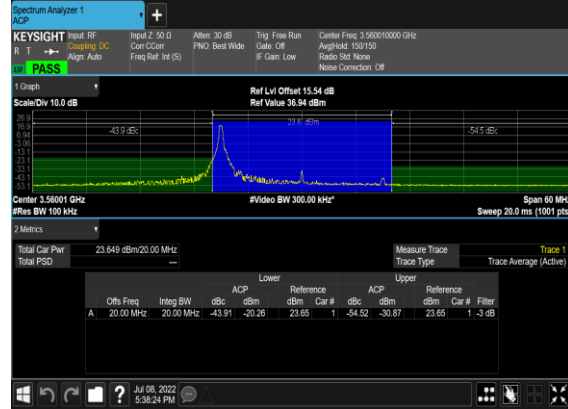

B13_N48(20M)_DFT-s-OFDM_PI_2-BPSK_Edge_1RB_Right_Low_CH

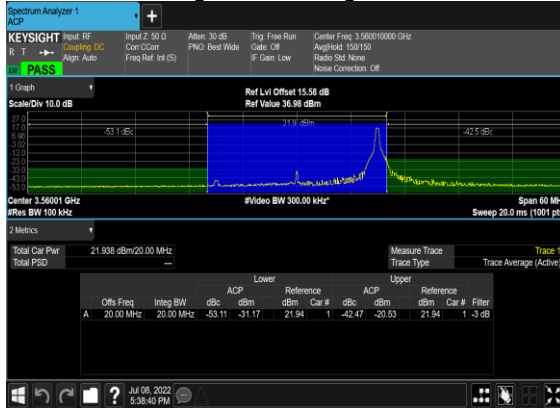

B13_N48(20M)_DFT-s-OFDM_QPSK_Outer_Full_Low_CH

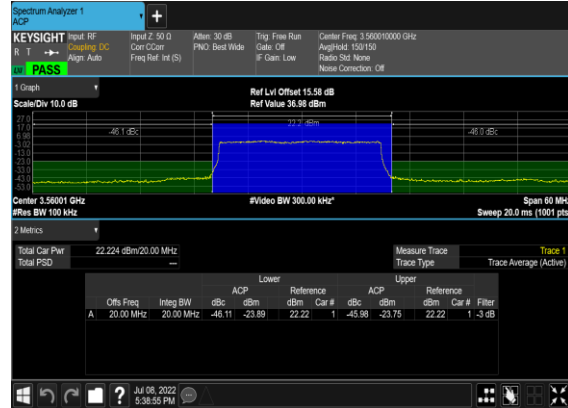

B13_N48(20M)_DFT-s-OFDM_QPSK_Edge_1RB_Left_Low_CH

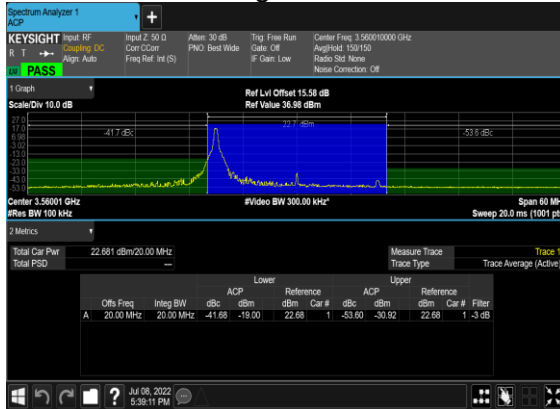

B13_N48(20M)_DFT-s-OFDM_QPSK_Edge_1RB_Right_Low_CH

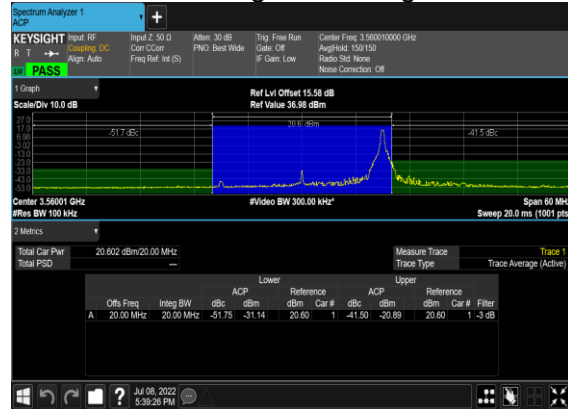



B13_N48(20M)_DFT-s-OFDM_PI_2-BPSK_Outer_Full_Mid_CH

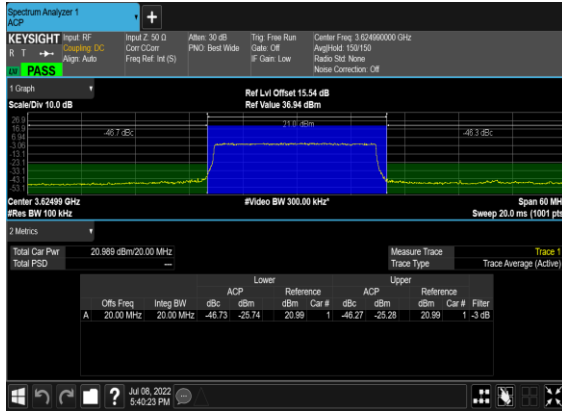

B13_N48(20M)_DFT-s-OFDM_PI_2-BPSK_Edge_1RB_Left_Mid_CH

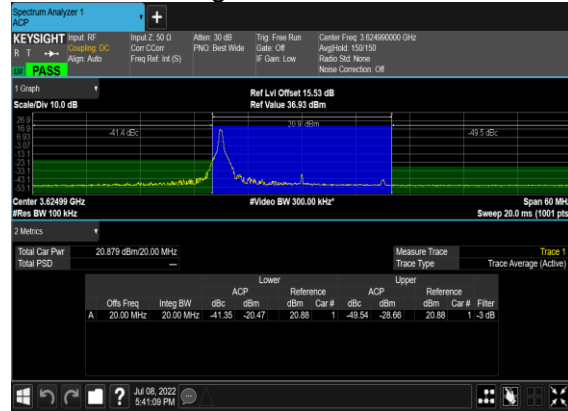

B13_N48(20M)_DFT-s-OFDM_PI_2-BPSK_Edge_1RB_Right_Mid_CH

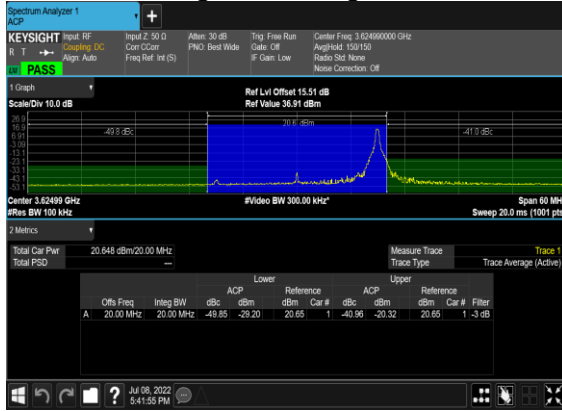

B13_N48(20M)_DFT-s-OFDM_QPSK_Outer_Full_Mid_CH

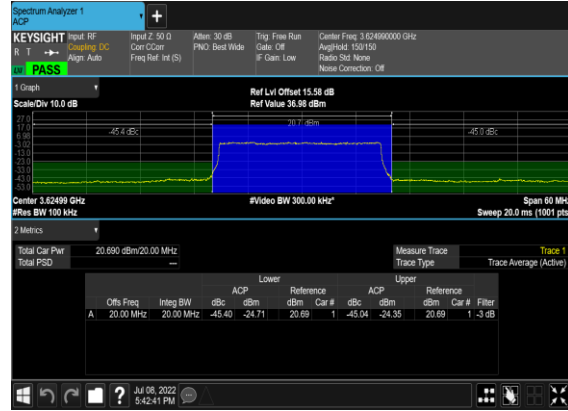

B13_N48(20M)_DFT-s-OFDM_QPSK_Edge_1RB_Left_Mid_CH

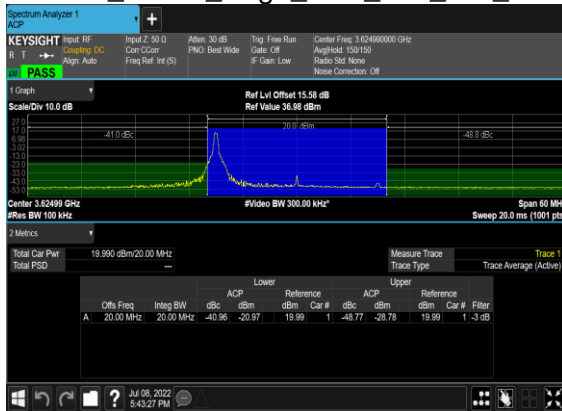

B13_N48(20M)_DFT-s-OFDM_QPSK_Edge_1RB_Right_Mid_CH

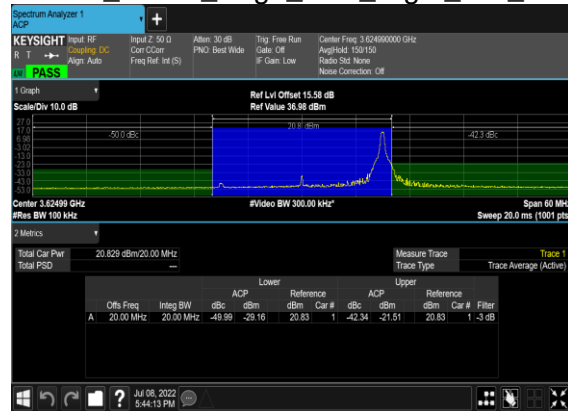



B13_N48(20M)_DFT-s-OFDM_PI_2-BPSK_Outer_Full_High_CH

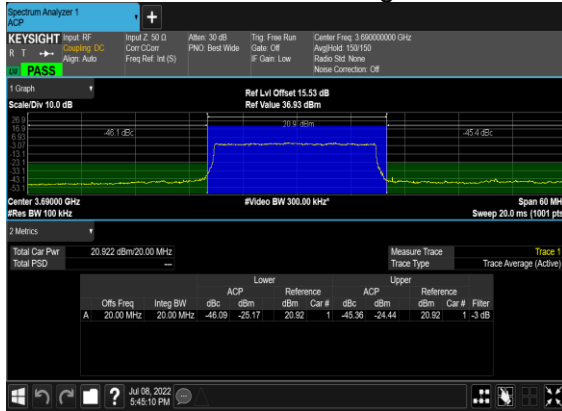

B13_N48(20M)_DFT-s-OFDM_PI_2-BPSK_Edge_1RB_Left_High_CH



B13_N48(20M)_DFT-s-OFDM_PI_2-BPSK_Edge_1RB_Right_High_CH

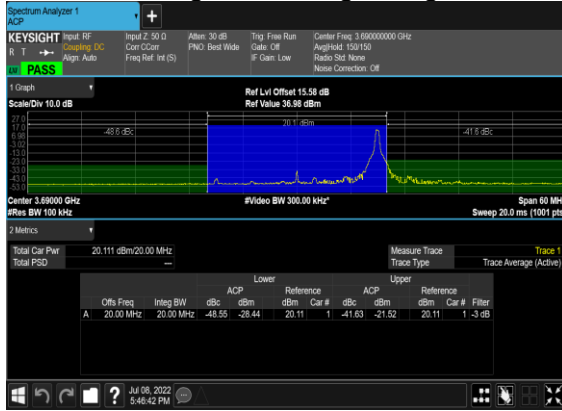

B13_N48(20M)_DFT-s-OFDM_QPSK_Outer_Full_High_CH

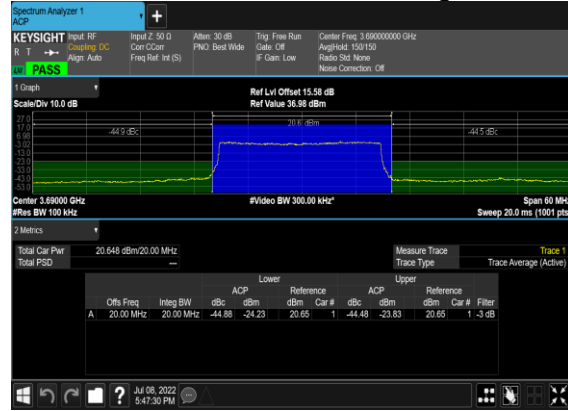

B13_N48(20M)_DFT-s-OFDM_QPSK_Edge_1RB_Left_High_CH

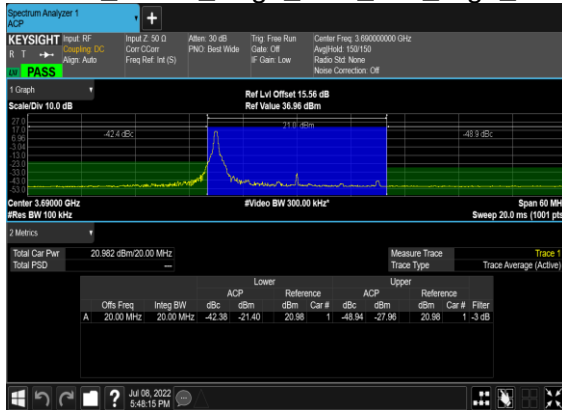

B13_N48(20M)_DFT-s-OFDM_QPSK_Edge_1RB_Right_High_CH

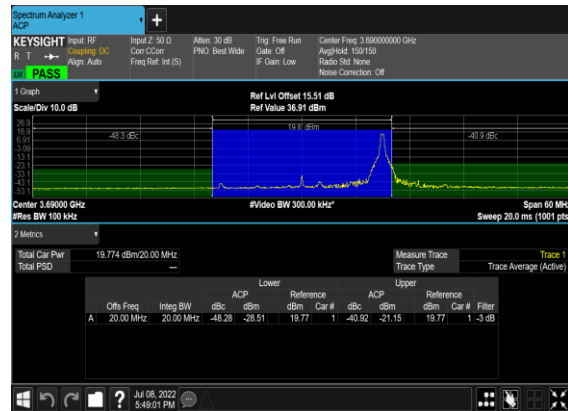



B13_N48(40M)_DFT-s-OFDM_PI_2-BPSK_Outer_Full_Low_CH

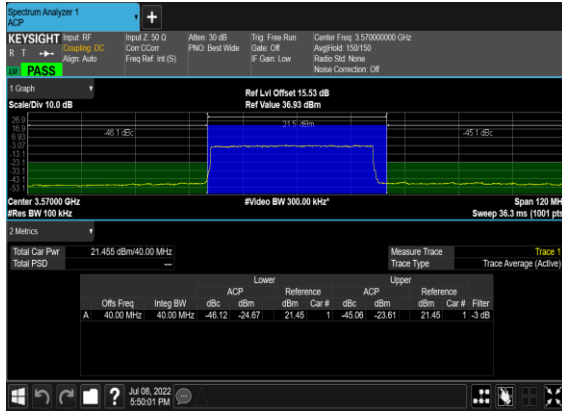

B13_N48(40M)_DFT-s-OFDM_PI_2-BPSK_Edge_1RB_Left_Low_CH

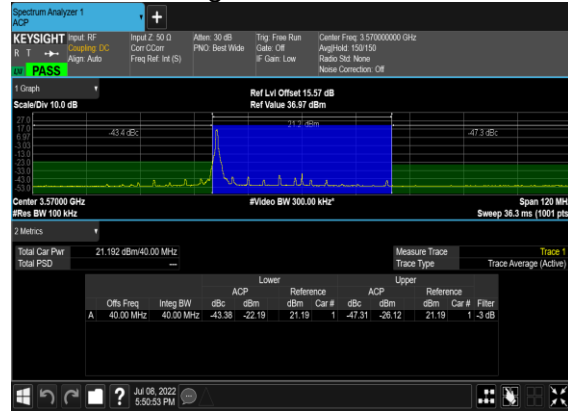

B13_N48(40M)_DFT-s-OFDM_PI_2-BPSK_Edge_1RB_Right_Low_CH

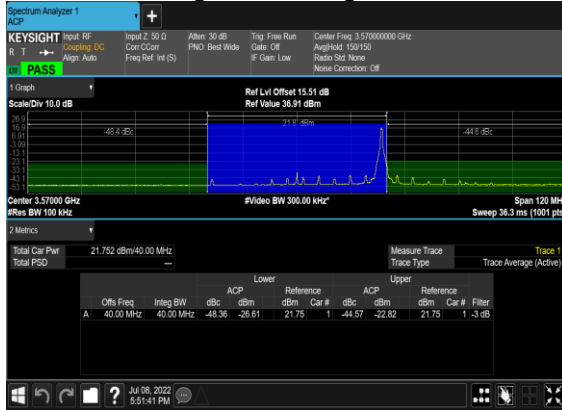

B13_N48(40M)_DFT-s-OFDM_QPSK_Outer_Full_Low_CH

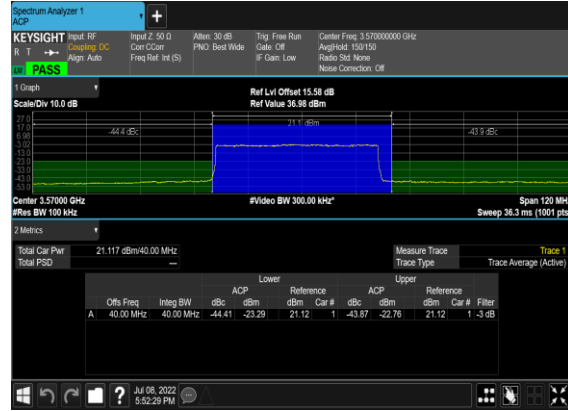

B13_N48(40M)_DFT-s-OFDM_QPSK_Edge_1RB_Left_Low_CH

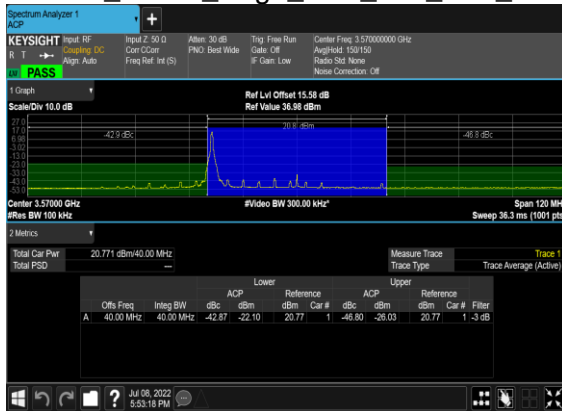

B13_N48(40M)_DFT-s-OFDM_QPSK_Edge_1RB_Right_Low_CH

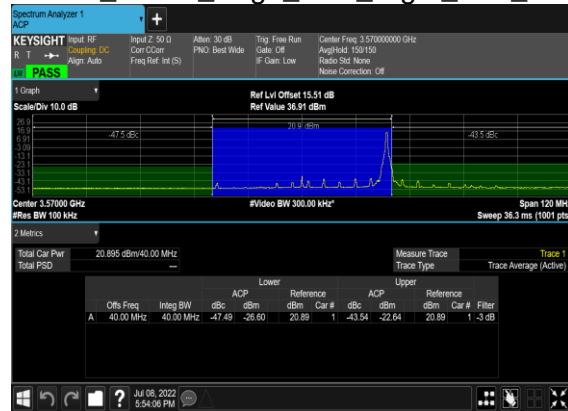



B13_N48(40M)_DFT-s-OFDM_PI_2-BPSK_Outer_Full_Mid_CH

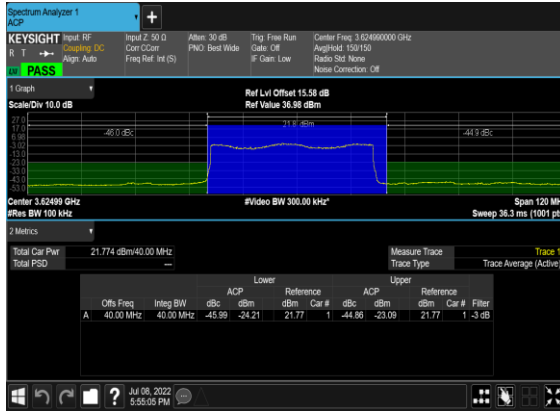

B13_N48(40M)_DFT-s-OFDM_PI_2-BPSK_Edge_1RB_Left_Mid_CH

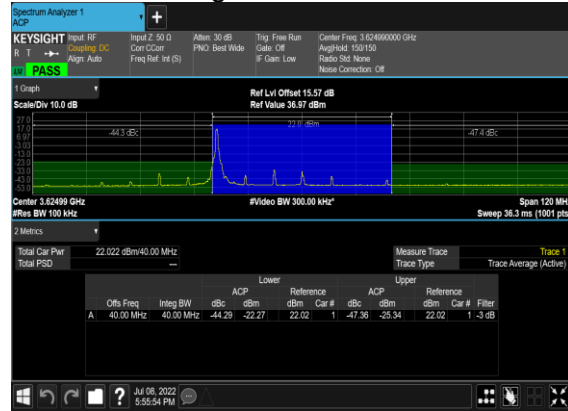

B13_N48(40M)_DFT-s-OFDM_PI_2-BPSK_Edge_1RB_Right_Mid_CH

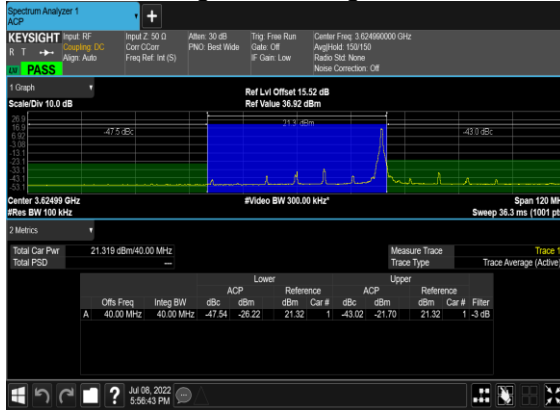

B13_N48(40M)_DFT-s-OFDM_QPSK_Outer_Full_Mid_CH

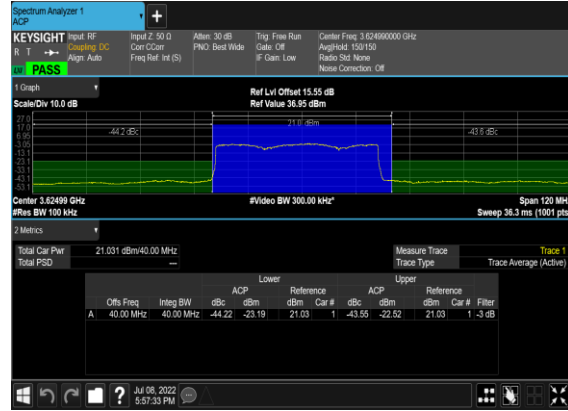

B13_N48(40M)_DFT-s-OFDM_QPSK_Edge_1RB_Left_Mid_CH

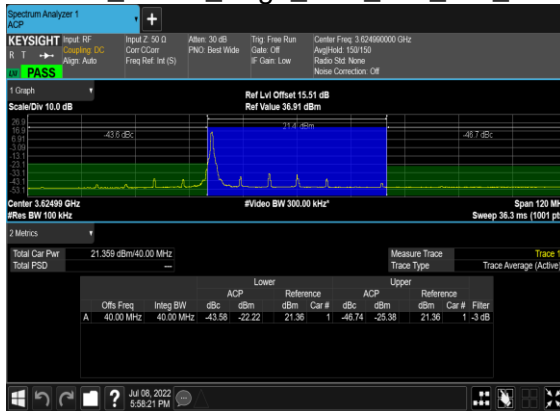

B13_N48(40M)_DFT-s-OFDM_QPSK_Edge_1RB_Right_Mid_CH

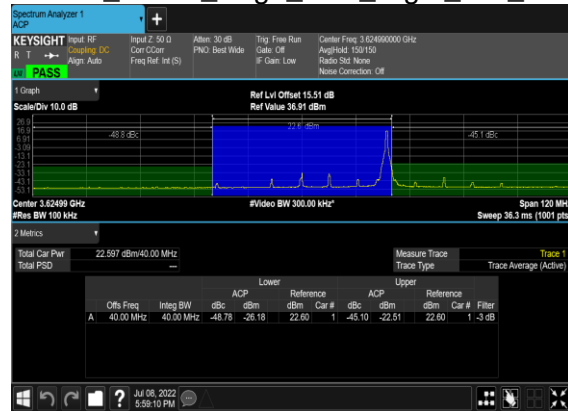



B13_N48(40M)_DFT-s-OFDM_PI_2-BPSK_Outer_Full_High_CH

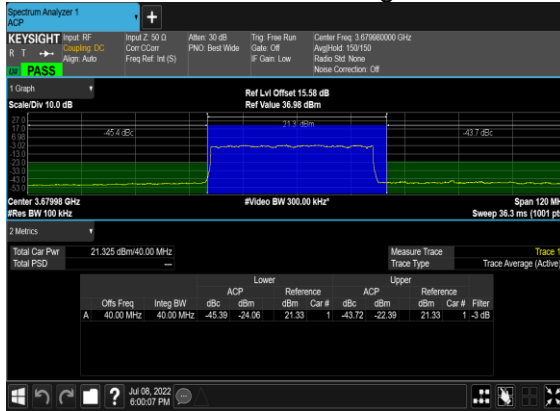

B13_N48(40M)_DFT-s-OFDM_PI_2-BPSK_Edge_1RB_Left_High_CH

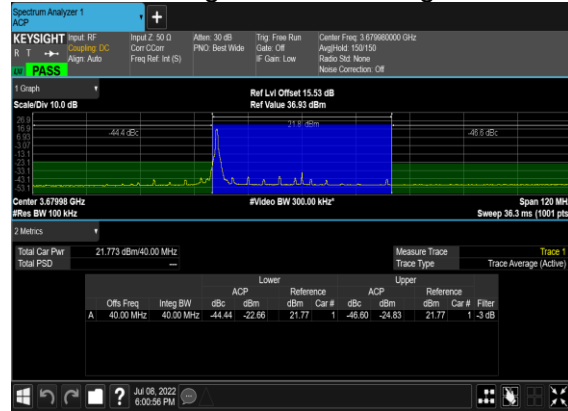

B13_N48(40M)_DFT-s-OFDM_PI_2-BPSK_Edge_1RB_Right_High_CH

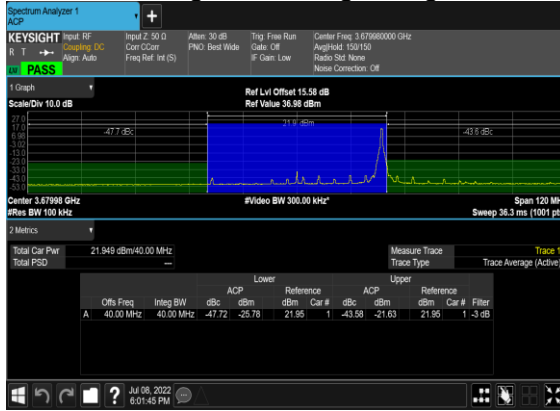

B13_N48(40M)_DFT-s-OFDM_QPSK_Outer_Full_High_CH

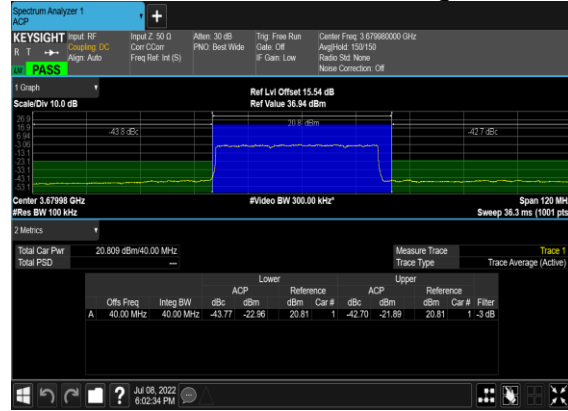

B13_N48(40M)_DFT-s-OFDM_QPSK_Edge_1RB_Left_High_CH

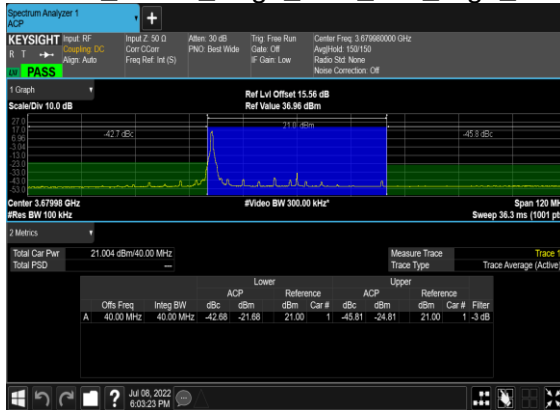

B13_N48(40M)_DFT-s-OFDM_QPSK_Edge_1RB_Right_High_CH

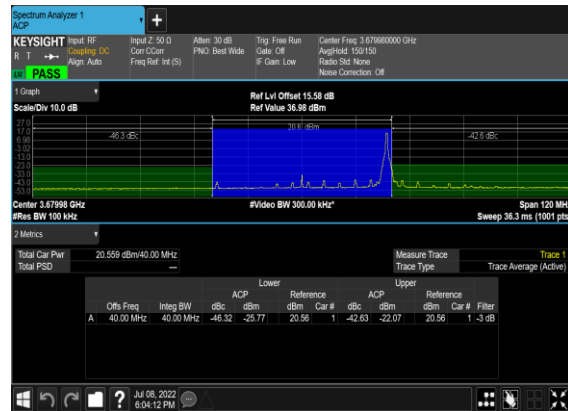



Conducted Spurious Emissions

NR Band	SCS (kHz)	Bandwidth (MHz)	Arfcn	Freq (MHz)	Modulation	RB	Result	Verdict
48	30	10	637000	3555.0	DFT-s-OFDM BPSK	1@0	see graph	---
48	30	10	637000	3555.0	DFT-s-OFDM BPSK	1@0	see graph	PASS
48	30	10	637000	3555.0	DFT-s-OFDM BPSK	1@0	see graph	PASS
48	30	10	637000	3555.0	DFT-s-OFDM QPSK	1@0	see graph	---
48	30	10	637000	3555.0	DFT-s-OFDM QPSK	1@0	see graph	PASS
48	30	10	637000	3555.0	DFT-s-OFDM QPSK	1@0	see graph	PASS
48	30	10	637000	3555.0	DFT-s-OFDM BPSK	1@23	see graph	---
48	30	10	637000	3555.0	DFT-s-OFDM BPSK	1@23	see graph	PASS
48	30	10	637000	3555.0	DFT-s-OFDM BPSK	1@23	see graph	PASS
48	30	10	637000	3555.0	DFT-s-OFDM QPSK	1@23	see graph	---
48	30	10	637000	3555.0	DFT-s-OFDM QPSK	1@23	see graph	PASS
48	30	10	637000	3555.0	DFT-s-OFDM QPSK	1@23	see graph	PASS
48	30	10	637000	3555.0	DFT-s-OFDM BPSK	24@0	see graph	---
48	30	10	637000	3555.0	DFT-s-OFDM BPSK	24@0	see graph	PASS
48	30	10	637000	3555.0	DFT-s-OFDM BPSK	24@0	see graph	PASS
48	30	10	637000	3555.0	DFT-s-OFDM QPSK	24@0	see graph	---
48	30	10	637000	3555.0	DFT-s-OFDM QPSK	24@0	see graph	PASS
48	30	10	637000	3555.0	DFT-s-OFDM QPSK	24@0	see graph	PASS
48	30	10	641666	3624.99	DFT-s-OFDM BPSK	1@0	see graph	---
48	30	10	641666	3624.99	DFT-s-OFDM BPSK	1@0	see graph	PASS



48	30	10	641666	3624.99	DFT-s-OFDM BPSK	1@0	see graph	PASS
48	30	10	641666	3624.99	DFT-s-OFDM QPSK	1@0	see graph	---
48	30	10	641666	3624.99	DFT-s-OFDM QPSK	1@0	see graph	PASS
48	30	10	641666	3624.99	DFT-s-OFDM QPSK	1@0	see graph	PASS
48	30	10	641666	3624.99	DFT-s-OFDM BPSK	1@23	see graph	---
48	30	10	641666	3624.99	DFT-s-OFDM BPSK	1@23	see graph	PASS
48	30	10	641666	3624.99	DFT-s-OFDM BPSK	1@23	see graph	PASS
48	30	10	641666	3624.99	DFT-s-OFDM QPSK	1@23	see graph	---
48	30	10	641666	3624.99	DFT-s-OFDM QPSK	1@23	see graph	PASS
48	30	10	641666	3624.99	DFT-s-OFDM QPSK	1@23	see graph	PASS
48	30	10	641666	3624.99	DFT-s-OFDM BPSK	24@0	see graph	---
48	30	10	641666	3624.99	DFT-s-OFDM BPSK	24@0	see graph	PASS
48	30	10	641666	3624.99	DFT-s-OFDM BPSK	24@0	see graph	PASS
48	30	10	641666	3624.99	DFT-s-OFDM QPSK	24@0	see graph	---
48	30	10	641666	3624.99	DFT-s-OFDM QPSK	24@0	see graph	PASS
48	30	10	641666	3624.99	DFT-s-OFDM QPSK	24@0	see graph	PASS
48	30	10	646332	3694.98	DFT-s-OFDM BPSK	1@0	see graph	---
48	30	10	646332	3694.98	DFT-s-OFDM BPSK	1@0	see graph	PASS
48	30	10	646332	3694.98	DFT-s-OFDM BPSK	1@0	see graph	PASS
48	30	10	646332	3694.98	DFT-s-OFDM QPSK	1@0	see graph	---
48	30	10	646332	3694.98	DFT-s-OFDM QPSK	1@0	see graph	PASS
48	30	10	646332	3694.98	DFT-s-OFDM QPSK	1@0	see graph	PASS



48	30	10	646332	3694.98	DFT-s-OFDM BPSK	1@23	see graph	---
48	30	10	646332	3694.98	DFT-s-OFDM BPSK	1@23	see graph	PASS
48	30	10	646332	3694.98	DFT-s-OFDM BPSK	1@23	see graph	PASS
48	30	10	646332	3694.98	DFT-s-OFDM QPSK	1@23	see graph	---
48	30	10	646332	3694.98	DFT-s-OFDM QPSK	1@23	see graph	PASS
48	30	10	646332	3694.98	DFT-s-OFDM QPSK	1@23	see graph	PASS
48	30	10	646332	3694.98	DFT-s-OFDM BPSK	24@0	see graph	---
48	30	10	646332	3694.98	DFT-s-OFDM BPSK	24@0	see graph	PASS
48	30	10	646332	3694.98	DFT-s-OFDM BPSK	24@0	see graph	PASS
48	30	10	646332	3694.98	DFT-s-OFDM QPSK	24@0	see graph	---
48	30	10	646332	3694.98	DFT-s-OFDM QPSK	24@0	see graph	PASS
48	30	10	646332	3694.98	DFT-s-OFDM QPSK	24@0	see graph	PASS
48	30	20	637334	3560.01	DFT-s-OFDM BPSK	1@0	see graph	---
48	30	20	637334	3560.01	DFT-s-OFDM BPSK	1@0	see graph	PASS
48	30	20	637334	3560.01	DFT-s-OFDM BPSK	1@0	see graph	PASS
48	30	20	637334	3560.01	DFT-s-OFDM QPSK	1@0	see graph	---
48	30	20	637334	3560.01	DFT-s-OFDM QPSK	1@0	see graph	PASS
48	30	20	637334	3560.01	DFT-s-OFDM QPSK	1@0	see graph	PASS
48	30	20	637334	3560.01	DFT-s-OFDM BPSK	1@50	see graph	---
48	30	20	637334	3560.01	DFT-s-OFDM BPSK	1@50	see graph	PASS
48	30	20	637334	3560.01	DFT-s-OFDM BPSK	1@50	see graph	PASS
48	30	20	637334	3560.01	DFT-s-OFDM QPSK	1@50	see graph	---



48	30	20	637334	3560.01	DFT-s-OFDM QPSK	1@50	see graph	PASS
48	30	20	637334	3560.01	DFT-s-OFDM QPSK	1@50	see graph	PASS
48	30	20	637334	3560.01	DFT-s-OFDM BPSK	50@0	see graph	---
48	30	20	637334	3560.01	DFT-s-OFDM BPSK	50@0	see graph	PASS
48	30	20	637334	3560.01	DFT-s-OFDM BPSK	50@0	see graph	PASS
48	30	20	637334	3560.01	DFT-s-OFDM QPSK	50@0	see graph	---
48	30	20	637334	3560.01	DFT-s-OFDM QPSK	50@0	see graph	PASS
48	30	20	637334	3560.01	DFT-s-OFDM QPSK	50@0	see graph	PASS
48	30	20	641666	3624.99	DFT-s-OFDM BPSK	1@0	see graph	---
48	30	20	641666	3624.99	DFT-s-OFDM BPSK	1@0	see graph	PASS
48	30	20	641666	3624.99	DFT-s-OFDM BPSK	1@0	see graph	PASS
48	30	20	641666	3624.99	DFT-s-OFDM QPSK	1@0	see graph	---
48	30	20	641666	3624.99	DFT-s-OFDM QPSK	1@0	see graph	PASS
48	30	20	641666	3624.99	DFT-s-OFDM QPSK	1@0	see graph	PASS
48	30	20	641666	3624.99	DFT-s-OFDM QPSK	1@0	see graph	PASS
48	30	20	641666	3624.99	DFT-s-OFDM BPSK	1@50	see graph	---
48	30	20	641666	3624.99	DFT-s-OFDM BPSK	1@50	see graph	PASS
48	30	20	641666	3624.99	DFT-s-OFDM BPSK	1@50	see graph	PASS
48	30	20	641666	3624.99	DFT-s-OFDM QPSK	1@50	see graph	---
48	30	20	641666	3624.99	DFT-s-OFDM QPSK	1@50	see graph	PASS
48	30	20	641666	3624.99	DFT-s-OFDM QPSK	1@50	see graph	PASS
48	30	20	641666	3624.99	DFT-s-OFDM BPSK	50@0	see graph	---
48	30	20	641666	3624.99	DFT-s-OFDM BPSK	50@0	see graph	PASS



48	30	20	641666	3624.99	DFT-s-OFDM BPSK	50@0	see graph	PASS
48	30	20	641666	3624.99	DFT-s-OFDM QPSK	50@0	see graph	---
48	30	20	641666	3624.99	DFT-s-OFDM QPSK	50@0	see graph	PASS
48	30	20	641666	3624.99	DFT-s-OFDM QPSK	50@0	see graph	PASS
48	30	20	646000	3690.0	DFT-s-OFDM BPSK	1@0	see graph	---
48	30	20	646000	3690.0	DFT-s-OFDM BPSK	1@0	see graph	PASS
48	30	20	646000	3690.0	DFT-s-OFDM BPSK	1@0	see graph	PASS
48	30	20	646000	3690.0	DFT-s-OFDM QPSK	1@0	see graph	---
48	30	20	646000	3690.0	DFT-s-OFDM QPSK	1@0	see graph	PASS
48	30	20	646000	3690.0	DFT-s-OFDM QPSK	1@0	see graph	PASS
48	30	20	646000	3690.0	DFT-s-OFDM BPSK	1@50	see graph	---
48	30	20	646000	3690.0	DFT-s-OFDM BPSK	1@50	see graph	PASS
48	30	20	646000	3690.0	DFT-s-OFDM BPSK	1@50	see graph	PASS
48	30	20	646000	3690.0	DFT-s-OFDM QPSK	1@50	see graph	---
48	30	20	646000	3690.0	DFT-s-OFDM QPSK	1@50	see graph	PASS
48	30	20	646000	3690.0	DFT-s-OFDM QPSK	1@50	see graph	PASS
48	30	20	646000	3690.0	DFT-s-OFDM BPSK	50@0	see graph	---
48	30	20	646000	3690.0	DFT-s-OFDM BPSK	50@0	see graph	PASS
48	30	20	646000	3690.0	DFT-s-OFDM BPSK	50@0	see graph	PASS
48	30	20	646000	3690.0	DFT-s-OFDM QPSK	50@0	see graph	---
48	30	20	646000	3690.0	DFT-s-OFDM QPSK	50@0	see graph	PASS
48	30	20	646000	3690.0	DFT-s-OFDM QPSK	50@0	see graph	PASS



48	30	40	638000	3570.0	DFT-s-OFDM BPSK	1@0	see graph	---
48	30	40	638000	3570.0	DFT-s-OFDM BPSK	1@0	see graph	PASS
48	30	40	638000	3570.0	DFT-s-OFDM BPSK	1@0	see graph	PASS
48	30	40	638000	3570.0	DFT-s-OFDM QPSK	1@0	see graph	---
48	30	40	638000	3570.0	DFT-s-OFDM QPSK	1@0	see graph	PASS
48	30	40	638000	3570.0	DFT-s-OFDM QPSK	1@0	see graph	PASS
48	30	40	638000	3570.0	DFT-s-OFDM BPSK	1@105	see graph	---
48	30	40	638000	3570.0	DFT-s-OFDM BPSK	1@105	see graph	PASS
48	30	40	638000	3570.0	DFT-s-OFDM BPSK	1@105	see graph	PASS
48	30	40	638000	3570.0	DFT-s-OFDM QPSK	1@105	see graph	---
48	30	40	638000	3570.0	DFT-s-OFDM QPSK	1@105	see graph	PASS
48	30	40	638000	3570.0	DFT-s-OFDM QPSK	1@105	see graph	PASS
48	30	40	638000	3570.0	DFT-s-OFDM BPSK	100@0	see graph	---
48	30	40	638000	3570.0	DFT-s-OFDM BPSK	100@0	see graph	PASS
48	30	40	638000	3570.0	DFT-s-OFDM BPSK	100@0	see graph	PASS
48	30	40	638000	3570.0	DFT-s-OFDM QPSK	100@0	see graph	---
48	30	40	638000	3570.0	DFT-s-OFDM QPSK	100@0	see graph	PASS
48	30	40	638000	3570.0	DFT-s-OFDM QPSK	100@0	see graph	PASS
48	30	40	641666	3624.99	DFT-s-OFDM BPSK	1@0	see graph	---
48	30	40	641666	3624.99	DFT-s-OFDM BPSK	1@0	see graph	PASS
48	30	40	641666	3624.99	DFT-s-OFDM BPSK	1@0	see graph	PASS
48	30	40	641666	3624.99	DFT-s-OFDM QPSK	1@0	see graph	---



48	30	40	641666	3624.99	DFT-s-OFDM QPSK	1@0	see graph	PASS
48	30	40	641666	3624.99	DFT-s-OFDM QPSK	1@0	see graph	PASS
48	30	40	641666	3624.99	DFT-s-OFDM BPSK	1@105	see graph	---
48	30	40	641666	3624.99	DFT-s-OFDM BPSK	1@105	see graph	PASS
48	30	40	641666	3624.99	DFT-s-OFDM BPSK	1@105	see graph	PASS
48	30	40	641666	3624.99	DFT-s-OFDM QPSK	1@105	see graph	---
48	30	40	641666	3624.99	DFT-s-OFDM QPSK	1@105	see graph	PASS
48	30	40	641666	3624.99	DFT-s-OFDM QPSK	1@105	see graph	PASS
48	30	40	641666	3624.99	DFT-s-OFDM BPSK	100@0	see graph	---
48	30	40	641666	3624.99	DFT-s-OFDM BPSK	100@0	see graph	PASS
48	30	40	641666	3624.99	DFT-s-OFDM BPSK	100@0	see graph	PASS
48	30	40	641666	3624.99	DFT-s-OFDM QPSK	100@0	see graph	---
48	30	40	641666	3624.99	DFT-s-OFDM QPSK	100@0	see graph	PASS
48	30	40	641666	3624.99	DFT-s-OFDM QPSK	100@0	see graph	PASS
48	30	40	645332	3679.98	DFT-s-OFDM BPSK	1@0	see graph	---
48	30	40	645332	3679.98	DFT-s-OFDM BPSK	1@0	see graph	PASS
48	30	40	645332	3679.98	DFT-s-OFDM BPSK	1@0	see graph	PASS
48	30	40	645332	3679.98	DFT-s-OFDM QPSK	1@0	see graph	---
48	30	40	645332	3679.98	DFT-s-OFDM QPSK	1@0	see graph	PASS
48	30	40	645332	3679.98	DFT-s-OFDM QPSK	1@0	see graph	PASS
48	30	40	645332	3679.98	DFT-s-OFDM BPSK	1@105	see graph	---
48	30	40	645332	3679.98	DFT-s-OFDM BPSK	1@105	see graph	PASS



48	30	40	645332	3679.98	DFT-s-OFDM BPSK	1@105	see graph	PASS
48	30	40	645332	3679.98	DFT-s-OFDM QPSK	1@105	see graph	---
48	30	40	645332	3679.98	DFT-s-OFDM QPSK	1@105	see graph	PASS
48	30	40	645332	3679.98	DFT-s-OFDM QPSK	1@105	see graph	PASS
48	30	40	645332	3679.98	DFT-s-OFDM BPSK	100@0	see graph	---
48	30	40	645332	3679.98	DFT-s-OFDM BPSK	100@0	see graph	PASS
48	30	40	645332	3679.98	DFT-s-OFDM BPSK	100@0	see graph	PASS
48	30	40	645332	3679.98	DFT-s-OFDM QPSK	100@0	see graph	---
48	30	40	645332	3679.98	DFT-s-OFDM QPSK	100@0	see graph	PASS
48	30	40	645332	3679.98	DFT-s-OFDM QPSK	100@0	see graph	PASS



B13_N48(10M)_DFT-s-OFDM_BPSK_Edge_1RB_Left_Low_CH

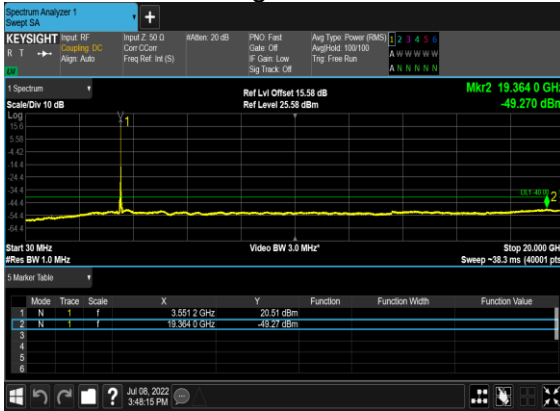

B13_N48(10M)_DFT-s-OFDM_BPSK_Edge_1RB_Left_Low_CH

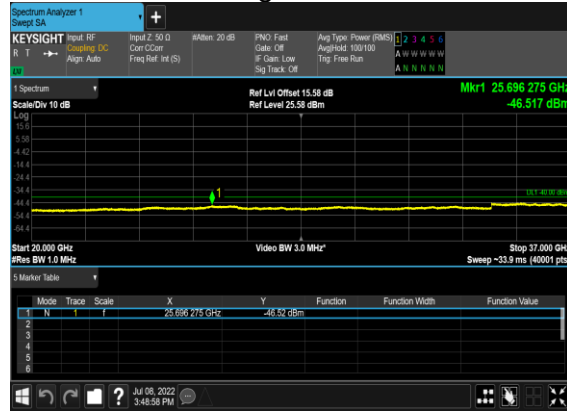

B13_N48(10M)_DFT-s-OFDM_QPSK_Edge_1RB_Left_Low_CH



B13_N48(10M)_DFT-s-OFDM_QPSK_Edge_1RB_Left_Low_CH



B13_N48(10M)_DFT-s-OFDM_BPSK_Edge_1RB_Right_Low_CH



B13_N48(10M)_DFT-s-OFDM_BPSK_Edge_1RB_Right_Low_CH

