

RF EVALUATION TEST REPORT

Applicant..... : ZAGG Inc.
Address..... : 910 West Legacy Center Way, Suite 500 Midvale, Utah 84047, USA.
Manufacturer..... : Dongguan Zhongkang Technology Electronics Co., Ltd.
Address..... : No.12 Yansha Road, TianXin, Tangxia Town, Dongguan City, Guangdong
Province, China
Factory..... : Dongguan Zhongkang Technology Electronics Co., Ltd.
Address..... : No.12 Yansha Road, TianXin, Tangxia Town, Dongguan City, Guangdong
Province, China
Product Name..... : JUMP STARTER
Brand
Name..... : **mophie**
Model No. : MP5G-WRLS44400
FCC ID..... : QTG-ZKMW
Measurement : 47 CFR PART 2, Section 2.1091& 2.1093
Standard..... TCB Workshop, April 27, 202, Wireless Power Transfer Updates
Receipt Date of Samples.... : July 07, 2022
Date of Tested..... : July 07, 2022 to July 20, 2022
Date of Report..... : July 26, 2022

This report shows that above equipment is technically compliant with the requirements of the standards above. All test results in this report apply only to the tested sample(s). Without prior written approval of Dongguan Nore Testing Center Co., Ltd, this report shall not be reproduced except in full.

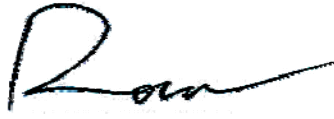

Prepared by

Rose Hu / Project Engineer



Approved by

Iori Fan / Authorized Signatory

Table of Contents

1. General Description of EUT 4

2. Test Facility and Location 6

3. Test Modes Detail 6

4. Configuration of EUT 7

5. Modification of EUT 7

6. Description of Support Device 7

7. Deviations and Abnormalities from Standard Conditions 7

8. Applicable Standards and References 7

9. Equipment approval considerations 8

10. Measurement Uncertainty 8

11. Maximum Permissible Exposure 9

12. Test Equipment List 13

13. Test Photos 14



Revision History

Report Number	Description	Issued Date
NTC2207060F-1	Initial Issue	2022-07-26

1. General Description of EUT

Product Information	
Product Name:	JUMP STARTER
Main Model Name:	MPSG-WRLS44400
Additional Model Name:	N/A
Model Difference:	N/A
S/N:	2207-3160
Brand Name:	mophie
Hardware Version:	Not stated
Software Version:	Not stated
Rating:	DC 14V come from Adapter DC 11.1V come from the internal battery
Typical Arrangement:	Table-top
I/O Port:	Refer to user manual.
Accessories Information	
Adapter:	M/N: PWRSTION-GO Input: AC 100-240V 50/60Hz 500mA Output: DC 14V 0.85A
Cable:	DC line of adapter: 1.24m unshielded, undetachable
Other:	N/A
Additional Information	
Note:	This report only applies to wireless charging function.
Remark:	All the information above are provided by the manufacturer. More detailed feature of the EUT please refers to the user manual.

Technical Specification	
Frequency Range:	110.5-205KHz
Modulation Type:	FSK
Antenna Type:	Coil antenna Antenna gain : -1dBi
Output power for each coil:	10W
Remark:	The information above are provided by the manufacturer. More detailed feature of the EUT please refers to the user manual.

Product Description Power Inductor(vertical Mount)

1. MECHANICAL DIMENSIONS: (mm)

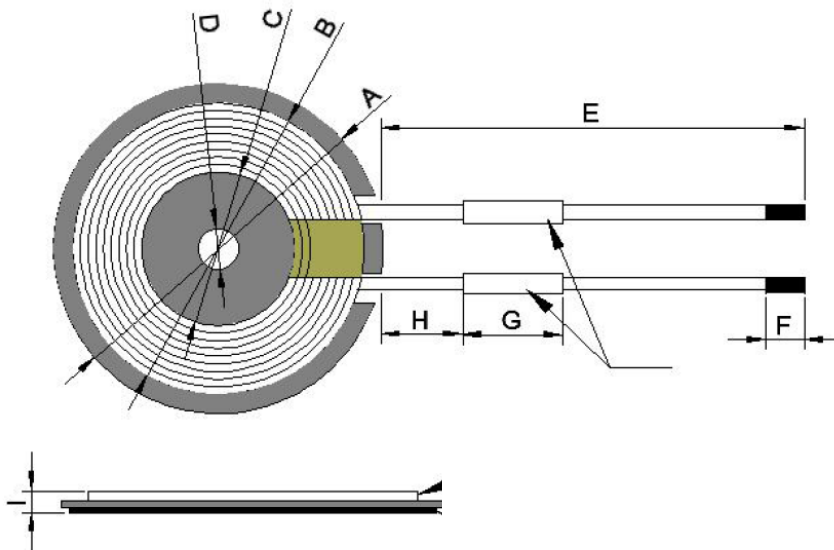

A	50±0.5
B	42.5±1.0
C	20.5±1.0
D	5.3±0.2
E	72±2
F	3.0±1.0
G	15.0±2.0
H	6±1.0
I	2.9Max

2. Test Facility and Location

Test Site	:	Dongguan Nore Testing Center Co., Ltd. (Dongguan NTC Co., Ltd.)
Accreditations and Authorizations	:	<p>The Laboratory has been assessed and proved to be in compliance with CNAS/CL01 Listed by CNAS, August 13, 2018 The Certificate Registration Number is L5795. The Certificate is valid until August 13, 2024</p> <p>The Laboratory has been assessed and proved to be in compliance with ISO17025 Listed by A2LA, November 01, 2017 The Certificate Registration Number is 4429.01</p> <p>Listed by FCC, November 06, 2017 Test Firm Registration Number: 907417</p> <p>Listed by Industry Canada, June 08, 2017 The Certificate Registration Number. Is 46405-9743A</p>
Test Site Location	:	Building D, Gaosheng Science and Technology Park, Hongtu Road, Nancheng District, Dongguan City, Guangdong Province, China

3. Test Modes Detail

Test Mode	Test Setup Configuration	Remark
1.	Operating with primary coil + 10W mobile phone	Internal Li-ion battery with full status
2.	Charging+Operating with primary coil + 10W mobile phone	Internal Li-ion battery with charging status
<p>Note: The tests took into account the state of the phone's battery at 1%, 50%, and 99%, only the worst case records in the report.</p>		

4. Configuration of EUT

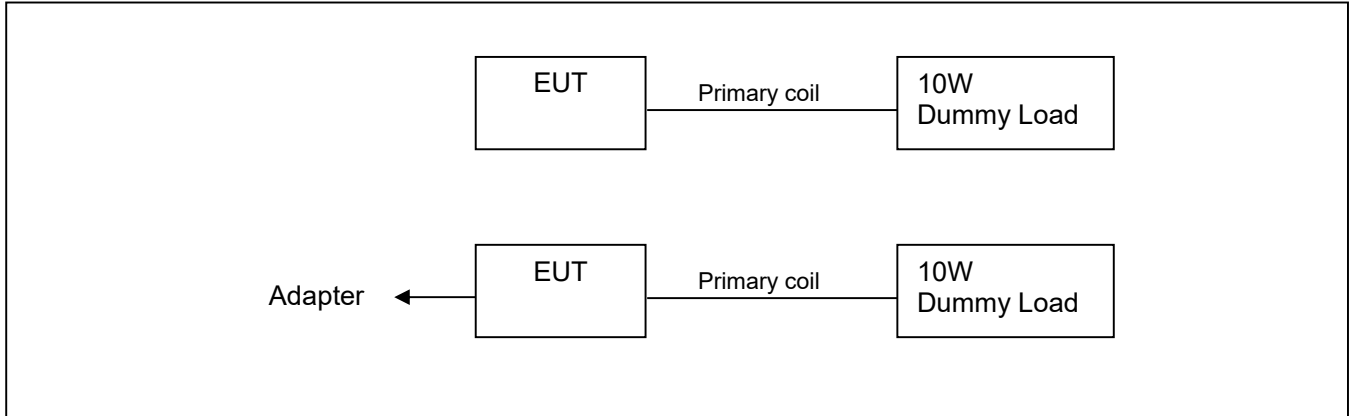

5. Modification of EUT

No modifications are made to the EUT during all test items.

6. Description of Support Device

The EUT has been tested as an independent unit together with other necessary accessories or support units. The following support units or accessories were used to form a representative test configuration during the tests.

No.	Equipment	Brand	M/N	S/N	Cable Specification	Remarks
1.	Mobile phone	APPLE	MQ6M2CH/A	FFNVJK8 MJC6F	---	---

7. Deviations and Abnormalities from Standard Conditions

No additions, deviations and exclusions from the standard.

8. Applicable Standards and References

According to the specifications of the manufacturer, the EUT must comply with the requirements of the following standards:

Test Standards:

47 CFR Part 1, 1.1307(b) and 1.1310

KDB 680106 D01v03

9. Equipment approval considerations

No.	Requirements	Conditions of the EUT
1.	Power transfer frequency is less than 1MHz	Yes, the operated frequency range is 110.5-205KHz.
2.	Output power from each primary coil is less than or equal to 15 watts	Yes, the maximum output power of the primary coil is 10W
3.	The system may consist of more than one source primary coils, charging one or more clients. If more than one primary coil is present, the coil pairs may be powered on at the same time	Yes; the transfer system includes two source primary coils pairs that can be powered on at the same time.
4.	Client device is placed directly in contact with the transmitter.	Yes, Client device is placed directly in contact with the transmitter.
5.	Mobile exposure conditions only (portable exposure conditions are not covered by this exclusion).	No, the device can be used as portable exposure condition.
6.	The aggregate H-field strengths at 20cm surrounding the device from all simultaneous transmitting coils are demonstrated to be less than 50% of the MPE limit.	Yes, less than the limits.
7.	The H-field strength surrounding the device is below the applicable limit in 47CF 1.1310.	Yes, H-field strength results are all below the limit in 47CF 1.1310.
8.	H-field data are taken along all three axes the device, from 0cm to 20 cm, in 2cm minimum increment measured from the edge of the device, with one axis coincident with the axis of the main coil	No. More than 50% of the MPE limit.
Remark: <input checked="" type="checkbox"/> need PAG process <input type="checkbox"/> no need PAG process		

10. Measurement Uncertainty

No.	Test Item	Uncertainty	Remarks
1.	Magnetic Field Emissions	±0.15 dB	---
2.	Electric Field Emissions	±0.36 dB	---
Note: 1.This uncertainty represents an expanded uncertainty expressed at approximately the 95% confidence level using a coverage factor of k=2.			

11. Maximum Permissible Exposure

LIMIT

Frequency range (MHz)	Electric field strength (V/m)	Magnetic field strength (A/m)	Power density (mW/cm ²)	Averaging time (minutes)
(A) Limits for Occupational/Controlled Exposures				
0.3-3.0	614	1.63	*(100)	6
3.0-30	1842/f	4.89/f	*(900/f ²)	6
30-300	61.4	0.163	1.0	6
300-1500	/	/	f/300	6
1500-100,000	/	/	5	6
(B) Limits for General Population/Uncontrolled Exposure				
0.3-1.34	614	1.63	*(100)	30
1.34-30	824/f	2.19/f	*(180/f ²)	30
30-300	27.5	0.073	0.2	30
300-1500	/	/	f/1500	30
1500-100,00	/	/	1.0	30

F=frequency in MHz

*=Plane-wave equivalent power density

RF exposure compliance will need to be determined with respect to 1.1307(c) and (d) of the FCC rules. The emissions should be within the limits at 300kHz in Table 1 of 1.1310(use the 300kHz limits for 150kHz: 614V/m,1.63A/m).

Per KDB 680106 D01 v03 r01, RF exposure evaluation at 15cm surrounding the device and 20cm above the top surface. Emission between 50 kHz to 300 kHz should be assessed versus the limits at 300 kHz in Table 1 of Section 1.1310: 1.63/Am and aggregate H-field strengths from all simultaneous transmitting coils are demonstrated to be less than 50% of the MPE limit.

BLOCK DIAGRAM OF TEST SETUP

For mobile exposure conditions:

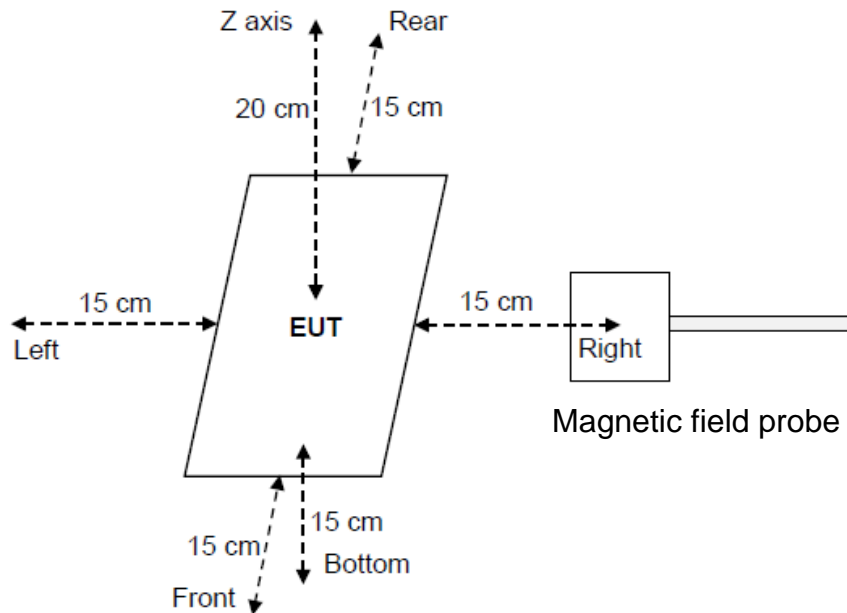

For portable exposure conditions:

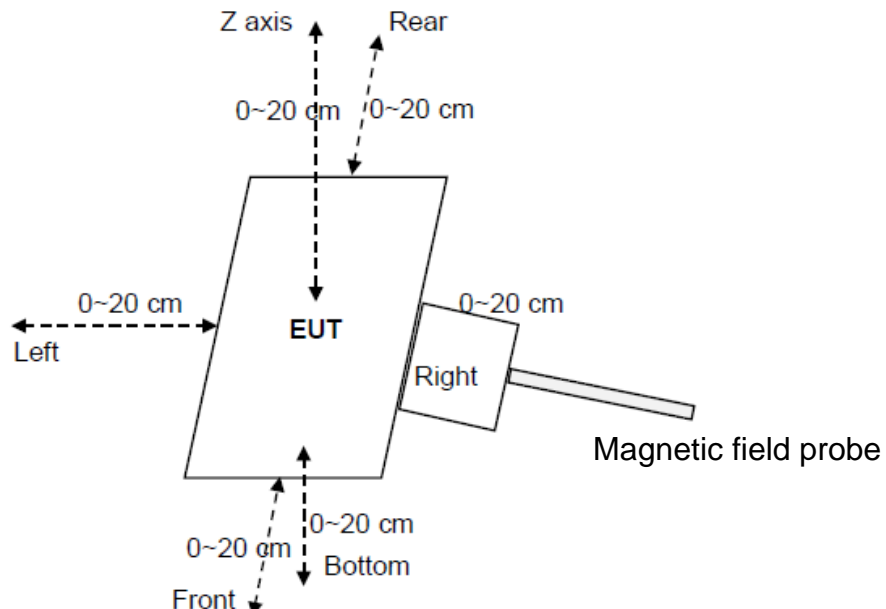

Note: The distance of the points A/B/C/D/E/F are 0, 2, 4, 6, 8, 10, 12, 14, 16, 18, 20cm.

TEST PROCEDURES

For mobile exposure conditions:

- a. The RF exposure test was performed in anechoic chamber;
- b. E and H-field measurements should be made with the center of the probe at a distance of 15cm surrounding the EUT and 20cm above the top surface of the primary/client pair.
- c. The highest emission level was recorded and compared with limit.
- d. The EUT was measured according to the dictates of KDB 680106 v03r01.

For portable exposure conditions:

- a. The RF exposure test was performed in anechoic chamber;
- b. E and H-field measurements should be made with the probe at 0cm for all side of the EUT.
- c. The highest emission level was recorded and compared with limit.

For portable exposure conditions:

Perform H-field measurements for each edge/top surface of the host/client pair at every 2cm, starting from as close as possible out to 10cm.

TEST RESULTS

PASS

Please refer to the following pages.

Test Mode 1					
Test Distance (cm)	Test Position	Probe Measure Result (V/m)	Probe Measure Result (A/m)	Limit (V/m)	Limit (A/m)
0	Side A	12.730	0.271	614	0.815
	Side B	14.254	0.382	614	0.815
	Side C	13.636	0.283	614	0.815
	Side D	18.732	0.255	614	0.815
	Side E	27.890	0.281	614	0.815
	Side F	14.250	0.256	614	0.815
2	Side A	8.679	0.261	614	0.815
	Side B	9.109	0.315	614	0.815
	Side C	11.456	0.276	614	0.815
	Side D	14.672	0.247	614	0.815
	Side E	20.821	0.283	614	0.815
	Side F	9.119	0.243	614	0.815
4	Side A	4.028	0.267	614	0.815
	Side B	3.783	0.370	614	0.815
	Side C	3.972	0.267	614	0.815
	Side D	7.180	0.244	614	0.815
	Side E	9.349	0.279	614	0.815
	Side F	3.763	0.234	614	0.815
6	Side A	2.403	0.225	614	0.815
	Side B	2.076	0.338	614	0.815
	Side C	1.855	0.219	614	0.815
	Side D	4.108	0.216	614	0.815
	Side E	7.402	0.269	614	0.815
	Side F	2.156	0.269	614	0.815
8	Side A	1.380	0.218	614	0.815
	Side B	1.339	0.318	614	0.815
	Side C	1.321	0.215	614	0.815
	Side D	2.749	0.209	614	0.815
	Side E	2.379	0.213	614	0.815
	Side F	1.231	0.215	614	0.815
10	Side A	1.078	0.211	614	0.815
	Side B	1.198	0.294	614	0.815
	Side C	0.767	0.211	614	0.815
	Side D	1.611	0.203	614	0.815
	Side E	1.032	0.193	614	0.815
	Side F	1.090	0.205	614	0.815
12	Side A	1.104	0.203	614	0.815
	Side B	1.106	0.263	614	0.815
	Side C	0.619	0.205	614	0.815
	Side D	0.666	0.193	614	0.815
	Side E	0.821	0.184	614	0.815
	Side F	0.921	0.193	614	0.815
14	Side A	0.846	0.195	614	0.815
	Side B	1.106	0.224	614	0.815
	Side C	0.619	0.201	614	0.815
	Side D	0.912	0.186	614	0.815
	Side E	0.831	0.194	614	0.815

	Side F	0.624	0.172	614	0.815
16	Side A	0.650	0.187	614	0.815
	Side B	1.040	0.209	614	0.815
	Side C	0.544	0.197	614	0.815
	Side D	0.521	0.179	614	0.815
	Side E	0.690	0.187	614	0.815
	Side F	0.544	0.181	614	0.815
	18	Side A	0.577	0.183	614
Side B		0.790	0.193	614	0.815
Side C		0.531	0.192	614	0.815
Side D		0.521	0.178	614	0.815
Side E		0.690	0.179	614	0.815
Side F		0.531	0.181	614	0.815
20		Side A	0.433	0.179	614
	Side B	0.738	0.178	614	0.815
	Side C	0.502	0.187	614	0.815
	Side D	0.490	0.177	614	0.815
	Side E	0.551	0.177	614	0.815
	Side F	0.433	0.178	614	0.815

12. Test Equipment List

Item	Equipment	Manufacturer	Model No.	Serial No.	Last Cal.	Cal. Interval
1.	Magnetic field probe 100cm ²	Narda	ETL-400 Probe 1Hz-400KHz (r=6.2cm)	M-1587	June 28,2022	1 Year
2.	E-Field Probe	Narda	EP-601	611WX70729	Mar. 23, 2022	1 Year

13. Test Photos

Side A: Test distance 0cm



Side A: Test distance 2cm



Side A: Test distance 4cm



Side A: Test distance 6cm



Side A: Test distance 8cm



Side A: Test distance 10cm



Side A: Test distance 12cm



Side A: Test distance 14cm



Side A: Test distance 16cm



Side A: Test distance 18cm



Side A: Test distance 20cm



Side B: Test distance 0cm



Side B: Test distance 2cm



Side B: Test distance 4cm



Side B: Test distance 6cm



Side B: Test distance 8cm



Side B: Test distance 10cm



Side B: Test distance 12cm



Side B: Test distance 14cm



Side B: Test distance 16cm



Side B: Test distance 18cm



Side B: Test distance 20cm



Side C: Test distance 0cm



Side C: Test distance 2cm



Side C: Test distance 4cm



Side C: Test distance 6cm



Side C: Test distance 8cm



Side C: Test distance 10cm



Side C: Test distance 12cm



Side C: Test distance 14cm



Side C: Test distance 16cm



Side C: Test distance 18cm



Side C: Test distance 20cm



Side D: Test distance 0cm



Side D: Test distance 2cm



Side D: Test distance 4cm



Side D: Test distance 6cm



Side D: Test distance 8cm



Side D: Test distance 10cm



Side D: Test distance 12cm



Side D: Test distance 14cm



Side D: Test distance 16cm



Side D: Test distance 18cm



Side D: Test distance 20cm



Side E: Test distance 0cm



Side E: Test distance 2cm



Side E: Test distance 4cm



Side E: Test distance 6cm



Side E: Test distance 8cm



Side E: Test distance 10cm



Side E: Test distance 12cm



Side E: Test distance 14cm

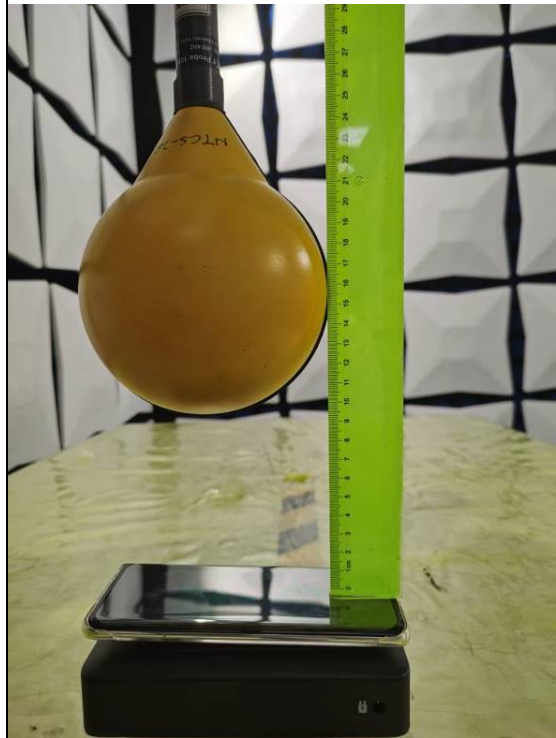

Side E: Test distance 16cm

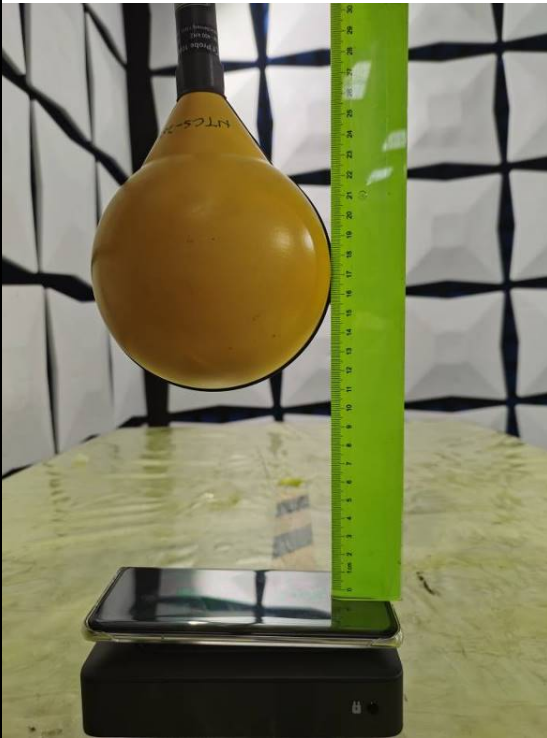

Side E: Test distance 18cm

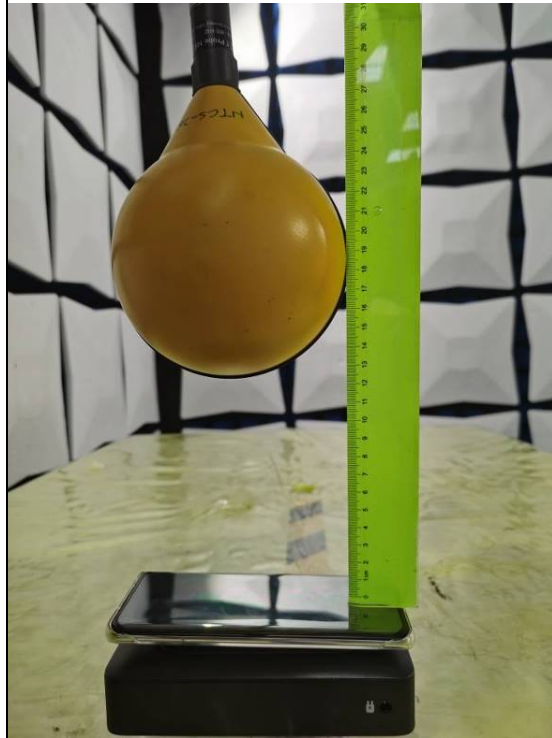

Side E: Test distance 20cm

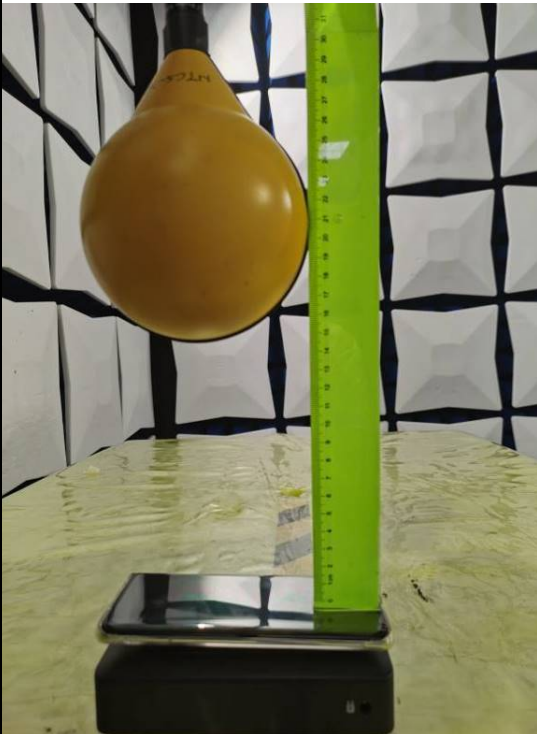

Side F: Test distance 0cm

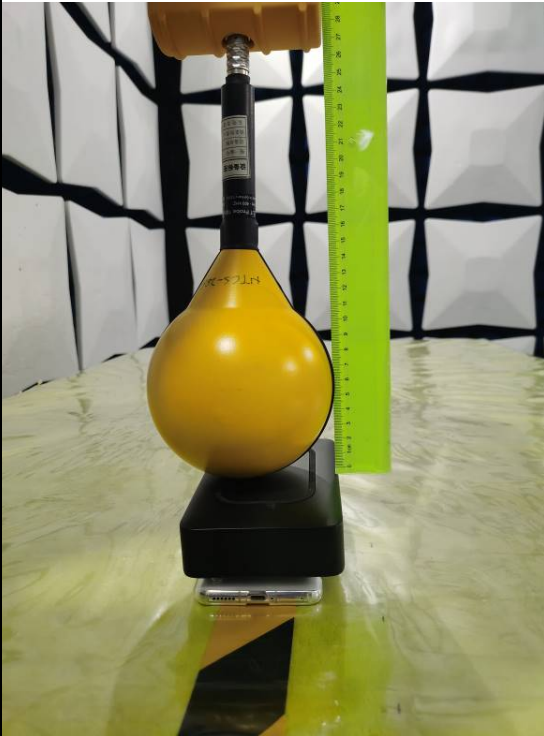

Side F: Test distance 2cm



Side F: Test distance 4cm

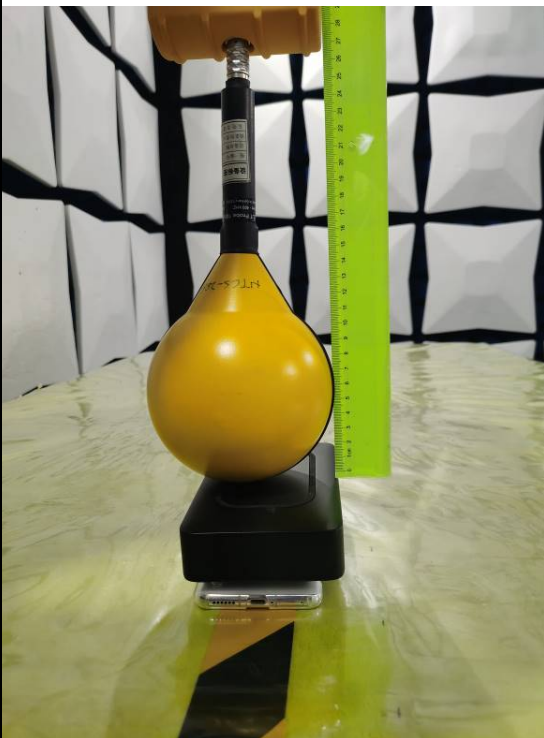

Side F: Test distance 6cm



Side F: Test distance 8cm



Side F: Test distance 10cm

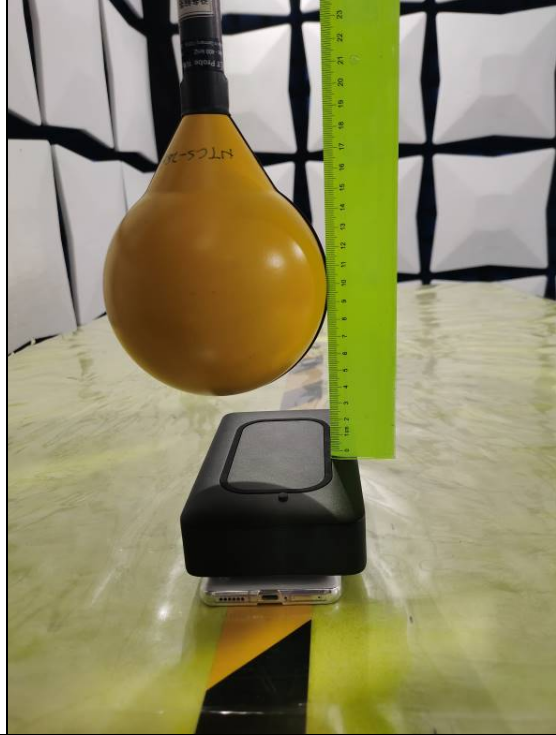

Side F: Test distance 12cm

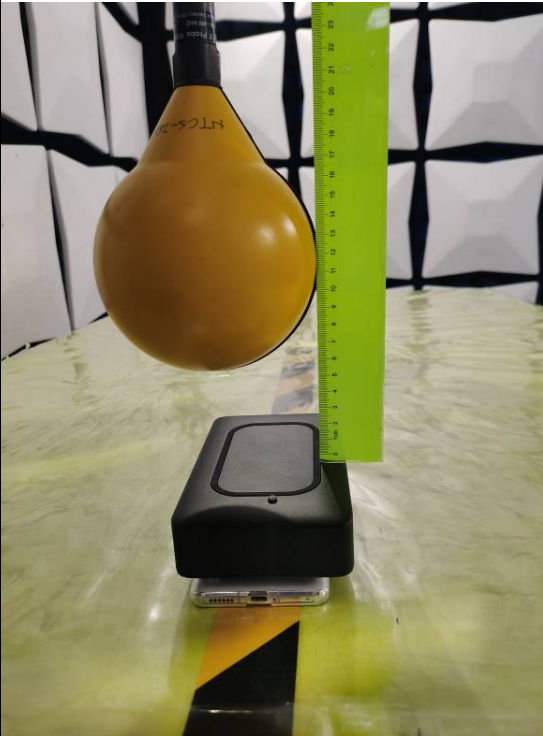

Side F: Test distance 14cm

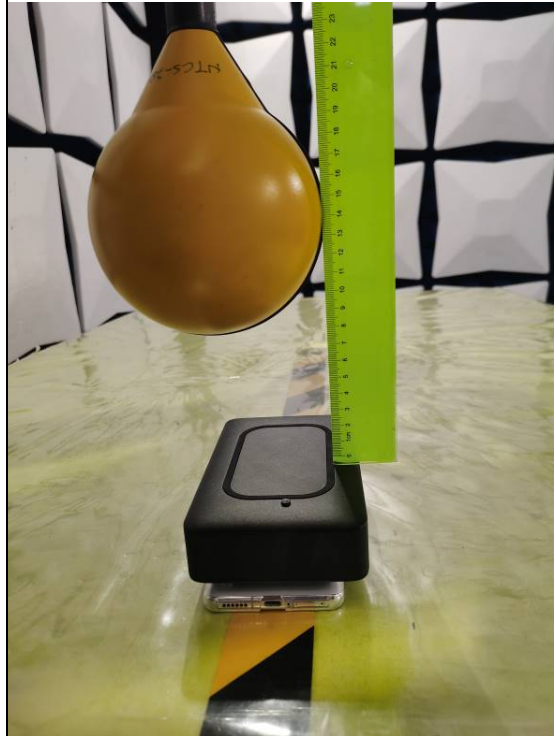

Side F: Test distance 16cm

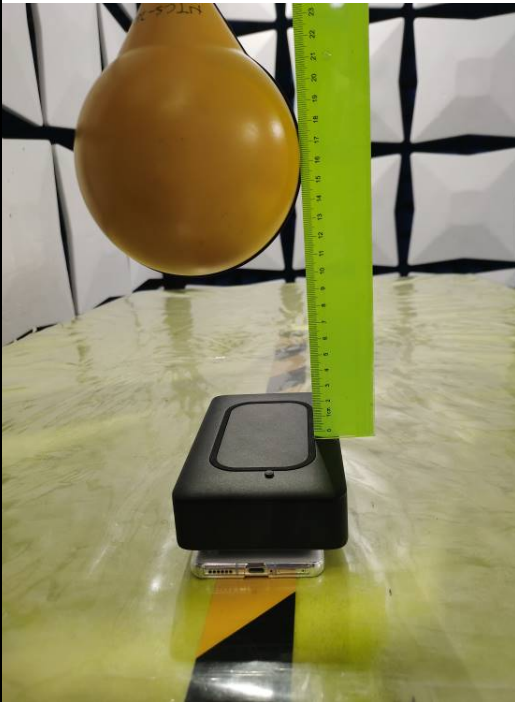

Side F: Test distance 18cm

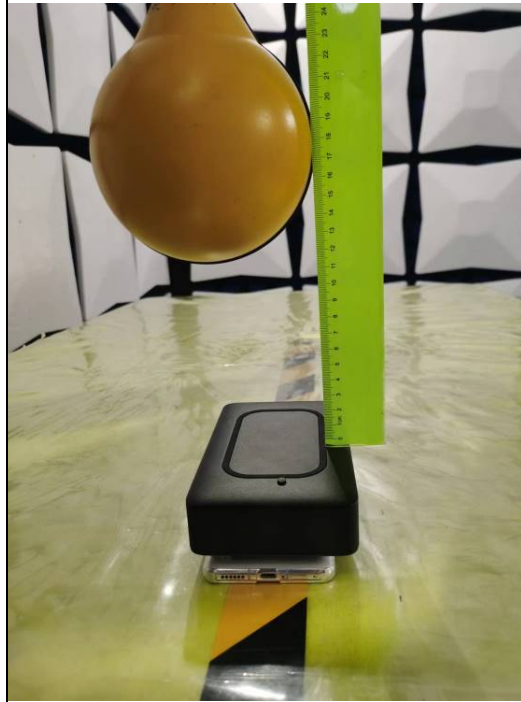

Side F: Test distance 20cm

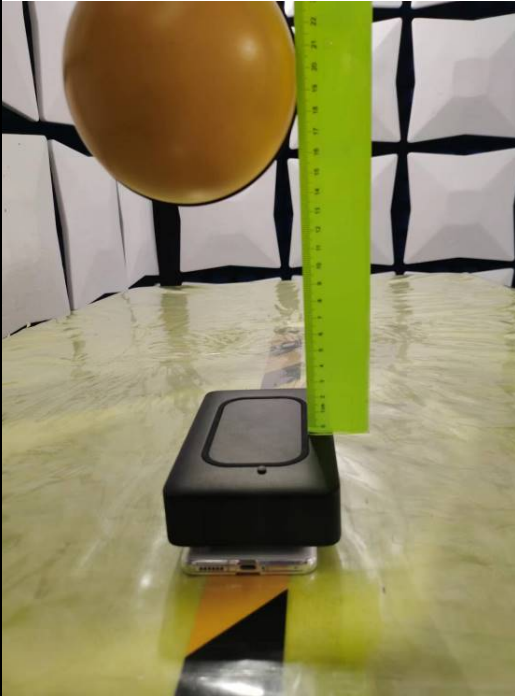

---End---