

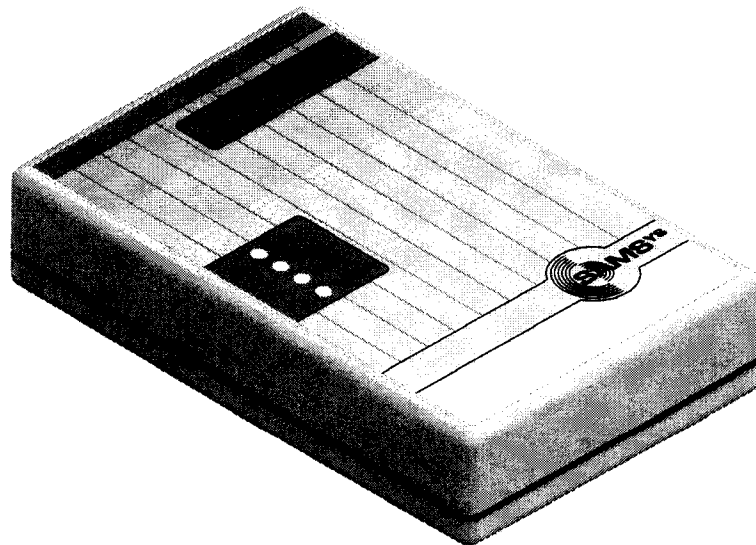

SARS MP9111

125 KHz Proximity Reader



Owner's Manual

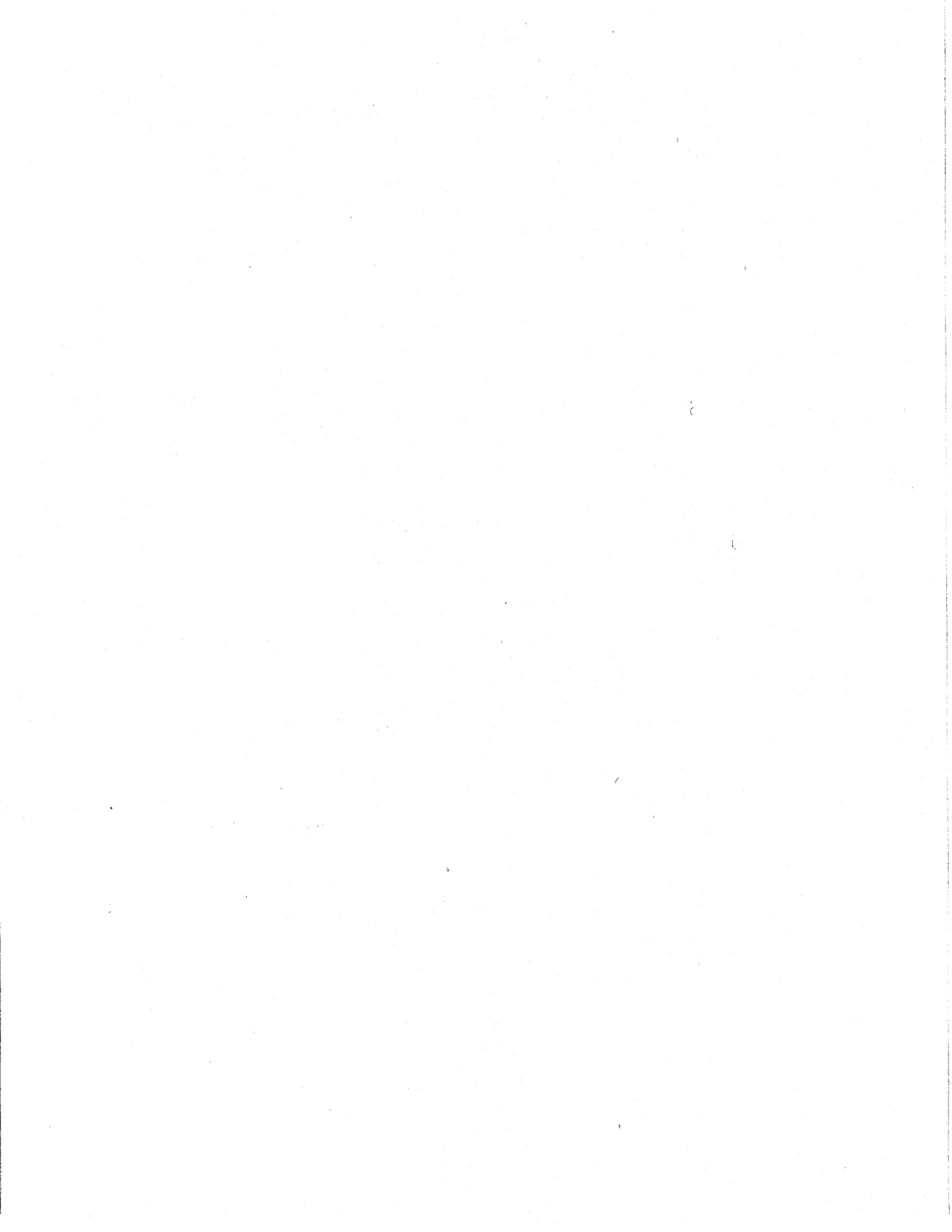



SARS MP9111

125 KHz Proximity Reader

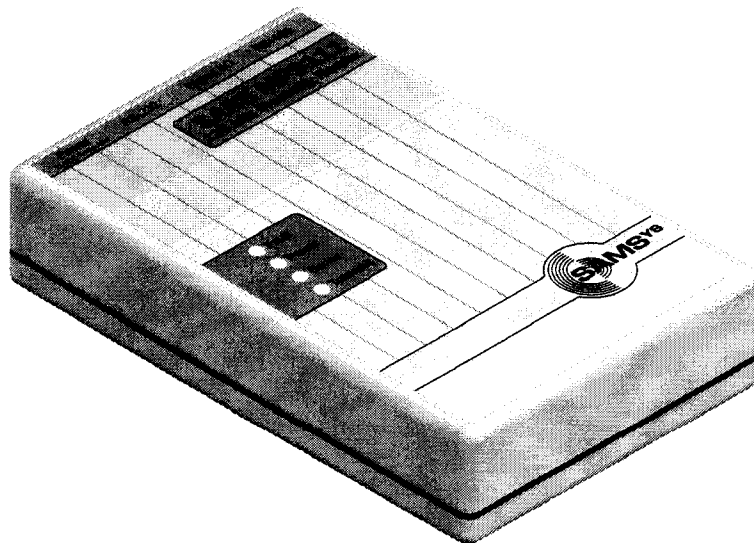

Owner's Manual

SAMSys

SARS MP9111

125 KHz Proximity Reader Owner's Manual

Second Edition (April 2003)

© Copyright 2003 SAMSys Technologies, Inc. All Rights Reserved.

Disclaimer and Limitation of Liability

The content of this manual is for information use only and is subject to change without notice. SAMSys assumes no responsibility or liability for any errors or inaccuracies that may appear in this publication. No part of this manual may be reproduced in any form or by any means, electronic, mechanical, recording, or otherwise, without the prior written permission of SAMSys.

SAMSys products are not designed, intended, authorized or warranted to be suitable for life support applications or any other life critical applications which could involve potential risk of death, personal injury, property damage, or environmental damage.

About SAMSys

SAMSys is the world leader in the design and supply of radio frequency identification (RFID) hardware solutions for high volume pallet and reusable container tracking applications in global logistics management, materials handling, and supply chain industries. SAMSys is a public company listed on the Canadian Venture Exchange under the symbol SMY.

SAMSys Technologies, Inc.
44 East Beaver Creek Rd., Unit 11
Richmond Hill, Ontario L4B 1G8 Canada
Phone: (905) 707-0404
Toll Free: (877) 463-6546
Fax: (905) 707-9944
E-mail: samsys@samsys.com
Web: www.samsys.com

Part Number: HI469-111-OM-V2



Federal Communications Commission (FCC) Notice

This device was tested and found to comply with the limits set forth in Part 15 of the FCC Rules. Operation is subject to the following conditions: (1) this device may not cause harmful interference, and (2) this device must accept any interference received including interference that may cause undesired operation. These limits are designed to provide reasonable protection against harmful interference when the equipment is operated in a commercial environment.

This device generates, uses, and can radiate radio frequency energy. If not installed and used in accordance with the instruction manual, the product may cause harmful interference to radio communications. Operation of this product in a residential area is likely to cause harmful interference, in which case, the user is required to correct the interference at their own expense.

The authority to operate this product is conditioned by the requirements that no modifications be made to the equipment unless the changes or modifications are expressly approved by SAMSys Technologies.

Trademarks

SAMSys is a trademark of SAMSys Technologies, Inc.

HyperTerminal® is a registered trademark of Hilgraeve, Inc.

Other company, product or service names appearing in this manual may be trademarks or service marks of their respective owners.

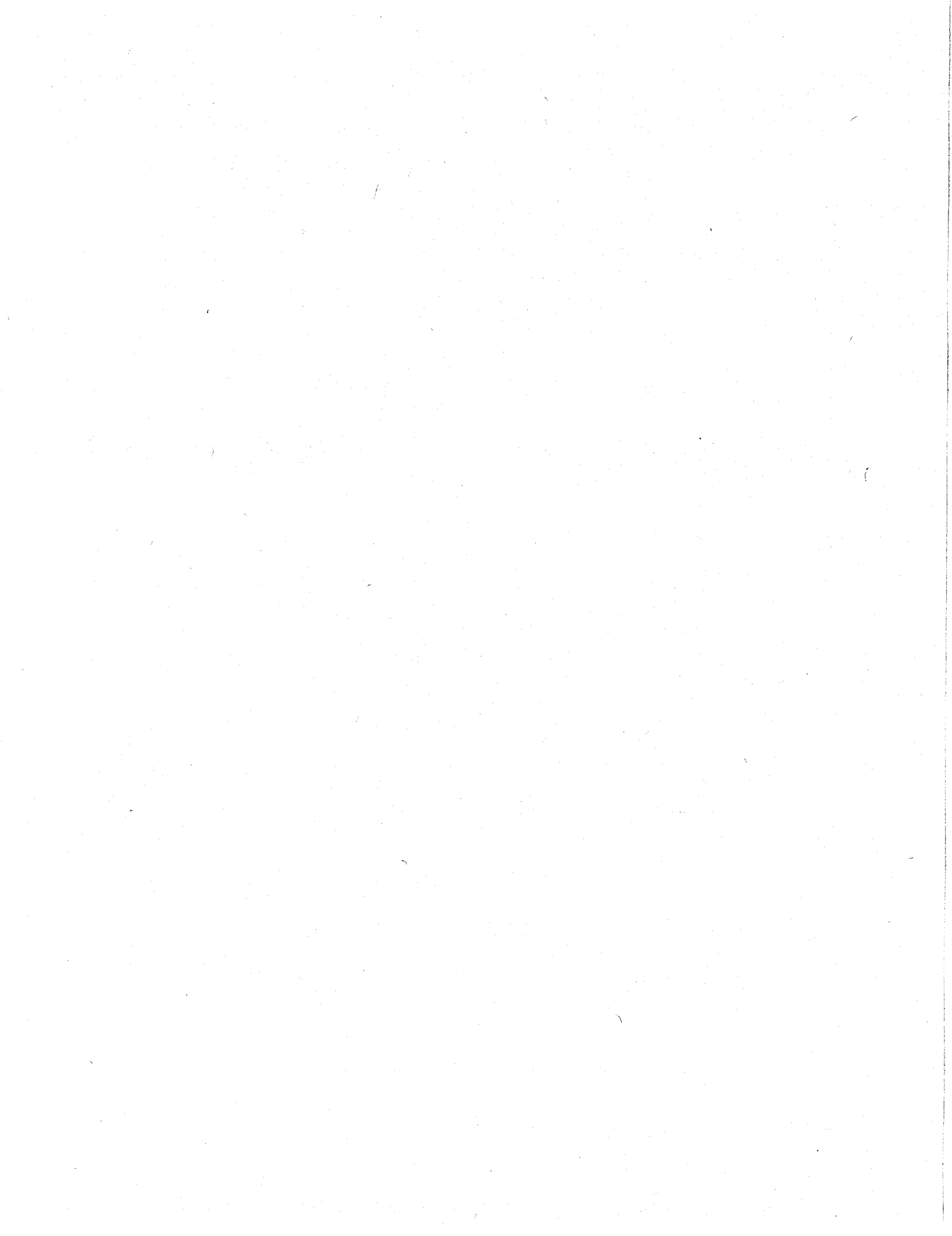

Contents

Introduction	1
Unpacking the Reader	2
About the SARS MP9111	3
Features	3
Applications	4
Physical Description	5
Installation	8
Reader Installation	9
RS-232 Communication Setup	10
RS-485 Communication Setup	11
Digital (TTL) Input/Output Setup	12
Operation	14
Reader Power Up	15
Reading Tags	15
Operation with the ICCM	16
Operation with a Terminal Emulation Program ...	16
Troubleshooting	17
General Troubleshooting	18
Contact Us	21
Specifications	22
Reader Specifications	23
Environmental Specifications	23
Power Supply Specifications	24
Digital I/O Connector Specifications	24
RS-232 Connector Specifications	25
RS-485 Connector Specifications	26

Figures

Reader and Accessories	2
SARS Reader Network	4
Reader Board and Enclosure	5
Reader LED Indicators	6
Reader End-Panel Connectors	7
Horizontal Surface Installation	9
RS-485 Cable Installation	12
LED Indicators - Reader Operational	15
LED Indicators - Tag Successfully Read	15
Digital I/O Connector	24
RS-232 Connector	25
RS-485 Connector	26

1

Introduction

This chapter provides a general description of the SARS MP9111. Topics discussed in this chapter include the following:

- Unpacking the Reader
- About the SARS MP9111
- Features
- Applications
- Physical Description

Unpacking the Reader

After opening the shipping container perform the following:

1. Unpack the contents of the shipping container.
2. Inspect the shipping container for damage. If damaged, notify the carrier and SAMSys Technologies. Keep the shipping materials for inspection by the carrier.
3. Verify your reader package includes the following items:
 - SARS MP9111 125 KHz Proximity Reader
 - 12 Vdc Power Supply
 - One or more communication cables (RS-232, RS-485)

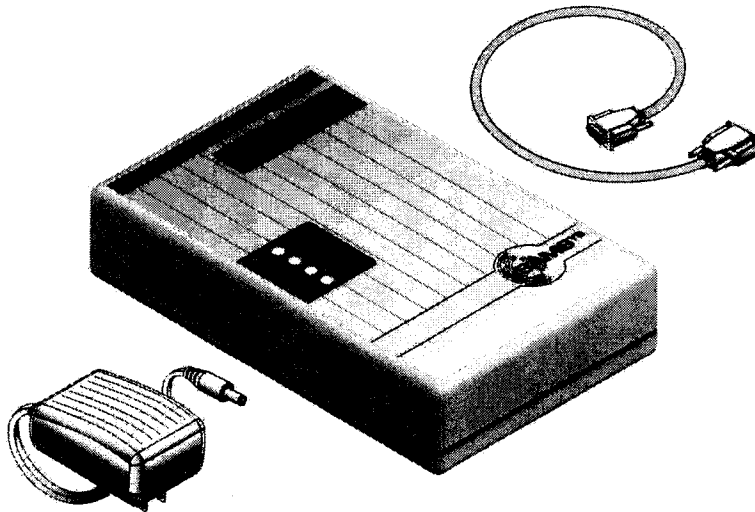

Figure 1: Reader and Accessories

About the SARS MP9111

The MP9111 is one of the most advanced 125 KHz proximity readers in the industry. This multi-protocol device supports many of today's most popular RFID tags including:

- Atmel (Temic) 5550
- EM Marin H4102
- Texas Instruments TIRIS

The MP9111 also supports anti-collision tag protocols including:

- EM 4025
- Philips Hitag 1

The MP9111 recognizes multiple protocols simultaneously during operation. With full-duplex capability, the device can read or write to any tag, depending on the capabilities of the tag.

Features

The MP9111 includes the following features:

- LED indicators
- Integrated antenna
- Multiple interface connection options (RS-232, RS-485)
- Digital input and output lines
- On-board storage
- Multi-protocol architecture
- Read and write capabilities
- Integrated real-time clock with battery backup (optional)
- On-board temperature sensor (optional)

Applications

The MP9111 can be used in a stand-alone type operation, where the application is built into the reader. The reader can also be used in a network of SARS readers connected to a concentrator for warehouse tracking or similar applications.

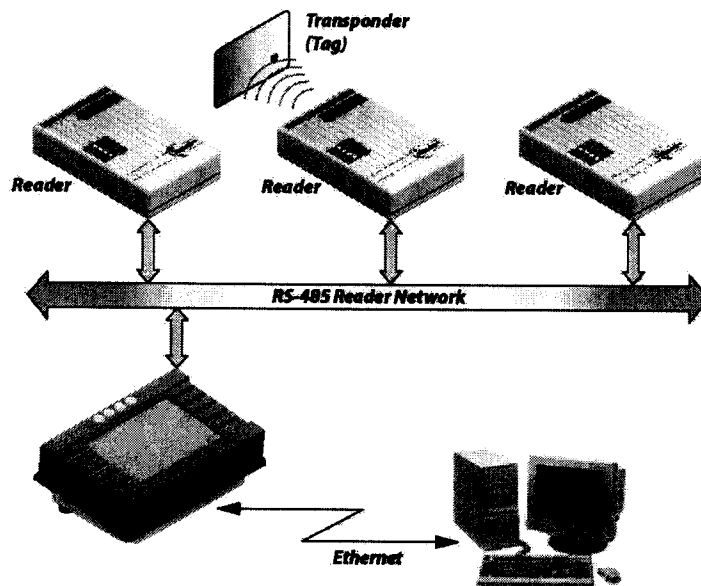

Figure 2: SARS Reader Network

In all of these cases, the reader can be used as an OEM board within the enclosure of other equipment or with its own enclosure.

Physical Description

The MP9111 consists of an RF reader board housed in an ABS plastic case. The board contains the microprocessor, RF circuits, and the digital signal processing circuits. The integral antenna is embedded in the board.

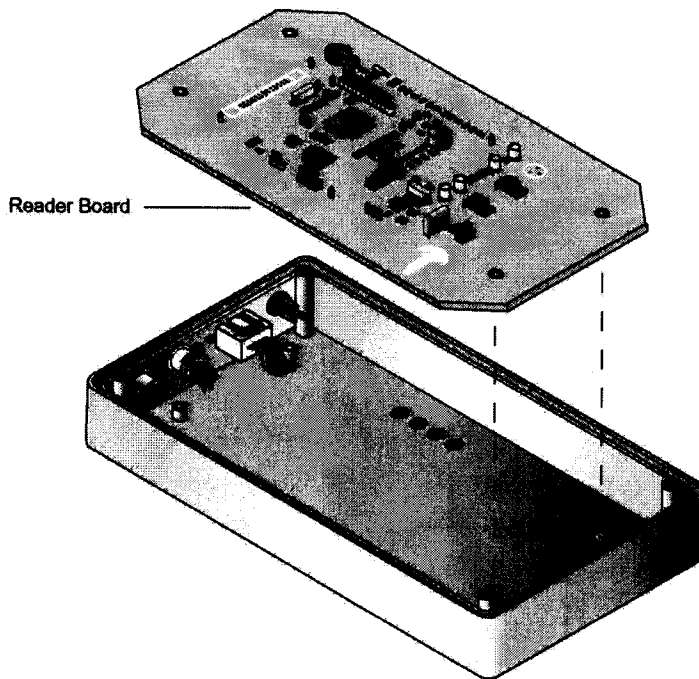

Figure 3: Reader Board and Enclosure

Note:

The reader enclosure is designed for office, indoor warehouse, and light manufacturing areas. If a sealed or explosion proof reader is required for wet or hazardous environments, contact your SAMSys representative.

SARS MP9111 Owner's Manual

The reader board contains four LED indicators to provide the operational status of the reader. The LEDs are visible on the front panel of the reader.

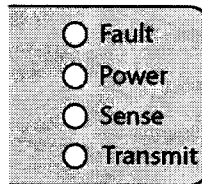

Figure 4: Reader LED Indicators

Indicator	Color	Description
Fault	Red	Read error occurred
Power	Yellow	Reader power-up test successful
Sense	Green	Tag data read successfully
Transmit	Green	Actively seeking tag data

The reader also has four power and communication interface connectors on the end panel.

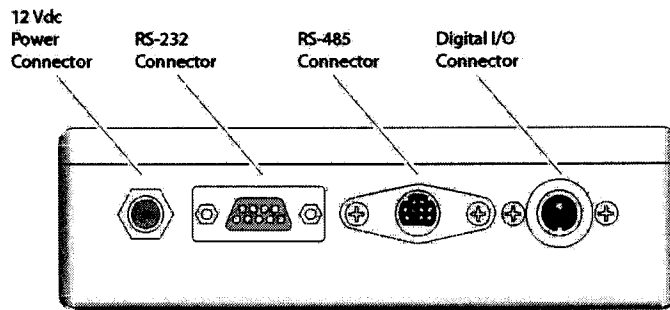

Figure 5: Reader End-Panel Connectors

2

Installation

This chapter provides information for installing the SARS MP9111. Topics discussed in this chapter include the following:

- Reader Installation
- RS-232 Communication Setup
- RS-485 Communication Setup
- Digital (TTL) Input/Output Setup

Reader Installation

The MP9111 is designed for easy installation. The following instructions provide the information to install your SARS reader.

As shown in Figure 6, the reader is designed for horizontal installation and has four rubber pads on the back panel to prevent slippage.

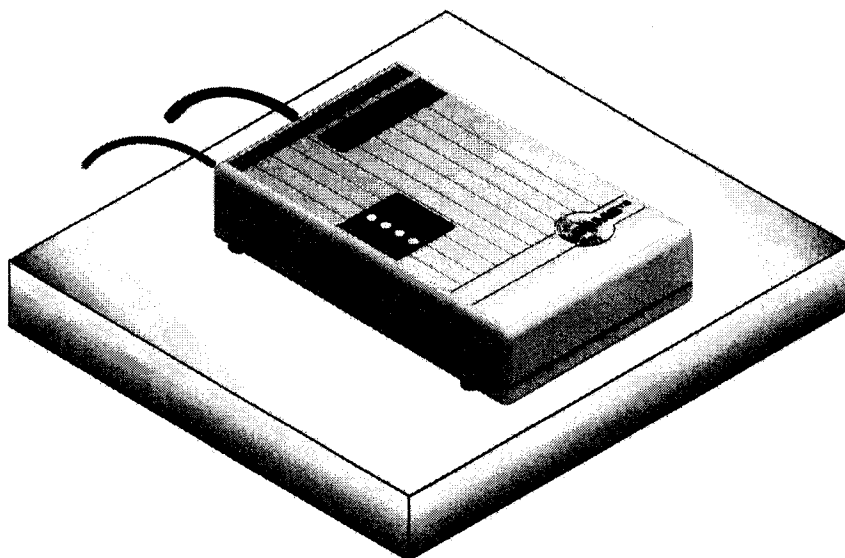
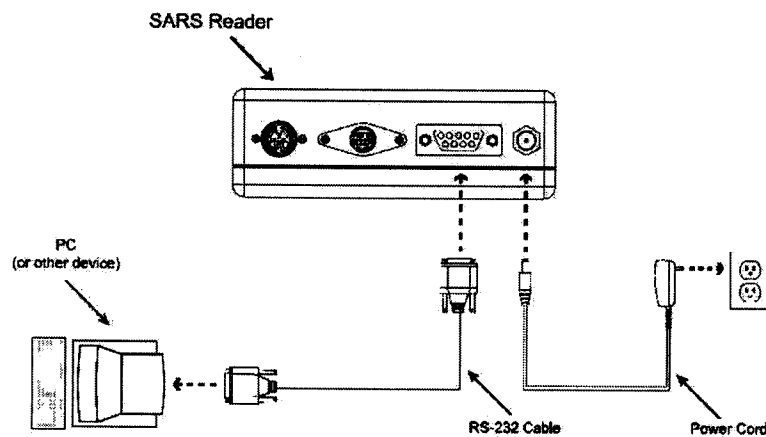

Figure 6: Horizontal Surface Installation

The reader can also be mounted on a wall or other vertical surface. If a vertical surface mount is required, contact your SAMSys representative for mounting hardware and instructions.

RS-232 Communication Setup

The reader is equipped with a 9-pin RS-232 communication port for communication directly with a PC or other serial device.



To set up a reader network with RS-232 communications, perform the following steps:

1. Insert the 9-pin male plug on the RS-232 cable into the 9-pin female connector on the end panel of the reader.
2. Insert the 9-pin female plug into the 9-pin serial port of a PC or other device.

Note: A serial port adapter may be required if the device has a different connector type. For example, some PCs may have 25-pin serial connectors.

3. Insert the AC adapter into a power outlet.
4. Insert the power supply cable into the power connector.

Refer to the *SAMSys Multi-Protocol Reader Programmer's Guide* for more information on configuring your reader.

RS-485 Communication Setup

The MP9111 communicates with the SAMSys Interrogator Control and Concentrator Module (ICCM) using an RS-485 interface. To set up a reader network with RS-485 communications, perform the following steps:

1. Insert the 3-pin male plug on the RS-485 cable into the 3-pin connector on the end panel of the reader.
2. Insert the 25-pin female plug on the RS-485 cable into the 25-pin connector on the ICCM.
3. Insert the AC adapter into a power outlet.
4. Insert the power supply cable into the power connector on the end panel of the reader.

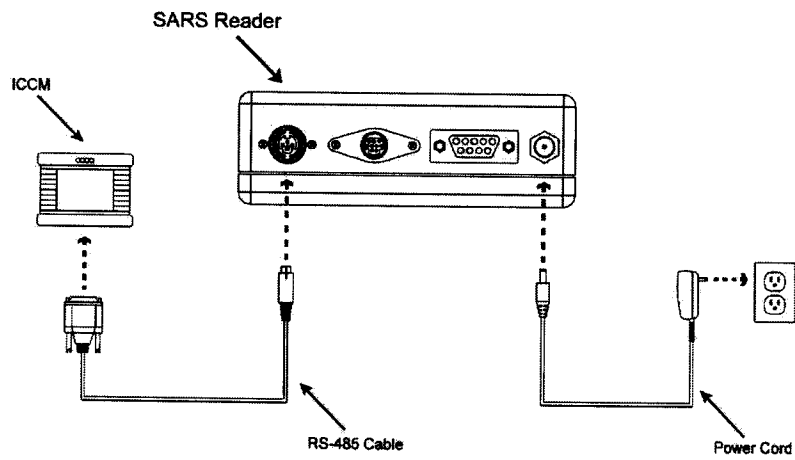

Figure 7: RS-485 Cable Installation

Digital (TTL) Input/Output Setup

The MP9111 is equipped with a digital I/O port that provides four logic-level (TTL) input signals and four output signals. This port can be programmed for specific applications using the FORTH interpreter built into the reader.

SARS MP9111 Owner's Manual

3

Operation

This chapter provides general information to operate the MP9111. Topics discussed in this chapter include the following:

- Reader Power Up
- Reading Tags
- Operation with the ICCM
- Operation with a Terminal Emulation Program

Reader Power Up

When the power supply is connected, the reader produces an extended beep while each LED indicator flashes briefly in sequence. The reader is operational when the **Power** and **Transmit** LEDs remain on.

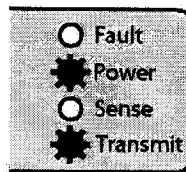

Figure 8: LED Indicators - Reader Operational

Reading Tags

After power up, the reader begins transmitting at the specified frequency. When a tag is placed within range, the reader activates the tag and reads the data. The **Sense** LED flashes when the tag is successfully read.

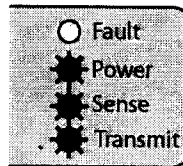

Figure 9: LED Indicators - Tag Successfully Read

Operation with the ICCM

The ICCM provides greater flexibility for accessing readers. With the ICCM, you can access your RFID data with your own client/server applications, perform administrative functions from an easy-to-use Web interface, perform debug activities on your readers remotely, and much more.

The ICCM also has a VGA touch screen LCD. The LCD can be used to provide an operator interface for applications running directly on the ICCM. This allows for local access to RFID data and applications in environments where a remote application server is not available or required.

The ICCM includes an integrated 10baseT Ethernet LAN interface. You can use the Ethernet connection to establish communication between your reader and a LAN-attached application server.

Contact your SAMSys representative for more information on the ICCM product or visit the SAMSys web site at www.samsys.com.

Operation with a Terminal Emulation Program

In addition to the ICCM, a terminal emulation program such as HyperTerminal® can be used to communicate directly with the reader. With the terminal emulation program, the user can view reader data, issue commands to the reader interface, upgrade the reader firmware, and perform debug and performance testing.

4

Troubleshooting

This chapter provides general information to troubleshoot the MP9111. Topics discussed in this chapter include the following:

- General Troubleshooting
- Contact Us

General Troubleshooting

SAMSys readers are designed, manufactured, and tested to provide many years of trouble-free service. However, in the event of a reader malfunction or failure, refer to the following troubleshooting instructions to help identify and correct the problem.



Warning - Electric Shock Hazard

The following procedures involve AC voltage. Use extreme caution when measuring voltage or installing cables and power supplies. Serious injury or death may occur if proper precautions are not observed.



Caution - ESD

The following procedures involve electrostatic discharge sensitive components. ESD protection is required. Damage to the reader can occur if proper ESD equipment such as grounded wrist straps and ESD protected work surfaces are not used.

Symptom	Probable Cause	Corrective Action
No LEDs or buzzer during power up.	Power supply malfunction.	Ensure power supply is inserted into wall outlet. Verify correct operating voltage at outlet. Replace Power Supply.
	Reader software is corrupt.	Replace reader.
Reader appears to lock up.	Readers are vulnerable to high ESD pulses. As a result, the reader can lock up.	Disconnect the power from the reader and reconnect. The reader should reset. If the reader does not function normally after reset, replace the reader.
Any LED fails and buzzer alarms during power up.	Suspect LED bad.	Reader may operate normally with one or more bad LEDs, but the reader should be replaced as soon as possible.
	Reader board failure.	If reader does not read or write, replace the reader.
No buzzer on power up.	Buzzer malfunction.	Reader may operate normally without buzzer, but the reader should be replaced as soon as possible.
	Reader board failure.	If reader does not read or write, replace the reader.
	Reader software is corrupt.	Replace reader.

SARS MP9111 Owner's Manual

Symptom	Probable Cause	Corrective Action
No buzzer when reading a tag.	Buzzer malfunction.	Reader may operate normally without buzzer, but the reader should be replaced as soon as possible.
	Reader board failure.	If the reader does not read or write, replace the reader.
	Reader software is corrupt.	Replace reader.
No RS-232 Communication.	External RS-232 cable malfunction	Check cable connectors for bent or broken pins. Replace external RS-485 cable if necessary.
	Internal RS-232 cable disconnected or reversed.	Remove back cover and reconnect internal cable.
	Reader board failure.	Replace reader.
No RS-485 Communication.	External RS-485 cable malfunction	Check cable connectors for bent or broken pins. Replace external RS-485 cable if necessary.
	Internal RS-485 cable disconnected or reversed.	Remove back cover and reconnect internal cable.
	Reader board failure.	Replace reader.
No Digital I/O signals present.	Internal digital I/O cable disconnected or reversed.	Remove back cover and reconnect cable.
	Reader board failure.	Replace reader.

Symptom	Probable Cause	Corrective Action
Tag ID/data is different from expected value.	Reader software version.	Program reader with latest software version release.
	Electromagnetic interference.	Shield or reposition reader
Tag read failure.	Read range exceeded.	Reader range is 6 inches (15.24 cm). Reposition reader or tag.
	Tag speed exceeded.	Slow tag when within range of reader.
	Faulty tag.	Verify reader operation with a known good tag.

Contact Us

For any questions regarding products and services, including returns, repairs, technical support, training, and all other available services, contact your distributor or SAMSys Customer Service at the following:

E-mail	support@samsys.com
Telephone	1-877-367-4342 (toll free) 8:00am-6:00pm EST, Mon-Fri
Fax	1-919-281-1551

5

Specifications

This chapter describes the specifications for the MP9111. Information provided includes the following:

- Reader Specifications
- Environmental Specifications
- Power Supply Specifications
- Digital I/O Connector Specifications
- RS-232 Connector Specifications
- RS-485 Connector Specifications

Reader Specifications

Range	Up to 6 inches (15.24 cm)
Frequency	125 KHz
Sensitivity	1 mVpp at the input to the receiver circuit
Antenna Drive Current	200 mW
Connections	RS-232, RS-485, Digital I/O (TTL) or Wiegand
Input Voltage	12 Vdc +/-5%
Input Current	0.5 A maximum

Environmental Specifications

Operating Temperature	32° F to 158° F (0° C to 70° C)
Maximum Operating Vibration	0.25 G from 3 Hz to 200 Hz
Storage Temperature	-67° F to 257° F (-55° C to 125° C)
Maximum Storage Vibration	0.5 G from 3 Hz to 200 Hz
Maximum Shock	3 foot (0.92 meter) drop to any corner
Relative Humidity	20% to 80% non-condensing
Case Material	Flame-retardant ABS plastic
Case Dimensions	8.66 x 5.51 x 1.58 in (22.00 x 14.00 x 4.05 cm)
Weight	12.8 oz (362.88 g)

Power Supply Specifications

Input Voltage	100 – 240 VAC
Input Consumption	0.3 A, 31 – 45 VA
Input Frequency	50 – 60 Hz
Output Voltage	12 VDC
Output Current	1 A

Digital I/O Connector Specifications

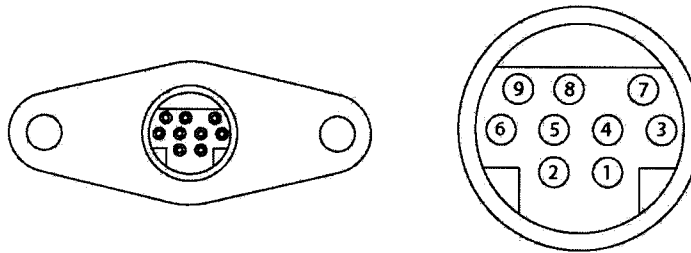

Figure 10: Digital I/O Connector

Pin 1	Input common for pins 2, 3, 4, 5 (<80 Vdc)
Pin 2	Digital input
Pin 3	Digital input
Pin 4	Digital input
Pin 5	Digital input
Pin 6	+5 Vdc digital output
Pin 7	+5 Vdc digital output
Pin 8	+5 Vdc digital output
Pin 9	+5 Vdc digital output
Shield	GND

RS-232 Connector Specifications

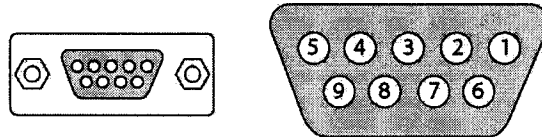

Figure 11: RS-232 Connector

Baud rate	9600	—
Parity	None	—
Data bits	8	—
Stop bits	1	—
Pin 1	CNVSS	Normally low. High puts reader in programming mode.
Pin 2	ETxD1	TXD
Pin 3	ERxD1	RXD
Pin 4	Shorted to pin 6 (DTR)	DTR
Pin 5	GND	GND
Pin 6	Shorted to pin 4 (DSR)	DSR
Pin 7	ECTS1	CTS
Pin 8	ERST1	RTS
Pin 9	+5 Vdc	+5 Vdc

RS-485 Connector Specifications

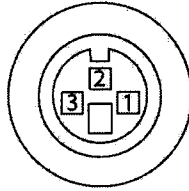
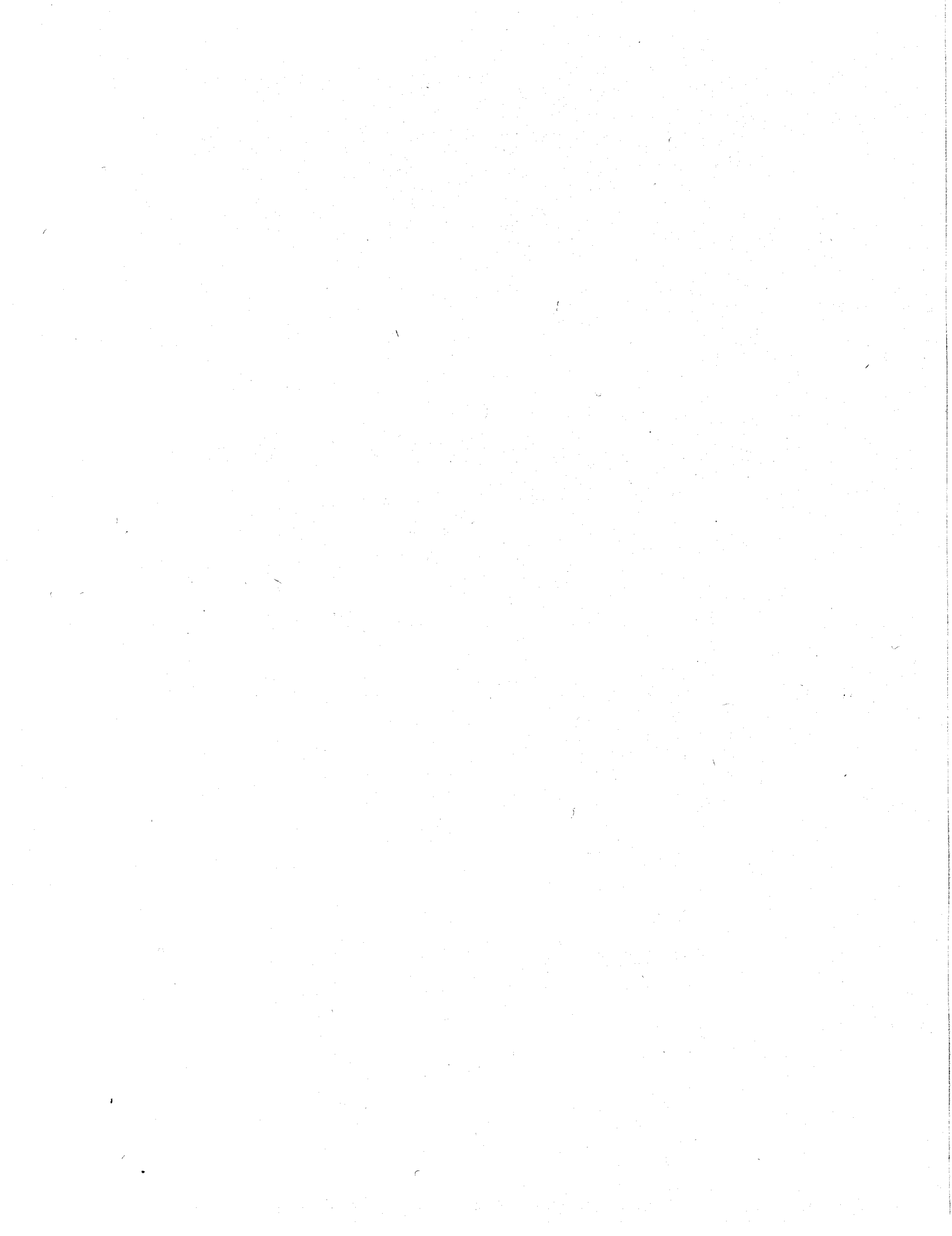

Figure 12: RS-485 Connector

Pin 1	RS-485 Phase A
Pin 2	RS-485 Phase B
Pin 3	RS-485 Phase C (common)



SAMSys Technologies, Inc.

Part Number: HI469-111-OM-V2
Printed in U.S.A.