

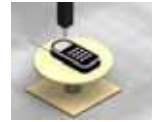

# PCTEST ENGINEERING LABORATORY, INC.

6660-B Dobbin Road, Columbia, MD 21045 USA  
Tel. 410.290.6652 / Fax 410.290.6554  
<http://www.pctestlab.com>



## HEARING AID COMPATIBILITY CERTIFICATE

**Applicant Name:**  
Nokia Inc.  
12278 Scripps Summit Drive  
San Diego, CA 92131-3697  
United States

**Date of Testing:**  
June 19 - 21, 2006  
**Test Site/Location:**  
PCTEST Lab, Columbia, MD, USA  
**Test Report Serial No.:**  
0606140494-R2

<b>FCC ID:</b>	<b>QMNRM-125</b>
<b>APPLICANT:</b>	<b>NOKIA INC.</b>

**Scope of Test:** Audio Band Magnetic Testing (T-Coil)  
**Application Type:** Class II Permissive Change  
**FCC Rule Part(s):** § 20.19(b), §6.3(v), §7.3(v)  
**HAC Standard:** ANSI C63.19-2006 v3.12  
**FCC Classification:** Licensed Transmitter Held to Ear (PCE)  
**EUT Type:** Tri-Mode Dual-Band Analog/PCS Phone with Bluetooth  
**Model(s):** 6165i  
**Tx Frequency:** 824.04 - 848.97 MHz (AMPS)  
824.70 - 848.31 MHz (Cellular CDMA)  
1851.25 - 1908.75 MHz (PCS CDMA)  
**Test Device Serial No.:** *Pre-Production Sample* [S/N: 215BA0A8]  
**Class II Permissive Change(s):** Adding T-Coil Rating

<b>C63.19 HAC Rated Category:</b>	<b>T4 (T-COIL RATING ONLY)</b>
-----------------------------------	--------------------------------

This wireless portable device has been shown to be hearing-aid compatible under the above rated category, specified in ANSI/IEEE Std. C63.19 and had been tested in accordance with the specified measurement procedures. The RF Emissions for this device was M3 and is covered under a separate test report. Hearing-Aid Compatibility is based on the assumption that all production units will be designed electrically identical to the device tested in this report.

I attest to the accuracy of data. All measurements reported herein were performed by me or were made under my supervision and are correct to the best of my knowledge and belief. I assume full responsibility for the completeness of these measurements and vouch for the qualifications of all persons taking them.

**NOTE: This revised Test Report (S/N: 0606140494-R2 ) supersedes and replaces the previously-issued test report on the same subject EUT for the same type of testing as indicated. Please discard or destroy the previously issued report (S/N: 0606140494-R1) and dispose of it accordingly.**

*PCTEST certifies that no party to this application has been denied the FCC benefits pursuant to Section 5301 of the Anti-Drug Abuse Act of 1988, 21 U.S.C. 862.*

Randy Ortanez  
President





FCC ID: QMNRM-125		C63.19-2006 v3.12 §6 HAC TEST REPORT		Reviewed by: Quality Manager
Filename: 0606140494-R2	Test Dates: June 19 - 21, 2006	EUT Type: Tri-Mode Dual-Band Analog/PCS Phone with Bluetooth	Page 1 of 39	

# TABLE OF CONTENTS

---

1.	INTRODUCTION .....	3
2.	TEST SITE LOCATION .....	4
3.	EUT DESCRIPTION .....	5
4.	ANSI/IEEE C63.19 PERFORMANCE CATEGORIES .....	6
5.	METHOD OF MEASUREMENT .....	9
6.	SYSTEM SPECIFICATIONS.....	18
7.	TEST SUMMARY .....	21
8.	FCC 3G MEASUREMENTS – MAY 2006 .....	24
9.	MEASUREMENT UNCERTAINTY .....	25
10.	EQUIPMENT LIST.....	26
11.	CALIBRATION CERTIFICATES.....	27
12.	CONCLUSION.....	35
13.	REFERENCES .....	36
14.	TEST SETUP PHOTOGRAPHS .....	38

<b>FCC ID:</b> QMNRM-125		<b>C63.19-2006 v3.12 §6 HAC TEST REPORT</b>		<b>Reviewed by:</b> Quality Manager
<b>Filename:</b> 0606140494-R2	<b>Test Dates:</b> June 19 - 21, 2006	<b>EUT Type:</b> Tri-Mode Dual-Band Analog/PCS Phone with Bluetooth		Page 2 of 39

# 1. INTRODUCTION

On July 10, 2003, the Federal Communications Commission (FCC) adopted new rules requiring wireless manufacturers and service providers to provide digital wireless phones that are compatible with hearing aids. The FCC has modified the exemption for wireless phones under the Hearing Aid Compatibility Act of 1998 (HAC Act) in WT Docket 01-309 RM-8658<sup>1</sup> to extend the benefits of wireless telecommunications to individuals with hearing disabilities. These benefits encompass business, social and emergency communications, which increase the value of the wireless network for everyone. An estimated more than 10% of the population in the United States show signs of hearing impairment and of that fraction, almost 80% use hearing aids. Approximately 500 million people worldwide suffer from hearing loss.

## Compatibility Tests Involved:

The standard calls for wireless communications devices to be measured for:

- RF Electric-field emissions
- RF Magnetic-field emissions
- T-coil mode, magnetic-signal strength in the audio band
- T-coil mode, magnetic-signal frequency response through the audio band
- T-coil mode, magnetic-signal and noise articulation index

The hearing aid must be measured for:



- RF immunity in microphone mode
- RF immunity in T-coil mode

In the following tests and results, this report includes the evaluation for a wireless communications device.



Figure 1-1 Hearing Aid *in-vitu*

<sup>1</sup> FCC Rule & Order, WT Docket 01-309 RM-8658

FCC ID: QMNRM-125	 PCTEST	C63.19-2006 v3.12 §6 HAC TEST REPORT	 NOKIA	Reviewed by: Quality Manager
Filename: 0606140494-R2	Test Dates: June 19 - 21, 2006	EUT Type: Tri-Mode Dual-Band Analog/PCS Phone with Bluetooth		Page 3 of 39

## 2. TEST SITE LOCATION

### I. Introduction

The map at the right shows the location of the PCTEST LABORATORY in Columbia, Maryland. It is in proximity to the FCC Laboratory, the Baltimore-Washington International (BWI) airport, the city of Baltimore and Washington, DC (See Figure 2).

These measurement tests were conducted at the PCTEST Engineering Laboratory, Inc. facility in New Concept Business Park, Guilford Industrial Park, Columbia, Maryland. The site address is 6660-B Dobbin Road, Columbia, MD 21045. The test site is one of the highest points in the Columbia area with an elevation of 390 feet above mean sea level. The site coordinates are 39° 11'15" N latitude and 76° 49' 38" W longitude. The facility is 1.5 miles north of the FCC laboratory, and the ambient signal and ambient signal strength are approximately equal to those of the FCC laboratory. There are no FM or TV transmitters within 15 miles of the site. The detailed description of the measurement facility was found to be in compliance with the requirements of § 2.948 according to ANSI C63.4 on October 19, 2002.





**Figure 2-1**  
**Map of the Greater Baltimore and Metropolitan Washington, D.C. Area**

### II. Test Facility / A2LA Accreditation:

Measurements were performed at an independent accredited PCTEST Engineering Lab located in Columbia, MD 21045, U.S.A.



- PCTEST facility is an FCC registered (PCTEST Reg. No. 90864) test facility with the site description report on file and has met all the requirements specified in Section 2.948 of the FCC Rules and Industry Canada (IC 2451).
- PCTEST Lab is accredited to ISO 17025 by U.S. National Institute of Standards and Technology (NIST) under the National Voluntary Laboratory Accreditation Program (NVLAP Lab code: 100431-0) in EMC, FCC and Telecommunications.
- PCTEST Lab is accredited to ISO 17025 by the American Association for Laboratory Accreditation (A2LA) in Specific Absorption Rate (SAR) testing, CTIA Test Plans, and wireless testing for FCC, HAC, CTIA OTA and Industry Canada Rules.
- PCTEST Lab is a recognized U.S. Conformity Assessment Body (CAB) in EMC and R&TTE (n.b. 0982) under the U.S.-EU Mutual Recognition Agreement (MRA).
- PCTEST TCB is a Telecommunication Certification Body (TCB) accredited to ISO/IEC Guide 65 by the American National Standards Institute (ANSI) in all scopes of FCC Rules.
- PCTEST facility is an IC registered (IC-2451) test laboratory with the site description on file at Industry Canada.
- PCTEST is a CTIA Authorized Test Laboratory (CATL) in AMPS and CDMA mobile phones.

FCC ID: QMNRM-125		C63.19-2006 v3.12 §6 HAC TEST REPORT		Reviewed by: Quality Manager
Filename: 0606140494-R2	Test Dates: June 19 - 21, 2006	EUT Type: Tri-Mode Dual-Band Analog/PCS Phone with Bluetooth	Page 4 of 39	

### 3. EUT DESCRIPTION



FCC ID: QMNRM-125  
 Manufacturer: Nokia Inc.  
 12278 Scripps Summit Drive  
 San Diego, CA 92131-3697  
 United States

Trade Name: Nokia  
 Model(s): 6165i  
 Serial Number: 215BA0A8  
 Tx Frequencies: 824.04 - 848.97 MHz (AMPS)  
 824.70 - 848.31 MHz (Cellular CDMA)  
 1851.25 - 1908.75 MHz (PCS CDMA)

HW Version: 5001  
 SW Version: V AZ100C0012.nep  
 Code Version: 0530279BN16MM

Maximum Conducted Power (EMC/SAR):

CDMA Mode			PCS Mode		
Ch1013	Ch384	Ch777	Ch25	Ch600	Ch1175
25.1 dBm	25.2 dBm	25.2 dBm	22.8 dBm	22.9 dBm	22.9 dBm
24.8 dBm	24.8 dBm	24.9 dBm	22.7 dBm	22.8 dBm	22.9 dBm

Maximum Conducted Power (HAC):

HAC Test Configurations: CDMA Mode, Channels 1013, 384, 777, BT Off  
 PCS CDMA, Channels 25, 600, 1175, BT Off

FCC Classification: Licensed Transmitter Held to Ear (PCE)  
 EUT Type: Tri-Mode Dual-Band Analog/PCS Phone with Bluetooth

FCC ID: QMNRM-125	PCTEST	C63.19-2006 v3.12 §6 HAC TEST REPORT	NOKIA	Reviewed by: Quality Manager
Filename: 0606140494-R2	Test Dates: June 19 - 21, 2006	EUT Type: Tri-Mode Dual-Band Analog/PCS Phone with Bluetooth	Page 5 of 39	

## 4. ANSI/IEEE C63.19 PERFORMANCE CATEGORIES

### I. RF EMISSIONS

The ANSI Standard presents performance requirements for acceptable interoperability of hearing aids with wireless communications devices. When these parameters are met, a hearing aid operates acceptably in close proximity to a wireless communications device.



Category	Telephone RF Parameters	
Near field Category	E-field emissions CW dB(V/m)	H-field emissions CW dB(A/m)
<b>f &lt; 960 MHz</b>		
<b>M1</b>	56 to 61 + 0.5 x AWF	5.6 to 10.6 +0.5 x AWF
<b>M2</b>	51 to 56 + 0.5 x AWF	0.6 to 5.6 +0.5 x AWF
<b>M3</b>	46 to 51 + 0.5 x AWF	-4.4 to 0.6 +0.5 x AWF
<b>M4</b>	< 46 + 0.5 x AWF	< -4.4 + 0.5 x AWF
<b>f &gt; 960 MHz</b>		
<b>M1</b>	46 to 51 + 0.5 x AWF	-4.4 to 0.6 +0.5 x AWF
<b>M2</b>	41 to 46 + 0.5 x AWF	-9.4 to -4.4 +0.5 x AWF
<b>M3</b>	36 to 41 + 0.5 x AWF	-14.4 to -9.4 +0.5 x AWF
<b>M4</b>	< 36 + 0.5 x AWF	< -14.4 + 0.5 x AWF

**Table 4-1**  
Hearing aid and WD near-field categories as defined in ANSI C63.19-2006 v3.12 [2]

### II. ARTICULATION WEIGHTING FACTOR (AWF)

Standard	Technology	Articulation Weighing Factor (AWF)
T1/T1P1/3GPP	UMTS (WCDMA)	0
IS-95	CDMA	0
iDEN™	TDMA (22 and 11 Hz)	0
J-STD-007	GSM (217 Hz)	-5

Table 6.2  
AWF has been developed from information presented to the committee regarding the interference potential of the various modulation types according to ANSI C63.19

FCC ID: QMNRM-125	 PCTEST	C63.19-2006 v3.12 §6 HAC TEST REPORT	 NOKIA	Reviewed by: Quality Manager
Filename: 0606140494-R2	Test Dates: June 19 - 21, 2006	EUT Type: Tri-Mode Dual-Band Analog/PCS Phone with Bluetooth	Page 6 of 39	

### III. MAGNETIC COUPLING

#### Axial Field Intensity

The axial component of the magnetic field, directed along the measurement axis and located at the measurement plane, shall be  $\geq -13$  dB(A/m) at 1 kHz.

#### Radial Field Intensity

The radial components of the magnetic field, in the horizontal and vertical position along the measurement plane shall be both  $\geq -18$  dB(A/m) at 1 kHz.

#### Frequency Response

The frequency response of the axial component of the magnetic field shall follow the response curve specified in EIA RS-504-1983, over the frequency range 300 Hz – 3300 Hz

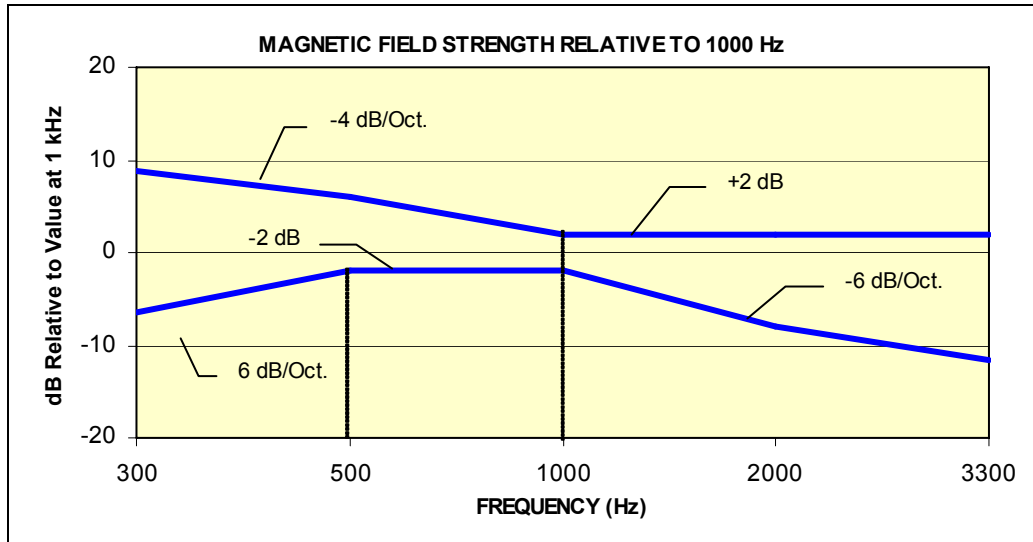

**Figure 4-1**  
Magnetic field frequency response for Wireless Devices with an axial field between -10 dB to -13 dB (A/m) at 1 kHz

FCC ID: QMNRM-125	PCTEST	C63.19-2006 v3.12 §6 HAC TEST REPORT	NOKIA	Reviewed by: Quality Manager
Filename: 0606140494-R2	Test Dates: June 19 - 21, 2006	EUT Type: Tri-Mode Dual-Band Analog/PCS Phone with Bluetooth		Page 7 of 39

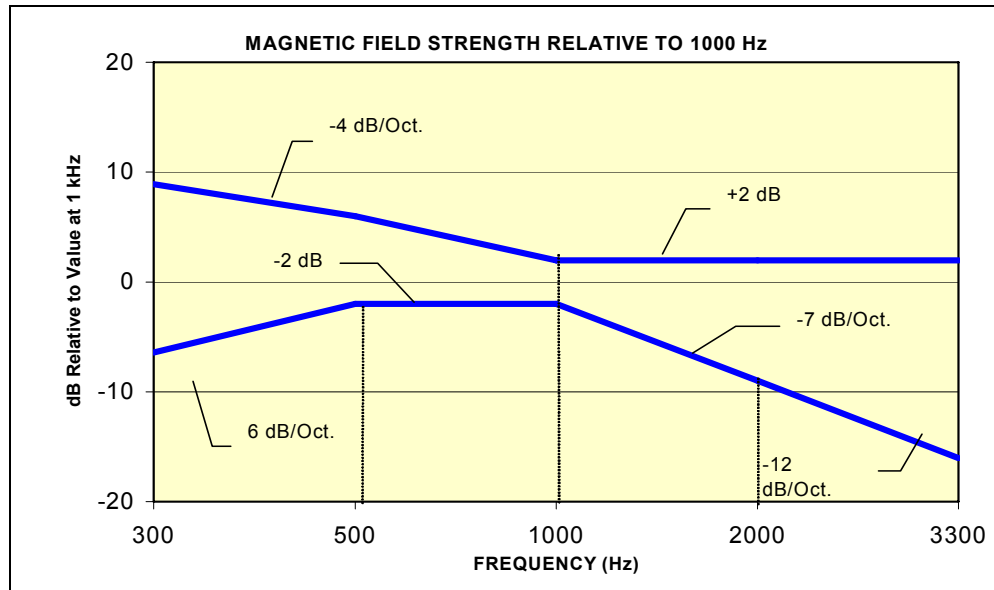

**Figure 4-2**  
Magnetic Field frequency response for wireless devices with an axial field that exceeds  $-10$  dB(A/m) at 1 kHz

### Signal Quality

The table below provides the signal quality requirement for the intended audio magnetic signal from a wireless device. Only the RF immunity of the hearing aid is measured in T-coil mode. It is assumed that a hearing aid can have no immunity to an interference signal in the audio band, which is the intended reception band for this mode. The only criterion that can be measured is the RF immunity in T-coil mode. This is measured using the same procedure as the audio coupling mode at the same levels.

The signal quality of the axial and radial components of the magnetic field was used to determine the T-coil mode category.

A device is classified beginning with its RF emissions category (i.e. M1 through M4). If the device meets the additional requirements here, it qualifies for the T-designation (T1, etc.)

Category	Hearing aid RF Parameters	Telephone RF Parameters
	Near field immunity (w/ 0.6W CW into dipole)	Wireless Device Signal Quality (Signal + Noise-to-noise ratio in dB)
T1	75 to 85 dB (IRIL)	-10 to -20 dB + AWF
T2	65 to 75 dB (IRIL)	0 to -10 dB + AWF
T3	55 to 65 dB (IRIL)	10 to 0 dB + AWF
T4	< 55 dB (IRIL)	> 10 dB + AWF

**Table 4-2 Magnetic Coupling Parameters**

FCC ID: QMNRM-125	PCTEST	C63.19-2006 v3.12 §6 HAC TEST REPORT	NOKIA	Reviewed by: Quality Manager
Filename: 0606140494-R2	Test Dates: June 19 - 21, 2006	EUT Type: Tri-Mode Dual-Band Analog/PCS Phone with Bluetooth		Page 8 of 39



## 5. METHOD OF MEASUREMENT

### I. Test Setup

The equipment was connected as shown in an acoustic/RF hemi-anechoic chamber:

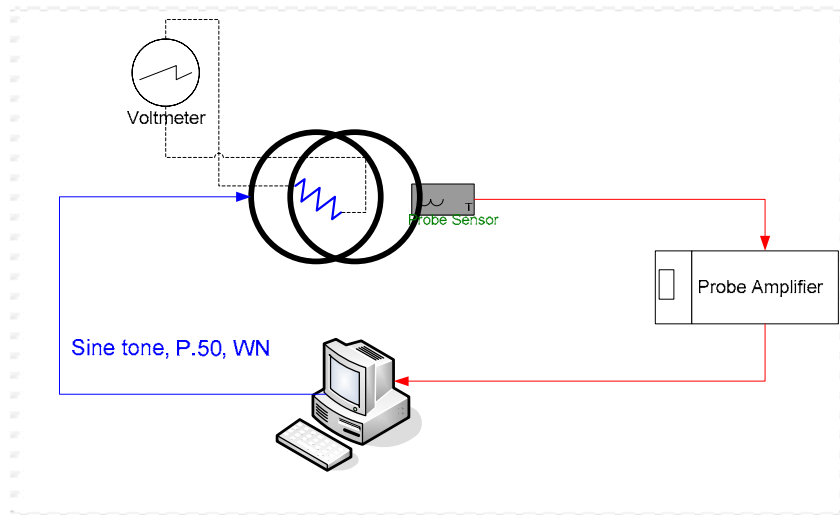

Figure 5-1 Validation Setup with Helmholtz Coil

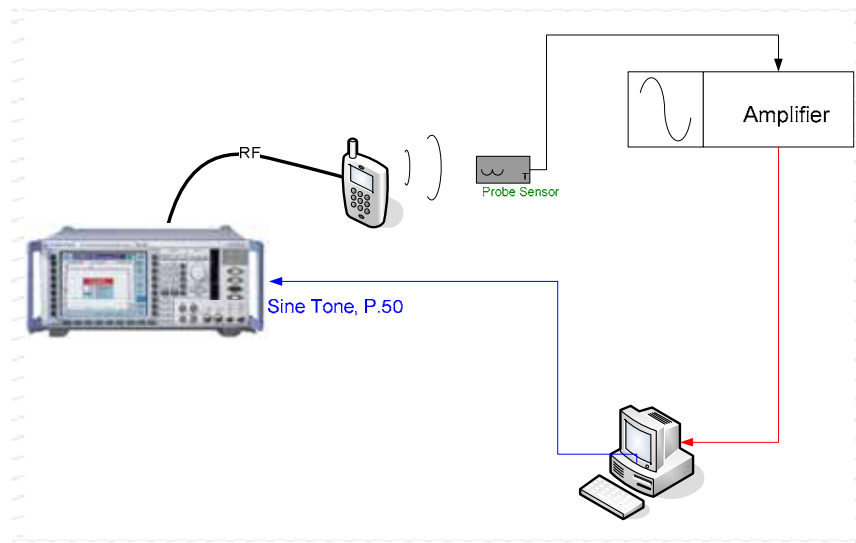

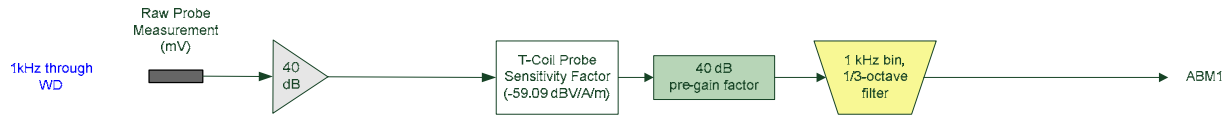

Figure 5-2 T-Coil Test Setup

FCC ID: QMNRM-125		C63.19-2006 v3.12 §6 HAC TEST REPORT		Reviewed by: Quality Manager
Filename: 0606140494-R2	Test Dates: June 19 - 21, 2006	EUT Type: Tri-Mode Dual-Band Analog/PCS Phone with Bluetooth		Page 9 of 39

ABM1 Measurement Block Diagram:



ABM2 Measurement Block Diagram:

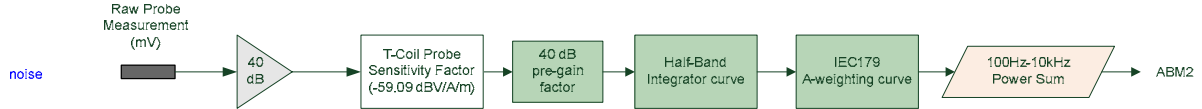

**Figure 5-3 Magnetic Measurement Processing Steps**

## II. Test Procedure

1. Ambient Noise Check per C63.19 §6.2.1
  - a. Ambient interference was monitored using a Real-Time Analyzer between 100-10,000 Hz with 1/3 octave filtering.
  - b. “A-weighting” and Half-Band Integration was applied to the measurements.
  - c. Since this measurement was measured in the same method as ABM2 measurements, this level was verified to be less than 10 dB below the lowest measurement signal (which is the highest ABM2 measurement for a T4 WD). Therefore the maximum noise level for a T4 WD with an ABM1 = -18 dBA/m is:

$$-18 - 10 - 10 + AWF = -38 \text{ dBA/m}$$

2. Measurement System Validation (See Figure 5-1)
  - a. The measurement system including the probe, pre-amplifier and acquisition system were validated as an entire system to ensure the reliability of test measurements.
  - b. ABM1 Validation  
The magnetic field at the center of the Helmholtz coil is given by the equation (per C63.19 Annex D.9.1):



$$H_c = \frac{NI}{r\sqrt{1.25^3}} = \frac{N\left(\frac{V}{R}\right)}{r\sqrt{1.25^3}}$$

Where  $H_c$  = magnetic field strength in amperes per meter  
 $N$  = number of turns per coil

For the Helmholtz Coil,  $N=20$ ;  $r=0.08\text{m}$ ;  $R=10.193\Omega$  and using  $V=57\text{mV}$ :

$$H_c = \frac{20 \cdot \left(\frac{0.057}{10.193}\right)}{0.08 \cdot \sqrt{1.25^3}} = 1.0003 \text{ A/m}$$

Therefore a pure tone of 1kHz was applied into the coils such that 57 mV was observed across the 10 Ω resistor. The voltmeter used for measurement was verified to be capable of measurements in the audio band range. This theoretically generates an expected field of 1 A/m in the center of the Helmholtz coil which was used to validate the probe measurement at 1 A/m. This was verified to be within ± 0.5 dB of the 1 A/m value (see Page 22).

FCC ID: QMNRM-125		C63.19-2006 v3.12 §6 HAC TEST REPORT		Reviewed by: Quality Manager
Filename: 0606140494-R2	Test Dates: June 19 - 21, 2006	EUT Type: Tri-Mode Dual-Band Analog/PCS Phone with Bluetooth		Page 10 of 39

c. Frequency Response Validation

The frequency response through the Helmholtz Coil was verified to be within 0.5 dB relative to 1 kHz, between 300 – 3300 Hz using the ITU-P.50 artificial speech signal as shown below:

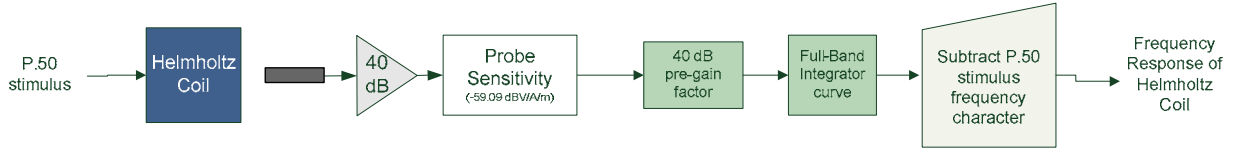

**Figure 5-4 Frequency Response Validation**

d. ABM2 Measurement Validation

WD noise measurements are filtered with A-weighting and Half-Band Integration over a frequency range of 100Hz – 10kHz to process ABM2 measurements. Below is the verification of the system processing A-weighting and Half-Band integration between system input to output within 0.5 dB of the theoretical result:

**Table 5-1  
ABM2 Frequency Response Validation**

f (Hz)	HBI, A - Measured (dB re 1kHz)	HBI, A - Theoretical (dB re 1kHz)	dB Var.
100	-16.180	-16.170	-0.010
125	-13.257	-13.250	-0.007
160	-10.347	-10.340	-0.007
200	-8.017	-8.010	-0.007
250	-5.925	-5.920	-0.005
315	-4.045	-4.040	-0.005
400	-2.405	-2.400	-0.005
500	-1.212	-1.210	-0.002
630	-0.349	-0.350	0.001
800	0.071	0.070	0.001
1000	0.000	0.000	0.000
1250	-0.503	-0.500	-0.003
1600	-1.513	-1.510	-0.003
2000	-2.778	-2.780	0.002
2500	-4.316	-4.320	0.004
3150	-6.166	-6.170	0.004
4000	-8.322	-8.330	0.008
5000	-10.573	-10.590	0.017
6300	-13.178	-13.200	0.022
8000	-16.241	-16.270	0.029
10000	-19.495	-19.520	0.025

FCC ID: QMNRM-125	PCTEST	C63.19-2006 v3.12 §6 HAC TEST REPORT	NOKIA	Reviewed by: Quality Manager
Filename: 0606140494-R2	Test Dates: June 19 - 21, 2006	EUT Type: Tri-Mode Dual-Band Analog/PCS Phone with Bluetooth		Page 11 of 39

ABM2 Frequency Response Validation (LISTEN)

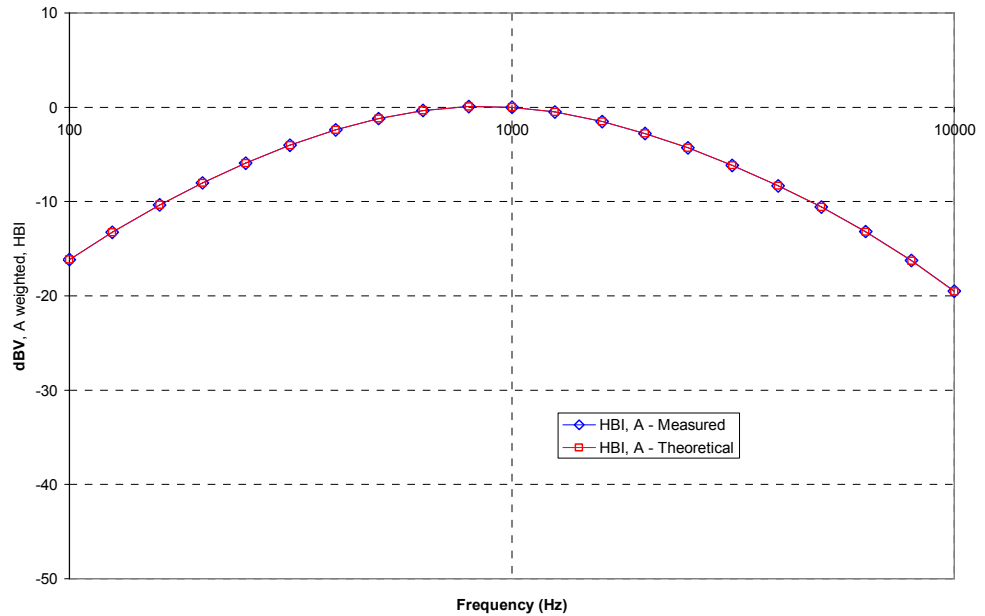



**Figure 5-5**  
**ABM2 Frequency Response Validation**

The ABM2 result is a power sum from 100 Hz to 10 kHz with half-band integration and A-weighting (See Figure 5-3). To verify the power sum measurement, a power sum over the full band was measured and verified to track with the source level. Therefore the setup in this step was used to verify the power sum post-processing for ABM2 measurements.

The power summed output results for a known input were compared to the multi-meter results to verify any deviation in the post-processing implemented with the power-sum.

**Table 5-2**  
**ABM2 Power Sum Validation**

WN Input (dBV)	Power Sum (dBV)	Multimeter-Full (dBV)	Dev (dB)
-60	-60.36	-60.2	0.16
-50	-50.19	-50.13	0.06
-40	-40.14	-40.03	0.11
-30	-30.13	-30.01	0.12
-20	-20.12	-20	0.12
-10	-10.14	-10	0.14

FCC ID: QMNRM-125		C63.19-2006 v3.12 §6 HAC TEST REPORT		Reviewed by: Quality Manager
Filename: 0606140494-R2	Test Dates: June 19 - 21, 2006	EUT Type: Tri-Mode Dual-Band Analog/PCS Phone with Bluetooth	Page 12 of 39	

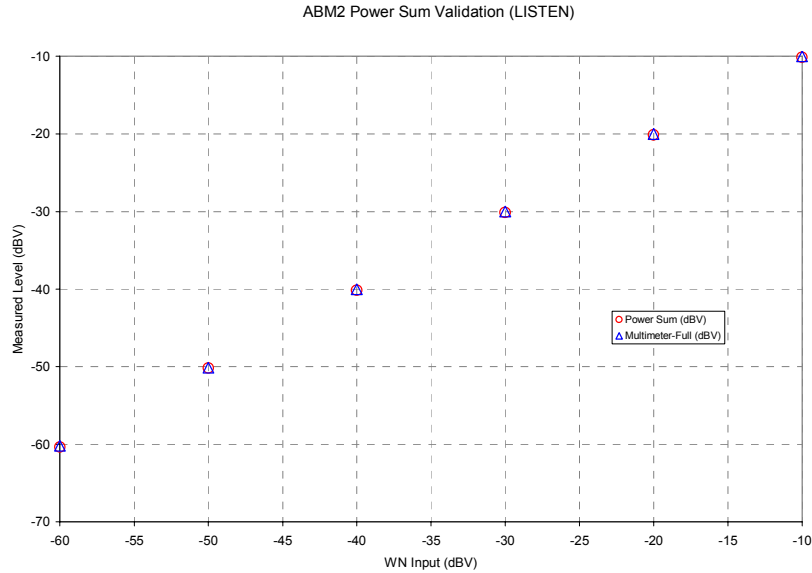

**Figure 5-6**  
**ABM2 Power Sum Validation**

3. Measurement Test Setup

a. Fine scan above the WD (TEM)



- i. A multitone signal was applied to the handset such that the phone acoustic output was stable within 1dB over the probe settling time and with the acoustic output level at the C63.19 specified levels (below). The measurement step size was in 2 mm increments.
- ii. After scanning, the planar field maximum point was determined. The position of the probe was moved to this location to setup the test using the sound check system.
- iii. These steps were repeated for the other T-coil orientations per Figure 5-11 after each T-coil orientation was fully measured with the sound check system.

b. Speech Signal Setup to Base Station Simulator

- i. C63.19 Table 6-1 states audio reference input levels for various technologies:

Standard	Technology	Input Level (dBm0)
TIA/EIA/IS 2000	CDMA	-18
J-STD-007	GSM (217)	-16
T1/T1P1/3GPP	UMTS (WCDMA)	-16
iDEN <sup>TM</sup>	TDMA (22 and 11 Hz)	-18

The CMU200 audio levels were determined using base station simulator manufacturer calibration procedures resulting in the below corresponding voltages relative to handset test point level (in dBm0):

FCC ID: QMNRM-125		C63.19-2006 v3.12 §6 HAC TEST REPORT		Reviewed by: Quality Manager
Filename: 0606140494-R2	Test Dates: June 19 - 21, 2006	EUT Type: Tri-Mode Dual-Band Analog/PCS Phone with Bluetooth		Page 13 of 39

**Table 5-3  
CMU200 Voltage Input Levels for Audio**

dBm0 Ref.	Input Voltage		Notes
3.14 dBm0	1052.0 mV	0.4 dBV	From CDMA2K "DECODER CAL". (What is needed through Encoder for FS)
-18 dBm0	92.260 mV	-20.7 dBV	For 8k Enhanced (Low)

- c. Real-Time Analyzer (RTA)
  - i. The Real-Time Analyzer was configured to analyze measurements using 1/3 Octave band weighted filtering.
- d. WD Radio Configuration Selection
  - i. The device was chosen to be tested in the worst-case noise condition under RC1/SO3 (see below):

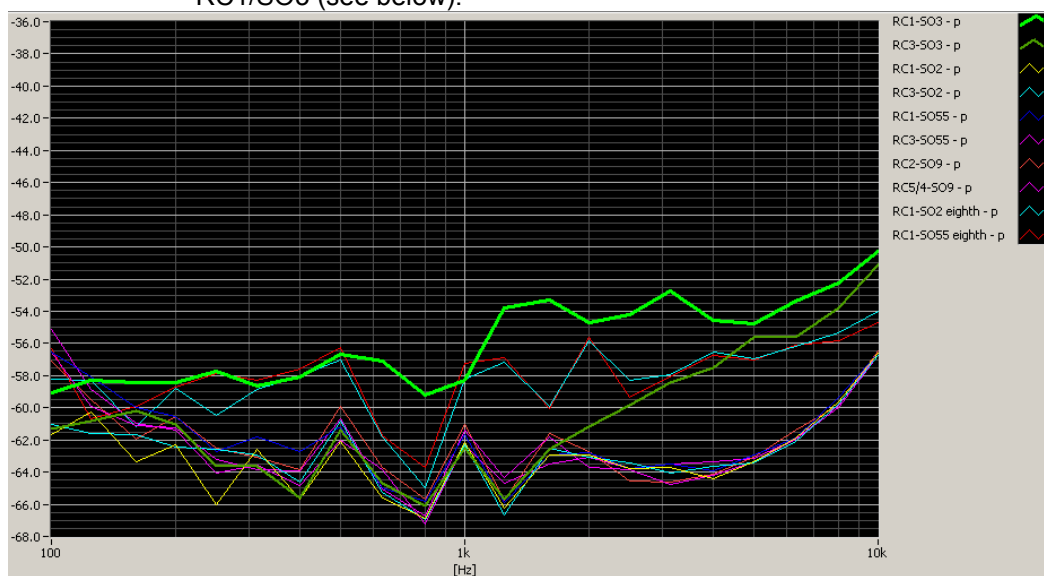

**Figure 5-7  
Vocoder Analysis for ABM Noise**

- 4. Signal Quality Data Analysis
  - a. Narrow-band Magnetic Intensity
    - i. The standard specifies a 1 kHz 1/3 octave band minimum field intensity for a sine tone. The ABM1 measurements were evaluated at 1kHz with 1/3 octave band filtering over an averaged period of 10 seconds.
  - b. Frequency Response
    - i. The appropriate frequency response curve was measured to curves in Figure 4-1 or Figure 4-2 between 300 – 3300 Hz using digital linear averaging (limit lines chosen according to measurement found in step 4a.) A linear average over 3x the length of the artificial voice signal (3x sampling) was performed. A 10 second delay was configured in the measurement process of the stimulus to ensure handset vocoder latency effects and echo cancellation devices (if any) were appropriately stabilized during measurements.
    - ii. The appropriate post-processing was applied according to the system processing chain illustrated in Figure 5-8. All R10 frequencies were plotted with respect to 0dB at 1 kHz value and aligned with respect to the EIA-504 mask.

FCC ID: QMNR-125	PCTEST	C63.19-2006 v3.12 §6 HAC TEST REPORT	NOKIA	Reviewed by: Quality Manager
Filename: 0606140494-R2	Test Dates: June 19 - 21, 2006	EUT Type: Tri-Mode Dual-Band Analog/PCS Phone with Bluetooth	Page 14 of 39	

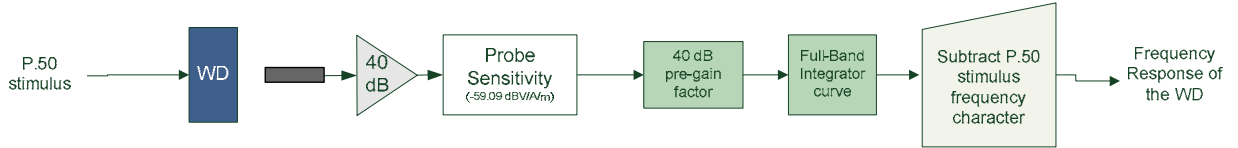

**Figure 5-8 Frequency Response Block Diagram**

- iii. The margin is represented by the closest measured data point on the curve to the EIA-504 limit lines, in dB.
- c. Signal Quality Index
  - i. Ensuring the WD was at maximum RF power, maximum volume, backlight on, display on, maximum contrast setting, keypad lights on (when possible) with no audio signal through the vocoder, the WD was measured over 100 Hz – 10,000 Hz, maximized over 5 seconds for the ABM2 measurement (5 second time period is used in noise measurements under standards such as IEEE 269, etc.)
  - ii. After applying half-band integration and A-weighting to the result, a power sum was applied over each 1/3 octave bandwidth frequency for an ABM2 value
  - iii. This result was subtracted from the ABM1 result in step a, to obtain the Signal Quality.

### III. Test Setup

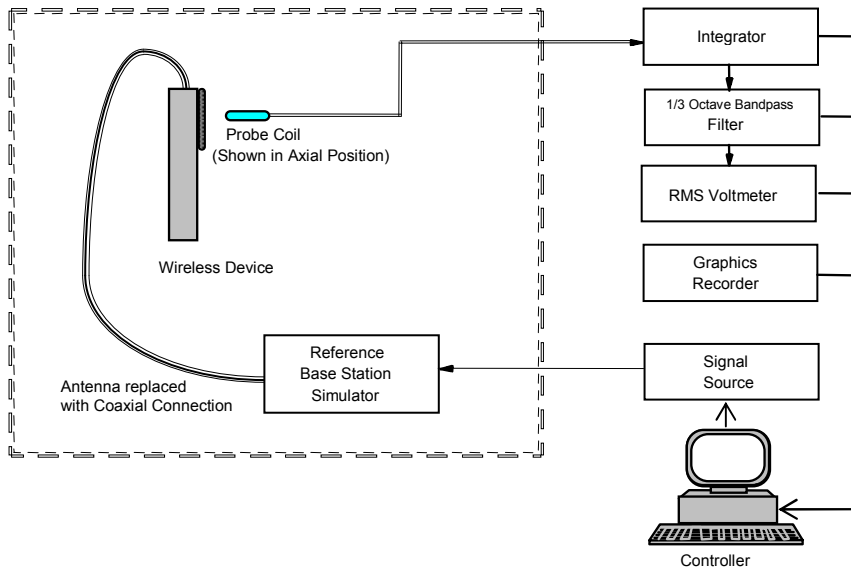

**Figure 5-9 Audio Magnetic Field Test Setup**

### IV. Deviation from C63.19 Test Procedure

Scan increments at 2mm;

FCC ID: QMNRM-125	PCTEST	C63.19-2006 v3.12 §6 HAC TEST REPORT	NOKIA	Reviewed by: Quality Manager
Filename: 0606140494-R2	Test Dates: June 19 - 21, 2006	EUT Type: Tri-Mode Dual-Band Analog/PCS Phone with Bluetooth		Page 15 of 39

## V. Wireless Device Channels and Frequencies

The frequencies listed in the table below are those that lie in the center of the bands used for cellular telephony. Low, middle and high channels were tested in each band for FCC compliance evaluation to ensure the maximum emission is captured across the entire band.

To facilitate setting of a base station simulator for ABM measurements, specific band plan channel numbers are listed that may be used in lieu of the band center frequencies.

**Table 5-4  
Center Channels and Frequencies**

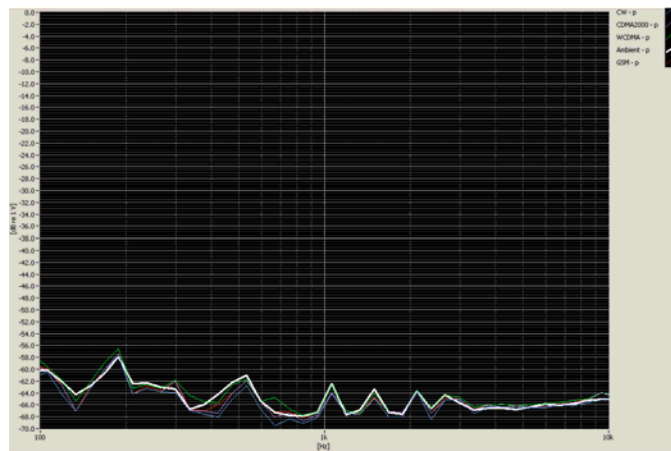

Test frequencies & associated channels	
Channel	Frequency (MHz)
<b>Cellular 850</b>	
384 (CDMA)	836.52
UARFCN 4175 (UMTS)	835.00
190 (GSM)	836.60
<b>PCS 1900</b>	
661 (GSM)	1880
600 (CDMA)	1880
UARFCN 9400 (UMTS)	1880

## VI. RF Emission Effect on T-coil Measurements



**Figure 5-10**

**High power RF Emissions Effect with HAC Dipole on the T-coil Probe System**

FCC ID: QMNRM-125		C63.19-2006 v3.12 §6 HAC TEST REPORT		Reviewed by: Quality Manager
Filename: 0606140494-R2	Test Dates: June 19 - 21, 2006	EUT Type: Tri-Mode Dual-Band Analog/PCS Phone with Bluetooth	Page 16 of 39	



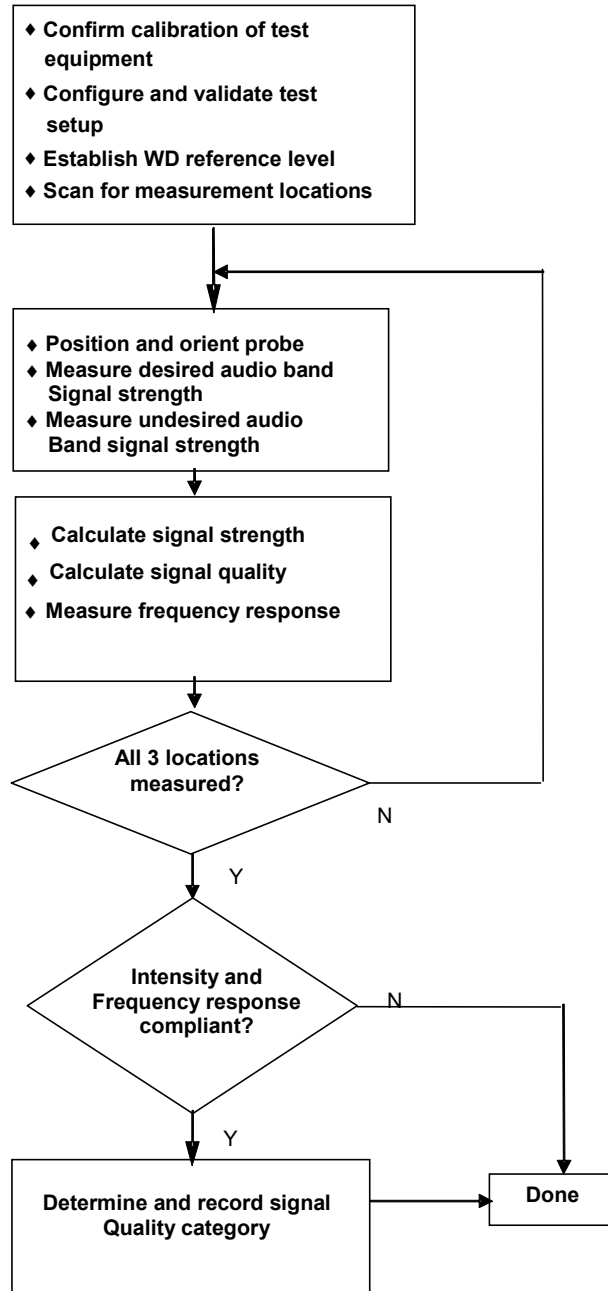

## VII. Test Flow

The flow diagram below was followed (From C63.19):



**Figure 5-11**  
**C63.19 T-Coil Signal Test Process**

FCC ID: QMNRM-125		C63.19-2006 v3.12 §6 HAC TEST REPORT		Reviewed by: Quality Manager
Filename: 0606140494-R2	Test Dates: June 19 - 21, 2006	EUT Type: Tri-Mode Dual-Band Analog/PCS Phone with Bluetooth	Page 17 of 39	

## 6. SYSTEM SPECIFICATIONS

### I. Precision Probe Position System

Manufacturer:	TEM
Accuracy:	± 0.83 cm/meter
Minimum Step Size:	0.1 mm
Maximum speed	6.1 cm/sec
Line Voltage:	115 VAC
Line Frequency:	60 Hz
Material Composite:	Delrin (Acetal)
Data Control:	Parallel Port
Dynamic Range (X-Y-Z):	45 x 31.75 x 47 cm
Dimensions:	36" x 25" x 38"
Operating Area:	36" x 49" x 55"
Reflections:	< -20 dB (in anechoic chamber)

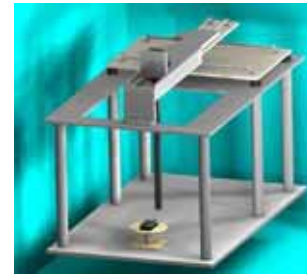

**Figure 6-1**  
RF Near-Field Scanner

### II. Measurement Software

Manufacturer:	TEM
Model:	EM Scan
Weighting Filters:	A, B, C Message Weighting
Integrators:	Half Band, Full Band
Octave Band Filters:	Full Band and Fractional

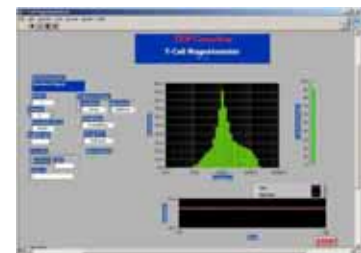

**Figure 6-2** Measurement Software

### III. T-Coil Probes

Manufacturer:	TEM
T-coil orientations:	Axial, Radial
Model:	MN3001
Sensitivity at 1 kHz:	-59.1 dB (V/A/m)
Coil Max. Dimensions (L x OD):	6.55 mm X 2.29 mm
Wire Size:	51 AWG
DC Resistance:	900 Ω
Sensitivity Tolerance:	±0.5 dB
Standards:	FCC Part 68, IEEE 1027-1996



**Figure 6-3** T-Coil Probes

FCC ID: QMNRM-125	PCTEST	C63.19-2006 v3.12 §6 HAC TEST REPORT	NOKIA	Reviewed by: Quality Manager
Filename: 0606140494-R2	Test Dates: June 19 - 21, 2006	EUT Type: Tri-Mode Dual-Band Analog/PCS Phone with Bluetooth		Page 18 of 39

#### IV. Amplifier

Manufacturer: Listen, Inc.  
 Frequency Range: 20 Hz to 100 kHz ( $\pm 0.1$  dB)  
 Gain: -20 to 60  $\pm 0.2$  dB in steps of 20  $\pm 0.1$  dB  
 Input Noise:  $<1.8\mu\text{V}_{\text{rms}}$  (A-weighted),  $<3.0\mu\text{V}_{\text{rms}}$  (20 kHz), @ 20 - 60 dB  
 Total Harmonic Distortion:  $<0.005\%$   
 Input/Output Impedance: 1 M $\Omega$  / 600  $\Omega$   
 Dimensions: 5.5" H (139.7 mm), 2.5" W (63.5 mm), 7.5" D (190.5 mm)



Figure 6-4 Amplifier

#### V. Helmholtz Coil

See IEEE C63.19, Annex D9 for Helmholtz Coil specifications

Manufacturer: TEM  
 Radius: 80 mm  
 Windings: 20 turns of no. 24 AWG enameled magnet wire  
 Sensitivity at Calibration Center: 17.549 A/m/V  
 Standard(s) calibrated: IEEE 1027



Figure 6-5 Helmholtz Coil

#### VI. Data Acquisition Card

Manufacturer: National Instruments  
 Model: PCI-4474  
 Max. Sampling Rate: 102.4 kS/s  
 Flatness (re to 1 kHz):  $\pm 0.1$  dB, DC to 0.4535 fs, max, DC-coupled  
 Anti-aliasing: 45 kHz alias-free bandwidth  
 Analog I/O Connectors: SMB Male  
 Resolution: 24 bit  
 Dynamic Range: 110 dB



Figure 6-6 Data Acquisition Card

#### VII. Real-Time Analyzer

Manufacturer: Listen, Inc.  
 Filters: 1/1, 1/3, 1/6, 1/12, 1/24 octave  
 Filter Type: True Digital Recursive  
 Weightings: A, B, or C weighting filters  
 Compliant to Standards: ANSI S1.11 and IEC 1260

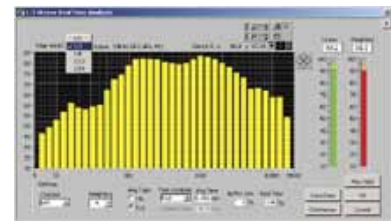



Figure 6-7 Real-Time Analyzer

FCC ID: QMNRM-125		C63.19-2006 v3.12 §6 HAC TEST REPORT		Reviewed by: Quality Manager
Filename: 0606140494-R2	Test Dates: June 19 - 21, 2006	EUT Type: Tri-Mode Dual-Band Analog/PCS Phone with Bluetooth		Page 19 of 39

## VIII. Acoustic Test Frequencies

The test frequencies and 1/3 octave test bandwidths to be used for the test are from ISO 3-1973 and ISO 266-1975.

1/3 - Octave band (Hz)	Included frequencies (Hz)
100	89.1 - 112.0
125	112 - 141
160	141 - 178
200	179 - 224
250	224 - 282
315	282 - 355
400	355 - 447
500	447 - 562
630	562 - 708
800	708 - 891
1000	891 - 1120
1250	1120 - 1410
1600	1410 - 1780
2000	1780 - 2240
2500	2240 - 2820
3150	2820 - 3550
4000	3550 - 4470
5000	4470 - 5620

**Table 6-1** Acoustic test frequencies

## IX. ITU-T P.50 Artificial Voice

Manufacturer: ITU-T  
 Active Frequency Range: 100 Hz – 8 kHz  
 Stimulus Type: Male and Female, no spaces  
 Single Sample Duration: 20.96 seconds

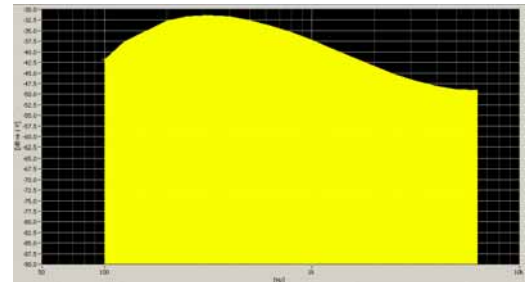



**Figure 6-8**  
P.50 Artificial Voice Signal

## X. Base Station Simulator

Manufacturer: Rohde & Schwarz  
 Model: CMU 200  
 Technology Capability: CDMA2K, GSM, GPRS, EDGE, UMTS, WCDMA, EvDO, AMPS, Bluetooth



**Figure 6-9**  
Base Station Simulator

FCC ID: QMNRM-125	 PCTEST	C63.19-2006 v3.12 §6 HAC TEST REPORT	 NOKIA	Reviewed by: Quality Manager
Filename: 0606140494-R2	Test Dates: June 19 - 21, 2006	EUT Type: Tri-Mode Dual-Band Analog/PCS Phone with Bluetooth		Page 20 of 39

## 7. TEST SUMMARY

### I. T-Coil Test Summary



**Table 7-1  
Table of Results**

C63.19 Sec.	Band	Test Description	Minimum Limit*	Measured	Verdict
			<i>dBa/m</i>	<i>dBa/m</i>	<i>PASS/FAIL</i>
7.3.1.1	Cellular	Intensity, Axial	-13	-8.8	PASS
7.3.1.2		Intensity, RadialH	-18	-17.3	PASS
7.3.1.2		Intensity, RadialV	-18	-13.1	PASS
7.3.3		Signal-to-Noise/Noise, Axial	0	45.8	PASS
7.3.3		Signal-to-Noise/Noise, RadialH	0	37.6	PASS
7.3.3		Signal-to-Noise/Noise, RadialV	0	33.4	PASS
7.3.2		Frequency Response, Axial	0	1.6	PASS
7.3.1.1	PCS	Intensity, Axial	-13	-9.6	PASS
7.3.1.2		Intensity, RadialH	-18	-17.1	PASS
7.3.1.2		Intensity, RadialV	-18	-13.1	PASS
7.3.3		Signal-to-Noise/Noise, Axial	0	45.2	PASS
7.3.3		Signal-to-Noise/Noise, RadialH	0	38.0	PASS
7.3.3		Signal-to-Noise/Noise, RadialV	0	33.3	PASS

**Table 7-2  
Consolidated Tabled Results with Rating**

	Volume Setting	Cellular			PCS		
		Axial	RadialH	RadialV	Axial	RadialH	RadialV
Freq. Response Margin	Maximum	PASS	PASS	PASS	PASS	PASS	PASS
Magnetic Intensity Verdict		PASS	PASS	PASS	PASS	PASS	PASS
FCC SNR Verdict		PASS	PASS	PASS	PASS	PASS	PASS

Note: Radial Orientation for Frequency Response not required for rating category determination. Result shown is for T-coil category only.

FCC ID: QMNRM-125		C63.19-2006 v3.12 §6 HAC TEST REPORT		Reviewed by: Quality Manager
Filename: 0606140494-R2	Test Dates: June 19 - 21, 2006	EUT Type: Tri-Mode Dual-Band Analog/PCS Phone with Bluetooth		Page 21 of 39

## II. Raw Handset Data

	Volume	Cellular Band								
		Axial			RadialH			RadialV		
		1013	384	777	1013	384	777	1013	384	777
Freq. Response Margin	Maximum	1.76	1.73	1.60	1.54	1.52	1.66	1.49	1.52	1.51
ABM1, dBA/m		-8.43	-8.77	-8.83	-17.29	-17.12	-16.34	-13.04	-12.96	-13.12
ABM2		-54.95	-54.56	-54.67	-54.87	-54.98	-54.87	-47.45	-46.83	-46.56
S+N/N		46.52	45.78	45.84	37.58	37.86	38.53	34.40	33.87	33.44
S+N/N per orientation		45.78			37.58			33.44		
Freq. Response Margin	Maximum	1.59	1.72	1.61	1.75	1.63	1.59	1.61	1.59	1.61
ABM1, dBA/m		-9.33	-9.59	-9.01	-15.89	-15.56	-17.11	-13.12	-12.81	-13.12
ABM2		-54.50	-55.02	-54.75	-54.79	-54.66	-55.09	-46.44	-48.47	-48.40
S+N/N		45.17	45.43	45.74	38.90	39.10	37.98	33.32	35.66	35.28
S+N/N per orientation		45.17			37.98			33.32		

Table 7-3 Raw Data Results

## WD Configuration

Test Dates: June 19 - 21, 2006

Facility: PCTEST Engineering Laboratory, Inc.

Radio Configuration: RC1/SO3

Power Configuration: Power Control Bits="All Up"

Phone Condition: Mute on; Backlight on; Contrast High, Max Volume, T-Coil Mode ON, BT off

## III. Frequency Response Graph

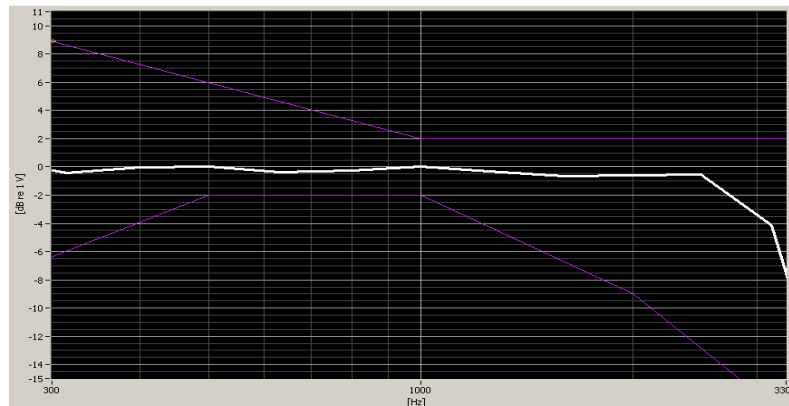
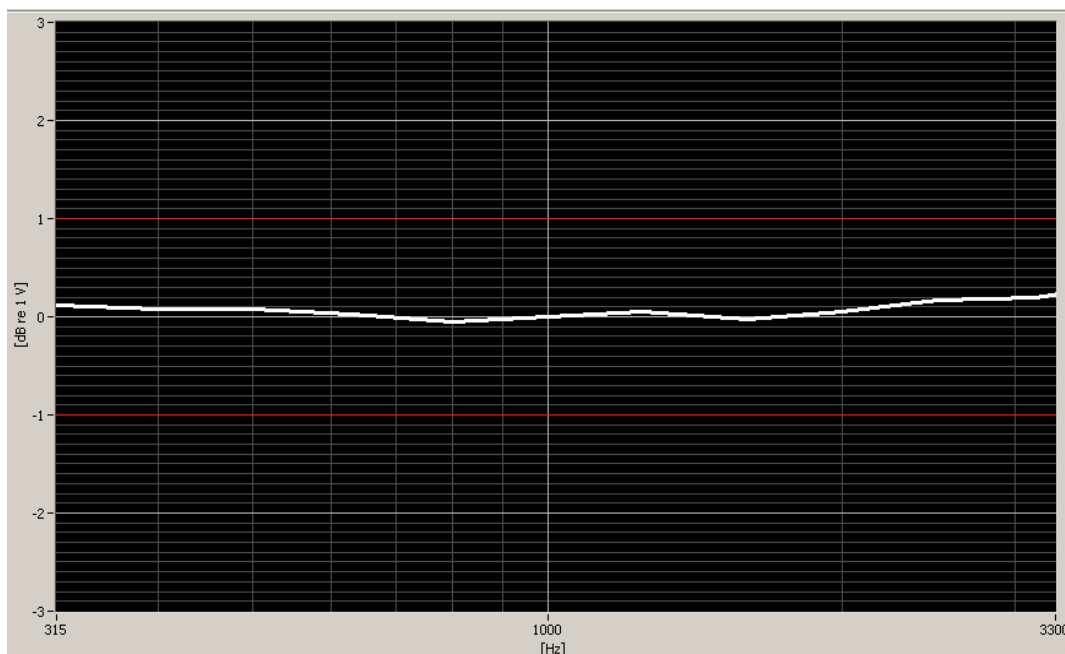

Figure 7-1  
Axial Frequency Response

FCC ID: QMNRM-125	PCTEST	C63.19-2006 v3.12 §6 HAC TEST REPORT	NOKIA	Reviewed by: Quality Manager
Filename: 0606140494-R2	Test Dates: June 19 - 21, 2006	EUT Type: Tri-Mode Dual-Band Analog/PCS Phone with Bluetooth	Page 22 of 39	



#### IV. T-Coil Validation Test Results



**Figure 7-2**  
Helmholtz Coil Validation for Frequency Response

**Table 7-4**  
Helmholtz Coil Validation Table of Results

Item	Target	Measured dB About Target	Verdict
<b>Signal Validation</b>			
Frequency Response, from limits	$0 \pm 0.5 \text{ dB}$	0.23	PASS
Magnetic Intensity, 0 dBA/m	$0 \pm 0.5 \text{ dB}$	0	PASS
<b>Noise Validation</b>			
Environmental Noise	$< - (38 - \text{AWF})$	-59.22	PASS

FCC ID: QMNRM-125		C63.19-2006 v3.12 §6 HAC TEST REPORT		Reviewed by: Quality Manager
Filename: 0606140494-R2	Test Dates: June 19 - 21, 2006	EUT Type: Tri-Mode Dual-Band Analog/PCS Phone with Bluetooth	Page 23 of 39	

## 8. FCC 3G MEASUREMENTS – MAY 2006

Radio Configuration 1, Service Option 3 (thick, green data curve) was used for the testing as the worst-case configuration for the handset due to vocoder gating from the EVRC logic. See below plot for ABM noise comparison between operational field service options and radio configurations for CDMA2000:

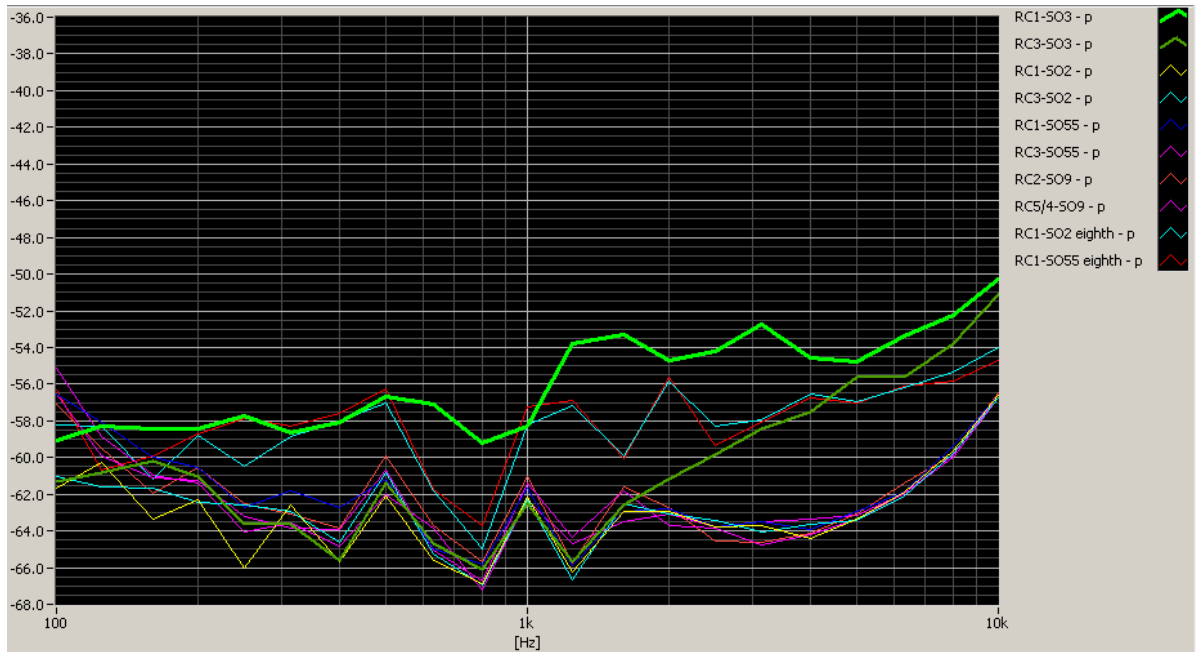

**Figure 8-1**  
**CDMA2000 Audio Band Magnetic Noise**

### I. Handset Setup Conditions:

- Mute on; Backlight on; Contrast High, Max Volume, T-Coil Mode ON, BT off
- Power Control Bits="All Up"



**Figure 8-2**  
**Audio Band Magnetic Curve Measurement Block Diagram**

FCC ID: QMNRM-125	<b>PCTEST</b>	C63.19-2006 v3.12 §6 HAC TEST REPORT		Reviewed by: Quality Manager
Filename: 0606140494-R2	Test Dates: June 19 - 21, 2006	EUT Type: Tri-Mode Dual-Band Analog/PCS Phone with Bluetooth	Page 24 of 39	



## 9. MEASUREMENT UNCERTAINTY



**Table 9-1  
Uncertainty Estimation Table**

Contribution	Data +/- %	Data +/- dB	Data Type	Probability distribution	Divisor	Standard uncertainty	Standard Uncertainty (dB)
RF Reflections	12.2%	0.50	Specification	Rectangular	1.73	7.0%	
ABM Noise	12.2%	0.50	Specification	Rectangular	1.73	7.0%	
Reference Signal Level	12.2%	0.50	Specification	Rectangular	1.73	7.0%	
Positioning Accuracy	10.0%	0.41	Uncertainty	Rectangular	1.73	5.8%	
Probe Coil Sensitivity	12.2%	0.50	Specification	Rectangular	1.73	7.0%	
Probe Linearity	12.2%	0.50	Specification	Rectangular	1.73	7.0%	
Cable Loss	2.4%	0.10	Specification	Normal k=2	2.00	1.2%	
Frequency Analyzer	5.0%	0.21	Specification	Rectangular	1.73	2.9%	
System Repeatability	5.0%	0.21	Std. Dev.	Normal k=1	1.00	5.0%	
Vocoder Variation	9.0%	0.37	Std. Dev.	Normal k=1	1.00	9.0%	
WD Repeatability	12.2%	0.50	Std. Dev.	Normal k=1	1.00	12.2%	
Positioner Accuracy	1.0%	0.04	Specification	Rectangular	1.73	0.6%	
Combined standard uncertainty, uc						23.4%	0.91
Expanded uncertainty (k=2), 95% confidence level						46.7%	1.67

**Notes:**

1. Test equipments are calibrated according to techniques outlined in NIS81, NIS3003 and NIST Tech Note 1297.
2. All equipments have traceability according to NIST. Measurement Uncertainties are defined in further detail in NIS 81 and NIST Tech Note 1297 and UKAS M3003.



Measurement uncertainty reflects the quality and accuracy of a measured result as compared to the true value. Such statements are generally required when stating results of measurements so that it is clear to the intended audience that the results may differ when reproduced by different facilities. Measurement results vary due to the measurement uncertainty of the instrumentation, measurement technique, and test engineer. Most uncertainties are calculated using the tolerances of the instrumentation used in the measurement, the measurement setup variability, and the technique used in performing the test. While not generally included, the variability of the equipment under test also figures into the overall measurement uncertainty. Another component of the overall uncertainty is based on the variability of repeated measurements (so-called Type A uncertainty). This may mean that the Hearing Aid compatibility tests may have to be repeated by taking down the test setup and resetting it up so that there are a statistically significant number of repeat measurements to identify the measurement uncertainty. By combining the repeat measurement results with that of the instrumentation chain using the technique contained in NIS 81 and NIS 3003, the overall measurement uncertainty was estimated.

FCC ID: QMNRM-125	 PCTEST	C63.19-2006 v3.12 §6 HAC TEST REPORT	 NOKIA	Reviewed by: Quality Manager
Filename: 0606140494-R2	Test Dates: June 19 - 21, 2006	EUT Type: Tri-Mode Dual-Band Analog/PCS Phone with Bluetooth		Page 25 of 39



## 10. EQUIPMENT LIST

Manufacturer	Make / Equipment	Calibration Due	Asset No.
MicroCoax	(1.0-26.5GHz) Microwave Cables	N/A	N/A
HP	8648D (9kHz-4GHz) Signal Generator	-	3613A00315
Rohde & Schwarz	(0.1-1000MHz) Signal Generator	September 2006	894215/012
Narda	3020A (50-1000MHz) Bi-Directional Coax Coupler	-	
HP	34401A Multimeter	August 2006	
NI	4474 Data Acquisition Card	N/A	
HP	437B Power Meter	May 2007	3125U24437
Amplifier Research	5S1G4 (5W, 800MHz-4.2GHz)	-	22322
Gigatronics	80701A (0.05-18GHz) Power Sensor	April 2007	1833460
HP	8482H (30mW-3W) Power Sensor	-	2237A02084
TEM	T-coil Magnetometer	January 2007	PCT920
HP	8594A Spectrum Analyzer	-	3051A00187
Gigatronics	8657A Universal Power Meter	April 2007	1835256
HP	8753E (30kHz-6GHz) Network Analyzer	February 2007	JP38020182
Agilent	8960 Base Station Simulator	January 2007	
PCTEST	9-pin Audio Cable	N/A	N/A
TEM	Axial Telecoil Probe	March 2007	TEM-1109
TEM	Radial Telecoil Probe	March 2007	TEM-1108
Agilent	Base Station Simulator	May 2007	661
TEM	C63.19 Helmholtz Coil	March 2007	PCT925
Rohde & Schwarz	CMU200 Base Station Simulator	September 2006	650378
SPEAG	DAE4	October 2006	637
Agilent	ESG-D Signal Generator	October 2006	
Optix	Fiber-Optic Line	N/A	
SPEAG	Freespace 1880 MHz Dipole	February 2007	1002
TDK	Freespace 1900 MHz Dipole	October 2007	130116
SPEAG	Freespace 2450 MHz Dipole	February 2007	1004
ETS	Freespace 835 MHz Dipole	February 2007	A005
SPEAG	Freespace 835 MHz Dipole	February 2007	1003
EMCO	Freespace E-field Probe	January 2007	9704-1441
SPEAG	Freespace E-field Probe	January 2007	2332
SPEAG	Freespace H-field Probe	October 2006	6180
TEM	HAC Positioner	N/A	PCT918
Bruel & Kjaer	HATS System	January 2007	687
Hosa	High Precision TRS Cable	N/A	
EMCO	Model 3115 (1-18GHz) Horn Antenna	October 2006	9203-2178
TEM	HAC System Controller with Software	October 2006	9704-5182
Rohde & Schwarz	NRVS Power Meter	April 2007	
RF Lindgren Model 26-2/2-0	Shielded Screen Room	N/A	6710 (PCT270)
Ray Proof Model S81	Shielded Semi-Anechoic Chamber	-	R2437 (PCT278)
AudioScan	Telecoil Magnetic Field Simulator	February 2007	22005

\* Traceable to NIST

FCC ID: QMNRM-125		C63.19-2006 v3.12 §6 HAC TEST REPORT		Reviewed by: Quality Manager
Filename: 0606140494-R2	Test Dates: June 19 - 21, 2006	EUT Type: Tri-Mode Dual-Band Analog/PCS Phone with Bluetooth		Page 26 of 39

# 11. CALIBRATION CERTIFICATES

<b>FCC ID:</b> QMNRM-125		<b>C63.19-2006 v3.12 §6 HAC TEST REPORT</b>		<b>Reviewed by:</b> Quality Manager
<b>Filename:</b> 0606140494-R2	<b>Test Dates:</b> June 19 - 21, 2006	<b>EUT Type:</b> Tri-Mode Dual-Band Analog/PCS Phone with Bluetooth	Page 27 of 39	

# I. System Manufacturer Calibration Certificates

## **TEM Consulting, LP**

140 River Rd.  
Georgetown, Texas 78628

### Certificate of Calibration

**Date:** October 12, 2005  
**Cert I.D.:** 1017-051012

---

#### Calibration Standard(s)

The instrument identified below has been individually calibrated to the following standards:

IEEE Standard 1027

---

#### Instrument Identification

**Manufacturer:** TEM Consulting, LP  
**Unit Description:** Helmholtz Coil

---

#### Calibration Instrumentation



Equipment Used	Make/Model - S/N	Calibration Date
Digital Multi-Meter Ruler	Fluke 8860A - SN 3085046	1/26/04

1

**TEM Consulting, LP**  
[www.temconsulting.com](http://www.temconsulting.com)

140 River Rd.  
Georgetown, Tx. 78628



Tel: (512) 864-3365  
Mobile (512) 466-0833  
Fax: (512) 869-8709  
E-MAIL [stephen.berger@ieee.org](mailto:stephen.berger@ieee.org)

FCC ID: QMNRM-125		C63.19-2006 v3.12 §6 HAC TEST REPORT		Reviewed by: Quality Manager
Filename: 0606140494-R2	Test Dates: June 19 - 21, 2006	EUT Type: Tri-Mode Dual-Band Analog/PCS Phone with Bluetooth	Page 28 of 39	

### Calibration Instrumentation

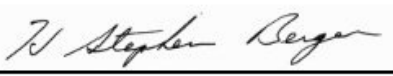
Equipment Used	Make/Model - S/N	Calibration Date
Digital Multi-Meter	Fluke 8860A - SN 3085046	1/26/04
Helmholtz Coil	TEM Consulting	NA

Calibration Completed by:   
Stephen Berger, Calibration Laboratory Supervisor

FCC ID: QMNRM-125		C63.19-2006 v3.12 §6 HAC TEST REPORT		Reviewed by: Quality Manager
Filename: 0606140494-R2	Test Dates: June 19 - 21, 2006	EUT Type: Tri-Mode Dual-Band Analog/PCS Phone with Bluetooth	Page 29 of 39	



## Certificate of Calibration Conformance

**This instrument identified below has been individually calibrated in compliance with the following standard(s):**

Internal Quality Standards.

Environment: Laboratory MTE is maintained in a temperature-controlled environment with ambient conditions from 18 to 28 C, relative humidity less than 90%. The instrument under test has been calibrated in a suitable environment to maintaining accurate and reliable measurement quality.

**Manufacturer:** TEM Consulting  
**Model Number:** T-Coil Probe Set  
**Serial Number:** 1108 / 1109  
**Tracking Number:** TEM051206  
**Date Completed:** March 12, 2006

**Operating Range:** 100Hz – 10KHz  
**Instrument Type:** T-Coil Probes

**Test remarks:** None

Calibration Traceability: All Measuring and Test Equipment (M/TE) identified below are traceable to the National Institute for Standards and Technology (NIST). Calibration Laboratory and Quality System controls are compliant with ISO/IEC 17025-1999.

**Standards and Equipment Used:**  
 Make / Model / Name/S/N / Recall Date  
 3478A Multimeter 2301A18249 6/30/2006  
 8116A Pulse/Function Generator 50Mhz  
 2516A01852 6/30/2006

**Condition of Instrument Upon Receipt:**  
 In tolerance to Internal Quality Standards

**On Release:**  
 In Tolerance to Internal Quality Standards

This document provides traceability of measurements to recognized national standards using controlled processes at the ETS-Lindgren Calibration Laboratory. This certificate and report may not be reproduced, except in full, without the written approval of ETS-Lindgren Calibration Laboratory in accordance with ISO/IEC 17025-1999. QAF 1127 (07/03).

<b>FCC ID:</b> QMNRM-125	<b>C63.19-2006 v3.12 §6 HAC TEST REPORT</b>		<b>Reviewed by:</b> Quality Manager
<b>Filename:</b> 0606140494-R2	<b>Test Dates:</b> June 19 - 21, 2006	<b>EUT Type:</b> Tri-Mode Dual-Band Analog/PCS Phone with Bluetooth	Page 30 of 39



**Certificate of Calibration Conformance**

**Sensor Factor** **0.6**  
 Factor to convert dB mV to dB A/m

**Dynamic Range**

Probe **1108**

Freq	Field Strength		Output	Sensor Factor	Sensor Linearity
	Hz	dB (A/m)    A/m			
1000	28	25.1	26.52	0.5	0.0
1000	23	14.1	14.99	0.5	0.0
1000	18	7.9	8.48	0.6	0.1

Probe **1109**

Freq	Field Strength		Output	Sensor Factor	Sensor Linearity
	Hz	dB (A/m)    A/m			
1000	28	25.1	26.52	0.4	0.0
1000	23	14.1	14.85	0.4	0.0
1000	18	7.9	8.47	0.6	0.1

FCC ID: QMNRM-125		C63.19-2006 v3.12 §6 HAC TEST REPORT		Reviewed by: Quality Manager
Filename: 0606140494-R2	Test Dates: June 19 - 21, 2006	EUT Type: Tri-Mode Dual-Band Analog/PCS Phone with Bluetooth		Page 31 of 39



**Certificate of Calibration Conformance**

**Frequency Response**

Probe 1108

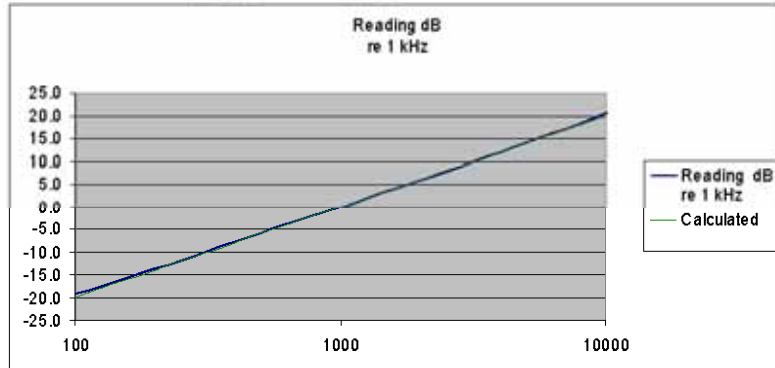

Freq Hz	Reading dB (mV)	Reading dB re 1 kHz	Delta to Calculated
100	13.38	-19.2	0.8
125	14.94	-17.7	0.4
160	17.06	-15.5	0.4
200	18.90	-13.7	0.3
250	20.73	-11.9	0.2
315	22.72	-9.9	0.1
400	24.76	-7.8	0.1
500	26.68	-5.9	0.1
630	28.68	-3.9	0.1
800	30.74	-1.9	0.1
1000	32.60	0.0	0.0
1250	34.51	1.9	0.0
1600	36.62	4.0	-0.1
2000	38.54	5.9	-0.1
2500	40.48	7.9	-0.1
3150	42.51	9.9	-0.1
4000	44.61	12.0	0.0
5000	46.59	14.0	0.0
6300	48.69	16.1	0.1
8000	50.91	18.3	0.2
10000	53.21	20.6	0.6

FCC ID: QMNRM-125	PCTEST	C63.19-2006 v3.12 §6 HAC TEST REPORT	NOKIA	Reviewed by: Quality Manager
Filename: 0606140494-R2	Test Dates: June 19 - 21, 2006	EUT Type: Tri-Mode Dual-Band Analog/PCS Phone with Bluetooth		Page 32 of 39





**Certificate of Calibration Conformance**

**Frequency Response**

Probe 1109

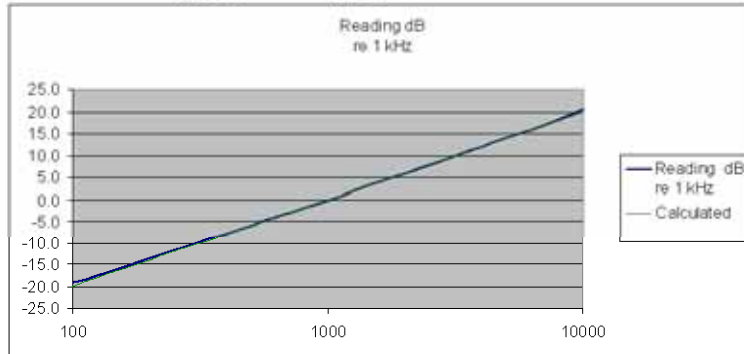

Freq Hz	Reading dB (mV)	Reading dB re 1 kHz	Delta to Calculated
100	13.34	-19.2	0.8
125	15.03	-17.5	0.6
160	16.99	-15.5	0.4
200	18.94	-13.6	0.4
250	20.78	-11.7	0.3
315	22.73	-9.8	0.3
400	24.73	-7.8	0.2
500	26.59	-5.9	0.1
630	28.59	-3.9	0.1
800	30.65	-1.9	0.1
1000	32.51	0.0	0.0
1250	34.42	1.9	0.0
1600	36.53	4.0	-0.1
2000	38.45	5.9	-0.1
2500	40.39	7.9	-0.1
3150	42.41	9.9	-0.1
4000	44.50	12.0	-0.1
5000	46.48	14.0	0.0
6300	48.56	16.0	0.1
8000	50.76	18.3	0.2
10000	53.02	20.5	0.5

FCC ID: QMNRM-125	PCTEST	C63.19-2006 v3.12 §6 HAC TEST REPORT	NOKIA	Reviewed by: Quality Manager
Filename: 0606140494-R2	Test Dates: June 19 - 21, 2006	EUT Type: Tri-Mode Dual-Band Analog/PCS Phone with Bluetooth		Page 33 of 39

## II. Frequency Response Check with probe system:

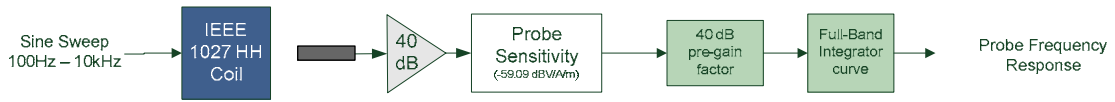
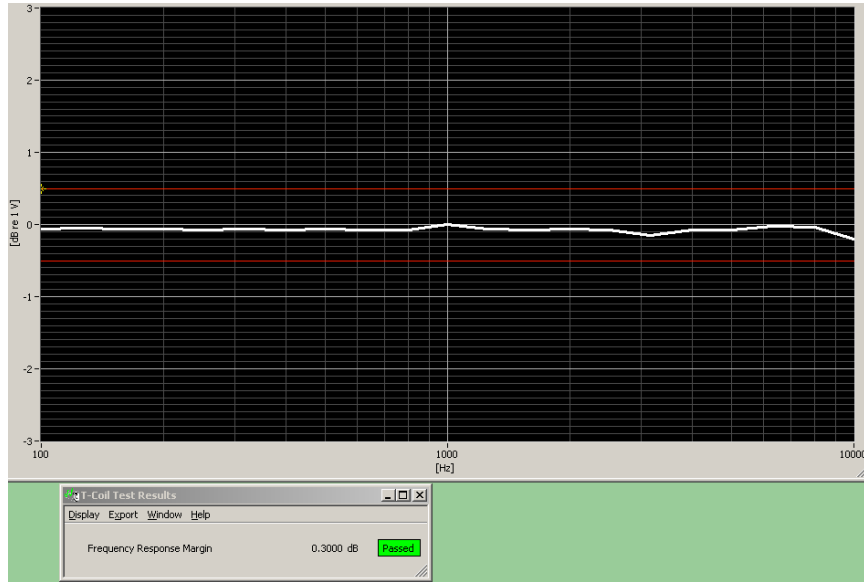

## III. Linearity Check with probe system:

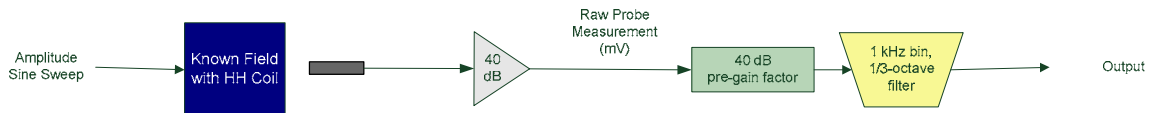
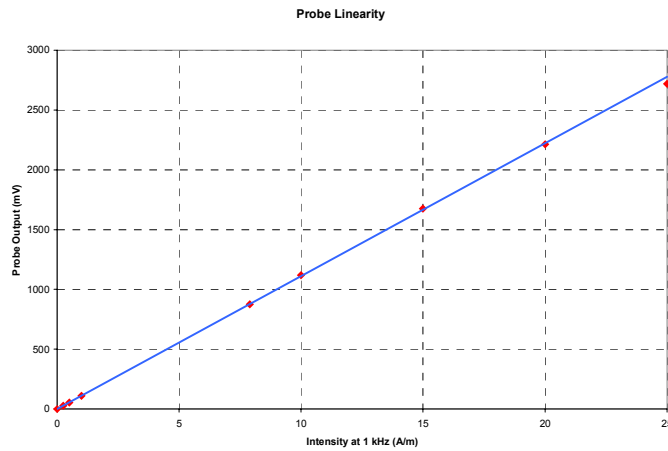



FCC ID: QMNRM-125	PCTEST	C63.19-2006 v3.12 §6 HAC TEST REPORT	NOKIA	Reviewed by: Quality Manager
Filename: 0606140494-R2	Test Dates: June 19 - 21, 2006	EUT Type: Tri-Mode Dual-Band Analog/PCS Phone with Bluetooth		Page 34 of 39

## 12. CONCLUSION



The measurements indicate that the wireless communications device complies with the HAC limits specified in accordance with the ANSI C63.19 Standard and FCC WT Docket No. 01-309 RM-8658. Precise laboratory measures were taken to assure repeatability of the tests. The tested device complies with the requirements in respect to all parameters specific to the test. The test results and statements relate only to the item(s) tested.

The measurement system and techniques presented in this evaluation are proposed in the ANSI standard as a means of best approximating wireless device compatibility with a hearing-aid. The literature is under continual re-construction.



<b>FCC ID:</b> QMNRM-125		<b>C63.19-2006 v3.12 §6 HAC TEST REPORT</b>		<b>Reviewed by:</b> Quality Manager
<b>Filename:</b> 0606140494-R2	<b>Test Dates:</b> June 19 - 21, 2006	<b>EUT Type:</b> Tri-Mode Dual-Band Analog/PCS Phone with Bluetooth	Page 35 of 39	

## 13. REFERENCES

1. ANSI C63.19-2006 v3.12, American National Standard for Methods of Measurement of Compatibility between Wireless communication devices and Hearing Aids.", New York, NY, IEEE, January 2006
2. FCC Public Notice DA 06-1215, *Wireless Telecommunications Bureau and Office of Engineering and Technology Clarify Use of Revised Wireless Phone Hearing Aid Compatibility Standard*, June 6, 2006
3. Berger, H. S., "Compatibility Between Hearing Aids and Wireless Devices," Electronic Industries Forum, Boston, MA, May, 1997
4. Berger, H. S., "Hearing Aid and Cellular Phone Compatibility: Working Toward Solutions," *Wireless Telephones and Hearing Aids: New Challenges for Audiology*, Gallaudet University, Washington, D.C., May, 1997 (To be reprinted in the American Journal of Audiology).
5. Berger, H. S., "Hearing Aid Compatibility with Wireless Communications Devices," IEEE International Symposium on Electromagnetic Compatibility, Austin, TX, August, 1997.
6. Bronaugh, E. L., "Simplifying EMI Immunity (Susceptibility) Tests in TEM Cells," in the 1990 IEEE International Symposium on Electromagnetic Compatibility Symposium Record, Washington, D.C., August 1990, pp. 488-491
7. Byrne, D. and Dillon, H., The National Acoustics Laboratory (NAL) New Procedure for Selecting the Gain and Frequency Response of a Hearing Aid, *Ear and Hearing* 7:257-265, 1986.
8. Crawford, M. L., "Measurement of Electromagnetic Radiation from Electronic Equipment using TEM Transmission Cells," U.S. Department of Commerce, National Bureau of Standards, NBSIR 73-306, Feb. 1973.
9. Crawford, M. L., and Workman, J. L., "Using a TEM Cell for EMC Measurements of Electronic Equipment," U.S. Department of Commerce, National Bureau of Standards. Technical Note 1013, July 1981.
10. EHIMA GSM Project, Development phase, Project Report (1<sup>st</sup> part) Revision A. Technical-Audiological Laboratory and Telecom Denmark, October 1993.
11. EHIMA GSM Project, Development phase, Part II Project Report. Technical-Audiological Laboratory and Telecom Denmark, June 1994.
12. EHIMA GSM Project Final Report, Hearing Aids and GSM Mobile Telephones: Interference Problems, Methods of Measurement and Levels of Immunity. Technical-Audiological Laboratory and Telecom Denmark, 1995.
13. HAMPIS Report, Comparison of Mobile phone electromagnetic near field with an upscaled electromagnetic far field, using hearing aid as reference, 21 October 1999.
14. Hearing Aids/GSM, Report from OTWIDAM, Technical-Audiological Laboratory and Telecom Denmark, April 1993.
15. IEEE 100, The Authoritative Dictionary of IEEE Standards Terms, Seventh Edition.

FCC ID: QMNRM-125		C63.19-2006 v3.12 §6 HAC TEST REPORT		Reviewed by: Quality Manager
Filename: 0606140494-R2	Test Dates: June 19 - 21, 2006	EUT Type: Tri-Mode Dual-Band Analog/PCS Phone with Bluetooth	Page 36 of 39	

16. Joyner, K. H., et. al., Interference to Hearing Aids by the New Digital Mobile Telephone System, Global System for Mobile (GSM) Communication Standard, National Acoustic Laboratory, Australian Hearing Series, Sydney 1993.
17. Joyner, K. H., et. al., Interference to Hearing Aids by the Digital Mobile Telephone System, Global System for Mobile Communications (GSM), NAL Report #131, National Acoustic Laboratory, Australian Hearing Series, Sydney, 1995.
18. Kecker, W. T., Crawford, M. L., and Wilson, W. A., "Construction of a Transverse Electromagnetic Cell", U.S. Department of Commerce, National Bureau of Standards, Technical Note 1011, Nov. 1978.
19. Konigstein, D., and Hansen, D., "A New Family of TEM Cells with enlarged bandwidth and Optimized working Volume," in the Proceedings of the 7<sup>th</sup> International Symposium on EMC, Zurich, Switzerland, March 1987; 50:9, pp. 127-132.
20. Kuk, F., and Hjorstgaard, N. K., "Factors affecting interference from digital cellular telephones," Hearing Journal, 1997; 50:9, pp 32-34.
21. Ma, M. A., and Kanda, M., "Electromagnetic Compatibility and Interference Metrology," U.S. Department of Commerce, National Bureau of Standards, Technical Note 1099, July 1986, pp. 17-43.
22. Ma, M. A., Sreenivashiah, I. , and Chang, D. C., "A Method of Determining the Emission and Susceptibility Levels of Electrically Small Objects Using a TEM Cell," U.S. Department of Commerce, National Bureau of Standards, Technial Note 1040, July 1981.
23. McCandless, G. A., and Lyregaard, P. E., Prescription of Gain/Output (POGO) for Hearing Aids, Hearing Instruments 1:16-21, 1983
24. Skopec, M., "Hearing Aid Electromagnetic Interference from Digital Wireless Telephones, "IEEE Transactions on Rehabilitation Engineering, vol. 6, no. 2, pp. 235-239, June 1998.
25. Technical Report, GSM 05.90, GSM EMC Considerations, European Telecommunications Standards Institute, January 1993.
26. Victorian, T. A., "Digital Cellular Telephone Interference and Hearing Aid Compatibility—an Update," Hearing Journal 1998; 51:10, pp. 53-60
27. Wong, G. S. K., and Embleton, T. F. W., eds., AIP Handbook of Condenser Microphones: Theory, Calibration and Measurements, AIP Press.

<b>FCC ID:</b> QMNRM-125	 <b>C63.19-2006 v3.12 §6 HAC TEST REPORT</b>		<b>Reviewed by:</b> Quality Manager
<b>Filename:</b> 0606140494-R2	<b>Test Dates:</b> June 19 - 21, 2006	<b>EUT Type:</b> Tri-Mode Dual-Band Analog/PCS Phone with Bluetooth	Page 37 of 39