

FCC Radio Test Report

FCC ID: QISME919BS-567A

This report concerns (check one): Original Grant Class II Change

Project No. : 1701C252
Equipment : LTE Module
Model Name : ME919Bs-567a
Applicant : Huawei Technologies Co.,Ltd.
Address : Administration Building, Headquarters of Huawei Technologies Co., Ltd., Bantian, Longgang District Shenzhen China

Date of Receipt : Feb. 08, 2017
Date of Test : Feb. 08, 2017 ~ Feb. 15, 2017
Issued Date : Feb. 16 2017
Tested by : BTL Inc.

Technical Engineer : Shawn Xiao
(Shawn Xiao)

Authorized Signatory : Steven Lu
(Steven Lu)

B T L I N C .

No.3, Jinshagang 1st Road, Shixia, Dalang Town, Dongguan, Guangdong, China.

TEL: +86-769-8318-3000 FAX: +86-769-8319-6000

Declaration

BTL represents to the client that testing is done in accordance with standard procedures as applicable and that test instruments used has been calibrated with standards traceable to international standard(s) and/or national standard(s).

BTL's reports apply only to the specific samples tested under conditions. It is manufacture's responsibility to ensure that additional production units of this model are manufactured with the identical electrical and mechanical components. **BTL** shall have no liability for any declarations, inferences or generalizations drawn by the client or others from **BTL** issued reports.

BTL's report must not be used by the client to claim product certification, approval, or endorsement by NVLAP, NIST, or any agency of the Federal Government.

This report is the confidential property of the client. As a mutual protection to the clients, the public and **BTL-self**, extracts from the test report shall not be reproduced except in full with **BTL's** authorized written approval.

BTL's laboratory quality assurance procedures are in compliance with the **ISO Guide17025** requirements, and accredited by the conformity assessment authorities listed in this test report.

Limitation

For the use of the authority's logo is limited unless the Test Standard(s)/Scope(s)/Item(s) mentioned in this test report is (are) included in the conformity assessment authorities acceptance respective.

Table of Contents

Page

REPORT ISSUED HISTORY	5
1 . CERTIFICATION	6
2 . SUMMARY OF TEST RESULTS	7
2.1 TEST FACILITY	8
2.2 MEASUREMENT UNCERTAINTY	8
3 . GENERAL INFORMATION	9
3.1 GENERAL DESCRIPTION OF EUT	9
3.2 DESCRIPTION OF TEST MODES AND TEST CONDITION	11
3.3 BLOCKDIAGRAMSHOWINGTHECONFIGURATIONOFSYSTEMTESTED FOR RADIATED	13
3.4 DESCRIPTION OF SUPPORT UNITS	14
4 . TEST RESULT	15
4.1 OUTPUT POWER MEASUREMENT	15
4.1.1 LIMIT	15
4.1.2 TEST PROCEDURE	15
4.1.3 TESTSETUP LAYOUT	15
4.1.4 TEST DEVIATION	15
4.1.5 TEST RESULTS	15
4.2 OCCUPIED BANDWIDTH MEASUREMENT	16
4.2.1 TEST PROCEDURE	16
4.2.2 TEST SETUP LAYOUT	16
4.2.3 TEST DEVIATION	16
4.2.4 TEST RESULTS	16
4.3 CONDUCTED EMISSIONS MEASUREMENT	17
4.3.1 LIMIT	17
4.3.2 TEST PROCEDURES	17
4.3.3 TESTSETUP LAYOUT	17
4.3.4 TESTDEVIATION	17
4.3.5 TEST RESULTS	17
4.4 RADIATED EMISSIONS MEASUREMENT	18
4.4.1 LIMIT	18
4.4.2 TEST PROCEDURES	18
4.4.3 TESTSETUP LAYOUT	18
4.4.4 TESTDEVIATION	18
4.4.5 TEST RESULTS	18
4.5 BAND EDGE MEASUREMENT	19
4.5.1 LIMIT	19

Table of Contents	Page
4.5.2 TEST PROCEDURES	19
4.5.3 TESTSETUP LAYOUT	19
4.5.4 TESTDEVIATION	19
4.5.5 TEST RESULTS	19
4.6 PEAK TO AVERAGE RATIO MEASUREMENT	20
4.6.1 LIMIT	20
4.6.2 TEST PROCEDURES	20
4.6.3 TESTSETUP LAYOUT	20
4.6.4 TESTDEVIATION	20
4.6.5 TEST RESULTS	20
4.7 FREQUENCY STABILITY MEASUREMENT	21
4.7.1 LIMIT	21
4.7.2 TEST PROCEDURES	21
4.7.3 TESTSETUP LAYOUT	21
4.7.4 TESTDEVIATION	21
4.7.5 TEST RESULTS	21
ATTACHMENT A - OUTPUT POWER	24
ATTACHMENT B - OCCUPIED BANDWIDTH	31
ATTACHMENT C - CONDUCTED EMISSIONS	45
ATTACHMENT D - RADIATED EMISSION	54
ATTACHMENT E - BAND EDGE	65
ATTACHMENT F - PEAK TO AVERAGE RATIO	72
ATTACHMENT G - FREQUENCY STABILITY	81

REPORT ISSUED HISTORY

Issued No.	Description	Issued Date
BTL-FCCP-1-1701C252	Original Issue.	Feb. 16 2017

1. CERTIFICATION

Equipment : LTE Module
Brand Name : HUAWEI
Model Name : ME919Bs-567a
Applicant : Huawei Technologies Co.,Ltd.
Manufacturer : Huawei Technologies Co.,Ltd.
Address : Administration Building, Headquarters of Huawei Technologies Co., Ltd.,
Bantian, Longgang District Shenzhen China
Factory : Huawei Technologies Co.,Ltd.
Address : Administration Building, Headquarters of Huawei Technologies Co., Ltd.,
Bantian, Longgang District Shenzhen China
Date of Test : Feb. 08, 2017 ~ Feb. 15, 2017
Test Sample : Engineering Sample
Standard(s) : 47 CFR FCC Part 22 Subpart H
47 CFR FCC Part 2
ANSI/TIA-603-D-2010
KDB 971168 D01 Power Meas License Digital Systems v02r02

The above equipment has been tested and found compliance with the requirement of the relative standards by BTL Inc.

The test data, data evaluation, and equipment configuration contained in our test report (Ref No. BTL-FCCP-1-1701C252) were obtained utilizing the test procedures, test instruments, test sites that has been accredited by the Authority of TAF according to the ISO-17025 quality assessment standard and technical standard(s).

Test result included in this report is only for the GSM850, WCDMA Band 5 and LTE Band 5 part.

2. SUMMARY OF TEST RESULTS

Test procedures according to the technical standard(s):

FCC Part 22 Subpart H& Part 2			
Standard(s) Section	Test Item	Judgment	Tested By
2.1046 22.913(a)	Radiated power	PASS	Paul Li
2.1046 22.913(a)	Conducted Output Power	PASS	Paul Li
2.1049(h) 22.917(a)	Occupied Bandwidth	PASS	Paul Li
2.1051 22.917(a)	Conducted Spurious Emissions	PASS	Paul Li
2.1053 22.917(a)	Radiated Spurious Emissions	PASS	Shaohua Peng
22.917(a)	Band Edge Measurements	PASS	Paul Li
-	Peak To Average Ratio	PASS	Paul Li
2.1055 22.355	Frequency Stability	PASS	Paul Li

NOTE:

(1) "N/A" denotes test is not applicable to this device.

2.1 TEST FACILITY

Conducted: No.3, Jinshagang 1st Road, Shixia, Dalang Town, Dongguan, Guangdong, China.

Radiated: No.2 New City Avenue Songshan Lake Sci. &Tech. Industry Park, Dongguan, Guangdong, P.R.C

BTL's test firm number for FCC: 319330

HUAWEI's test firm number for FCC: 97456

2.2 MEASUREMENT UNCERTAINTY

Where relevant, the following measurement uncertainty levels have been estimated for tests performed on the EUT as specified in CISPR 16-4-2. The BTL / HUAWEI measurement uncertainty is less than the CISPR 16-4-2 U_{cispr} requirement.

The reported uncertainty of measurement $y \pm U$, where expanded uncertainty U is based on a standard uncertainty multiplied by a coverage factor of $k=2$, providing a level of confidence of approximately **95%**.

System Measurement Uncertainty	
Items	Extended Uncertainty
RE(9KHz-30MHz)	$U(E)=4.2, k=2$
RSE(30MHz-26.5GHz)	$U=4.9, k=2$

Note: Unless specifically mentioned, the uncertainty of measurement has not been taken into account to declare the compliance or non-compliance to the specification.

3. GENERAL INFORMATION

3.1 GENERAL DESCRIPTION OF EUT

Equipment	LTE Module		
Brand Name	HUAWEI		
Model Name	ME919Bs-567a		
Model Difference	N/A		
Modulation Type	GSM/GPRS	GMSK	
	EDGE	GMSK, 8PSK	
	WCDMA	Uplink: BPSK Downlink: QPSK	
	WCDMA(HSDPA/HSUPA/HSPA+/DC-HSDPA/DC-HSUPA)	16QAM/64QAM	
	LTE	QPSK, 16QAM	
Operation Frequency	GSM /EDGE/GPRS	824.2 ~ 848.8 MHz	
	WCDMA Band 5	826.4 ~ 846.6 MHz	
	LTE 5 (Channel Bandwidth: 1.4MHz)	824.7 ~ 848.3 MHz	
	LTE 5 (Channel Bandwidth: 3MHz)	825.5 ~ 847.5 MHz	
	LTE 5 (Channel Bandwidth: 5MHz)	826.5 ~ 846.5 MHz	
	LTE 5 (Channel Bandwidth: 10MHz)	829.0 ~ 844.0 MHz	
Max. ERP Power	GSM/GPRS	GMSK	29.78 dBm
	EDGE	8PSK	25.72 dBm
	WCDMA	BPSK	21.44 dBm
	WCDMA_HSDPA	16QAM	21.42 dBm
	WCDMA_HSUPA	16QAM	21.42 dBm
	LTE 5 (Channel Bandwidth: 1.4MHz)	QPSK	21.61 dBm
		16QAM	20.87 dBm
	LTE 5 (Channel Bandwidth: 3MHz)	QPSK	21.74 dBm
		16QAM	21.23 dBm
	LTE 5 (Channel Bandwidth: 5MHz)	QPSK	22.06 dBm
		16QAM	21.25 dBm
	LTE 5 (Channel Bandwidth: 10MHz)	QPSK	21.90 dBm
16QAM		21.21 dBm	
Antenna Type	External Antenna		
Antenna Gain	2.5 dBi for GSM, 2.5 dBi for WCDMA, 2.5 dBi for LTE		
Hardware Version	RM1ME919BSTM		
Software Version	11.655.03.00.1419		

IMEI No.1	Radiated	004401727616498
	Conducted	354189080003885
Power Source	#1 Supplied from PC USB port or adapter. #2 Battery Supplied.	
Power Rating	#1 100-240V~ 50/60Hz #2 4.0V (3.8V-4.2V)	

Note:

For a more detailed features description, please refer to the manufacturer's specifications or the user's manual.

3.2 DESCRIPTION OF TEST MODES AND TEST CONDITION

Following channel(s) was (were) selected for the final test as listed below:

GSM MODE			
Test Item	Available Channel	Tested Channel	Mode
ERP	128 to 251	128, 190, 251	GSM, EDGE
Conducted Output Power	128 to 251	128, 190, 251	GSM, EDGE
Occupied Bandwidth	128 to 251	128, 190, 251	GSM, EDGE
Condcudeted Emission	128 to 251	190	GSM, EDGE
Radiated Emission	128 to 251	190	GSM, EDGE
Band Edge	128 to 251	128, 251	GSM, EDGE
Peak to Average Ratio	128 to 251	128, 190, 251	GSM, EDGE
Frequency Stability	128 to 251	190	GSM, EDGE

WCDMA MODE			
Test Item	Available Channel	Tested Channel	Mode
ERP	4132 to 4233	4132, 4182, 4233	WCDMA, HSDPA, HSUPA
Conducted Output Power	4132 to 4233	4132, 4182, 4233	WCDMA, HSDPA, HSUPA
Condcudeted Emission	4132 to 4233	4182	WCDMA, HSDPA, HSUPA
Radiated Emission	4132 to 4233	4182	WCDMA, HSDPA, HSUPA
Band Edge	4132 to 4233	4132, 4233	WCDMA, HSDPA, HSUPA
Peak to Average Ratio	4132 to 4233	4132, 4182, 4233	WCDMA, HSDPA, HSUPA
Frequency Stability	4132 to 4233	4182	WCDMA, HSDPA, HSUPA

Note: 1. This device was tested under all bandwidths, RB configurations and modulations. The worst case was found in **QPSK** modulation.

2. For 18G to 26.5G, the highest bandwidth is worst case and recording in the test report.

LTE BAND 5 MODE						
Test Item	Available Channel	Tested Channel	Channel Bandwidth	Modulation	Mode	
ERP	20407 to 20643	20407, 20525, 20643	1.4MHz	QPSK, 16QAM	1 RB / 0 RB Offset	
	20450 to 20600	20450, 20525, 20600	10MHz	QPSK, 16QAM	1 RB / 0 RB Offset	
Occupied Bandwidth	20407 to 20643	20407, 20525, 20643	1.4MHz	QPSK, 16QAM	6 RB / 0 RB Offset	
	20415 to 20635	20415, 20525, 20635	3MHz	QPSK, 16QAM	15 RB / 0 RB Offset	
	20425 to 20625	20425, 20525, 20625	5MHz	QPSK, 16QAM	25 RB / 0 RB Offset	
	20450 to 20600	20450, 20525, 20600	10MHz	QPSK, 16QAM	50 RB / 0 RB Offset	
Conducted Emission	20407 to 20643	20525	1.4MHz	QPSK	1 RB / 0 RB Offset	
	20415 to 20635	20525	3MHz	QPSK	1 RB / 0 RB Offset	
	20425 to 20625	20525	5MHz	QPSK	1 RB / 0 RB Offset	
	20450 to 20600	20525	10MHz	QPSK	1 RB / 0 RB Offset	
Radiated Emission	20407 to 20643	20525	1.4MHz	QPSK	1 RB / 0 RB Offset	
	20450 to 20600	20525	10MHz	QPSK	1 RB / 0 RB Offset	
Band Edge	20407 to 20643	20407	1.4MHz	QPSK	1 RB / 0 RB Offset 6 RB / 0 RB Offset	
		20643	1.4MHz	QPSK	1 RB / 5 RB Offset 6 RB / 0 RB Offset	
	20415 to 20635	20415	3MHz	QPSK	1 RB / 0 RB Offset 15 RB / 0 RB Offset	
		20635	3MHz	QPSK	1 RB / 14 RB Offset 15 RB / 0 RB Offset	
	20425 to 20625	20425	5MHz	QPSK	1 RB / 0 RB Offset 25 RB / 0 RB Offset	
		20625	5MHz	QPSK	1 RB / 24 RB Offset 25 RB / 0 RB Offset	
	20450 to 20600	20450	10MHz	QPSK	1 RB / 0 RB Offset 50 RB / 0 RB Offset	
		20600	10MHz	QPSK	1 RB / 49 RB Offset 50 RB / 0 RB Offset	
	Peak To Average Ratio	20407 to 20643	20407, 20525, 20643	1.4MHz	QPSK, 16QAM	1 RB / 0 RB Offset
		20415 to 20635	20415, 20525, 20635	3MHz	QPSK, 16QAM	1 RB / 0 RB Offset
		20425 to 20625	20425, 20525, 20625	5MHz	QPSK, 16QAM	1 RB / 0 RB Offset
		20450 to 20600	20450, 20525, 20600	10MHz	QPSK, 16QAM	1 RB / 0 RB Offset
Frequency Stability	20407 to 20643	20525	1.4MHz	QPSK	1 RB / 0 RB Offset	
	20415 to 20635	20525	3MHz	QPSK	1 RB / 0 RB Offset	
	20425 to 20625	20525	5MHz	QPSK	1 RB / 0 RB Offset	
	20450 to 20600	20525	10MHz	QPSK	1 RB / 0 RB Offset	

EUT TEST CONDITIONS:

Test Item	Environmental Conditions	Test Voltage
ERP	25°C, 60%RH	DC 4.0V
Conducted Output Power	25°C, 65%RH	DC 4.0V
Occupied Bandwidth	25°C, 65%RH	DC 4.0V
Conducted Emission	25°C, 65%RH	DC 4.0V
Radiated Emission	25°C, 60%RH	AC 120V/60Hz
Band Edge	25°C, 65%RH	DC 4.0V
Peak to Average Ratio	25°C, 65%RH	DC 4.0V
Frequency Stability	25°C, 65%RH	DC 4.0V

3.3 BLOCKDIGRAMSHOWINGTHECONFIGURATIONOFSYSTEMTESTED FOR RADIATED

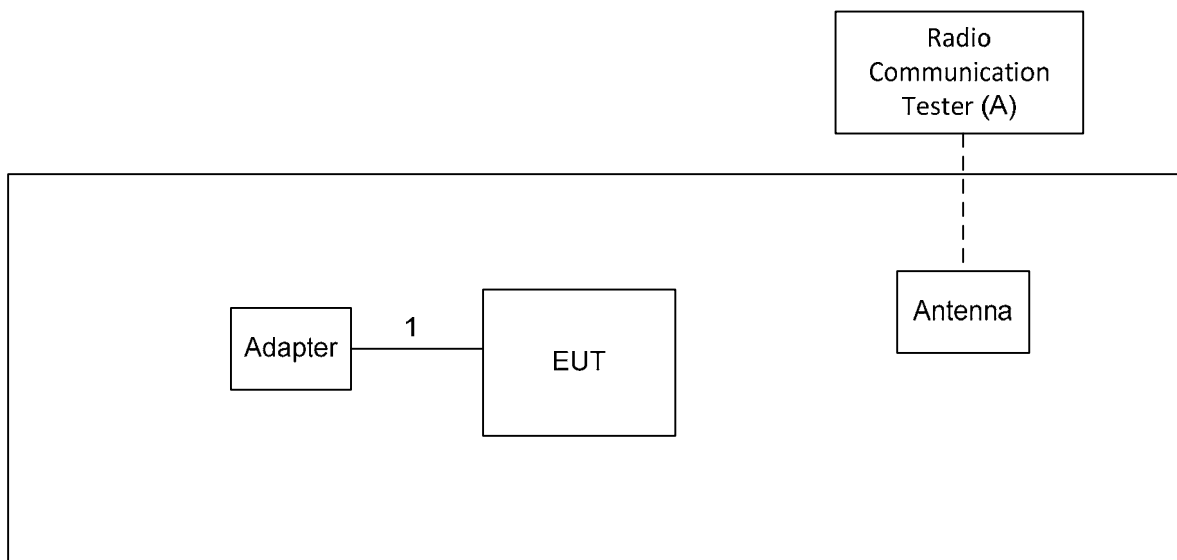

3.4 DESCRIPTION OF SUPPORT UNITS

The EUT has been tested as an independent unit together with other necessary accessories or support units. The following support units or accessories were used to form a representative test configuration during the tests.

Item	Equipment	Mfr/Brand	Model/Type No.	FCC ID	Series No.
A	Radio Communication Tester	R&S	CMU200	N/A	3608082535
		Anritsu	MT8820C	N/A	A110518805
B	Adaptor	Huawei	HW-050200U3W	N/A	HWHKA8G62400013

Item	Shielded Type	Ferrite Core	Length	Note
1	YES	NO	1m	USB cable

4. TEST RESULT

4.1 OUTPUT POWER MEASUREMENT

4.1.1 LIMIT

Mobile / Portable station are limited to 7 watts e.r.p.

4.1.2 TEST PROCEDURE

EIRP/ERP:

1. EIRP= Conducted Power +Antenan gain
ERP power=EIPR power-2.15dBi.

Conducted Power:

The EUT was set up for the maximum power with GSM, GPRS, EDGE, WCDMA and LTE link data modulation and link up with simulator. Set the EUT to transmit under low, middle and high channel and record the power level shown on simulator.

4.1.3 TESTSETUP LAYOUT

Conducted Power Measurement

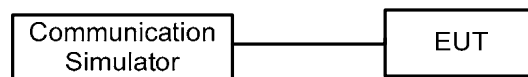

4.1.4 TEST DEVIATION

No deviation

4.1.5 TEST RESULTS

Please refer to the Attachment A.

4.2 OCCUPIED BANDWIDTH MEASUREMENT

4.2.1 TEST PROCEDURE

The EUT makes a call to the communication simulator. All measurements were done at low, middle and high operational frequency range. The communication simulator station system controlled a EUT to export maximum output power under transmission mode and specific channel frequency. Use OBW measurement function of Spectrum analyzer to measure 99 % occupied bandwidth and 26dB bandwidth.

4.2.2 TEST SETUP LAYOUT

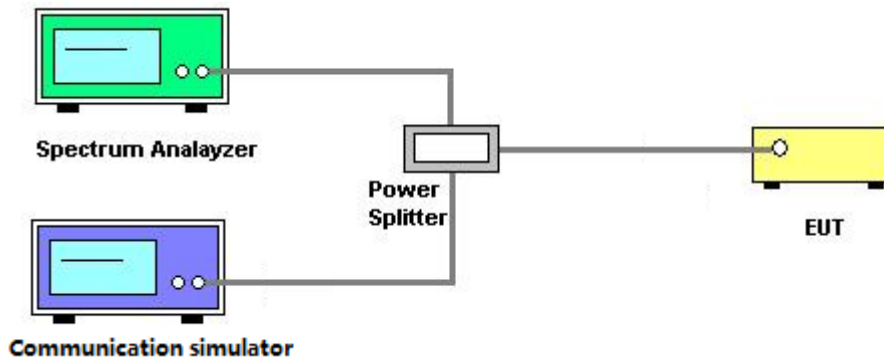

4.2.3 TEST DEVIATION

No deviation

4.2.4 TEST RESULTS

Please refer to the Attachment B.

4.3 CONDUCTED EMISSIONS MEASUREMENT

4.3.1 LIMIT

The power of any emission outside of the authorized operating frequency ranges must be attenuated below the transmitting power (P) by a factor of at least $43 + 10 \log(P)$ dB. The emission limit equal to -13dBm .

4.3.2 TEST PROCEDURES

1. The testing follows FCC KDB 971168 v02r02 Section 6.0.
2. The EUT was connected to spectrum analyzer and system simulator via a power divider.
3. The band edges of low and high channels for the highest RF powers were measured. Set $\text{RBW} \geq 1\%$ EBW in the 1MHz band immediately outside and adjacent to the band edge.
4. Set spectrum analyzer with RMS detector.
5. The RF fundamental frequency should be excluded against the limit line in the operating frequency band.
6. The limit line is derived from $43+10\log(P)\text{dB}$ below the transmitter power P(Watts)

$$= P(\text{W}) - [43 + 10\log(P)](\text{dB})$$

$$= [30 + 10\log(P)](\text{dBm}) - [43 + 10\log(P)](\text{dB})$$

$$= -13\text{dBm}$$

4.3.3 TESTSETUP LAYOUT

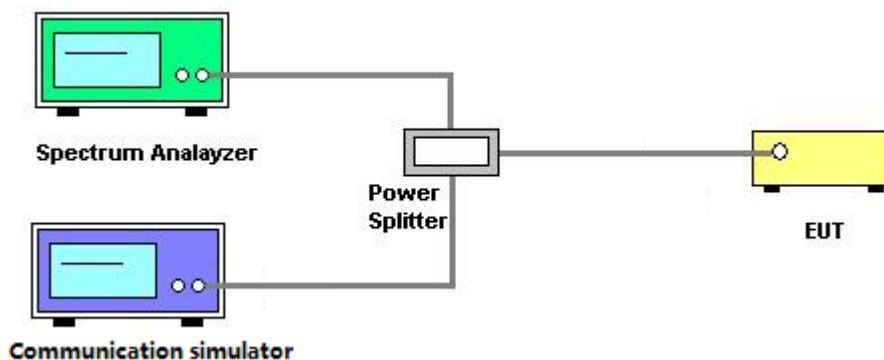

4.3.4 TESTDEVIATION

No deviation

4.3.5 TEST RESULTS

Please refer to the Attachment C.

4.4 RADIATED EMISSIONS MEASUREMENT

4.4.1 LIMIT

The power of any emission outside of the authorized operating frequency ranges must be attenuated below the transmitting power (P) by a factor of at least $43 + 10 \log(P)$ dB. The emission limit equal to -13dBm.

4.4.2 TEST PROCEDURES

1. Substitution method is used for E.I.R.P measurement. In the semi-anechoic chamber, EUT placed on the 0.8m height of Turn Table, rotated the table around 360 degrees to search the maximum radiation power and receiver antenna shall be rotated vertical and horizontal polarization and moved height from 1m to 4m to find the maximum polar radiated power. The "Read Value" is the spectrum reading the maximum power value.
2. The substitution horn antenna is substituted for EUT at the same position and signals generator export the CW signal to the substitution antenna via a TX cable. Rotated the Turn Table and moved receiving antenna to find the maximum radiation power. Adjust output power level of S.G to get a Value of spectrum reading equal to "Read Value " of step a. Record the power level of S.G
3. EIRP = Output power level of S.G – TX cable loss + Antenna gain of substitution horn.
4. E.R.P power can be calculated form E.I.R.P power by subtracting the gain of dipole, E.R.P power = E.I.P.R power - 2.15dBi.
5. The resolution bandwidth and video bandwidth of test receiver/spectrum analyzer is 1MHz/3MHz.

4.4.3 TESTSETUP LAYOUT

This test setup layout is the same as that shown in **section 4.1.3**.

4.4.4 TESTDEVIATION

No deviation

4.4.5 TEST RESULTS

Please refer to the Attachment D.

4.5 BAND EDGE MEASUREMENT

4.5.1 LIMIT

A Power of any emission outside of the authorized operating frequency ranges must be attenuated below the transmitting power (P) by a factor of at least $43 + 10 \log(P)$ dB. In the 1 MHz bands immediately outside and adjacent to the frequency block a resolution bandwidth of at least one percent of the emission bandwidth of the fundamental emission of the transmitter may be employed.

4.5.2 TEST PROCEDURES

1. All measurements were done at low and high operational frequency range.
2. The center frequency of spectrum is the band edge frequency and span is 1MHz. RB of the spectrum is 3kHz and VB of the spectrum is 10kHz (GSM/GPRS/EDGE).
3. The center frequency of spectrum is the band edge frequency and span is 5MHz. RB of the spectrum is 100kHz and VB of the spectrum is 300kHz (WCDMA).
4. The center frequency of spectrum is the band edge frequency and span is 1MHz. RB of the spectrum is 13kHz and VB of the spectrum is 51kHz (LTE Bandwidth 1.4MHz).
5. The center frequency of spectrum is the band edge frequency and span is 1MHz. RB of the spectrum is 30kHz and VB of the spectrum is 100kHz (LTE Bandwidth 3MHz).
6. The center frequency of spectrum is the band edge frequency and span is 1MHz. RB of the spectrum is 100kHz and VB of the spectrum is 300kHz (LTE Bandwidth 5MHz/10MHz).
7. Record the max trace plot into the test report.

4.5.3 TESTSETUP LAYOUT

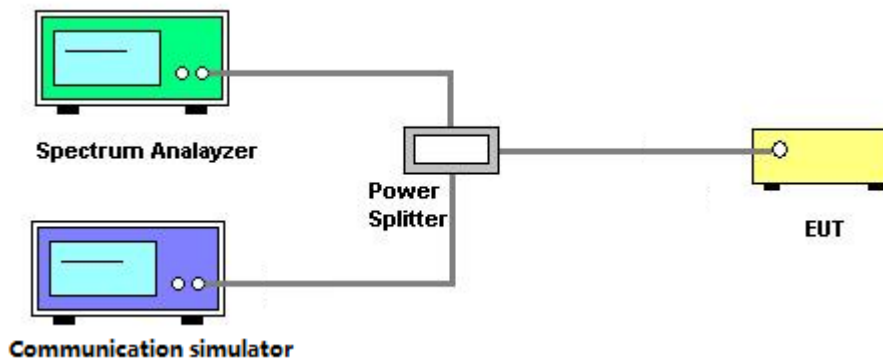

4.5.4 TESTDEVIATION

No deviation

4.5.5 TEST RESULTS

Please refer to the Attachment E.

4.6 PEAK TO AVERAGE RATIO MEASUREMENT

4.6.1 LIMIT

In measuring transmissions in this band using an average power technique, the peak to-average ratio (PAR) of the transmission may not exceed 13 dB.

4.6.2 TEST PROCEDURES

1. Set resolution/measurement bandwidth \geq signal's occupied bandwidth;
2. Set the number of counts to a value that stabilizes the measured CCDF curve;
3. Record the maximum PAPR level associated with a probability of 0.1%.

4.6.3 TESTSETUP LAYOUT

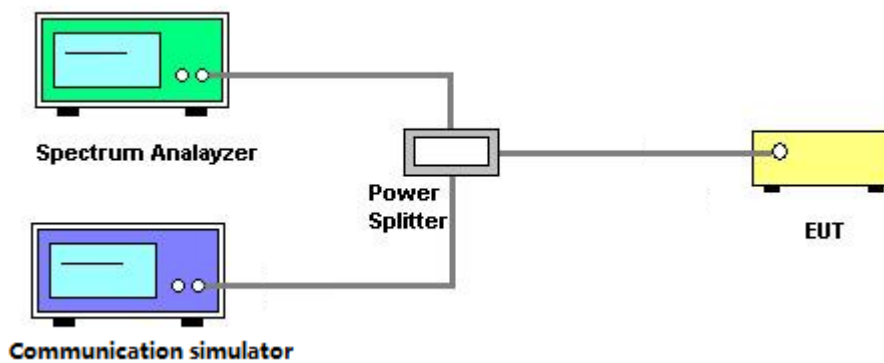

4.6.4 TESTDEVIATION

No deviation

4.6.5 TEST RESULTS

Please refer to the Attachment F.

4.7 FREQUENCY STABILITY MEASUREMENT

4.7.1 LIMIT

1.5 ppm is for base and fixed station. 2.5 ppm is for mobile station.

4.7.2 TEST PROCEDURES

1. Device is placed at the oven room. The oven room could control the temperatures and humidity. Power warm up is at least 15 min and power applied should perform before recording frequency error.
2. EUT is connected the external power supply to control the DC input power. The test voltage range is from minimum to maximum working voltage. Each step shall be record the frequency error rate.
3. The temperature range step is 10 degrees in this test items. All temperature levels shall be hold the $\pm 0.5^{\circ}\text{C}$ during the measurement testing. The each temperature step shall be at least 0.5 hours, consider the EUT could be test under the stability condition.
4. The frequency error was recorded frequency error from the communication simulator.

4.7.3 TESTSETUP LAYOUT

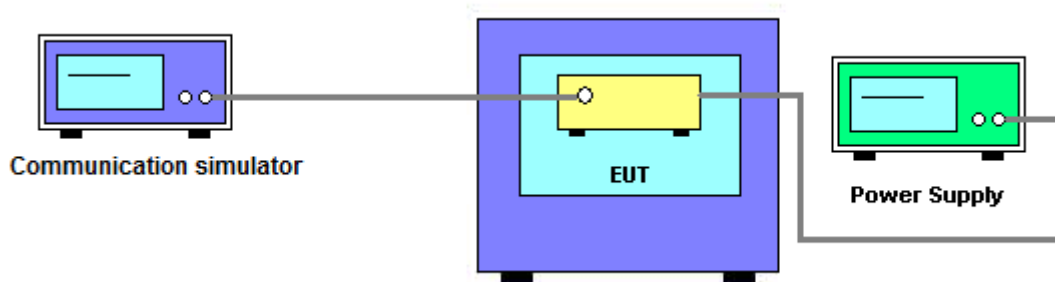

4.7.4 TESTDEVIATION

No deviation

4.7.5 TEST RESULTS

Please refer to the Attachment G.

5. List of measurement equipments

Radiated Emission Measurement					
Item	Kind of Equipment	Manufacturer	Type No.	Serial No.	Calibrated until
1	Test receiver	R&S	ESU26	100387	Jul. 21, 2017
2	LOOP Antennas(9kHz-30MHz)	R&S	HFH2-Z2	100263	Apr. 29, 2017
3	Spectrum analyzer	R&S	FSU3	200474	May 24, 2017
4	Spectrum analyzer	R&S	FSU43	100144	Jun. 02, 2017
5	Trilog Broadband Antenna (30M~3GHz)	SCHWARZBECK	VULB 9163	9163-521	Apr. 08, 2017
6	Double-Ridged Waveguide Horn Antenna (1G~18GHz)	R&S	HF907	100304	Apr. 29, 2017
7	Pyramidal Horn Antenna(18GHz-26.5 GHz)	ETS-Lindgren	Sep-60	5140299	Jul. 14, 2017
8	Radio Communication Tester	R&S	CMU200	3608082535	Mar. 30, 2017
9	Radio Communication Tester	Anritsu	MT8820C	A110518805	May 23, 2017

Conducted Emission & Band Edge & Occupied Bandwidth Measurement					
Item	Kind of Equipment	Manufacturer	Type No.	Serial No.	Calibrated until
1	Wireless Communication Test SET	Agilent	E5515C	MY48364183	Mar. 27, 2017
2	EXA Spectrum Analyzer	Agilent	N9010A	MY50520044	Mar. 27, 2017
3	POWER SPLITTER	Mini-Circuits	ZFRSC-123-S+	331000910-1	Feb. 26, 2017
4	wideband radio communication tester	R&S	CMW500	152372	Mar. 27, 2017
5	Cable	N/A	RG316(0.3m)	N/A	Jul. 06, 2017
6	Cable	N/A	RG316(0.3m)	N/A	Jul. 06, 2017

Frequency Stability Measurement					
Item	Kind of Equipment	Manufacturer	Type No.	Serial No.	Calibrated until
1	Wireless Communication Test SET	Agilent	E5515C	MY48364183	Mar. 27, 2017
2	DC power supply	GW Instek	GPC-3030DN	EK880675	Oct. 13, 2017
3	POWER SPLITTER	Mini-Circuits	ZFRSC-123-S+	331000910-1	Feb. 26, 2017
4	wideband radio communication tester	R&S	CMW500	152372	Mar. 27, 2017
5	Const Temp, & Humidity Chamber	Giant?Force	ITH-225-20-S	IAB0309-001	Sep. 04, 2017
6	Cable	N/A	RG316(0.3m)	N/A	Jul. 06, 2017

Remark: "N/A" denotes no model name, serial no. or calibration specified.
 All calibration period of equipment list is one year.

ATTACHMENT A - OUTPUT POWER

Conducted Power:

GSM850 (Capsensor Off)	Burst Conducted Power (dBm)		
	128CH	190CH	251CH
	824.2MHz	836.6MHz	848.8MHz
GSM (CS)	-	-	-
GPRS/EDGE (GMSK)	31.90	31.93	31.84
	30.35	30.25	30.30
	29.41	29.41	29.50
	27.42	27.52	27.50
EDGE (8PSK)	27.87	27.66	27.42
	25.36	25.32	25.54
	24.06	24.10	24.15
	22.46	22.63	22.72

Modulation	Band	WCDMA V(Capsensor Off)		
	Tx Channel	4132CH	4182CH	4233CH
	Rx Channel	4357CH	4407CH	4458CH
	Frequency	826.4MHz	836.4MHz	846.6MHz
BPSK	RMC 12.2K	23.44	23.37	23.52
	RMC 64K	23.48	23.33	23.56
	RMC 144K	23.47	23.44	23.59
	RMC 384K	23.45	23.45	23.54
16QAM	HSDPA Subtest-1	23.45	23.41	23.57
	HSDPA Subtest-2	22.99	22.90	23.02
	HSDPA Subtest-3	22.37	22.29	22.41
	HSDPA Subtest-4	22.34	22.32	22.42
16QAM	HSUPA Subtest-1	22.95	22.90	23.02
	HSUPA Subtest-2	23.52	23.44	23.53
	HSUPA Subtest-3	22.34	22.32	22.42
	HSUPA Subtest-4	23.50	23.33	23.51
	HSUPA Subtest-5	23.48	23.44	23.57

LTE Band / BW	Modulation	RB Sizing	RB Offset	Low CH	Mid CH	High CH
				20407 CH	20525 CH	20643 CH
				824.7 MHz	836.5 MHz	848.3 MHz
5 / 1.4M	QPSK	1	0	23.51	23.28	22.91
		1	2	23.68	23.47	23.00
		1	5	23.70	23.52	22.84
		3	0	23.68	23.37	22.94
		3	1	23.73	23.46	22.94
		3	3	23.76	23.51	22.91
	16QAM	6	0	23.15	22.96	22.32
		1	0	22.78	22.80	22.08
		1	2	22.94	22.95	22.18
		1	5	22.94	23.02	22.02
		3	0	22.87	22.62	22.22
		3	1	22.93	22.69	22.23
		3	3	22.96	22.75	22.19
		6	0	22.31	22.08	21.54

LTE Band / BW	Modulation	RB Sizing	RB Offset	Low CH	Mid CH	High CH
				20415 CH	20525 CH	20635 CH
				825.5 MHz	836.5 MHz	847.5 MHz
5 / 3M	QPSK	1	0	23.36	22.97	22.64
		1	7	23.89	23.53	23.00
		1	14	23.36	23.55	22.67
		8	0	23.14	22.71	22.15
		8	3	23.27	22.98	22.30
		8	7	23.12	23.08	22.26
		15	0	23.16	22.96	22.22
	16QAM	1	0	22.80	22.34	22.03
		1	7	23.38	23.03	22.39
		1	14	22.79	23.06	21.99
		8	0	22.23	21.89	21.32
		8	3	22.39	22.11	21.47
		8	7	22.20	22.20	21.42
		15	0	22.23	22.01	21.34

LTE Band / BW	Modulation	RB Sizing	RB Offset	Low CH	Mid CH	High CH
				20425 CH	20525 CH	20625 CH
				826.5 MHz	836.5 MHz	846.5 MHz
5 / 5M	QPSK	1	0	24.00	23.22	23.42
		1	12	23.73	23.60	22.85
		1	24	23.53	24.21	23.15
		12	0	23.20	22.53	22.25
		12	6	23.21	22.93	22.22
		12	13	23.00	23.11	22.23
		25	0	23.04	22.81	22.18
	16QAM	1	0	23.29	22.49	22.81
		1	12	23.12	22.87	22.23
		1	24	22.83	23.40	22.49
		12	0	22.29	21.69	21.37
		12	6	22.32	22.00	21.33
		12	13	22.11	22.18	21.35
		25	0	22.15	21.86	21.31

LTE Band / BW	Modulation	RB Sizer	RB Offset	Low CH	Mid CH	High CH
				20450 CH	20525 CH	20600 CH
				829.0 MHz	836.5 MHz	844.0 MHz
5 / 10M	QPSK	1	0	23.66	22.60	24.00
		1	24	23.10	23.57	23.27
		1	49	22.66	24.05	22.88
		25	0	22.91	22.22	23.06
		25	12	22.55	22.89	22.48
		25	25	21.89	23.09	22.02
		50	0	22.44	22.73	22.43
	16QAM	1	0	22.99	22.01	23.12
		1	24	22.40	22.91	22.34
		1	49	21.98	23.36	22.03
		25	0	21.96	21.32	22.01
		25	12	21.58	21.94	21.54
		25	25	20.97	22.05	21.14
		50	0	21.51	21.69	21.46

ERP Power:

GSM850 (Capsensor Off)	ERP Power (dBm)		
	128CH	190CH	251CH
	824.2MHz	836.6MHz	848.8MHz
GSM (CS)	-	-	-
GPRS/EDGE (GMSK)	29.75	29.78	29.69
	28.20	28.10	28.15
	27.26	27.26	27.35
	25.27	25.37	25.35
EDGE (8PSK)	25.72	25.51	25.27
	23.21	23.17	23.39
	21.91	21.95	22.00
	20.31	20.48	20.57

Modulation	Band	WCDMA V(Capsensor Off)		
	Tx Channel	4132CH	4182CH	4233CH
	Rx Channel	4357CH	4407CH	4458CH
	Frequency	826.4MHz	836.4MHz	846.6MHz
BPSK	RMC 12.2K	21.29	21.22	21.37
	RMC 64K	21.33	21.18	21.41
	RMC 144K	21.32	21.29	21.44
	RMC 384K	21.30	21.30	21.39
16QAM	HSDPA Subtest-1	21.30	21.26	21.42
	HSDPA Subtest-2	20.84	20.75	20.87
	HSDPA Subtest-3	20.22	20.14	20.26
	HSDPA Subtest-4	20.19	20.17	20.27
16QAM	HSUPA Subtest-1	20.80	20.75	20.87
	HSUPA Subtest-2	21.37	21.29	21.38
	HSUPA Subtest-3	20.19	20.17	20.27
	HSUPA Subtest-4	21.35	21.18	21.36
	HSUPA Subtest-5	21.33	21.29	21.42

LTE Band / BW	Modulation	RB Sizing	RB Offset	Low CH	Mid CH	High CH
				20407 CH	20525 CH	20643 CH
				824.7 MHz	836.5 MHz	848.3 MHz
5 / 1.4M	QPSK	1	0	21.36	21.13	20.76
		1	2	21.53	21.32	20.85
		1	5	21.55	21.37	20.69
		3	0	21.53	21.22	20.79
		3	1	21.58	21.31	20.79
		3	3	21.61	21.36	20.76
	16QAM	6	0	21.00	20.81	20.17
		1	0	20.63	20.65	19.93
		1	2	20.79	20.80	20.03
		1	5	20.79	20.87	19.87
		3	0	20.72	20.47	20.07
		3	1	20.78	20.54	20.08
		3	3	20.81	20.60	20.04
		6	0	20.16	19.93	19.39

LTE Band / BW	Modulation	RB Sizing	RB Offset	Low CH	Mid CH	High CH
				20415 CH	20525 CH	20635 CH
				825.5 MHz	836.5 MHz	847.5 MHz
5 / 3M	QPSK	1	0	21.21	20.82	20.49
		1	7	21.74	21.38	20.85
		1	14	21.21	21.40	20.52
		8	0	20.99	20.56	20.00
		8	3	21.12	20.83	20.15
		8	7	20.97	20.93	20.11
	16QAM	15	0	21.01	20.81	20.07
		1	0	20.65	20.19	19.88
		1	7	21.23	20.88	20.24
		1	14	20.64	20.91	19.84
		8	0	20.08	19.74	19.17
		8	3	20.24	19.96	19.32
		8	7	20.05	20.05	19.27
		15	0	20.08	19.86	19.19

LTE Band / BW	Modulation	RB Sizing	RB Offset	Low CH	Mid CH	High CH
				20425 CH	20525 CH	20625 CH
				826.5 MHz	836.5 MHz	846.5 MHz
5 / 5M	QPSK	1	0	21.85	21.07	21.27
		1	12	21.58	21.45	20.70
		1	24	21.38	22.06	21.00
		12	0	21.05	20.38	20.10
		12	6	21.06	20.78	20.07
		12	13	20.85	20.96	20.08
	16QAM	25	0	20.89	20.66	20.03
		1	0	21.14	20.34	20.66
		1	12	20.97	20.72	20.08
		1	24	20.68	21.25	20.34
		12	0	20.14	19.54	19.22
		12	6	20.17	19.85	19.18
		12	13	19.96	20.03	19.20
		25	0	20.00	19.71	19.16

LTE Band / BW	Modulation	RB Sizer	RB Offset	Low CH	Mid CH	High CH
				20450 CH	20525 CH	20600 CH
				829.0 MHz	836.5 MHz	844.0 MHz
5 / 10M	QPSK	1	0	21.51	20.45	21.85
		1	24	20.95	21.42	21.12
		1	49	20.51	21.90	20.73
		25	0	20.76	20.07	20.91
		25	12	20.40	20.74	20.33
		25	25	19.74	20.94	19.87
		50	0	20.29	20.58	20.28
	16QAM	1	0	20.84	19.86	20.97
		1	24	20.25	20.76	20.19
		1	49	19.83	21.21	19.88
		25	0	19.81	19.17	19.86
		25	12	19.43	19.79	19.39
		25	25	18.82	19.90	18.99
		50	0	19.36	19.54	19.31

ATTACHMENT B - OCCUPIED BANDWIDTH

GSM850					
GSM			EDGE		
CS			8PSK		
Channel	Frequency (MHz)	99% Occupied Bandwidth (MHz)	Channel	Frequency (MHz)	99% Occupied Bandwidth (MHz)
128	824.2	0.241	128	824.2	0.255
190	836.6	0.245	190	836.6	0.252
251	848.8	0.245	251	848.8	0.251
Channel	Frequency (MHz)	26dB Bandwidth (MHz)	Channel	Frequency (MHz)	26dB Bandwidth (MHz)
128	824.2	0.311	128	824.2	0.322
190	836.6	0.313	190	836.6	0.323
251	848.8	0.313	251	848.8	0.320

Spectrum Plot

GSM -128



GSM-190

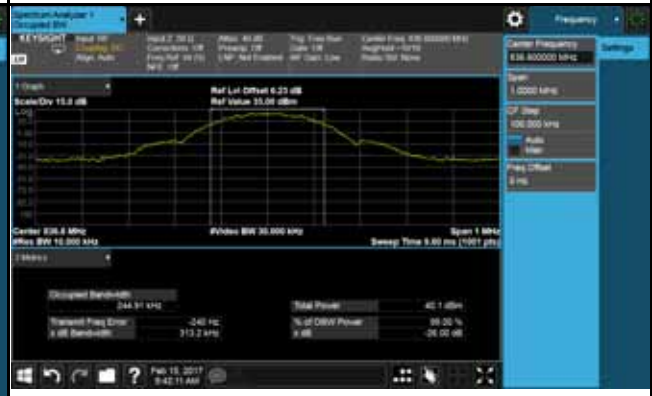

GSM-251



EDGE-128

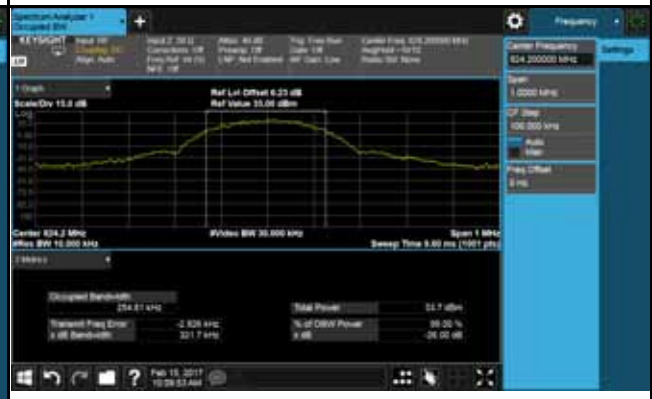

EDGE-190



EDGE-251

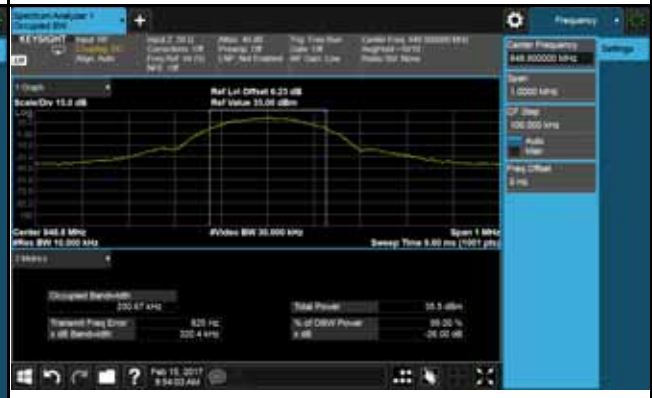

WCDMA Band V					
Channel	Frequency (MHz)	99% Occupied Bandwidth (MHz)	Channel	Frequency (MHz)	26dB Bandwidth (MHz)
4132	826.4	4.132	4132	826.4	4.698
4182	836.4	4.146	4182	836.4	4.719
4233	846.6	4.128	4233	846.6	4.700

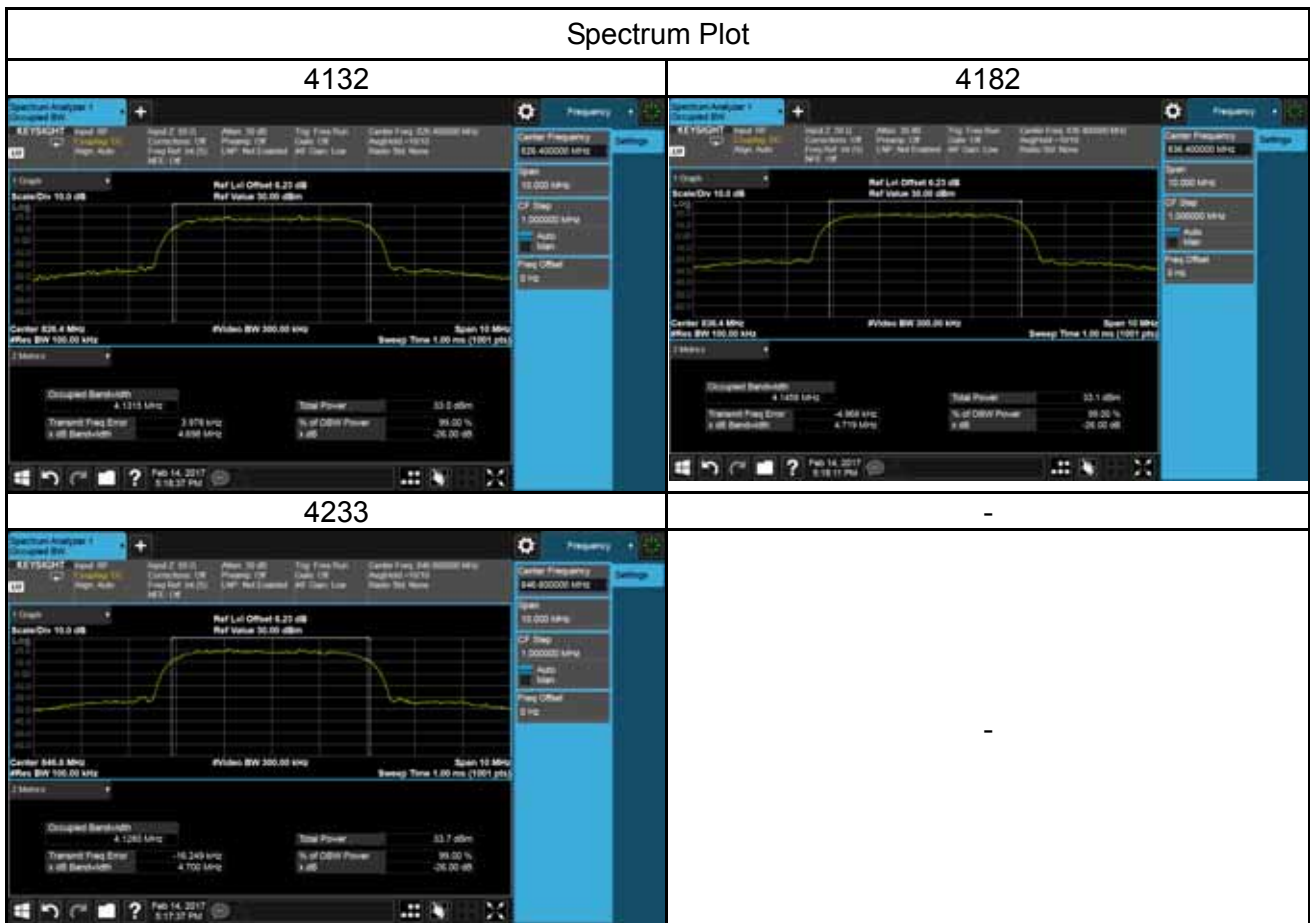

WCDMA_HSDPA Band V					
Channel	Frequency (MHz)	99% Occupied Bandwidth (MHz)	Channel	Frequency (MHz)	26dB Bandwidth (MHz)
4132	826.4	4.130	4132	826.4	4.703
4182	836.4	4.153	4182	836.4	4.739
4233	846.6	4.145	4233	846.6	4.684

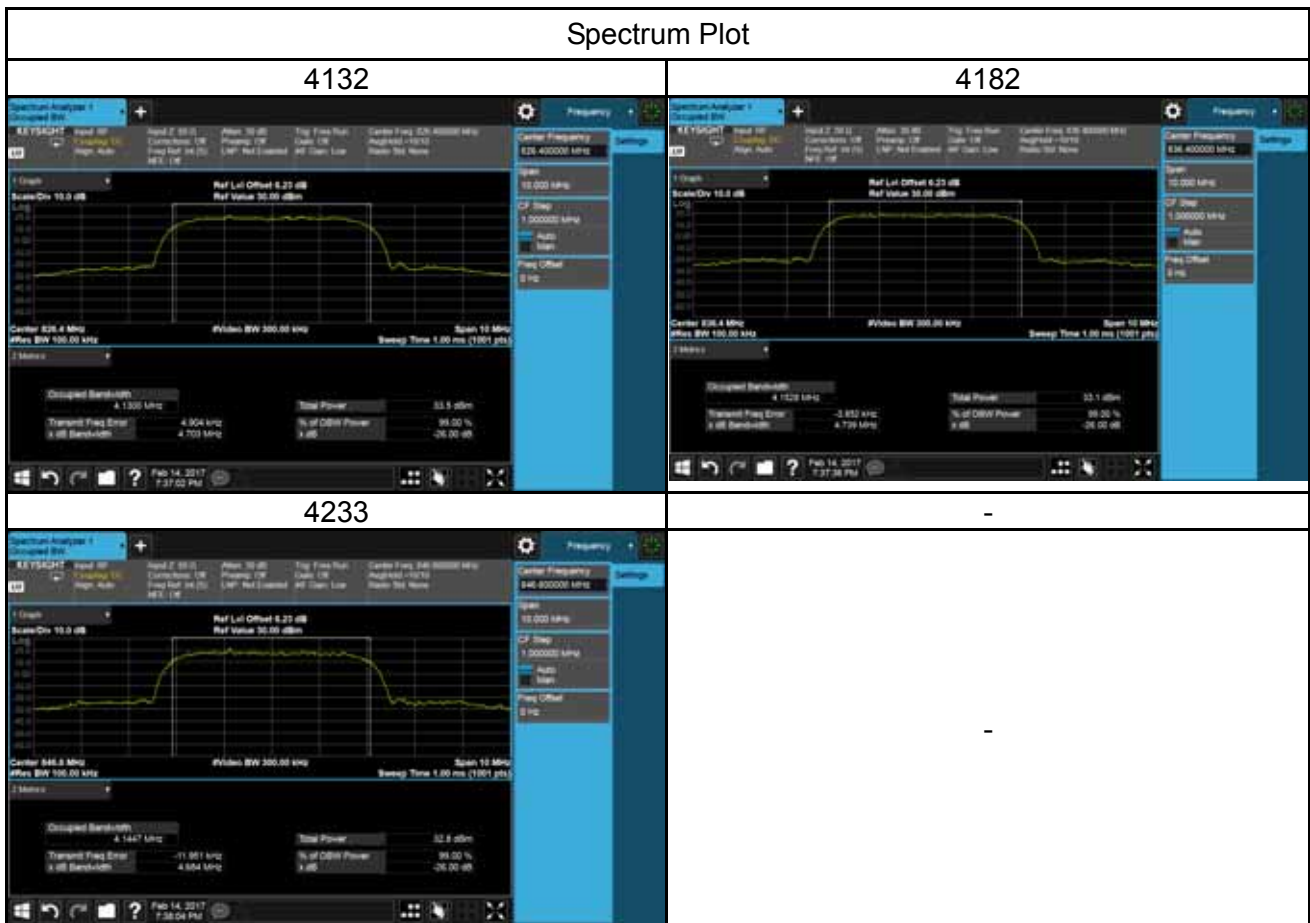

WCDMA_HSUPA Band V					
Channel	Frequency (MHz)	99% Occupied Bandwidth (MHz)	Channel	Frequency (MHz)	26dB Bandwidth (MHz)
4132	826.4	4.132	4132	826.4	4.706
4182	836.4	4.152	4182	836.4	4.727
4233	846.6	4.1349	4233	846.6	4.687

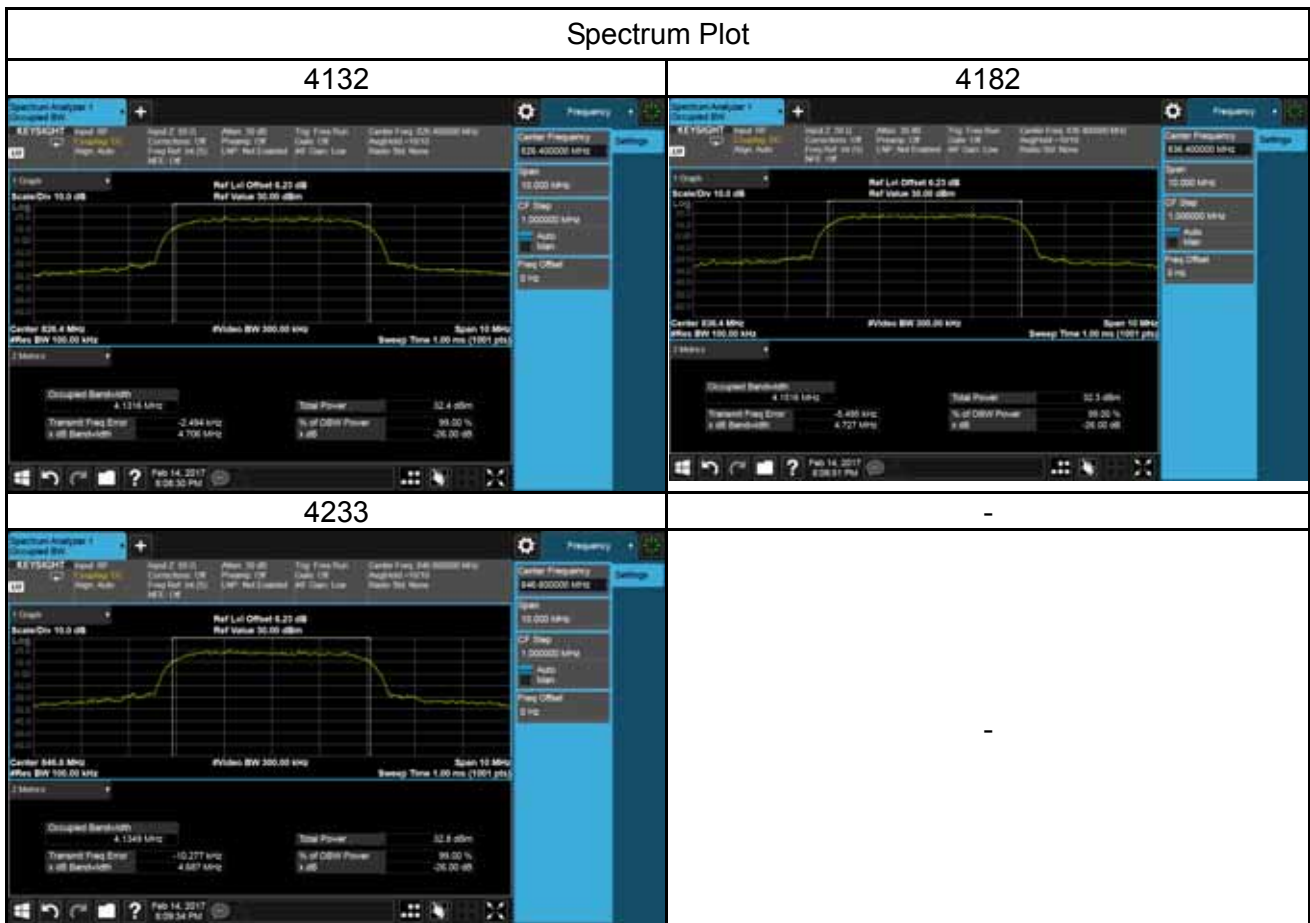

LTE Band 5_1.4M					
QPSK			16QAM		
Channel	Frequency (MHz)	99% Occupied Bandwidth (MHz)	Channel	Frequency (MHz)	99% Occupied Bandwidth (MHz)
20407	824.7	1.092	20407	824.7	1.090
20525	836.5	1.093	20525	836.5	1.091
20643	848.3	1.090	20643	848.3	1.090
Channel	Frequency (MHz)	26dB Bandwidth (MHz)	Channel	Frequency (MHz)	26dB Bandwidth (MHz)
20407	824.7	1.234	20407	824.7	1.228
20525	836.5	1.227	20525	836.5	1.237
20643	848.3	1.232	20643	848.3	1.237

Spectrum Plot

QPSK-20407

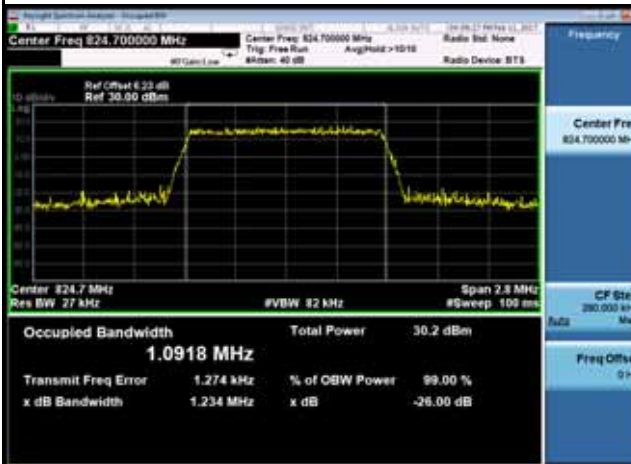

QPSK-20525



QPSK-20643

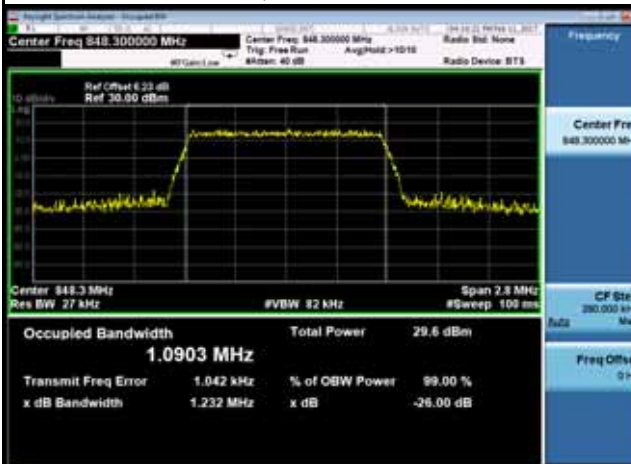

16QAM-20407



16QAM-20525



16QAM-20643



LTE Band 5_3M					
QPSK			16QAM		
Channel	Frequency (MHz)	99% Occupied Bandwidth (MHz)	Channel	Frequency (MHz)	99% Occupied Bandwidth (MHz)
20415	825.5	2.698	20415	825.5	2.698
20525	836.5	2.702	20525	836.5	2.700
20635	847.5	2.700	20635	847.5	2.692
Channel	Frequency (MHz)	26dB Bandwidth (MHz)	Channel	Frequency (MHz)	26dB Bandwidth (MHz)
20415	825.5	2.970	20415	825.5	2.964
20525	836.5	2.962	20525	836.5	2.985
20635	847.5	2.961	20635	847.5	2.967

Spectrum Plot

QPSK-20415



QPSK-20525



QPSK-20635

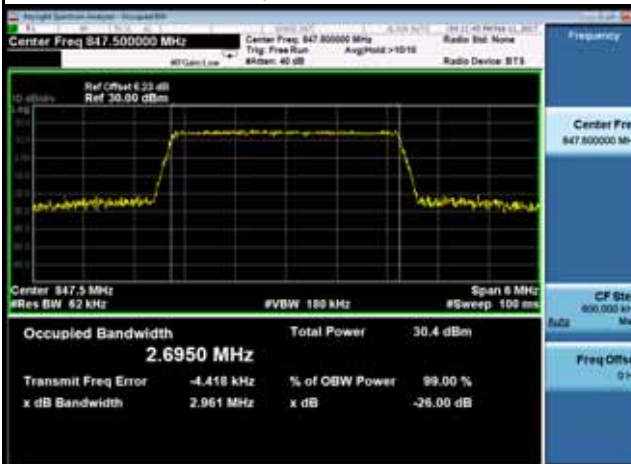

16QAM-20415

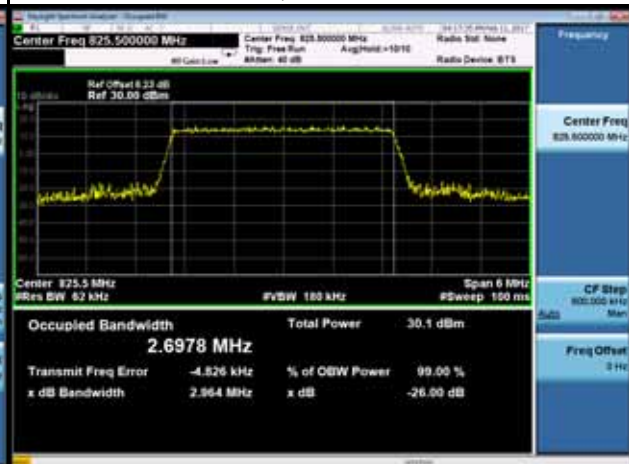

16QAM-20525



16QAM-20635



LTE Band 5_5M					
QPSK			16QAM		
Channel	Frequency (MHz)	99% Occupied Bandwidth (MHz)	Channel	Frequency (MHz)	99% Occupied Bandwidth (MHz)
20425	826.5	4.496	20425	826.5	4.504
20525	836.5	4.503	20525	836.5	4.516
20625	846.5	4.503	20625	846.5	4.503
Channel	Frequency (MHz)	26dB Bandwidth (MHz)	Channel	Frequency (MHz)	26dB Bandwidth (MHz)
20425	826.5	4.953	20425	826.5	4.941
20525	836.5	4.928	20525	836.5	4.943
20625	846.5	4.966	20625	846.5	4.930

Spectrum Plot

QPSK-20425

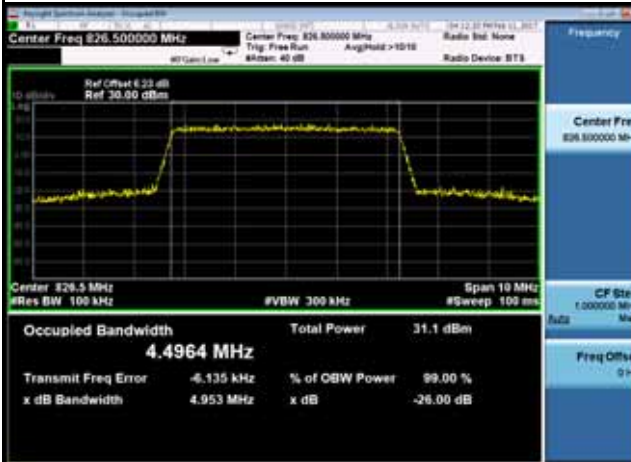

QPSK-20525



QPSK-20625



16QAM-20425



16QAM-20525



16QAM-20625



LTE Band 5_10M					
QPSK			16QAM		
Channel	Frequency (MHz)	99% Occupied Bandwidth (MHz)	Channel	Frequency (MHz)	99% Occupied Bandwidth (MHz)
20450	829.0	8.971	20450	829.0	8.972
20525	836.5	9.002	20525	836.5	8.988
20600	844.0	8.977	20600	844.0	8.959
Channel	Frequency (MHz)	26dB Bandwidth (MHz)	Channel	Frequency (MHz)	26dB Bandwidth (MHz)
20450	829.0	9.979	20450	829.0	9.762
20525	836.5	9.809	20525	836.5	9.880
20600	844.0	9.803	20600	844.0	9.799

Spectrum Plot

QPSK-20450



QPSK-20525



QPSK-20600

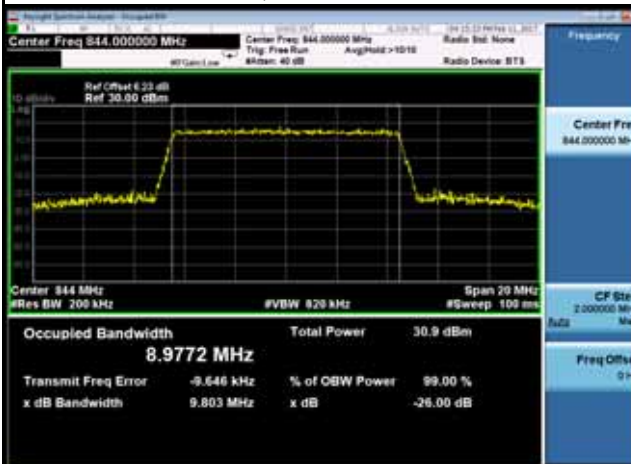

16QAM-20450



16QAM-20525



16QAM-20600



ATTACHMENT C - CONDUCTED EMISSIONS

GSM850			
GSM		GSM	
Channel	Frequency(MHz)	Channel	Frequency(MHz)
190	836.6	190	836.6
GSM		EDGE	
Channel	Frequency(MHz)	Channel	Frequency(MHz)
190	836.6	190	836.6
EDGE		EDGE	
Channel	Frequency(MHz)	Channel	Frequency(MHz)
190	836.6	190	836.6

WCDMA Band V			
Channel	Frequency(MHz)	Channel	Frequency(MHz)
4182	836.4	4182	836.4
Channel	Frequency(MHz)	-	-
4182	836.4	-	-
		-	

WCDMA_HSDPA Band V			
Channel	Frequency(MHz)	Channel	Frequency(MHz)
4182	836.4	4182	836.4
Channel	Frequency(MHz)	-	-
4182	836.4	-	-
		-	

WCDMA_HSUPA Band V			
Channel	Frequency(MHz)	Channel	Frequency(MHz)
4182	836.4	4182	836.4
Channel	Frequency(MHz)	-	-
4182	836.4	-	-
		-	

LTE Band 5_1.4M			
Channel	Frequency(MHz)	Channel	Frequency(MHz)
20525	836.5	20525	836.5
Channel	Frequency(MHz)	-	-
20525	836.5	-	-
		-	

LTE Band 5_3M			
Channel	Frequency(MHz)	Channel	Frequency(MHz)
20525	836.5	20525	836.5
Channel	Frequency(MHz)	-	-
20525	836.5	-	-
		-	

LTE Band 5_5M			
Channel	Frequency(MHz)	Channel	Frequency(MHz)
20525	836.5	20525	836.5
Channel	Frequency(MHz)	-	-
20525	836.5	-	-
		-	

LTE Band 5_10M			
Channel	Frequency(MHz)	Channel	Frequency(MHz)
20525	836.5	20525	836.5
Channel	Frequency(MHz)	-	-
20525	836.5	-	-
		-	

ATTACHMENT D - RADIATED EMISSION

Test Mode: TX Mode_GSM850

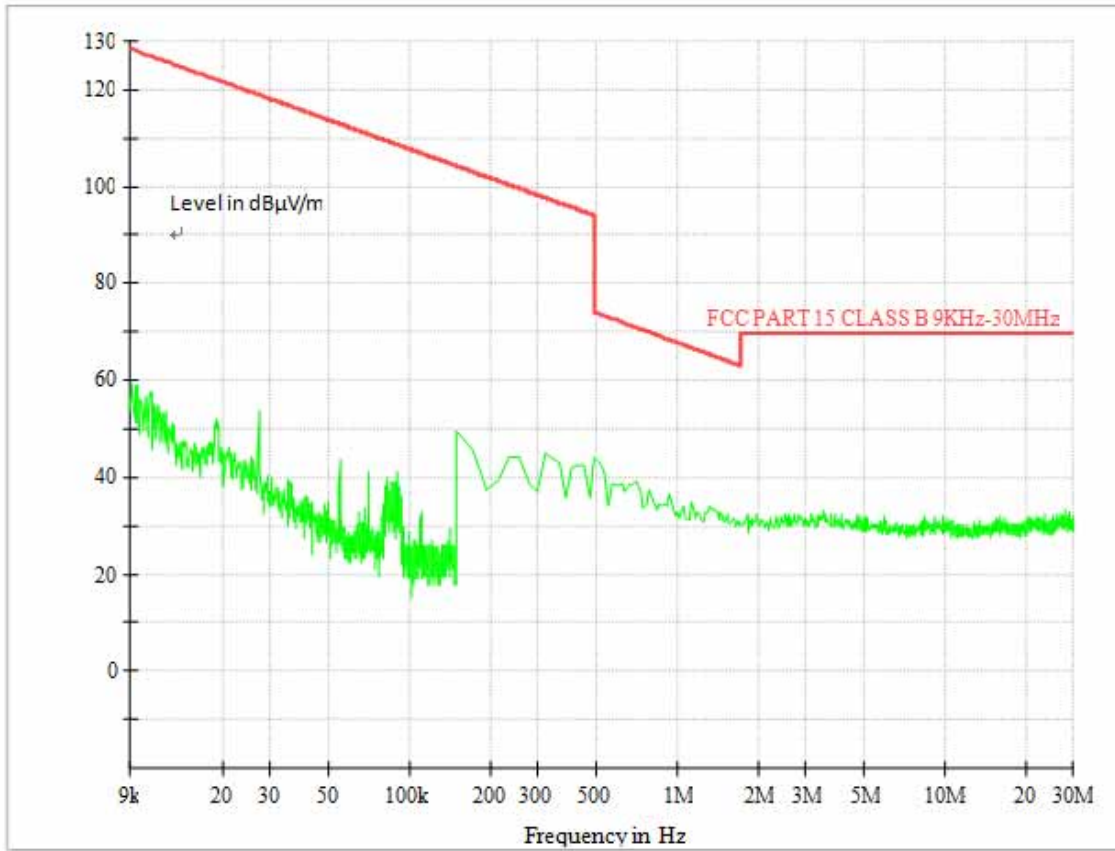

Test Mode: TX Mode_WCDMABand 5

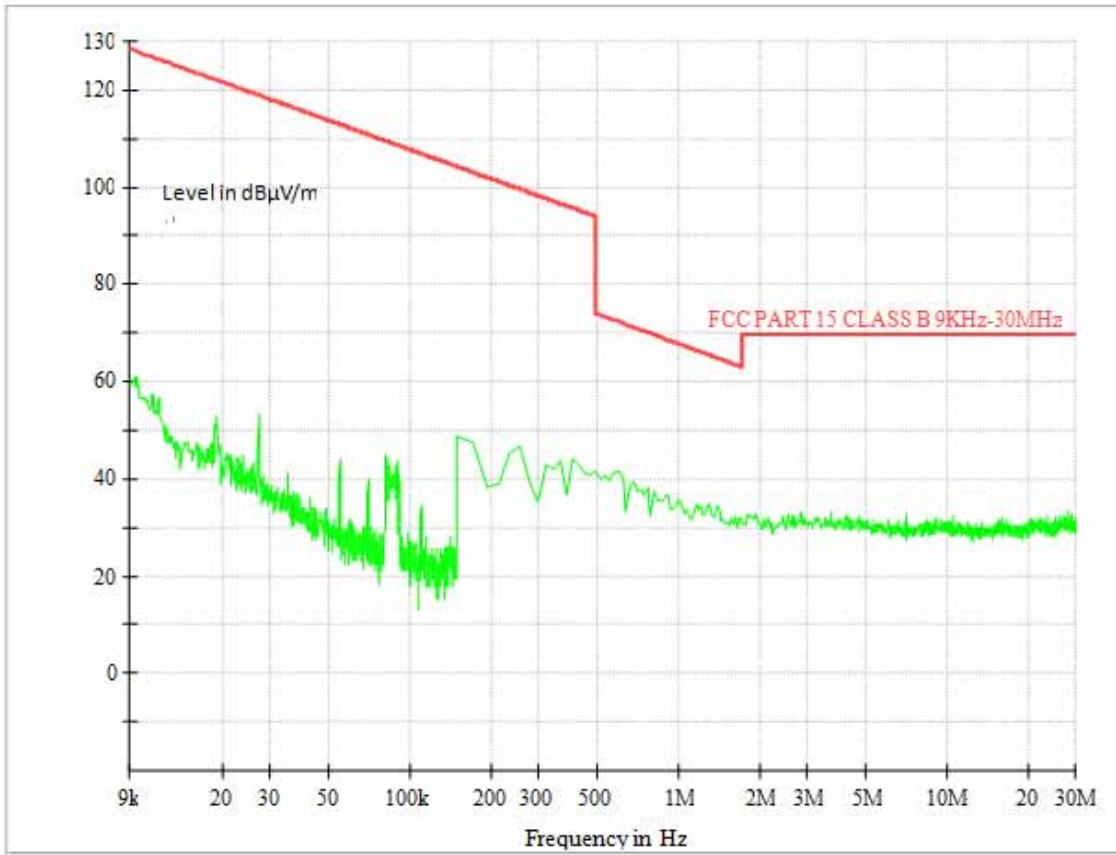

Test Mode: TX Mode_LTEBand 5

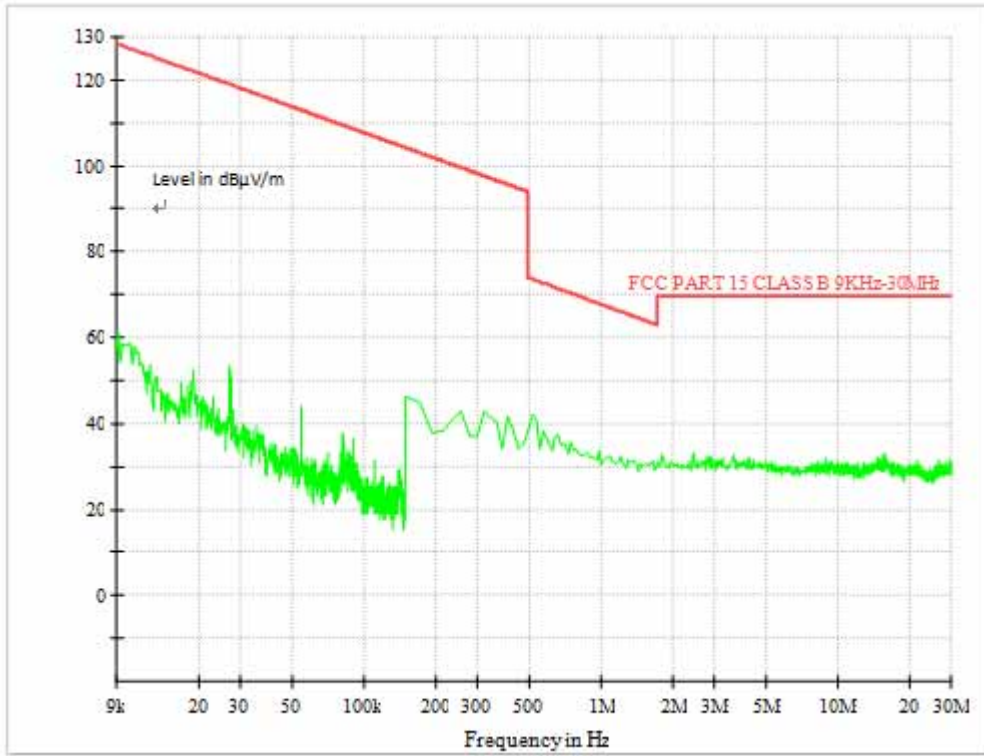

Test Mode: GSM850_TX CH190_GSM

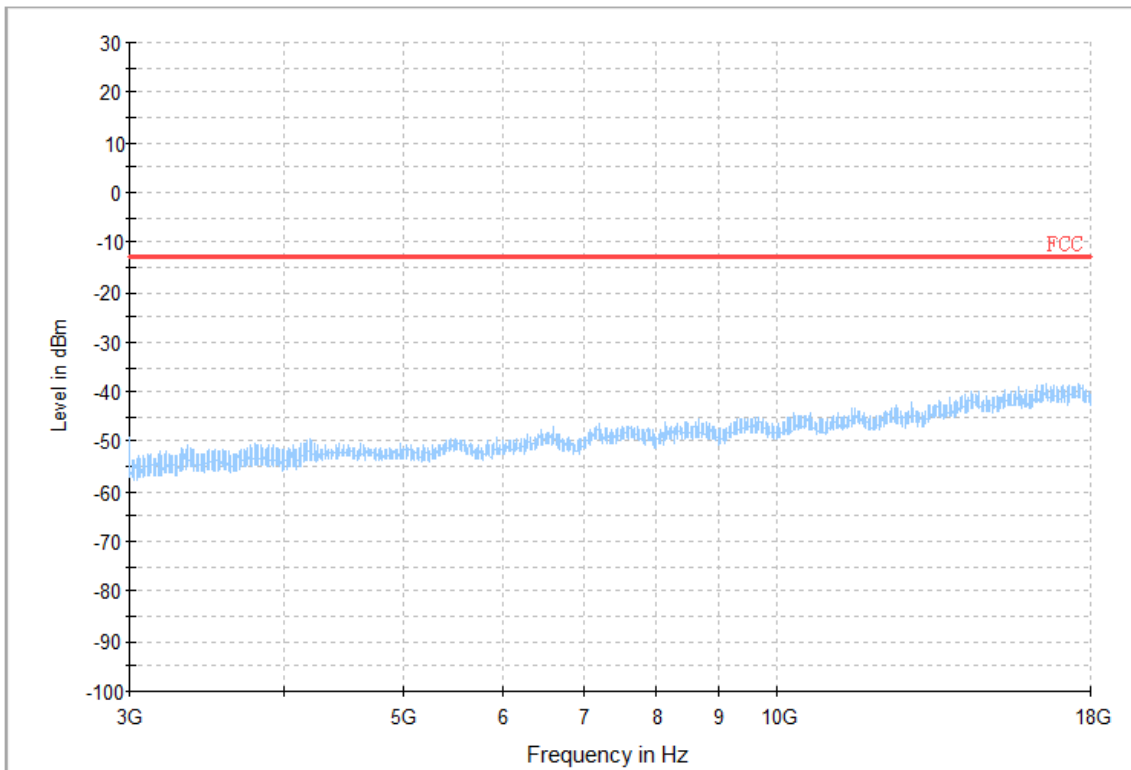
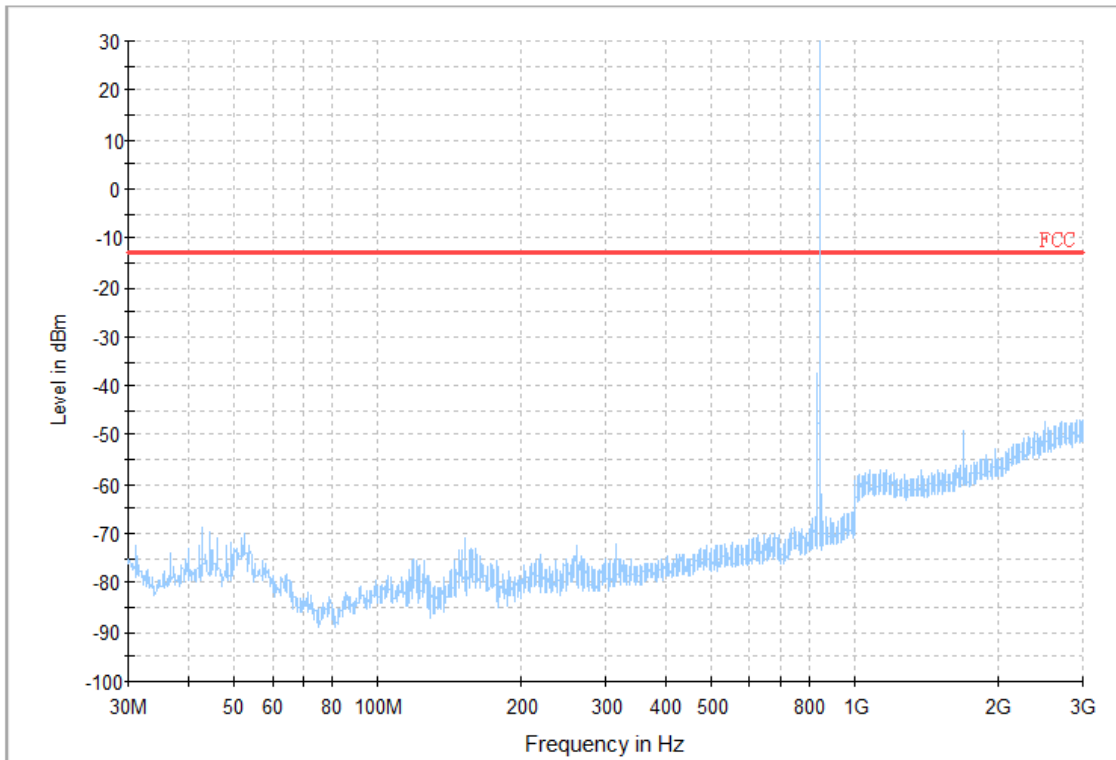

Test Mode: GSM850_TX CH190_EDGE

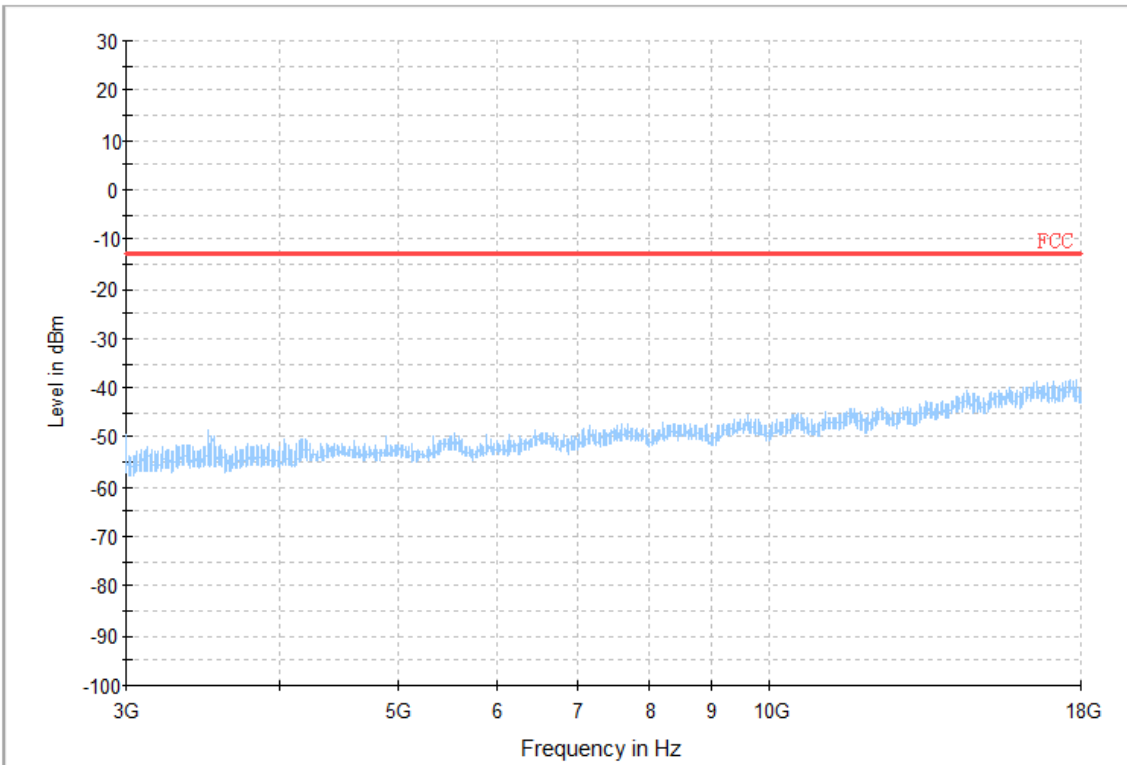
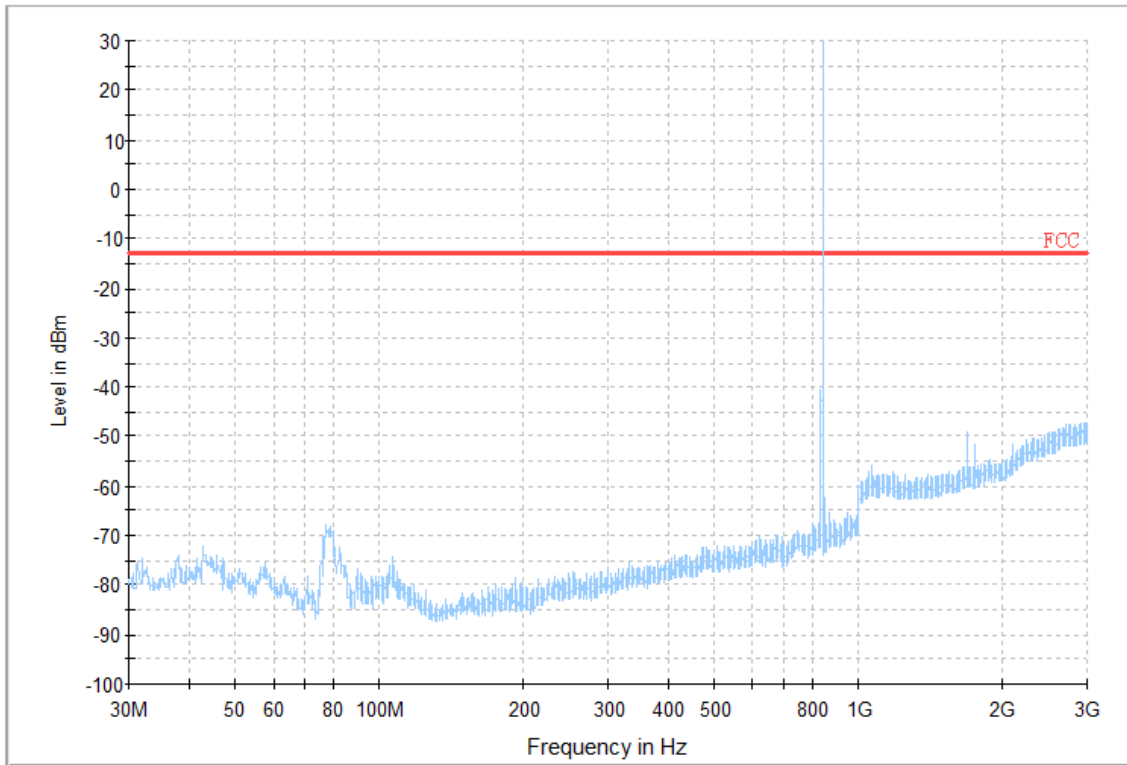

Test Mode: WCDMA Band 5_TX CH4182

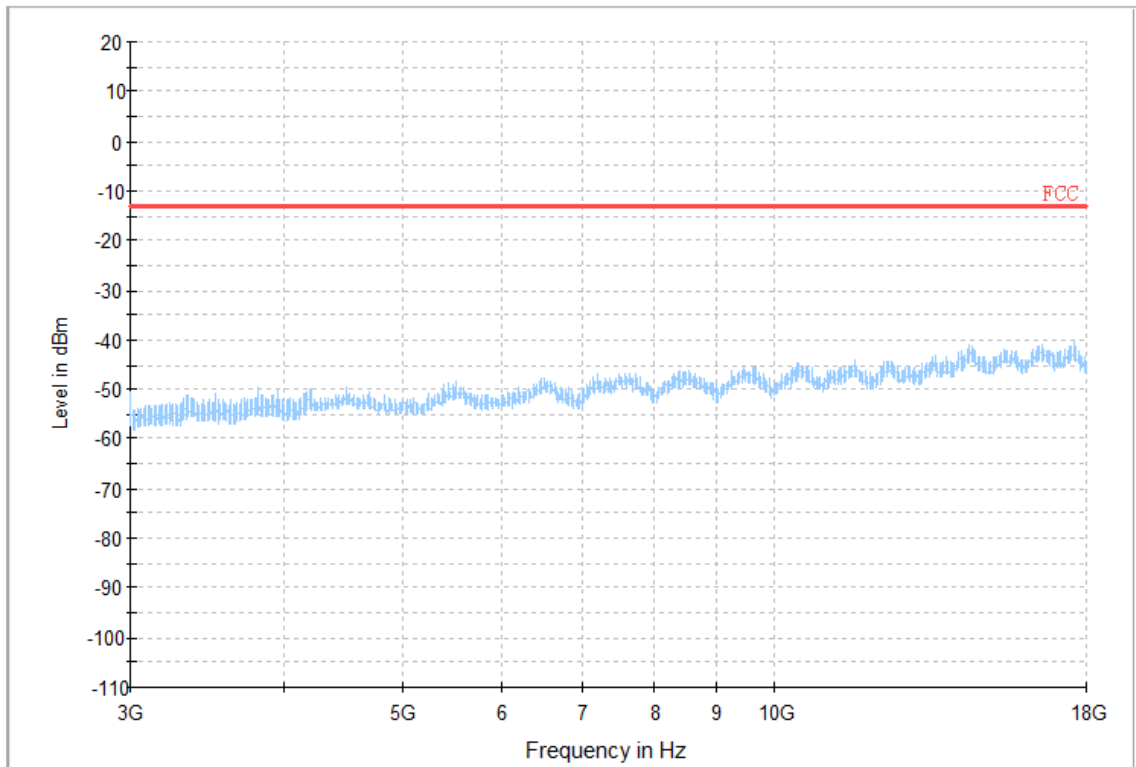
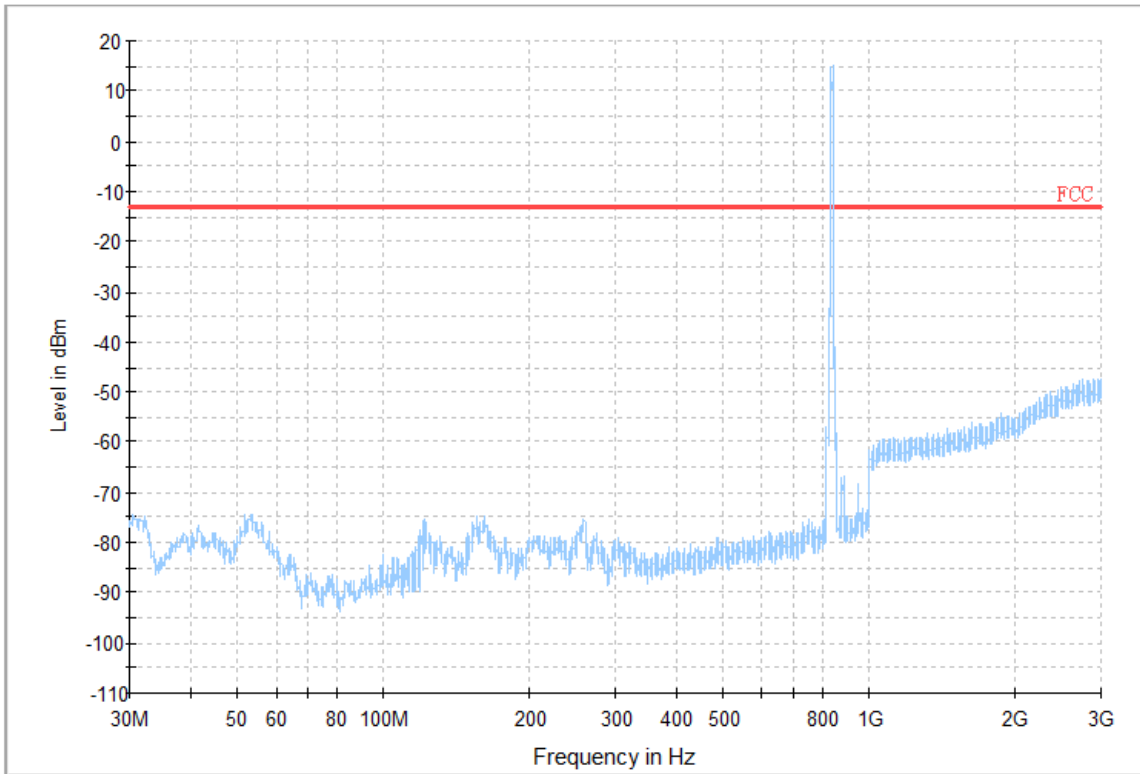

Test Mode: HSUPA Band V_TX CH4182

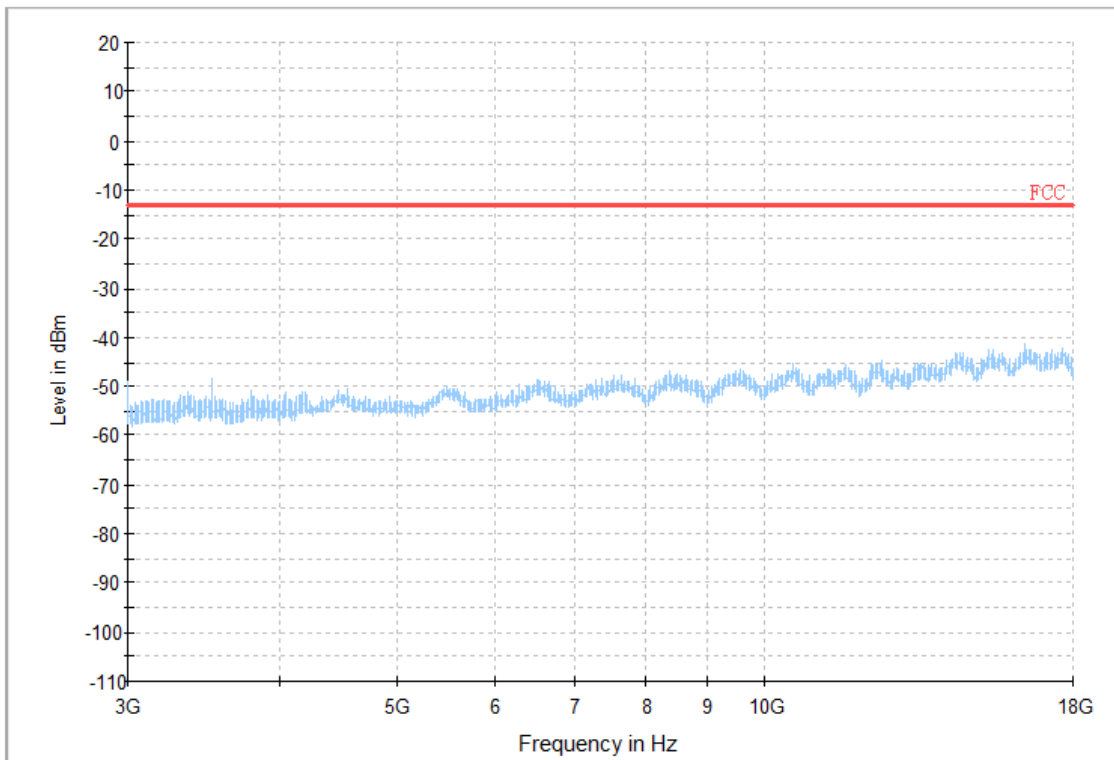
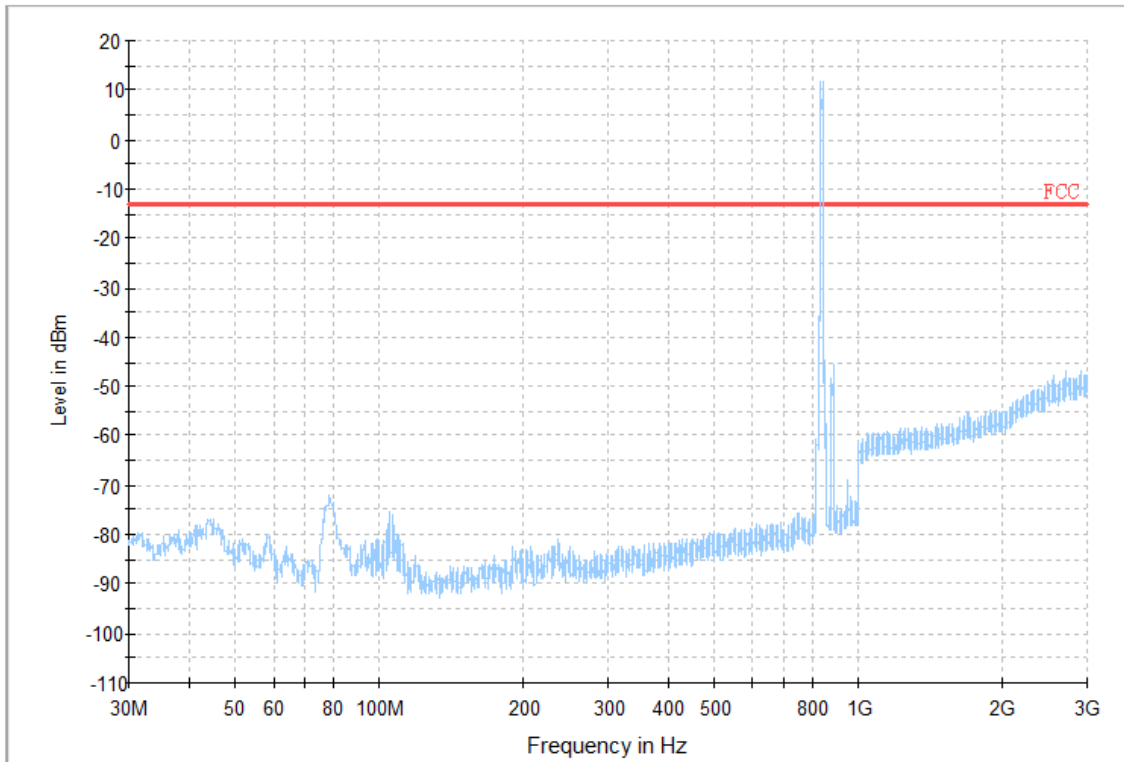

Test Mode: HSDPA Band V_TX CH4182

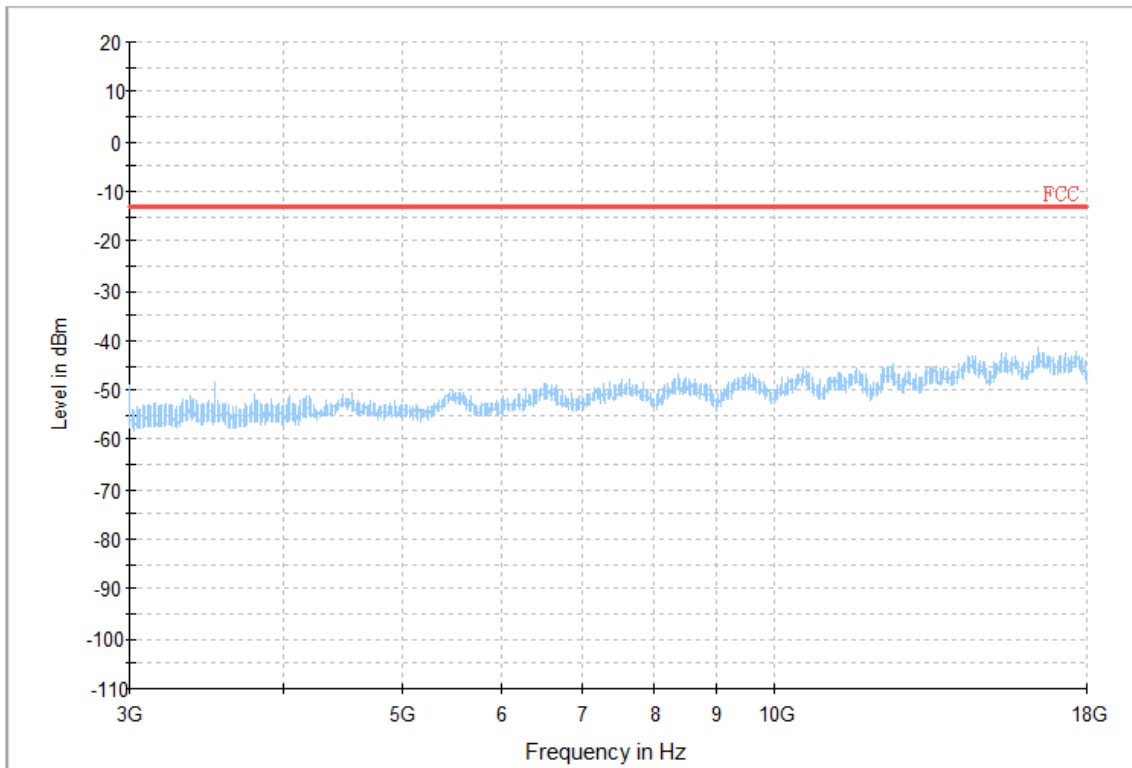
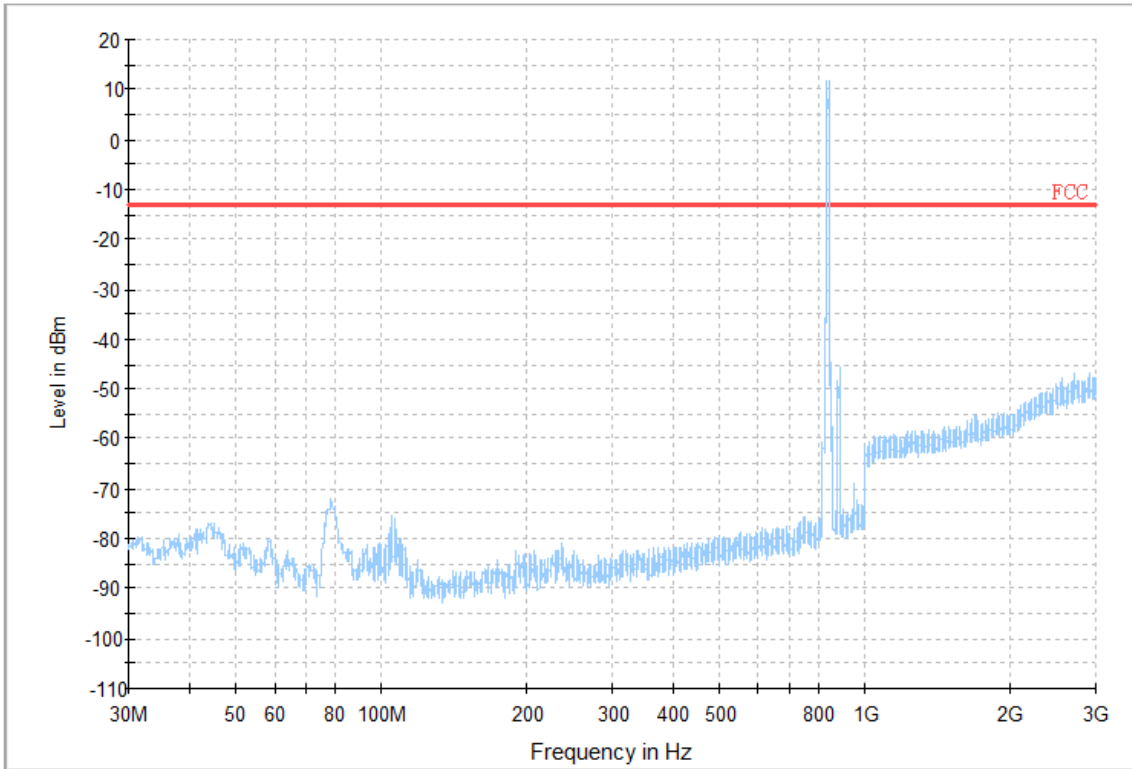

Test Mode: LTE Band 5_TX CH20525_1.4M

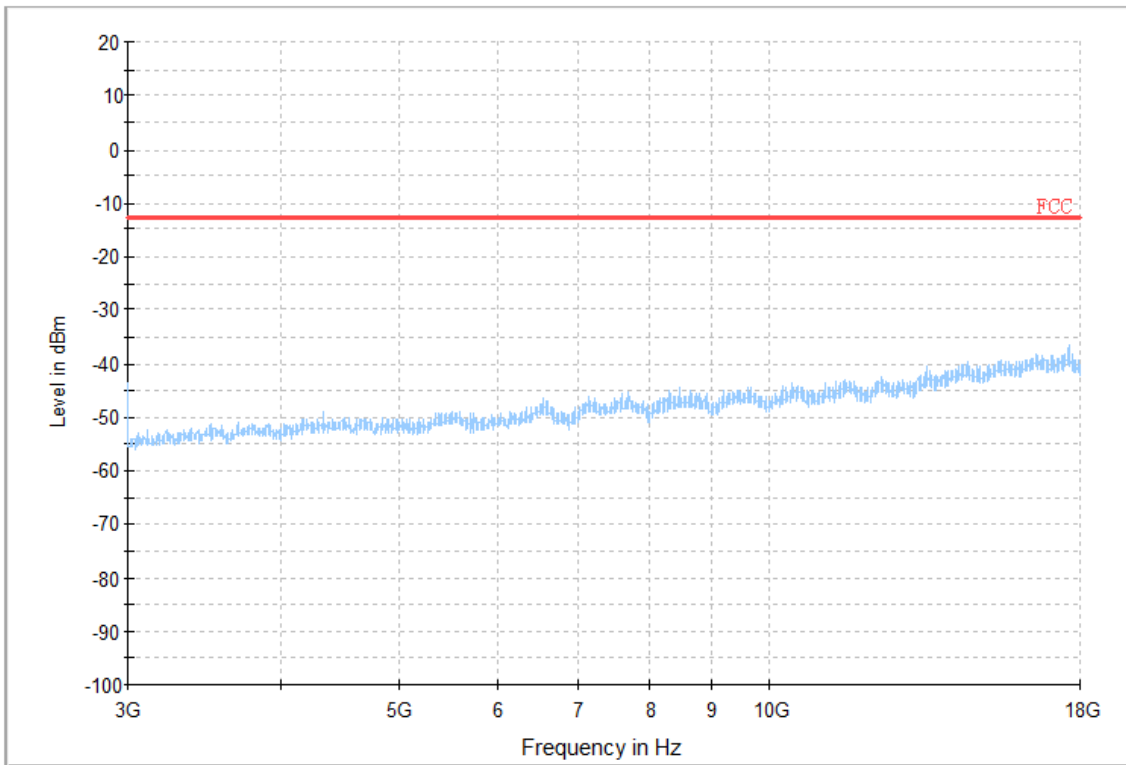
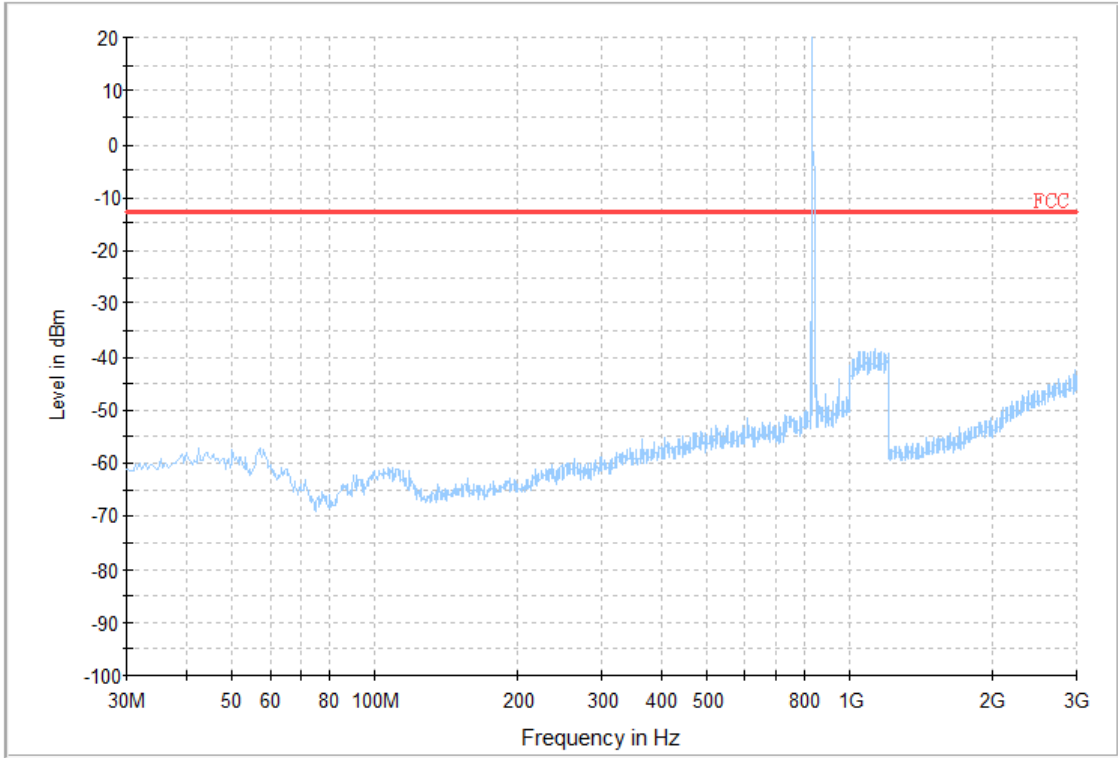

Test Mode: LTE Band 5_TX CH20525_10M

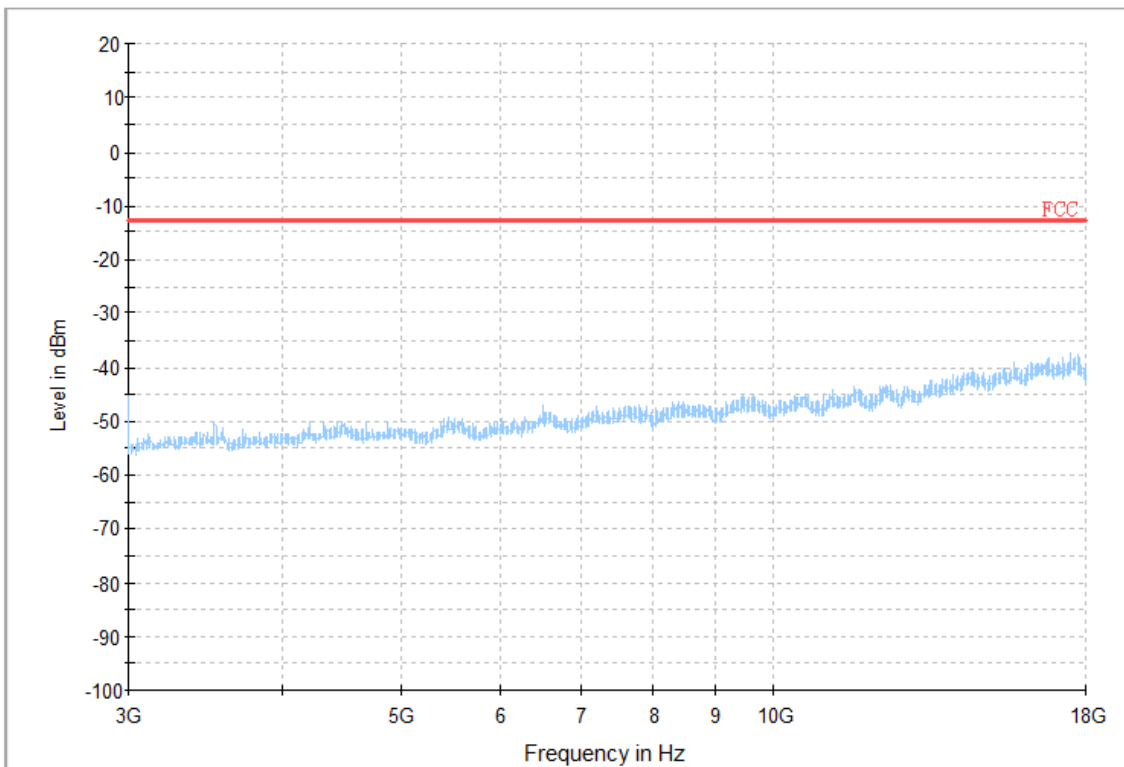
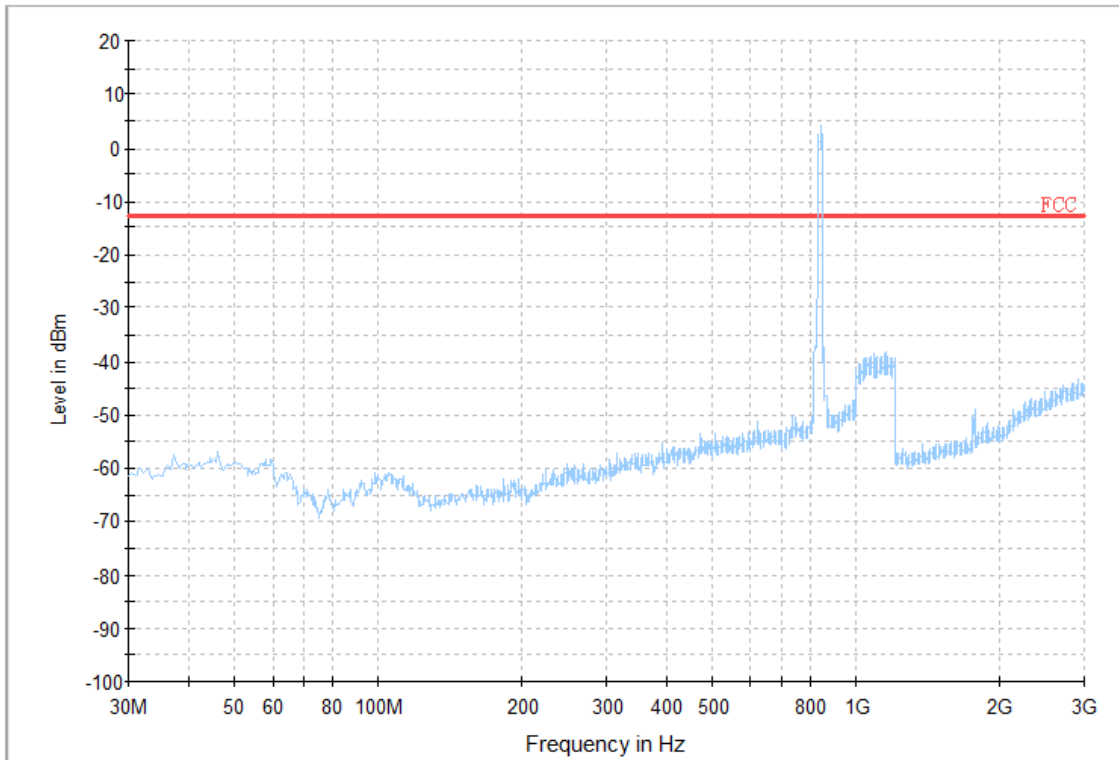

ATTACHMENT E - BAND EDGE

GSM850

GSM

Channel	128	Channel	251
---------	-----	---------	-----

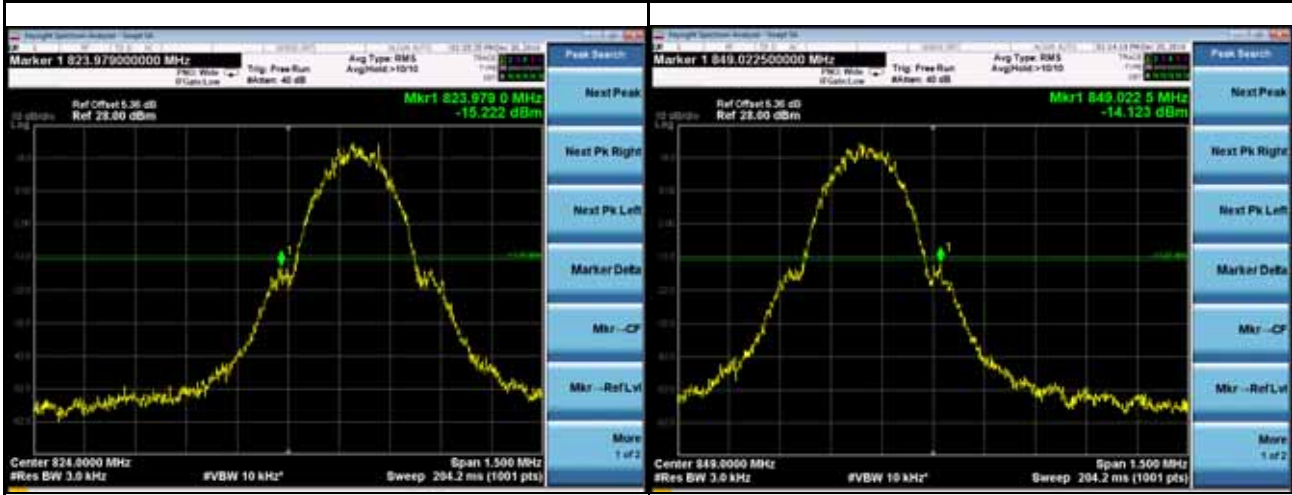

EDGE

Channel	128	Channel	251
---------	-----	---------	-----



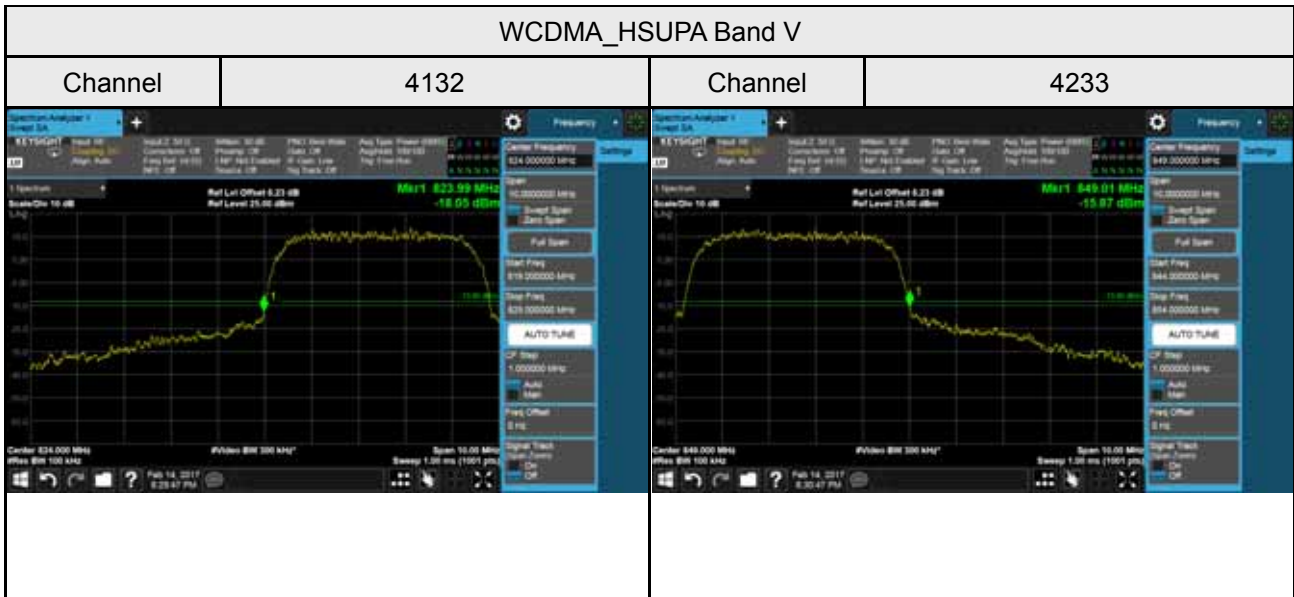
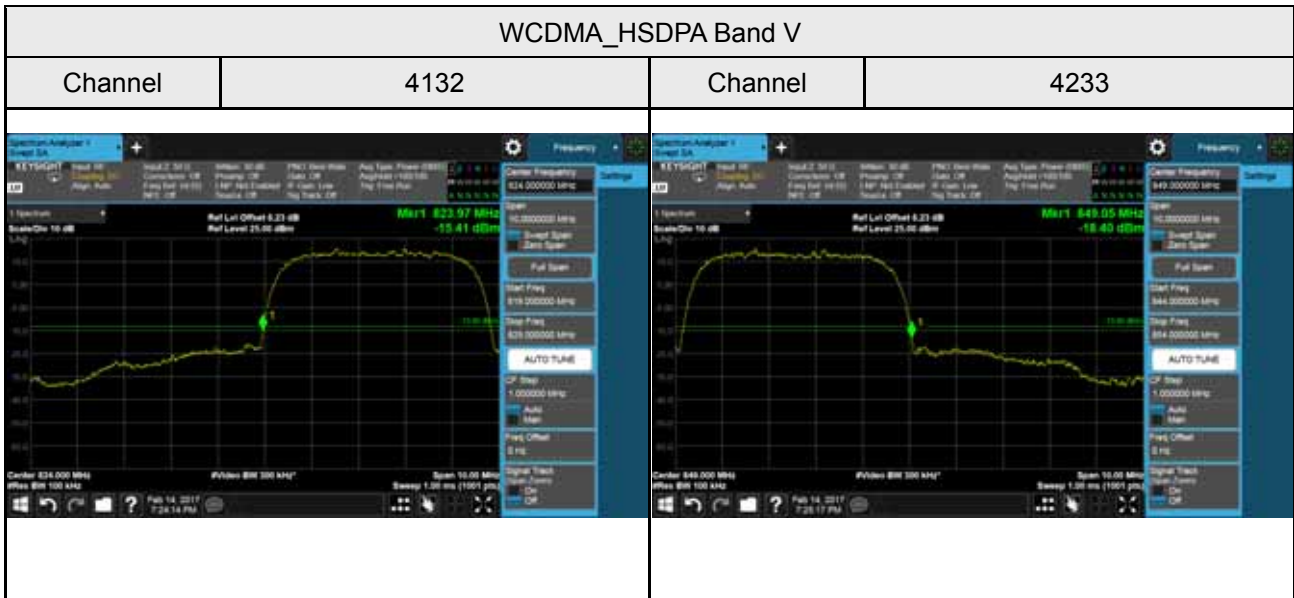
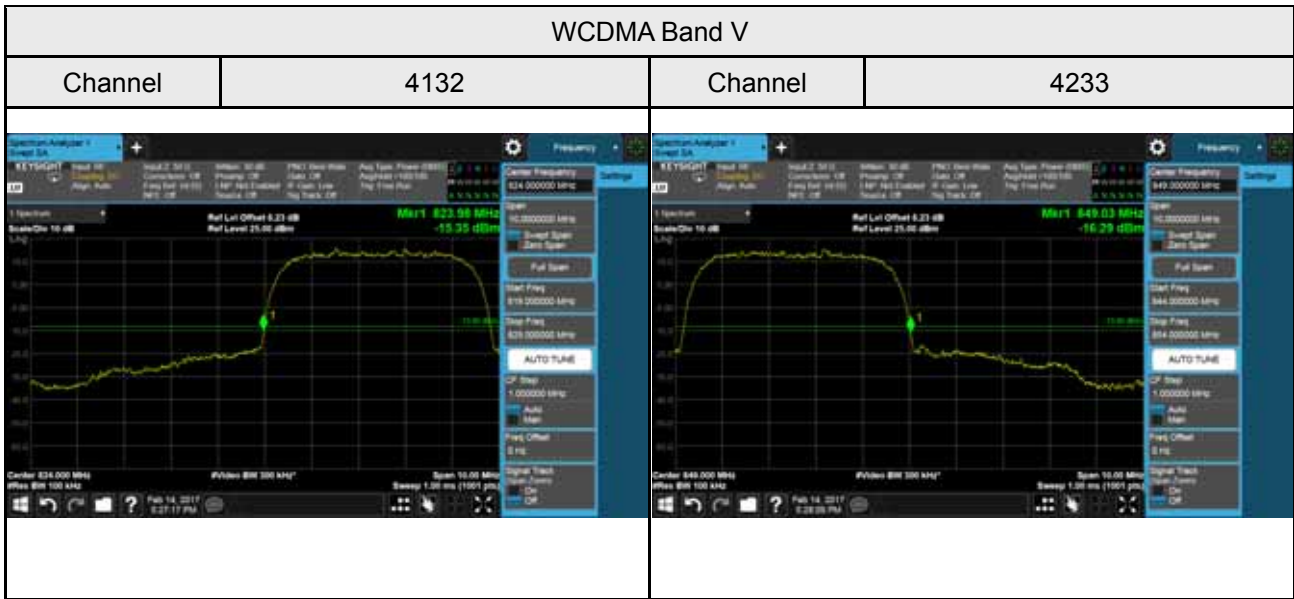

LTE Band 5_1.4M

1RB0

1RB5

Channel

20407

Channel

20643

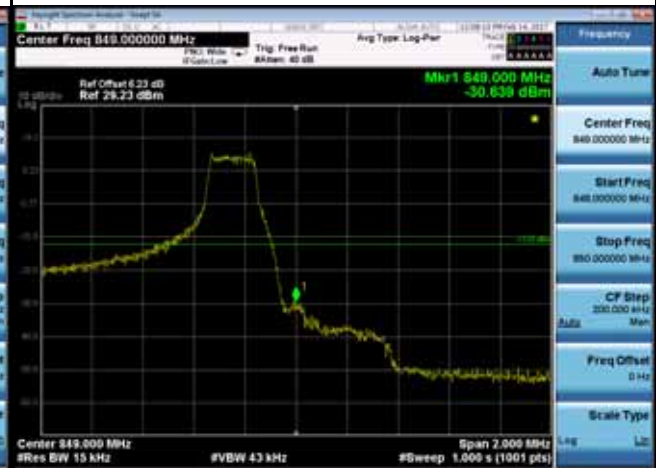
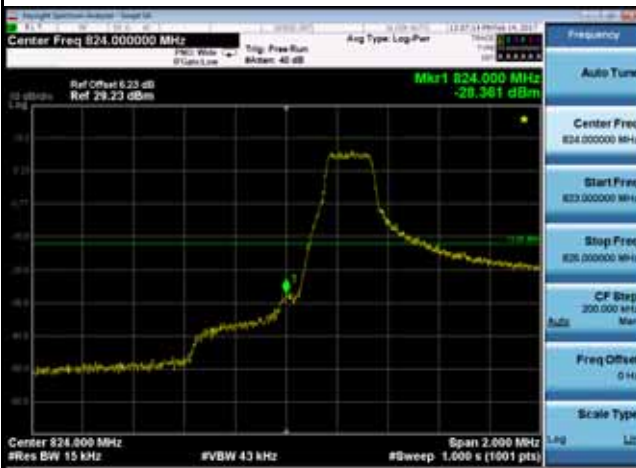

6RB0

Channel

20407

Channel

20643

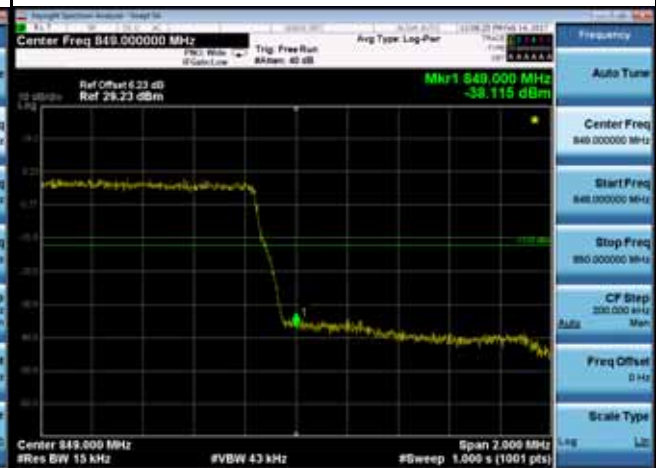
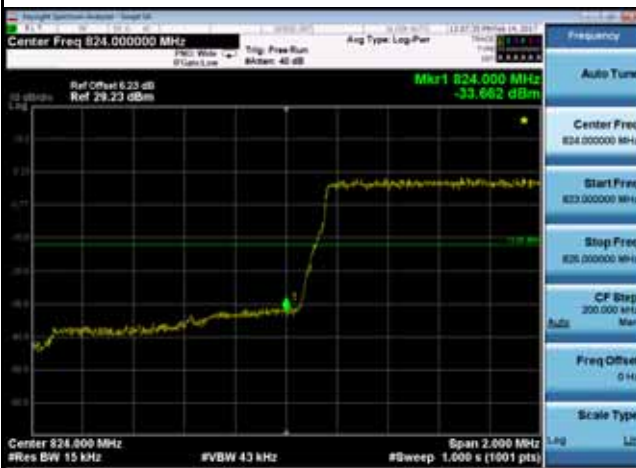

LTE Band 5_3M

1RB0

1RB14

Channel

20415

Channel

20635

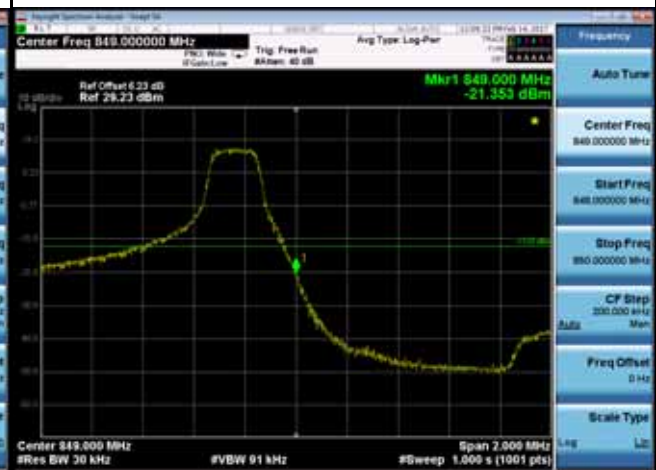
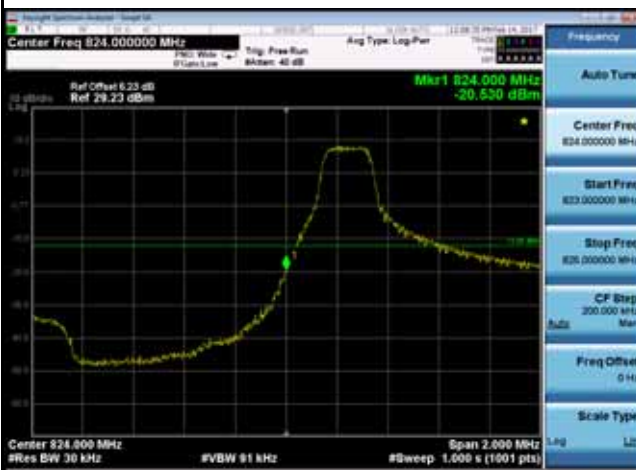

15RB0

Channel

20415

Channel

20635

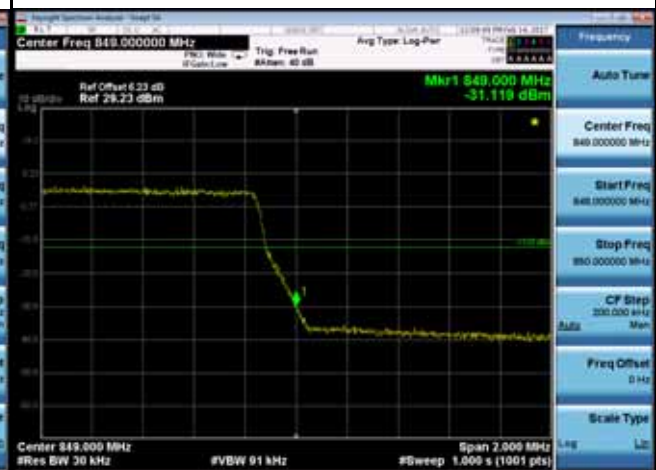
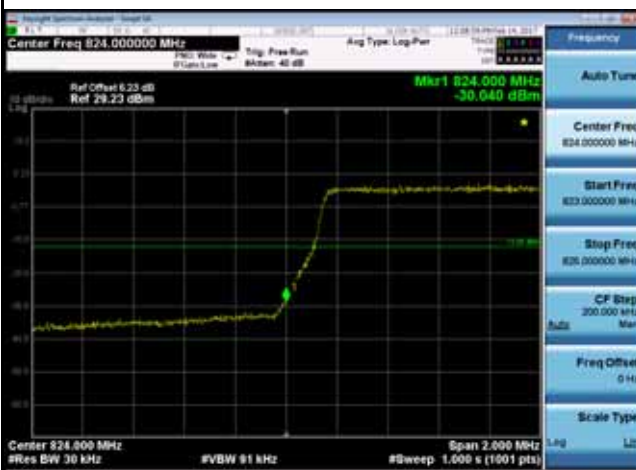

LTE Band 5_5M

1RB0

1RB24

Channel

20425

Channel

20625

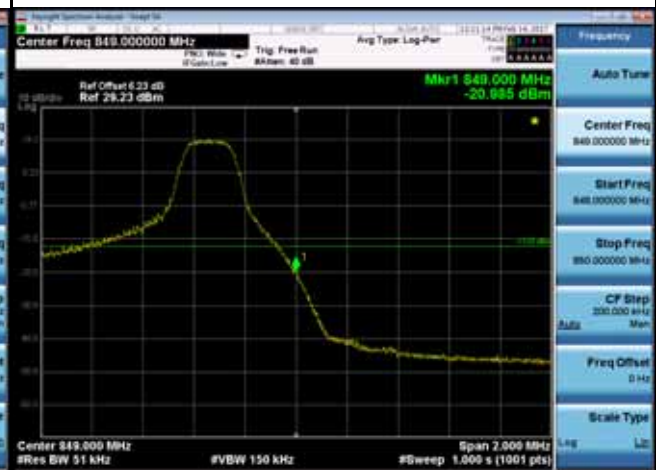
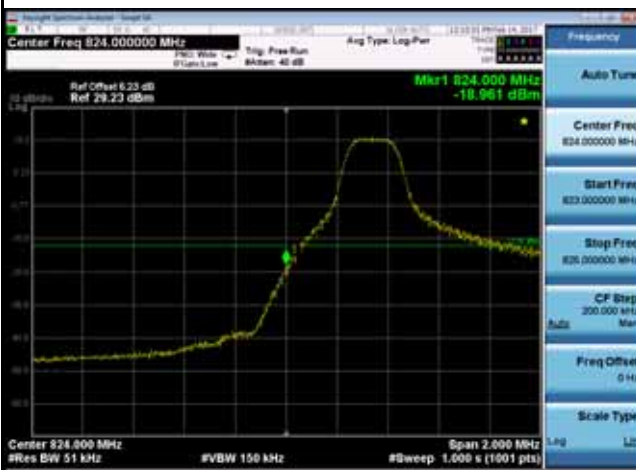

25RB0

Channel

20425

Channel

20625

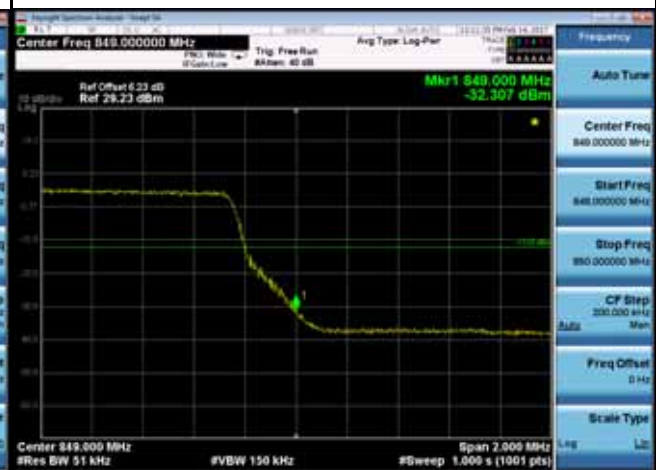
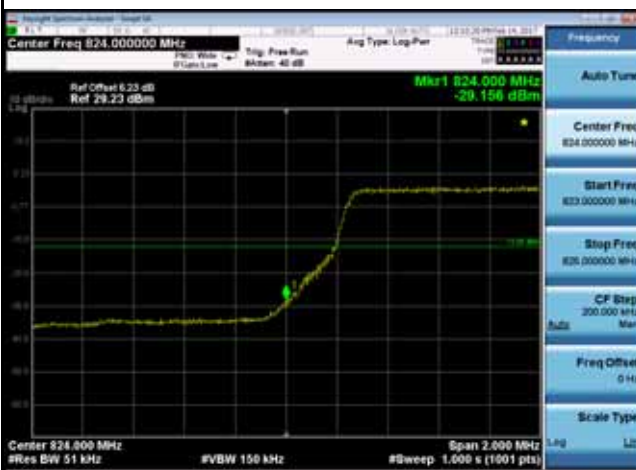

LTE Band 5_10M

1RB0	1RB49
------	-------

Channel	20450	Channel	20600
---------	-------	---------	-------

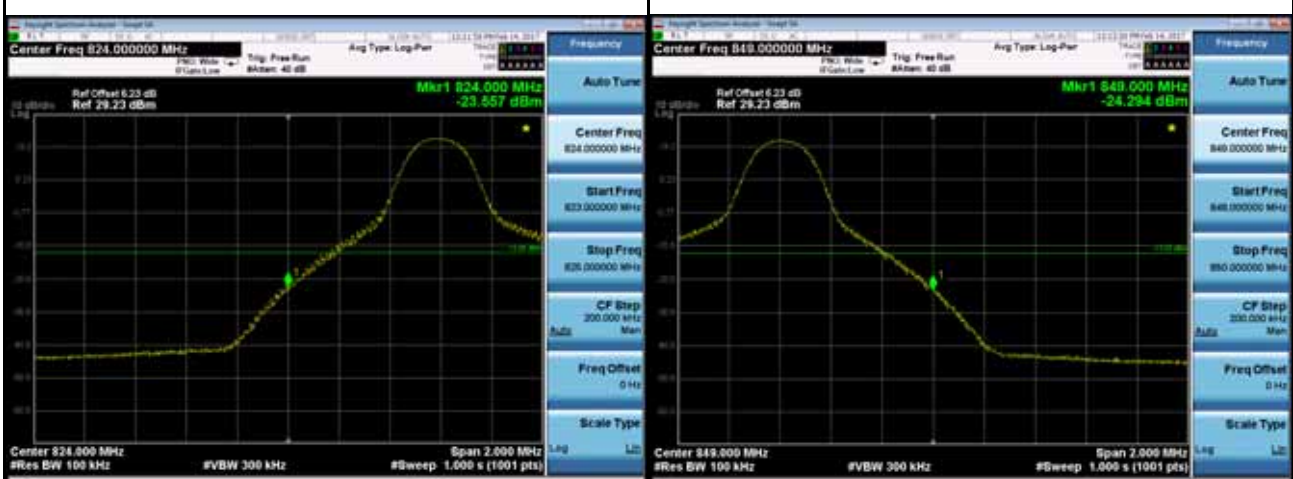

50RB0

Channel	20450	Channel	20600
---------	-------	---------	-------



ATTACHMENT F - PEAK TO AVERAGE RATIO

GSM 850 Spectrum Plot

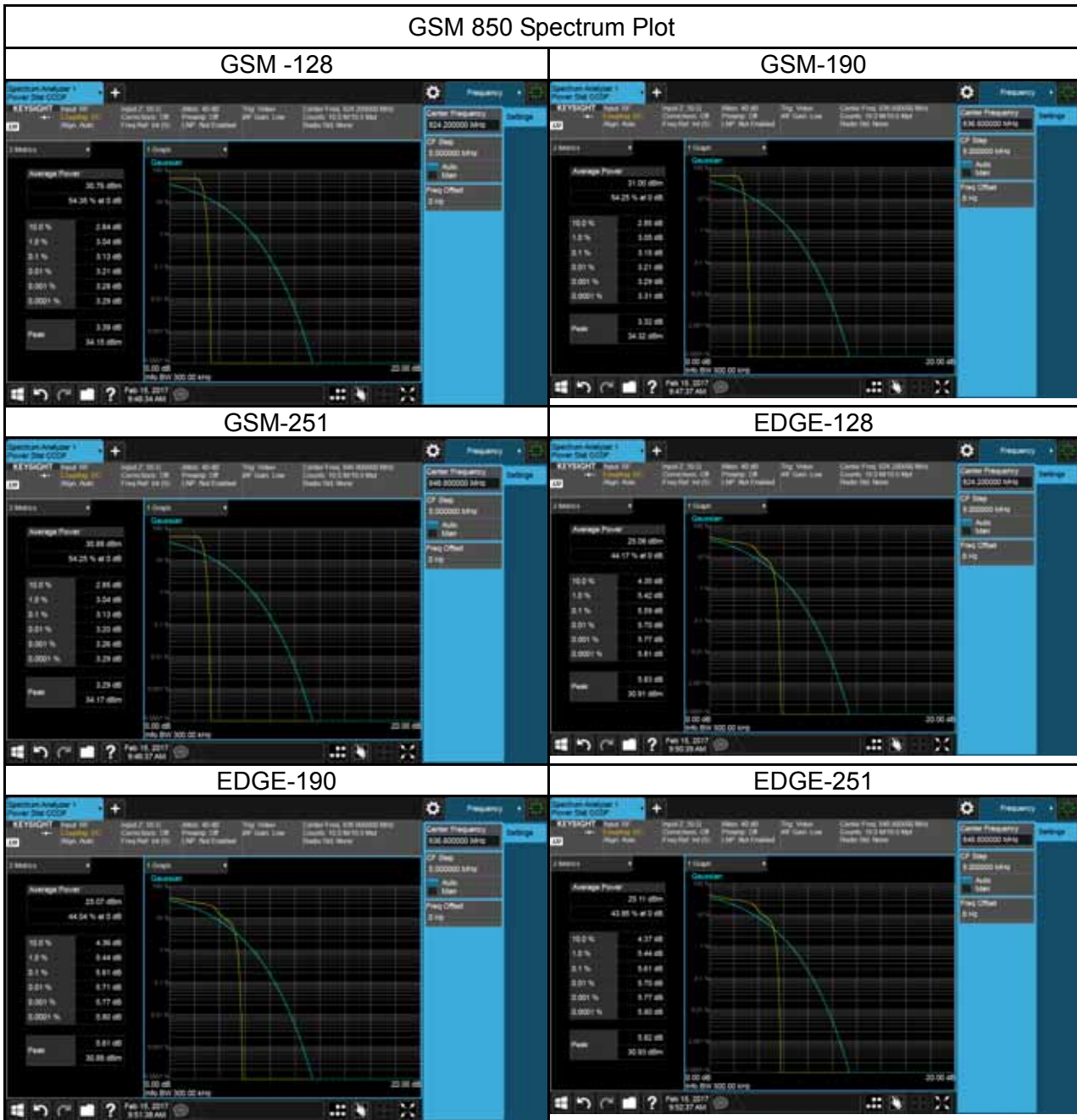

WCDMA Band V Spectrum Plot

4132

4182

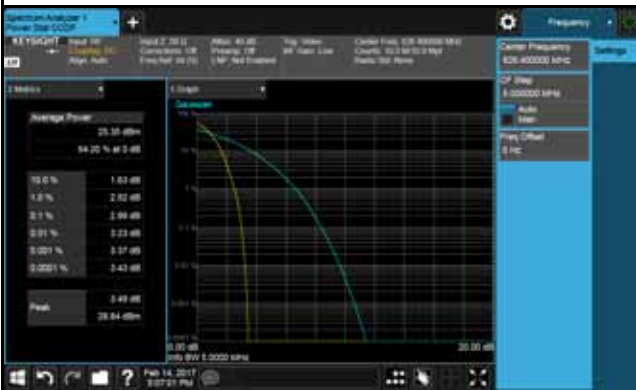

4233

-

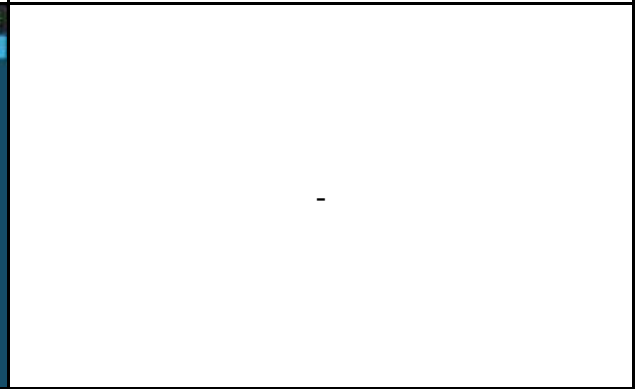
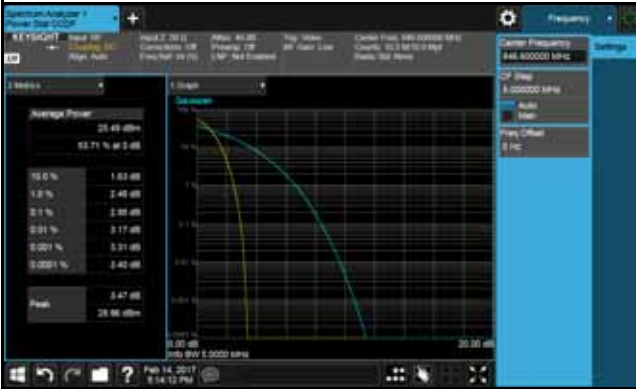

WCDMA_HSDPA Band V Spectrum Plot

4132

4182

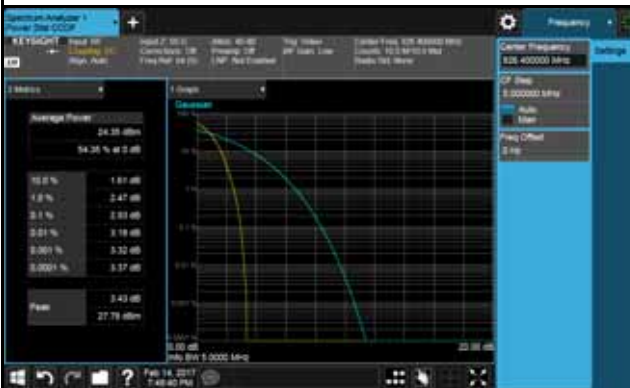

4233

-

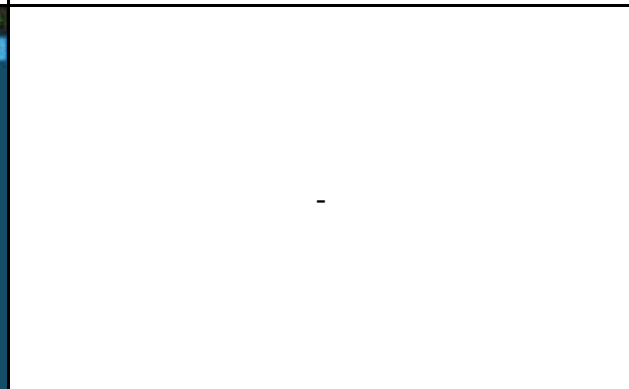
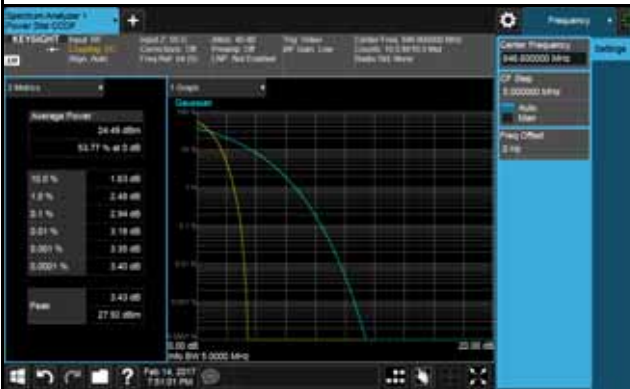

WCDMA_HSUPA Band V Spectrum Plot

4132

4182

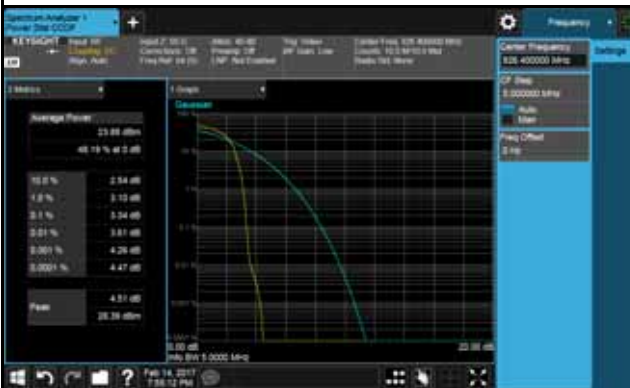

4233

-

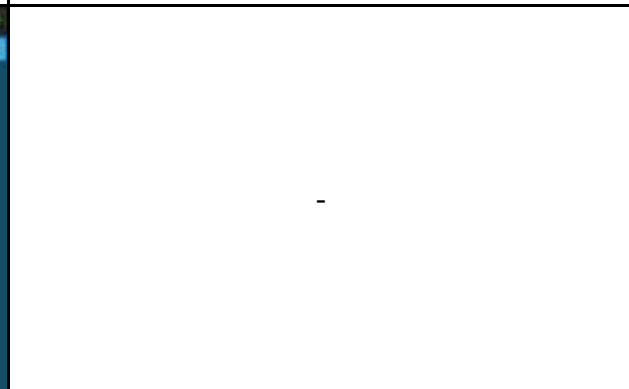
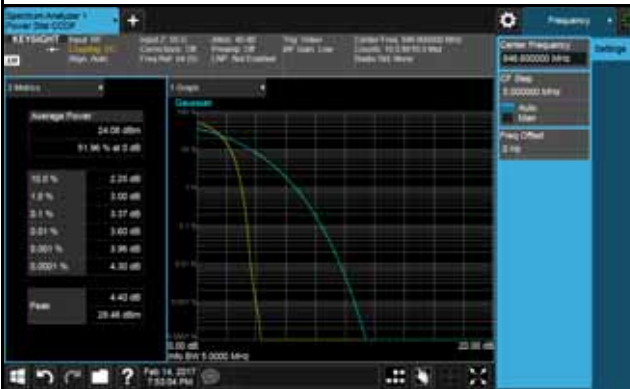

LTE Band 5 Spectrum Plot_1.4M

QPSK-20407

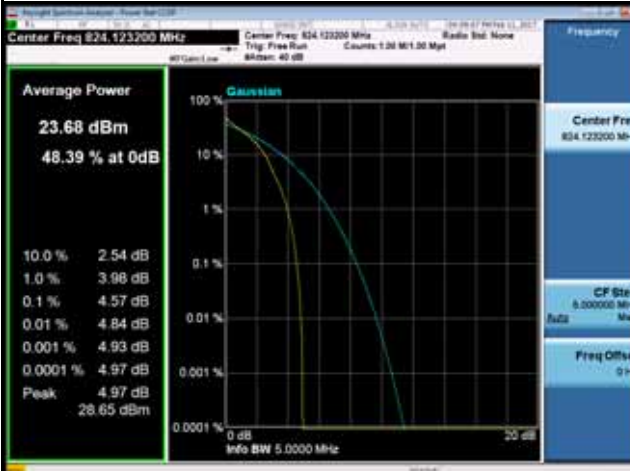

QPSK-20525

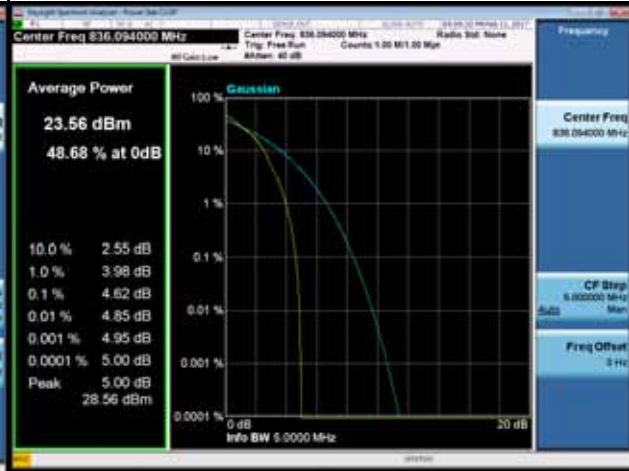

QPSK-20643

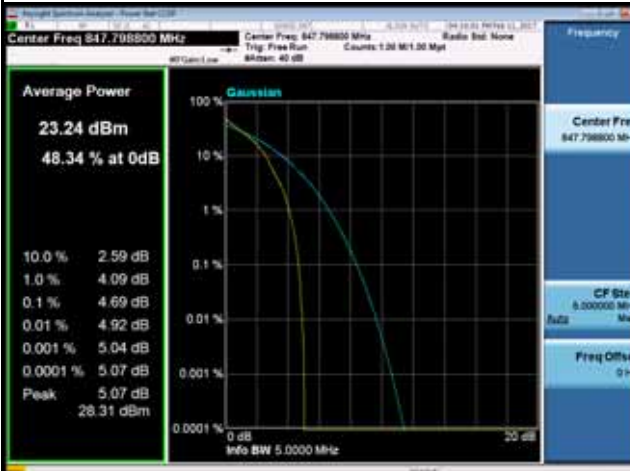

16QAM-20407

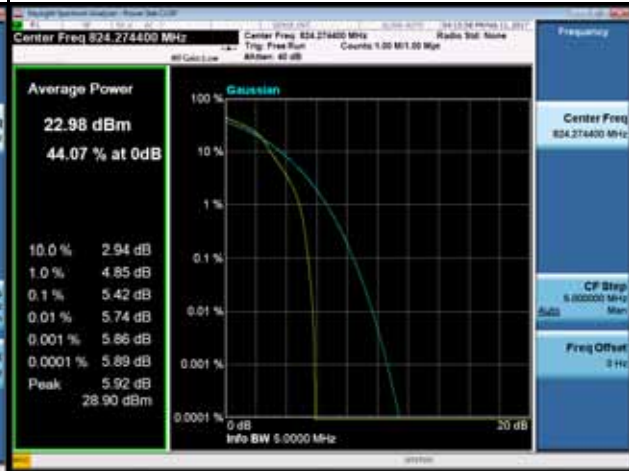

16QAM-20525

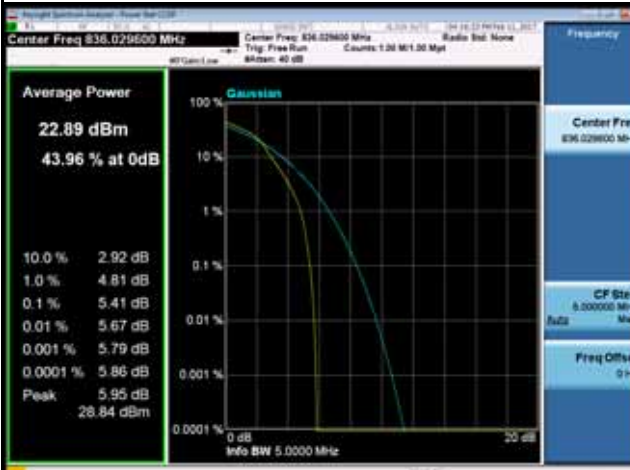

16QAM-20643

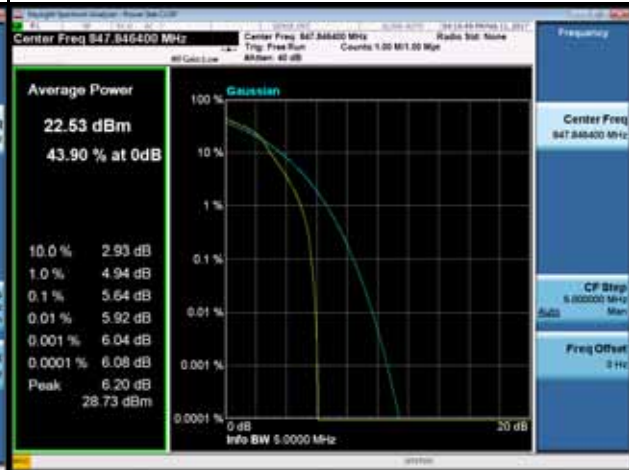

LTE Band 5 Spectrum Plot_3M



LTE Band 5 Spectrum Plot_5M



LTE Band 5 Spectrum Plot_10M



ATTACHMENT G - FREQUENCY STABILITY

Test Mode:	GSM850_CH190
------------	--------------

Temperature vs. Frequency Stability

Temperature()	Frequency Error (Hz)	Frequency Error (ppm)	Limit(ppm)
-30	7.31	0.008869207	2.5
-20	4.65	0.005641835	2.5
-10	5.71	0.00692793	2.5
0	7.22	0.00876001	2.5
10	3.16	0.003834021	2.5
20	4.05	0.004913856	2.5
30	8.13	0.009864111	2.5
40	8.77	0.010640621	2.5
50	4.59	0.005569037	2.5
Max. Deviation (ppm)	8.77	0.010640621	2.5

Voltage vs. Frequency Stability

Voltage(Volts)	Frequency Error (Hz)	Frequency Error (ppm)	Limit(ppm)
3.8	8.26	0.010021839	2.5
4	6.47	0.007850036	2.5
4.2	8.31	0.010082504	2.5
Max. Deviation (ppm)	8.31	0.010082504	2.5

Test Mode:	WCDMA Band 5_CH4182
------------	---------------------

Temperature vs. Frequency Stability

Temperature()	Frequency Error (Hz)	Frequency Error (ppm)	Limit(ppm)
-30	9.01	0.010772358	2.5
-20	8.34	0.009971306	2.5
-10	6.43	0.007687709	2.5
0	7.62	0.009110473	2.5
10	8.42	0.010066954	2.5
20	6.27	0.007496413	2.5
30	8.41	0.010054998	2.5
40	7.22	0.008632233	2.5
50	8.17	0.009768054	2.5
Max. Deviation (ppm)	9.01	0.010772358	2.5

Voltage vs. Frequency Stability

Voltage(Volts)	Frequency Error (Hz)	Frequency Error (ppm)	Limit(ppm)
3.8	9.3	0.011119082	2.5
4	7.25	0.008668101	2.5
4.2	8.31	0.009935438	2.5
Max. Deviation (ppm)	9.3	0.011119082	2.5

Test Mode:	LTE Band 5_CH20525_1.4M
------------	-------------------------

Temperature vs. Frequency Stability

Temperature()	Frequency Error (Hz)	Frequency Error (ppm)	Limit(ppm)
-30	-3.16	0.003777645	2.5
-20	-2.46	0.002940825	2.5
-10	3.14	0.003753736	2.5
0	-1.66	0.001984459	2.5
10	3.87	0.00462642	2.5
20	2.67	0.003191871	2.5
30	-2.33	0.002785415	2.5
40	-2.67	0.003191871	2.5
50	4.76	0.005690377	2.5
Max. Deviation (ppm)	4.76	0.005690377	2.5

Voltage vs. Frequency Stability

Voltage(Volts)	Frequency Error (Hz)	Frequency Error (ppm)	Limit(ppm)
3.8	-3.26	0.003897191	2.5
4	1.67	0.001996414	2.5
4.2	2.47	0.002952779	2.5
Max. Deviation (ppm)	3.26	0.003897191	2.5

Test Mode:	LTE Band 5_CH20525_3M
------------	-----------------------

Temperature vs. Frequency Stability

Temperature()	Frequency Error (Hz)	Frequency Error (ppm)	Limit(ppm)
-30	3.67	0.004387328	2.5
-20	2.83	0.003383144	2.5
-10	-1.79	0.002139868	2.5
0	-2.67	0.003191871	2.5
10	3.46	0.004136282	2.5
20	2.16	0.002582188	2.5
30	-3.31	0.003956964	2.5
40	2.89	0.003454871	2.5
50	-3.46	0.004136282	2.5
Max. Deviation (ppm)	3.67	0.004387328	2.5

Voltage vs. Frequency Stability

Voltage(Volts)	Frequency Error (Hz)	Frequency Error (ppm)	Limit(ppm)
3.8	3.16	0.003777645	2.5
4	2.43	0.002904961	2.5
4.2	-4.31	0.005152421	2.5
Max. Deviation (ppm)	4.31	0.005152421	2.5

Test Mode:	LTE Band 5_CH20525_5M
------------	-----------------------

Temperature vs. Frequency Stability

Temperature()	Frequency Error (Hz)	Frequency Error (ppm)	Limit(ppm)
-30	-4.77	0.005702331	2.5
-20	-3.69	0.004411237	2.5
-10	2.68	0.003203825	2.5
0	2.06	0.002462642	2.5
10	-2.44	0.002916916	2.5
20	2.18	0.002606097	2.5
30	1.96	0.002343096	2.5
40	-2.32	0.002773461	2.5
50	-3.08	0.003682008	2.5
Max. Deviation (ppm)	4.77	0.005702331	2.5

Voltage vs. Frequency Stability

Voltage(Volts)	Frequency Error (Hz)	Frequency Error (ppm)	Limit(ppm)
3.8	2.63	0.003144053	2.5
4	3.22	0.003849372	2.5
4.2	-3.15	0.00376569	2.5
Max. Deviation (ppm)	3.22	0.003849372	2.5

Test Mode:	LTE Band 5_CH20525_10M
------------	------------------------

Temperature vs. Frequency Stability

Temperature()	Frequency Error (Hz)	Frequency Error (ppm)	Limit(ppm)
-30	4.26	0.005092648	2.5
-20	-3.73	0.004459056	2.5
-10	3.16	0.003777645	2.5
0	-2.77	0.003311417	2.5
10	1.99	0.00237896	2.5
20	2.63	0.003144053	2.5
30	1.88	0.00224746	2.5
40	-3.46	0.004136282	2.5
50	-4.73	0.005654513	2.5
Max. Deviation (ppm)	4.73	0.005654513	2.5

Voltage vs. Frequency Stability

Voltage(Volts)	Frequency Error (Hz)	Frequency Error (ppm)	Limit(ppm)
3.8	-2.16	0.002582188	2.5
4	-1.79	0.002139868	2.5
4.2	3.22	0.003849372	2.5
Max. Deviation (ppm)	3.22	0.003849372	2.5