



EMC Test Report

Product Name: **Tablet**

Product Model: **CMR-W09**

Report Number: **SYBH(Z-EMC)021122017-2**

FCC ID: **QISCMR-W09**

Reliability Laboratory of Huawei Technologies Co., Ltd.

(Global Compliance and Testing Center of Huawei Technologies Co., Ltd)

Administration Building, Headquarters of Huawei Technologies Co., Ltd., Bantian, Longgang District,
Shenzhen, 518129, P.R.C

Tel: +86 755 28780808 Fax: +86 755 89652518

Notice

1. The laboratory has passed the accreditation by China National Accreditation Service for Conformity Assessment (CNAS). The accreditation number is L0310.
2. The laboratory has passed the accreditation by The American Association for Laboratory Accreditation (A2LA). The accreditation number is 2174.01
3. The laboratory has been listed by Industry Canada to perform electromagnetic emission measurements. The recognition numbers of test site are 6369A-1.
4. The laboratory (Reliability Lab of Huawei Technologies Co., Ltd) is also named “Global Compliance and Testing Center of Huawei Technologies Co., Ltd” , the both names have coexisted since 2009.
5. The laboratory has been recognized by the US Federal Communications Commission (FCC) to perform compliance testing subject to the Commission's Certification rules. The Designation Number is CN1173, and the Test Firm Registration Number is 294140.
6. The test report is invalid if not marked with the signatures of the persons responsible for preparing and approving the test report.
7. The test report is invalid if there is any evidence of erasure and/or falsification.
8. If there is any dissidence for the test report, please file objection to the test centre within 15 days from the date of receiving the test report.
9. Normally, the test report is only responsible for the samples that have undergone the test.
10. Content of the test report, in part or in full, cannot be used for publicity and/or promotional purposes without prior written approval from the laboratory.



Applicant: Huawei Technologies Co., Ltd.
Address: Administration Building, Headquarters of Huawei Technologies Co., Ltd., Bantian, Longgang District, Shenzhen, 518129, P.R.C

Date of Receipt Test Item: 2017-12-07
Start Date of Test: 2017-12-08
End Date of Test: 2017-12-21

Test Result: Pass

**Approved By
(Lab Manager)**

2017-12-25
Date

Roger Zhang
Name

Roger Zhang

Signature

**Operator
(Test Engineer)**

2017-12-21
Date

Hu haizhou
Name

Hu Haizhou

Signature



Modification Record

No.	Last Report No.	Modification Description
1	NA	First report

TABLE OF CONTENT

1	General Information	6
1.1	EUT Description	6
1.2	Test Site Information	8
1.3	Applied Standards	8
2	Summary of Results.....	9
3	System Configuration during EMC Test.....	10
3.1	Test Mode	10
3.2	Test System Configuration.....	11
3.3	Cables Used during Test.....	12
3.4	Associated Equipment Used during Test.....	12
4	Electromagnetic Interference (EMI).....	13
4.1	Radiated Disturbance 30MHz to 18GHz	13
4.2	Conducted Disturbance 0.15 MHz to 30MHz.....	15
5	Main Test Instruments.....	16
6	System Measurement Uncertainty	16
7	Test Data and Graph.....	17
7.1	Radiated Disturbance.....	17
7.2	Conducted Disturbance.....	21



1 General Information

1.1 EUT Description

EUT Description	
Product Name	Tablet
Model Number	CMR-W09
Input voltage	3.82V
TX Frequency	Bluetooth: 2402MHz To 2480MHz WIFI: 2412MHz To 2462MHz 5150 MHz -5250 MHz 5250 MHz -5350 MHz 5470 MHz -5725 MHz 5725 MHz -5850 MHz
RX Frequency	Bluetooth: 2402MHz To 2480MHz WIFI: 2412MHz To 2462MHz 5150 MHz -5250 MHz 5250 MHz -5350 MHz 5470 MHz -5725 MHz 5725 MHz -5850 MHz GPS: 1575.42MHz
S/N	2KH0117A25000014
HW Version	SH1CMRONLM
SW Version	CMR-W09 8.0.1.1(SP1C331)
EUT Accessory	
Data cable	Data Cable USB A Male to Micro USB 100cm,White, Shielded Manufacturer: Honglin Technology Co., Ltd. Luxshare Precision Industry Co., Ltd. Foxconn Interconnect.,Ltd. Technology.,Ltd. Foxlink cheng uei precision industry Co., Ltd
USB Type-C to 3.5 mm headset jack adapter cable	Foster Electric Co. (HONG KONG) Ltd. Boluo County Quancheng Electronic Co.,Ltd. Jiangxi Lianchuang Hongsheng Electronic Co.,Ltd. Merry Electronics Co., Ltd.
Adapter	Manufacturer:Huawei Technologies Co.,Ltd. Model: HW-059200EHQ Input: 100V~240V AC and 50/60 Hz,0.5A SN:K68367H7309413;B6832H7920825 DC Output: 5V --- 2A / 9V --- 2A
Adapter	Manufacturer:Huawei Technologies Co.,Ltd. Model: HW-059200BHQ Input: 100V~240V AC and 50/60 Hz,0.5A SN:K68445H9726155;B68498H9P02300 DC Output: 5V --- 2A / 9V --- 2A

Adapter	Manufacturer:Huawei Technologies Co.,Ltd. Model: HW-059200AHQ Input: 100V~240V AC and 50/60 Hz,0.5A SN:K68547G6P01598;B68328H7A22138 DC Output: 5V --- 2A / 9V --- 2A
Adapter	Manufacturer:Huawei Technologies Co.,Ltd. Model: HW-059200UHQ Input: 100V~240V AC and 50/60 Hz,0.5A SN: B76595GCY02927;K76547GCR14739 DC Output: 5V --- 2A / 9V --- 2A
Li-ion	Manufacturer:Huawei Technologies Co.,Ltd. Battery Model: HB2994I8ECW Rated capacity: 7350 mAh Nominal Voltage: +3.82V Charging Voltage: +4.4V SN: 5GHUAYH721;5FAFGIH628;5FAHSCHA11

Remark: The above EUT's information is declared by manufacturer. Please refer to the specifications or user's manual for more detailed information.

1.2 Test Site Information

Test Site 1:	RELIABILITY LABORATORY OF HUAWEI TECHNOLOGIES CO., LTD.
Test Site Location:	Administration Building, Headquarters of Huawei Technologies Co., Ltd., Bantian, Longgang District, Shenzhen, 518129, P.R.C
Test Site 2:	RELIABILITY LABORATORY OF HUAWEI TECHNOLOGIES CO., LTD.
Test Site Location:	No.2 New City Avenue Songshan Lake Sci. &Tech. Industry Park, Dongguan, Guangdong, China

1.3 Applied Standards

APPLIED STANDARD

47 CFR FCC Part 15 2016, Subpart B

2 Summary of Results

Summary of Results				
Test Items	Test Mode	Performance Class & Required Performance Criteria	Result	Site
<u>Radiated Emissions</u> Enclosure Port	Mode1 Mode2 Mode3	CLASS B	Pass	Site1 Site2
<u>Conducted Emissions</u> <input type="checkbox"/> DC Power Port <input checked="" type="checkbox"/> AC Power Port <input type="checkbox"/> Telecommunication Ports	Mode1 Mode2	CLASS B	Pass	Site1
Note: 1, Measurement taken is within the uncertainty of test system. 2, <input checked="" type="checkbox"/> The item has been tested; <input type="checkbox"/> The item has not been tested.				

During the measurement, the environmental conditions complied with the range listed as below.

Item	Required
Ambient temperature	15°C ~ 35°C
Relative humidity	25% ~ 75%
Atmospheric pressure	86kPa ~ 106kPa

3 System Configuration during EMC Test

3.1 **Test Mode**

The EUT was configured, installed, arranged and operated in a manner consistent with typical application. The following mode(s) were applied during the compliance test.

Test Mode	
Mode 1:	Charging(EUT with adapter)+Camera On +(WiFi BT GPS) On
Mode 2:	Charging(EUT with adapter)+Video Playing
Mode 3:	Data Transmitting (EUT with PC)

Remark:

- 1) If there is one kind of accessories with different models, each one should be applied throughout the compliance test respectively, however, only the worst case will be recorded in this report.
- 2) If EUT has more than one typical operation, only the worst test mode will be recorded in this report.

Traffic Mode:

When the EUT state is switched on and with Radio Resource Control (RRC) connection established.

Idle Mode:

When the EUT state is switched on but without Radio Resource Control (RRC) connection.

Worst Case:

- 1) Radiated Emission
Mode 3: Data Transmitting (EUT with PC) This result is the worst case.
- 2) Conducted Emission
Mode 1: Adapter (Model: HW-059200UHQ, SN: B76595GCV02927) + Charging(EUT with adapter)+Camera On +(WiFi BT GPS) On This result is the worst case.

3.2 Test System Configuration

Connection Diagram (Mode 1~Mode 2)

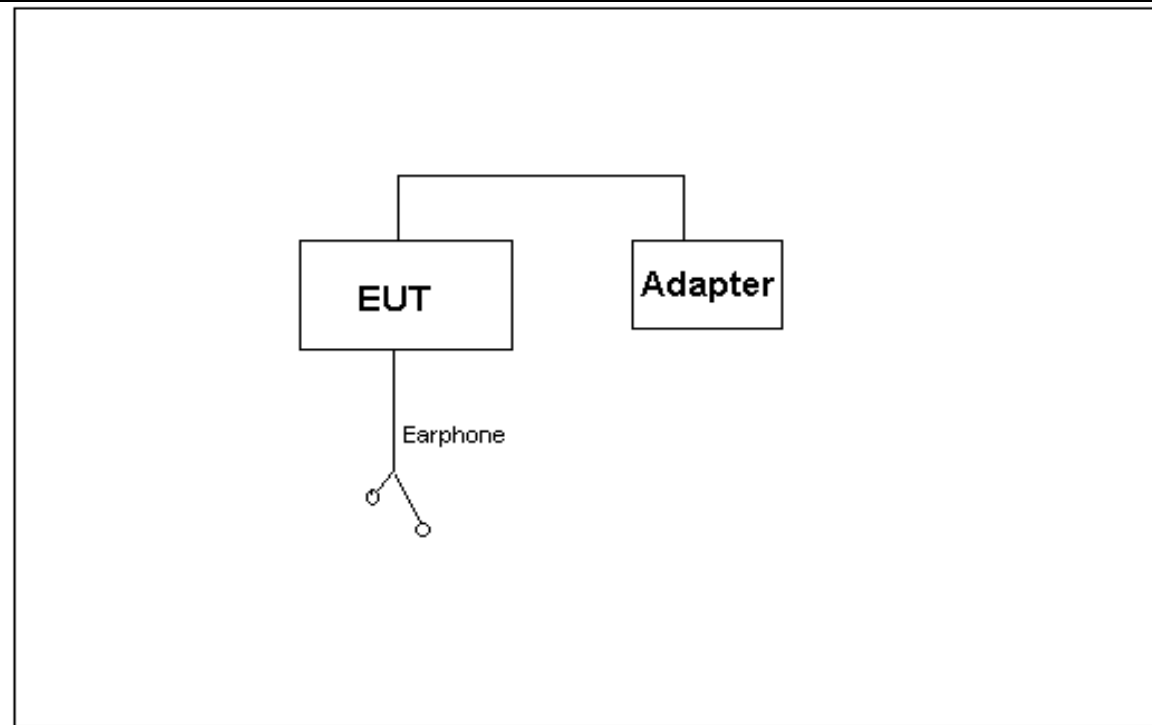

Connection Diagram (Mode3)

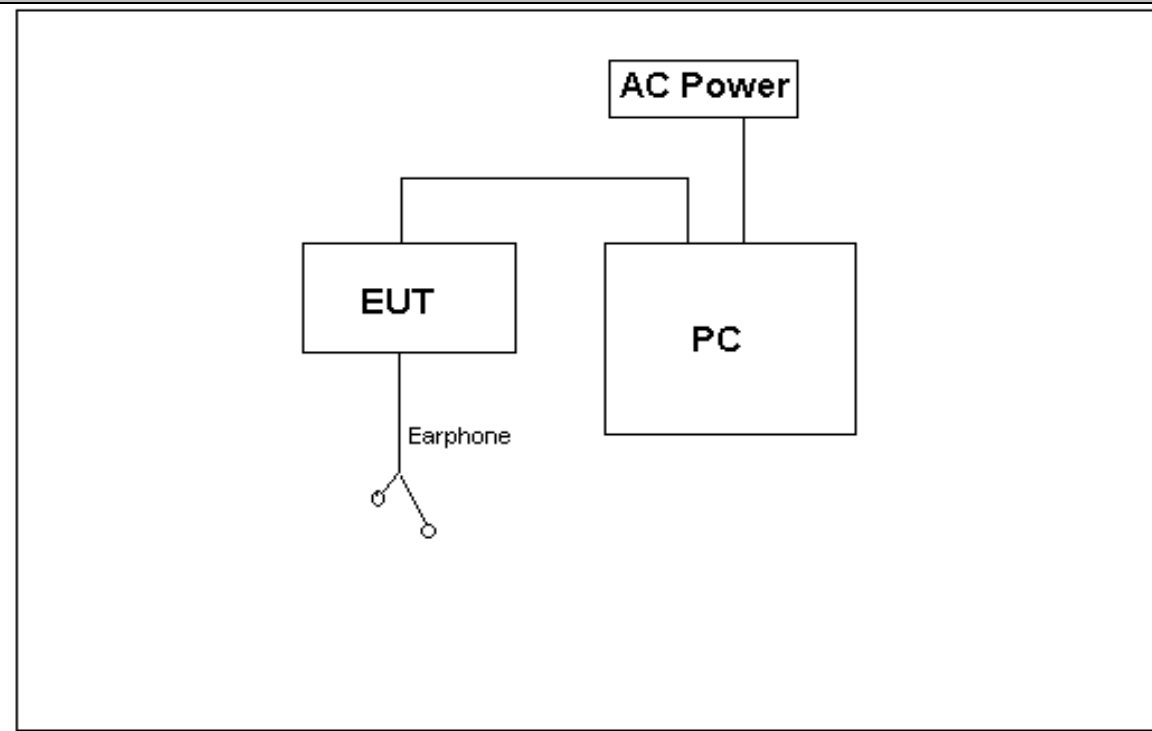

3.3 Cables Used during Test

Cable	Quantity	Length	Type of Cable
USB	1	<3m	shielded

3.4 Associated Equipment Used during Test

Name	Model	Manufacturer	S/N	Calibrated Deadline
Notebook	X230	ThinkPad	31090403579	/
Mouse	M-U0025-O	Lenovo	HS423HB22TB	/

4 Electromagnetic Interference (EMI)

4.1 Radiated Disturbance 30MHz to 18GHz

4.1.1 Test Procedure

The test site semi-anechoic chamber has met the requirement of NSA tolerance 4dB according to the standards: ANSI C63.4-2014. The test distance was 3m. The set-up and test methods were according to ANSI C63.4-2014.

A preliminary scan and a final scan of the emissions were made from 30 MHz to 18 GHz by using test script of software; The emissions were measured using Quasi-Peak Detector (30MHz~1GHz) and AV/PK detector (above 1GHz). The maximal emission value was acquired by adjusting the antenna height, polarisation and turntable azimuth in accordance with the software setup. Normally, the height range of antenna was 1m to 4m. The azimuth range of turntable was 0° to 360°. The receiving antenna has two polarizations V and H.

Measurement bandwidth (RBW) for 30MHz to 1000 MHz: 120 kHz;

Measurement bandwidth (RBW) for 1000MHz to 40000 MHz: 1MHz;

EUT was configured in idle mode and the test performed at worst emission state.

4.1.2 Test setup

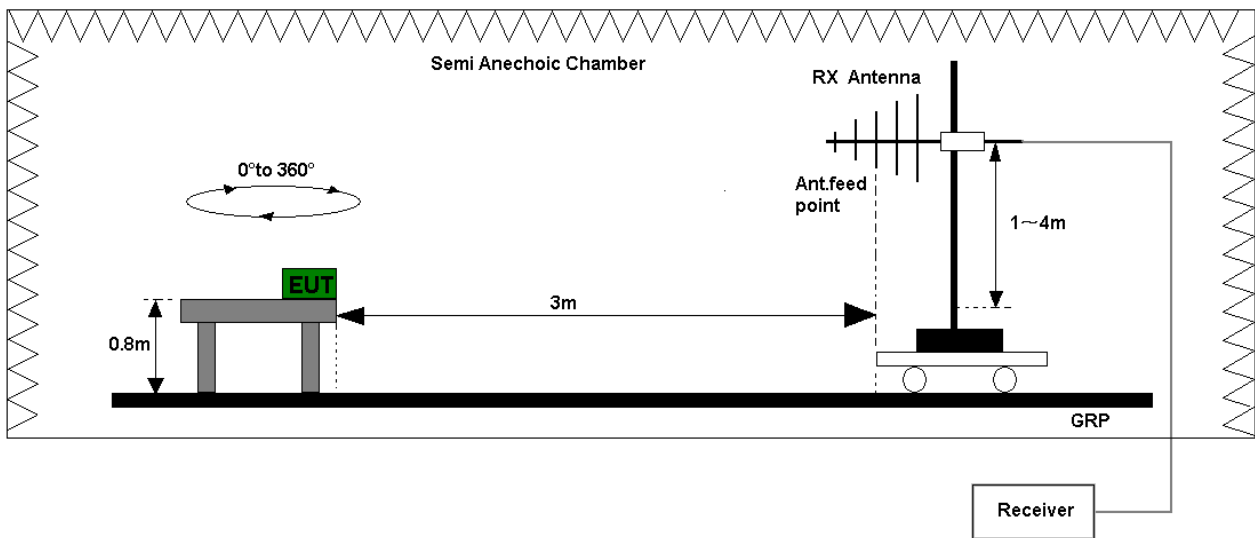

Figure 1. Test set-up of radiated disturbance(30MHz-1GHz)

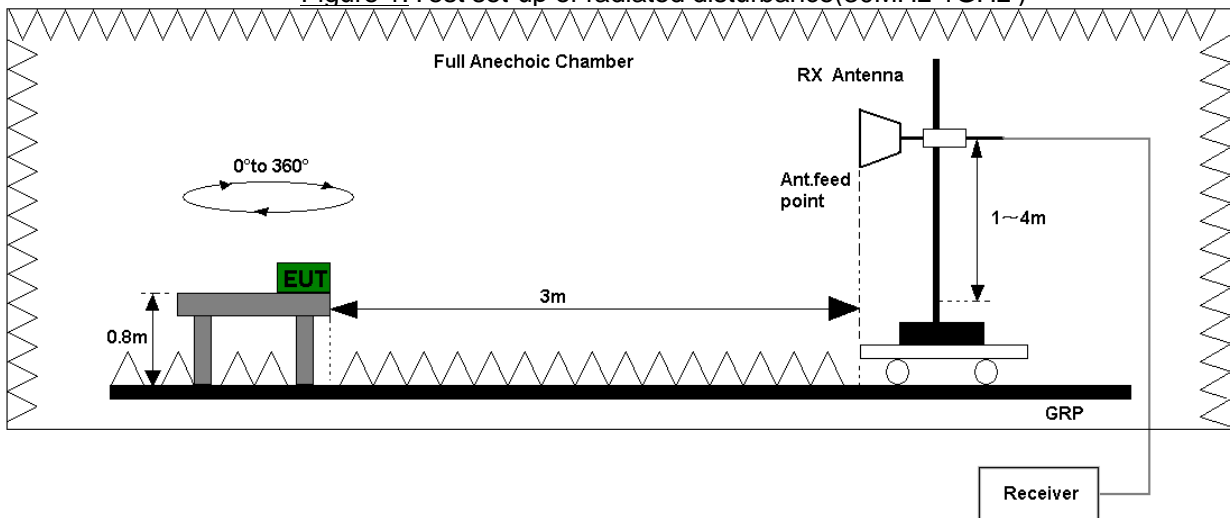

Figure 2. Test set-up of radiated disturbance(above 1GHz)



4.1.3 Test Results

The EUT has met the requirements for Radiated Emission of enclosure port.
 Refer to the section 7 of this report for test data.

Test Limits (Class B)				
Frequency of Emission (MHz)	Radiated Limit			
	Unit(μ V/m)		Unit(dB μ V/m)	
30-88	100		40	
88-216	150		43.5	
216-960	200		46	
Above 960	500		54	
Above 1000	AV	PK	AV	PK
	500	5000	54	74

4.2 Conducted Disturbance 0.15 MHz to 30MHz

4.2.1 Test Procedure

The Table-top EUT was placed upon a non-metallic table 0.8 m above the horizontal metal reference ground plane. EUT was connected to LISN and LISN was connected to reference Ground Plane. EUT was 80cm away from LISN. The set-up and test methods were according to ANSI C63.4-2014. Conducted Disturbance at AC Port measurements were undertaken on the L and N Lines. The emissions were measured using a Quasi-Peak Detector and Average Detector. EUT was communicated with the simulator through Air interface, the simulator controls the EUT to transmitter the maximum power which defined in specification of product. The EUT operated on the typical channel.

Measurement bandwidth (RBW) for 150 kHz to 30 MHz: 9 kHz;

The EUT was set in the shielded chamber and operated under nominal conditions.

4.2.2 Test Setup

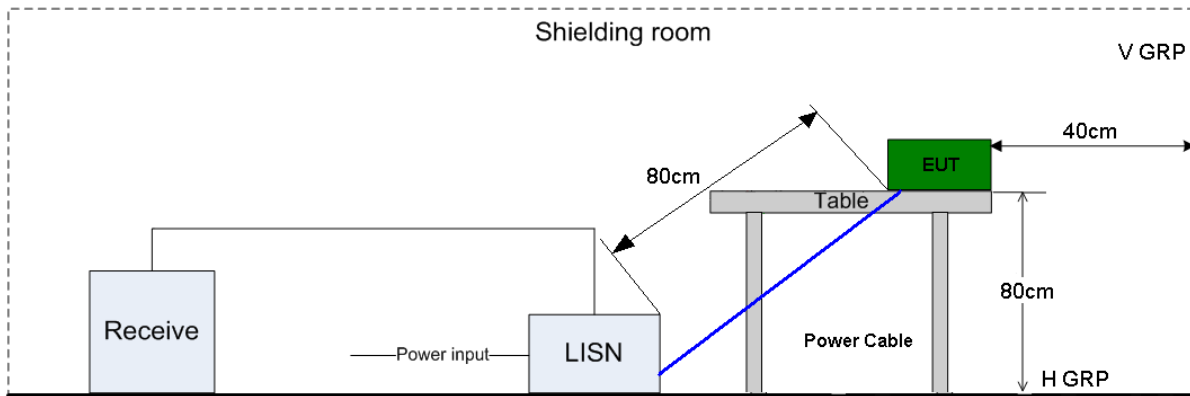

Figure 3. Test Set-up of conducted disturbance

4.2.3 Test Results

The EUT has met requirements for Conducted disturbance of power lines.

Refer to the section 7 of this report for test data.

Test Limit of AC Power Port		
Frequency range	150kHz ~ 30MHz	
Frequency	Voltage limits	
	QP (dB μ V)	AV (dB μ V)
0.15MHz~0.5MHz	66-56	56-46
0.5MHz-5MHz	56	46
5MHz~30MHz	60	50

5 Main Test Instruments

Main Test Equipments						
Test item	Test Instrument	Model	S/N	Manufacturer	Calibrated Deadline	Cal interval
RE	EMI Test receiver	ESU26	100150	R&S	Feb. 20, 2018	12
	Spectrum Analyzer	E4447A	MY52090002	Agilent	Oct. 22, 2018	12
	Broadband Antenna	VULB 9163	9163-491	SCHWARZB ECK	Mar. 28, 2019	24
	Horn Antenna	HF906	100683	R&S	Mar. 28, 2019	24
	Horn antenna (18 to 40GHz)	SAS-574	426	A.H.Systems	Air.09,2018	24
CE	EMI Test receiver	ESU26	101163	R&S	Feb. 20, 2018	12
	Artificial Mains Network	ENV216	100382	R&S	May. 15, 2018	12
Software Information						
Test Item	Software Name	Manufacturer		Version		
RE	EMC32	R&S		V9.25.0		
RE	ES-K1	R&S		V1.7.1		
CE	EMC32	R&S		V9.25.0		

6 System Measurement Uncertainty

For a 95% confidence level, the measurement expanded uncertainties for defined systems, in accordance with the recommendations of ISO 17025 were:

System Measurement Uncertainty		
Items	Extended Uncertainty	
RE(30MHz-1GHz)	Field strength (dB μ V/m)	U=4.1dB; k=2
RE(1GHz-18GHz)	Field strength (dB μ V/m)	U=5.0dB; k=2
RE(18 GHz-26.5GHz)	Field strength (dB μ V/m)	U=5.9 dB; k=2
RE (26.5 GHz- 40GHz)	Field strength (dB μ V/m)	U=5.8 dB; k=2
CE	Disturbance Voltage (dB μ V)	U=2.5dB; k=2

7 Test Data and Graph

Only the worst test results were shown

7.1 Radiated Disturbance

7.1.1 30MHz~1GHz

Test Mode3: Data Transmitting (EUT with PC)

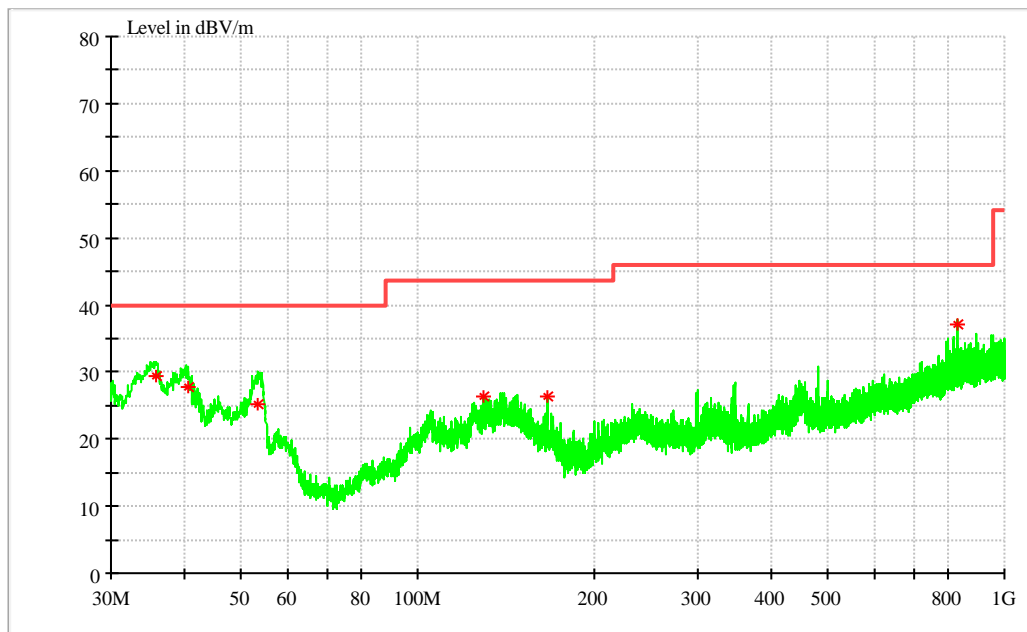

MEASUREMENT RESULT: QP Detector

Frequency MHz	Level dB μ V/m	Transd dB	Limit dB μ V/m	Margin dB	Height cm	Azimuth deg	Polarisation
35.868500	29.48	16.1	40.00	10.52	100.0	257.0	V
40.476000	27.82	17.3	40.00	12.18	100.0	2.0	V
53.522500	25.09	11.3	40.00	14.91	100.0	94.0	V
129.522000	26.29	13.8	43.50	17.21	100.0	173.0	V
166.042500	26.31	11.8	43.50	17.19	100.0	118.0	V
828.843500	37.19	25.6	46.00	8.81	100.0	161.0	V

Note:

Level = Reading level by receiver + Transd (Antenna factor + cable loss – preamplifier gain)

The reading level is calculated by software which is not shown in the sheet.

7.1.2 1GHz~18GHz

Test Mode3: Data Transmitting (EUT with PC)

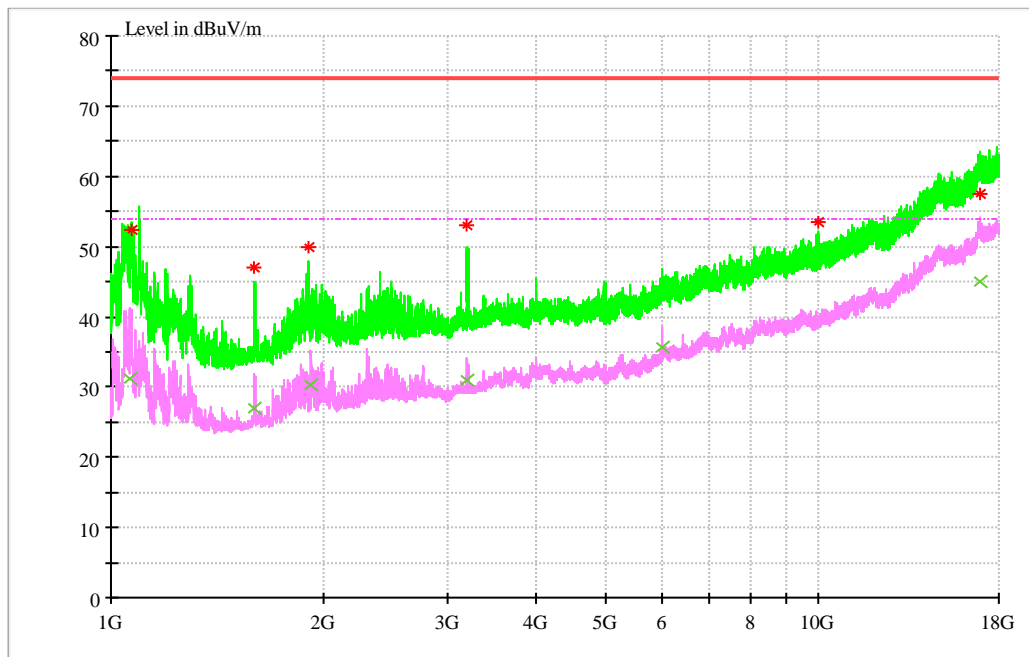

MEASUREMENT RESULT: PK Detector

Frequency MHz	Level dB μ V/m	Transd dB	Limit dB μ V/m	Margin dB	Height cm	Azimuth deg	Polarisation
1067.433	52.42	-15.2	74.0	21.58	100.0	138.0	V
1597.266	46.99	-12.0	74.0	31.01	100.0	56.0	V
1899.866	50.01	-10.0	74.0	27.99	100.0	138.0	V
3190.166	52.98	-4.5	74.0	21.02	100.0	216.0	V
9977.700	53.57	7.4	74.0	20.43	100.0	164.0	V
16926.733	57.44	20.8	74.0	16.56	100.0	170.0	H

MEASUREMENT RESULT: AV Detector

Frequency MHz	Level dB μ V/m	Transd dB	Limit dB μ V/m	Margin dB	Height cm	Azimuth deg	Polarisation
1061.200	31.25	-15.3	54.0	22.75	100.0	138.0	V
1593.866	26.89	-12.0	54.0	27.11	100.0	56.0	V
1919.700	30.31	-9.9	54.0	24.69	100.0	107.0	V
3190.733	31.05	-4.5	54.0	22.95	100.0	32.0	V
6000.266	35.63	1.2	54.0	18.37	100.0	56.0	V
16909.166	45.06	20.9	54.0	8.94	100.0	14.0	H

Note:

Level = Reading level by receiver + Transd (Antenna factor + cable loss – preamplifier gain)
 The reading level is calculated by software which is not shown in the sheet.

7.1.3 18GHz-26.5GHz

Test Mode3: Data Transmitting (EUT with PC)

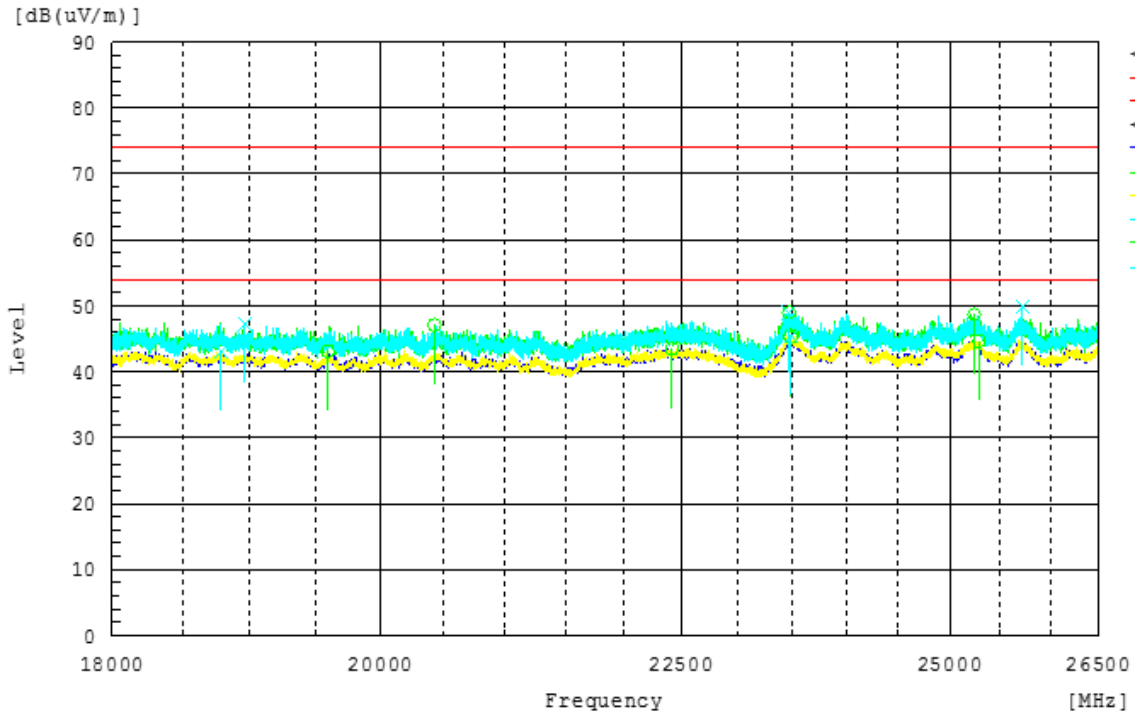

MEASUREMENT RESULT: PK Detector

Frequency MHz	Level dB μ V/m	Transd dB	Limit dB μ V/m	Margin dB	Height cm	Azimuth deg	Polarisation
18953.700	47.2	-15.3	74.0	26.8	100.0	121.0	V
20425.050	47.0	-16.3	74.0	27.0	100.0	341.0	H
23462.100	48.9	-12.5	74.0	25.1	100.0	128.0	V
23469.750	48.9	-12.4	74.0	25.1	100.0	286.0	H
25241.150	48.7	-11.8	74.0	25.3	100.0	327.0	H
25718.850	49.9	-11.6	74.0	24.1	100.0	279.0	V

MEASUREMENT RESULT: AV Detector

Frequency MHz	Level dB μ V/m	Transd dB	Limit dB μ V/m	Margin dB	Height cm	Azimuth deg	Polarisation
18782.000	43.1	-14.6	54.0	10.9	100.0	1.0	V
19587.800	43.0	-16.5	54.0	11.0	100.0	360.0	H
22415.800	43.5	-13.6	54.0	10.5	100.0	170.0	H
23485.100	45.5	-12.2	54.0	8.5	100.0	80.0	V
23486.800	45.2	-12.2	54.0	8.8	100.0	74.0	H
25280.300	44.7	-11.8	54.0	9.3	100.0	314.0	H

Note:

Level = Reading level by receiver + Transd (Antenna factor + cable loss – preamplifier gain)
 The reading level is calculated by software which is not shown in the sheet.

7.1.4 26.5GHz-40GHz

Test Mode3: Data Transmitting (EUT with PC)

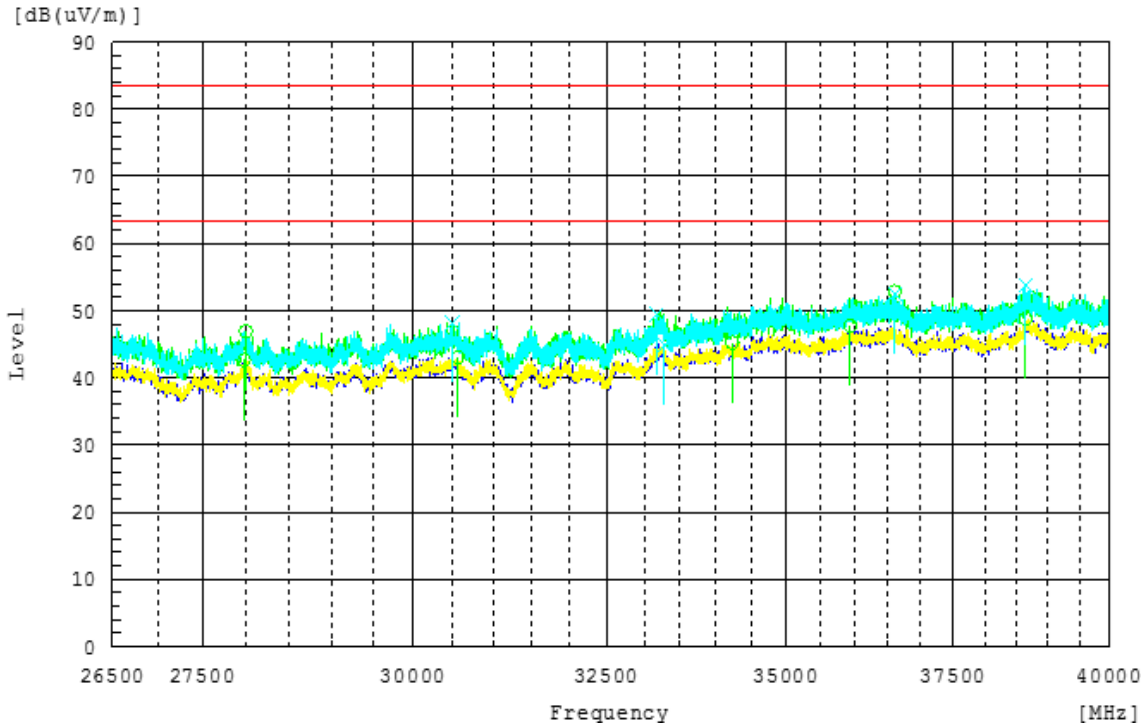

MEASUREMENT RESULT: PK Detector

Frequency MHz	Level dB μ V/m	Transd dB	Limit dB μ V/m	Margin dB	Height cm	Azimuth deg	Polarisation
27998.500	46.9	-10.5	84.0	37.1	100.0	169.0	H
30494.650	48.2	-5.7	84.0	35.8	100.0	1.0	V
33177.100	49.5	-1.2	84.0	34.5	100.0	95.0	V
36608.800	52.6	3.0	84.0	31.4	100.0	184.0	V
36611.500	52.8	3.0	84.0	31.2	100.0	265.0	H
38632.450	53.8	1.0	84.0	30.2	100.0	238.0	V

MEASUREMENT RESULT: AV Detector

Frequency MHz	Level dB μ V/m	Transd dB	Limit dB μ V/m	Margin dB	Height cm	Azimuth deg	Polarisation
27979.600	42.7	-10.6	64.0	21.3	100.0	0.0	H
30562.150	43.1	-5.7	64.0	20.9	100.0	3.0	H
33277.000	44.9	-0.9	64.0	19.1	100.0	245.0	V
34232.800	45.2	1.3	64.0	18.8	100.0	0.0	H
35941.900	47.8	3.4	64.0	16.2	100.0	26.0	H
38631.100	48.7	1.0	64.0	15.3	100.0	0.0	H

Note:

Level =Reading level by receiver + Transd (Antenna factor + cable loss – preamplifier gain)

The reading level is calculated by software which is not shown in the sheet.

Limit:(PK)=74+20log(D1/D2)=74+20log(3/1)=84

Limit:(AV)=54+20log(D1/D2)=54+20log(3/1)=64

7.2 Conducted Disturbance

7.2.1 AC Port Test Data

Test Mode1: Charging(EUT with adapter)+Camera On +(WiFi BT GPS) On

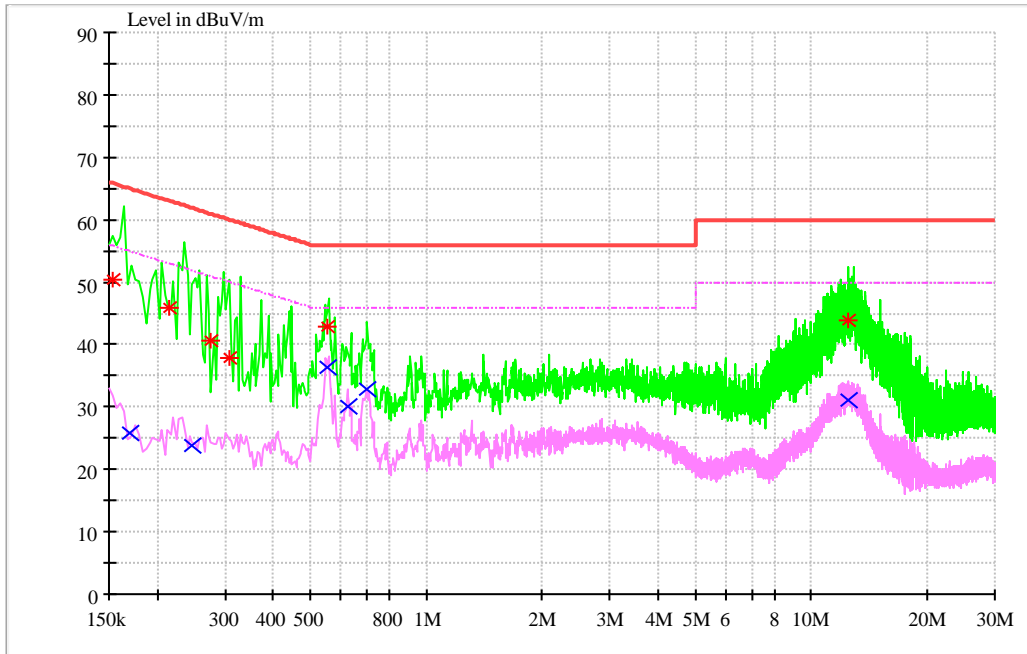

MEASUREMENT RESULT: QP Detector

Frequency MHz	Level dB μ V	Line	Transd dB	Margin dB	Limit dB μ V	PE
0.153422	50.46	L1	9.7	15.35	65.81	FLO
0.214523	45.79	N	9.7	17.24	63.03	FLO
0.274815	40.55	L1	9.7	20.42	60.97	FLO
0.307419	37.89	N	9.7	22.15	60.04	FLO
0.553115	42.84	N	9.7	13.16	56.00	FLO
12.526083	43.97	N	10.0	16.03	60.00	FLO

MEASUREMENT RESULT: AV Detector

Frequency MHz	Level dB μ V	Line	Transd dB	Margin dB	Limit dB μ V	PE
0.169997	25.70	N	9.7	29.26	54.96	FLO
0.246531	23.88	N	9.7	27.99	51.87	FLO
0.553628	36.45	N	9.7	9.55	46.00	FLO
0.623349	30.18	N	9.7	15.82	46.00	FLO
0.696809	32.92	N	9.7	13.08	46.00	FLO
12.523984	31.17	N	10.0	18.83	50.00	FLO

-----**END**-----