

## FCC Test Report (15.407)

**Report No.:** RF150506E05E-1 R1

**FCC ID:** QISCG1241D

**Test Model:** CG1241D

**Series Model:** CG5245

**Received Date:** May 06, 2015

**Test Date:** May 29 to July 10, 2015

**Issued Date:** Aug. 31, 2015

**Applicant:** Huawei Technologies Co., Ltd.

**Address:** Administration Building, Headquarters of Huawei Technologies Co., Ltd.,  
Bantian, Longgang District, Shenzhen, China

**Issued By:** Bureau Veritas Consumer Products Services (H.K.) Ltd., Taoyuan Branch  
Hsin Chu Laboratory

**Lab Address:** No. 81-1, Lu Liao Keng, 9th Ling, Wu Lung Tsuen, Chiung Lin Hsiang, Hsin  
Chu Hsien 307, Taiwan R.O.C.

**Test Location (1):** No. 81-1, Lu Liao Keng, 9th Ling, Wu Lung Tsuen, Chiung Lin Hsiang, Hsin  
Chu Hsien 307, Taiwan R.O.C.

**Test Location (2):** No. 49, Ln. 206, Wende Rd., Shangshan Tsuen, Chiung Lin Hsiang, Hsin  
Chu Hsien 307, Taiwan R.O.C.



This report is for your exclusive use. Any copying or replication of this report to or for any other person or entity, or use of our name or trademark, is permitted only with our prior written permission. This report sets forth our findings solely with respect to the test samples identified herein. The results set forth in this report are not indicative or representative of the quality or characteristics of the lot from which a test sample was taken or any similar or identical product unless specifically and expressly noted. Our report includes all of the tests requested by you and the results thereof based upon the information that you provided to us. You have 60 days from date of issuance of this report to notify us of any material error or omission caused by our negligence, provided, however, that such notice shall be in writing and shall specifically address the issue you wish to raise. A failure to raise such issue within the prescribed time shall constitute your unqualified acceptance of the completeness of this report, the tests conducted and the correctness of the report contents. Unless specific mention, the uncertainty of measurement has been explicitly taken into account to declare the compliance or non-compliance to the specification. The report must not be used by the client to claim product certification, approval, or endorsement by TAF or any government agencies.



### Table of Contents

<b>Release Control Record</b> .....	<b>4</b>
<b>1 Certificate of Conformity</b> .....	<b>5</b>
<b>2 Summary of Test Results</b> .....	<b>6</b>
2.1 Measurement Uncertainty .....	6
2.2 Modification Record .....	6
<b>3 General Information</b> .....	<b>7</b>
3.1 General Description of EUT .....	7
3.2 Description of Test Modes .....	10
3.2.1 Test Mode Applicability and Tested Channel Detail .....	11
3.3 Duty Cycle of Test Signal .....	13
3.4 Description of Support Units .....	14
3.4.1 Configuration of System under Test .....	15
3.5 General Description of Applied Standard .....	16
<b>4 Test Types and Results</b> .....	<b>17</b>
4.1 Radiated Emission and Bandedge Measurement.....	17
4.1.1 Limits of Radiated Emission and Bandedge Measurement .....	17
4.1.2 Test Instruments .....	18
4.1.3 Test Procedure .....	20
4.1.4 Deviation from Test Standard .....	20
4.1.5 Test Setup.....	21
4.1.6 EUT Operating Condition .....	21
4.1.7 Test Results .....	22
4.2 Conducted Emission Measurement .....	39
4.2.1 Limits of Conducted Emission Measurement .....	39
4.2.2 Test Instruments .....	39
4.2.3 Test Procedure .....	40
4.2.4 Deviation from Test Standard .....	40
4.2.5 Test Setup.....	40
4.2.6 EUT Operating Condition .....	40
4.2.7 Test Results (Mode 1).....	41
4.2.8 Test Results (Mode 2).....	43
4.3 Transmit Power Measurement .....	45
4.3.1 Limits of Transmit Power Measurement .....	45
4.3.2 Test Setup.....	45
4.3.3 Test Instruments .....	45
4.3.4 Test Procedure .....	45
4.3.5 Deviation from Test Standard .....	45
4.3.6 EUT Operating Condition .....	45
4.3.7 Test Result.....	46
4.4 Peak Power Spectral Density Measurement .....	47
4.4.1 Limits of Peak Power Spectral Density Measurement .....	47
4.4.2 Test Setup.....	47
4.4.3 Test Instruments .....	47
4.4.4 Test Procedure .....	47
4.4.5 Deviation from Test Standard .....	47
4.4.6 EUT Operating Condition .....	47
4.4.7 Test Results .....	48
4.5 Frequency Stability Measurement .....	52
4.5.1 Limits of Frequency Stability Measurement .....	52
4.5.2 Test Setup.....	52
4.5.3 Test Instruments .....	52
4.5.4 Test Procedure .....	52
4.5.5 Deviation from Test Standard .....	52



4.5.6 EUT Operating Condition .....	52
4.5.7 Test Results .....	53
4.6 6dB Bandwidth Measurement .....	54
4.6.1 Limits of 6dB Bandwidth Measurement .....	54
4.6.2 Test Setup .....	54
4.6.3 Test Instruments .....	54
4.6.4 Test Procedure .....	54
4.6.5 Deviation from Test Standard .....	54
4.6.6 EUT Operating Condition .....	54
4.6.7 Test Results .....	55
<b>5 Pictures of Test Arrangements .....</b>	<b>57</b>
<b>Appendix – Information on the Testing Laboratories .....</b>	<b>58</b>



A D T

### Release Control Record

Issue No.	Description	Date Issued
RF150506E05E-1	Original release.	Aug. 06, 2015
RF150506E05E-1 R1	1. Modified the brand name of EUT. 2. Modified the Model name of EUT. 3. Revised the applicant and FCC ID.	Aug. 31, 2015



1 Certificate of Conformity

**Product:** WiFi EMTA

**Brand:** Huawei

**Test Model:** CG1241D

**Series Model:** CG5245

**Sample Status:** ENGINEERING SAMPLE

**Applicant:** Huawei Technologies Co., Ltd.

**Test Date:** May 29 to July 10, 2015

**Standard:** 47 CFR FCC Part 15, Subpart E (Section 15.407)  
ANSI C63.10:2013

The above equipment has been tested by **Bureau Veritas Consumer Products Services (H.K.) Ltd., Taoyuan Branch**, and found compliance with the requirement of the above standards. The test record, data evaluation & Equipment Under Test (EUT) configurations represented herein are true and accurate accounts of the measurements of the sample's EMC characteristics under the conditions specified in this report.

**Prepared by :**  , **Date:** Aug. 31, 2015  
Lori Chung / Specialist

**Approved by :**  , **Date:** Aug. 31, 2015  
May Chen / Manager

## 2 Summary of Test Results

47 CFR FCC Part 15, Subpart E (SECTION 15.407 Under New Rule)			
FCC Clause	Test Item	Result	Remarks
15.407(b)(6)	AC Power Conducted Emissions	PASS	Meet the requirement of limit. Minimum passing margin is -14.42dB at 17.05859MHz.
15.407(b) (1/2/3/4/6)	Radiated Emissions & Band Edge Measurement	PASS	Meet the requirement of limit. Minimum passing margin is -0.1dB at 5150.00MHz, 5725.00MHz, 5850.00MHz, 10480.00MHz, 5715.00MHz.
15.407(a)(1/2 /3)	Max Average Transmit Power	PASS	Meet the requirement of limit.
15.407(a)(1/2 /3)	Peak Power Spectral Density	PASS	Meet the requirement of limit.
15.407(e)	6dB bandwidth	PASS	Meet the requirement of limit. (U-NII-3 Band only)
15.407(g)	Frequency Stability	PASS	Meet the requirement of limit.
15.203	Antenna Requirement	PASS	Antenna connector is i-pex(MHF) not a standard connector.

**NOTE:** The EUT was operating in 2400 ~ 2483.5MHz, 5150~5250MHz and 5725~5850MHz frequencies band. This report was recorded the RF parameters including 5150~5250MHz and 5725~5850MHz. For the 2400 ~ 2483.5MHz RF parameters was recorded in another test report.

### 2.1 Measurement Uncertainty

Where relevant, the following measurement uncertainty levels have been estimated for tests performed on the EUT as specified in CISPR 16-4-2:

Measurement	Frequency	Expanded Uncertainty (k=2) (±)
Conducted Emissions at mains ports	150kHz ~ 30MHz	2.86 dB
Radiated Emissions up to 1 GHz	30MHz ~ 1GHz	5.43 dB
Radiated Emissions above 1 GHz	1GHz ~ 6GHz	3.65 dB
	6GHz ~ 18GHz	3.88 dB
	18GHz ~ 40GHz	4.11 dB

### 2.2 Modification Record

There were no modifications required for compliance.

### 3 General Information

#### 3.1 General Description of EUT

Product	WiFi EMTA
Brand	Huawei
Test Model	CG1241D
Series Model	CG5245
Status of EUT	ENGINEERING SAMPLE
Power Supply Rating	12Vdc from power adapter
Modulation Type	CCK, DQPSK, DBPSK for DSSS 64QAM, 16QAM, QPSK, BPSK for OFDM
Modulation Technology	DSSS, OFDM
Transfer Rate	802.11b: up to 11Mbps 802.11a/g: up to 54Mbps 802.11n: up to 300Mbps
Operating Frequency	<b>For 15.407</b> 5.18 ~ 5.24GHz, 5.745 ~ 5.825GHz
	<b>For 15.247</b> 2.412 ~ 2.462GHz
Number of Channel	<b>For 15.407</b> 9 for 802.11a, 802.11n (HT20) 4 for 802.11n (HT40)
	<b>For 15.247</b> 11 for 802.11b, 802.11g, 802.11n (HT20) 7 for 802.11n (HT40)
Output Power	<b>For 15.407</b> 802.11a: 266.606mW 802.11n (HT20): 252.439mW 802.11n (HT40): 115.994mW
	<b>For 15.247</b> 802.11b: 258.226mW 802.11g: 682.092mW 802.11n (HT20): 612.08mW 802.11n (HT40): 156.884mW
Antenna Type	Refer to Note
Antenna Connector	Refer to Note
Accessory Device	Adapter x 1
Data Cable Supplied	NA

**Note:**

1. The EUT has different model names which are identical to each other in all aspects except for the following table:

Brand	Model Name	Description
Huawei	CG1241D	WLAN: 2.4GHz and 5GHz band.
	CG5245	WLAN: 2.4GHz and 5GHz band.

Note: From the above models, model: CG1241D was selected as representative model for the test and its data was recorded in this report.

2. The EUT must be supplied with a power adapter and following two different models could be chosen as following table:

No	Manufacturer	Brand	Model No.	Spec.
1	SHENZHEN HUNTKEY ELECTRIC CO., LTD.	HUAWEI	HW-120200U1W	Input: 100-240V, 0.8A, 50-60Hz Output: 12V, 2A DC output cable: 1.5m, unshielded
2	DONGGUAN SHILONG FUHUA ELECTRONIC CO., LTD	HUAWEI	HW-120200U1W	Input: 100-240V, 0.8A, 50-60Hz Output: 12V, 2A DC output cable: 1.5m, unshielded

For Radiated Emission test, the EUT was pre-tested with adapter 1 & 2, the worst case was found in adapter 2. Therefore only the test data of the adapter 2 was recorded in this report.

3. The emission of the simultaneous operation (2.4GHz & 5GHz) has been evaluated and no non-compliance was found.

4. The antennas provided to the EUT, please refer to the following table:

2.4GHz Band						
Antenna No.	PCB Chain No.	Brand	Ant. Gain(dBi) <Including cable loss>	Frequency range (GHz to GHz)	Antenna Type	Connector Type
A	Chain (1)	NA	3.76	2.4~2.4835	PCB	None (like solder)
B	Chain (2)	NA	3.87	2.4~2.4835	PCB	None (like solder)

For 802.11b, the worst case was found in Ant. B Chain (2). Therefore only the test data of the mode was recorded in this report.

5GHz Band						
Antenna No.	PCB Chain No.	Brand	Ant. Gain(dBi) <Including cable loss>	Frequency range (GHz to GHz)	Antenna Type	Connector Type
C	Chain (1)	Hong-Lin	5.78	5.15~5.85	PCB	i-pex(MHF)
D	Chain (2)	Hong-Lin	4.36	5.15~5.85	PCB	i-pex(MHF)



5. The EUT incorporates a MIMO function.

<b>2.4GHz Band</b>			
<b>MODULATION MODE</b>	<b>DATA RATE (MCS)</b>	<b>TX &amp; RX CONFIGURATION</b>	
<b>802.11b</b>	1 ~ 11Mbps	1TX (diversity)	1RX
<b>802.11g</b>	6 ~ 54Mbps	2TX	2RX
<b>802.11n (HT20)</b>	MCS 0~7	2TX	2RX
	MCS 8~15	2TX	2RX
<b>802.11n (HT40)</b>	MCS 0~7	2TX	2RX
	MCS 8~15	2TX	2RX
<b>5GHz Band</b>			
<b>MODULATION MODE</b>	<b>DATA RATE (MCS)</b>	<b>TX &amp; RX CONFIGURATION</b>	
<b>802.11a</b>	6 ~ 54Mbps	2TX	2RX
<b>802.11n (HT20)</b>	MCS 0~7	2TX	2RX
	MCS 8~15	2TX	2RX
<b>802.11n (HT40)</b>	MCS 0~7	2TX	2RX
	MCS 8~15	2TX	2RX

6. The above EUT information is declared by manufacturer and for more detailed features description, please refer to the manufacturer's specifications or user's manual.

### 3.2 Description of Test Modes

#### For 5180 ~ 5240MHz

4 channels are provided for 802.11a, 802.11n (HT20):

Channel	Frequency	Channel	Frequency
36	5180 MHz	44	5220 MHz
40	5200 MHz	48	5240 MHz

2 channels are provided for 802.11n (HT40):

Channel	Frequency	Channel	Frequency
38	5190 MHz	46	5230 MHz

#### For 5745 ~ 5825MHz:

5 channels are provided for 802.11a, 802.11n (HT20):

Channel	Frequency	Channel	Frequency
149	5745MHz	161	5805MHz
153	5765MHz	165	5825MHz
157	5785MHz		

2 channels are provided for 802.11n (HT40):

Channel	Frequency	Channel	Frequency
151	5755MHz	159	5795MHz

### 3.2.1 Test Mode Applicability and Tested Channel Detail

EUT CONFIGURE MODE	APPLICABLE TO				DESCRIPTION
	RE $\geq$ 1G	RE<1G	PLC	APCM	
1	-	-	√	-	With adapter 1
2	√	√	√	√	With adapter 2

Where **RE $\geq$ 1G**: Radiated Emission above 1GHz      **RE<1G**: Radiated Emission below 1GHz  
**PLC**: Power Line Conducted Emission      **APCM**: Antenna Port Conducted Measurement

**NOTE**: "-" means no effect.

#### **Radiated Emission Test (Above 1GHz):**

- Pre-Scan has been conducted to determine the worst-case mode from all possible combinations between available modulations, data rates and antenna ports (if EUT with antenna diversity architecture).
- Following channel(s) was (were) selected for the final test as listed below.

MODE	FREQ. BAND (MHz)	AVAILABLE CHANNEL	TESTED CHANNEL	MODULATION TECHNOLOGY	MODULATION TYPE	DATA RATE (Mbps)
802.11a	5180-5240	36 to 48	36, 40, 48	OFDM	BPSK	6
802.11n (HT20)		36 to 48	36, 40, 48	OFDM	BPSK	6.5
802.11n (HT40)		38 to 46	38, 46	OFDM	BPSK	13.5
802.11a	5745-5825	149 to 165	149, 157, 165	OFDM	BPSK	6
802.11n (HT20)		149 to 165	149, 157, 165	OFDM	BPSK	6.5
802.11n (HT40)		151 to 159	151, 159	OFDM	BPSK	13.5

#### **Radiated Emission Test (Below 1GHz):**

- Pre-Scan has been conducted to determine the worst-case mode from all possible combinations between available modulations, data rates and antenna ports (if EUT with antenna diversity architecture).
- Following channel(s) was (were) selected for the final test as listed below.

MODE	FREQ. BAND (MHz)	AVAILABLE CHANNEL	TESTED CHANNEL	MODULATION TECHNOLOGY	MODULATION TYPE	DATA RATE (Mbps)
802.11a	5180-5240 5745-5825	36 to 48 149 to 165	157	OFDM	BPSK	6

#### **Power Line Conducted Emission Test:**

- Pre-Scan has been conducted to determine the worst-case mode from all possible combinations between available modulations, data rates and antenna ports (if EUT with antenna diversity architecture).
- Following channel(s) was (were) selected for the final test as listed below.

MODE	FREQ. BAND (MHz)	AVAILABLE CHANNEL	TESTED CHANNEL	MODULATION TECHNOLOGY	MODULATION TYPE	DATA RATE (Mbps)
802.11a	5180-5240 5745-5825	36 to 48 149 to 165	157	OFDM	BPSK	6

**Antenna Port Conducted Measurement:**

- This item includes all test value of each mode, but only includes spectrum plot of worst value of each mode.
- Pre-Scan has been conducted to determine the worst-case mode from all possible combinations between available modulations, data rates and antenna ports (if EUT with antenna diversity architecture).
- Following channel(s) was (were) selected for the final test as listed below.

MODE	FREQ. BAND (MHz)	AVAILABLE CHANNEL	TESTED CHANNEL	MODULATION TECHNOLOGY	MODULATION TYPE	DATA RATE (Mbps)
802.11a	5180-5240	36 to 48	36, 40, 48	OFDM	BPSK	6
802.11n (HT20)		36 to 48	36, 40, 48	OFDM	BPSK	6.5
802.11n (HT40)		38 to 46	38, 46	OFDM	BPSK	13.5
802.11a	5745-5825	149 to 165	149, 157, 165	OFDM	BPSK	6
802.11n (HT20)		149 to 165	149, 157, 165	OFDM	BPSK	6.5
802.11n (HT40)		151 to 159	151, 159	OFDM	BPSK	13.5

**Test Condition:**

APPLICABLE TO	ENVIRONMENTAL CONDITIONS	INPUT POWER	TESTED BY
RE $\geq$ 1G	23deg. C, 67%RH	120Vac, 60Hz	Weiwei Lo
RE $<$ 1G	22deg. C, 70%RH	120Vac, 60Hz	Weiwei Lo
PLC	25deg. C, 67%RH	120Vac, 60Hz	Jyunchun Lin
APCM	25deg. C, 60%RH	120Vac, 60Hz	Tim Ho

### 3.3 Duty Cycle of Test Signal

Duty cycle of test signal is  $\geq 98\%$ , duty factor is not required.

**802.11a:** Duty cycle = 2.97 ms/3.002 ms = 0.989

**802.11n (HT20):** Duty cycle = 2.747 ms/2.788 ms = 0.985

**802.11n (HT40):** Duty cycle = 1.343 ms/1.369 ms = 0.981

**802.11a**

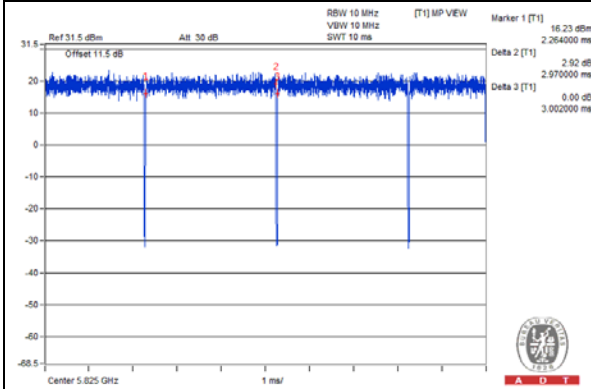

**802.11n (HT20)**

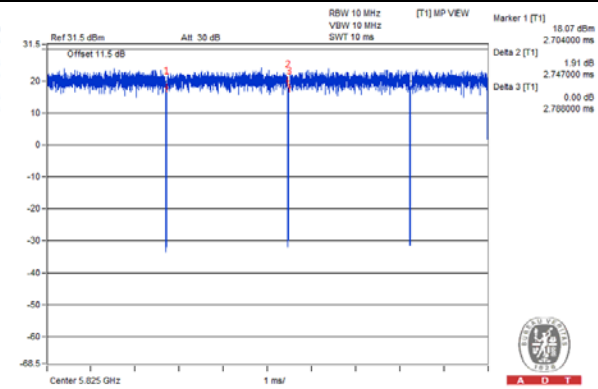

**802.11n (HT40)**

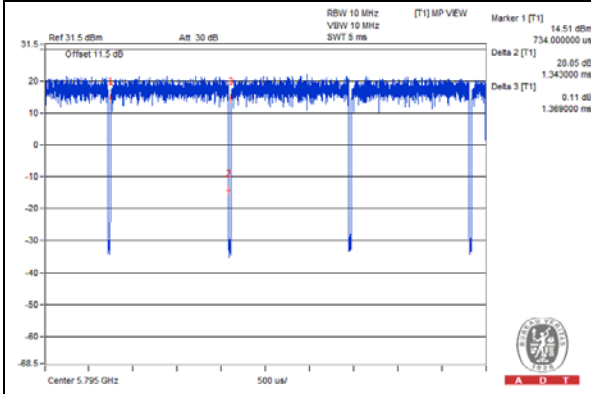

### 3.4 Description of Support Units

The EUT has been tested as an independent unit together with other necessary accessories or support units. The following support units or accessories were used to form a representative test configuration during the tests.

No.	Product	Brand	Model No.	Serial No.	FCC ID	Remark
A	PHONE (For conducted emission test)	WONDER	WD-303	7C17KA05211	NA	Provided by Lab
	PHONE (For other test items)	WONDER	WD-303	7C17KA04011	NA	Provided by Lab
B	PHONE (For conducted emission test)	WONDER	WD-303	7C17KA04440	NA	Provided by Lab
	PHONE (For other test items)	WONDER	WD-303	8C17DA02763	NA	Provided by Lab
C	NOTEBOOK COMPUTER	DELL	PP18L	12252644560	FCC DoC	Provided by Lab
D	SWITCH	Linksys	SD208	NA	NA	Provided by Lab

**NOTE:**

1. All power cords of the above support units are non-shielded (1.8 m).

No.	Cable	Qty.	Length (m)	Shielded (Yes/ No)	Cores (Number)	Remark
1	DC	1	1.5	No	0	Supplied by Client
2	RJ11	1	1.8	No	0	Provided by Lab
3	RJ11	1	1.8	No	0	Provided by Lab
4	RJ45	1	10	No	0	Provided by Lab
5	Coaxial	1	10	Yes	0	Provided by Lab
6	RJ45	3	10	No	0	Provided by Lab

### 3.4.1 Configuration of System under Test

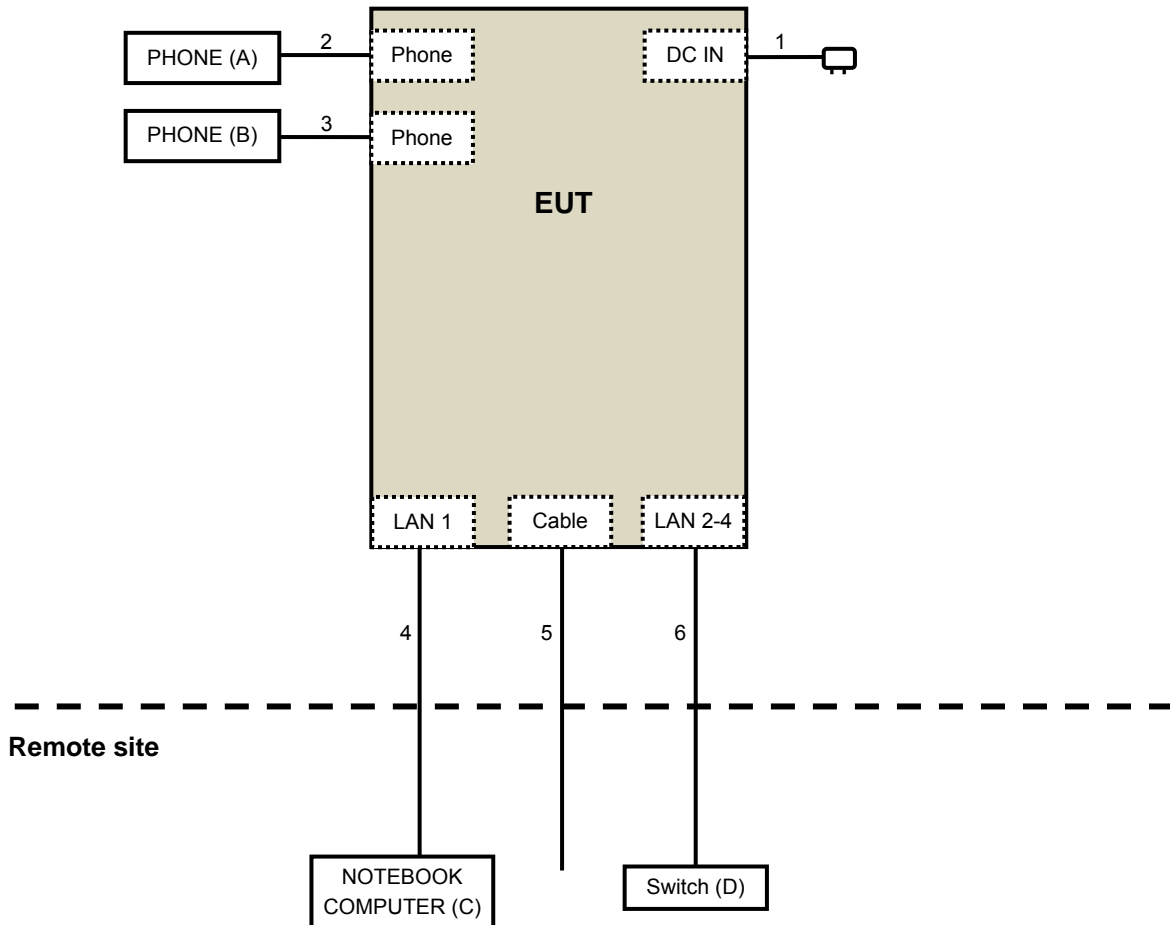

### 3.5 General Description of Applied Standard

The EUT is a RF Product. According to the specifications of the manufacturer, it must comply with the requirements of the following standards:

**FCC Part 15, Subpart E (15.407)**  
**789033 D02 General UNII Test Procedure New Rules v01**  
**662911 D01 Multiple Transmitter Output v02r01**  
ANSI C63.10-2013

All test items have been performed and recorded as per the above standards.

**NOTE:** The EUT has been verified to comply with the requirements of FCC Part 15, Subpart B, Class B (DoC). The test report has been issued separately.



## 4 Test Types and Results

### 4.1 Radiated Emission and Bandedge Measurement

#### 4.1.1 Limits of Radiated Emission and Bandedge Measurement

Radiated emissions which fall in the restricted bands must comply with the radiated emission limits specified as below table.

Frequencies (MHz)	Field Strength (microvolts/meter)	Measurement Distance (meters)
0.009 ~ 0.490	2400/F(kHz)	300
0.490 ~ 1.705	24000/F(kHz)	30
1.705 ~ 30.0	30	30
30 ~ 88	100	3
88 ~ 216	150	3
216 ~ 960	200	3
Above 960	500	3

#### NOTE:

1. The lower limit shall apply at the transition frequencies.
2. Emission level (dBuV/m) = 20 log Emission level (uV/m).
3. For frequencies above 1000MHz, the field strength limits are based on average detector, however, the peak field strength of any emission shall not exceed the maximum permitted average limits, specified above by more than 20dB under any condition of modulation.

#### LIMITS OF UNWANTED EMISSION OUT OF THE RESTRICTED BANDS

APPLICABLE TO	LIMIT	
789033 D02 General UNII Test Procedure New Rules v01	FIELD STRENGTH AT 3m	
	PK:74 (dBuV/m)	AV:54 (dBuV/m)
APPLICABLE TO	EIRP LIMIT	EQUIVALENT FIELD STRENGTH AT 3m
15.407(b)(1)	PK:-27 (dBm/MHz)	PK:68.2(dBuV/m)
15.407(b)(2)		
15.407(b)(3)		
15.407(b)(4)	PK:-27 (dBm/MHz) <sup>*1</sup> PK:-17 (dBm/MHz) <sup>*2</sup>	PK: 68.2(dBuV/m) <sup>*1</sup> PK:78.2 (dBuV/m) <sup>*2</sup>

**NOTE:** <sup>\*1</sup> beyond 10MHz of the band edge <sup>\*2</sup> within 10 MHz of band edge

The following formula is used to convert the equipment isotropic radiated power (eirp) to field strength:

$$E = \frac{1000000\sqrt{30P}}{3} \mu\text{V/m, where P is the eirp (Watts).}$$

#### 4.1.2 Test Instruments

For above 1GHz test:

DESCRIPTION & MANUFACTURER	MODEL NO.	SERIAL NO.	CALIBRATED DATE	CALIBRATED UNTIL
Test Receiver Agilent	N9038A	MY51210105	July 21, 2014	July 20, 2015
Horn_Antenna AISI	AIH.8018	000032009111 0	Feb. 09, 2015	Feb. 08, 2016
Pre-Amplifier Agilent	8449B	3008A02578	June 24, 2014	June 23, 2015
RF Cable	NA	131205 131216 131217 SNMY23684/ 4	Jan. 16, 2015	Jan. 15, 2016
Spectrum Analyzer R&S	FSV40	100964	July 05, 2014	July 04, 2015
Pre-Amplifier SPACEK LABS	SLKKa-48-6	9K16	Dec. 12, 2014	Dec. 11, 2015
Horn_Antenna SCHWARZBECK	BBHA 9170	9170-424	Feb. 05, 2015	Feb. 04, 2016
RF Cable	NA	329751/4 RF104-204	Dec. 11, 2014	Dec. 10, 2015
Software	ADT_Radiated _V8.7.07	NA	NA	NA
Antenna Tower & Turn Table CT	NA	NA	NA	NA
Power Meter Anritsu	ML2495A	1014008	Apr. 28, 2015	Apr. 27, 2016
Power Sensor Anritsu	MA2411B	0917122	Apr. 28, 2015	Apr. 27, 2016
Spectrum Analyzer R&S	FSP 40	100060	May 08, 2015	May 07, 2016
Temperature & Humidity Chamber GIANTFORCE	GTH-150-40-S P-AR	MAA0812-00 8	Jan. 12, 2015	Jan. 11, 2016

**Note:**

1. The calibration interval of the above test instruments is 12 months and the calibrations are traceable to NML/ROC and NIST/USA.
2. The test was performed in 966 Chamber No. G.
3. The FCC Site Registration No. is 966073.
4. The VCCI Site Registration No. is G-137.
5. The CANADA Site Registration No. is IC 7450H-2.
6. Tested Date: June 04 to 05, 2015

**For below 1GHz test:**

DESCRIPTION & MANUFACTURER	MODEL NO.	SERIAL NO.	CALIBRATED DATE	CALIBRATED UNTIL
Test Receiver Agilent	N9038A	MY50010156	Aug. 11, 2014	Aug. 10, 2015
Pre-Amplifier Mini-Circuits	ZFL-1000VH2 B	AMP-ZFL-04	Nov. 12, 2014	Nov. 11, 2015
Trilog Broadband Antenna SCHWARZBECK	VULB 9168	9168-361	Feb. 09, 2015	Feb. 08, 2016
RF Cable	8D-FB	CHHCAB-001- 1 CHHCAB-001- 2	Oct. 05, 2014	Oct. 04, 2015
	RF-141	CHHCAB-004	Oct. 05, 2014	Oct. 04, 2015
Software	ADT_Radiated _V8.7.07	NA	NA	NA
Antenna Tower & Turn Table CT	NA	NA	NA	NA

**Note:**

1. The calibration interval of the above test instruments is 12 months and the calibrations are traceable to NML/ROC and NIST/USA.
2. The test was performed in 966 Chamber No. H.
3. The FCC Site Registration No. is 797305.
4. The CANADA Site Registration No. is IC 7450H-3.
5. Tested Date: July 10, 2015

#### 4.1.3 Test Procedure

- a. The EUT was placed on the top of a rotating table 0.8 meters above the ground at 3 meter chamber room for test. The table was rotated 360 degrees to determine the position of the highest radiation.
- b. The EUT was set 3 meters away from the interference-receiving antenna, which was mounted on the top of a variable-height antenna tower.
- c. The height of antenna is varied from one meter to four meters above the ground to determine the maximum value of the field strength. Both horizontal and vertical polarizations of the antenna are set to make the measurement.
- d. For each suspected emission, the EUT was arranged to its worst case and then the antenna was tuned to heights from 1 meter to 4 meters and the rotatable table was turned from 0 degrees to 360 degrees to find the maximum reading.
- e. The test-receiver system was set to quasi-peak detect function and specified bandwidth with maximum hold mode when the test frequency is below 1 GHz.
- f. The test-receiver system was set to peak and average detect function and specified bandwidth with maximum hold mode when the test frequency is above 1 GHz. If the peak reading value also meets average limit, measurement with the average detector is unnecessary.

#### Note:

1. For emission measurements above 1 GHz, the EUT shall be placed at a height of 1.5 m above the ground at 3 meter chamber room for test
2. The resolution bandwidth and video bandwidth of test receiver/spectrum analyzer is 120kHz for Quasi-peak detection (QP) at frequency below 1GHz.
3. The resolution bandwidth of test receiver/spectrum analyzer is 1 MHz and the video bandwidth is 3 MHz for Peak detection (PK) at frequency above 1GHz.
4. The resolution bandwidth of test receiver/spectrum analyzer is 1MHz and the video bandwidth is 3MHz for RMS Average (Duty cycle < 98%) for Average detection (AV) at frequency above 1GHz, then the measurement results was added to a correction factor ( $10 \log(1/\text{duty cycle})$ ).
5. The resolution bandwidth of test receiver/spectrum analyzer is 1MHz and the video bandwidth is 10Hz (Duty cycle  $\geq 98\%$ ) for Average detection (AV) at frequency above 1GHz.
6. All modes of operation were investigated and the worst-case emissions are reported.

#### 4.1.4 Deviation from Test Standard

No deviation.

#### 4.1.5 Test Setup

##### <Frequency Range below 1GHz>

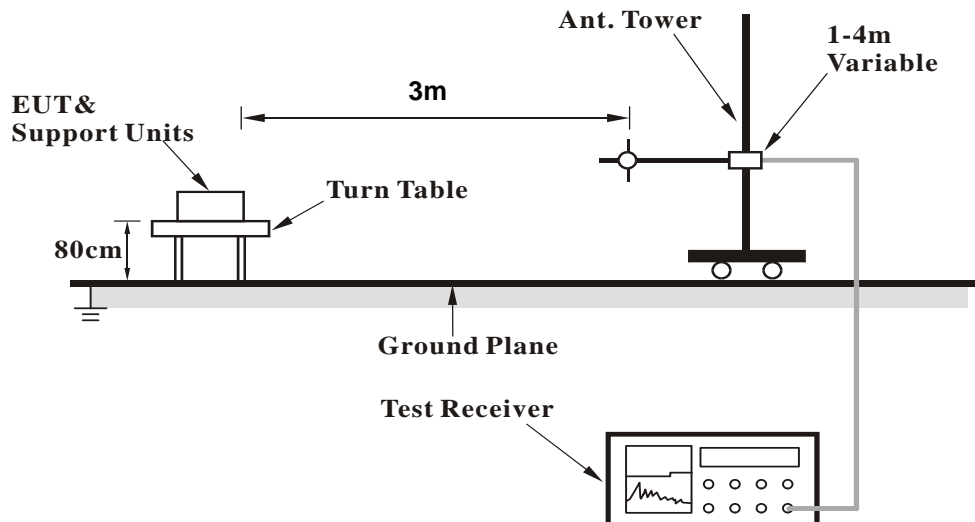

##### <Frequency Range above 1GHz>

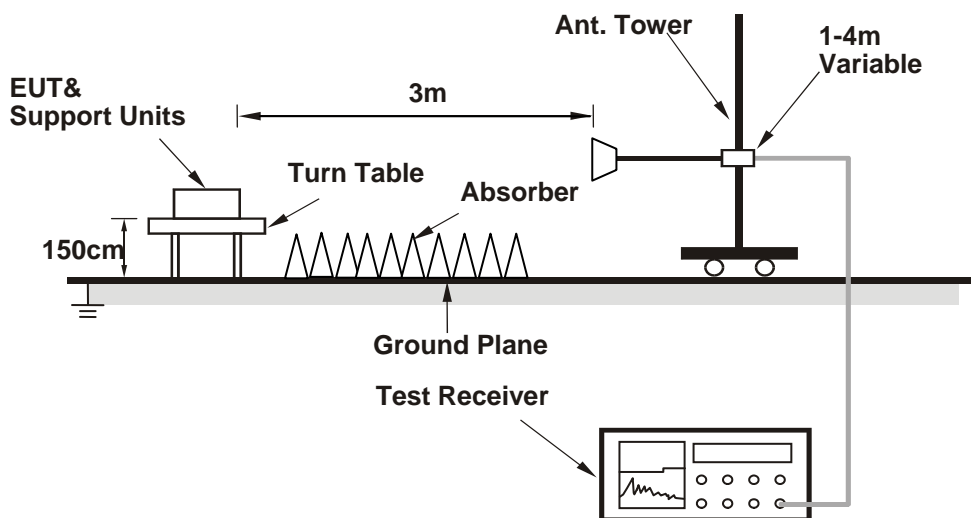

For the actual test configuration, please refer to the attached file (Test Setup Photo).

#### 4.1.6 EUT Operating Condition

1. Connect the EUT with the support unit C (NOTEBOOK COMPUTER) which is placed on remote site.
2. Controlling software (MTool\_2.0.1.0.msi) has been activated to set the EUT on specific status.

#### 4.1.7 Test Results

#### Above 1GHz Data:

#### 802.11a

<b>CHANNEL</b>	TX Channel 36	<b>DETECTOR FUNCTION</b>	Peak (PK)
<b>FREQUENCY RANGE</b>	1GHz ~ 40GHz		Average (AV)

#### ANTENNA POLARITY & TEST DISTANCE: HORIZONTAL AT 3 M

NO.	FREQ. (MHz)	EMISSION LEVEL (dBuV/m)	LIMIT (dBuV/m)	MARGIN (dB)	ANTENNA HEIGHT (m)	TABLE ANGLE (Degree)	RAW VALUE (dBuV)	CORRECTION FACTOR (dB/m)
1	5150.00	61.2 PK	74.0	-12.8	1.88 H	259	51.23	9.97
2	5150.00	48.5 AV	54.0	-5.5	1.88 H	259	38.53	9.97
3	*5180.00	109.8 PK			1.76 H	67	99.64	10.16
4	*5180.00	99.9 AV			1.76 H	67	89.74	10.16
5	#10360.00	59.4 PK	74.0	-14.6	2.31 H	183	42.42	16.98
6	#10360.00	51.3 AV	54.0	-2.7	2.31 H	183	34.32	16.98
7	15540.00	63.1 PK	74.0	-10.9	2.28 H	211	41.17	21.93
8	15540.00	49.8 AV	54.0	-4.2	2.28 H	211	27.87	21.93

#### ANTENNA POLARITY & TEST DISTANCE: VERTICAL AT 3 M

NO.	FREQ. (MHz)	EMISSION LEVEL (dBuV/m)	LIMIT (dBuV/m)	MARGIN (dB)	ANTENNA HEIGHT (m)	TABLE ANGLE (Degree)	RAW VALUE (dBuV)	CORRECTION FACTOR (dB/m)
1	5150.00	68.5 PK	74.0	-5.5	1.73 V	214	58.53	9.97
2	<b>5150.00</b>	<b>53.9 AV</b>	<b>54.0</b>	<b>-0.1</b>	<b>1.73 V</b>	<b>214</b>	<b>43.93</b>	<b>9.97</b>
3	*5180.00	111.8 PK			1.71 V	214	101.64	10.16
4	*5180.00	102.1 AV			1.71 V	214	91.94	10.16
5	#10360.00	67.5 PK	74.0	-6.5	1.87 V	323	50.52	16.98
6	#10360.00	49.4 AV	54.0	-4.6	1.87 V	323	32.42	16.98
7	15540.00	63.0 PK	74.0	-11.0	1.60 V	225	41.07	21.93
8	15540.00	49.2 AV	54.0	-4.8	1.60 V	225	27.27	21.93

#### REMARKS:

1. Emission Level(dBuV/m) = Raw Value(dBuV) + Correction Factor(dB/m)
2. Correction Factor(dB/m) = Antenna Factor(dB/m) + Cable Factor(dB) – Pre-Amplifier Factor(dB)
3. The other emission levels were very low against the limit.
4. Margin value = Emission Level – Limit value
5. " \* ": Fundamental frequency.
6. " # ": The radiated frequency is out of the restricted band.



<b>CHANNEL</b>	TX Channel 40	<b>DETECTOR FUNCTION</b>	Peak (PK)
<b>FREQUENCY RANGE</b>	1GHz ~ 40GHz		Average (AV)

**ANTENNA POLARITY & TEST DISTANCE: HORIZONTAL AT 3 M**

NO.	FREQ. (MHz)	EMISSION LEVEL (dBuV/m)	LIMIT (dBuV/m)	MARGIN (dB)	ANTENNA HEIGHT (m)	TABLE ANGLE (Degree)	RAW VALUE (dBuV)	CORRECTION FACTOR (dB/m)
1	5150.00	57.5 PK	74.0	-16.5	1.87 H	282	47.53	9.97
2	5150.00	46.5 AV	54.0	-7.5	1.87 H	282	36.53	9.97
3	*5200.00	109.7 PK			1.87 H	282	99.44	10.26
4	*5200.00	103.5 AV			1.87 H	282	93.24	10.26
5	5460.00	53.8 PK	74.0	-20.2	1.87 H	282	42.91	10.89
6	5460.00	42.2 AV	54.0	-11.8	1.87 H	282	31.31	10.89
7	#10400.00	60.6 PK	74.0	-13.4	2.36 H	185	43.54	17.06
8	#10400.00	53.1 AV	54.0	-0.9	2.36 H	185	36.04	17.06
9	15600.00	62.7 PK	74.0	-11.3	2.29 H	223	40.42	22.28
10	15600.00	49.2 AV	54.0	-4.8	2.29 H	223	26.92	22.28

**ANTENNA POLARITY & TEST DISTANCE: VERTICAL AT 3 M**

NO.	FREQ. (MHz)	EMISSION LEVEL (dBuV/m)	LIMIT (dBuV/m)	MARGIN (dB)	ANTENNA HEIGHT (m)	TABLE ANGLE (Degree)	RAW VALUE (dBuV)	CORRECTION FACTOR (dB/m)
1	5150.00	64.9 PK	74.0	-9.1	1.78 V	99	54.93	9.97
2	5150.00	51.0 AV	54.0	-3.0	1.78 V	99	41.03	9.97
3	*5200.00	119.7 PK			1.62 V	197	109.44	10.26
4	*5200.00	108.6 AV			1.62 V	197	98.34	10.26
5	5460.00	56.5 PK	74.0	-17.5	1.49 V	102	45.61	10.89
6	5460.00	43.9 AV	54.0	-10.1	1.49 V	102	33.01	10.89
7	#10400.00	68.7 PK	74.0	-5.3	1.88 V	300	51.64	17.06
8	#10400.00	50.2 AV	54.0	-3.8	1.88 V	300	33.14	17.06
9	15600.00	62.8 PK	74.0	-11.2	1.53 V	213	40.52	22.28
10	15600.00	49.6 AV	54.0	-4.4	1.53 V	213	27.32	22.28

**REMARKS:**

1. Emission Level(dBuV/m) = Raw Value(dBuV) + Correction Factor(dB/m)
2. Correction Factor(dB/m) = Antenna Factor(dB/m) + Cable Factor(dB) – Pre-Amplifier Factor(dB)
3. The other emission levels were very low against the limit.
4. Margin value = Emission Level – Limit value
5. " \* ": Fundamental frequency.
6. " # ": The radiated frequency is out of the restricted band.

<b>CHANNEL</b>	TX Channel 48	<b>DETECTOR FUNCTION</b>	Peak (PK)
<b>FREQUENCY RANGE</b>	1GHz ~ 40GHz		Average (AV)

**ANTENNA POLARITY & TEST DISTANCE: HORIZONTAL AT 3 M**

NO.	FREQ. (MHz)	EMISSION LEVEL (dBuV/m)	LIMIT (dBuV/m)	MARGIN (dB)	ANTENNA HEIGHT (m)	TABLE ANGLE (Degree)	RAW VALUE (dBuV)	CORRECTION FACTOR (dB/m)
1	5150.00	53.7 PK	74.0	-20.3	1.54 H	289	43.73	9.97
2	5150.00	43.5 AV	54.0	-10.5	1.54 H	289	33.53	9.97
3	*5240.00	108.9 PK			1.54 H	289	98.57	10.33
4	*5240.00	102.4 AV			1.54 H	289	92.07	10.33
5	5350.00	53.9 PK	74.0	-20.1	1.54 H	289	43.35	10.55
6	5350.00	41.7 AV	54.0	-12.3	1.54 H	289	31.15	10.55
7	#10480.00	68.8 PK	74.0	-5.2	1.72 H	63	52.07	16.73
8	#10480.00	53.8 AV	54.0	-0.2	1.72 H	63	37.07	16.73
9	15720.00	63.3 PK	74.0	-10.7	1.70 H	33	40.67	22.63
10	15720.00	49.8 AV	54.0	-4.2	1.70 H	33	27.17	22.63

**ANTENNA POLARITY & TEST DISTANCE: VERTICAL AT 3 M**

NO.	FREQ. (MHz)	EMISSION LEVEL (dBuV/m)	LIMIT (dBuV/m)	MARGIN (dB)	ANTENNA HEIGHT (m)	TABLE ANGLE (Degree)	RAW VALUE (dBuV)	CORRECTION FACTOR (dB/m)
1	5150.00	65.3 PK	74.0	-8.7	1.72 V	213	55.33	9.97
2	5150.00	46.5 AV	54.0	-7.5	1.72 V	213	36.53	9.97
3	*5240.00	115.5 PK			1.81 V	210	105.17	10.33
4	*5240.00	105.4 AV			1.81 V	210	95.07	10.33
5	5350.00	61.6 PK	74.0	-12.4	1.55 V	209	51.05	10.55
6	5350.00	45.5 AV	54.0	-8.5	1.55 V	209	34.95	10.55
7	#10480.00	66.3 PK	74.0	-7.7	1.89 V	211	49.57	16.73
8	#10480.00	49.6 AV	54.0	-4.4	1.89 V	211	32.87	16.73
9	15720.00	68.9 PK	74.0	-5.1	1.87 V	310	46.27	22.63
10	15720.00	50.3 AV	54.0	-3.7	1.87 V	310	27.67	22.63

**REMARKS:**

- Emission Level(dBuV/m) = Raw Value(dBuV) + Correction Factor(dB/m)
- Correction Factor(dB/m) = Antenna Factor(dB/m) + Cable Factor(dB) – Pre-Amplifier Factor(dB)
- The other emission levels were very low against the limit.
- Margin value = Emission Level – Limit value
- " \* ": Fundamental frequency.
- " # ": The radiated frequency is out of the restricted band.



<b>CHANNEL</b>	TX Channel 149	<b>DETECTOR FUNCTION</b>	Peak (PK)
<b>FREQUENCY RANGE</b>	1GHz ~ 40GHz		Average (AV)

**ANTENNA POLARITY & TEST DISTANCE: HORIZONTAL AT 3 M**

NO.	FREQ. (MHz)	EMISSION LEVEL (dBuV/m)	LIMIT (dBuV/m)	MARGIN (dB)	ANTENNA HEIGHT (m)	TABLE ANGLE (Degree)	RAW VALUE (dBuV)	CORRECTION FACTOR (dB/m)
1	#5715.00	63.1 PK	74.0	-10.9	1.89 H	279	51.57	11.53
2	#5715.00	51.5 AV	54.0	-2.5	1.89 H	279	39.97	11.53
3	#5725.00	72.5 PK	78.2	-5.7	1.89 H	279	60.95	11.55
4	*5745.00	106.5 PK			1.89 H	279	94.87	11.63
5	*5745.00	98.9 AV			1.89 H	279	87.27	11.63
6	11490.00	60.9 PK	74.0	-13.1	2.28 H	168	43.60	17.30
7	11490.00	48.2 AV	54.0	-5.8	2.28 H	168	30.90	17.30
8	#17235.00	62.8 PK	74.0	-11.2	2.23 H	211	35.99	26.81
9	#17235.00	49.1 AV	54.0	-4.9	2.23 H	211	22.29	26.81

**ANTENNA POLARITY & TEST DISTANCE: VERTICAL AT 3 M**

NO.	FREQ. (MHz)	EMISSION LEVEL (dBuV/m)	LIMIT (dBuV/m)	MARGIN (dB)	ANTENNA HEIGHT (m)	TABLE ANGLE (Degree)	RAW VALUE (dBuV)	CORRECTION FACTOR (dB/m)
1	#5715.00	71.7 PK	74.0	-2.3	1.61 V	212	60.17	11.53
2	#5715.00	52.6 AV	54.0	-1.4	1.61 V	212	41.07	11.53
3	#5725.00	<b>78.1 PK</b>	<b>78.2</b>	<b>-0.1</b>	<b>2.13 V</b>	<b>207</b>	<b>66.55</b>	<b>11.55</b>
4	*5745.00	113.2 PK			1.90 V	113	101.57	11.63
5	*5745.00	101.9 AV			1.90 V	113	90.27	11.63
6	11490.00	58.9 PK	74.0	-15.1	1.87 V	306	41.60	17.30
7	11490.00	47.3 AV	54.0	-6.7	1.87 V	306	30.00	17.30
8	#17235.00	63.3 PK	74.0	-10.7	1.59 V	220	36.49	26.81
9	#17235.00	49.6 AV	54.0	-4.4	1.59 V	220	22.79	26.81

**REMARKS:**

1. Emission Level(dBuV/m) = Raw Value(dBuV) + Correction Factor(dB/m)
2. Correction Factor(dB/m) = Antenna Factor(dB/m) + Cable Factor(dB) – Pre-Amplifier Factor(dB)
3. The other emission levels were very low against the limit.
4. Margin value = Emission Level – Limit value
5. " \* ": Fundamental frequency.
6. " # ": The radiated frequency is out of the restricted band.

<b>CHANNEL</b>	TX Channel 157	<b>DETECTOR FUNCTION</b>	Peak (PK)
<b>FREQUENCY RANGE</b>	1GHz ~ 40GHz		Average (AV)

**ANTENNA POLARITY & TEST DISTANCE: HORIZONTAL AT 3 M**

NO.	FREQ. (MHz)	EMISSION LEVEL (dBuV/m)	LIMIT (dBuV/m)	MARGIN (dB)	ANTENNA HEIGHT (m)	TABLE ANGLE (Degree)	RAW VALUE (dBuV)	CORRECTION FACTOR (dB/m)
1	#5715.00	66.4 PK	74.0	-7.6	1.94 H	269	54.87	11.53
2	#5715.00	52.4 AV	54.0	-1.6	1.94 H	269	40.87	11.53
3	#5725.00	71.5 PK	78.2	-6.7	1.94 H	269	59.95	11.55
4	*5785.00	114.5 PK			1.94 H	269	102.76	11.74
5	*5785.00	107.4 AV			1.94 H	269	95.66	11.74
6	#5850.00	63.8 PK	78.2	-14.4	1.94 H	269	52.05	11.75
7	#5860.00	59.5 PK	74.0	-14.5	1.94 H	269	47.75	11.75
8	#5860.00	48.7 AV	54.0	-5.3	1.94 H	269	36.95	11.75
9	11570.00	61.2 PK	74.0	-12.8	2.23 H	151	43.29	17.91
10	11570.00	51.2 AV	54.0	-2.8	2.23 H	151	33.29	17.91
11	#17355.00	63.1 PK	74.0	-10.9	2.25 H	122	35.96	27.14
12	#17355.00	49.8 AV	54.0	-4.2	2.25 H	122	22.66	27.14

**ANTENNA POLARITY & TEST DISTANCE: VERTICAL AT 3 M**

NO.	FREQ. (MHz)	EMISSION LEVEL (dBuV/m)	LIMIT (dBuV/m)	MARGIN (dB)	ANTENNA HEIGHT (m)	TABLE ANGLE (Degree)	RAW VALUE (dBuV)	CORRECTION FACTOR (dB/m)
1	#5715.00	68.1 PK	74.0	-5.9	1.68 V	203	56.57	11.53
2	#5715.00	53.1 AV	54.0	-0.9	1.68 V	203	41.57	11.53
3	#5725.00	77.1 PK	78.2	-1.1	1.70 V	202	65.55	11.55
4	*5785.00	120.1 PK			1.90 V	109	108.36	11.74
5	*5785.00	109.8 AV			1.90 V	109	98.06	11.74
6	#5850.00	67.5 PK	78.2	-10.7	1.78 V	208	55.75	11.75
7	#5860.00	61.0 PK	74.0	-13.0	1.90 V	223	49.25	11.75
8	#5860.00	50.4 AV	54.0	-3.6	1.90 V	223	38.65	11.75
9	11570.00	59.2 PK	74.0	-14.8	1.80 V	148	41.29	17.91
10	11570.00	48.1 AV	54.0	-5.9	1.80 V	148	30.19	17.91
11	#17355.00	63.2 PK	74.0	-10.8	1.88 V	144	36.06	27.14
12	#17355.00	50.0 AV	54.0	-4.0	1.88 V	144	22.86	27.14

**REMARKS:**

1. Emission Level(dBuV/m) = Raw Value(dBuV) + Correction Factor(dB/m)
2. Correction Factor(dB/m) = Antenna Factor(dB/m) + Cable Factor(dB) – Pre-Amplifier Factor(dB)
3. The other emission levels were very low against the limit.
4. Margin value = Emission Level – Limit value
5. " \* ": Fundamental frequency.
6. " # ": The radiated frequency is out of the restricted band.

<b>CHANNEL</b>	TX Channel 165	<b>DETECTOR FUNCTION</b>	Peak (PK)
<b>FREQUENCY RANGE</b>	1GHz ~ 40GHz		Average (AV)

**ANTENNA POLARITY & TEST DISTANCE: HORIZONTAL AT 3 M**

NO.	FREQ. (MHz)	EMISSION LEVEL (dBuV/m)	LIMIT (dBuV/m)	MARGIN (dB)	ANTENNA HEIGHT (m)	TABLE ANGLE (Degree)	RAW VALUE (dBuV)	CORRECTION FACTOR (dB/m)
1	*5825.00	111.1 PK			1.95 H	271	99.32	11.78
2	*5825.00	103.6 AV			1.95 H	271	91.82	11.78
3	#5850.00	74.5 PK	78.2	-3.7	1.95 H	271	62.75	11.75
4	#5860.00	68.3 PK	74.0	-5.7	1.95 H	271	56.55	11.75
5	#5860.00	50.8 AV	54.0	-3.2	1.95 H	271	39.05	11.75
6	11650.00	63.0 PK	74.0	-11.0	2.18 H	141	44.84	18.16
7	11650.00	49.7 AV	54.0	-4.3	2.18 H	141	31.54	18.16
8	#17475.00	65.4 PK	74.0	-8.6	2.20 H	111	37.48	27.92
9	#17475.00	50.9 AV	54.0	-3.1	2.20 H	111	22.98	27.92

**ANTENNA POLARITY & TEST DISTANCE: VERTICAL AT 3 M**

NO.	FREQ. (MHz)	EMISSION LEVEL (dBuV/m)	LIMIT (dBuV/m)	MARGIN (dB)	ANTENNA HEIGHT (m)	TABLE ANGLE (Degree)	RAW VALUE (dBuV)	CORRECTION FACTOR (dB/m)
1	*5825.00	114.1 PK			1.78 V	97	102.32	11.78
2	*5825.00	104.3 AV			1.78 V	97	92.52	11.78
<b>3</b>	<b>#5850.00</b>	<b>78.1 PK</b>	<b>78.2</b>	<b>-0.1</b>	<b>1.87 V</b>	<b>228</b>	<b>66.35</b>	<b>11.75</b>
4	#5860.00	70.4 PK	74.0	-3.6	1.78 V	90	58.65	11.75
5	#5860.00	53.6 AV	54.0	-0.4	1.78 V	90	41.85	11.75
6	11650.00	60.5 PK	74.0	-13.5	2.26 V	201	42.34	18.16
7	11650.00	47.0 AV	54.0	-7.0	2.26 V	201	28.84	18.16
8	#17475.00	63.0 PK	74.0	-11.0	2.03 V	311	35.08	27.92
9	#17475.00	49.8 AV	54.0	-4.2	2.03 V	311	21.88	27.92

**REMARKS:**

1. Emission Level(dBuV/m) = Raw Value(dBuV) + Correction Factor(dB/m)
2. Correction Factor(dB/m) = Antenna Factor(dB/m) + Cable Factor(dB) – Pre-Amplifier Factor(dB)
3. The other emission levels were very low against the limit.
4. Margin value = Emission Level – Limit value
5. " \* ": Fundamental frequency.
6. " # ": The radiated frequency is out of the restricted band.

**802.11n (HT20)**

<b>CHANNEL</b>	TX Channel 36	<b>DETECTOR FUNCTION</b>	Peak (PK)
<b>FREQUENCY RANGE</b>	1GHz ~ 40GHz		Average (AV)

<b>ANTENNA POLARITY &amp; TEST DISTANCE: HORIZONTAL AT 3 M</b>								
<b>NO.</b>	<b>FREQ. (MHz)</b>	<b>EMISSION LEVEL (dBuV/m)</b>	<b>LIMIT (dBuV/m)</b>	<b>MARGIN (dB)</b>	<b>ANTENNA HEIGHT (m)</b>	<b>TABLE ANGLE (Degree)</b>	<b>RAW VALUE (dBuV)</b>	<b>CORRECTION FACTOR (dB/m)</b>
1	5150.00	60.5 PK	74.0	-13.5	1.75 H	288	50.53	9.97
2	5150.00	52.5 AV	54.0	-1.5	1.75 H	288	42.53	9.97
3	*5180.00	106.5 PK			1.75 H	288	96.34	10.16
4	*5180.00	100.2 AV			1.75 H	288	90.04	10.16
5	#10360.00	59.8 PK	74.0	-14.2	2.21 H	142	42.82	16.98
6	#10360.00	51.0 AV	54.0	-3.0	2.21 H	142	34.02	16.98
7	15540.00	62.8 PK	74.0	-11.2	2.24 H	122	40.87	21.93
8	15540.00	49.2 AV	54.0	-4.8	2.24 H	122	27.27	21.93

<b>ANTENNA POLARITY &amp; TEST DISTANCE: VERTICAL AT 3 M</b>								
<b>NO.</b>	<b>FREQ. (MHz)</b>	<b>EMISSION LEVEL (dBuV/m)</b>	<b>LIMIT (dBuV/m)</b>	<b>MARGIN (dB)</b>	<b>ANTENNA HEIGHT (m)</b>	<b>TABLE ANGLE (Degree)</b>	<b>RAW VALUE (dBuV)</b>	<b>CORRECTION FACTOR (dB/m)</b>
1	5150.00	68.3 PK	74.0	-5.7	1.76 V	146	58.33	9.97
2	5150.00	53.7 AV	54.0	-0.3	1.76 V	146	43.73	9.97
3	*5180.00	113.7 PK			1.77 V	138	103.54	10.16
4	*5180.00	103.5 AV			1.77 V	138	93.34	10.16
5	#10360.00	58.8 PK	74.0	-15.2	2.26 V	202	41.82	16.98
6	#10360.00	49.6 AV	54.0	-4.4	2.26 V	202	32.62	16.98
7	15540.00	62.6 PK	74.0	-11.4	1.98 V	296	40.67	21.93
8	15540.00	49.4 AV	54.0	-4.6	1.98 V	296	27.47	21.93

**REMARKS:**

- Emission Level(dBuV/m) = Raw Value(dBuV) + Correction Factor(dB/m)
- Correction Factor(dB/m) = Antenna Factor(dB/m) + Cable Factor(dB) – Pre-Amplifier Factor(dB)
- The other emission levels were very low against the limit.
- Margin value = Emission Level – Limit value
- " \* ": Fundamental frequency.
- " # ": The radiated frequency is out of the restricted band.



<b>CHANNEL</b>	TX Channel 40	<b>DETECTOR FUNCTION</b>	Peak (PK)
<b>FREQUENCY RANGE</b>	1GHz ~ 40GHz		Average (AV)

**ANTENNA POLARITY & TEST DISTANCE: HORIZONTAL AT 3 M**

NO.	FREQ. (MHz)	EMISSION LEVEL (dBuV/m)	LIMIT (dBuV/m)	MARGIN (dB)	ANTENNA HEIGHT (m)	TABLE ANGLE (Degree)	RAW VALUE (dBuV)	CORRECTION FACTOR (dB/m)
1	5150.00	58.8 PK	74.0	-15.2	1.86 H	286	48.83	9.97
2	5150.00	48.1 AV	54.0	-5.9	1.86 H	286	38.13	9.97
3	*5200.00	109.1 PK			1.86 H	286	98.84	10.26
4	*5200.00	103.2 AV			1.86 H	286	92.94	10.26
5	#10400.00	60.4 PK	74.0	-13.6	2.26 H	145	43.34	17.06
6	#10400.00	53.0 AV	54.0	-1.0	2.26 H	145	35.94	17.06
7	15600.00	63.8 PK	74.0	-10.2	2.29 H	113	41.52	22.28
8	15600.00	50.0 AV	54.0	-4.0	2.29 H	113	27.72	22.28

**ANTENNA POLARITY & TEST DISTANCE: VERTICAL AT 3 M**

NO.	FREQ. (MHz)	EMISSION LEVEL (dBuV/m)	LIMIT (dBuV/m)	MARGIN (dB)	ANTENNA HEIGHT (m)	TABLE ANGLE (Degree)	RAW VALUE (dBuV)	CORRECTION FACTOR (dB/m)
1	5150.00	61.7 PK	74.0	-12.3	1.75 V	152	51.73	9.97
2	5150.00	50.8 AV	54.0	-3.2	1.75 V	152	40.83	9.97
3	*5200.00	115.3 PK			1.79 V	215	105.04	10.26
4	*5200.00	106.7 AV			1.79 V	215	96.44	10.26
5	#10400.00	60.2 PK	74.0	-13.8	2.23 V	193	43.14	17.06
6	#10400.00	50.3 AV	54.0	-3.7	2.23 V	193	33.24	17.06
7	15600.00	62.8 PK	74.0	-11.2	1.97 V	283	40.52	22.28
8	15600.00	49.2 AV	54.0	-4.8	1.97 V	283	26.92	22.28

**REMARKS:**

1. Emission Level(dBuV/m) = Raw Value(dBuV) + Correction Factor(dB/m)
2. Correction Factor(dB/m) = Antenna Factor(dB/m) + Cable Factor(dB) – Pre-Amplifier Factor(dB)
3. The other emission levels were very low against the limit.
4. Margin value = Emission Level – Limit value
5. " \* ": Fundamental frequency.
6. " # ": The radiated frequency is out of the restricted band.



<b>CHANNEL</b>	TX Channel 48	<b>DETECTOR FUNCTION</b>	Peak (PK)
<b>FREQUENCY RANGE</b>	1GHz ~ 40GHz		Average (AV)

**ANTENNA POLARITY & TEST DISTANCE: HORIZONTAL AT 3 M**

NO.	FREQ. (MHz)	EMISSION LEVEL (dBuV/m)	LIMIT (dBuV/m)	MARGIN (dB)	ANTENNA HEIGHT (m)	TABLE ANGLE (Degree)	RAW VALUE (dBuV)	CORRECTION FACTOR (dB/m)
1	5150.00	53.2 PK	74.0	-20.8	1.79 H	287	43.23	9.97
2	5150.00	42.3 AV	54.0	-11.7	1.79 H	287	32.33	9.97
3	*5240.00	107.8 PK			1.79 H	287	97.47	10.33
4	*5240.00	101.6 AV			1.79 H	287	91.27	10.33
5	5350.00	53.5 PK	74.0	-20.5	1.79 H	287	42.95	10.55
6	5350.00	41.9 AV	54.0	-12.1	1.79 H	287	31.35	10.55
7	#10480.00	68.7 PK	74.0	-5.3	1.85 H	62	51.97	16.73
<b>8</b>	<b>#10480.00</b>	<b>53.9 AV</b>	<b>54.0</b>	<b>-0.1</b>	<b>1.85 H</b>	<b>62</b>	<b>37.17</b>	<b>16.73</b>
9	15720.00	63.6 PK	74.0	-10.4	1.65 H	46	40.97	22.63
10	15720.00	50.2 AV	54.0	-3.8	1.65 H	46	27.57	22.63

**ANTENNA POLARITY & TEST DISTANCE: VERTICAL AT 3 M**

NO.	FREQ. (MHz)	EMISSION LEVEL (dBuV/m)	LIMIT (dBuV/m)	MARGIN (dB)	ANTENNA HEIGHT (m)	TABLE ANGLE (Degree)	RAW VALUE (dBuV)	CORRECTION FACTOR (dB/m)
1	5150.00	65.4 PK	74.0	-8.6	1.69 V	200	55.43	9.97
2	5150.00	46.6 AV	54.0	-7.4	1.69 V	200	36.63	9.97
3	*5240.00	114.5 PK			1.88 V	118	104.17	10.33
4	*5240.00	105.2 AV			1.88 V	118	94.87	10.33
5	5350.00	60.8 PK	74.0	-13.2	1.54 V	213	50.25	10.55
6	5350.00	45.0 AV	54.0	-9.0	1.54 V	213	34.45	10.55
7	#10480.00	59.7 PK	74.0	-14.3	2.26 V	186	42.97	16.73
8	#10480.00	49.9 AV	54.0	-4.1	2.26 V	186	33.17	16.73
9	15720.00	63.1 PK	74.0	-10.9	1.92 V	296	40.47	22.63
10	15720.00	49.4 AV	54.0	-4.6	1.92 V	296	26.77	22.63

**REMARKS:**

1. Emission Level(dBuV/m) = Raw Value(dBuV) + Correction Factor(dB/m)
2. Correction Factor(dB/m) = Antenna Factor(dB/m) + Cable Factor(dB) – Pre-Amplifier Factor(dB)
3. The other emission levels were very low against the limit.
4. Margin value = Emission Level – Limit value
5. " \* ": Fundamental frequency.
6. " # ": The radiated frequency is out of the restricted band.

<b>CHANNEL</b>	TX Channel 149	<b>DETECTOR FUNCTION</b>	Peak (PK)
<b>FREQUENCY RANGE</b>	1GHz ~ 40GHz		Average (AV)

**ANTENNA POLARITY & TEST DISTANCE: HORIZONTAL AT 3 M**

NO.	FREQ. (MHz)	EMISSION LEVEL (dBuV/m)	LIMIT (dBuV/m)	MARGIN (dB)	ANTENNA HEIGHT (m)	TABLE ANGLE (Degree)	RAW VALUE (dBuV)	CORRECTION FACTOR (dB/m)
1	#5715.00	60.5 PK	74.0	-13.5	1.97 H	273	48.97	11.53
2	#5715.00	52.5 AV	54.0	-1.5	1.97 H	273	40.97	11.53
3	#5725.00	77.6 PK	78.2	-0.6	1.97 H	273	66.05	11.55
4	*5745.00	107.5 PK			1.97 H	273	95.87	11.63
5	*5745.00	99.1 AV			1.97 H	273	87.47	11.63
6	11490.00	61.0 PK	74.0	-13.0	1.87 H	74	43.70	17.30
7	11490.00	48.5 AV	54.0	-5.5	1.87 H	74	31.20	17.30
8	#17235.00	62.7 PK	74.0	-11.3	1.61 H	35	35.89	26.81
9	#17235.00	49.2 AV	54.0	-4.8	1.61 H	35	22.39	26.81

**ANTENNA POLARITY & TEST DISTANCE: VERTICAL AT 3 M**

NO.	FREQ. (MHz)	EMISSION LEVEL (dBuV/m)	LIMIT (dBuV/m)	MARGIN (dB)	ANTENNA HEIGHT (m)	TABLE ANGLE (Degree)	RAW VALUE (dBuV)	CORRECTION FACTOR (dB/m)
1	#5715.00	61.9 PK	74.0	-12.1	1.76 V	213	50.37	11.53
2	#5715.00	53.3 AV	54.0	-0.7	1.76 V	213	41.77	11.53
3	#5725.00	77.9 PK	78.2	-0.3	1.50 V	206	66.35	11.55
4	*5745.00	110.0 PK			1.61 V	212	98.37	11.63
5	*5745.00	101.6 AV			1.61 V	212	89.97	11.63
6	11490.00	59.6 PK	74.0	-14.4	2.26 V	180	42.30	17.30
7	11490.00	47.8 AV	54.0	-6.2	2.26 V	180	30.50	17.30
8	#17235.00	63.0 PK	74.0	-11.0	1.86 V	294	36.19	26.81
9	#17235.00	49.4 AV	54.0	-4.6	1.86 V	294	22.59	26.81

**REMARKS:**

1. Emission Level(dBuV/m) = Raw Value(dBuV) + Correction Factor(dB/m)
2. Correction Factor(dB/m) = Antenna Factor(dB/m) + Cable Factor(dB) – Pre-Amplifier Factor(dB)
3. The other emission levels were very low against the limit.
4. Margin value = Emission Level – Limit value
5. " \* ": Fundamental frequency.
6. " # ": The radiated frequency is out of the restricted band.

<b>CHANNEL</b>	TX Channel 157	<b>DETECTOR FUNCTION</b>	Peak (PK)
<b>FREQUENCY RANGE</b>	1GHz ~ 40GHz		Average (AV)

**ANTENNA POLARITY & TEST DISTANCE: HORIZONTAL AT 3 M**

NO.	FREQ. (MHz)	EMISSION LEVEL (dBuV/m)	LIMIT (dBuV/m)	MARGIN (dB)	ANTENNA HEIGHT (m)	TABLE ANGLE (Degree)	RAW VALUE (dBuV)	CORRECTION FACTOR (dB/m)
1	#5715.00	66.8 PK	74.0	-7.2	1.86 H	268	55.27	11.53
2	#5715.00	52.2 AV	54.0	-1.8	1.86 H	268	40.67	11.53
3	#5725.00	69.2 PK	78.2	-9.0	1.86 H	268	57.65	11.55
4	*5785.00	113.4 PK			1.86 H	268	101.66	11.74
5	*5785.00	106.8 AV			1.86 H	268	95.06	11.74
6	#5850.00	62.8 PK	78.2	-15.4	1.86 H	268	51.05	11.75
7	#5860.00	57.6 PK	74.0	-16.4	1.86 H	268	45.85	11.75
8	#5860.00	48.6 AV	54.0	-5.4	1.86 H	268	36.85	11.75
9	11570.00	61.5 PK	74.0	-12.5	2.23 H	138	43.59	17.91
10	11570.00	51.4 AV	54.0	-2.6	2.23 H	138	33.49	17.91
11	#17355.00	62.5 PK	74.0	-11.5	2.24 H	127	35.36	27.14
12	#17355.00	49.1 AV	54.0	-4.9	2.24 H	127	21.96	27.14

**ANTENNA POLARITY & TEST DISTANCE: VERTICAL AT 3 M**

NO.	FREQ. (MHz)	EMISSION LEVEL (dBuV/m)	LIMIT (dBuV/m)	MARGIN (dB)	ANTENNA HEIGHT (m)	TABLE ANGLE (Degree)	RAW VALUE (dBuV)	CORRECTION FACTOR (dB/m)
1	#5715.00	67.9 PK	74.0	-6.1	1.72 V	190	56.37	11.53
2	#5715.00	52.9 AV	54.0	-1.1	1.72 V	190	41.37	11.53
3	#5725.00	76.4 PK	78.2	-1.8	1.75 V	212	64.85	11.55
4	*5785.00	116.9 PK			1.55 V	210	105.16	11.74
5	*5785.00	109.1 AV			1.55 V	210	97.36	11.74
6	#5850.00	66.9 PK	78.2	-11.3	1.83 V	213	55.15	11.75
7	#5860.00	60.8 PK	74.0	-13.2	1.89 V	220	49.05	11.75
8	#5860.00	50.4 AV	54.0	-3.6	1.89 V	220	38.65	11.75
9	11570.00	58.5 PK	74.0	-15.5	1.74 V	163	40.59	17.91
10	11570.00	47.6 AV	54.0	-6.4	1.74 V	163	29.69	17.91
11	#17355.00	62.9 PK	74.0	-11.1	1.86 V	147	35.76	27.14
12	#17355.00	49.6 AV	54.0	-4.4	1.86 V	147	22.46	27.14

**REMARKS:**

1. Emission Level(dBuV/m) = Raw Value(dBuV) + Correction Factor(dB/m)
2. Correction Factor(dB/m) = Antenna Factor(dB/m) + Cable Factor(dB) – Pre-Amplifier Factor(dB)
3. The other emission levels were very low against the limit.
4. Margin value = Emission Level – Limit value
5. " \* ": Fundamental frequency.
6. " # ": The radiated frequency is out of the restricted band.



<b>CHANNEL</b>	TX Channel 165	<b>DETECTOR FUNCTION</b>	Peak (PK)
<b>FREQUENCY RANGE</b>	1GHz ~ 40GHz		Average (AV)

**ANTENNA POLARITY & TEST DISTANCE: HORIZONTAL AT 3 M**

NO.	FREQ. (MHz)	EMISSION LEVEL (dBuV/m)	LIMIT (dBuV/m)	MARGIN (dB)	ANTENNA HEIGHT (m)	TABLE ANGLE (Degree)	RAW VALUE (dBuV)	CORRECTION FACTOR (dB/m)
1	*5825.00	110.9 PK			1.50 H	276	99.12	11.78
2	*5825.00	103.5 AV			1.50 H	276	91.72	11.78
3	#5850.00	77.4 PK	78.2	-0.8	1.50 H	273	65.65	11.75
4	#5860.00	70.2 PK	74.0	-3.8	1.50 H	273	58.45	11.75
5	#5860.00	53.4 AV	54.0	-0.6	1.50 H	273	41.65	11.75
6	11650.00	56.0 PK	74.0	-18.0	1.57 H	62	37.84	18.16
7	11650.00	48.5 AV	54.0	-5.5	1.57 H	62	30.34	18.16
8	#17475.00	62.8 PK	74.0	-11.2	1.76 H	309	34.88	27.92
9	#17475.00	49.1 AV	54.0	-4.9	1.76 H	309	21.18	27.92

**ANTENNA POLARITY & TEST DISTANCE: VERTICAL AT 3 M**

NO.	FREQ. (MHz)	EMISSION LEVEL (dBuV/m)	LIMIT (dBuV/m)	MARGIN (dB)	ANTENNA HEIGHT (m)	TABLE ANGLE (Degree)	RAW VALUE (dBuV)	CORRECTION FACTOR (dB/m)
1	*5825.00	113.3 PK			1.54 V	213	101.52	11.78
2	*5825.00	104.5 AV			1.54 V	213	92.72	11.78
3	#5850.00	74.7 PK	78.2	-3.5	1.89 V	111	62.95	11.75
4	#5860.00	67.6 PK	74.0	-6.4	1.76 V	106	55.85	11.75
5	#5860.00	52.8 AV	54.0	-1.2	1.76 V	106	41.05	11.75
6	11650.00	57.8 PK	74.0	-16.2	1.74 V	172	39.64	18.16
7	11650.00	47.1 AV	54.0	-6.9	1.74 V	172	28.94	18.16
8	#17475.00	62.9 PK	74.0	-11.1	1.91 V	143	34.98	27.92
9	#17475.00	49.5 AV	54.0	-4.5	1.91 V	143	21.58	27.92

**REMARKS:**

1. Emission Level(dBuV/m) = Raw Value(dBuV) + Correction Factor(dB/m)
2. Correction Factor(dB/m) = Antenna Factor(dB/m) + Cable Factor(dB) – Pre-Amplifier Factor(dB)
3. The other emission levels were very low against the limit.
4. Margin value = Emission Level – Limit value
5. " \* ": Fundamental frequency.
6. " # ": The radiated frequency is out of the restricted band.

**802.11n (HT40)**

<b>CHANNEL</b>	TX Channel 38	<b>DETECTOR FUNCTION</b>	Peak (PK)
<b>FREQUENCY RANGE</b>	1GHz ~ 40GHz		Average (AV)

ANTENNA POLARITY & TEST DISTANCE: HORIZONTAL AT 3 M								
NO.	FREQ. (MHz)	EMISSION LEVEL (dBuV/m)	LIMIT (dBuV/m)	MARGIN (dB)	ANTENNA HEIGHT (m)	TABLE ANGLE (Degree)	RAW VALUE (dBuV)	CORRECTION FACTOR (dB/m)
1	5150.00	59.5 PK	74.0	-14.5	1.77 H	292	49.53	9.97
2	5150.00	49.2 AV	54.0	-4.8	1.77 H	292	39.23	9.97
3	*5190.00	100.4 PK			1.77 H	292	90.20	10.20
4	*5190.00	93.5 AV			1.77 H	292	83.30	10.20
5	#10380.00	55.1 PK	74.0	-18.9	1.16 H	62	38.08	17.02
6	#10380.00	46.8 AV	54.0	-7.2	1.16 H	62	29.78	17.02
7	15570.00	63.5 PK	74.0	-10.5	1.77 H	322	41.40	22.10
8	15570.00	49.8 AV	54.0	-4.2	1.77 H	322	27.70	22.10

ANTENNA POLARITY & TEST DISTANCE: VERTICAL AT 3 M								
NO.	FREQ. (MHz)	EMISSION LEVEL (dBuV/m)	LIMIT (dBuV/m)	MARGIN (dB)	ANTENNA HEIGHT (m)	TABLE ANGLE (Degree)	RAW VALUE (dBuV)	CORRECTION FACTOR (dB/m)
1	5150.00	70.4 PK	74.0	-3.6	1.66 V	181	60.43	9.97
2	<b>5150.00</b>	<b>53.9 AV</b>	<b>54.0</b>	<b>-0.1</b>	<b>1.66 V</b>	<b>181</b>	<b>43.93</b>	<b>9.97</b>
3	*5190.00	105.3 PK			1.77 V	219	95.10	10.20
4	*5190.00	96.3 AV			1.77 V	219	86.10	10.20
5	#10380.00	58.6 PK	74.0	-15.4	1.78 V	154	41.58	17.02
6	#10380.00	45.1 AV	54.0	-8.9	1.78 V	154	28.08	17.02
7	15570.00	63.1 PK	74.0	-10.9	1.89 V	161	41.00	22.10
8	15570.00	49.6 AV	54.0	-4.4	1.89 V	161	27.50	22.10

**REMARKS:**

- Emission Level(dBuV/m) = Raw Value(dBuV) + Correction Factor(dB/m)
- Correction Factor(dB/m) = Antenna Factor(dB/m) + Cable Factor(dB) – Pre-Amplifier Factor(dB)
- The other emission levels were very low against the limit.
- Margin value = Emission Level – Limit value
- " \* ": Fundamental frequency.
- " # ": The radiated frequency is out of the restricted band.

<b>CHANNEL</b>	TX Channel 46	<b>DETECTOR FUNCTION</b>	Peak (PK)
<b>FREQUENCY RANGE</b>	1GHz ~ 40GHz		Average (AV)

**ANTENNA POLARITY & TEST DISTANCE: HORIZONTAL AT 3 M**

NO.	FREQ. (MHz)	EMISSION LEVEL (dBuV/m)	LIMIT (dBuV/m)	MARGIN (dB)	ANTENNA HEIGHT (m)	TABLE ANGLE (Degree)	RAW VALUE (dBuV)	CORRECTION FACTOR (dB/m)
1	5150.00	59.8 PK	74.0	-14.2	1.76 H	292	49.83	9.97
2	5150.00	47.5 AV	54.0	-6.5	1.76 H	292	37.53	9.97
3	*5230.00	106.7 PK			1.76 H	292	96.38	10.32
4	*5230.00	100.2 AV			1.76 H	292	89.88	10.32
5	5350.00	55.3 PK	74.0	-18.7	1.76 H	292	44.75	10.55
6	5350.00	44.8 AV	54.0	-9.2	1.76 H	292	34.25	10.55
7	#10460.00	55.5 PK	74.0	-18.5	1.22 H	56	38.68	16.82
8	#10460.00	47.3 AV	54.0	-6.7	1.22 H	56	30.48	16.82
9	15690.00	63.5 PK	74.0	-10.5	1.72 H	331	40.98	22.52
10	15690.00	49.8 AV	54.0	-4.2	1.72 H	331	27.28	22.52

**ANTENNA POLARITY & TEST DISTANCE: VERTICAL AT 3 M**

NO.	FREQ. (MHz)	EMISSION LEVEL (dBuV/m)	LIMIT (dBuV/m)	MARGIN (dB)	ANTENNA HEIGHT (m)	TABLE ANGLE (Degree)	RAW VALUE (dBuV)	CORRECTION FACTOR (dB/m)
1	5150.00	69.8 PK	74.0	-4.2	1.68 V	222	59.83	9.97
2	5150.00	52.9 AV	54.0	-1.1	1.68 V	222	42.93	9.97
3	*5230.00	112.1 PK			1.79 V	200	101.78	10.32
4	*5230.00	103.2 AV			1.79 V	200	92.88	10.32
5	5350.00	62.4 PK	74.0	-11.6	1.54 V	213	51.85	10.55
6	5350.00	48.7 AV	54.0	-5.3	1.54 V	213	38.15	10.55
7	#10460.00	53.4 PK	74.0	-20.6	1.72 V	205	36.58	16.82
8	#10460.00	46.2 AV	54.0	-7.8	1.72 V	205	29.38	16.82
9	15690.00	62.8 PK	74.0	-11.2	1.56 V	221	40.28	22.52
10	15690.00	49.3 AV	54.0	-4.7	1.56 V	221	26.78	22.52

**REMARKS:**

1. Emission Level(dBuV/m) = Raw Value(dBuV) + Correction Factor(dB/m)
2. Correction Factor(dB/m) = Antenna Factor(dB/m) + Cable Factor(dB) – Pre-Amplifier Factor(dB)
3. The other emission levels were very low against the limit.
4. Margin value = Emission Level – Limit value
5. " \* ": Fundamental frequency.
6. " # ": The radiated frequency is out of the restricted band.

<b>CHANNEL</b>	TX Channel 151	<b>DETECTOR FUNCTION</b>	Peak (PK)
<b>FREQUENCY RANGE</b>	1GHz ~ 40GHz		Average (AV)

**ANTENNA POLARITY & TEST DISTANCE: HORIZONTAL AT 3 M**

NO.	FREQ. (MHz)	EMISSION LEVEL (dBuV/m)	LIMIT (dBuV/m)	MARGIN (dB)	ANTENNA HEIGHT (m)	TABLE ANGLE (Degree)	RAW VALUE (dBuV)	CORRECTION FACTOR (dB/m)
1	#5715.00	69.5 PK	74.0	-4.5	1.83 H	276	57.97	11.53
2	#5715.00	53.2 AV	54.0	-0.8	1.83 H	276	41.67	11.53
3	#5725.00	72.9 PK	78.2	-5.3	1.83 H	276	61.35	11.55
4	*5755.00	101.8 PK			1.83 H	276	90.16	11.64
5	*5755.00	94.5 AV			1.83 H	276	82.86	11.64
6	11510.00	55.9 PK	74.0	-18.1	1.26 H	50	38.60	17.30
7	11510.00	47.3 AV	54.0	-6.7	1.26 H	50	30.00	17.30
8	#17265.00	60.4 PK	74.0	-13.6	1.74 H	341	33.69	26.71
9	#17265.00	49.9 AV	54.0	-4.1	1.74 H	341	23.19	26.71

**ANTENNA POLARITY & TEST DISTANCE: VERTICAL AT 3 M**

NO.	FREQ. (MHz)	EMISSION LEVEL (dBuV/m)	LIMIT (dBuV/m)	MARGIN (dB)	ANTENNA HEIGHT (m)	TABLE ANGLE (Degree)	RAW VALUE (dBuV)	CORRECTION FACTOR (dB/m)
1	#5715.00	70.0 PK	74.0	-4.0	1.58 V	214	58.47	11.53
2	#5715.00	53.9 AV	54.0	-0.1	1.58 V	214	42.37	11.53
3	#5725.00	75.3 PK	78.2	-2.9	1.56 V	215	63.75	11.55
4	*5755.00	106.3 PK			1.73 V	213	94.66	11.64
5	*5755.00	96.5 AV			1.73 V	213	84.86	11.64
6	11510.00	55.8 PK	74.0	-18.2	1.76 V	210	38.50	17.30
7	11510.00	46.5 AV	54.0	-7.5	1.76 V	210	29.20	17.30
8	#17265.00	63.2 PK	74.0	-10.8	1.59 V	219	36.49	26.71
9	#17265.00	49.8 AV	54.0	-4.2	1.59 V	219	23.09	26.71

**REMARKS:**

1. Emission Level(dBuV/m) = Raw Value(dBuV) + Correction Factor(dB/m)
2. Correction Factor(dB/m) = Antenna Factor(dB/m) + Cable Factor(dB) – Pre-Amplifier Factor(dB)
3. The other emission levels were very low against the limit.
4. Margin value = Emission Level – Limit value
5. " \* ": Fundamental frequency.
6. " # ": The radiated frequency is out of the restricted band.

<b>CHANNEL</b>	TX Channel 159	<b>DETECTOR FUNCTION</b>	Peak (PK)
<b>FREQUENCY RANGE</b>	1GHz ~ 40GHz		Average (AV)

**ANTENNA POLARITY & TEST DISTANCE: HORIZONTAL AT 3 M**

NO.	FREQ. (MHz)	EMISSION LEVEL (dBuV/m)	LIMIT (dBuV/m)	MARGIN (dB)	ANTENNA HEIGHT (m)	TABLE ANGLE (Degree)	RAW VALUE (dBuV)	CORRECTION FACTOR (dB/m)
1	#5715.00	64.9 PK	74.0	-9.1	1.85 H	268	53.37	11.53
2	#5715.00	51.8 AV	54.0	-2.2	1.85 H	268	40.27	11.53
3	#5725.00	74.6 PK	78.2	-3.6	1.85 H	268	63.05	11.55
4	*5795.00	109.4 PK			1.85 H	268	97.62	11.78
5	*5795.00	101.8 AV			1.85 H	268	90.02	11.78
6	#5850.00	74.2 PK	78.2	-4.0	1.85 H	268	62.45	11.75
7	#5860.00	70.1 PK	74.0	-3.9	1.85 H	268	58.35	11.75
8	#5860.00	53.3 AV	54.0	-0.7	1.85 H	268	41.55	11.75
9	11590.00	56.8 PK	74.0	-17.2	1.63 H	262	38.69	18.11
10	11590.00	49.1 AV	54.0	-4.9	1.63 H	262	30.99	18.11
11	#17385.00	68.1 PK	74.0	-5.9	1.54 H	142	40.65	27.45
12	#17385.00	49.7 AV	54.0	-4.3	1.54 H	142	22.25	27.45

**ANTENNA POLARITY & TEST DISTANCE: VERTICAL AT 3 M**

NO.	FREQ. (MHz)	EMISSION LEVEL (dBuV/m)	LIMIT (dBuV/m)	MARGIN (dB)	ANTENNA HEIGHT (m)	TABLE ANGLE (Degree)	RAW VALUE (dBuV)	CORRECTION FACTOR (dB/m)
1	#5715.00	65.3 PK	74.0	-8.7	1.75 V	214	53.77	11.53
2	#5715.00	52.1 AV	54.0	-1.9	1.75 V	214	40.57	11.53
3	#5725.00	75.9 PK	78.2	-2.3	1.74 V	201	64.35	11.55
4	*5795.00	110.9 PK			1.81 V	107	99.12	11.78
5	*5795.00	103.0 AV			1.81 V	107	91.22	11.78
6	#5850.00	74.6 PK	78.2	-3.6	1.72 V	223	62.85	11.75
7	#5860.00	70.2 PK	74.0	-3.8	1.79 V	229	58.45	11.75
8	#5860.00	53.6 AV	54.0	-0.4	1.79 V	229	41.85	11.75
9	11590.00	56.1 PK	74.0	-17.9	1.67 V	203	37.99	18.11
10	11590.00	48.5 AV	54.0	-5.5	1.67 V	203	30.39	18.11
11	#17385.00	62.9 PK	74.0	-11.1	1.60 V	213	35.45	27.45
12	#17385.00	49.6 AV	54.0	-4.4	1.60 V	213	22.15	27.45

**REMARKS:**

1. Emission Level(dBuV/m) = Raw Value(dBuV) + Correction Factor(dB/m)
2. Correction Factor(dB/m) = Antenna Factor(dB/m) + Cable Factor(dB) – Pre-Amplifier Factor(dB)
3. The other emission levels were very low against the limit.
4. Margin value = Emission Level – Limit value
5. " \* ": Fundamental frequency.
6. " # ": The radiated frequency is out of the restricted band.

**Below 1GHz Data:**
**802.11a**

<b>CHANNEL</b>	TX Channel 157	<b>DETECTOR FUNCTION</b>	Quasi-Peak (QP)
<b>FREQUENCY RANGE</b>	Below 1GHz		

**ANTENNA POLARITY & TEST DISTANCE: HORIZONTAL AT 3 M**

NO.	FREQ. (MHz)	EMISSION LEVEL (dBuV/m)	LIMIT (dBuV/m)	MARGIN (dB)	ANTENNA HEIGHT (m)	TABLE ANGLE (Degree)	RAW VALUE (dBuV)	CORRECTION FACTOR (dB/m)
1	59.21	32.1 QP	40.0	-7.9	1.50 H	35	45.77	-13.67
2	350.00	38.6 QP	46.0	-7.4	1.20 H	39	49.30	-10.70
3	474.98	34.3 QP	46.0	-11.7	1.60 H	89	42.01	-7.74
4	625.14	38.4 QP	46.0	-7.6	1.10 H	354	42.73	-4.31
5	775.01	39.1 QP	46.0	-6.9	1.70 H	137	40.72	-1.60
6	900.00	37.3 QP	46.0	-8.7	1.20 H	60	37.16	0.18

**ANTENNA POLARITY & TEST DISTANCE: VERTICAL AT 3 M**

NO.	FREQ. (MHz)	EMISSION LEVEL (dBuV/m)	LIMIT (dBuV/m)	MARGIN (dB)	ANTENNA HEIGHT (m)	TABLE ANGLE (Degree)	RAW VALUE (dBuV)	CORRECTION FACTOR (dB/m)
1	53.64	36.9 QP	40.0	-3.2	1.20 V	187	49.99	-13.14
2	102.49	34.8 QP	43.5	-8.7	1.40 V	256	51.89	-17.12
3	256.00	34.7 QP	46.0	-11.3	1.05 V	106	48.43	-13.77
4	375.07	34.1 QP	46.0	-11.9	1.03 V	124	44.34	-10.22
5	605.00	40.8 QP	46.0	-5.3	1.22 V	240	45.30	-4.55
6	835.02	39.4 QP	46.0	-6.6	1.50 V	222	40.19	-0.83

**REMARKS:**

1. Emission Level(dBuV/m) = Raw Value(dBuV) + Correction Factor(dB/m)
2. Correction Factor(dB/m) = Antenna Factor(dB/m) + Cable Factor(dB) – Pre-Amplifier Factor(dB)
3. The other emission levels were very low against the limit.
4. Margin value = Emission Level – Limit value

## 4.2 Conducted Emission Measurement

### 4.2.1 Limits of Conducted Emission Measurement

Frequency (MHz)	Conducted Limit (dBuV)	
	Quasi-peak	Average
0.15 - 0.5	66 - 56	56 - 46
0.50 - 5.0	56	46
5.0 - 30.0	60	50

Note: 1. The lower limit shall apply at the transition frequencies.

2. The limit decreases in line with the logarithm of the frequency in the range of 0.15 to 0.50MHz.

### 4.2.2 Test Instruments

DESCRIPTION & MANUFACTURER	MODEL NO.	SERIAL NO.	CALIBRATED DATE	CALIBRATED UNTIL
Test Receiver R&S	ESCS 30	100375	May 06, 2015	May 05, 2016
Line-Impedance Stabilization Network (for EUT) SCHWARZBECK	NSLK-8127	8127-522	Sep. 15, 2014	Sep. 14, 2015
Line-Impedance Stabilization Network (for Peripheral) R&S	ENV216	100072	June 11, 2015	June 10, 2016
RF Cable	5D-FB	COCCAB-001	Mar. 09, 2015	Mar. 08, 2016
50 ohms Terminator	N/A	EMC-03	Sep. 22, 2014	Sep. 21, 2015
50 ohms Terminator	N/A	EMC-02	Sep. 30, 2014	Sep. 29, 2015
Software BVADT	BVADT_Cond_ V7.3.7.3	NA	NA	NA

**Note:**

1. The calibration interval of the above test instruments are 12 months and the calibrations are traceable to NML/ROC and NIST/USA.
2. The test was performed in Shielded Room No. C.
3. The VCCI Con C Registration No. is C-3611.
4. Tested Date: July 09, 2015

#### 4.2.3 Test Procedure

- a. The EUT was placed 0.4 meters from the conducting wall of the shielded room with EUT being connected to the power mains through a line impedance stabilization network (LISN). Other support units were connected to the power mains through another LISN. The two LISNs provide 50 ohm/ 50uH of coupling impedance for the measuring instrument.
- b. Both lines of the power mains connected to the EUT were checked for maximum conducted interference.
- c. The frequency range from 150kHz to 30MHz was searched. Emission levels under (Limit - 20dB) was not recorded.

**NOTE:** All modes of operation were investigated and the worst-case emissions are reported.

#### 4.2.4 Deviation from Test Standard

No deviation.

#### 4.2.5 Test Setup

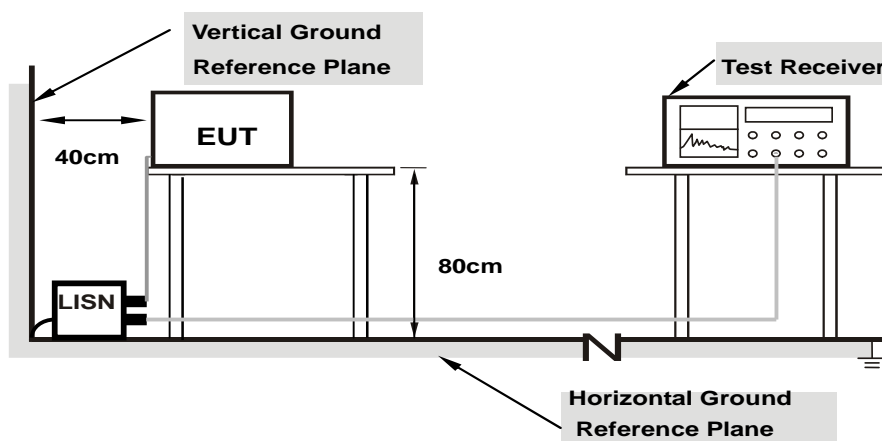

**Note:** 1.Support units were connected to second LISN.

For the actual test configuration, please refer to the attached file (Test Setup Photo).

#### 4.2.6 EUT Operating Condition

Same as 4.1.6.



#### 4.2.7 Test Results (Mode 1)

Phase	Line (L)	Detector Function	Quasi-Peak (QP) / Average (AV)
-------	----------	-------------------	--------------------------------

Phase Of Power : Line (L)										
No	Frequency (MHz)	Correction Factor (dB)	Reading Value (dBuV)		Emission Level (dBuV)		Limit (dBuV)		Margin (dB)	
			Q.P.	AV.	Q.P.	AV.	Q.P.	AV.	Q.P.	AV.
1	0.15000	0.14	48.84	35.18	48.98	35.32	66.00	56.00	-17.02	-20.68
2	0.16953	0.14	46.54	36.80	46.68	36.94	64.98	54.98	-18.30	-18.04
3	0.21250	0.15	39.78	31.44	39.93	31.59	63.11	53.11	-23.18	-21.52
4	0.44297	0.17	32.80	22.02	32.97	22.19	57.01	47.01	-24.03	-24.81
5	3.22266	0.33	34.56	27.72	34.89	28.05	56.00	46.00	-21.11	-17.95
<b>6</b>	<b>17.05859</b>	<b>1.00</b>	<b>40.04</b>	<b>34.58</b>	<b>41.04</b>	<b>35.58</b>	<b>60.00</b>	<b>50.00</b>	<b>-18.96</b>	<b>-14.42</b>

#### Remarks:

1. Q.P. and AV. are abbreviations of quasi-peak and average individually.
2. The emission levels of other frequencies were very low against the limit.
3. Margin value = Emission level – Limit value
4. Correction factor = Insertion loss + Cable loss
5. Emission Level = Correction Factor + Reading Value

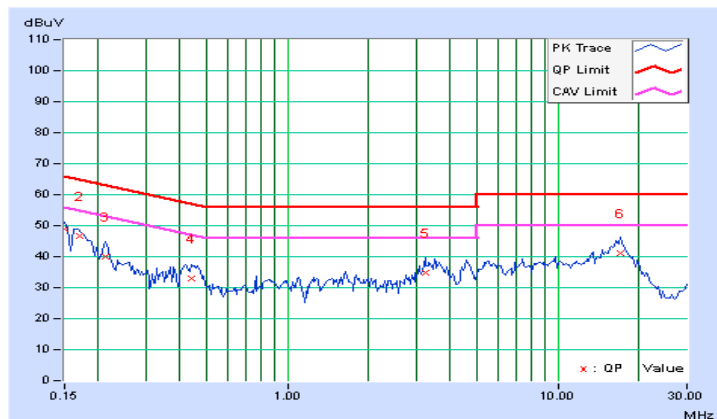

Phase	Neutral (N)	Detector Function	Quasi-Peak (QP) / Average (AV)
-------	-------------	-------------------	--------------------------------

Phase Of Power : Neutral (N)										
No	Frequency (MHz)	Correction Factor (dB)	Reading Value (dBuV)		Emission Level (dBuV)		Limit (dBuV)		Margin (dB)	
			Q.P.	AV.	Q.P.	AV.	Q.P.	AV.	Q.P.	AV.
1	0.15000	0.14	48.84	35.00	48.98	35.14	66.00	56.00	-17.02	-20.86
2	0.20563	0.15	40.02	27.88	40.17	28.03	63.38	53.38	-23.21	-25.35
3	0.41172	0.19	36.32	26.00	36.51	26.19	57.61	47.61	-21.10	-21.42
4	3.33984	0.38	33.04	26.20	33.42	26.58	56.00	46.00	-22.58	-19.42
5	5.30859	0.50	31.14	24.96	31.64	25.46	60.00	50.00	-28.36	-24.54
6	18.28516	1.15	29.06	23.36	30.21	24.51	60.00	50.00	-29.79	-25.49

**Remarks:**

1. Q.P. and AV. are abbreviations of quasi-peak and average individually.
2. The emission levels of other frequencies were very low against the limit.
3. Margin value = Emission level – Limit value
4. Correction factor = Insertion loss + Cable loss
5. Emission Level = Correction Factor + Reading Value

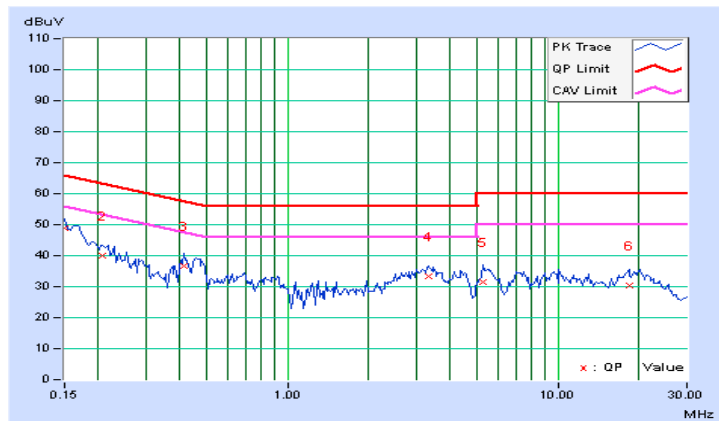

4.2.8 Test Results (Mode 2)

Phase	Line (L)	Detector Function	Quasi-Peak (QP) / Average (AV)
-------	----------	-------------------	--------------------------------

Phase Of Power : Line (L)										
No	Frequency (MHz)	Correction Factor (dB)	Reading Value (dBuV)		Emission Level (dBuV)		Limit (dBuV)		Margin (dB)	
			Q.P.	AV.	Q.P.	AV.	Q.P.	AV.	Q.P.	AV.
1	0.30234	0.16	35.78	22.76	35.94	22.92	60.18	50.18	-24.24	-27.26
2	0.40781	0.17	32.98	22.88	33.15	23.05	57.69	47.69	-24.54	-24.64
3	0.82188	0.19	31.92	22.40	32.11	22.59	56.00	46.00	-23.89	-23.41
4	1.43359	0.23	30.22	21.90	30.45	22.13	56.00	46.00	-25.55	-23.87
5	2.70703	0.30	27.60	21.18	27.90	21.48	56.00	46.00	-28.10	-24.52
6	11.12875	0.78	29.32	25.98	30.10	26.76	60.00	50.00	-29.90	-23.24

Remarks:

1. Q.P. and AV. are abbreviations of quasi-peak and average individually.
2. The emission levels of other frequencies were very low against the limit.
3. Margin value = Emission level – Limit value
4. Correction factor = Insertion loss + Cable loss
5. Emission Level = Correction Factor + Reading Value

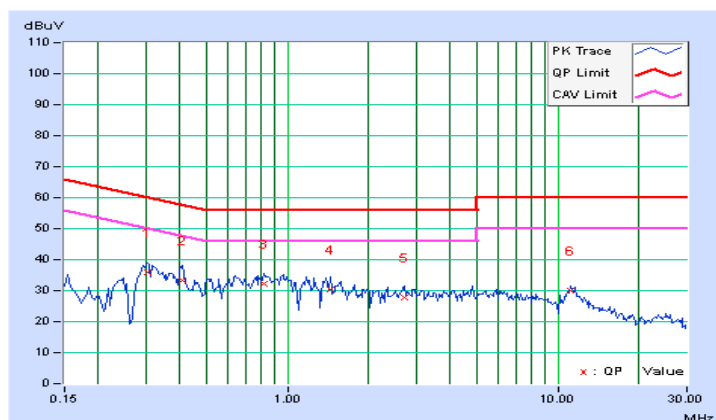

Phase	Neutral (N)	Detector Function	Quasi-Peak (QP) / Average (AV)
-------	-------------	-------------------	--------------------------------

Phase Of Power : Neutral (N)										
No	Frequency (MHz)	Correction Factor (dB)	Reading Value (dBuV)		Emission Level (dBuV)		Limit (dBuV)		Margin (dB)	
			Q.P.	AV.	Q.P.	AV.	Q.P.	AV.	Q.P.	AV.
1	0.30234	0.17	36.10	23.16	36.27	23.33	60.18	50.18	-23.91	-26.85
2	0.40000	0.19	33.10	20.06	33.29	20.25	57.85	47.85	-24.56	-27.60
3	0.64609	0.21	30.46	21.68	30.67	21.89	56.00	46.00	-25.33	-24.11
4	0.96641	0.24	29.98	20.48	30.22	20.72	56.00	46.00	-25.78	-25.28
5	1.40625	0.26	30.90	23.30	31.16	23.56	56.00	46.00	-24.84	-22.44
6	2.71875	0.34	26.20	19.36	26.54	19.70	56.00	46.00	-29.46	-26.30

**Remarks:**

1. Q.P. and AV. are abbreviations of quasi-peak and average individually.
2. The emission levels of other frequencies were very low against the limit.
3. Margin value = Emission level – Limit value
4. Correction factor = Insertion loss + Cable loss
5. Emission Level = Correction Factor + Reading Value

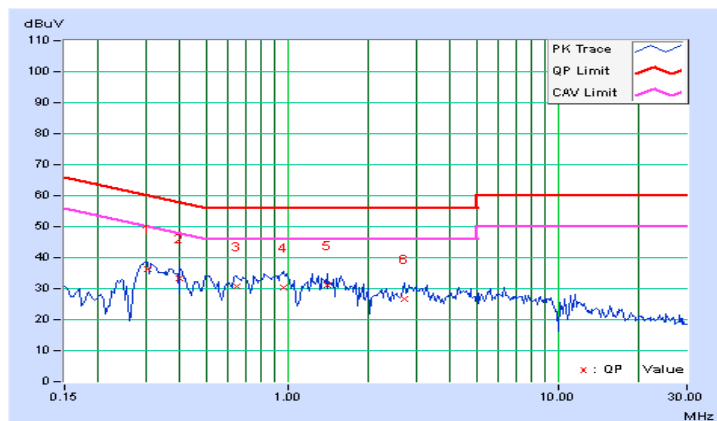

### 4.3 Transmit Power Measurement

#### 4.3.1 Limits of Transmit Power Measurement

Operation Band	EUT Category		LIMIT
U-NII-1		Outdoor Access Point	1 Watt (30 dBm) (Max. e.i.r.p $\leq$ 125mW(21 dBm) at any elevation angle above 30 degrees as measured from the horizon)
		Fixed point-to-point Access Point	1 Watt (30 dBm)
	√	Indoor Access Point	1 Watt (30 dBm)
		Mobile and Portable client device	250mW (24 dBm)
U-NII-2A			250mW (24 dBm) or 11 dBm+10 log B*
U-NII-2C			250mW (24 dBm) or 11 dBm+10 log B*
U-NII-3	√		1 Watt (30 dBm)

\*B is the 26 dB emission bandwidth in megahertz

Per KDB 662911 Method of conducted output power measurement on IEEE 802.11 devices,

Array Gain = 0 dB (i.e., no array gain) for  $N_{ANT} \leq 4$ ;

Array Gain = 0 dB (i.e., no array gain) for channel widths  $\geq 40$  MHz for any  $N_{ANT}$ ;

Array Gain =  $5 \log(N_{ANT}/N_{SS})$  dB or 3 dB, whichever is less for 20-MHz channel widths with  $N_{ANT} \geq 5$ .

For power measurements on all other devices: Array Gain =  $10 \log(N_{ANT}/N_{SS})$  dB.

#### 4.3.2 Test Setup

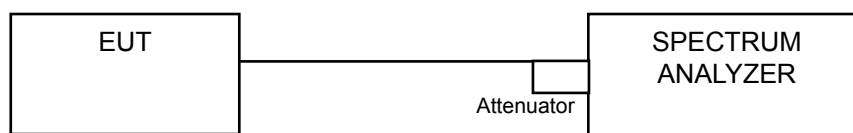

#### 4.3.3 Test Instruments

Refer to section 4.1.2 to get information of above instrument.

#### 4.3.4 Test Procedure

Method PM is used to perform output power measurement, trigger and gating function of wide band power meter is enabled to measure max output power of TX on burst. Duty factor is not added to measured value.

#### 4.3.5 Deviation from Test Standard

No deviation.

#### 4.3.6 EUT Operating Condition

The software provided by client to enable the EUT under transmission condition continuously at lowest, middle and highest channel frequencies individually.

**4.3.7 Test Result**
**POWER OUTPUT:**
**802.11a**

Chan.	Freq. (MHz)	Maximum Conducted Power (dBm)		Total Power (mW)	Total Power (dBm)	Power Limit (dBm)	Pass / Fail
		Chain 0	Chain 1				
36	5180	12.91	12.77	38.466	15.85	30	Pass
40	5200	17.20	17.53	109.105	20.38	30	Pass
48	5240	16.45	17.16	96.157	19.83	30	Pass
149	5745	12.67	11.60	32.947	15.18	30	Pass
157	5785	21.82	20.59	266.606	24.26	30	Pass
165	5825	14.83	13.82	54.508	17.36	30	Pass

**802.11n (HT20)**

Chan.	Freq. (MHz)	Maximum Conducted Power (dBm)		Total Power (mW)	Total Power (dBm)	Power Limit (dBm)	Pass / Fail
		Chain 0	Chain 1				
36	5180	13.32	13.57	44.229	16.46	30	Pass
40	5200	17.17	17.47	107.966	20.33	30	Pass
48	5240	15.77	16.51	82.528	19.17	30	Pass
149	5745	13.68	12.14	39.703	15.99	30	Pass
157	5785	21.42	20.56	252.439	24.02	30	Pass
165	5825	16.56	15.48	80.608	19.06	30	Pass

**802.11n (HT40)**

Chan.	Freq. (MHz)	Maximum Conducted Power (dBm)		Total Power (mW)	Total Power (dBm)	Power Limit (dBm)	Pass / Fail
		Chain 0	Chain 1				
38	5190	10.01	11.22	23.266	13.67	30	Pass
46	5230	17.27	17.97	115.994	20.64	30	Pass
151	5755	10.43	9.78	20.547	13.13	30	Pass
159	5795	16.20	16.20	83.374	19.21	30	Pass

#### 4.4 Peak Power Spectral Density Measurement

##### 4.4.1 Limits of Peak Power Spectral Density Measurement

Operation Band	EUT Category		LIMIT
U-NII-1		Outdoor Access Point	17dBm/ MHz
		Fixed point-to-point Access Point	
	√	Indoor Access Point	
		Mobile and Portable client device	11dBm/ MHz
U-NII-2A			11dBm/ MHz
U-NII-2C			11dBm/ MHz
U-NII-3		√	30dBm/ 500kHz

##### 4.4.2 Test Setup

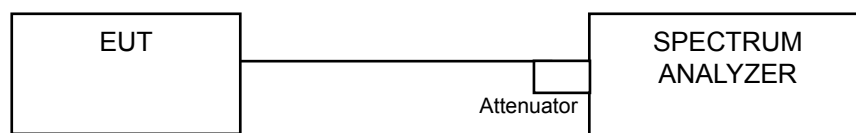

##### 4.4.3 Test Instruments

Refer to section 4.1.2 to get information of above instrument.

##### 4.4.4 Test Procedure

###### For U-NII-1, U-NII-2A, U-NII-2C band:

Using method SA-1

1. Set span to encompass the entire emission bandwidth (EBW) of the signal.
2. Set RBW = 1 MHz, Set VBW ≥ 3 MHz, Detector = RMS
3. Sweep time = auto, trigger set to “free run”.
4. Trace average at least 100 traces in power averaging mode.
5. Record the max value

###### For U-NII-3 band:

1. Set span to encompass the entire emission bandwidth (EBW) of the signal.
2. Set RBW = 300 kHz, Set VBW ≥ 1 MHz, Detector = RMS
3. Use the peak marker function to determine the maximum power level in any 300 kHz band segment within the fundamental EBW.
4. Scale the observed power level to an equivalent value in 500 kHz by adjusting (reducing) the measured power by a bandwidth correction factor (BWCF) where  $BWCF = 10\log(500\text{ kHz}/300\text{kHz})$
5. Sweep time = auto, trigger set to “free run”.
6. Trace average at least 100 traces in power averaging mode.
7. Record the max value

##### 4.4.5 Deviation from Test Standard

No deviation.

##### 4.4.6 EUT Operating Condition

Same as Item 4.3.6.

#### 4.4.7 Test Results

#### For U-NII-1 Band 802.11a

Chan.	Chan. Freq. (MHz)	PSD (dBm)		Total Power Density (dBm)	Max. Limit (dBm)	Pass / Fail
		Chain 0	Chain 1			
36	5180	3.22	2.61	5.94	14.89	Pass
40	5200	7.77	7.22	10.51	14.89	Pass
48	5240	6.65	7.18	9.93	14.89	Pass

- NOTE:**
- Method a) of power density measurement of KDB 662911 is using for calculating total power density. Total power density is summing entire spectra across corresponding frequency bins on the various outputs by computer.
  - Directional gain =  $10 \log[(10^{G1/20} + 10^{G2/20})^2 / 2] = 8.11\text{dBi} > 6\text{dBi}$ , so the power density limit shall be reduced to  $17-(8.11-6) = 14.89\text{dBm}$ .

#### 802.11n (HT20)

Chan.	Chan. Freq. (MHz)	PSD (dBm)		Total Power Density (dBm)	Max. Limit (dBm)	Pass / Fail
		Chain 0	Chain 1			
36	5180	3.49	3.29	6.40	14.89	Pass
40	5200	7.21	7.16	10.20	14.89	Pass
48	5240	5.51	6.38	8.98	14.89	Pass

- NOTE:**
- Method a) of power density measurement of KDB 662911 is using for calculating total power density. Total power density is summing entire spectra across corresponding frequency bins on the various outputs by computer.
  - Directional gain =  $10 \log[(10^{G1/20} + 10^{G2/20})^2 / 2] = 8.11\text{dBi} > 6\text{dBi}$ , so the power density limit shall be reduced to  $17-(8.11-6) = 14.89\text{dBm}$ .

#### 802.11n (HT40)

Chan.	Chan. Freq. (MHz)	PSD (dBm)		Total Power Density (dBm)	Max. Limit (dBm)	Pass / Fail
		Chain 0	Chain 1			
38	5190	-3.28	-1.92	0.46	14.89	Pass
46	5230	4.00	4.41	7.22	14.89	Pass

- NOTE:**
- Method a) of power density measurement of KDB 662911 is using for calculating total power density. Total power density is summing entire spectra across corresponding frequency bins on the various outputs by computer.
  - Directional gain =  $10 \log[(10^{G1/20} + 10^{G2/20})^2 / 2] = 8.11\text{dBi} > 6\text{dBi}$ , so the power density limit shall be reduced to  $17-(8.11-6) = 14.89\text{dBm}$ .

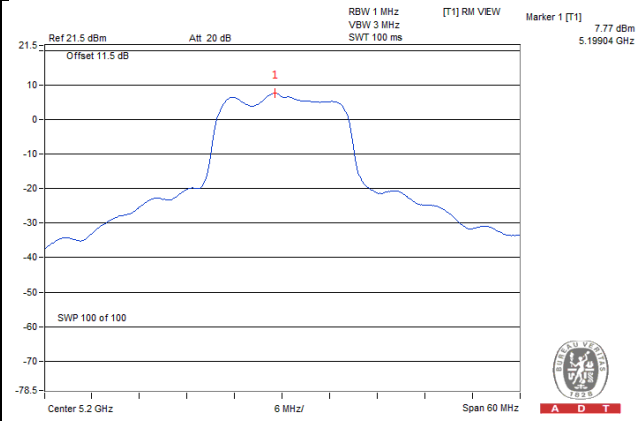
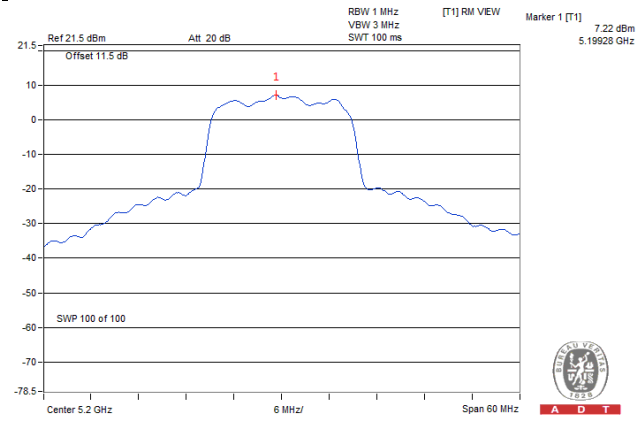
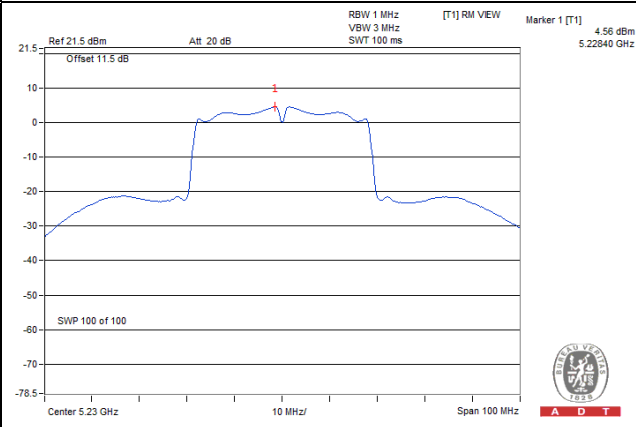

**Spectrum Plot of Worst Value****802.11a – Chain (0): CH 40****802.11n (HT20) – Chain (0): CH 40****802.11n (HT40) – Chain (1): CH 46**

## For U-NII-3 Band

### 802.11a

TX chain	Chan.	Chan. Freq. (MHz)	PSD		10 log (N=2) dB	Total PSD (dBm/500kHz)	Limit (dBm/500kHz)	Pass /Fail
			(dBm/300kHz)	(dBm/500kHz)				
0	149	5745	-0.37	1.85	3.01	4.86	27.89	Pass
	157	5785	6.15	8.37	3.01	11.38	27.89	Pass
	165	5825	0.39	2.61	3.01	5.62	27.89	Pass
1	149	5745	-3.34	-1.12	3.01	1.89	27.89	Pass
	157	5785	6.99	9.21	3.01	12.22	27.89	Pass
	165	5825	-1.07	1.15	3.01	4.16	27.89	Pass

**NOTE:** Directional gain =  $10 \log[(10^{G1/20} + 10^{G2/20})^2 / 2]$  = 8.11dBi > 6dBi , so the power density limit shall be reduced to  $30-(8.11-6) = 27.89$ dBm.

### 802.11n (HT20)

TX chain	Chan.	Chan. Freq. (MHz)	PSD		10 log (N=2) dB	Total PSD (dBm/500kHz)	Limit (dBm/500kHz)	Pass /Fail
			(dBm/300kHz)	(dBm/500kHz)				
0	149	5745	-1.09	1.13	3.01	4.14	27.89	Pass
	157	5785	6.20	8.42	3.01	11.43	27.89	Pass
	165	5825	1.57	3.79	3.01	6.80	27.89	Pass
1	149	5745	-3.01	-0.79	3.01	2.22	27.89	Pass
	157	5785	6.90	9.12	3.01	12.13	27.89	Pass
	165	5825	0.68	2.90	3.01	5.91	27.89	Pass

**NOTE:** Directional gain =  $10 \log[(10^{G1/20} + 10^{G2/20})^2 / 2]$  = 8.11dBi > 6dBi , so the power density limit shall be reduced to  $30-(8.11-6) = 27.89$ dBm.

### 802.11n (HT40)

TX chain	Chan.	Chan. Freq. (MHz)	PSD		10 log (N=2) dB	Total PSD (dBm/500kHz)	Limit (dBm/500kHz)	Pass /Fail
			(dBm/300kHz)	(dBm/500kHz)				
0	151	5755	-7.77	-5.55	3.01	-2.54	27.89	Pass
	159	5795	-1.28	0.94	3.01	3.95	27.89	Pass
1	151	5755	-8.55	-6.33	3.01	-3.32	27.89	Pass
	159	5795	-1.74	0.48	3.01	3.49	27.89	Pass

**NOTE:** Directional gain =  $10 \log[(10^{G1/20} + 10^{G2/20})^2 / 2]$  = 8.11dBi > 6dBi , so the power density limit shall be reduced to  $30-(8.11-6) = 27.89$ dBm.

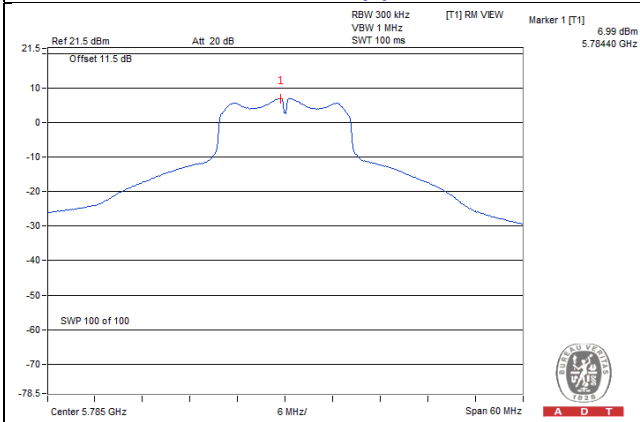
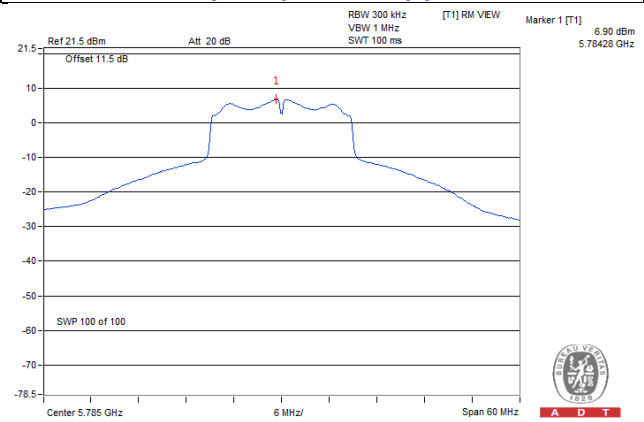
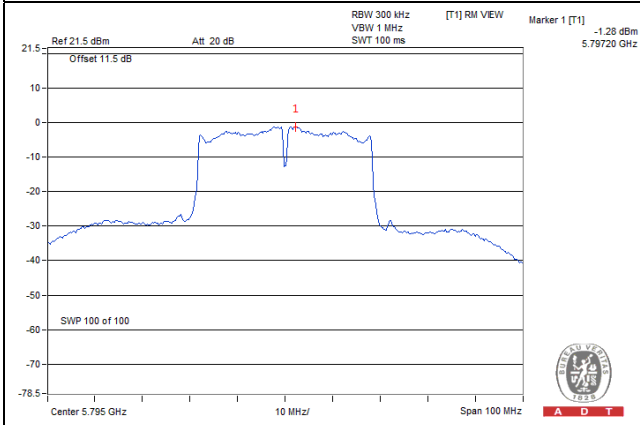
**Spectrum Plot of Worst Value****802.11a – Chain (1): CH 157****802.11n (HT20) – Chain (1): CH 157****802.11n (HT40) – Chain (0): CH 159**

## 4.5 Frequency Stability Measurement

### 4.5.1 Limits of Frequency Stability Measurement

The frequency of the carrier signal shall be maintained within band of operation

### 4.5.2 Test Setup

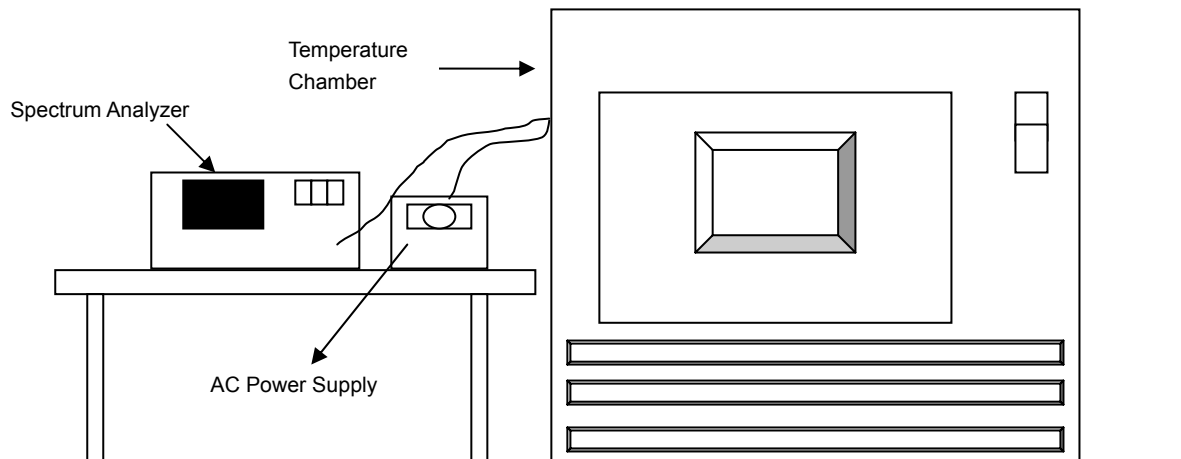

### 4.5.3 Test Instruments

Refer to section 4.1.2 to get information of above instrument.

### 4.5.4 Test Procedure

- The EUT was placed inside the environmental test chamber and powered by nominal AC voltage.
- Turn the EUT on and couple its output to a spectrum analyzer.
- Turn the EUT off and set the chamber to the highest temperature specified.
- Allow sufficient time (approximately 30 min) for the temperature of the chamber to stabilize, turn the EUT on and measure the operating frequency after 2, 5, and 10 minutes.
- Repeat step 2 and 3 with the temperature chamber set to the lowest temperature.
- The test chamber was allowed to stabilize at +20 degree C for a minimum of 30 minutes. The supply voltage was then adjusted on the EUT from 85% to 115% and the frequency record.

### 4.5.5 Deviation from Test Standard

No deviation.

### 4.5.6 EUT Operating Condition

Set the EUT transmit at un-modulation mode to test frequency stability.

**4.5.7 Test Results**

<b>FREQUENCY STABILITY VERSUS TEMP.</b>									
<b>OPERATING FREQUENCY: 5180MHz</b>									
<b>TEMP. (°C)</b>	<b>POWER SUPPLY (Vac)</b>	<b>0 MINUTE</b>		<b>2 MINUTE</b>		<b>5 MINUTE</b>		<b>10 MINUTE</b>	
		<b>Measured Frequency (MHz)</b>	<b>Frequency Drift (%)</b>	<b>Measured Frequency (MHz)</b>	<b>Frequency Drift (%)</b>	<b>Measured Frequency (MHz)</b>	<b>Frequency Drift (%)</b>	<b>Measured Frequency (MHz)</b>	<b>Frequency Drift (%)</b>
50	120	5179.9886	-0.00022	5179.9925	-0.00014	5179.9903	-0.00019	5179.9925	-0.00014
40	120	5179.9836	-0.00032	5179.9863	-0.00026	5179.985	-0.00029	5179.984	-0.00031
30	120	5180.0191	0.00037	5180.0187	0.00036	5180.0213	0.00041	5180.0207	0.00040
20	120	5179.9925	-0.00014	5179.9971	-0.00006	5179.9958	-0.00008	5179.9952	-0.00009
10	120	5179.9921	-0.00015	5179.9877	-0.00024	5179.9874	-0.00024	5179.991	-0.00017
0	120	5179.9794	-0.00040	5179.9785	-0.00042	5179.9797	-0.00039	5179.9756	-0.00047
-10	120	5179.9768	-0.00045	5179.975	-0.00048	5179.9736	-0.00051	5179.9731	-0.00052
-20	120	5179.9971	-0.00006	5179.9985	-0.00003	5179.9947	-0.00010	5179.9963	-0.00007
-30	120	5180.0255	0.00049	5180.0213	0.00041	5180.0253	0.00049	5180.0216	0.00042

<b>FREQUENCY STABILITY VERSUS TEMP.</b>									
<b>OPERATING FREQUENCY: 5180MHz</b>									
<b>TEMP. (°C)</b>	<b>POWER SUPPLY (Vac)</b>	<b>0 MINUTE</b>		<b>2 MINUTE</b>		<b>5 MINUTE</b>		<b>10 MINUTE</b>	
		<b>Measured Frequency (MHz)</b>	<b>Frequency Drift (%)</b>	<b>Measured Frequency (MHz)</b>	<b>Frequency Drift (%)</b>	<b>Measured Frequency (MHz)</b>	<b>Frequency Drift (%)</b>	<b>Measured Frequency (MHz)</b>	<b>Frequency Drift (%)</b>
20	138	5179.9927	-0.00014	5179.9964	-0.00007	5179.9956	-0.00008	5179.9953	-0.00009
	120	5179.9925	-0.00014	5179.9971	-0.00006	5179.9958	-0.00008	5179.9952	-0.00009
	102	5179.9918	-0.00016	5179.9974	-0.00005	5179.9963	-0.00007	5179.9947	-0.00010

## 4.6 6dB Bandwidth Measurement

### 4.6.1 Limits of 6dB Bandwidth Measurement

The minimum of 6dB Bandwidth Measurement is 0.5MHz.

### 4.6.2 Test Setup

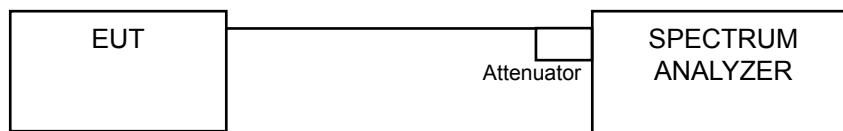

### 4.6.3 Test Instruments

Refer to section 4.1.2 to get information of above instrument.

### 4.6.4 Test Procedure

#### MEASUREMENT PROCEDURE REF

- a. Set resolution bandwidth (RBW) = 100kHz
- b. Set the video bandwidth (VBW)  $\geq 3 \times$  RBW, Detector = Peak.
- c. Trace mode = max hold.
- d. Sweep = auto couple.
- e. Measure the maximum width of the emission that is constrained by the frequencies associated with the two amplitude points (upper and lower) that are attenuated by 6 dB relative to the maximum level measured in the fundamental emission

### 4.6.5 Deviation from Test Standard

No deviation.

### 4.6.6 EUT Operating Condition

The software provided by client to enable the EUT under transmission condition continuously at lowest, middle and highest channel frequencies individually.

#### 4.6.7 Test Results

##### 802.11a

Channel	Frequency (MHz)	6dB Bandwidth (MHz)		Minimum Limit (MHz)	Pass / Fail
		Chain 0	Chain 1		
149	5745	15.37	15.50	0.5	Pass
157	5785	15.15	15.75	0.5	Pass
165	5825	15.18	15.19	0.5	Pass

##### 802.11n (HT20)

Channel	Frequency (MHz)	6dB Bandwidth (MHz)		Minimum Limit (MHz)	Pass / Fail
		Chain 0	Chain 1		
149	5745	15.38	15.53	0.5	Pass
157	5785	15.21	16.34	0.5	Pass
165	5825	15.53	16.32	0.5	Pass

##### 802.11n (HT40)

Channel	Frequency (MHz)	6dB Bandwidth (MHz)		Minimum Limit (MHz)	Pass / Fail
		Chain 0	Chain 1		
151	5755	36.13	36.39	0.5	Pass
159	5795	36.12	36.42	0.5	Pass

Spectrum Plot of Worst Value

802.11a – Chain (0): CH 157

802.11n (HT20) – Chain (0): CH 157

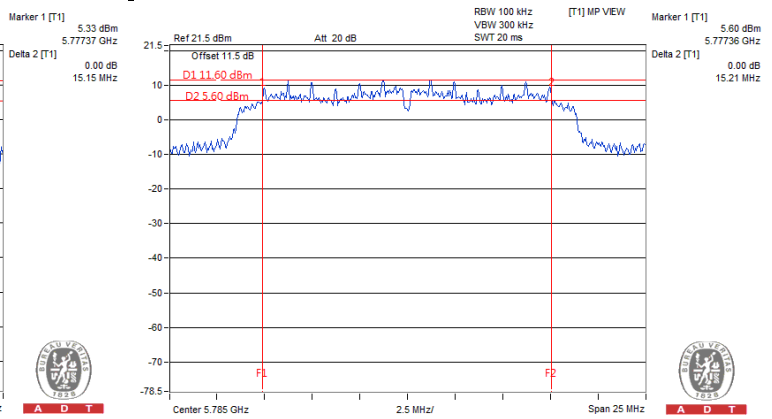
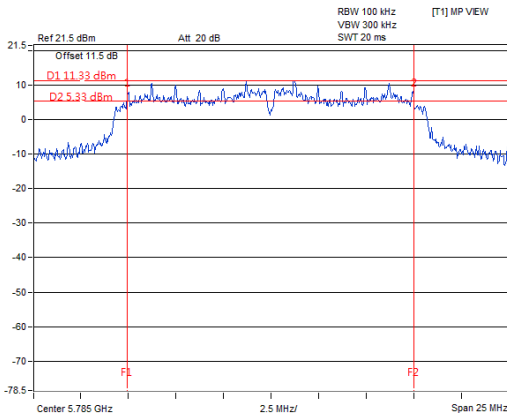

802.11n (HT40) – Chain (0): CH 159

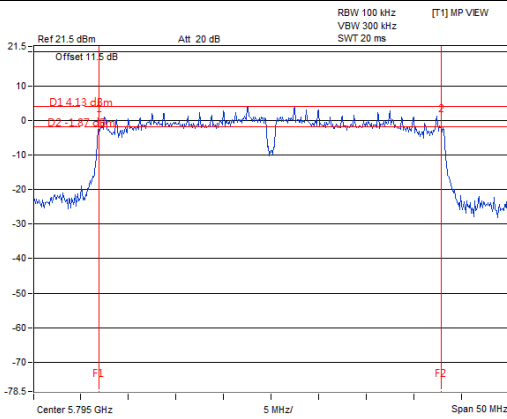





## 5 Pictures of Test Arrangements

Please refer to the attached file (Test Setup Photo).

## Appendix – Information on the Testing Laboratories

We, Bureau Veritas Consumer Products Services (H.K.) Ltd., Taoyuan Branch, were founded in 1988 to provide our best service in EMC, Radio, Telecom and Safety consultation. Our laboratories are accredited and approved according to ISO/IEC 17025.

If you have any comments, please feel free to contact us at the following:

### **Linko EMC/RF Lab**

Tel: 886-2-26052180

Fax: 886-2-26051924

### **Hsin Chu EMC/RF Lab/Telecom Lab**

Tel: 886-3-5935343

Fax: 886-3-5935342

### **Hwa Ya EMC/RF/Safety**

Tel: 886-3-3183232

Fax: 886-3-3270892

**Email:** [service.adt@tw.bureauveritas.com](mailto:service.adt@tw.bureauveritas.com)

**Web Site:** [www.bureauveritas-adt.com](http://www.bureauveritas-adt.com)

The address and road map of all our labs can be found in our web site also.

--- END ---