

Version 1

Date: 2014-03-24

# 1417WGC

## User / Installation Manual

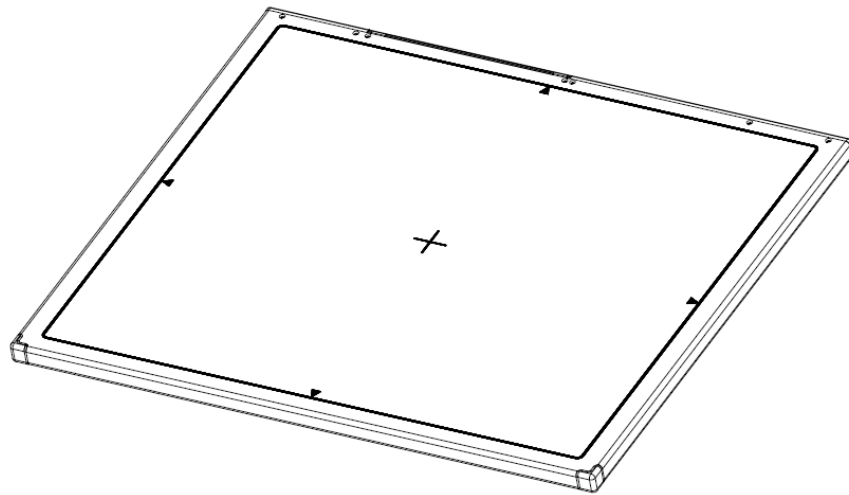

© Copyright 2014, Rayence Co. Ltd.

---

All pages of this document contain proprietary and confidential information of Rayence Corporation and are intended for exclusive use by Rayence Corporation personnel or customers. Copying, disclosure to others or other use is prohibited without the express written authorization from Rayence Corporation. Please report any violations of requirement to Rayence Corporation.

# Attention

For improvement of product performance, supplementation, or follow-up of information; the contents of this manual are subject to change without separate prior notice.

Please note that our company has neither responsibility for any accidents nor obligation to do free repair service for any damage of the equipment due to user's mistake, which resulted from failure to follow the contents in this manual. Make sure to be familiar with the safety precautions and usage procedures. Also note that the product may slightly differ from the contents of this manual depending on specification.

The following marks are used for the effective use of the product in this manual.



**Attention, consult accompanying documents.**

---



**This is used to emphasize essential information. Be sure to read this information to avoid incorrect operation.**



**This indicates hazardous situation which, if not heeded, may result in minor or moderate injury to you or others, or may result in machine damage.**



**This indicates a potentially hazardous situation which, if not heeded, could result in death or serious injury to you or others.**

**Federal Law restricts this device to sale by or the order of a radiologist or any other practitioners licensed by the law of the state in which that person practices to use or order the use of the device.**

---

# Contents

<b>1. Introduction .....</b>	<b>6</b>
(1) Overview .....	6
(2) Intended use .....	6
(3) Product features .....	7
(4) Product components .....	8
(5) Components Description .....	11
(6) Warning .....	14
(7) Caution .....	16
<b>2. Notes for Using the Detector .....</b>	<b>19</b>
(1) Preparing .....	19
(2) Handling .....	21
(3) Before Exposure .....	22
(4) During Exposure .....	22
(5) Limit of Load .....	23
(6) Disinfection and Cleaning .....	24
(7) Others .....	24
<b>3. Technical Features .....</b>	<b>25</b>
(1) Mechanical Features .....	25
(2) Electrical Features .....	25
(3) Environmental requirement .....	29
(4) PC Requirements .....	29
<b>4. Installation .....</b>	<b>30</b>
(1) Program setup .....	30
(2) Connection (Manual Trigger) .....	31
(3) Connection (Auto Trigger) .....	39
(5) IP set up .....	44
(6) Using FPD_Manager (IP, SSID Change / Upgrade FW) .....	45
<b>5. Calibration .....</b>	<b>51</b>
(1) General Principle .....	51
(2) Calibration .....	53
<b>6. Image Acquisition Test .....</b>	<b>58</b>
(1) Get Image .....	58
(2) View Images .....	59
(3) Get Recent Frame .....	64
<b>7. Operation .....</b>	<b>65</b>
(1) Recommend .....	65
(2) Switching power on / off .....	65
(3) Storage .....	65
<b>8. Safety Information .....</b>	<b>66</b>
(1) Safety standard .....	66
(2) Electromagnetic Compatibility Information .....	68
<b>9. Radio Frequency compliance .....</b>	<b>73</b>
(1) FCC Notice (U.S.A) .....	73
(2) IC Notice (CANADA) .....	75
(3) R&TTE Notice (European Union) .....	76
<b>10. Maintenance .....</b>	<b>77</b>

(1) Maintenance .....	77
(2) Cleaning.....	77
(3) Inspection .....	78
(4) Disposal or Recycling .....	79
(5) Marking and labeling symbols.....	80

**Appendix.....82**

# 1. Introduction

## (1) Overview

The 1417WGC is a wireless digital X-ray flat panel detector that can generate images of any part of the body. The wireless LAN((IEEE 802.11a/g/n) communication feature improves the operability, and high-speed processing. This X-ray imaging system consists of a scintillator directly coupled to an a-Si TFT sensor. It makes high-resolution, high-sensitive digital images.

## (2) Intended use

Digital Flat Panel X-Ray Detector is indicated for digital imaging solution designed for general radiographic system for human anatomy. It is intended to replace film or screen based radiographic systems in all general purpose diagnostic procedures. Not to be used for mammography.

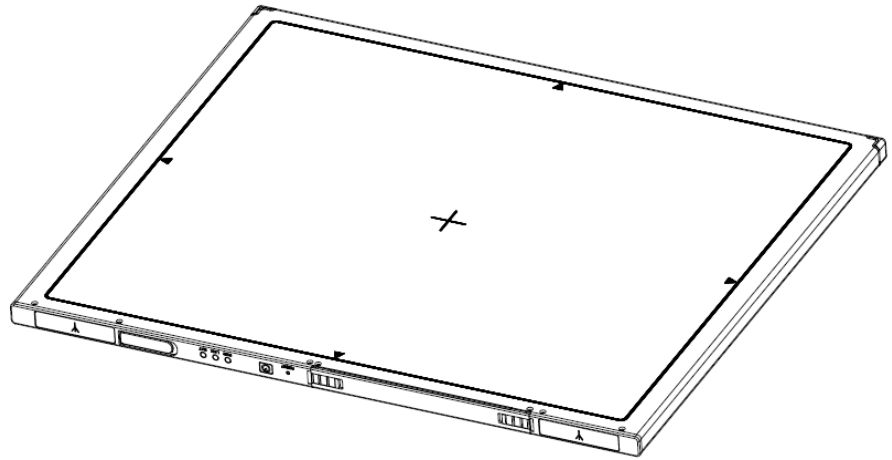

### (3) Product features



- Wi-Fi (802.11a/g/n)
- Based on a-Si TFT active matrix
- Compact (15.4mm thickness) and light weight (Typ. 3kg)
- Limiting Resolution : 3.9 lp/mm
- 14/16-bit digital output
- Easy integration

## (4) Product components

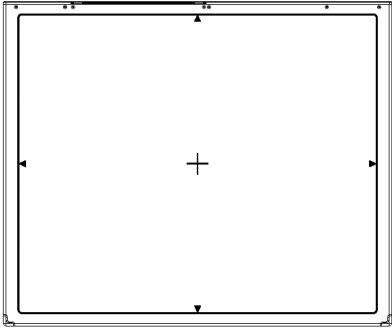
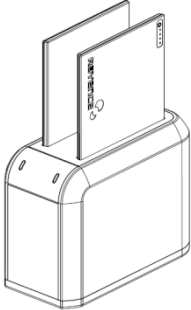
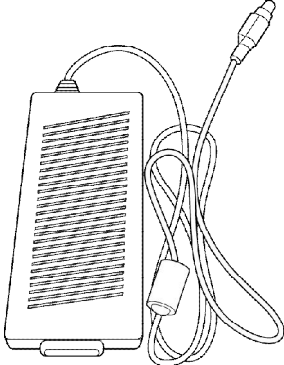
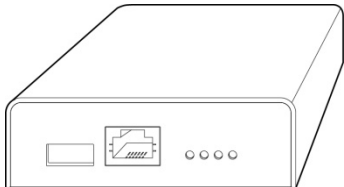
- Medical Image Processing Unit

Photo	Item	Part Name	Quantity
	Detector	RD1417WGC	1
	Battery pack	RB37WHA	2
	Battery charger	RC120WA	1
	Charger adapter	PMP120-13-3	1
	AGI	RA001A	1
	Power supply box	RP003A	1

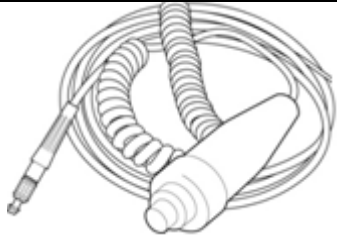
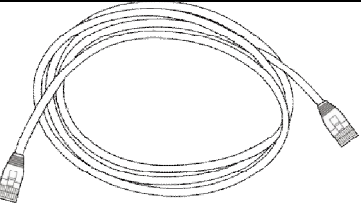
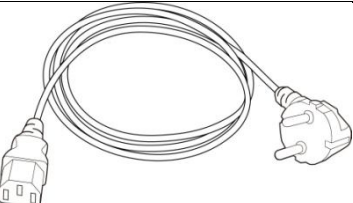

- Cables

	Item	Part Name	Length	Quantity
	Link cable		7m	1
	P-Interface cable	VRH017A	8m	1
	USB cable(A to B)	VRH078A	1.8m	1
	LAN cable	VRH027A	10m	1
	AC Power cord	VRH018A/019A	1.8m	2

- Installation CD

- Manual
- Detector Library

- Option
  - Additional Battery
  - Trigger cable

## (5) Components Description

The detector is designed to capture radiographic images.

Captured images are transmitted to PC using the wireless/wired connection.

(1) Detector

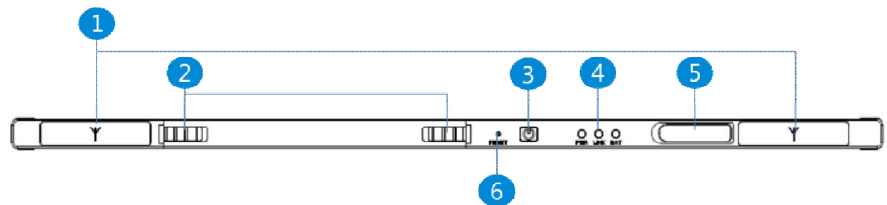

### 1. Wireless antennas

The module adopts the latest 802.11n Dual-Band technology (2.4Ghz and 5Ghz). The transmitter of the module is powered by host equipment(Detector). The antennas are 2 printed-dipole antennas.

\*Wireless module information:

The SparkLAN WPEA-121N 802.11 a/b/g/n half mini PCI-e module is implemented. It supports 2T2R (2 transmit 2 receive) MIMO technology, which delivers throughput up to 300Mbps.

1417WGC in the RF module does not use DFS band.

\*RF module (FCC ID: [PPD-AR5BHB116](#))

2. **Battery unlock-lever** : This is an unlock-lever to remove battery.
3. **Power button** : Power on / Power off switch.
4. **LED indicator**: The LED indicates the state of detector.
  - i. **Green on** : Power on.
  - ii. **Blue blinking** : Wireless Connection.
  - iii. **Orange on** : Low battery.
5. **Link cable connector** : This is a connector for wire communication and power supplying. Connect the detector to the power supply using Link cable.
6. **Reset button** : This is a button for factory reset.

## (2) Battery & Charger

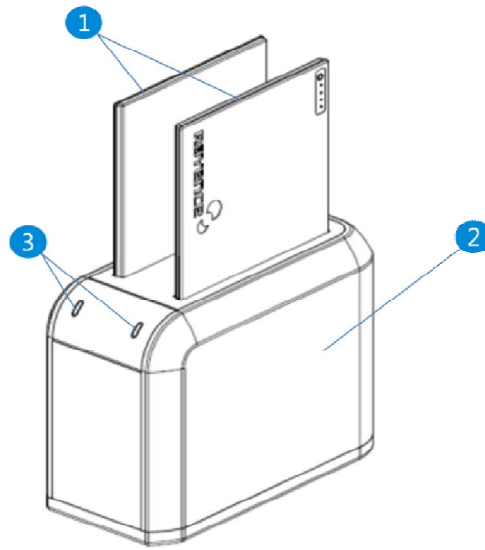

1. **Battery** : Lithium ion battery. The number of times being acquired image is 960 images(@ cycle time : 15s). The batteries are rechargeable

The charging time = 3 hours.

2. **Charger** : Two port cradle type.

3. **LED indicator** :

- i. **Orange on** : charging
- ii. **Green on** : Charging is completed.

## (3) AGI

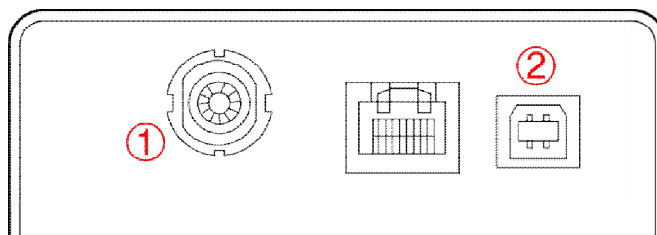

1. **Trigger connector**: This is a connector for synchronization between detector and generator. Connect the AGI to the generator using P-interface cable or trigger cable

2. **USB connector**: This is a connector for communication between AGI and PC. Connect the AGI to the PC using USB cable.

#### (4) Power supply box

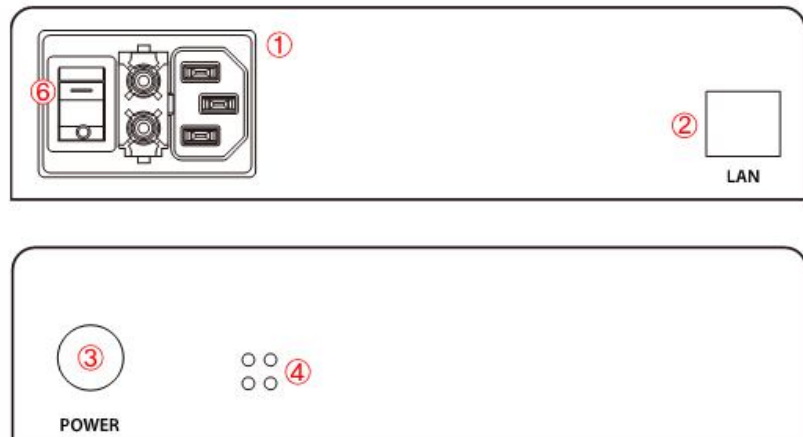

1. **Power plug connector:** Connect with AC power supply cord
  2. **LAN connector :** Ethernet port for transmitting the image/command between detector and PC
  3. **Link cable connector:** Power connector for detector operating
  4. **LED indicator:** Four LEDs to display the status
- ※ **Changeable part:** Fuse T3.15 AL 250V



Make sure  
to observe  
the following right

## **(6) Warning**

### **Environment of Use and Storage**

Follow the specified process of operational instructions written in this manual for the safety of the users and patients.

Does not use or store the instrument near any flammable chemicals such as thinner, benzene, etc. Also, this instrument is not a category AP or APG equipment. If chemicals are spilled or evaporate, it may result in fire or electric shock through contact with electric parts inside the instruments. Also, some disinfectants are flammable. Be sure to take care when using them.

### **Connection**

Do not connect the instrument with anything other than specified. Otherwise, it may result in fire or electric shock.

To avoid the risk of electric shock, this equipment must only be connected to a supply mains with protective earth.

### **Wireless connection**

SSID & PSK value should match to Router's setting. (Refer to the Ch.4.(2)). If these values are not matched with Detector and Router, the connection is not allowed for security.

Avoid using co-channel or adjacent-channel with other wireless devices for high quality wireless performance.

### **Handling**

Always be sure to keep checking the condition of the system and the patient to ensure they are normal during the use of the instrument. If any problem is found, take appropriate measures, such as stopping the operation of the instrument, as required.

Never disassemble or modify the product as it may result in fire or electric shock. Also, since the instrument incorporates parts that may cause electric shocks and other hazardous parts, touching them may cause death or serious injury.

Do not hit or drop the instrument. The instrument may be damaged if it receives a strong jolt, which may result in fire or electric shock if the instrument is used without being repaired.

### **When Problem Occurs**

Should any of the following occur, immediately turn OFF the power of each instruments, unplug the power supply cord from the AC outlet, and contact Rayence representative or distributor.

- When there is smoke, odd smell or abnormal sound.
- When liquid has been spilled into the instrument or a metal object has entered through an opening.
- When the instrument has been dropped and it is damaged.

### **Maintenance and Inspection**

For safety reasons, be sure to turn OFF the power of each instrument when the inspections indicated in this manual are going to be performed. Otherwise, it may result in electric shock.

When the instrument is going to be cleaned, be sure to turn OFF the power of each instrument, and unplug the power supply cord from the AC outlet.

The instrument must be repaired by a qualified engineer only. If it is not repaired properly, it may cause fire, electric shock, or accident.

## (7) Caution

### Environment of Use and Storage

Do not install the instrument in a location with the conditions listed below. Otherwise, it may result in failure or malfunction, cause fire or injury.

- Close to facilities where water is used.
- Where it will be exposed to direct sunlight.
- Close to air-conditioner or ventilation equipment.
- Close to heat source such as a heater.
- Prone to vibration.
- Insecure place.
- Dusty environment.
- Saline or sulfurous environment.
- High temperature or humidity.
- Freezing or condensation.



Do not place the storage case in a location with the conditions listed below.

- Where the cable of the sensor unit will be strongly pulled when the sensor unit is put into the case, otherwise, the cable may be damaged, resulting in fire or electric shock.
- Where someone might get their foot caught in the cable of the sensor unit. Otherwise they could trip over, resulting in injury
- Non-medical equipment such as the battery charger, access point cannot be used in patient's vicinity.

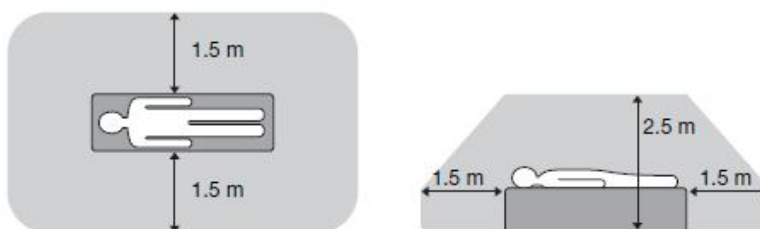



## Handling

Do not spill liquid or chemicals onto the instrument or, in cases where the patient is injured, allow it to become wet with blood or other body fluids, as doing so may result in fire or electric shock. In such situation, protect the instrument with disposable covering as necessary.

Wipe the CFRP plate of the sensor unit with ethanol or glutaraldehyde solution to disinfect it each time a different patient uses the instrument, in order to prevent infection.

Turn off the power of each instrument for safety when they are not going to be used.

This device is contraindicated in pregnant woman.

## Maintenance and Inspection

For safety reasons, be sure to inspect the instrument before using it. In addition, carry out a regular inspection at least once a year.

## Modifications

Any changes or modifications in construction of this device which are not expressly approved by the party responsible for compliance could void the user's authority to operate the equipment.

## Battery

**Do not let the detector or battery come in contact with liquids.** Liquids can get into the detector's circuits, leading to corrosion. Even when the detector appears to be dry and appears to operate normally, the circuitry could slowly corrode and pose a safety hazard. If the detector and/or battery get wet, have them checked by your service provider or contact Rayence, even if they appear to be working properly.

**Do not place your battery in or near a heat source.** Excessive heating can damage the detector or the battery and could cause the detector or the battery to explode. Do not dry a wet or damp battery with an appliance or heat source such as a microwave oven, hair dryer, iron, or radiator.

**Do not dispose of the detector or the battery in a fire.** The detector or the battery may explode when overheated.

**Never use any charger or battery that is damaged in any way.**

**Important!** Use only Rayence-approved batteries, and recharge your battery only with Rayence-approved chargers which are specifically designed for your detector.

**Use of a non-Rayence-approved battery or charger may present a risk of fire, explosion, leakage, or other hazard.** Rayence's warranty does not cover damage to the detector caused by non-Rayence-approved batteries and/or chargers

**Misuse or use of incompatible batteries and charging devices could result in damage to the equipment and a possible risk of fire, explosion, or leakage, leading to serious injuries, damages to your detector, or other serious hazard.**

Check the battery status frequently to avoid battery empty. (Refer to the Ch.3.(2) Electrical Features) When the low battery LED of detector is turned on, change the battery or charge the battery using cable

## 2. Notes for Using the Detector

### (1) Preparing

Fully charge the battery pack. Charge the battery on the day of examination or on the previous day.

- Battery slowly discharges even if not in use. The battery pack may have expired if it discharges immediately after being fully charged. You can purchase an optional battery pack to replace an exhausted one.
- Be sure to fully charge the battery before use.
  - ※ The battery charger, RC120WA is designed for the dedicated battery pack.
  - ※ When the detector will not be used for some time, remove the battery pack.

Attach the battery pack. Align the claw on the battery pack and the groove on the battery bay. Insert the battery pack fully. Push down the battery pack and cover.

<Insert battery>

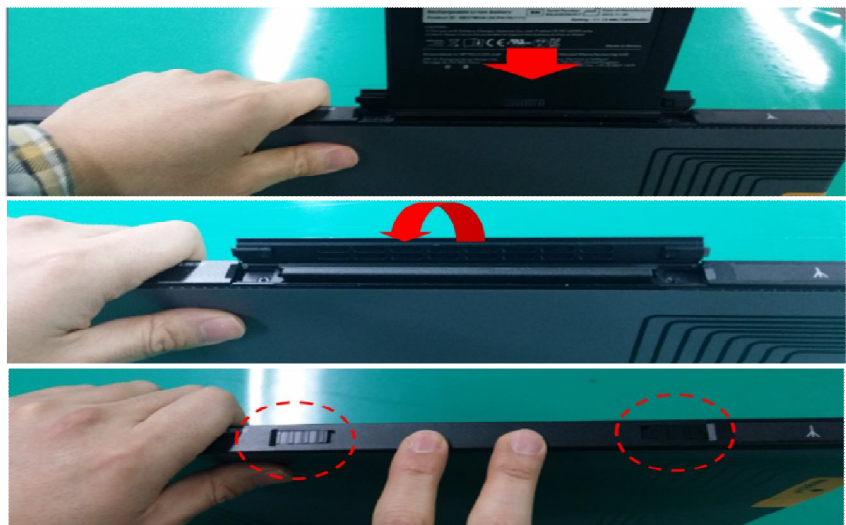

<Remove battery>

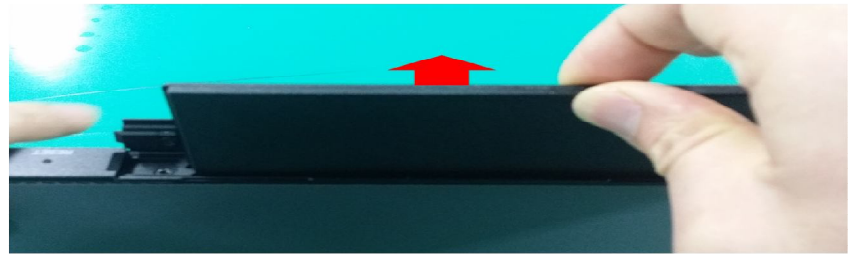

## (2) Handling

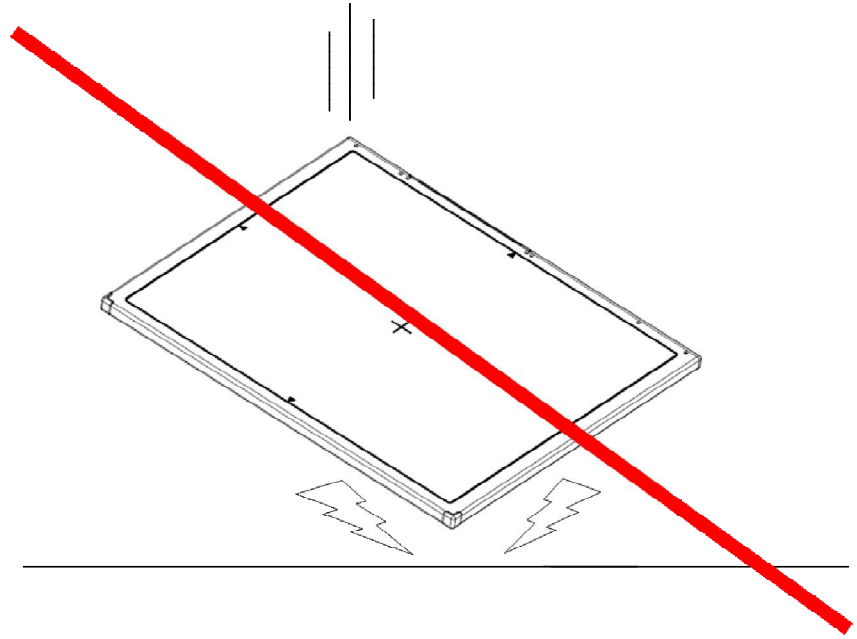

Handle the instrument carefully, as it may be damaged if something is hit against it, dropped, or receives a strong jolt.

### **(3) Before Exposure**

Be sure to check the equipment daily and confirm that it works properly.

Sudden heating of the room in cold areas will cause condensation to form on the instrument. In this case, wait until condensation disappears before performing exposure.

➔ Room temp. 70°F / 21°C is recommended.

If the instrument is used with condensation formed on it, problems may occur in the quality of the instrument. When an air-conditioner is going to be used, be sure to raise/lower the temperature gradually so that a difference in temperature in the room and in the instrument does not occur, to prevent forming of condensation.

### **(4) During Exposure**

Do not use the detector near devices generating a strong magnetic field. Doing so may produce image noise or artifacts.

Do not apply excessive weight to the sensor unit. Otherwise, the sensor may be damaged.

## (5) Limit of Load

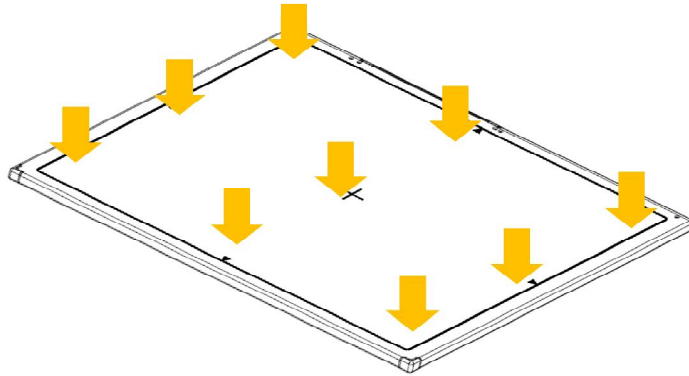

Uniform load: 150 kg over the whole area of sensor window.

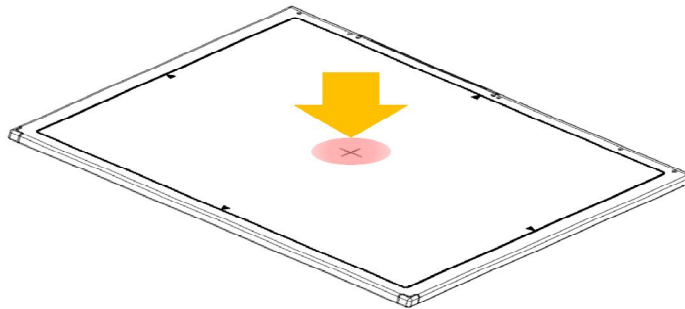

Local load: 100 kg on an area 40 mm in diameter.

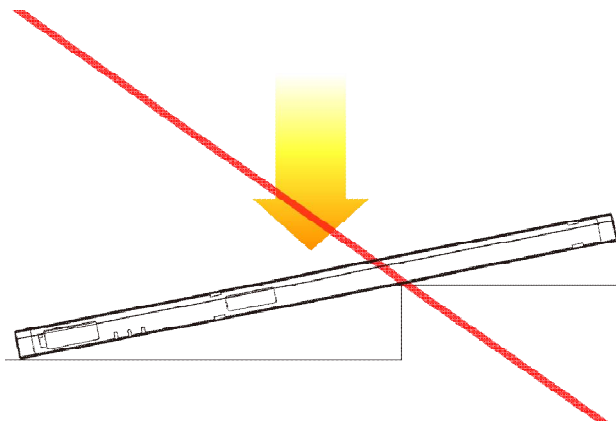

Be sure to use the sensor unit on a flat place so it will not bend.

Otherwise, the sensor may be damaged.

## **(6) Disinfection and Cleaning**

Do not spray the detector directly with disinfectants or detergents.

Do not use anything other than neutral detergent for cleaning the cover of the instrument. Otherwise, the coating will be corroded.

## **(7) Others**

Be sure to reconnect the cables to the proper connectors. Otherwise, the instrument may malfunction or may be damaged.



## 3. Technical Features

### (1) Mechanical Features

<b>Size</b>	460 x 384 x 15.4 mm
<b>Weight</b>	3 kg
<b>Encapsulation Material</b>	Carbon fiber plate with 1.8 mm thickness
<b>Window Material</b>	Carbon fiber plate with 1.8 mm thickness

### (2) Electrical Features

#### Detector

<b>Sensor Type</b>	Amorphous Silicon with TFT (Single Panel)
<b>X-ray Converter</b>	Gd <sub>2</sub> O <sub>2</sub> S:Tb
<b>Total Pixel Number</b>	3328 × 2816 pixels
<b>Total Pixel Area</b>	422.7 × 357.6 mm
<b>Effective Pixel Number</b>	3268 × 2756 pixels
<b>Effective Pixel Area</b>	415.0 × 350.0 mm
<b>Pixel Pitch</b>	127 μm
<b>Limiting Resolution</b>	Max. 3.9 lp/mm
<b>Energy Range</b>	40 - 150 kV
<b>A/D Conversion</b>	14/16 bits
<b>Preview Time</b>	< 2.0 sec (wired) < 5.0 sec (wireless)
<b>Data Interface</b>	- Wireless: Wi-Fi (802.11a/g/n) - Wired: Gigabit Ethernet
<b>Power consumption</b>	Typ. 15W (Max. 30W)

- Under RQA5 condition (70kVp, 21mAl)
- Preview time is not included post-processing time

## Power Supply





<b>Size</b>	188 x 92 x 41.5 mm
<b>Weight</b>	0.46kg
<b>Input</b>	110~220VAC (50/60Hz)
<b>Output</b>	Typ. 24VDC (Max 1.9A)

## Battery

<b>Size</b>	263.2 x 127.8 x 6 mm
<b>Weight</b>	Typ. 0.3 kg
<b>Input</b>	12.5 VDC
<b>Output</b>	11.1 VDC
<b>Charging time</b>	Typ. 3 hours
<b>Capacity</b>	Typ. 3400 mAh
<b>The number of times being acquired image</b>	960 images (@cycle time = 15s)

The Battery level can be displayed on the LED status of battery.

If the battery level goes down under 25%, please charge the battery

Display	Battery level
	75~100 %
	50~75 %
	25~50 %
	0~25 %

## Charger

<b>Size</b>	200 x 100 x 150 mm
<b>Weight</b>	Typ. 0.85 kg
<b>Input</b>	20 VDC
<b>Output</b>	12.5 VDC

## Adapter

<b>Size</b>	160 x 76 x 43.7mm (cable length: 1.28m)
<b>Weight</b>	Typ. 0.73 kg
<b>Input</b>	100~240 VAC, 47~63 Hz, 1.4~0.6A
<b>Output</b>	20 VDC, Max 6.0A

## Wireless Spec

<b>Standard</b>	802.11a/g/n compliance Without DFS (5.25GHz to 5.35GHz and 5.47 to 5.725) Band
<b>Peak Rate</b>	300Mbps
<b>Frequency</b>	2.4 GHz / 5 GHz
<b>Bandwidth</b>	20MHz/40MHz
<b>MIMO</b>	2x2

※ Recommended Maximum operable distance : 10m  
(From the Access Point)

※ 5150~5250 MHz band is restricted to indoor operations only. (for FCC)

5150~5250 MHz band is restricted to indoor operations only. (for CE)

5150~5250 MHz is indoor use only. (for Japan)

### (3) Environmental requirement

Item	Min.	Typ.	Max.	Unit	Note
Temperature (Storage)	-10		50	°C	
Temperature (Operation)	5		40	°C	
Humidity (Storage)	10		80	% H.R.	
Humidity (Operation)	30		75	% H.R.	
Vibrations (Wrapping condition)		2G (8G)			10-150Hz, 10Sweeps, 1min/Octave, XYZ axis

※ Regularly changed parts : Battery (warranty 6 months)

### (4) PC Requirements

- Processor: At least Intel Pentium IV HT with 2.8GHz, Intel Core Duo / Core 2 or comparable AMD Dual Core processor
- At least 3GB of RAM requirement (4GB for 32 BITS OS and 8GB for 64 BITS OS recommended)
- At least 500GB for application and archiving. Recommended 500GB for applications and secondary drive of 1TB for image archiving..
- Dual 10/100/1000 network card system required. One for network (Internet) and one for the DR Panel communication
- Graphics card / monitor: Resolution of at least 1,600 x 900 for desktop and 1366 x 768 for laptop. For diagnostics purpose we recommend 1920 x 1080 resolution (2 mega pixels) monitor
- Microsoft® Windows 7 32BIT/64BIT
- No antivirus except for Microsoft® Security Essentials.

# 4. Installation

 Portable Imaging processing unit must be installed in a way that enables the user to achieve optimal use

The Detector is composed of sensitive electronic parts and components. It is recommended to use the product in a clean place and to exercise caution to ensure that it is not affected by dust or liquids. It is recommended to Use a dry and soft cloth to clean the detector housing.

## (1) Program setup

- Detector’s IP : Wireless - 2.2.2.100 Wired – 2.2.2.101
- Detector’s number of ADC : 0
- Detector’s size of image : 3328x2816

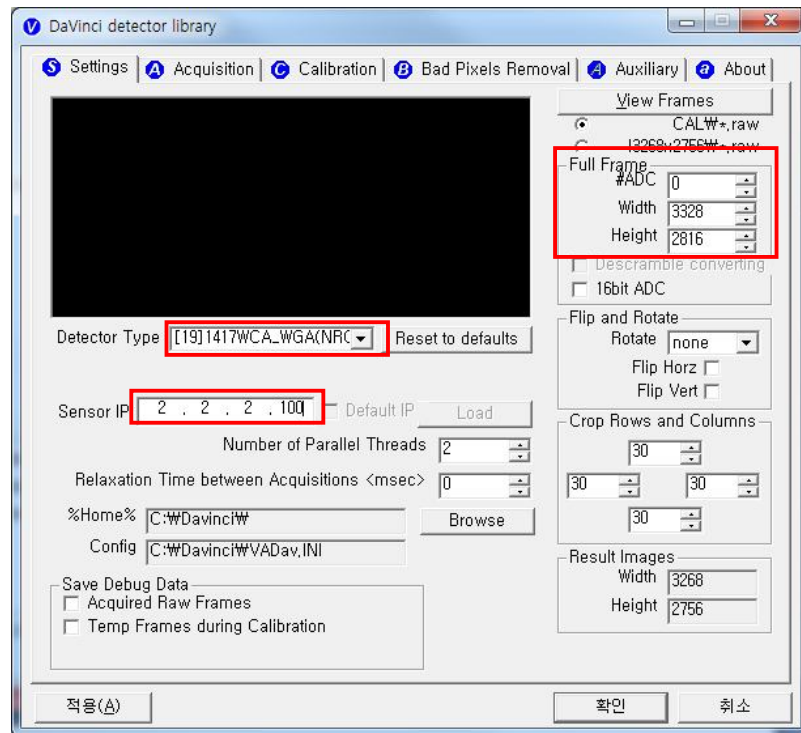
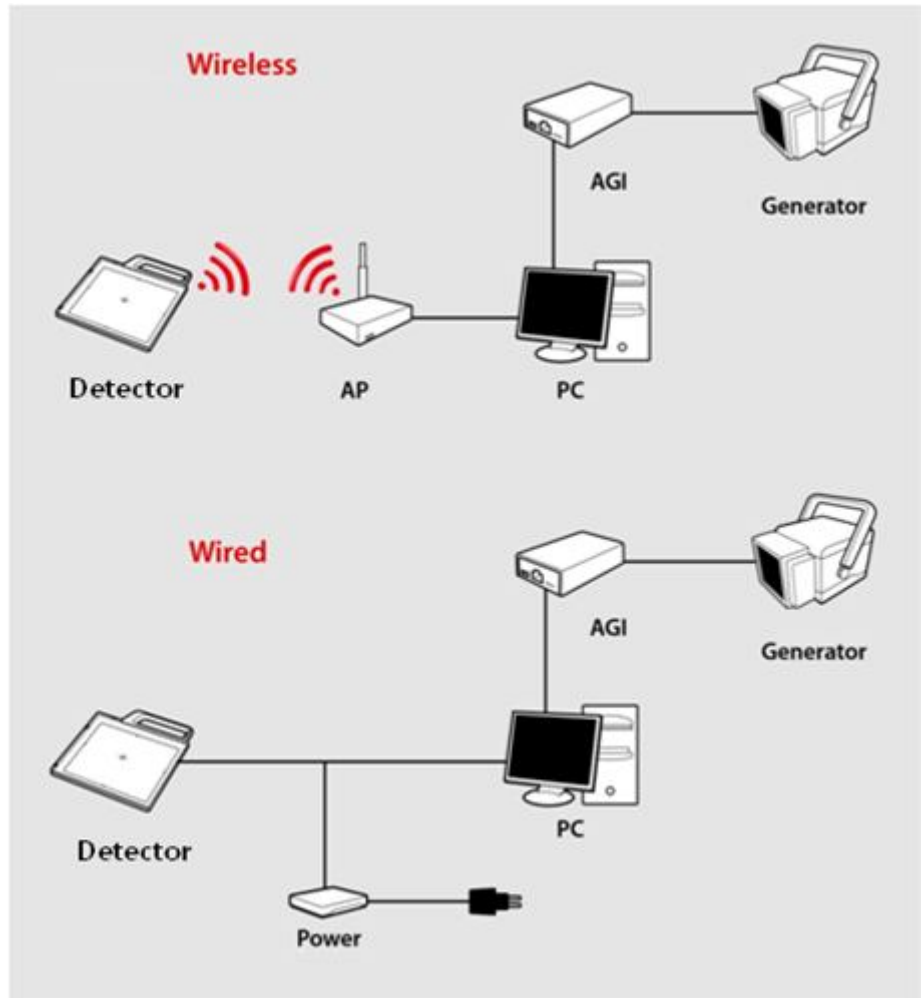

Figure 1: Setup

## (2) Connection (Manual Trigger)



### Power Connection

A. Connect the battery pack or power cable to the equipment.

*\* In wired mode, the frame ground is necessary.*

B. Connect the USB cable from your PC to AGI.

**※ Be sure to use only the dedicated battery pack, RB37WH for 1417WGC.**

### Wireless Communication

#### A. AP Router(Line sharer) setting

- SSID : Griffon
- Internal network
  - IP address : 2.2.2.1
  - Subnet mask : 255.255.255.0
  - Dynamic IP allocation range : 2.2.2.2~2.2.2.254
- Pre-Shared Key(Password) : project302
  - Authentication methods : WPAPSK or WPA2PSK
  - Password methods : TKIP/AES
- AP IP : 2.2.2.1
- Channel (Frequency)
  - Avoid crowded channel  
(Using wireless detector under crowded channel result in low performance)
  - If available, Use 'Auto-Channel Selection' function of router to find optimal channel

#### B. Reception Indicator

Link LED flickering

Blink Speed : Slow – Low link quality

Fast – High link quality

#### C. Checking Link Quality & Battery Remain



- After wireless connection is established, perform 'Get Bright' in 'Calibration' tap.
- Check the value named 'Wireless Signal' in black log screen.  
Wireless Signal = Link Quality (Max. 100)
- Check the value named 'Battery Remain' in black log screen.  
Battery Remain = Battery Remain(Max. 100)

The value 'Wireless Signal' will be displayed here

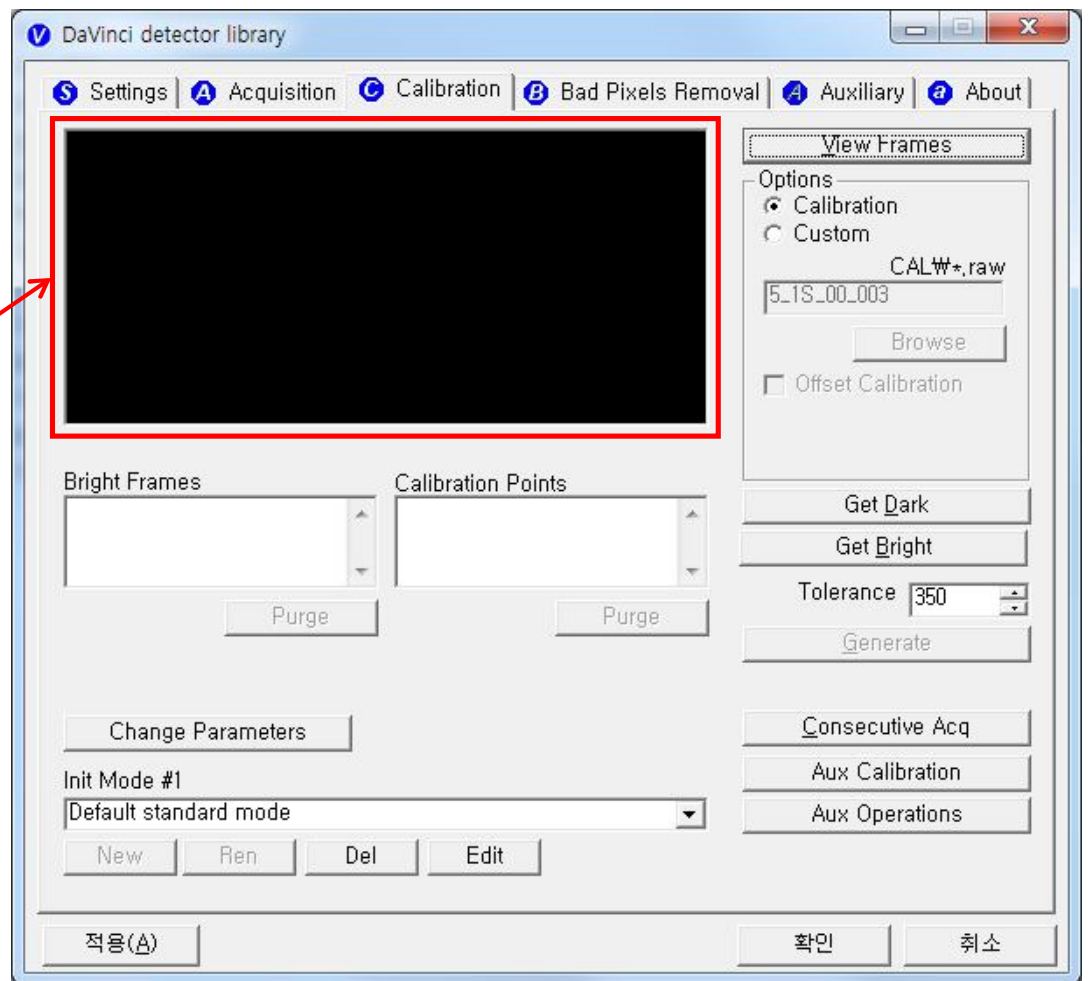

## Software Setting

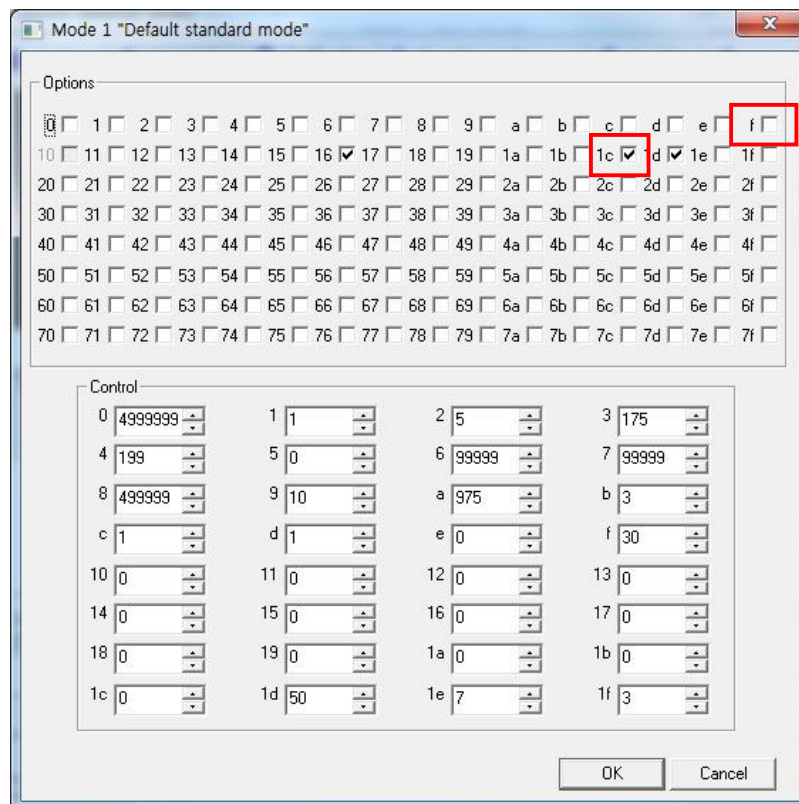
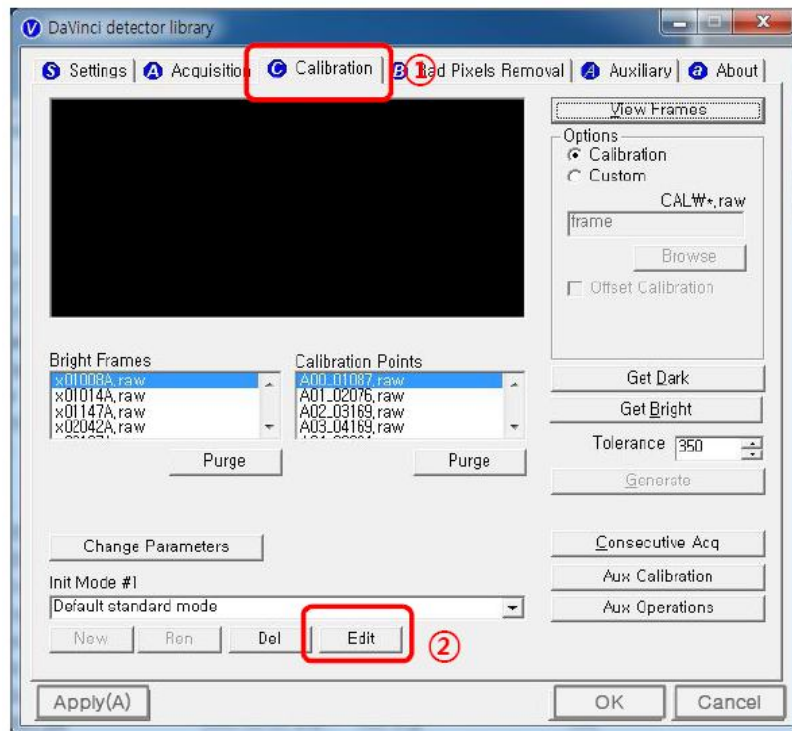
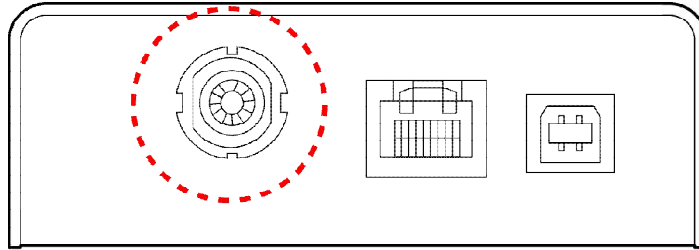

Figure 2: Davinci Setting

## Trigger Connection

A. Connect the P-interface cable or trigger cable to the generator



Make assurance doubly sure  
SIGNAL RATING before connection.

## X-ray Generator Connection

A. Mode 1 : P-interface cable mode

Connect the P-interface cable between the AGI box and X-ray generator.

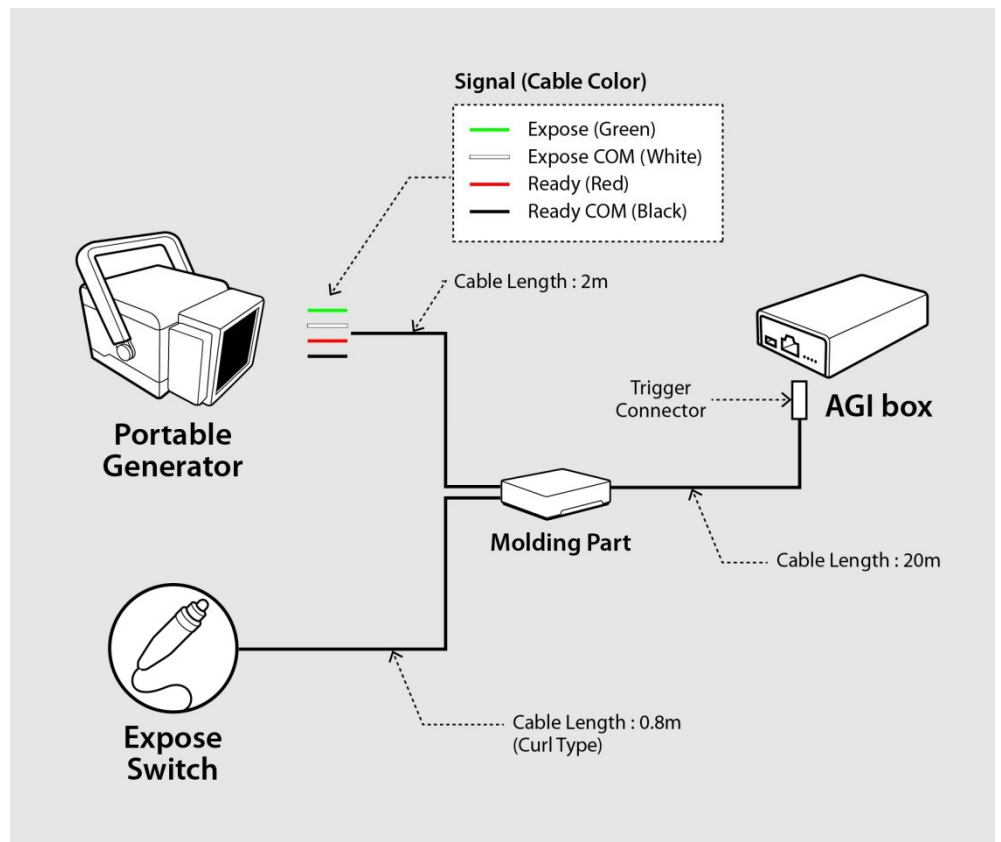

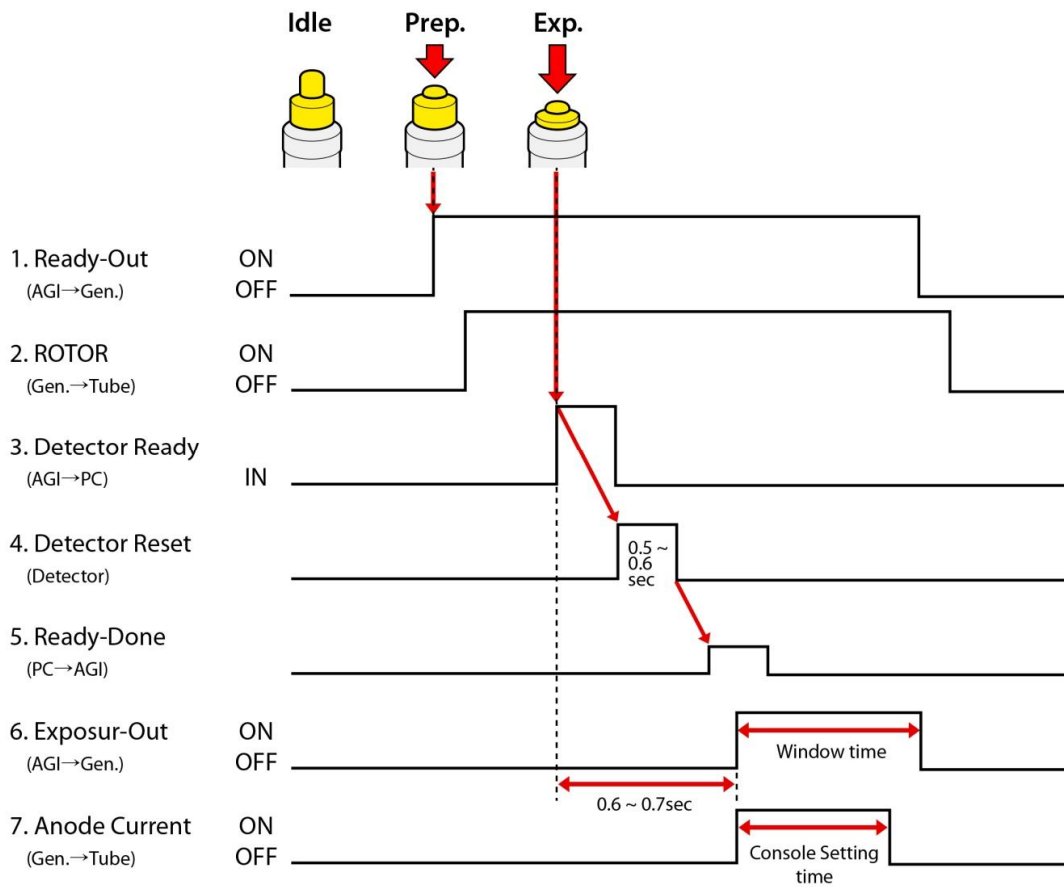

The window time can be changed. Refer to the following pictures

 Exposure Time(\*clk) 4999999 is designate to 0.5sec

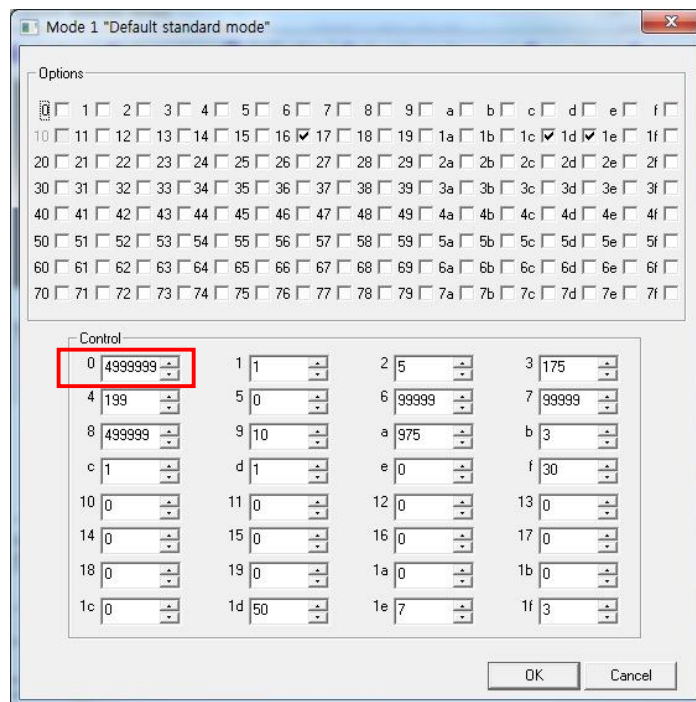



Make assurance doubly sure  
**SIGNAL RATING**  
 before connection.

## B. Mode 2 : Trigger cable mode

Connect the Trigger cable between the X-ray enable connector of AGI with X-ray generator.

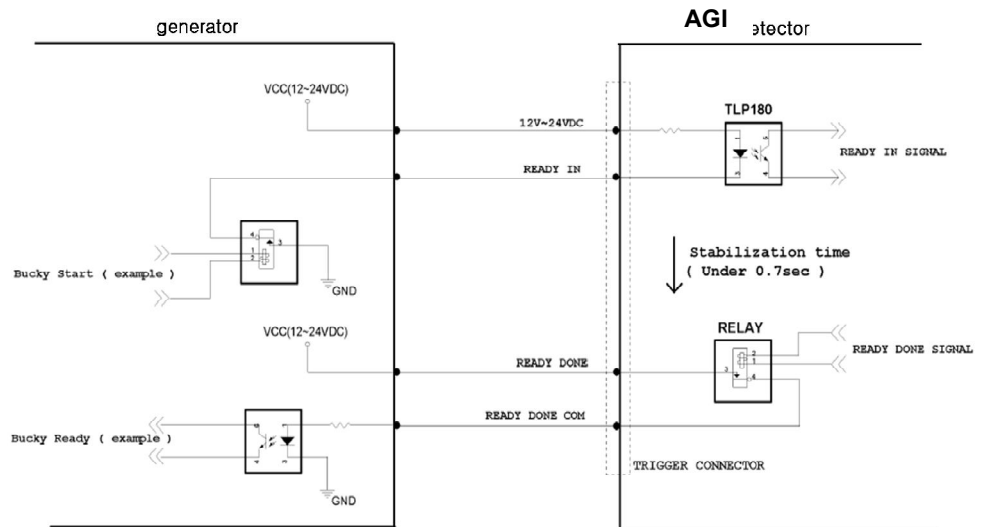

### Connection description

Signal	New Label	Old Label	Color	Input / Output
READY IN	12V~24VDC	R.E.C. +12-24V	Red	Input
	READY IN	Ready Input Signal	Black	Input
READY DONE	READY DONE	Exposure Output SW 1	Green	Output
	READY DONE COM	Exposure Output SW 2	Blue	Output

Table 3 : Connection description

## Operating description

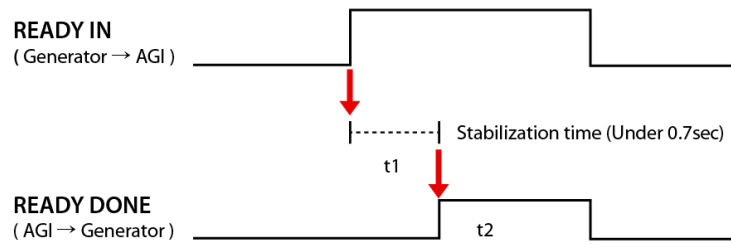

Figure 3 : Timing chart

t1: It will be occurred when exposure switch is pushed completely after.

t2: Window time of detector is varying 0 sec ~ 5 sec. which can be control by SW. (Editing parameter: Exposure Time – Refer to the NOTE)

→ Expose relay switch ON time (Window Time) and X-ray exposure time must be same.

→ t2 time can be control by SW

The window time can be changed. Refer to the following pictures

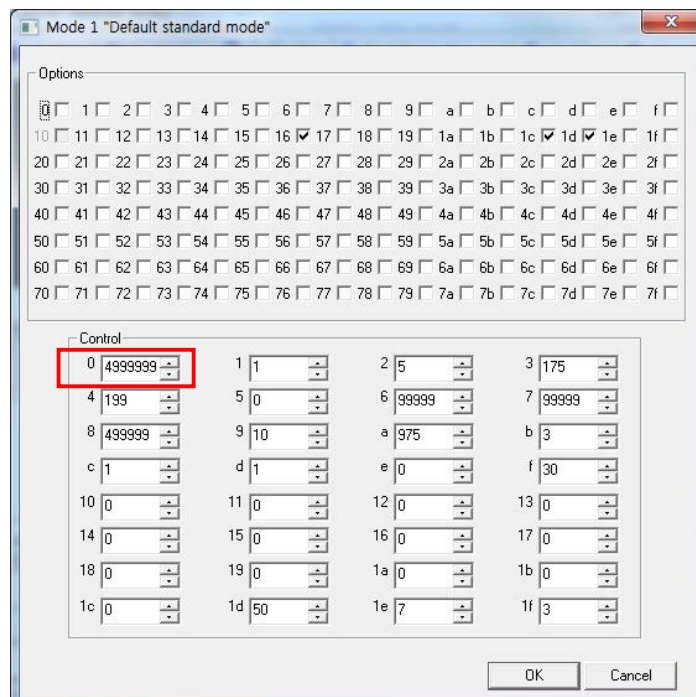

### (3) Connection (Auto Trigger)

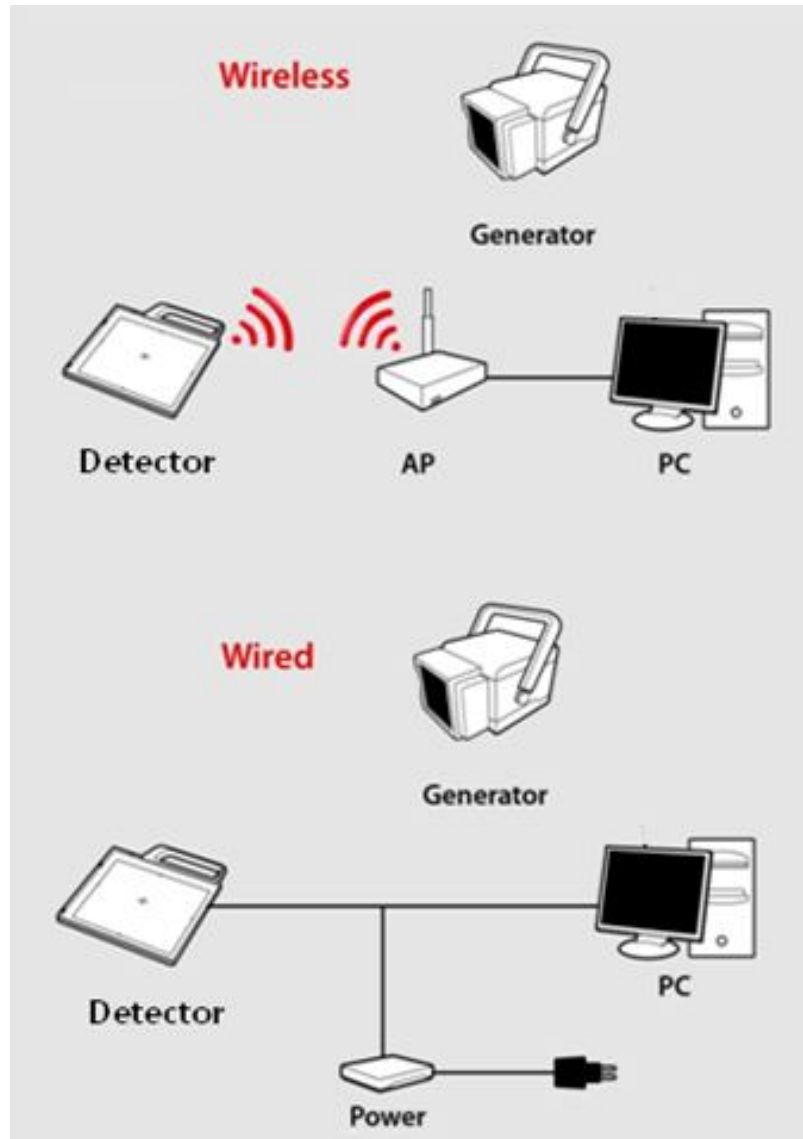

#### Power Connection

A. Connect the battery pack or power cable to the equipment.

*\* In wired mode, the frame ground is necessary.*

**※ Be sure to use only the dedicated battery pack, RB37WH for 1417WGC.**

## Wireless Communication

### A. AP Router(Line sharer) setting

- SSID : Griffon
- Internal network
  - IP address : 2.2.2.1
  - Subnet mask : 255.255.255.0
  - Dynamic IP allocation range : 2.2.2.2~2.2.2.254
- Pre-Shared Key(Password) : project302
  - Authentication methods : WPAPSK or WPA2PSK
  - Password methods : TKIP/AES
- AP IP : 2.2.2.1
- Channel (Frequency)
  - Avoid crowded channel  
(Using wireless detector under crowded channel result in low performance)
  - If available, Use 'Auto-Channel Selection' function of router to find optimal channel

### B. Reception Indicator

Link LED flickering

Blink Speed : Slow – Low link quality

Fast – High link quality



### C. Checking Link Quality & Battery Remain

- After wireless connection is established, perform 'Get Bright' in 'Calibration' tap.

- Check the value named 'Wireless Signal' in black log screen.  
Wireless Signal = Link Quality (Max. 100)

- Check the value named 'Battery Remain' in black log screen.  
Battery Remain = Battery Remain(Max. 100)

The value 'Wireless Signal' will be displayed here

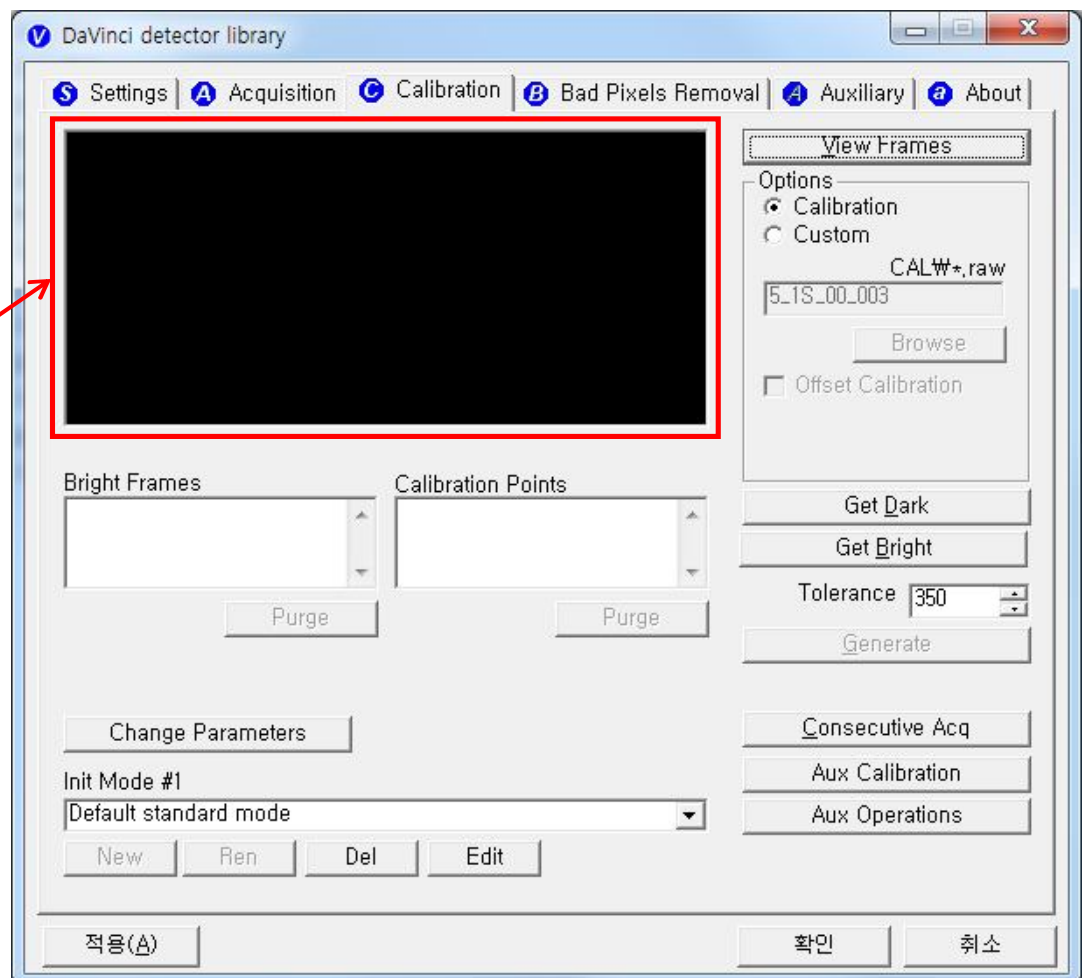

## Software Setting

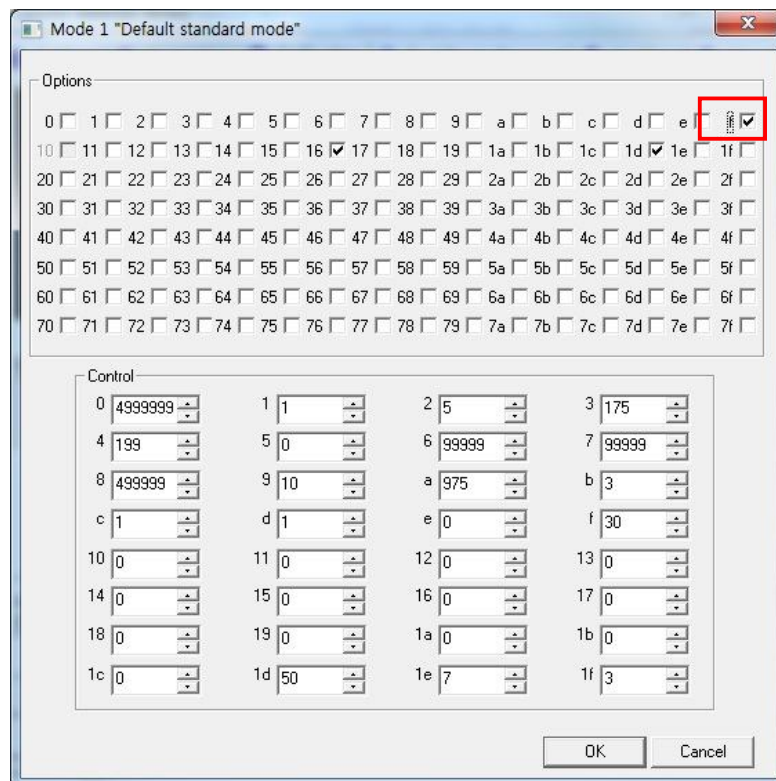
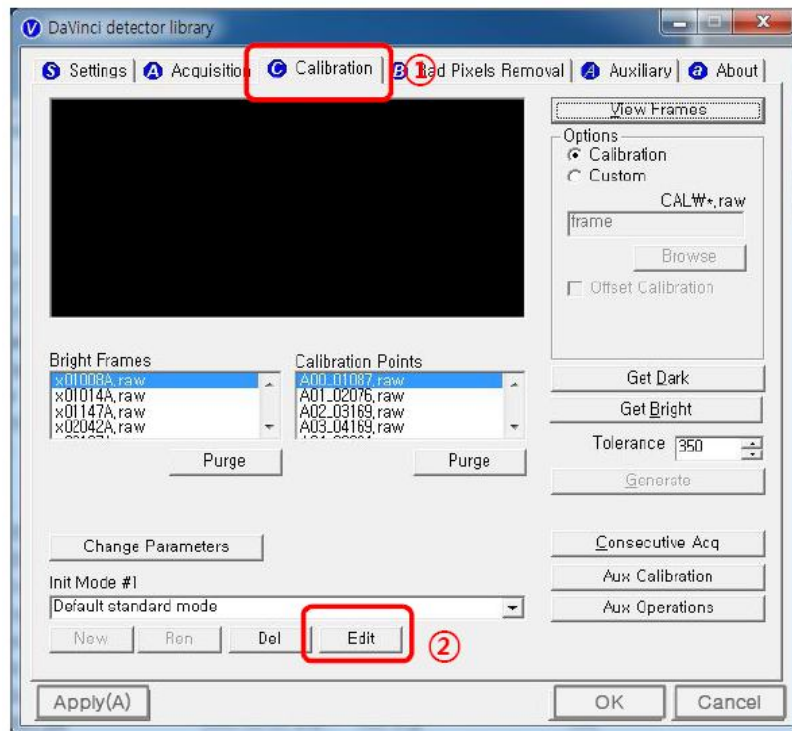

Figure 4: Davinci Setting

## Important Note

In AUTO TRIGGER MODE, the trigger will be forced not to acquire images when detector senses vibration or shock.

In READY mode, Detector will automatically switch to WAIT mode when detector senses vibration or shock, so that user won't acquire images in WAIT mode although X-ray exposure applies.

WAIT mode switches back to READY mode after 2-3 seconds.

If you don't want to use ANTI-SHOCK FUNCTION, please click OPTION "1c"

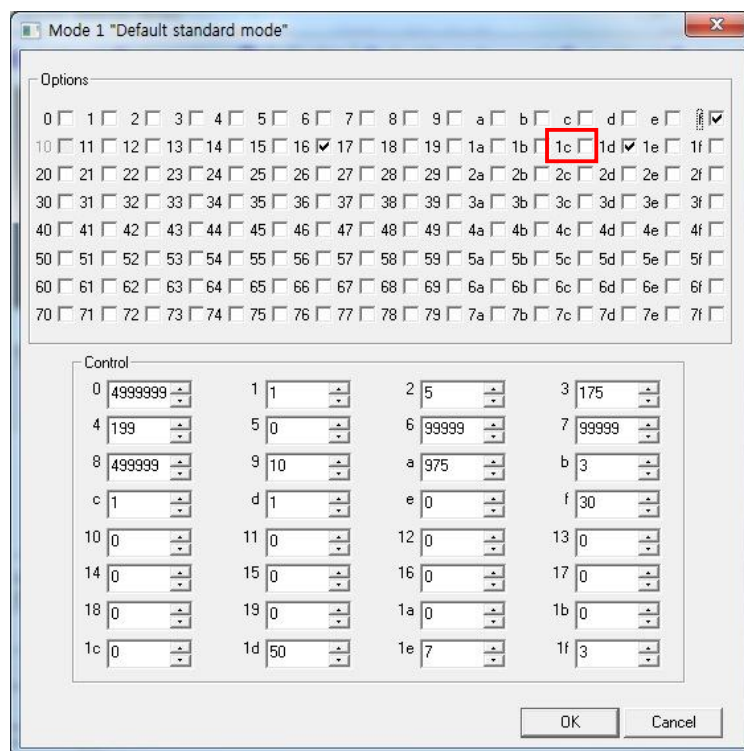

IF you don't use ANTI-SHOCK FUNCTION, you are able to get images regardless detector senses vibration or shock. However, you should keep in mind there is also a possibility images can be acquired by vibration or shock without X-ray exposure.

## (5) IP set up

[My Network Places] → [Properties] → [Local Area Connection]

→ [Properties] → [Internet Protocol (TCP/IP)]

→ [Use the following IP address]

IP address: Obtain an IP address automatically

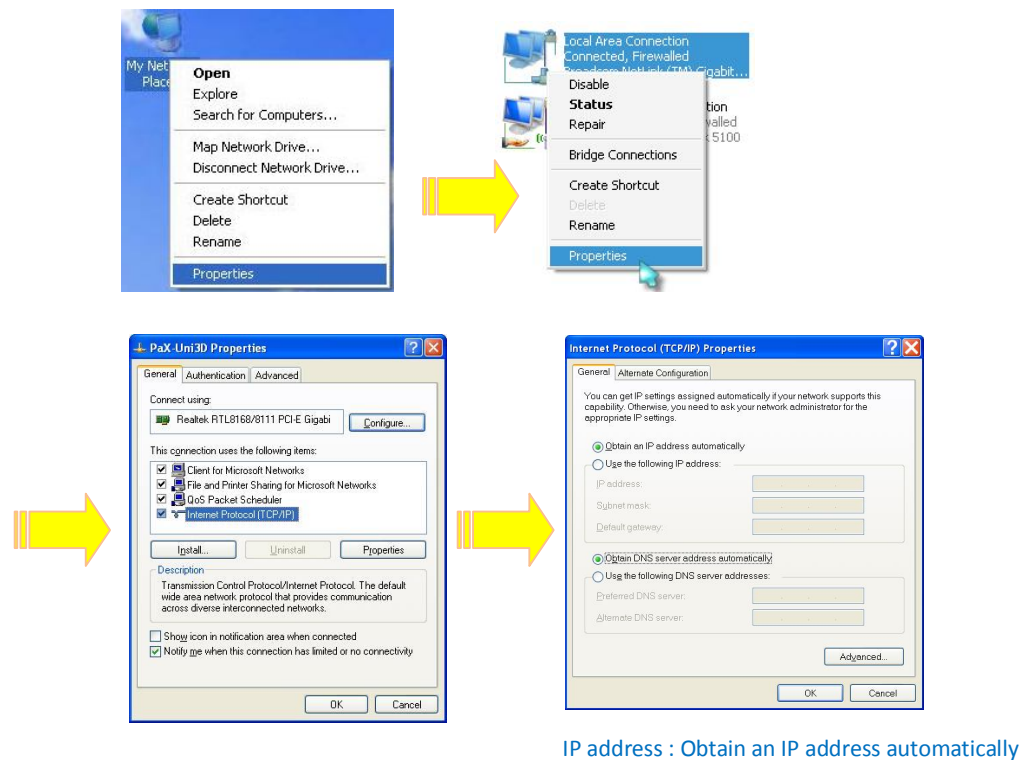

## (6) Using FPD\_Manager (IP, SSID Change / Upgrade FW)

### Change IP Address of Detector

- A. Turn on Detector and connect to PC  
(wired connection is recommended)
- B. After detector boot up, Launch FPD\_Manager.exe

The screenshot shows the 'FPD Updater for V-Panel 1G' window. It features several sections for configuration:

- IP Change:** Includes a 'Current Setting' section with 'Detector IP Address' set to '0 . 0 . 0 . 0'. Below it is a 'Change to' section with fields for 'Wired IP address', 'Subnet Mask', and 'Wireless IP address', all currently set to '0 . 0 . 0 . 0'.
- SSID Change:** Includes a 'Change to' section with fields for 'SSID' and 'PSK (Pre-Shared Key)'.
- Firmware/FPGA Update:** Includes an 'Uploading' progress bar, a 'Firmware' field with a 'Select' button, and an 'FPGA' field with a 'Select' button.

At the bottom of the window, there are two buttons: 'Start Setting' and 'Exit'.

C. Check the “IP Change” and type current IP address as below

FPD Updater for V-Panel 1G

IP Change

Current Setting

Detector IP Address 2 . 2 . 2 . 100

Change to

Wired IP address 0 . 0 . 0 . 0

Subnet Mask 0 . 0 . 0 . 0

Wireless IP address 0 . 0 . 0 . 0

SSID Change

Change to

SSID

PSK (Pre-Shared Key)

Firmware/FPGA Update

Uploading

Firmware

FPGA

Select

Select

Start Setting

Exit

D. Type IP address to set

FPD Updater for V-Panel 1G

IP Change

Current Setting

Detector IP Address 2 . 2 . 2 . 100

Change to

Wired IP address 10 . 1 . 1 . 100

Subnet Mask 255 . 255 . 255 . 0

Wireless IP address 10 . 1 . 1 . 101

SSID Change

Change to

SSID

PSK (Pre-Shared Key)

Firmware/FPGA Update

Uploading

Firmware

FPGA

Select

Select

Start Setting

Exit

- E. Click “Start Setting” button
- F. Restart detector(Turn Off then On)

### **Change SSID and PSK(Pre-Shared Key)**

- A. Turn on Detector and connect to PC  
(wired connection is recommended)
- B. After detector boot up, Launch FPD\_Manager.exe

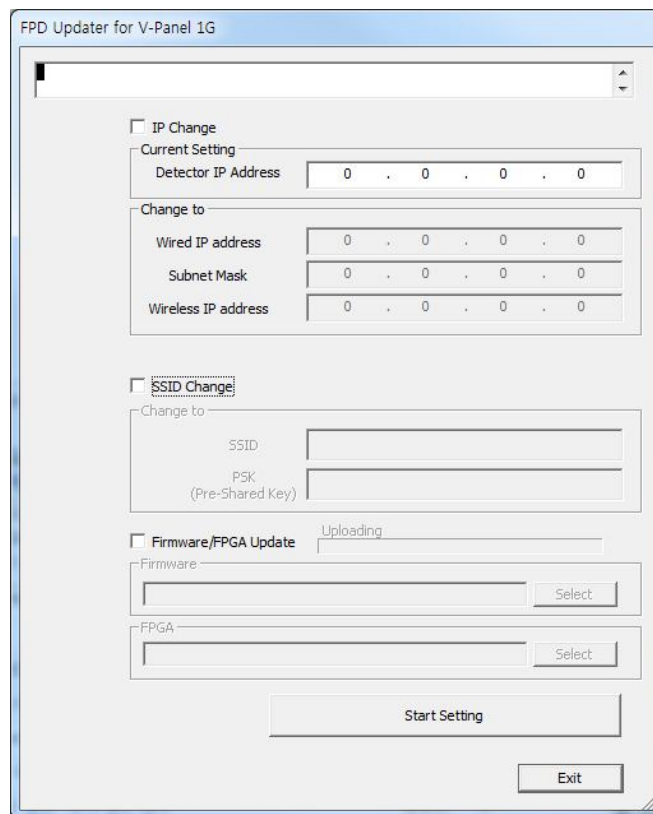

C. Check the “SSID change” and write current IP address as below

FPD Updater for V-Panel 1G

IP Change

Current Setting

Detector IP Address 2 . 2 . 2 . 100

Change to

Wired IP address 10 . 1 . 1 . 100

Subnet Mask 255 . 255 . 255 . 0

Wireless IP address 10 . 1 . 1 . 101

SSID Change

Change to

SSID

PSK (Pre-Shared Key)

Firmware/FPGA Update

Uploading

Firmware

FPGA

Select

Select

Start Setting

Exit

D. Type SSID and PSK to set

FPD Updater for V-Panel 1G

IP Change

Current Setting

Detector IP Address 2 . 2 . 2 . 100

Change to

Wired IP address 10 . 1 . 1 . 100

Subnet Mask 255 . 255 . 255 . 0

Wireless IP address 10 . 1 . 1 . 101

SSID Change

Change to

SSID Rayence

PSK (Pre-Shared Key) rayence001

Firmware/FPGA Update

Uploading

Firmware

FPGA

Select

Select

Start Setting

Exit



- E. Click “Start Setting” button
- F. Restart detector(Turn Off then On)

### Upgrade Firmware

- A. Turn on Detector and connect to PC  
(wired connection is recommended)
- B. After detector boot up, Launch FPD\_Manager.exe

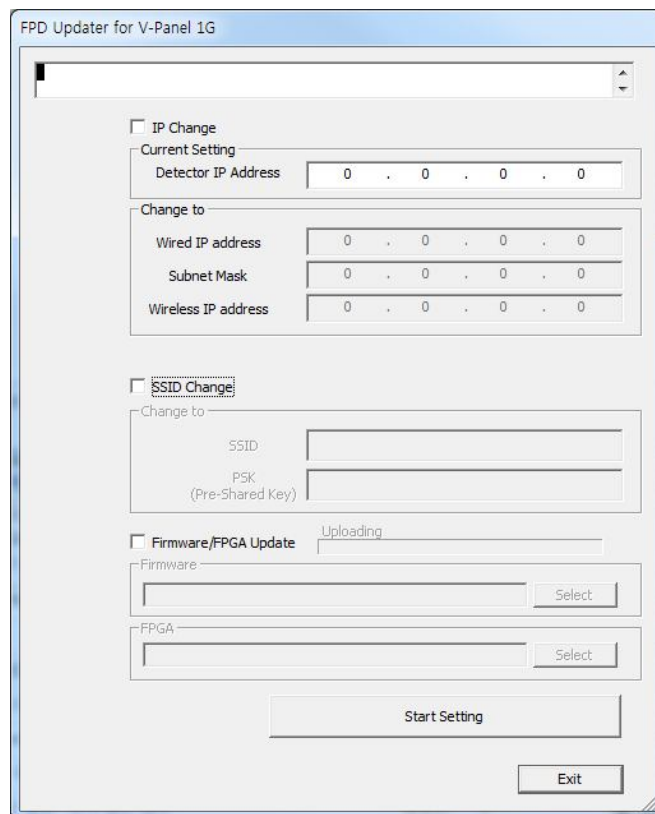

- C. Check the “SSID change” and write current IP address as below

FPD Updater for V-Panel 1G

IP Change

Current Setting

Detector IP Address 2 . 2 . 2 . 100

Change to

Wired IP address 10 . 1 . 1 . 100

Subnet Mask 255 . 255 . 255 . 0

Wireless IP address 10 . 1 . 1 . 101

SSID Change

Change to

SSID Rayence

PSK (Pre-Shared Key) rayence001

Firmware/FPGA Update Uploading

Firmware

FPGA

- D. Select firmware or FPGA file by click “select” button.  
Click “Start Setting” button

- E. Restart detector(Turn Off then On)

# 5. Calibration



X-ray detector should be used at stable state within driving temperature range. Acquire the X-ray images after power on and 5 minutes warming up to obtain high quality images.

## (1) General Principle

### Notation

Calibration can be done by image acquisition S/W. The gain-offset correction (under calibration) will be done with one dark, at least one bright and object frame.

Parameter	Description
Offset	Dark image, acquired image without X-ray exposure
Bright	Acquired image with X-ray exposure
Object	Bright image with object, will be calibrated
Gain	Gain of imaging system, offset subtracted image
Offset correction	Offset subtract
Gain correction	Compensate gain variance of pixel

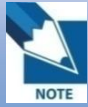

The calibration range of bright is can be select by which exposure level is maximum level that user want to use. If the maximum level of user want to use is '6500' in this case the level is contained in Bright point of '3'(refer 'Table 5 : Median value'). The meaning is you don't have to make bright point for '4'(In this case, it will be does not working if you get image on higher level than maximum bright point.)

## Bright Calibration Point

To gain correction, bright frame and dark frame should be acquired. The dark frame is needed only one frame. The bright frame is recommended to be acquired more than 2 different levels of median values of bright frames. The X-ray source condition will be recommended the tube energy level of 70kVp with variable tube current and exposure time. To acquire at least 2 frames at same condition will be recommended. The median values of bright frames are below.

(Additional 21mm Al filter is recommended for calibration)

Point	1	2	3	4
Median Value [LSB]	500~ 1000	2900~ 3400	6200~ 6700	9500~ 10000

Table 5 : Median value

## The Purpose of Bright Calibration

The center of the non calibrated image is brighter than the edge due to hill effect of X-ray exposure. Generally, the intensity of X-ray flux at center region of exposed area is higher than surroundings due to the X-ray expose like cone shape. A calibration process is used to compensate for this effect. Generally, called it 'Flat Field Correction'(Bright calibration).

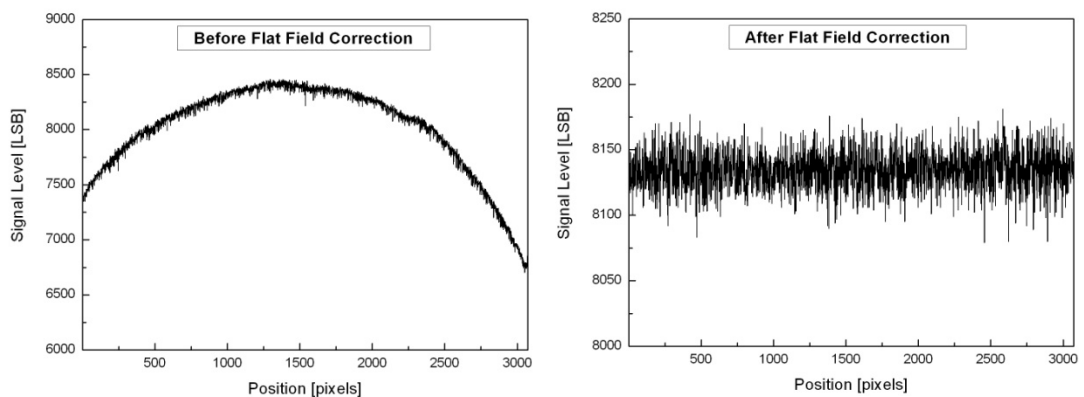

## (2) Calibration

Describe the calibration step by step.

### 1st Step

Click on the “Get Dark” button. The acquired dark frame “dark.raw” will be generated in the “\cal\” folder.

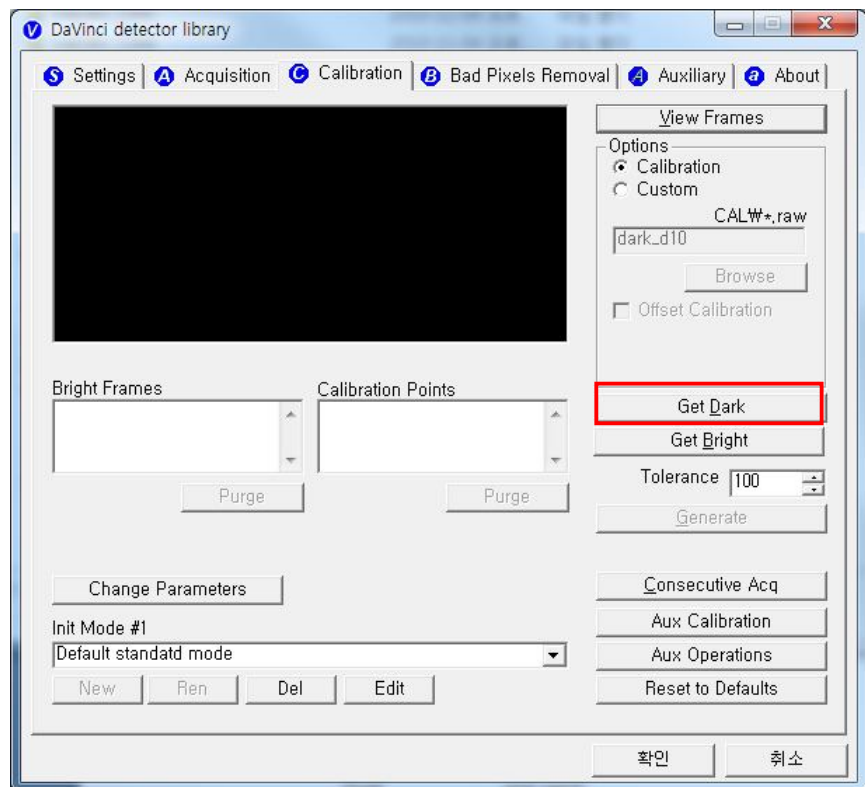

Figure 5: Get dark



Click button [Get Bright]. It will produce *frame* with name %CAL% xNNNNNA.raw, where NNNNN is median pixel's value within current *image* borders after offset calibration (cut frame edges are never used during calibration). Suffix 'A' (it also could be 'B', 'C' etc) avoids casual coincidence of file names.

## 2nd Step

Push "Get Bright" button at different four of X-ray condition. The X-ray condition should be set or tested before, same as the level of '1.2'. Push "Get Bright" button at least 2 times at same condition, and then the offset subtracted bright (gain) is generated which of filename is "xNNNNNA.raw(Refer to NOTE)

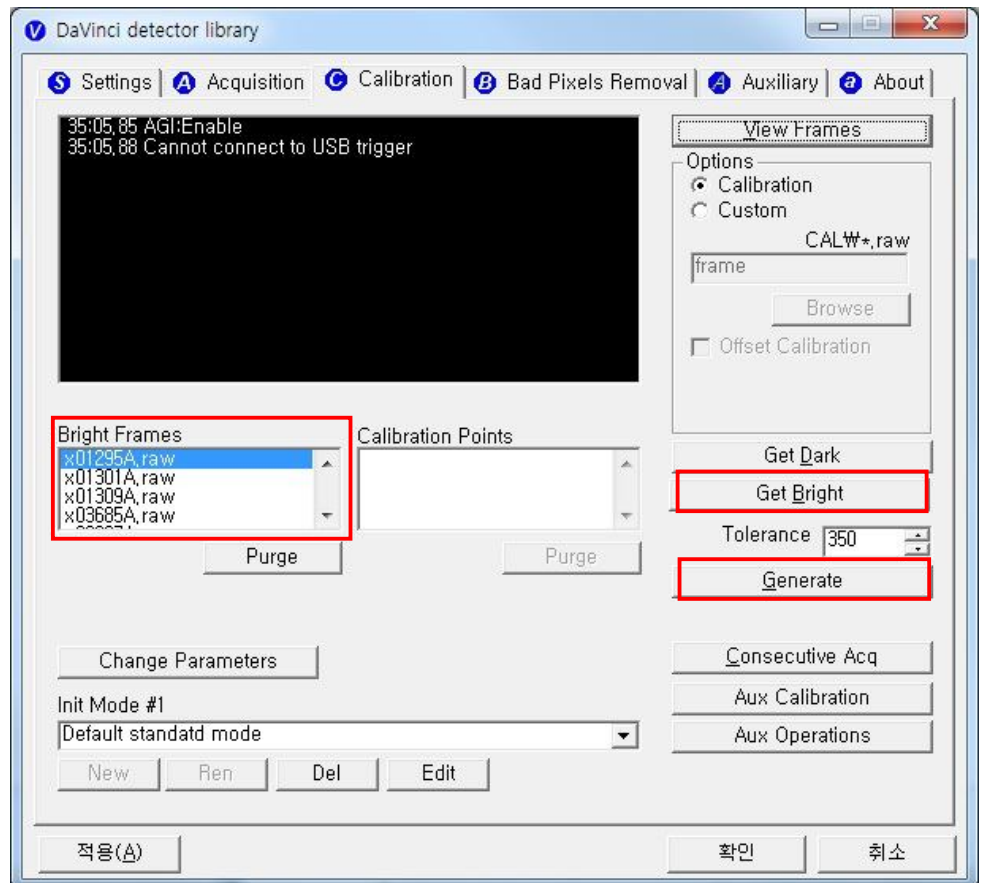

Figure 6: Get bright.

### 3rd step

After 2<sup>nd</sup> step, the “Generate” button will be activated. Click the button “Generate”, and then calibration point will be generated which of file name is “A ‘# of point’\_ ‘median value of generated point’” like file of bright frame. The acquired bright frames within tolerance value which is variance of median level of acquired bright frames will be averaged and generated to a calibration point. The tolerance value can be edited.

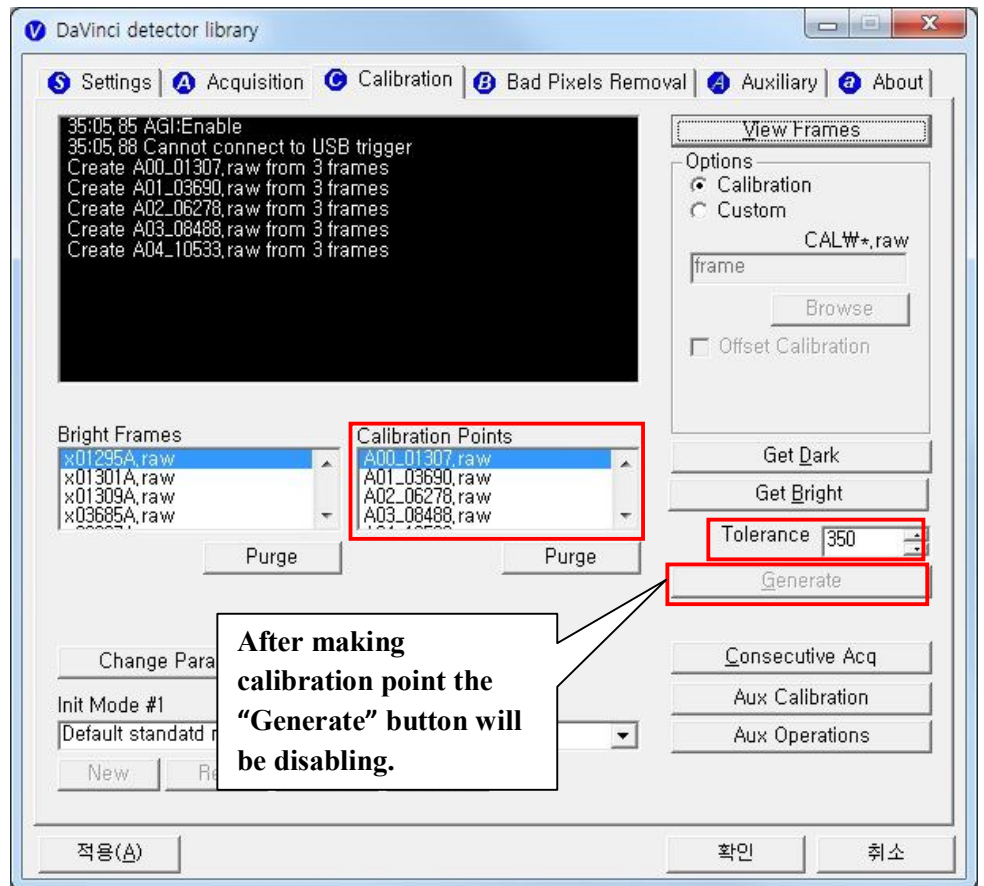

Figure 7: Generate

## 4th step

After 3rd step, Change Bad Pixels Removal Tab, Click the button “Generate Auto BPM”, and then Defect Map will be generated which of file name is “BPM.raw “ at the “cal\” folder.

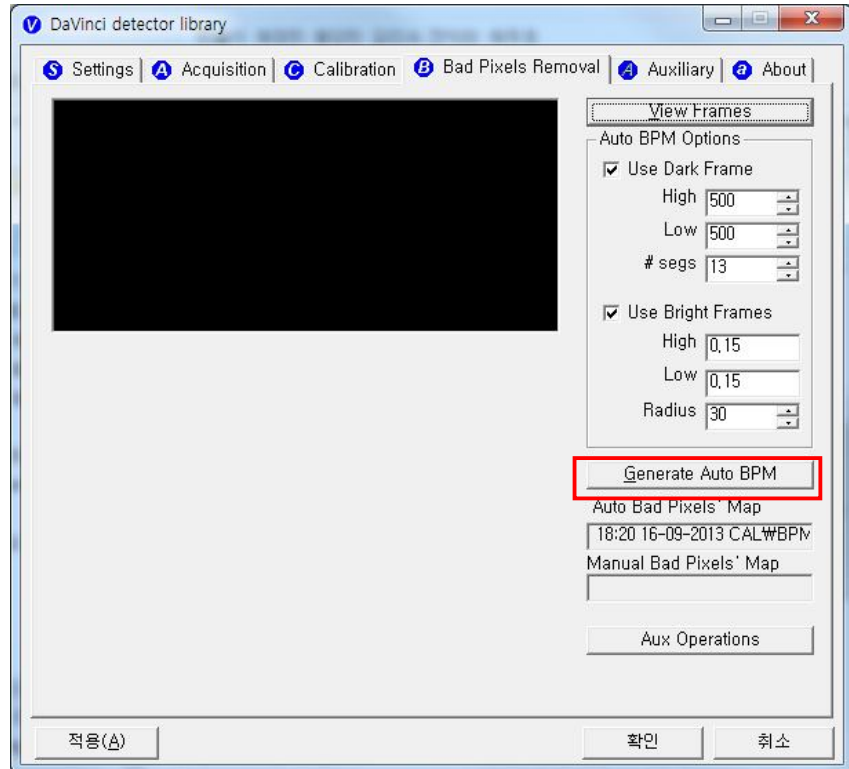

Figure 8: Bad pixels removal



## 5th step

For additional Defect correction, if “BPMM.raw” is existed at the install CD, copy to the “\cal\” folder.

## 6th step

On Acquisition Tab. Check the box “Offset Calibration”, “Gain Calibration”, “Bad Pix Map” for activate to each calibration and Bad Pixels Removal. Otherwise, it will does not working when going to pre-processing .

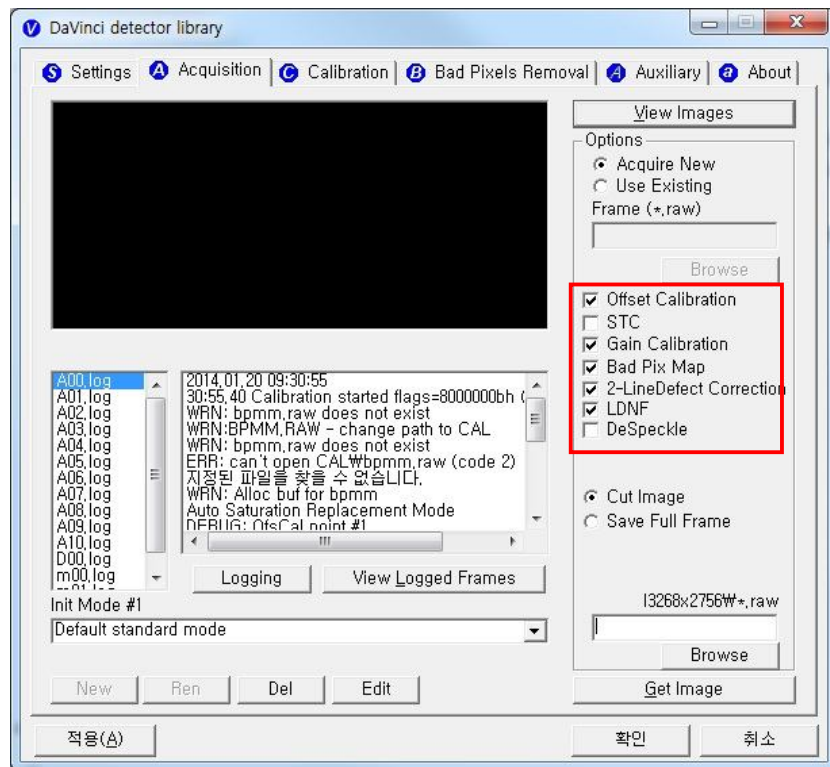
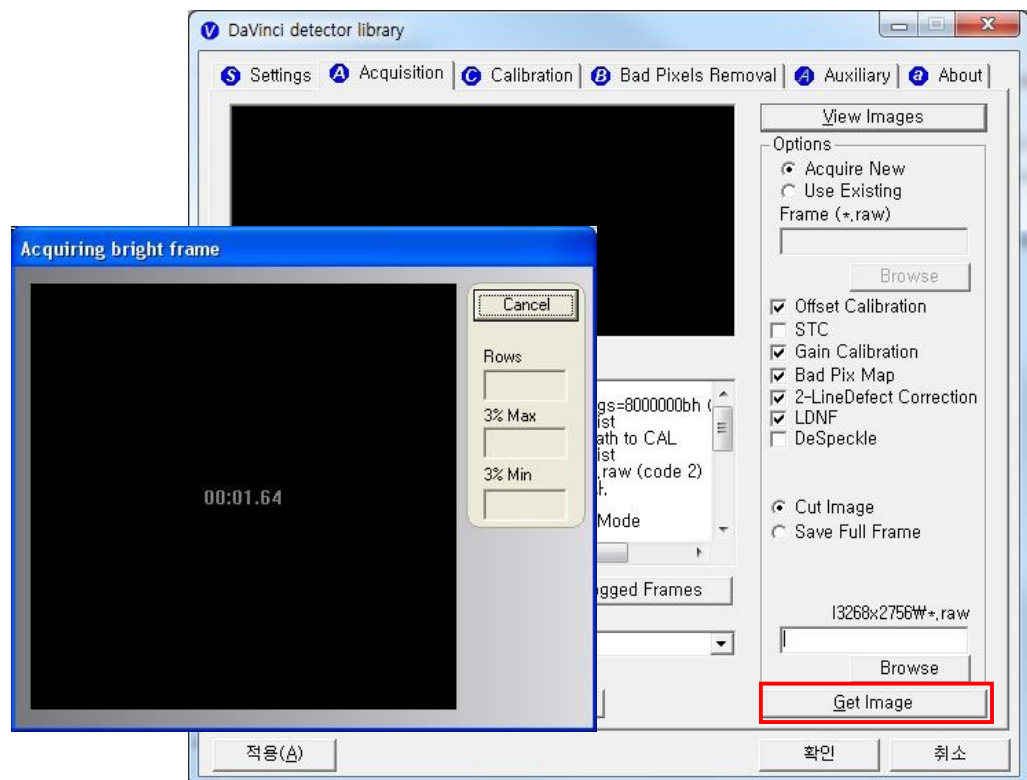

Figure 9: Application of calibration

# 6. Image Acquisition Test

## (1) Get Image

On Acquisition tab, click the “Get Image” button to get image. After click the button, you can see pop-up window, which is display window time and process of acquiring image.



## (2) View Images

Frame- and image-files have extension “raw” and contain pixel data in signed 16-bits little-endian format. One could view those files in Photoshop or another image editor.

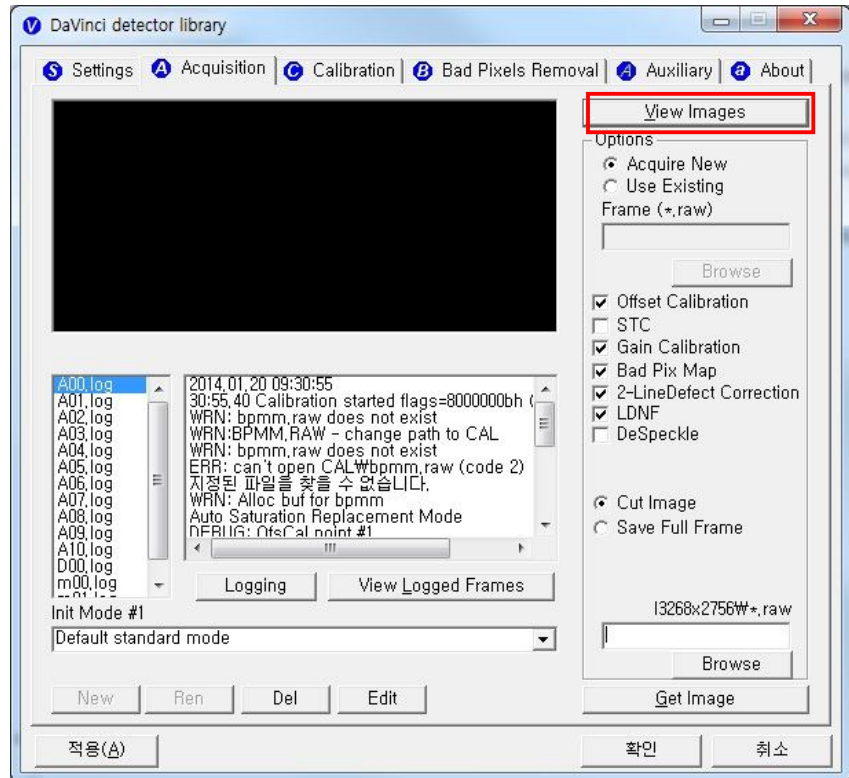

## Common controls and displayed statistics

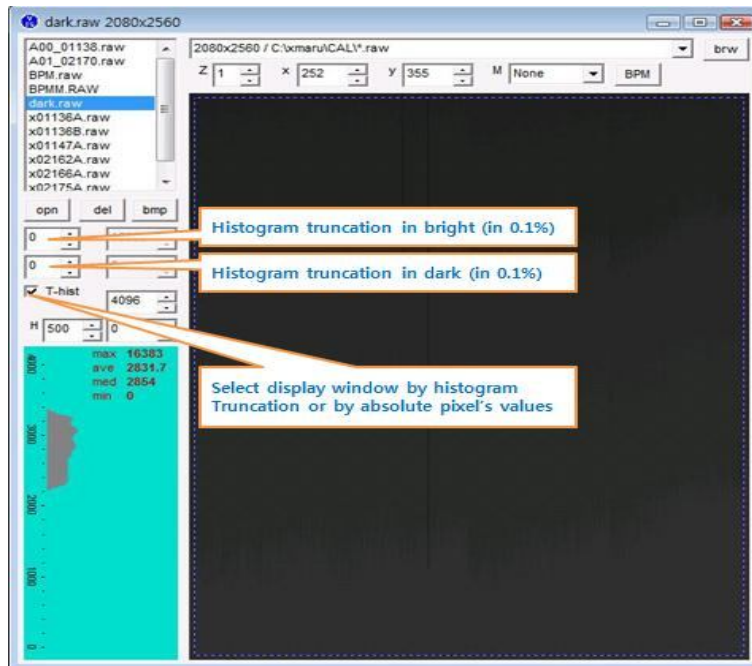

- Pixel\_Min – minimum pixel value in frame- or image- data
- Pixel\_Max – maximum pixel value
- Pixel\_Black – if a pixel  $\leq$  Pixel\_Black then it is displayed as black (RGB 0, 0, 0)
- Pixel\_White – if a pixel  $\geq$  Pixel\_White then it is displayed as white (RGB 255, 255, 255)

## Histogram's presentation

Relative Histogram Scale  $[H]=1000$  means that the distance depicted as “**H**” on the drawing matches 1% of total number of pixels. Respectively  $[H]=100$  means that “**H**” matches 0.1% of pixels and  $[H]=500$  means that “**H**” matches 0.5% of pixels.

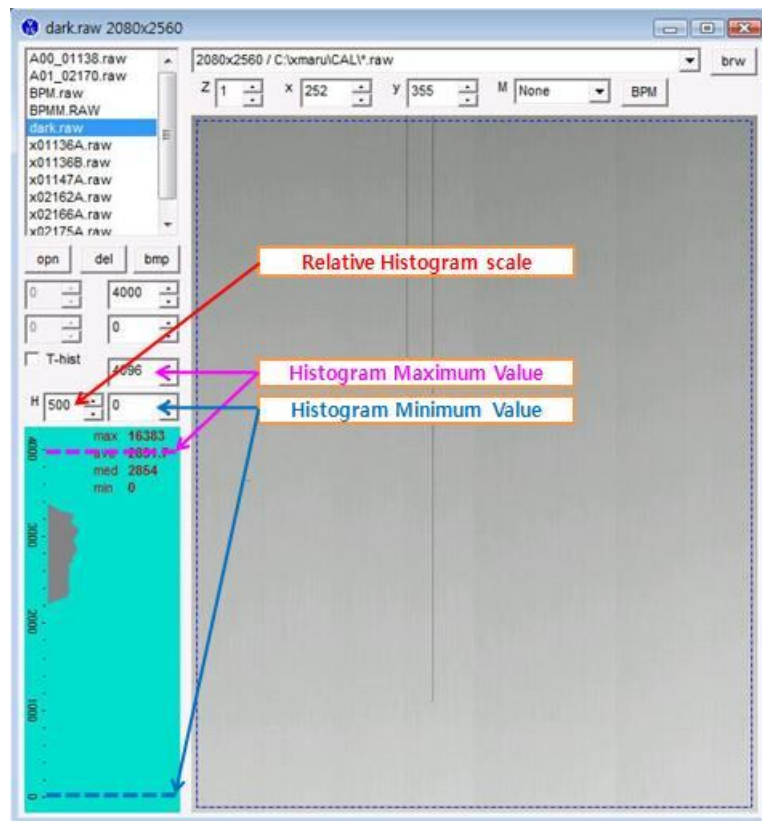

## Marker type "S"

Displays local surround of selected location

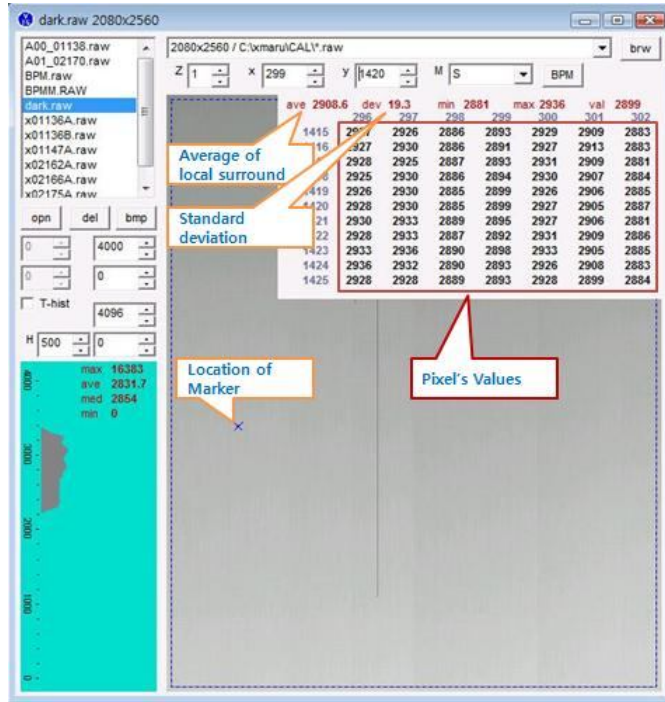

## Marker type "R"

Display profile chart of a row.

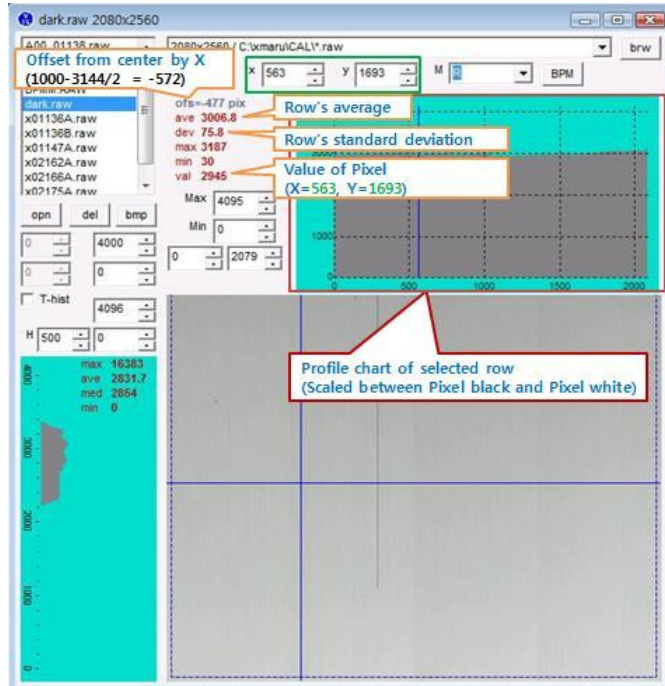

## Marker type "C"

Display profile chart of a column.

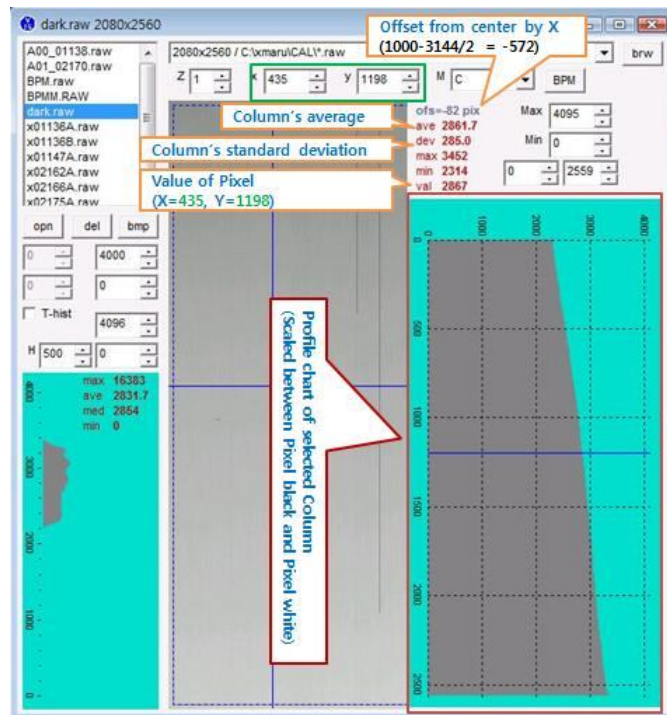

### (3) Get Recent Frame

If the image is not transferred to the PC after exposure because of connection fail (wire or wireless). You can get a recent frame again.

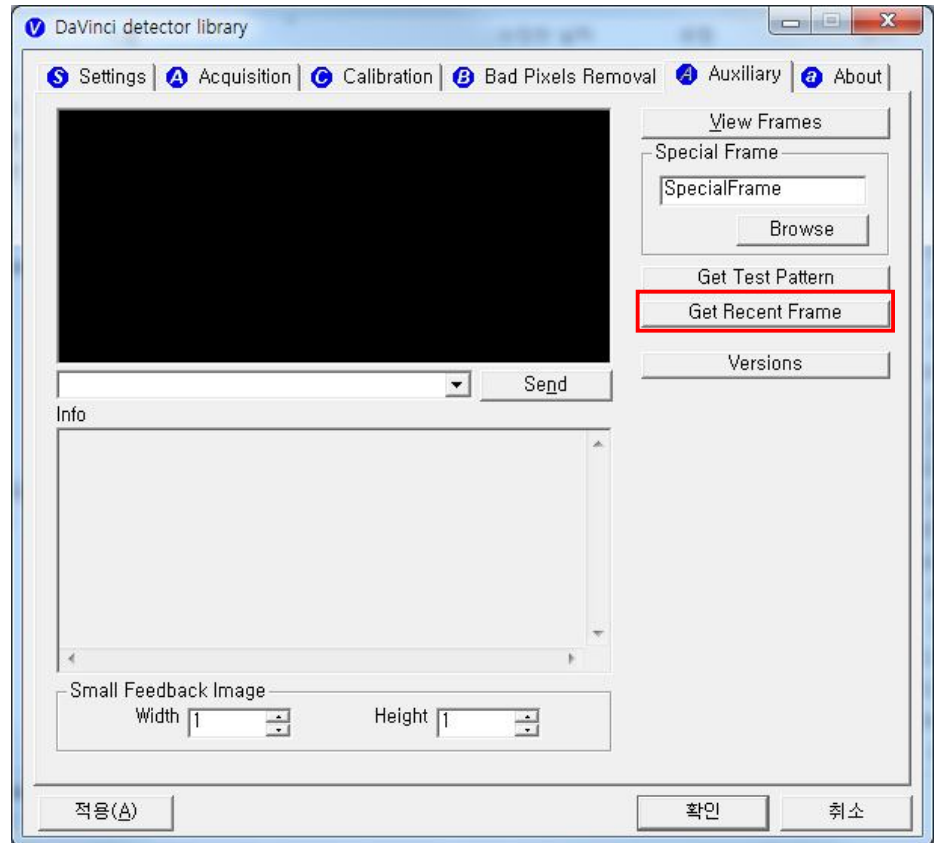



# 7. Operation

## (1) Recommend

X-ray detector should be used at stable state within driving temperature range.

Acquire the X-ray images after power on and 5 minutes warming up to obtain high quality images.

The calibration should be performed every 6 months

## (2) Switching power on / off

- All connection should be done, before turn on the power.
- Press the power button by more than 3 sec, when power on/off.
- The green light of the LED indicator on the detector is on, the detector power is on.
- The blue light of the LED indicator on the detector is blinking, the detector is getting prepared to work and initialize.
- After power off, separate the battery.

## (3) Storage

Store the sensor unit in clean and dry place. Ensure that storage place should be not affected by dust or liquids.

# 8. Safety Information



Do not touch signal

input, signal output or other connectors, and the patient simultaneously. External equipment intended for connection to signal input, signal output or other connectors, shall comply with relevant IEC Standard.

## (1) Safety standard

This equipment has been tested and found to comply with the limits for medical devices in IEC 60601-1-2:1994. These limits are designed to provide reasonable protection against harmful interference in a typical medical installation.

This equipment generate, uses and can radiate radio frequency energy and, if not installed and used in accordance with the instructions, may cause harmful interference to other devices in the vicinity. However, there is no guarantee that interference will not occur in a particular installation. If this equipment does cause harmful interference to other devices, which can be determined by turning the equipment off and on, the user is encouraged to try to correct the interference by one or more of the following measures:

- Reorient or relocate the receiving device.
- Increase the separation between the equipment.
- Connect the equipment into an outlet on a circuit different from that to which the other devices are connected.
- Consult the manufacturer or field service technician for help (e.g., IEC 60950-1 for IT equipment and IEC 60601-1 series for medical electrical equipment.)

In addition, all such combination system shall comply with the standard IEC 60601-1 and/or IEC 60601-1 harmonized national standard or the combination. If, in doubt, contact qualified technician or your local representative.

- Type of protection against electric shock: Class I equipment
- Classification according to the degree of protection against ingress of water as detailed in the current edition of IEC 529: IPX0, ordinary equipment
- This equipment is not suitable for use in the presence of flammable anesthetics or oxygen.
- Mode of operation: continuous operation

## (2) Electromagnetic Compatibility Information

### Guidance and manufacturer's declaration - electromagnetic emissions

<p>The EUT is intended for use in the electromagnetic environment specified below. The customer or the user of the EUT should assure that it is used in such an environment.</p>		
Immunity Test	Compliance	Electromagnetic Environment - Guidance
RF Emissions CISPR 11	Group 1	The EUT uses RF energy only for its internal function. Therefore, its RF emissions are very low and are not likely to cause any interference in nearby electronic equipment
RF Emissions CISPR 11	Class A	The EUT is suitable for use in all establishments, including domestic establishments and those directly connected to the public low-voltage power supply network that supplies buildings used for domestic purposes
Harmonic emissions IEC 61000-3-2	Complies	The EUT is suitable for use in all establishments, including domestic establishments and those directly connected to the public low-voltage power supply network that supplies buildings used for domestic purposes
Voltage fluctuations/ Flicker emissions  IEC 61000-3-3	Complies	The EUT is suitable for use in all establishments, including domestic establishments and those directly connected to the public low-voltage power supply network that supplies buildings used for domestic purposes

## Guidance and manufacturer's declaration - electromagnetic immunity

The EUT is intended for use in the electromagnetic environment specified below.

The customer or the user of the EUT should assure that it is used in such an environment.

The EUT is intended for use in the electromagnetic environment specified below. The customer or the user of the EUT should assure that it is used in such an environment.			
Immunity test	IEC 60601-1-2 Test level	Compliance level	Electromagnetic environment - guidance
Electrostatic discharge (ESD) IEC 61000-4-2	±6kV Contact ±8kV air	±6kV Contact ±8kV air	Floors should be wood, concrete or ceramic tile. If floors are covered with synthetic material, the relative humidity should be at least 30%.
Electrical fast transient/burst IEC 61000-4-4	±2kV for power supply lines ± 1kV for input/output lines	±2kV for power supply lines ± 1kV for input/output lines	Mains power quality should be that of a typical commercial or hospital environment.
Surge IEC 61000-4-5	±1kV differential mode ±2kV common mode	±1kV differential mode ±2kV common mode	Mains power quality should be that of a typical commercial or hospital environment.
Voltage dips, short interruptions and voltage variations on power supply input lines IEC 61000-4-11	<5% $U_T$ (>95% dip in $U_T$ ) for 0.5 cycle 40% $U_T$ (60% dip in $U_T$ ) for 5 cycle 70% $U_T$ (30% dip in $U_T$ ) for 25 cycle <5% $U_T$ (<95% dip in $U_T$ ) for 5 s	<5% $U_T$ (>95% dip in $U_T$ ) for 0.5 cycle 40% $U_T$ (60% dip in $U_T$ ) for 5 cycle 70% $U_T$ (30% dip in $U_T$ ) for 25 cycle <5% $U_T$ (<95% dip in $U_T$ ) for 5 s	Mains power quality should be that of a typical commercial or hospital environment. If the user of the EUT image intensifier requires continued operation during power mains interruptions, it is recommended that the EUT image intensifier be powered from an uninterruptible power supply or a battery.
Power frequency (50/60Hz) magnetic field IEC 61000-4-8	3 A/m	3 A/m	Power frequency magnetic fields should be at levels characteristic of a typical location in a typical commercial or hospital environment.
NOTE $U_T$ is the a.c. mains voltage prior to application of the test level.			

## Guidance and manufacturer's declaration - electromagnetic immunity

The EUT is intended for use in the electromagnetic environment specified below.

The customer or the user of the EUT should assure that it is used in such an environment.

Immunity test	IEC 60601-1-2 test level	Compliance level	Electromagnetic environment - guidance
<p>Conducted RF IEC 61000-4-6</p> <p>Radiated RF IEC 61000-4-3</p>	<p>3 Vrms 150 kHz to 80MHz</p> <p>3 V/m 80 MHz to 2.5GHz</p>	<p><math>V_1=3V_{rms}</math></p> <p><math>E_1=3V/m</math></p>	<p>Portable and mobile RF communications equipment should be used no closer to any part of the EUT, including cables, than the recommended separation distance calculated from the equation applicable to the frequency of the transmitter.</p> <p><b>Recommended separation distance :</b></p> $d = \left[ \frac{3.5}{V_1} \right] \sqrt{P}$ $d = \left[ \frac{3.5}{E_1} \right] \sqrt{P} \quad 80\text{MHz to } 800\text{MHz}$ $d = \left[ \frac{7}{E_1} \right] \sqrt{P} \quad 800\text{MHz to } 2.5\text{GHz}$ <p>where P is the maximum output power rating of the transmitter in watts (W) according to the transmitter manufacturer and d is the recommended separation distance in meters (m). Field strengths from fixed RF transmitters, as determined by an electromagnetic site survey,<sup>a</sup> should be less than the compliance level in each frequency range.<sup>b</sup> Interference may occur in the vicinity of equipment marked with the following symbol :</p> 

NOTE 1) At 80MHz and 800MHz, the higher frequency range applies.

NOTE 2) These guidelines may not apply in all situations. Electromagnetic propagation is affected by absorption and reflection from structures, objects and people.

<sup>a</sup> Field strengths from fixed transmitters, such as base stations for radio (cellular/cordless) telephones and land mobile radios, amateur radio, AM and FM radio broadcast and TV broadcast cannot be predicted theoretically with accuracy. To assess the electromagnetic environment due to fixed RF transmitters, an electromagnetic site survey should be considered. If the measured field strength in the location in which the EUT is used exceeds the applicable RF compliance level above, the EUT should be observed to verify normal operation. If abnormal performance is observed, additional measures may be necessary, such as re-orienting or relocating the EUT.

<sup>b</sup> Over the frequency range 150kHz to 80MHz, field strengths should be less than  $[V_1]$  V/m.

## Recommended separation distances between portable and mobile RF communications equipment and the EUT

There is intended for use in an electromagnetic environment in which radiated RF disturbances are controlled. The customer or the user of the EUT can help Prevent electromagnetic interference by maintaining a minimum distance between portable and mobile RF communications equipment (transmitters) and the EUT as recommended below, according to the maximum output power of the communications equipment.

Separation distance according to frequency of transmitter [m] IEC 60601-1-2			
Frequency of Transmitter	150kHz to 80MHz	80MHz to 800MHz	800MHz to 2.5GHz
Equation	$d = \left[ \frac{3.5}{V_1} \right] \sqrt{P}$	$d = \left[ \frac{3.5}{E_1} \right] \sqrt{P}$	$d = \left[ \frac{7}{E_1} \right] \sqrt{P}$
Rated maximum output power of transmitter [W]	$V_1=3V_{rms}$	$E_1=3V/m$	$E_1=3V/m$
	Separation Distance (meters)	Separation Distance (meters)	Separation Distance (meters)
0.01	0.116	0.1166	0.2333
0.1	0.368	0.3687	0.7378
1	1.166	1.1660	2.3333
10	3.687	3.6872	7.3785
100	11.660	11.6600	23.333

For transmitters rated at a maximum output power not listed above, the recommended separation distance d in meters (m) can be estimated using the equation applicable to the frequency of the transmitter, where p is the maximum output power rating of the transmitter in watts (W) according to the transmitter manufacturer.

NOTE 1) At 80MHz and 800MHz, the separation distance for the higher frequency range applies.  
NOTE 2) These guidelines may not apply in all situations. Electromagnetic propagation is affected by absorption and reflection from structures, objects and people.

<sup>a</sup> Field strengths from fixed transmitters, such as base stations for radio (cellular/cordless) telephones and land mobile radios, amateur radio, AM and FM radio broadcast and TV broadcast cannot be predicted theoretically with accuracy. To assess the electromagnetic environment due to fixed RF transmitters, an electromagnetic site survey should be considered. If the measured field strength in the location in which the EUT is used exceeds the applicable RF compliance level above, the EUT should be observed to verify normal operation. If abnormal performance is observed, additional measures may be necessary, such as re-orienting or relocating the EUT.

<sup>b</sup> Over the frequency range 150kHz to 80MHz, field strengths should be less than [V1] V/m.

Name	Shield Type	Length	Notes
Link cable	Shielded	6 m	Provided with wiring unit.
P-interface cable	Non-shielded	8 m	Provided with X-ray interface unit.
USB cable (A to B)	Non-shielded	1.8 m	Provided with AGI unit.
AC power cord (220V)	Shielded	1.8 m	Provided with charger unit.

## Immunity and Compliance Level

Immunity test	IEC 60601-1-2 Test Level	Actual Immunity Level	Compliance Level
Conducted RF IEC 61000-4-6	3Vrms 150kHz to 80MHz	3Vrms	3Vrms
Radiated RF IEC 61000-4-3	3Vrms 80MHz to 2.5GHz	3V/m	3V/m

### Guidance and manufacturer's declaration - electromagnetic immunity

The EUT is intended for use in the electromagnetic environment specified below.

The customer or the user of the EUT should assure that it is used in such an electromagnetic environment.

Immunity test	IEC 60601-1-2 Test level	Compliance level	Electromagnetic environment - guidance
Conducted RF IEC 61000-4-6	3 Vrms 150kHz to 80MHz	3 Vrms 150 kHz to 80MHz	The EUT must be used only in a shielded location with a minimum RH shielding effectiveness nad, for each cable that enters the shielded location with a minimum RF shielding effectiveness and, for each cable that enters the shielded location.
Radiated RF IEC 61000-4-3	3V/m 80MHz to 2.5GHz	3V/m 80MHz to 2.5GHz	Field strengths outside the shielded location from fixed RF transmitters, as determined by an electromagnetic site survey, should be less than 3V/m. <sup>a</sup>  Interference may occur in the vicinity of equipment marked with the following symbol:  

NOTE 1) These guidelines may not apply in all situations. Electromagnetic propagation is affected by absorption and reflection from structures, objects and people.

NOTE 2) It is essential that the actual shielding effectiveness and filter attenuation of the shielded location be verified to assure that they meet the minimum specification.

<sup>a</sup> Field strengths from fixed transmitters, such as base stations for radio (cellular/cordless) telephones and land mobile radios, amateur radio, AM and FM radio broadcast and TV broadcast cannot be predicted theoretically with accuracy. To assess the electromagnetic environment due to fixed RF transmitters, an electromagnetic site survey should be considered. If the measured field strength outside the shielded location in which the EUT is used exceeds 3V/m, the EUT should be observed to verify normal operation.

If abnormal performance is observed, additional measures may be necessary, such as relocating the EUT or using a shielded location with a higher RF shielding effectiveness and filter attenuation.



# 9. Radio Frequency compliance

## (1) FCC Notice (U.S.A)

- **Test standards**

- 47CFR Part 15.107 (b) / 47CFR Part 15.109 (g) Class A.
- FCC Part 15 C Section 15.247, Operation within the bands 902–928 MHz, 2400–2483.5 MHz, and 5725–5850 MHz
- FCC Part 15 C Section 15.407, Operation within the bands 902–928 MHz, 2400–2483.5 MHz, and 5725–5850 MHz

- **FCC ID: QIIRY1417W**

5.15- 5.25 GHz band is restricted to indoor operations only.

Host device of the approved module shall be marked with the following item:

Contains Transmitter Module FCC ID: PPD-AR5BHB116

Compliance with FCC requirement 15.407(c)

Data transmission is always initiated by software, which is the passed down through the MAC, through the digital and analog baseband, and finally to the RF chip. Several special packets are initiated by the MAC. These are the only ways the digital baseband portion will turn on the RF transmitter, which it then turns off at the end of the packet. Therefore, the transmitter will be on only while one of the aforementioned packets is being transmitted. In other words, this device automatically discontinues transmission in case of either absence of information to transmit or operational failure.

This device complies with part 15 of the FCC Rules. Operation is subject to the following two conditions: (1) This device may not cause harmful interference, and (2) this device must accept any interference received, including interference that may cause undesired operation.

## FCC CAUTION

Changes or modifications not expressly approved by the party responsible for compliance could void the user's authority to operate the equipment. This transmitter must not be co-located or operated in conjunction with any other antenna or transmitter.

### When installing it in a mobile equipment

This equipment complies with FCC radiation exposure limits set forth for an uncontrolled environment and meets the FCC radio frequency (RF) Exposure Guidelines in Supplement C to OET65. This equipment has very low levels of RF energy that it deemed to comply without maximum permissive exposure evaluation (MPE). But it is desirable that it should be installed and operated keeping the radiator at least 20cm or more away from person's body (excluding extremities: hands, wrists, feet and ankles).

When you use the detector with wire mode, the wireless function is automatically off.

## **(2) IC Notice (CANADA)**

- **Test standards**

- ICES-003 Issue 4
- IC RSS-210 Issue 7, Operation within the bands 902–928MHz, 2400–2483.5 MHz, and 5725–5850 MHz
- IC RSS-210 Issue 7, Operation within the bands 902–928 MHz, 2400–2483.5 MHz, and 5725–5850 MHz

- **IC: 10742A-1417W**

This Class A digital apparatus complies with Canadian ICES-003

Host device of the approved module shall be marked with the following item:

Contains Transmitter Module Radio Certification No. : 4104A-AR5BHB116

This device complies with Industry Canada licence-exempt RSS standard(s). Operation is subject to the following two conditions: (1) this device may not cause interference, and (2) this device must accept any interference, including interference that may cause undesired operation of the device.

Le present appareil est conforme aux CNR d'Industrie Canada applicables aux appareils radio exempts de licence. L'exploitation est autorisee aux deux conditions suivantes : (1) l'appareil ne doit pas produire de brouillage, et (2) l'utilisateur de l'appareil doit accepter tout brouillage radioelectrique subi, meme si le brouillage est susceptible d'en compromettre le fonctionnement.

### **(3) R&TTE Notice (European Union)**

- **Test standards**
  - EN 62311
  - ETSI EN 301 489-1
  - ETSI EN 301 489-17
  - ETSI EN 300 328
  - ETSI EN 301 893

# 10. Maintenance



For safety reasons, be sure to turn OFF the power of the detector when the following inspections are going to be performed. Otherwise, it may result in electric shock.

## (1) Maintenance

- Maintenance of the detector should be done by an authorized service provider
- If the Detector Panel is defective, the detector will be returned as is to the manufacturer for repair
- Clean the equipment with a dry soft cloth, or a soft cloth lightly moistened with mild detergent solution. Do not use any type of solvent, such as benzene
- This equipment and accessories are to be disposed of safely after the life span of them and national regulation must be observed.
- For safety reasons, be sure to inspect the instrument before using it. In addition, carry out a regular inspection at least once a year.
- Arrange the detector and power supply link cable to prevent the damage of the cable's rubber tube. For example, do not press the cable under the legs of the table or the people.
- This equipment must only be connected to a supply mains with protective earth.



When the instrument is going to be cleaned, be sure to turn OFF the power of each instrument, and unplug the power cable from the AC outlet. Otherwise, fire or electric shock may result.

## (2) Cleaning

### Cover

Clean the cover by the left warning box, if it is dirty.

### CFRP of Detector

Wipe the CFRP plate of the sensor unit with ethanol or glutaraldehyde solution to disinfect it each time a different patient uses the instrument, in order to prevent infection. If you are using disinfectant other than those specified above, or you are mixing another disinfectant with ethanol, please also consult a specialist, because they may harm the CFRP plate.

### (3) Inspection

In order to ensure that the instrument is used safely and normally, please be sure to inspect the instrument before use. If any problem is found during the inspection, please take measures indicated in this chapter. If problem still cannot be corrected, please contact Rayence representative or distributor. It is recommended that a record of the inspection be kept by making copies of the check lists in this section, or making a separate check list.

#### Inspection chart

Inspection	User	Vendor	Cycle
Check that cables are not damaged or cover of cables is not torn	<input type="radio"/>		Daily
Check that the plugs and locks of connectors are not loose	<input type="radio"/>		Daily
Check that the cover or parts are not damaged and not loose	<input type="radio"/>		Daily
Check the LED indicator	<input type="radio"/>		Daily
Check the bad pixel map		<input type="radio"/>	Half year
Check the performance of the instrument by performing exposures using a phantom or a resolution chart		<input type="radio"/>	Yearly

## (4) Disposal or Recycling













Follow local governing ordinances and recycling plans regarding the disposal or recycling of device components.











Disposal of old Electrical & Electronic Equipment

(Application in the European Union and other European countries with separate collection system.) This symbol indicates that this product shall not be treated as household waste. Instead, it shall be handed over to the applicable collection point for the recycling of electrical and electronic equipment. By ensuring this product is disposed of correctly, you will help prevent potential negative consequences for the environment and human health, which could otherwise be caused by inappropriate waste handling of this product. For more detailed information about recycling this product, please refer to local governing ordinances and recycling plans.

## (5) Marking and labeling symbols

Symbols	Meaning
	Caution : "Attention, see instructions for use"
	Alternate current
	Protective earth (Ground)
	Off (power : disconnect from the main switch)
	On (power : connect to the main switch)
	Warning
	Caution
	Note
	Manufacturer
	Date of manufacture
	Serial number
	TYPE B Equipment



	<p>WEEE : Waste Electrical and Electronic Equipment</p>
	<p>Authorized representative in the European Community</p>
	<p>CE symbol grants the product compliance to the European Directive for Medical Devices 93/42/EEC as a class IIb device and 1999/5/EC. Authorized by <b>Notified Body SGS (code no.:0120) of British</b></p>
	<p>Recognized Component Mark for Canada and the United States</p>
	<p>non-ionizing radiation</p>
	<p>For KOREA Korea Certification</p>
	<p>For JAPAN Product Safety of Electrical Appliance &amp; Materials</p>
	<p>For JAPAN Telecom Engineering Center (TELEC) : Technical Regulations Conformity Certification</p>

# Appendix

Dimension

[unit : mm]

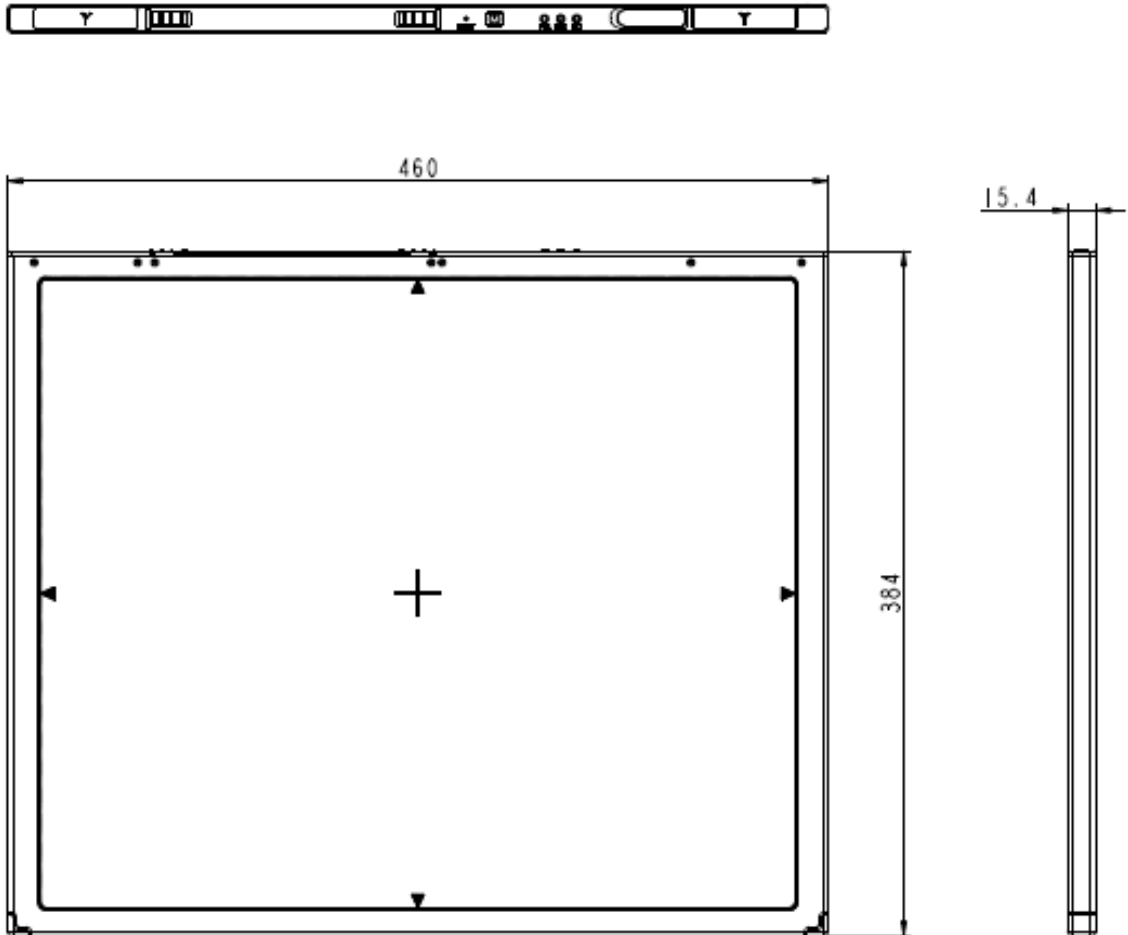



**VATECH Dental Manufacturing Ltd.**

Axion House, The Centre Feltham,  
Middlesex, TW134AU, United Kingdom  
Tel : +44-20-8831-1660 Fax : +44-20-8831-1679



**Rayence Co., Ltd.**

14, Samsung 1-ro 1-gil, Hwaseong-si, Gyeonggi-do, Korea

[www.rayence.com](http://www.rayence.com)



**Rayence Co., Ltd.**

14, Samsung 1-ro 1-gil, Hwaseong-si, Gyeonggi-do, Korea

[www.rayence.com](http://www.rayence.com)