



# TEST REPORT FROM RADIO FREQUENCY INVESTIGATION LTD.

Test Of: Nokia UK Ltd.  
Cameron Imaging Phone 3650 (NHL-8)  
Mobile Phone Handset

To: FCC Part 24: 2001, FCC Part 15: 2001  
and Part 2: 2001

**Test Report Serial No:**  
RFI/MPTB3/RP70413JD06A

**Supersedes Test Report Serial No:**  
RFI/MPTB1/RP70413JD06A &  
RFI/MPTB2/RP70413JD06A

<b>This Test Report Is Issued Under The Authority Of Richard Jacklin, Operations Director:</b> 	<b>Checked By:</b> 
<b>Tested By:</b> 	<b>Release Version No: PDF01</b>
<b>Issue Date: 23 December 2002</b>	<b>Test Dates: 19 November 2002 to 26 November 2002</b>

This report is issued in Adobe Acrobat portable document format (PDF). It is only a valid copy of the report if it is being viewed in PDF format with the following security options not allowed: Changing the document, Selecting text and graphics, Adding or changing notes and form fields. Furthermore, the date of creation must match the issue date stated above.

This report may be copied in full.

The results in this report apply only to the sample(s) tested.

Radio Frequency Investigation Ltd, Ewhurst Park, Ramsdell, Basingstoke, Hampshire, RG26 5RQ, ENGLAND. Tel: +44 (0) 1256 851193 Fax: +44 (0) 1256 851192	Registered in England, No. 211 7901. Registered Office: Ewhurst Park, Ramsdell, Basingstoke, Hampshire RG26 5RQ	
---	---	---

**RADIO FREQUENCY INVESTIGATION LTD.**

**TEST REPORT**

**Conformance Testing Department**

**S.No: RFI/MPTB3/RP70413JD06A**

**Page 2 of 90**

**Issue Date: 23 December 2002**

**Test Of: Nokia UK Ltd.**

**Cameron Imaging Phone 3650 (NHL-8) Mobile Phone Handset**

**To: FCC Part 24: 2001, FCC Part 15: 2001 and Part 2: 2001**

---

This page has been left intentionally blank.

Test Of: Nokia UK Ltd.

Cameron Imaging Phone 3650 (NHL-8) Mobile Phone Handset

To: FCC Part 24: 2001, FCC Part 15: 2001 and Part 2: 2001

---

**Table of Contents**

1. Client Information.....	4
2. Equipment Under Test (EUT) .....	5
3. Test Specification, Methods And Procedures .....	8
4. Deviations From The Test Specification .....	10
5. Operation Of The EUT During Testing .....	11
6. Summary Of Test Results.....	12
7. Measurements, Examinations And Derived Results.....	14
8. Measurement Uncertainty .....	29
Appendix 1. Test Equipment Used .....	30
Appendix 2. Measurement Methods .....	32
Appendix 3. Test Configuration Drawings.....	39
Appendix 4. Graphical Test Results .....	43
Appendix 5. Photographs of EUT .....	90

**Test Of: Nokia UK Ltd.**

**Cameron Imaging Phone 3650 (NHL-8) Mobile Phone Handset**

**To: FCC Part 24: 2001, FCC Part 15: 2001 and Part 2: 2001**

---

**1. Client Information**

<b>Company Name:</b>	Nokia UK Ltd..
<b>Address:</b>	Nokia House Summit Avenue Southwood Farnborough Hampshire GU14 0NG
<b>Contact Name:</b>	Mr A White

Test Of: Nokia UK Ltd.

Cameron Imaging Phone 3650 (NHL-8) Mobile Phone Handset

To: FCC Part 24: 2001, FCC Part 15: 2001 and Part 2: 2001

---

## **2. Equipment Under Test (EUT)**

The following information has been supplied by the client:

### **2.1. Identification Of Equipment Under Test (EUT)**

#### **EMC Sample**

<b>Brand Name:</b>	Nokia
<b>Model Name or Number:</b>	Cameron Imaging Phone
<b>Unique Type Identification:</b>	3650 (NHL-8)
<b>IMEI Number:</b>	004400/11/173558/3
<b>Country of Manufacture:</b>	Finland
<b>Date of Receipt:</b>	01 October 2002

Test Of: Nokia UK Ltd.

Cameron Imaging Phone 3650 (NHL-8) Mobile Phone Handset

To: FCC Part 24: 2001, FCC Part 15: 2001 and Part 2: 2001

## 2.2. Description Of EUT

The equipment under test is a tri-band (900, 1800 & 1900) camera mobile handset, which also supports IR and Bluetooth. (The 900 and 1800 Bands are not available in the USA)

## 2.3. Modifications Incorporated In EUT

The EUT has not been modified from what is described by the Model Number and Unique Type Identification stated above.

## 2.4. Additional Information Related To Testing

<b>Power Supply Requirement: (non-removable lithium ion battery)</b>	Internal battery supply of 3.7 V
<b>Power Supply Requirement: (AC Battery Charger)</b>	Nominal 115 V 60 Hz AC Mains supply
<b>Intended Operating Environment:</b>	Within GSM Network Coverage
<b>Equipment Category:</b>	Portable
<b>Type of Unit:</b>	Mobile handset
<b>Weight:</b>	130 g
<b>Dimensions:</b>	130 x 55 x 23 mm
<b>Interface Ports:</b>	Battery Connection Headset Connection
<b>Transmit Frequency</b>	1850 to 1910 MHz
<b>Receive Frequency</b>	1930 to 1990 MHz
<b>Maximum Power Output (EIRP)</b>	30.11 dBm

Test Of: Nokia UK Ltd.

Cameron Imaging Phone 3650 (NHL-8) Mobile Phone Handset

To: FCC Part 24: 2001, FCC Part 15: 2001 and Part 2: 2001

---

## **2.5. Support Equipment**

The following support equipment was used to exercise the EUT during testing:

<b>Description:</b>	Li-ion Battery
<b>Brand Name:</b>	Nokia
<b>Model Name or Number:</b>	BL-5C
<b>Serial Number:</b>	067040063663222411
<b>Cable Length And Type:</b>	N/A
<b>Connected to Port:</b>	Battery

<b>Description:</b>	AC Power Supply
<b>Brand Name:</b>	Nokia
<b>Model Name or Number:</b>	Travel Charger
<b>Serial Number:</b>	ACP-12U
<b>Cable Length And Type:</b>	175 cm
<b>Connected to Port:</b>	Charger

<b>Description:</b>	Headset
<b>Brand Name:</b>	Nokia
<b>Model Name or Number:</b>	Headset
<b>Serial Number:</b>	HDE-2
<b>Cable Length And Type:</b>	108 cm
<b>Connected to Port:</b>	Not Stated by Applicant

Test Of: Nokia UK Ltd.

Cameron Imaging Phone 3650 (NHL-8) Mobile Phone Handset

To: FCC Part 24: 2001, FCC Part 15: 2001 and Part 2: 2001

### **3. Test Specification, Methods And Procedures**

#### **3.1. Test Specification**

<b>Reference:</b>	FCC Part 24 2001: Subpart E Sections 24.232, 24.235, 24.238
<b>Title:</b>	Code of Federal Regulations, Part 24 (47CFR) Personal Communication Services.
<b>Comments:</b>	None.
<b>Purpose of Test:</b>	To determine whether the equipment complied with the requirements of the specification for the purposes of certification.

<b>Reference:</b>	FCC Part 15: 2001 Class B, Sections: 15.107 and 15.109
<b>Title:</b>	Code of Federal Regulations, Part 15 (47CFR) Radio Frequency Devices: Digital Devices.
<b>Comments:</b>	A description of the test facility used for this test is on file with, and has been accepted by, the Federal Communications Commission as required by Section 2.948 of Federal Rules.
<b>Purpose of Test:</b>	To determine whether the equipment complied with the requirements of the specification for the purposes of certification.

<b>Reference:</b>	FCC Part 2: 2001 Sections 2.1046 2.1049 2.1051 2.1055
<b>Title:</b>	Code of Federal Regulations, Part 2 (47CFR) Frequency allocations and radio treaty matters; General Rules and Regulations
<b>Comments:</b>	None.
<b>Purpose of Test:</b>	To determine whether the equipment complied with the requirements of the specification for the purposes of certification.



Test Of: Nokia UK Ltd.

Cameron Imaging Phone 3650 (NHL-8) Mobile Phone Handset

To: FCC Part 24: 2001, FCC Part 15: 2001 and Part 2: 2001

---

### **3.2. Methods And Procedures**

The methods and procedures used were as detailed in:

47CFR: Part 24 (2001)

Title: Federal Communications Commission: Code of Federal Regulations 47:  
Personal Communication Services.

47CFR: Part 15 (2001)

Title: Federal Communications Commission: Code of Federal Regulations 47:  
Telecommunication

47CFR: Part 2 (2001)

Title: Federal Communications Commission: Code of Federal Regulations 47:  
Telecommunication

ANSI C63.2 (1996)

Title: American National Standard for Instrumentation - Electromagnetic noise and field strength.

ANSI C63.4 (2001)

Title: American National Standard Methods of Measurement of Electromagnetic Emissions from Low Voltage Electrical and Electronic Equipment in the Range of 9 kHz to 40 GHz.

ANSI C63.5 (1998)

Title: American National Standard for the Calibration of antennas used for Radiated Emission measurements in Electromagnetic Interference (EMI) control.

ANSI C63.7 (1988)

Title: American National Standard Guide for Construction of Open Area Test Sites for performing Radiated Emission Measurements.

CISPR 16-1 (1999)

Title: Specification for radio disturbance and immunity measuring apparatus and methods. Part 1. Radio disturbance and immunity measuring apparatus.

### **3.3. Definition Of Measurement Equipment**

The measurement equipment used complied with the requirements of the standards referenced in the Methods & Procedures section above. Appendix 1 contains a list of the test equipment used.

Test Of: Nokia UK Ltd.

Cameron Imaging Phone 3650 (NHL-8) Mobile Phone Handset

To: FCC Part 24: 2001, FCC Part 15: 2001 and Part 2: 2001

---

#### **4. Deviations From The Test Specification**

The standard requests that testing be performed on Top, Bottom and Middle channels. These equate to GSM channels 512, 660 and 810. The client however requested that the EIRP test be performed on channels 514, 661 and 804.

The radiated spurious attenuation limits were determined using the EIRP values measured on channels 514, 661 and 804.

Test Of: Nokia UK Ltd.

Cameron Imaging Phone 3650 (NHL-8) Mobile Phone Handset

To: FCC Part 24: 2001, FCC Part 15: 2001 and Part 2: 2001

---

## **5. Operation Of The EUT During Testing**

### **5.1. Operating Conditions**

The EUT was tested in a normal laboratory environment.

During testing, the EUT was powered by nominal 115 V 60 Hz AC mains supply

### **5.2. Operating Modes**

The EUT was tested in the following operating modes:

#### **Transmitter Modes:**

For carrier output power, occupied bandwidth and final transmitter radiated measurements, testing was performed at full power on top, middle and bottom channels of the assigned frequency block.

For frequency stability testing, measurements were performed at full power on the top and bottom channels of the assigned frequency block at -30 through +50 deg.C in 10 degree increments.

All transmitter, radiated and conducted spurious pre-scan tests were performed at full power on the middle channel of the assigned frequency block. Final measurements were then performed on the Top, Middle and Bottom channels if an emission was identified.

This mode was tested in its worse case configuration, see note.

#### **Receiver Modes:**

Testing was performed with the call terminated from the GSM Test Simulator and the phone left in its receive mode.

This mode was tested in its worse case configuration, see note.

- **Note.**

The EUT was tested with AC charger and the Hands Free kit making it impossible to operate both simultaneously. In light of this fact, Pre-scans were performed with the Hands Free kit fitted and then repeated with the 115 V AC battery charger fitted. The worse case configuration was deduced and final measurements were performed on this configuration in both modes of operation.

### **5.3. Configuration and Peripherals**

The EUT was tested in the following configuration:

With an AC Charger and Headset connected

NB Section 2 of this report contains a full list of support equipment used and Appendix 3 contains a schematic diagram of the test configuration.

Test Of: Nokia UK Ltd.

Cameron Imaging Phone 3650 (NHL-8) Mobile Phone Handset

To: FCC Part 24: 2001, FCC Part 15: 2001 and Part 2: 2001

## 6. Summary Of Test Results

### 6.1. Call Mode

Range Of Measurements	Specification Reference	Mode of Operation	Port Type	Compliance Status
Carrier Output Power	Part 2 of CFR 47: 2001, Section 2.1046(a)	Transmit	Antenna	Complied
Carrier Output Power (EIRP)	Part 24 of CFR 47: 2001, Section 24.232	Transmit	Antenna	Complied
Frequency Stability (Temperature Variation)	Part 24 of CFR 47: 2001, Section 24.235	Transmit	Antenna Terminals	Complied
Frequency Stability (Voltage Variation)	Part 24 of CFR 47: 2001, Section 24.235	Transmit	Antenna Terminals	Complied
Occupied Bandwidth	Part 24 of CFR 47: 2001, Section 24.238	Transmit	Antenna Terminals	Complied
Conducted Emissions at Band Edges	Part 24 of CFR 47: 2001, Section 24.238	Transmit	Antenna Terminals	Complied
Conducted Emissions (Antenna Terminals)	Part 24 of CFR 47: 2001, Section 24.238	Transmit	Antenna Terminals	Complied
Electric Field Strength, Spurious Emissions (30 MHz to 26.5 GHz)	Part 24 of CFR 47: 2001, Section 24.238	Transmit	Antenna	Complied
Electric Field Strength, Spurious Emissions (1.0 GHz to 26.5 GHz)	Part 24 of CFR 47: 2001, Section 24.238	Transmit	Antenna	Complied
Radiated Emissions at Band Edges	Part 2 of CFR 47: 2001, Section 2.1053	Transmit	Antenna	Complied

### 6.2. Receive/Idle Mode

Range Of Measurements	Specification Reference	Mode of Operation	Port Type	Compliance Status
Conducted Spurious Emissions (150 kHz to 30 MHz)	Part 15 of CFR 47: 2001, Section 15.107	Receive/Idle	AC Mains Input	Complied
Electric Field Strength, Spurious Emissions (30 MHz to 26.5 GHz)	Part 15 of CFR 47: 2001, Section 15.109	Receive/Idle	Enclosure	Complied

Test Of: Nokia UK Ltd.

Cameron Imaging Phone 3650 (NHL-8) Mobile Phone Handset

To: FCC Part 24: 2001, FCC Part 15: 2001 and Part 2: 2001

---

### **6.3. Location Of Tests**

All the measurements described in this report were performed at the premises of Radio Frequency Investigation Ltd, Ewhurst Park, Ramsdell, Basingstoke, Hampshire, RG26 5RQ, England.

Test Of: Nokia UK Ltd.

Cameron Imaging Phone 3650 (NHL-8) Mobile Phone Handset

To: FCC Part 24: 2001, FCC Part 15: 2001 and Part 2: 2001

---

## **7. Measurements, Examinations And Derived Results**

### **7.1. General Comments**

7.1.1. This section contains test results only. Details of the test methods and procedures can be found in Appendix 3 of this report.

7.1.2. Measurement uncertainties are evaluated in accordance with current best practice. Our reported expanded uncertainties are based on standard uncertainties, which are multiplied by an appropriate coverage factor to provide a statistical confidence level of approximately 95%. Please refer to Section 8 for details of measurement uncertainties.

7.1.3. The term "Call Mode" is used to signify Transmitter active and in normal mode of operation.

7.1.4. The term "Idle Mode" is used to signify that the phone is in a Standby condition.

7.1.5. During Conducted Antenna port measurements the front cover of the phone was replaced. The replacement cover was identical in all respects apart from the addition of an aperture to allow access to the antenna port. It should also be noted that the modified cover was coloured yellow where as the original colour was grey.

Test Of: Nokia UK Ltd.

Cameron Imaging Phone 3650 (NHL-8) Mobile Phone Handset

To: FCC Part 24: 2001, FCC Part 15: 2001 and Part 2: 2001

---

## **7.2. Conducted RF Output Power: Call Mode: (Antenna Terminals): Section 2.1046(a)**

7.2.1. The EUT, spectrum analyser and HP GSM test set were configured as for conducted port measurements.

7.2.2. Tests were performed to identify the maximum transmit power in accordance with FCC Part 2.1046(a) for conducted power.

7.2.3. The applicant provided a temporary antenna port to allow a direct connection to be made for conducted power measurements.

7.2.4. Results are shown for the EUT set to Bottom, Middle and Top channels using a fully charged battery. The battery nominally charged voltage is declared at 3.7 Volts:

### **Results:**

Channel	Frequency (MHz)	Maximum RF Output Power (dBm)	Limit (dBm)	Margin (dBm)	Result
Bottom (512)	1850.225	29.33	33.00	3.67	Complied
Middle (660)	1879.825	29.60	33.00	3.40	Complied
Top (810)	1909.775	29.93	33.00	3.07	Complied

Test Of: Nokia UK Ltd.

Cameron Imaging Phone 3650 (NHL-8) Mobile Phone Handset

To: FCC Part 24: 2001, FCC Part 15: 2001 and Part 2: 2001

---

### **7.3. Carrier Output Power: Call Mode: (EIRP): Section 24.232**

7.3.1. Tests were performed to identify the maximum transmit power in accordance with FCC Part 24.232 for EIRP.

7.3.2. Results are shown for the EUT set to channel 514, 661 and 804 at the applicants request using a fully charged battery. The battery nominally charged voltage is declared at 3.7 Volts:

7.3.3. The highest EIRP was found with the AC charger disconnected. As such, all results were taken with the charger disconnected.

#### **Results EIRP.**

Channel	Frequency (MHz)	Antenna Polarity (H/V)	Maximum Transmitter EIRP (dBm)	Limit EIRP (dBm)	Margin	Result
Chan 514	1851.416	Horiz.	30.11	33.0	2.89	Complied
Chan 661	1880.144	Horiz.	29.42	33.0	3.58	Complied
Chan 804	1908.622	Horiz.	28.44	33.0	4.56	Complied



Test Of: Nokia UK Ltd.

Cameron Imaging Phone 3650 (NHL-8) Mobile Phone Handset

To: FCC Part 24: 2001, FCC Part 15: 2001 and Part 2: 2001

#### **7.4 Frequency Stability Measurements: Call Mode: (Temperature and Voltage Variation): Section 24.235**

7.3.4. The EUT and HP GSM test set were configured for conducted antenna port measurements.

7.3.5. The applicant to allow for conducted measurements provided a temporary antenna port.

7.3.6. Measurements were performed to determine the frequency stability of the fundamental emission from the EUT, when subjected to variation of ambient temperature and variation of supply voltage.

7.3.7. The device is battery operated. The applicant has stated that the nominal voltage of the battery is 3.7 volts with an end point voltage of 3.49 volts. Extreme measurements were performed at these two voltages as requested in FCC Part 2.1055 (d) (2)

7.3.8. The ambient temperature was varied from -30°C to +50°C in 10°C steps. During the test the fundamental frequency of the EUT shall stay within the authorised frequency block.

7.3.9. The ppm frequency error is calculated using the following formulae taken from the TIA\_EIA\_603A document.

$$\text{ppm error} = \left( \frac{MCF_{\text{MHz}}}{ACF_{\text{MHz}}} - 1 \right) * 10^6$$

where  $MCF_{\text{MHz}}$  is the measured carrier frequency in MHz

$ACF_{\text{MHz}}$  is the assigned carrier frequency in MHz

7.3.10. The limit to the lower band edge from the bottom channel and the limit to the upper band edge from the top channel was calculated in ppm. The actual error in ppm is then calculated and subtracted from the calculated limit. If the margin was less than 0 the frequency would be outside of the authorised frequency block.

7.3.11. The client has stated that the authorised frequency block is:-

Lower Block Edge	1850 MHz
Upper Block Edge	1910 MHz

The limit is stated as the frequency stability that is sufficient to ensure that the fundamental emission stays within the authorised frequency block.

Test Of: Nokia UK Ltd.

Cameron Imaging Phone 3650 (NHL-8) Mobile Phone Handset

To: FCC Part 24: 2001, FCC Part 15: 2001 and Part 2: 2001

**Frequency Stability Measurements: Call Mode: (continued)****Results: Bottom Channel (1850.2 MHz)**

Temperature (°C)	DC Input Voltage (Volts)	Absolute Peak Frequency Error (Hz)	Frequency Error (ppm)	Limit to band Edge (ppm)	Margin (ppm)	Result
-30	3.45	19.0	0.010	108.108	108.098	Complied
	4.2	27.0	0.015	108.108	108.094	Complied
-20	3.45	24.0	0.013	108.108	108.095	Complied
	4.2	21.0	0.011	108.108	108.097	Complied
-10	3.45	23.0	0.012	108.108	108.096	Complied
	4.2	16.0	0.009	108.108	108.099	Complied
+0	3.45	10.0	0.005	108.108	108.103	Complied
	4.2	21.0	0.011	108.108	108.097	Complied
+10	3.45	13.0	0.007	108.108	108.101	Complied
	4.2	12.0	0.006	108.108	108.102	Complied
+20	3.45	10.0	0.005	108.108	108.103	Complied
	4.2	12.0	0.006	108.108	108.102	Complied
+30	3.45	26.0	0.014	108.108	108.094	Complied
	4.2	22.0	0.012	108.108	108.096	Complied
+40	3.45	11.0	0.006	108.108	108.102	Complied
	4.2	6.0	0.003	108.108	108.105	Complied
+50	3.45	13.0	0.007	108.108	108.101	Complied
	4.2	15.0	0.008	108.108	108.100	Complied

Test Of: Nokia UK Ltd.

Cameron Imaging Phone 3650 (NHL-8) Mobile Phone Handset

To: FCC Part 24: 2001, FCC Part 15: 2001 and Part 2: 2001

**Frequency Stability Measurements: Call Mode: (continued)****Results: Top Channel (1909.8 MHz)**

Temperature (°C)	DC Input Voltage (Volts)	Absolute Peak Frequency Error (Hz)	Frequency Error (ppm)	Limit (ppm)	Margin (ppm)	Result
-30	3.45	24.0	0.013	104.712	104.699	Complied
	4.2	12.0	0.006	104.712	104.706	Complied
-20	3.45	21.0	0.011	104.712	104.701	Complied
	4.2	15.0	0.008	104.712	104.704	Complied
-10	3.45	15.0	0.008	104.712	104.704	Complied
	4.2	20.0	0.010	104.712	104.702	Complied
+0	3.45	9.0	0.005	104.712	104.707	Complied
	4.2	13.0	0.007	104.712	104.705	Complied
+10	3.45	12.0	0.006	104.712	104.706	Complied
	4.2	13.0	0.007	104.712	104.705	Complied
+20	3.45	2.0	0.001	104.712	104.711	Complied
	4.2	9.0	0.005	104.712	104.707	Complied
+30	3.45	35.0	0.018	104.712	104.694	Complied
	4.2	21.0	0.011	104.712	104.701	Complied
+40	3.45	17.0	0.009	104.712	104.703	Complied
	4.2	20.0	0.010	104.712	104.702	Complied
+50	3.45	28.0	0.015	104.712	104.697	Complied
	4.2	27.0	0.014	104.712	104.698	Complied

Test Of: Nokia UK Ltd.

Cameron Imaging Phone 3650 (NHL-8) Mobile Phone Handset

To: FCC Part 24: 2001, FCC Part 15: 2001 and Part 2: 2001

---

#### **7.4. Transmitter Conducted Measurements: Call Mode: (Occupied Bandwidth): Section 24.238**

7.4.1. The EUT, HP GSM test and spectrum analyser were configured for conducted antenna port measurements.

7.4.2. The applicant to allow for conducted measurements provided a temporary antenna port.

7.4.3. The device was operating in its normal mode of operation.

7.4.4. Measurements were performed to determine the Occupied Bandwidth of the fundamental emission from the EUT at the bottom middle and top channels.

7.4.5. The Occupied Bandwidth was measured using the built in occupied bandwidth function of the Rohde and Schwarz FSEB spectrum analyser. It was set to measure the bandwidth where 99% of the signal power was contained. The analyser settings were set as per those outlined in the FSEB user manual for this measurement, i.e. RBW  $\leq$  1/20 of occupied bandwidth.

#### **Results:**

<b>Channel</b>	<b>Frequency (MHz)</b>	<b>Resolution Bandwidth (kHz)</b>	<b>Video Bandwidth (kHz)</b>	<b>Occupied Bandwidth (kHz)</b>
Bottom (512)	1850.2	3.0	10.0	216.2
Middle (660)	1879.8	3.0	10.0	209.6
Top (810)	1909.8	3.0	10.0	213.9

Test Of: Nokia UK Ltd.

Cameron Imaging Phone 3650 (NHL-8) Mobile Phone Handset

To: FCC Part 24: 2001, FCC Part 15: 2001 and Part 2: 2001

### **7.5. Transmitter Conducted Measurements: Call Mode: (Emissions at Band Edges): Section 24.238**

7.5.1. The EUT and spectrum analyser were configured as for conducted antenna port measurements.

7.5.2. The applicant to allow for conducted measurements provided a temporary antenna port.

7.5.3. FCC Part 24.238 states that emissions shall be attenuated by at least  $43+10 \log(P)$  dB below the transmitter power (P), where (P) is the power measured at the EUT antenna terminals.

7.5.4. FCC Part 24.238 also states that the 1<sup>st</sup> MHz band immediately adjacent to the applicants declared frequency block may be measured using a resolution bandwidth of at least 1% of the emission bandwidth. This bandwidth was found to be 3 kHz.

7.5.5. The highest level within these 1 MHz bands was thus measured and recorded in the tables below.

7.5.6. The spurious attenuation level in dB is described in TIA\_EIA\_603A and is defined as: -

$$\text{dB} = 10 \log_{10} \left( \frac{\text{TX power in watts}}{0.001} \right) - \text{spurious level (dBm)}$$

#### **Results:**

##### **Bottom Band Edge**

Frequency (MHz)	Peak Emission Level (dBm)	Spurious Attenuation (dBc)	Limit (dBc)	Margin (dB)	Result
1849.984	-15.95	45.20	43.11	2.09	Complied

##### **Top Band Edge**

Frequency (MHz)	Peak Emission Level (dBm)	Spurious Attenuation (dBc)	Limit (dBc)	Margin (dB)	Result
1910.009	-15.95	45.08	41.44	3.64	Complied

Test Of: Nokia UK Ltd.

Cameron Imaging Phone 3650 (NHL-8) Mobile Phone Handset

To: FCC Part 24: 2001, FCC Part 15: 2001 and Part 2: 2001

**7.6. Transmitter Conducted Measurements: Call Mode: (Emissions Outside of Authorised Frequency Block): Section 24.238**

7.6.1.The EUT and spectrum analyser was configured as for conducted antenna port measurements.

7.6.2.The applicant to allow for conducted measurements provided a temporary antenna port.

7.6.3.FCC Part 24.238 states that emissions shall be attenuated by at least  $43+10 \log (P)$  dB below the transmitter power (P).

7.6.4.The spurious attenuation level is defined as: -

$$\text{dB} = 10 \log_{10} \left( \frac{\text{TX power in watts}}{0.001} \right) - \text{spurious level (dBm)}$$

**Result: Bottom Channel**

Frequency (MHz)	Peak Emission Level (dBm)	Spurious Attenuation (dBc)	Limit (dBc)	Margin (dB)	Result
2645.00	-33.0	62.33	42.33	20.0	Complied
7675.00	-27.23	57.16	42.33	14.83	Complied

**Result: Middle Channel**

Frequency (MHz)	Peak Emission Level (dBm)	Spurious Attenuation (dBc)	Limit (dBc)	Margin (dB)	Result
3300.00	-33.0	62.60	42.60	20.0	Complied
7458.00	-29.17	58.77	42.60	16.17	Complied

**Result: Top Channel**

Frequency (MHz)	Peak Emission Level (dBm)	Spurious Attenuation (dBc)	Limit (dBc)	Margin (dB)	Result
3190.00	-33.0	62.93	42.93	20.0	Complied
7483.00	-28.5	58.43	42.93	15.5	Complied

Test Of: Nokia UK Ltd.

Cameron Imaging Phone 3650 (NHL-8) Mobile Phone Handset

To: FCC Part 24: 2001, FCC Part 15: 2001 and Part 2: 2001

---

## **7.7. Transmitter Radiated Emissions: Section 24.238.**

### **7.7.1. Electric Field Strength Measurements: 30 to 1000 MHz.**

7.7.1.1. The client has stated that the highest clock frequency for the EUT was 3.98 GHz Therefore measurements were performed up to 26 GHz.

7.7.1.2. Preliminary Radiated spurious scans were performed with the EUT set to Middle channel.

7.7.1.3. Plots of the initial scans can be found in Appendix 4.

**Note:** The preliminary scans showed all emissions to be greater than 20dB below the limit therefore no final measurements were performed.

Test Of: Nokia UK Ltd.

Cameron Imaging Phone 3650 (NHL-8) Mobile Phone Handset

To: FCC Part 24: 2001, FCC Part 15: 2001 and Part 2: 2001

**7.8. Radiated Emissions: Call Mode****7.8.1. Electric Field Strength Measurements: 1.0 to 26.0 GHz**

7.8.1.1. The client has stated that the highest fundamental frequency for the EUT was 3.98 GHz. Therefore tests were performed up to 26 GHz.

7.8.1.2. Preliminary Radiated spurious scans were performed with the EUT set to the Middle channel. Any visible spurious was then measured with the device set to top, bottom and middle channels.

7.8.1.3. The following table lists frequencies at which emissions were measured using a Quasi-Peak detector at a test distance of 3m (results incorporate antenna factors and cable losses):

7.8.1.4. The limit is specified as  $43+10 \log (P)$  dB below the transmitter power (P), where (P) is the power measured at the EUT antenna terminals.

7.8.1.5. The radiated spurious emission level in dB is described in TIA\_EIA\_603A and is defined as: -

$$\text{dB} = 10 \log_{10} \left( \frac{\text{TX power in watts}}{0.001} \right) - \text{spurious level (dBm)}$$

7.8.1.6. Spurious emissions tests were carried out on the Bottom, Middle and Top channels with the spurious attenuation limit calculated based on the EIRP values given in Section 7.3 of this report.

**Results:- Bottom Channel**

Frequency (MHz)	Signal Generator Level (dBm)	Matching Attenuator & Cable Loss (dB)	Substitution Antenna Gain (dBi)	Spurious Emission (dBm)	Spurious Attenuation dBc	Spurious Attenuation Limit (dBc)	Margin (dB)	Result
3700.533	-34.9	7.2	20.5	-21.6	51.71	43.11	8.6	Complied

**Results:- Middle Channel**

Frequency (MHz)	Signal Generator Level (dBm)	Matching Attenuator & Cable Loss (dB)	Substitution Antenna Gain (dBi)	Spurious Emission (dBm)	Spurious Attenuation dBc	Spurious Attenuation Limit (dBc)	Margin (dB)	Result
3759.599	-30.4	7.2	20.5	-17.1	46.52	42.42	4.1	Complied



Test Of: Nokia UK Ltd.

Cameron Imaging Phone 3650 (NHL-8) Mobile Phone Handset

To: FCC Part 24: 2001, FCC Part 15: 2001 and Part 2: 2001

---

**Radiated Emissions: Call Mode (continued)****Results:- Top Channel**

Frequency (MHz)	Signal Generator Level (dBm)	Matching Attenuator & Cable Loss (dB)	Substitution Antenna Gain (dBi)	Spurious Emission (dBm)	Spurious Attenuation dBc	Spurious Attenuation Limit (dBc)	Margin (dB)	Result
3819.538	-27.9	7.2	20.5	-14.6	43.04	41.44	1.6	Complied

Test Of: Nokia UK Ltd.

Cameron Imaging Phone 3650 (NHL-8) Mobile Phone Handset

To: FCC Part 24: 2001, FCC Part 15: 2001 and Part 2: 2001

### **7.9. Radiated Emissions: Call Mode: (Emissions at Band Edges): Section 2.1053**

7.9.1.FCC Part 24.238 states that emissions shall be attenuated by at least  $43+10 \log(P)$  dB below the transmitter power (P). It also states that the 1<sup>st</sup> MHz band immediately adjacent to the applicants declared frequency block may be measured using a resolution bandwidth of at least 1% of the emission bandwidth. This bandwidth was found to be 3 kHz.

7.9.2. The highest level within these 1 MHz bands was thus measured and recorded.

7.9.3. The limit is specified as  $43+10 \log(P)$  dB below the transmitter power (P), where (P) is the power measured at the EUT antenna terminals.

7.9.4.The radiated spurious emission level in dB is described in TIA\_EIA\_603A and is defined as: -

$$\text{dB} = 10 \log_{10} \left( \frac{\text{TX power in watts}}{0.001} \right) - \text{spurious level (dBm)}$$

7.9.5. Spurious emissions tests were carried out on the Top, Middle and Bottom channels with the spurious attenuation limit calculated based on the EIRP values given in Section 7.3 of this report.

#### **Results:**

##### **Bottom Band Edge**

Frequency (MHz)	Peak Emission Level (dBm)	Radiated Spurious Emission (dBc)	Limit (dBc)	Margin (dB)	Result
1849.993	-15.09	45.2	43.11	2.09	Complied

##### **Top Band Edge**

Frequency (MHz)	Peak Emission Level (dBm)	Radiated Spurious Emission (dBc)	Limit (dBc)	Margin (dB)	Result
1910.023	-16.64	45.08	41.44	3.64	Complied

Test Of: Nokia UK Ltd.

Cameron Imaging Phone 3650 (NHL-8) Mobile Phone Handset

To: FCC Part 24: 2001, FCC Part 15: 2001 and Part 2: 2001

**7.10. AC Mains Conducted Emissions: Receive/Idle Mode: Section 15.107****7.10.1. Quasi-Peak Detector Measurements On Live And Neutral Lines**

7.10.1.1. Plots of the initial scans can be found in Appendix 4.

7.10.1.2. The following table lists frequencies at which emissions were measured using a Quasi-Peak detector:

Frequency (MHz)	Line	Q-P Level (dB $\mu$ V)	Q-P Limit (dB $\mu$ V)	Margin (dB)	Result
0.17329	Live/Neutral	35.66	64.80	29.14	Complied
0.31246	Live/Neutral	28.45	59.90	31.45	Complied
0.41565	Live/Neutral	31.80	57.53	25.73	Complied
0.44812	Live/Neutral	31.32	56.91	25.59	Complied
0.7902	Live/Neutral	25.99	56.00	30.01	Complied
0.94307	Live/Neutral	19.26	56.00	36.74	Complied

**7.10.2. Average Detector Measurements On Live And Neutral Lines**

7.10.2.1. Following the initial scans and Quasi-Peak measurements, further measurements were made at the relevant frequencies using an average detector. The measured levels were as follows:

Frequency (MHz)	Line	Av. Level (dB $\mu$ V)	Av. Limit (dB $\mu$ V)	Margin (dB)	Result
0.17329	Live/Neutral	23.33	54.86	31.58	Complied
0.31246	Live/Neutral	17.25	49.90	32.65	Complied
0.41565	Live/Neutral	17.25	47.53	30.28	Complied
0.44812	Live/Neutral	16.59	46.91	30.32	Complied
0.7902	Live/Neutral	15.17	46.00	30.83	Complied
0.94307	Live/Neutral	11.18	46.00	34.82	Complied

Test Of: Nokia UK Ltd.

Cameron Imaging Phone 3650 (NHL-8) Mobile Phone Handset

To: FCC Part 24: 2001, FCC Part 15: 2001 and Part 2: 2001

---

**7.11. Radiated Emissions: Receive/Idle Mode: Section 15.109 (Class B)****7.11.1. Electric Field Strength Measurements (Frequency Range: 30 to 1000 MHz)**

7.11.1.1. The following table indicates measured results with the EUT operating in receive mode to the limits specified in Part 15.109.

7.11.1.2. The following table lists frequencies at which emissions were measured using a Quasi-Peak detector at a test distance of 3m (results incorporate antenna factors and cable losses):

**Results:**

Frequency (MHz)	Ant. Pol.	Q-P Level (dB $\mu$ V/m)	Limit (dB $\mu$ V/m)	Margin (dB)	Result
45.472	Vert.	28.8	40.0	11.2	Complied

Test Of: Nokia UK Ltd.

Cameron Imaging Phone 3650 (NHL-8) Mobile Phone Handset

To: FCC Part 24: 2001, FCC Part 15: 2001 and Part 2: 2001

## **8. Measurement Uncertainty**

8.1. No measurement or test can ever be perfect and the imperfections give rise to error of measurement in the results. Consequently, the result of a measurement is only an approximation to the value of the measurand (the specific quantity subject to measurement) and is only complete when accompanied by a statement of the uncertainty of the approximation.

8.2. The expression of uncertainty of a measurement result allows realistic comparison of results with reference values and limits given in specifications and standards.

8.3. The uncertainty of the result may need to be taken into account when interpreting the measurement results.

8.4. The reported expanded uncertainties below are based on a standard uncertainty multiplied by an appropriate coverage factor, such that a confidence level of approximately 95% is maintained. For the purposes of this document “approximately” is interpreted as meaning “effectively” or “for most practical purposes”.

<b>Measurement Type</b>	<b>Range</b>	<b>Confidence Level</b>	<b>Calculated Uncertainty</b>
Carrier Output Power (EIRP)	Not applicable	95%	+/- 1.78 dB
Conducted Emissions (AC)	0.15 MHz to 30 MHz	95%	+/- 3.25 dB
Conducted Emissions Antenna Port	0.009 kHz to 26 GHz	95%	+/- 1.2 dB
Radiated Emissions at 3.0 metres	30 MHz to 1000 MHz	95%	+/- 5.26 dB
Radiated Emissions at 3.0 metres	1 GHz to 26 GHz	95%	+/- 1.78 dB
Frequency Stability	Not applicable	95%	+/- 20 Hz
Occupied Bandwidth	1850 to 1910 MHz	95%	+/- 0.12 %
Emissions at Band Edges	1850 to 1910 MHz	95%	+/- 1.78 dB

8.5. The methods used to calculate the above uncertainties are in line with those recommended within the various measurement specifications. Where measurement specifications do not include guidelines for the evaluation of measurement uncertainty, the published guidance of the appropriate accreditation body is followed.

Test Of: Nokia UK Ltd.

Cameron Imaging Phone 3650 (NHL-8) Mobile Phone Handset

To: FCC Part 24: 2001, FCC Part 15: 2001 and Part 2: 2001

**Appendix 1. Test Equipment Used**

RFI No.	Instrument	Maker	Type No.	Serial No.
A027	Horn Antenna	Eaton	9188-2	301
A031	2 to 4 GHz Eaton Horn Antenna	Eaton	91889-2	557
A067	LISN	Rohde & Schwarz	ESH3-Z5	890603/002
A1077	3020A	Narda	3020A	40140
A1141	HP 11691D	Hewlett Packard	11691D	1212A02494
A246	30 dB Attenuator	Schaffner	6830-17-B	None
A388	20 dB attenuator (6)	Suhner	6820.17.B	None
A490	Bilog Antenna	Chase	CBL6111A	1590
A512	Wave Guide Antenna	EMCO	3115	3993
A532	RHT & Barometer	RS Components	216-935	N/A
A553	Bi-log Antenna	Chase	CBL6111A	1593
A559	Pulse Limiter	Rohde & Schwarz	ESH3-Z2	357881052
C222	Cable	Rosenberger	UFA210A-1-1181-70x70	None
C225	Cable	Rosenberger	UFA210A-1-1181-70x70	None
C321	Cable	Rosenberger	UFA 210A-1-0788-50x50	96A0122
C346	Coaxial Cable	Rosenberger	UFA210A-1-1181-70x70	1932
C364	BNC Cable	Rosenberger	RG142	None
C367	Cable	RFI	RG58	None
C573	C573-N-N-2	Rosenberger	UFA210A-1-788-50x50	97E0936
E013	PCN Environmental Chamber	Sanyo	ATMOS chamber	None
G013	SMHU Signal Generator	Rohde & Schwarz	SMHU	894 055/003
G085	Generator	Hewlett Packard	83650L	3614A00104
M025	Fluke 87 Multimeter	Fluke	87	473 50093
M069	ESMI Spectrum Analyser / Receiver	Rohde & Schwarz	ESMI	829 808/007 (DU) / 827 063/008 (RU)

Test Of: Nokia UK Ltd.

Cameron Imaging Phone 3650 (NHL-8) Mobile Phone Handset

To: FCC Part 24: 2001, FCC Part 15: 2001 and Part 2: 2001

**Test Equipment Used (Continued)**

RFI No.	Instrument	Maker	Type No.	Serial No.
M090	Receiver / Spectrum Analyser System	Rohde & Schwarz	ESBI	DU:838494/005 RU:836833/001
M093	HP Oscilloscope	Hewlett Packard	54520A	US34360744
M1013	GSM Test set	Hewlett Packard	8922M	3503U00372
M1014	DCS Test set	Hewlett Packard	83220E	3741U02702
M133	Temperature/Humidity/Pressure Meter	RS Components	None	None
M198	Thermal Power Sensor	Rohde & Schwarz	NRV-Z52	827 191/003
M199	Power Meter	Rohde & Schwarz	NRVS	827023/075
M243	Thermometer/Barometer /Hygrometer	Oregon Scientific	BA 116	None
S011	D.C. PSU	INSTEK	PR-3010H	9401270
S201	Site 1	RFI	1	
S204	Site 4	RFI	4	357881052
S216	Site 16	RFI	16	None

**NB** In accordance with UKAS requirements, all the measurement equipment is on a calibration schedule.

Test Of: Nokia UK Ltd.

Cameron Imaging Phone 3650 (NHL-8) Mobile Phone Handset

To: FCC Part 24: 2001, FCC Part 15: 2001 and Part 2: 2001

## **Appendix 2. Measurement Methods**

### **A2.1 FCC Part 24.232: Effective Isotropic Radiated Power (EIRP)**

A2.1.1 EIRP measurements were performed in accordance with the standard, against appropriate limits.

A2.1.2 The EIRP was measured with the EUT arranged on a non-conducting turn table on a standard test site compliant with ANSI C63.4 – 2001 Clause 5.4. The transmitter was fitted with an integral antenna, as such tests were run with the unit operating into the integral antenna.

A2.1.3 The level of the EIRP was measured using a spectrum analyser. Its amplitude was maximised by first raising and lowering the test antenna in the horizontal plane. The turntable was then rotated through 360 degrees to determine the maximum reading. The maximum reading was then recorded. This procedure was then repeated for the Vertical polarity.

A2.1.4 Once the final amplitude (maximised) had been obtained, the EIRP was measured by using a substitution method.

A2.1.5 The substitution method involved replacing the EUT with a substitution antenna. For EIRP measurements a Horn antenna whose gain was based on an isotropic antenna was used. The centre of the substitution antenna was set to approximately the same centre location as the EUT. The substitution antenna was set to the horizontal polarity. The substitution antenna was then connected to and fed by a signal generator tuned to the EUT's operating frequency. The test antenna was then raised and lowered to obtain a maximum reading on the spectrum analyser. The level of the signal generator output was then adjusted until the previously recorded maximum level for this set of conditions was obtained. This procedure was repeated with both antennas vertically polarised. The EIRP was then taken as:-

$$\text{EIRP} = \text{Signal Generator Level} - \text{Cable Loss} + \text{Antenna Gain}$$

A2.1.6 All measurements were performed using broadband Horn antennas.

A2.1.7 The test equipment settings for EIRP measurements were as follows:

<b>Receiver Function</b>	<b>Final Measurements</b>
Detector Type:	Peak
Mode:	Not applicable
Bandwidth:	1 MHz
Amplitude Range:	20 dB
Measurement Time:	> 1 s
Observation Time:	> 15 s
Sweep Time:	Coupled



Test Of: Nokia UK Ltd.

Cameron Imaging Phone 3650 (NHL-8) Mobile Phone Handset

To: FCC Part 24: 2001, FCC Part 15: 2001 and Part 2: 2001

---

## **A2.2 FCC Part 24.235: Frequency Stability**

A2.2.1 The EUT was situated within an environmental test chamber and connected to test equipment via and access port.

A2.2.1 Measurements were performed with the EUT operating under extremes of temperature in 10 degree increments within the range -30 to 50 Deg C.

A2.2.1 Measurements were also performed at voltage extremes between the declared nominal supply voltage and at the declared endpoint voltage.

A2.2.1 The requirement was to determine the frequency stability of the device under specified environmental operating conditions.

A2.2.2 Measurements were made on the top, middle and bottom channels.

A2.2.3 The EUT was switched off for a minimum of 30 minutes between each stage of testing while the environmental chamber stabilised at the next temperature within the stated temperature range.

A2.2.4 The frequency error measured was converted to an error in ppm using the following formula as defined by TIA\_EIA\_603A :-

$$\text{ppm error} = \left( \frac{MCF_{\text{MHz}}}{ACF_{\text{MHz}}} - 1 \right) * 10^6$$

where  $MCF_{\text{MHz}}$  is the measured carrier frequency in MHz

$ACF_{\text{MHz}}$  is the assigned carrier frequency in MHz

A2.2.5 The measured ppm had to be less then the relevant limits in order to comply.

Test Of: Nokia UK Ltd.

Cameron Imaging Phone 3650 (NHL-8) Mobile Phone Handset

To: FCC Part 24: 2001, FCC Part 15: 2001 and Part 2: 2001

### **A2.3 Conducted Antenna Port Measurements: FCC Part 24.238:**

A2.3.1 Spurious measurements at the Antenna port were performed from the lower frequency of the allocated frequency block and from the top frequency of the allocated frequency block to 10 times the highest EUT generated frequency.

A2.3.2 A measuring receiver was connected to the antenna port of the EUT via a suitable cable and RF Attenuator. The total loss of both the cable and the attenuator were measured and entered as a reference level offset into the measuring receiver to correct for the losses.

A2.3.3 The specified frequency band was investigated with the transmitter operating at full power on the middle channel. Any spurious noted was then measured with the transmitter set to top, bottom and middle channels.

A2.3.4 The EUT was then replaced with a signal generator who's frequency was set to the indicated spurious frequency and who's level was adjusted to equal that recorded in section from the EUT. The level final recorded level was that reported by the signal generated.

A2.3.5 The test equipment settings for conducted antenna port measurements were as follows:

<b>Receiver Function</b>	<b>Initial Scan</b>	<b>Final Measurements Below 1GHz</b>	<b>Final Measurements Above 1 GHz</b>
Detector Type:	Peak	Quasi-Peak (CISPR)	Peak/Average
Mode:	Max Hold	Not applicable	Not applicable
Bandwidth:	100 kHz	120 kHz	1 MHz
Amplitude Range:	60 dB	20 dB	20 dB (typical)
Measurement Time:	Not applicable	> 1 s	> 1 s
Observation Time:	Not applicable	> 15 s	> 15 s
Step Size:	Continuous sweep	Not applicable	Not applicable
Sweep Time:	Coupled	Not applicable	Not applicable

\* The resolution bandwidth used for measurements in the 1 MHz blocks either side of the declared operating frequency block was set to 3 kHz.

Test Of: Nokia UK Ltd.

Cameron Imaging Phone 3650 (NHL-8) Mobile Phone Handset

To: FCC Part 24: 2001, FCC Part 15: 2001 and Part 2: 2001

---

#### **A2.4 FCC Part 24.238: Occupied Bandwidth**

A2.4.1 The EUT was connected to a spectrum analyser via its temporary antenna port.

A2.4.1 Measurements were performed to determine the Occupied Bandwidth in accordance with FCC Part 2.1049. The Occupied Bandwidth was measured from the fundamental emission at the bottom middle and top channels. The EUT is a PCS phone therefore no modulation input port was available. A call was thus setup using the PCS/GSM simulator and using normal modulation. The Occupied Bandwidth was measured in this configuration.

A2.4.2 The Occupied Bandwidth was measured using the built in occupied bandwidth function of the Rohde and Schwarz FSEB spectrum analyser. It was set to measure the bandwidth where 99% of the signal power was contained. The analyser settings were set as per those outlined in the FSEB user manual for this measurement, i.e.,  $RBW \leq 1/20$  of occupied bandwidth. A value of 3kHz was used.

Test Of: Nokia UK Ltd.

Cameron Imaging Phone 3650 (NHL-8) Mobile Phone Handset

To: FCC Part 24: 2001, FCC Part 15: 2001 and Part 2: 2001

## **A2.5 FCC Part 15: AC Mains Conducted Emissions**

A2.5.1 AC mains conducted emissions measurements were performed in accordance with the standard, against appropriate limits for each detector function.

A2.5.2 The test was performed in a shielded enclosure with the equipment arranged as detailed in the standard on a wooden bench using the floor of the screened enclosure as the ground reference plane.

A2.5.3 Initial measurements in the form of swept scans covering the entire measurement band were performed in order to identify frequencies on which the EUT was generating interference. In order to minimise the time taken for these swept measurements, a Peak detector was used in conjunction with the appropriate detector IF measuring bandwidths (see table below). Repetitive scans were performed to allow for emissions with low repetition rates, and the duty cycle of the EUT. The test configuration was the same for the initial scans as for the final measurements.

A2.5.4 During the swept measurements (and also during subsequent final measurements on single frequencies) any signals found to be between the limit and a level 6 dB below it were further maximised by changing the configuration of the EUT, e.g. re-routing cables to peripherals and moving peripherals with respect to the EUT.

A2.5.5 Following the initial scans, a graph was produced giving an overview of the emissions from the EUT plotted against the appropriate specification limit. A tolerance line was set 6 dB below the specification limit and levels above the tolerance line were re-tested (at individual frequencies) using the appropriate detector function.

A2.5.6 The test equipment settings for conducted emissions measurements were as follows:

<b>Receiver Function</b>	<b>Initial Scan</b>	<b>Final Measurements</b>
Detector Type:	Peak	Quasi-Peak (CISPR)/Average
Mode:	Max Hold	Not applicable
Bandwidth:	10 kHz*	9 kHz*
Amplitude Range:	60 dB	20 dB
Measurement Time:	Not applicable	> 1 s
Observation Time:	Not applicable	> 15 s
Step Size:	Continuous sweep	Not applicable
Sweep Time:	Coupled	Not applicable

\* Where measurements were made below 150 kHz a 200 Hz bandwidth was used.

**Test Of: Nokia UK Ltd.****Cameron Imaging Phone 3650 (NHL-8) Mobile Phone Handset****To: FCC Part 24: 2001, FCC Part 15: 2001 and Part 2: 2001**

---

**A2.6 Radiated Emissions: FCC Part 15/24**

A2.6.1 Radiated emissions measurements were performed in accordance with the standard, against appropriate limits for each detector function.

A2.6.2 Initial pre-scans covering the entire measurement band from the lowest generated frequency up to the highest specified frequency were performed within a screened chamber in order to identify frequencies on which the EUT was generating interference. This determined the frequencies from the EUT with required further attention. In order to minimise the time taken for the swept measurements, a peak detector was used in conjunction with the appropriate detector measuring bandwidth (see table below). Repetitive scans were performed to allow for emissions with low repetition rates, and for the duty cycle of the EUT.

A2.6.3 The initial scans were performed using an antenna height of 1.5 m and a measurement distance of 3 m. A tolerance line was set 6 dB below the specification limit and levels above the tolerance line were re-tested on the open area test site, at the appropriate distance, using a measuring receivers with a Quasi-Peak detector (below 1000 MHz), where applicable, for measurements above 1000 MHz average and peak detectors were used.

A2.6.4 For the main (final) measurements the EUT arranged on a non-conducting turn table on a standard test site compliant with ANSI C63.4 – 2001 Clause 5.4.

A2.6.5 On the open area test site, at each frequency where a signal was found, the levels were maximised by initially rotating the turntable through 360° and then varying the antenna height between 1 m and 4 m in the horizontal polarisation. At this point, any signals found to be between the limit and a level 6 dB below it were further maximised by changing the configuration of the EUT, e.g. re-routing cables to peripherals and moving peripherals with respect to the EUT. The procedure was repeated for the vertical polarisation.

A2.6.6 The final field strength was determined as the indicated level in dBuV plus cable loss and antenna factor.

Test Of: Nokia UK Ltd.

Cameron Imaging Phone 3650 (NHL-8) Mobile Phone Handset

To: FCC Part 24: 2001, FCC Part 15: 2001 and Part 2: 2001

---

A2.6.7 The test equipment settings for radiated emissions measurements were as follows:

Receiver Function	Initial Scan	Final Measurements Below 1GHz	Final Measurements Above 1 GHz
Detector Type:	Peak	Quasi-Peak (CISPR)	Peak/Average
Mode:	Max Hold	Not applicable	Not applicable
Bandwidth:	(120 kHz < 1GHz) (1MHz > 1GHz)	120 kHz	1 MHz (If Applicable)
Amplitude Range:	60 dB	20 dB	20 dB (typical)
Measurement Time:	Not applicable	> 1 s	> 1 s
Observation Time:	Not applicable	> 15 s	> 15 s
Step Size:	Continuous sweep	Not applicable	Not applicable
Sweep Time:	Coupled	Not applicable	Not applicable

Test Of: Nokia UK Ltd.

Cameron Imaging Phone 3650 (NHL-8) Mobile Phone Handset

To: FCC Part 24: 2001, FCC Part 15: 2001 and Part 2: 2001

---

### **Appendix 3. Test Configuration Drawings**

This appendix contains the following drawings:

<b>Drawing Reference Number</b>	<b>Title</b>
DRG\70413JD06\EMICON	Test configuration for measurement of conducted emissions
DRG\70413JD06\EMIRAD	Test configuration for measurement of radiated emissions
DRG\70413JD06\001	Schematic diagram of the EUT, support equipment and interconnecting cables used for the test

Test Of: Nokia UK Ltd.

Cameron Imaging Phone 3650 (NHL-8) Mobile Phone Handset

To: FCC Part 24: 2001, FCC Part 15: 2001 and Part 2: 2001

DRG\70413JD06\EMICON

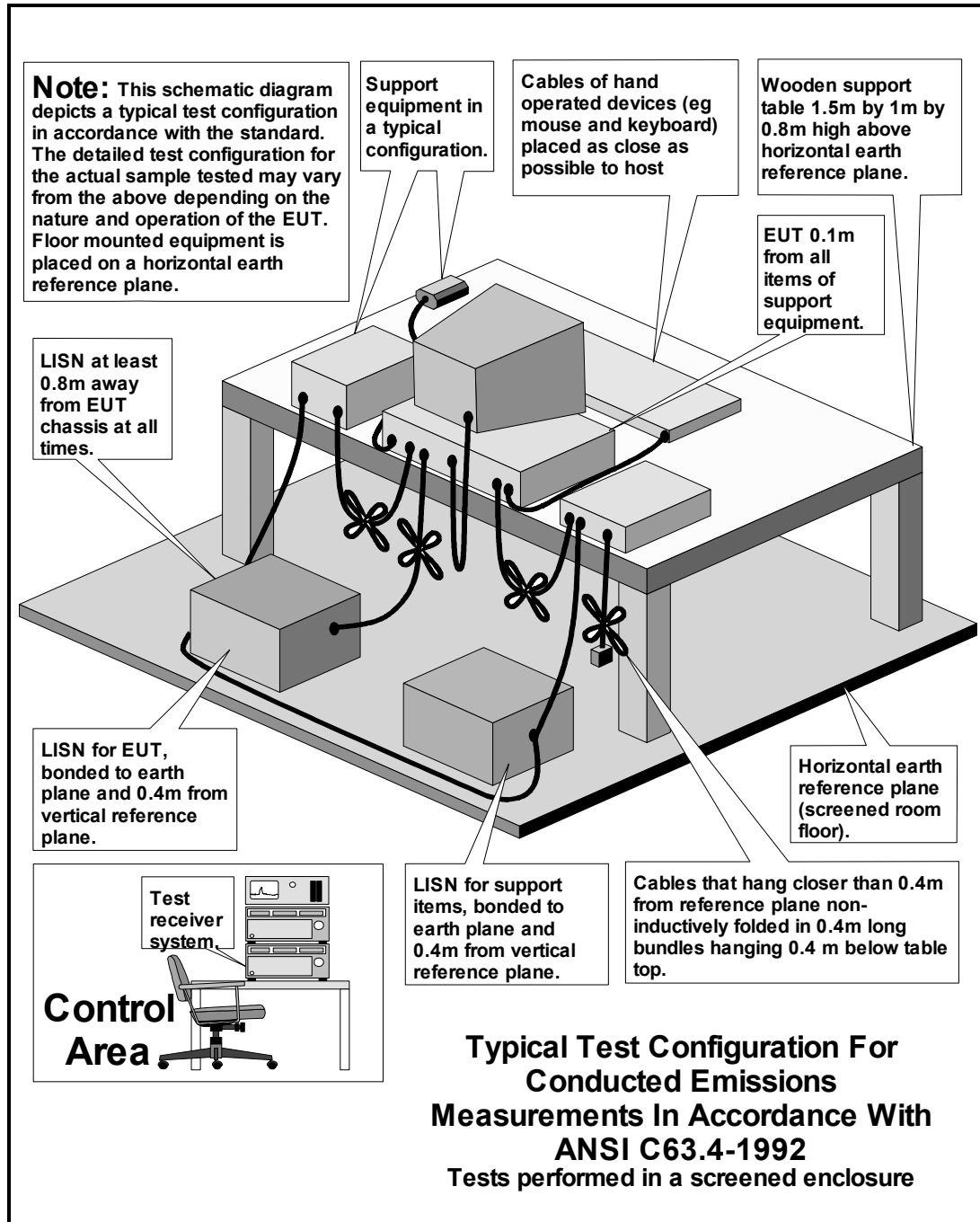



Test Of: Nokia UK Ltd.

Cameron Imaging Phone 3650 (NHL-8) Mobile Phone Handset

To: FCC Part 24: 2001, FCC Part 15: 2001 and Part 2: 2001

DRG\70413JD06\EMIRAD

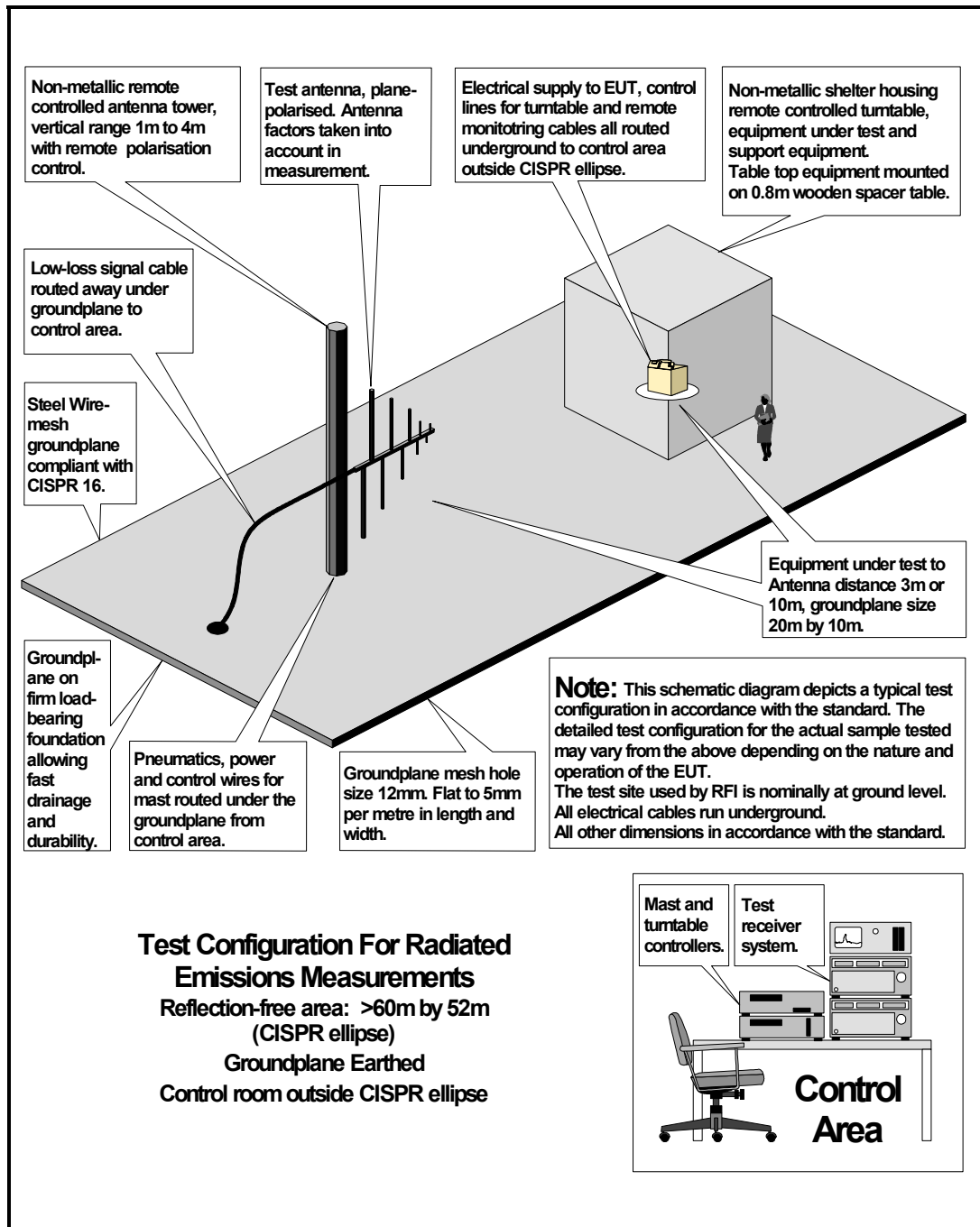

Test Of: Nokia UK Ltd.

Cameron Imaging Phone 3650 (NHL-8) Mobile Phone Handset

To: FCC Part 24: 2001, FCC Part 15: 2001 and Part 2: 2001

DRG\70413JD06\001

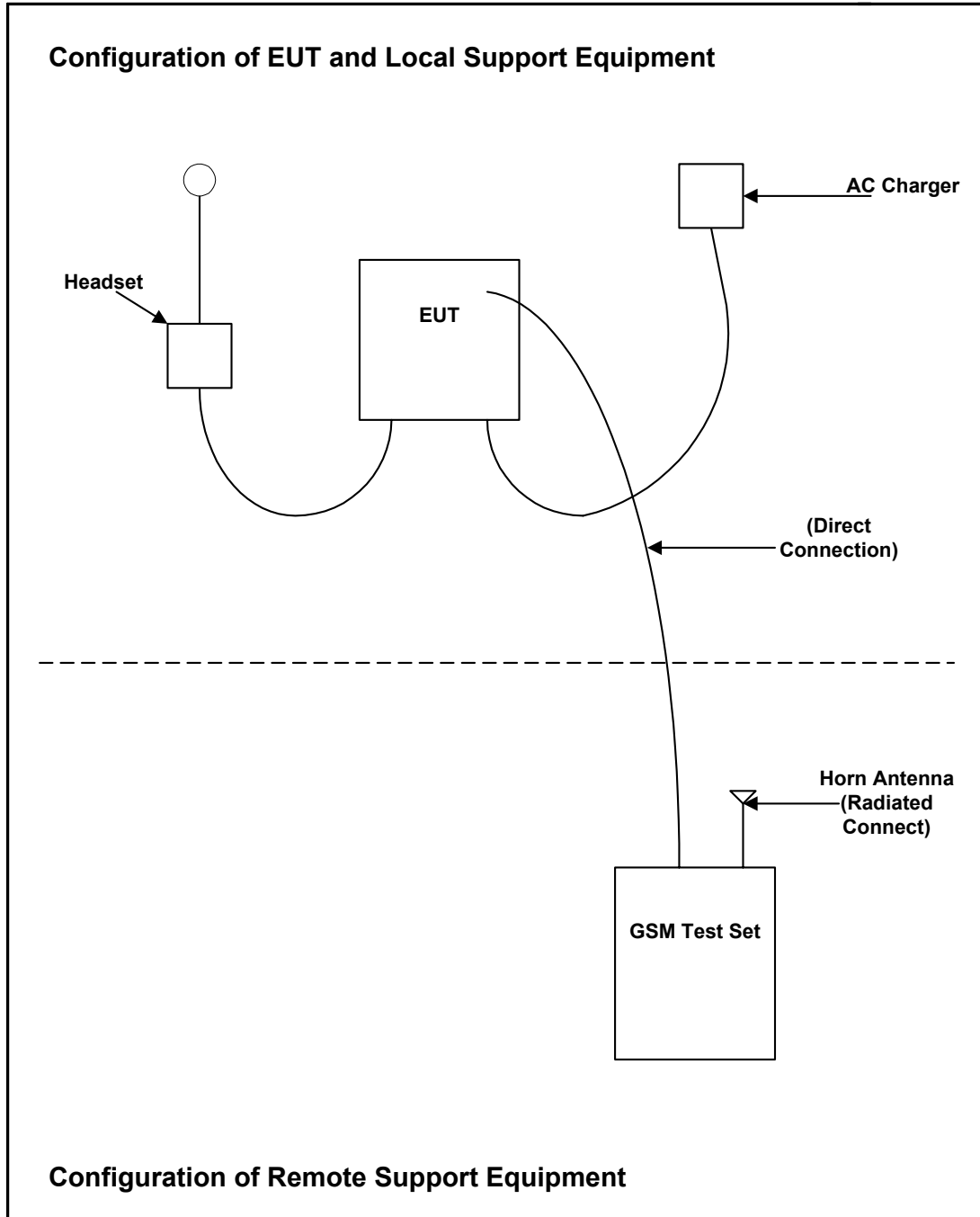

Test Of: Nokia UK Ltd.

Cameron Imaging Phone 3650 (NHL-8) Mobile Phone Handset

To: FCC Part 24: 2001, FCC Part 15: 2001 and Part 2: 2001

**Appendix 4. Graphical Test Results**

This appendix contains the following graphs:

Graph Reference Number	Title
GPH\70413JD06ce\003	Conducted Band Edge - Operating Condition :- Allocated Bottom Channel. 1.8489 GHz to 1.8501 GHz
GPH\70413JD06ce\004	Conducted Band Edge – Operating Condition :- Allocated Top Channel 1.9099 GHz to 1.9111 GHz
GPH\70413JD06ce\005	Conducted Emissions - Operating Condition :- Allocated Bottom Channel 1.0 MHz to 1.0 GHz
GPH\70413JD06ce\006	Conducted Emissions - Operating Condition :- Allocated Middle Channel 1.0 MHz to 1.0 GHz
GPH\70413JD06ce\007	Conducted Emissions - Operating Condition :- Allocated Top Channel 1.0 MHz to 1.0 GHz
GPH\70413JD06ce\012	Conducted Emissions - Operating Condition :- Allocated Bottom Channel 1.0 GHz to 1.1849 GHz
GPH\70413JD06ce\013	Conducted Emissions - Operating Condition :- Allocated Middle Channel 1.0 GHz to 1.1849 GHz
GPH\70413JD06ce\014	Conducted Emissions - Operating Condition :- Allocated Top Channel 1.0 GHz to 1.1849 GHz
GPH\70413JD06ce\015	Conducted Emissions - Operating Condition :- Allocated Bottom Channel 1.911 GHz to 2.0 GHz
GPH\70413JD06ce\016	Conducted Emissions - Operating Condition :- Allocated Middle Channel 1.911 GHz to 2.0 GHz
GPH\70413JD06ce\017	Conducted Emissions - Operating Condition :- Allocated Top Channel 1.911 GHz to 2.0 GHz
GPH\70413JD06ce\018	Conducted Emissions - Operating Condition :- Allocated Bottom Channel 2.0 GHz to 5.0 GHz
GPH\70413JD06ce\019	Conducted Emissions - Operating Condition :- Allocated Middle Channel 2.0 GHz to 5.0 GHz
GPH\70413JD06ce\020	Conducted Emissions - Operating Condition :- Allocated Top Channel 2.0 GHz to 5.0 GHz
GPH\70413JD06ce\021	Conducted Emissions - Operating Condition :- Allocated Bottom Channel 5.0 GHz to 10.0 GHz
GPH\70413JD06ce\022	Conducted Emissions - Operating Condition :- Allocated Middle Channel 5.0 GHz to 10.0 GHz
GPH\70413JD06ce\023	Conducted Emissions - Operating Condition :- Allocated Top Channel 5.0 GHz to 10.0 GHz
GPH\70413JD06ce\024	Conducted Emissions - Operating Condition :- Allocated Bottom Channel 10.0 GHz to 15.0 GHz

Test Of: Nokia UK Ltd.

Cameron Imaging Phone 3650 (NHL-8) Mobile Phone Handset

To: FCC Part 24: 2001, FCC Part 15: 2001 and Part 2: 2001

**Graphical Test Results (continued)**

Graph Reference Number	Title
GPH\70413JD06ce\025	Conducted Emissions - Operating Condition :- Allocated Middle Channel 10.0 GHz to 15.0 GHz
GPH\70413JD06ce\026	Conducted Emissions - Operating Condition :- Allocated Top Channel 10.0 GHz to 15.0 GHz
GPH\70413JD06ce\027	Conducted Emissions - Operating Condition :- Allocated Bottom Channel 15.0 GHz to 20.0 GHz
GPH\70413JD06ce\028	Conducted Emissions - Operating Condition :- Allocated Middle Channel 15.0 GHz to 20.0 GHz
GPH\70413JD06ce\029	Conducted Emissions - Operating Condition :- Allocated Top Channel 15.0 GHz to 20.0 GHz
GPH\70413JD06\001	Radiated Emissions – Operating Condition :- Allocated Middle Channel 4.0 GHz to 5.0 GHz
GPH\70413JD06\002	Radiated Emissions – Operating Condition :- Idle Mode 4.0 GHz to 5.0 GHz
GPH\70413JD06\003	Radiated Emissions – Operating Condition :- Allocated Middle Channel 5.0 GHz to 6.0 GHz
GPH\70413JD06\004	Radiated Emissions – Operating Condition :- Idle Mode 5.0 GHz to 6.0 GHz
GPH\70413JD06\007	Radiated Emissions – Operating Condition :- Allocated Middle Channel 6.0 GHz to 8.0 GHz
GPH\70413JD06\008	Radiated Emissions – Operating Condition :- Idle Mode 6.0 GHz to 8.0 GHz
GPH\70413JD06\009	Radiated Emissions – Operating Condition :- Allocated Middle Channel 8.0 GHz to 12.5 GHz
GPH\70413JD06\010	Radiated Emissions – Operating Condition :- Idle Mode 8.0 GHz to 12.5 GHz
GPH\70413JD06\011	Radiated Emissions – Operating Condition :- Allocated Middle Channel 12.5 GHz to 18.0 GHz
GPH\70413JD06\012	Radiated Emissions – Operating Condition :- Idle Mode 12.5 GHz to 18.0 GHz
GPH\70413JD06\013	Radiated Emissions – Operating Condition :- Allocated Middle Channel 18.0 GHz to 26.5 GHz
GPH\70413JD06\015	Radiated Emissions – Operating Condition :- Idle Mode 18.0 GHz to 26.5 GHz
GPH\70413JD06\022	Radiated Emissions – Operating Condition – Idle Mode 30.0 MHz to 1.0 GHz
GPH\70413JD06\023	Radiated Emissions – Operating Condition – Allocated Middle Channel 30.0 MHz to 1.0 GHz

Test Of: Nokia UK Ltd.

Cameron Imaging Phone 3650 (NHL-8) Mobile Phone Handset

To: FCC Part 24: 2001, FCC Part 15: 2001 and Part 2: 2001

**Graphical Test Results (continued)**

Graph Reference Number	Title
GPH\70413JD06\024	Radiated Emissions – Operating Condition – Allocated Middle Channel 1.0 GHz to 2.0 GHz
GPH\70413JD06\025	Radiated Emissions – Operating Condition – Idle Mode 1.0 GHz to 2.0 GHz
GPH\70413JD06\026	Radiated Emissions – Operating Condition – Idle Mode 2.0 GHz to 4.0 GHz
GPH\70413JD06\027	Radiated Emissions – Operating Condition – Allocated Middle Channel 2.0 GHz to 4.0 GHz
GPH\70413JD06\028	Conducted Emissions – Operating Conditions – Idle Mode 150.0 kHz to 30.0 MHz
GPH\70413JD06BE\001	Radiated Band Edge - Operating Condition :- Allocated Bottom Channel. 1.8489 GHz to 1.8501 GHz
GPH\70413JD06BE\002	Radiated Band Edge - Operating Condition :- Allocated Top Channel 1.9099 GHz to 1.9111 GHz

Test Of: Nokia UK Ltd.

Cameron Imaging Phone 3650 (NHL-8) Mobile Phone Handset

To: FCC Part 24: 2001, FCC Part 15: 2001 and Part 2: 2001

GPH\70413JD06CE\003

Conducted Band Edge.

Test for Nokia of NHL-8XX CAMERON M.S. IMEI:-004400/11/1753558/3.

Operating Condition :- Allocated Bottom Channel.

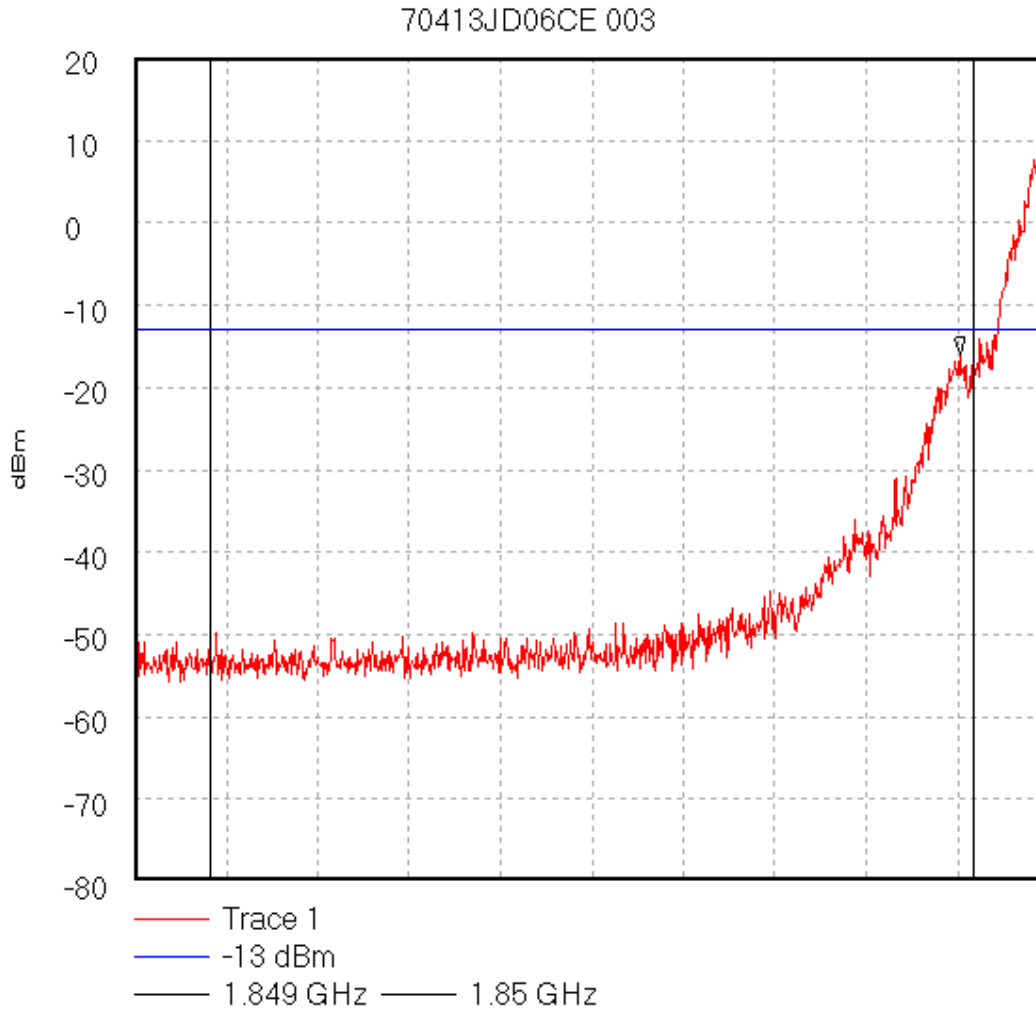

Start 1.8489 GHz; Stop 1.8501 GHz

Ref 20 dBm; Ref Offset 51.0 dB; 10 dB/div

RBW 3.0 kHz; VBW 3.0 kHz; Att 5 dB; Swp 400.0 mS

Marker 1.849984 GHz, -15.95 dBm

Display Line: -13 dBm;

28/10/02 08:50:30

Test Of: Nokia UK Ltd.

Cameron Imaging Phone 3650 (NHL-8) Mobile Phone Handset

To: FCC Part 24: 2001, FCC Part 15: 2001 and Part 2: 2001

GPH\70413JD06CE\004

Conducted Band Edge.

Test for Nokia of NHL-8XX CAMERON M.S. IMEI:-004400/11/1753558/3.

Operating Condition :- Allocated Top Channel.

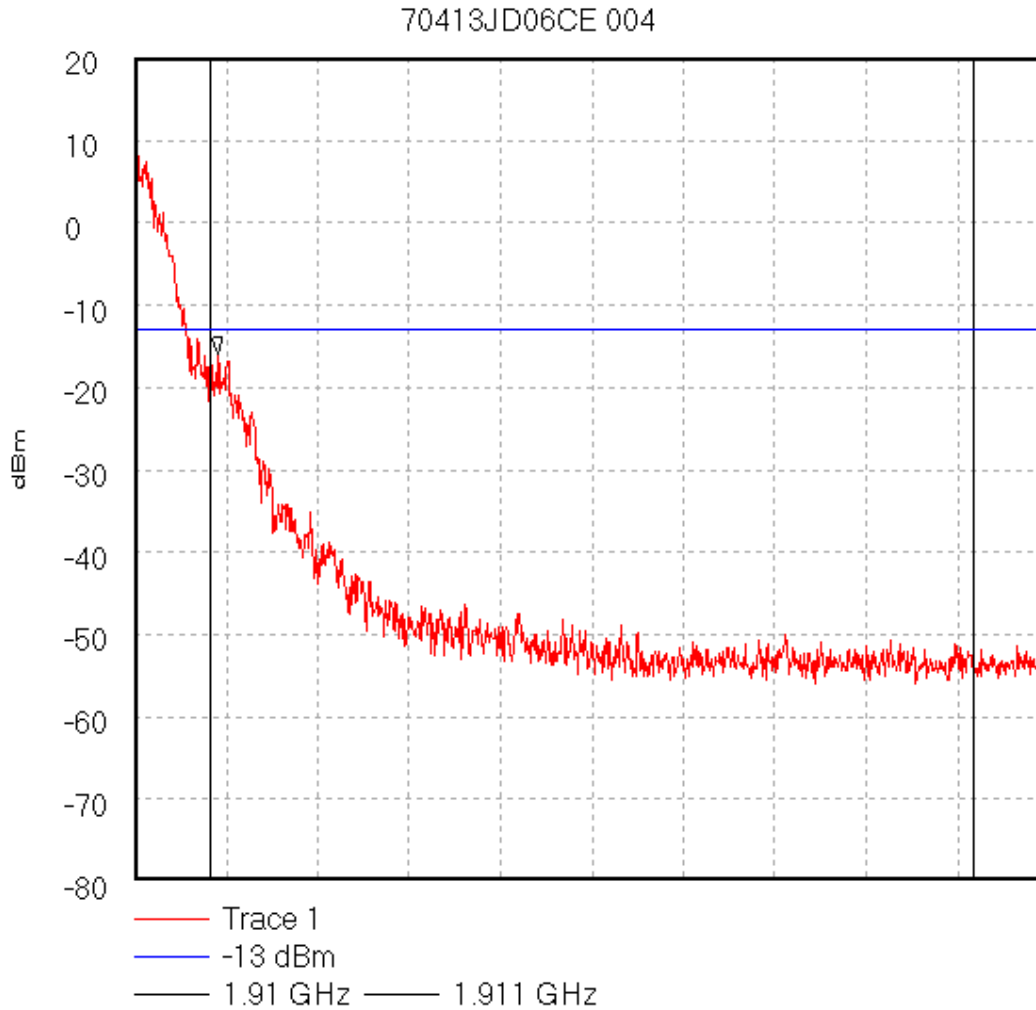

Start 1.9099 GHz; Stop 1.911 GHz

Ref 20 dBm; Ref Offset 50.7 dB; 10 dB/div

RBW 3.0 kHz; VBW 3.0 kHz; Att 5 dB; Swp 400.0 mS

Marker 1.910009 GHz, -15.95 dBm

Display Line: -13 dBm;

28/10/02 08:53:16

Test Of: Nokia UK Ltd.

Cameron Imaging Phone 3650 (NHL-8) Mobile Phone Handset

To: FCC Part 24: 2001, FCC Part 15: 2001 and Part 2: 2001

GPH\70413JD06CE\005

Conducted Antenna Port Spurious Emissions

Test for Nokia of NHL-8XX CAMERON M.S. IMEI:-004400/11/1753558/3.

Operating Condition :- Allocated Bottom Channel.

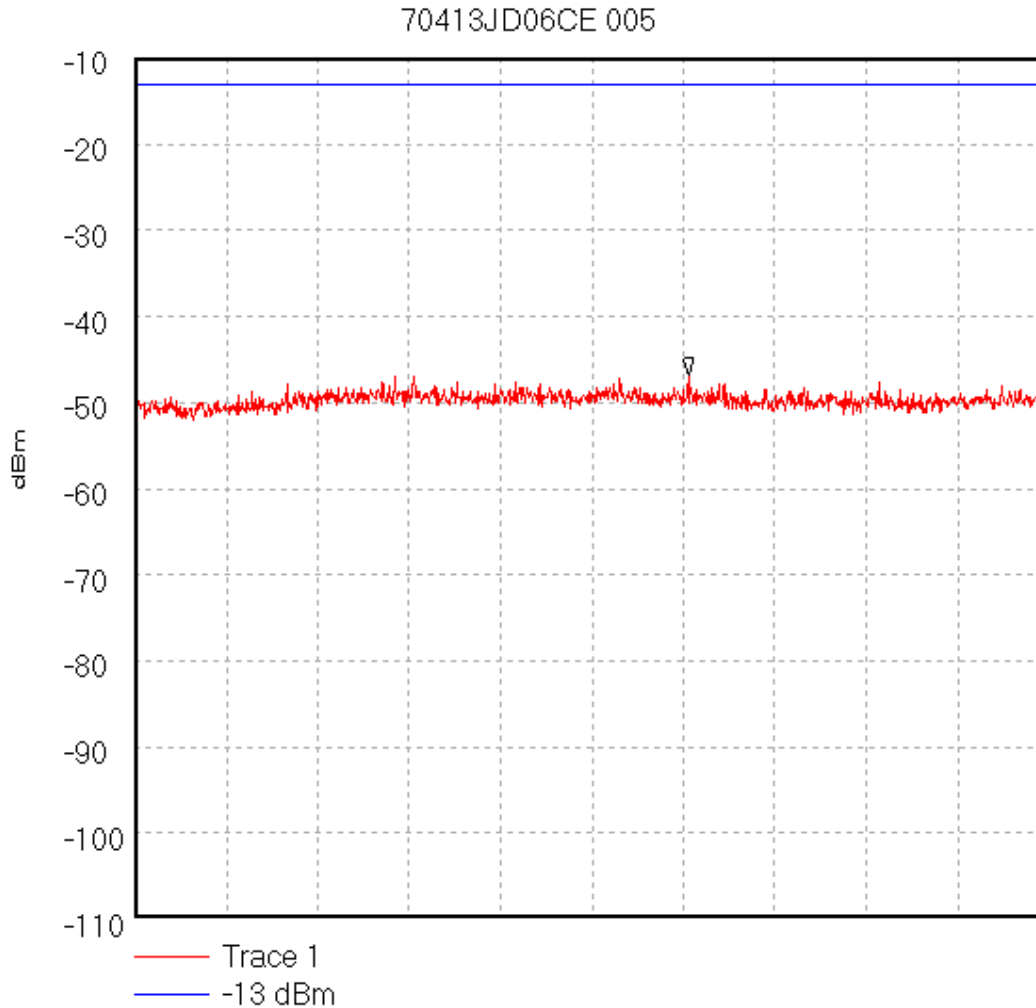

Start 1.0 MHz; Stop 1.0 GHz

Ref -10 dBm; Ref Offset 50.8 dB; 10 dB/div

RBW 10.0 kHz; VBW 10.0 kHz; Att 5 dB; Swp 30.0 S

Peak 607.06 MHz, -46.89 dBm

Display Line: -13 dBm;

28/10/02 10:17:34



Test Of: Nokia UK Ltd.

Cameron Imaging Phone 3650 (NHL-8) Mobile Phone Handset

To: FCC Part 24: 2001, FCC Part 15: 2001 and Part 2: 2001

GPH\70413JD06CE\006

Conducted Antenna Port Spurious Emissions

Test for Nokia of NHL-8XX CAMERON M.S. IMEI:-004400/11/1753558/3.

Operating Condition :- Allocated Middle Channel.

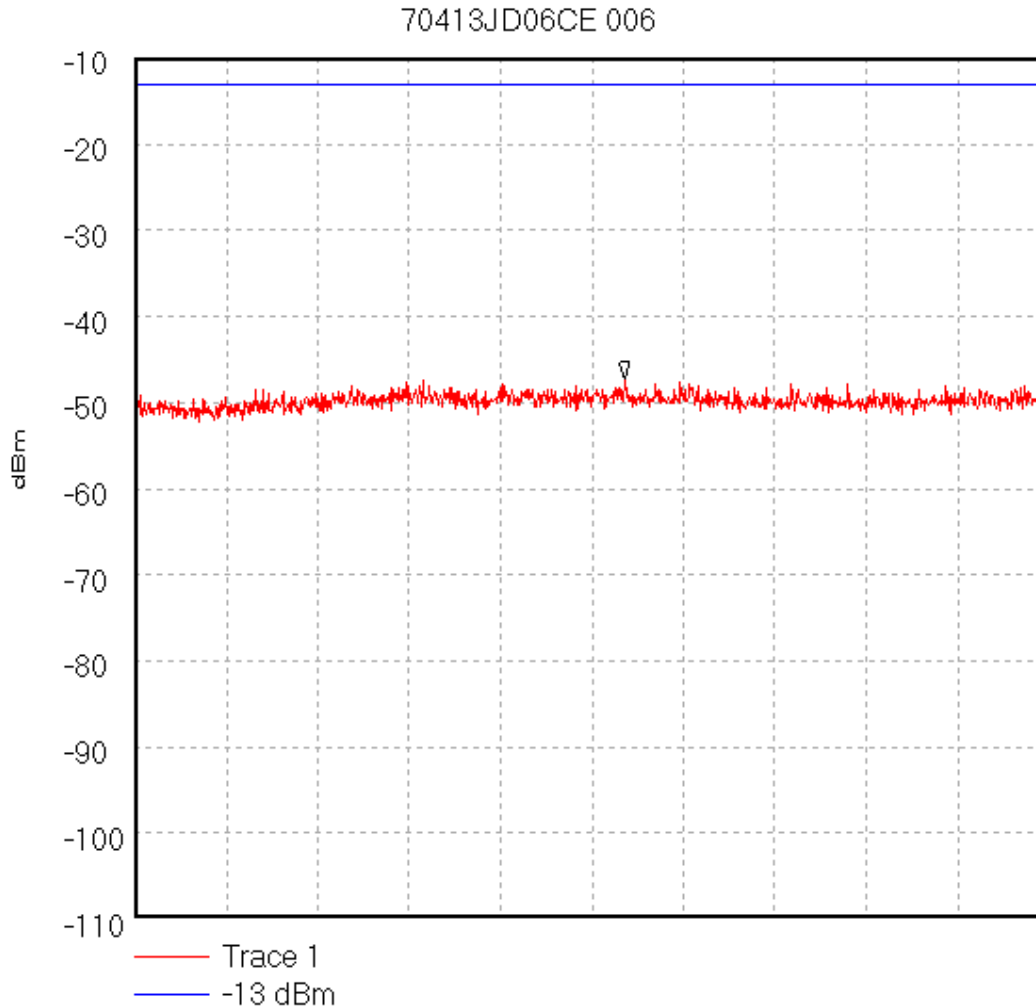

Start 1.0 MHz; Stop 1.0 GHz

Ref -10 dBm; Ref Offset 50.8 dB; 10 dB/div

RBW 10.0 kHz; VBW 10.0 kHz; Att 5 dB; Swp 30.0 S

Peak 537.13 MHz, -47.32 dBm

Display Line: -13 dBm;

28/10/02 10:20:06

Test Of: Nokia UK Ltd.

Cameron Imaging Phone 3650 (NHL-8) Mobile Phone Handset

To: FCC Part 24: 2001, FCC Part 15: 2001 and Part 2: 2001

GPH\70413JD06CE\007

Conducted Antenna Port Spurious Emissions

Test for Nokia of NHL-8XX CAMERON M.S. IMEI:-004400/11/1753558/3.

Operating Condition :- Allocated Top Channel.

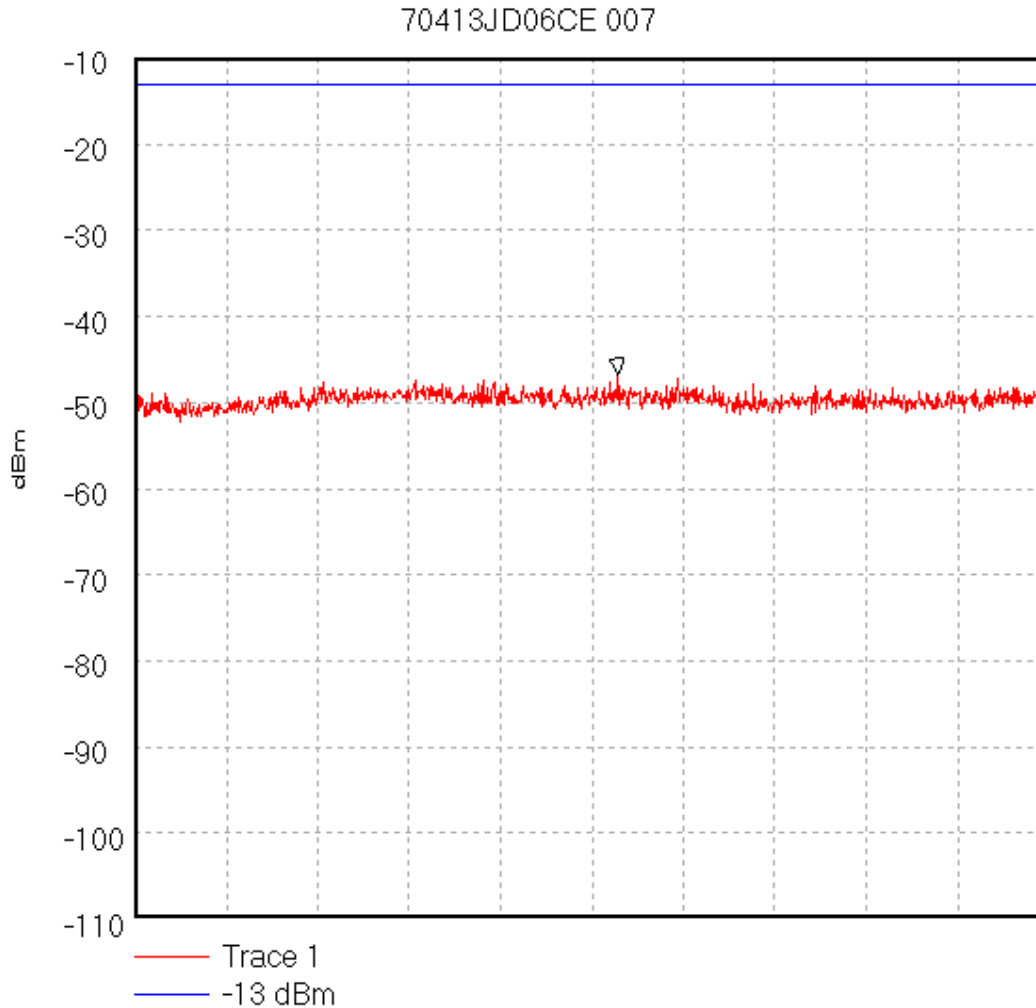

Start 1.0 MHz; Stop 1.0 GHz

Ref -10 dBm; Ref Offset 50.8 dB; 10 dB/div

RBW 10.0 kHz; VBW 10.0 kHz; Att 5 dB; Swp 30.0 S

Peak 529.36 MHz, -46.76 dBm

Display Line: -13 dBm;

28/10/02 10:21:14

Test Of: Nokia UK Ltd.

Cameron Imaging Phone 3650 (NHL-8) Mobile Phone Handset

To: FCC Part 24: 2001, FCC Part 15: 2001 and Part 2: 2001

GPH\70413JD06CE\012

Conducted Antenna Port Spurious Emissions

Test for Nokia of NHL-8XX CAMERON M.S. IMEI:-004400/11/1753558/3.

Operating Condition :- Allocated Bottom Channel.

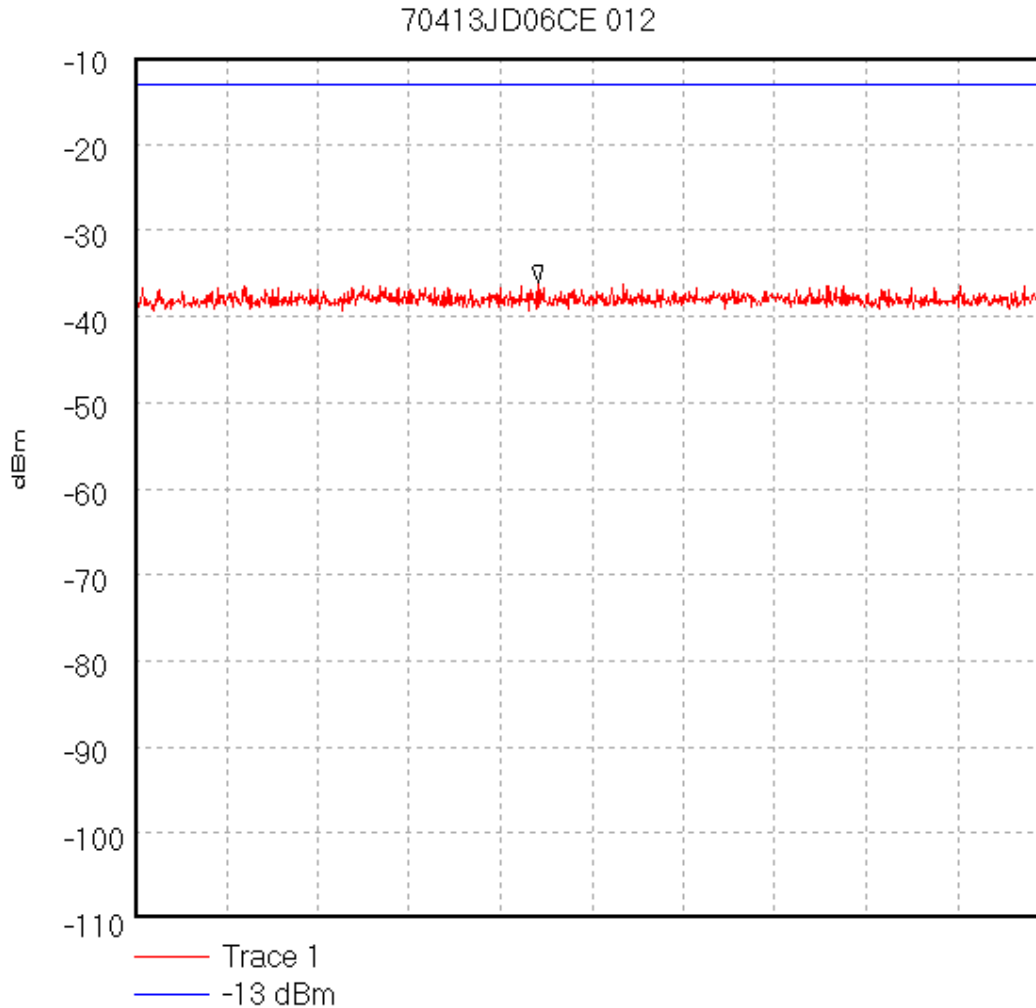

Start 1.0 GHz; Stop 1.1849 GHz

Ref -10 dBm; Ref Offset 41.2 dB; 10 dB/div

RBW 1.0 MHz; VBW 1.0 MHz; Att 5 dB; Swp 20.0 mS

Peak 1.081561 GHz, -36.02 dBm

Display Line: -13 dBm;

28/10/02 11:59:12

Test Of: Nokia UK Ltd.

Cameron Imaging Phone 3650 (NHL-8) Mobile Phone Handset

To: FCC Part 24: 2001, FCC Part 15: 2001 and Part 2: 2001

GPH\70413JD06CE\013

Conducted Antenna Port Spurious Emissions

Test for Nokia of NHL-8XX CAMERON M.S. IMEI:-004400/11/1753558/3.

Operating Condition :- Allocated Middle Channel.

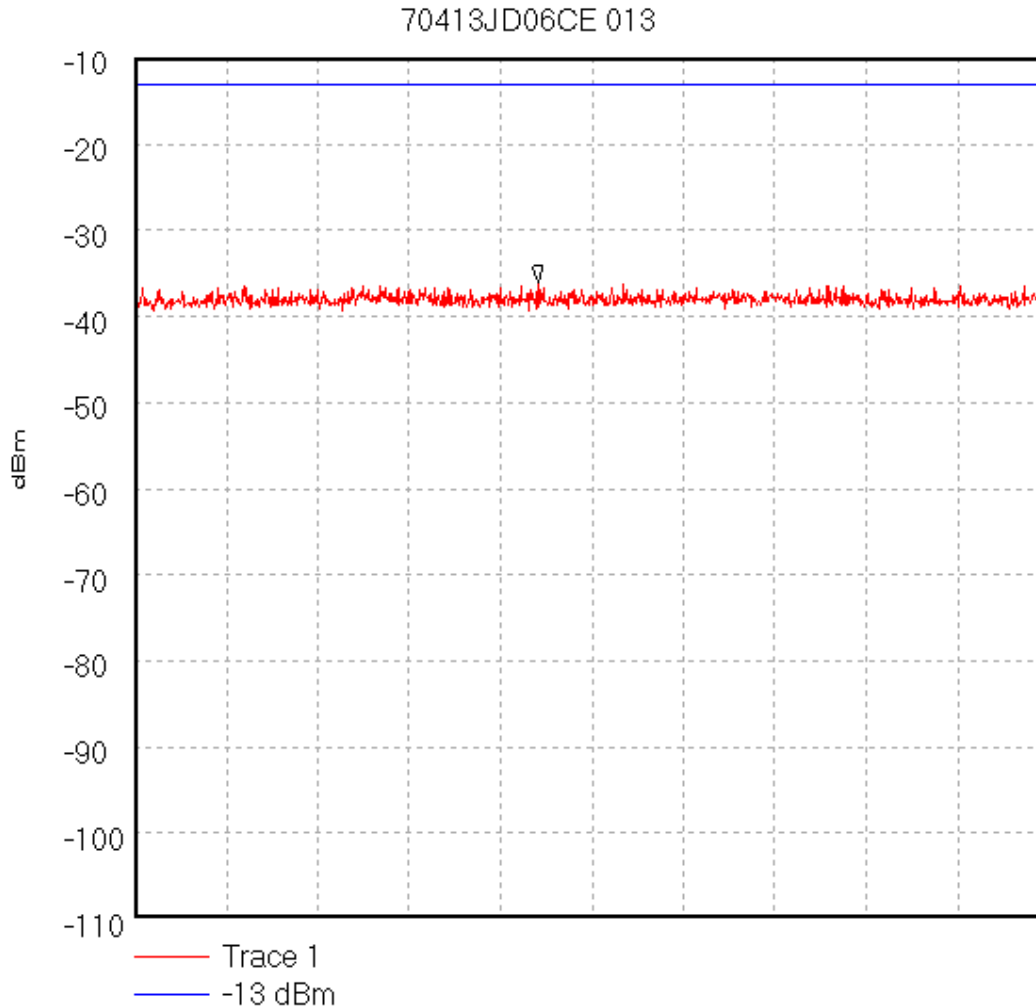

Start 1.0 GHz; Stop 1.1849 GHz

Ref -10 dBm; Ref Offset 41.2 dB; 10 dB/div

RBW 1.0 MHz; VBW 1.0 MHz; Att 5 dB; Swp 20.0 mS

Peak 1.081561 GHz, -36.02 dBm

Display Line: -13 dBm;

28/10/02 11:59:47

Test Of: Nokia UK Ltd.

Cameron Imaging Phone 3650 (NHL-8) Mobile Phone Handset

To: FCC Part 24: 2001, FCC Part 15: 2001 and Part 2: 2001

GPH\70413JD06CE\014

Conducted Antenna Port Spurious Emissions

Test for Nokia of NHL-8XX CAMERON M.S. IMEI:-004400/11/1753558/3.

Operating Condition :- Allocated Top Channel.

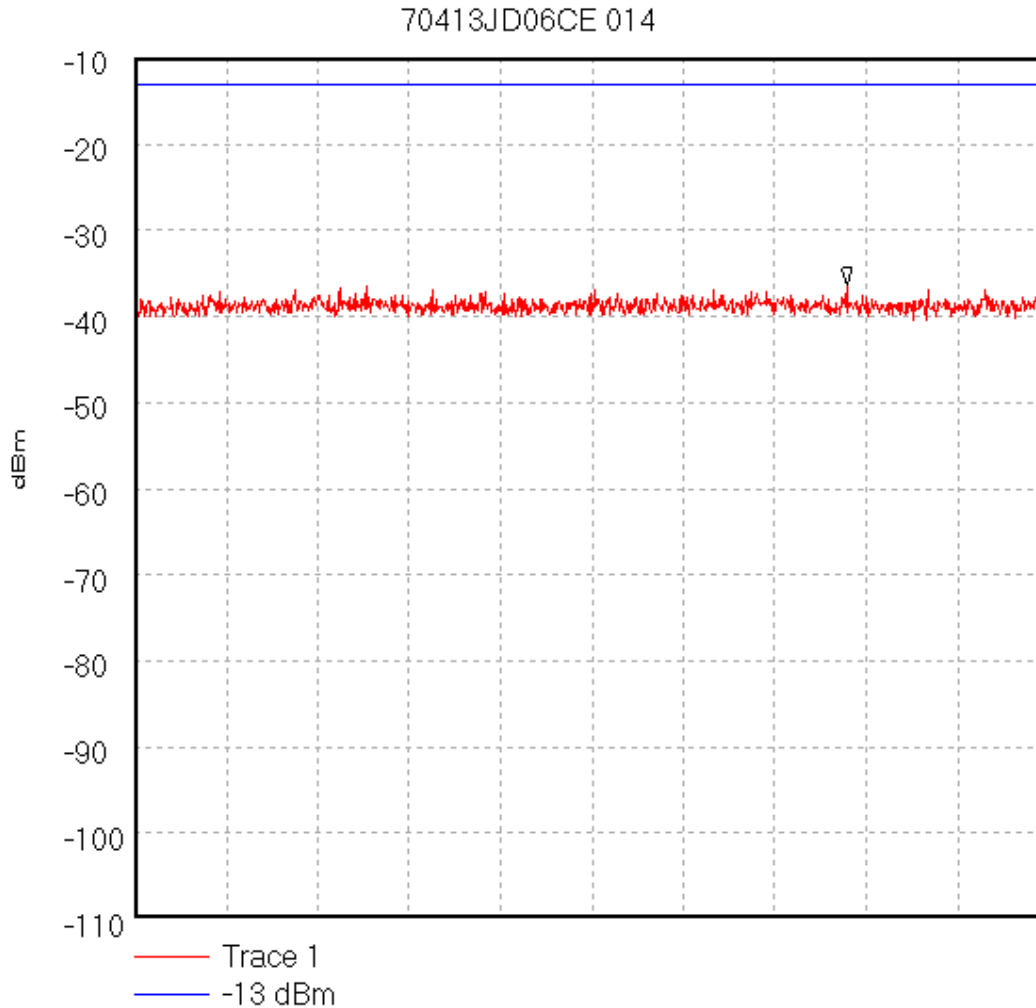

Start 1.0 GHz; Stop 1.1849 GHz

Ref -10 dBm; Ref Offset 41.2 dB; 10 dB/div

RBW 1.0 MHz; VBW 1.0 MHz; Att 5 dB; Swp 20.0 mS

Peak 1.144222 GHz, -36.35 dBm

Display Line: -13 dBm;

28/10/02 12:00:14

Test Of: Nokia UK Ltd.

Cameron Imaging Phone 3650 (NHL-8) Mobile Phone Handset

To: FCC Part 24: 2001, FCC Part 15: 2001 and Part 2: 2001

GPH\70413JD06CE\015

Conducted Antenna Port Spurious Emissions

Test for Nokia of NHL-8XX CAMERON M.S. IMEI:-004400/11/1753558/3.

Operating Condition :- Allocated Bottom Channel.

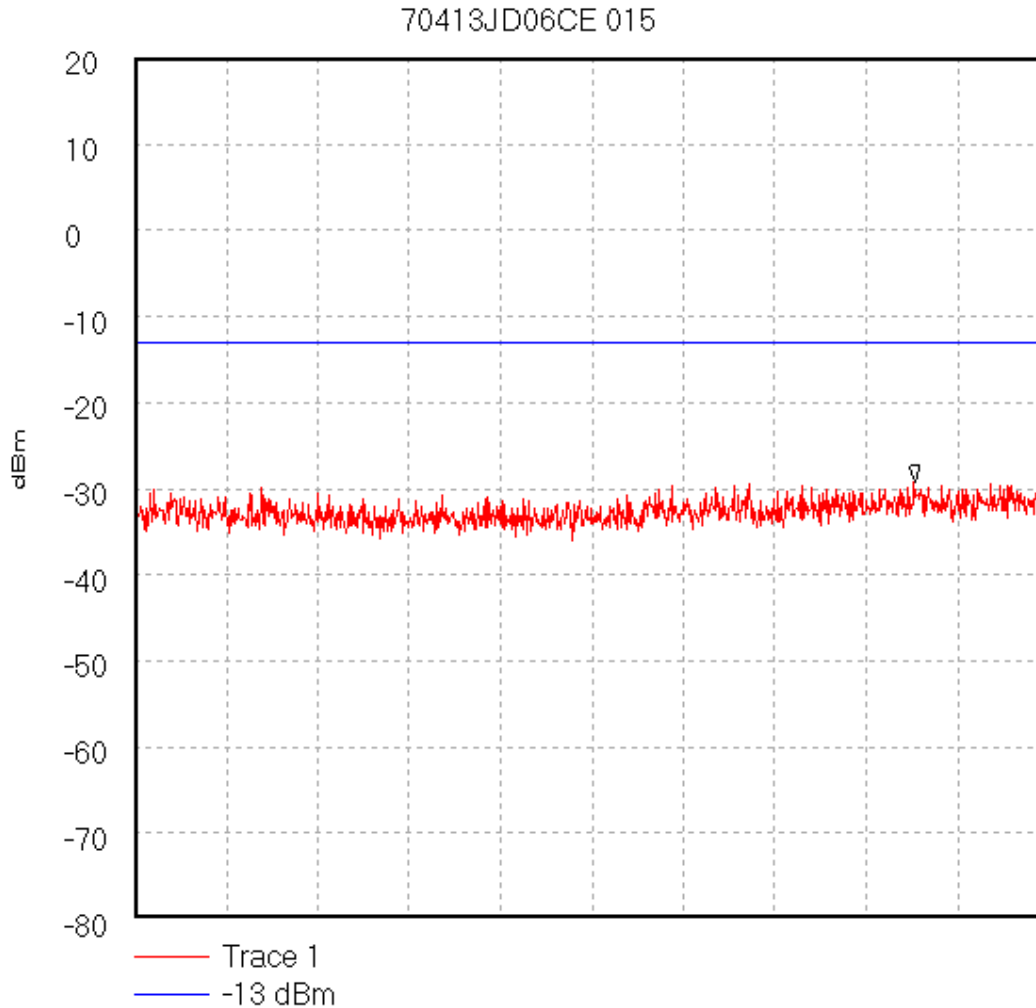

Start 1.911 GHz; Stop 2.0 GHz

Ref 20 dBm; Ref Offset 41.2 dB; 10 dB/div

RBW 1.0 MHz; VBW 1.0 MHz; Att 5 dB; Swp 20.0 mS

Peak 1.986947 GHz, -29.26 dBm

Display Line: -13 dBm;

28/10/02 12:02:18

Test Of: Nokia UK Ltd.

Cameron Imaging Phone 3650 (NHL-8) Mobile Phone Handset

To: FCC Part 24: 2001, FCC Part 15: 2001 and Part 2: 2001

GPH\70413JD06CE\016

Conducted Antenna Port Spurious Emissions

Test for Nokia of NHL-8XX CAMERON M.S. IMEI:-004400/11/1753558/3.

Operating Condition :- Allocated Middle Channel.

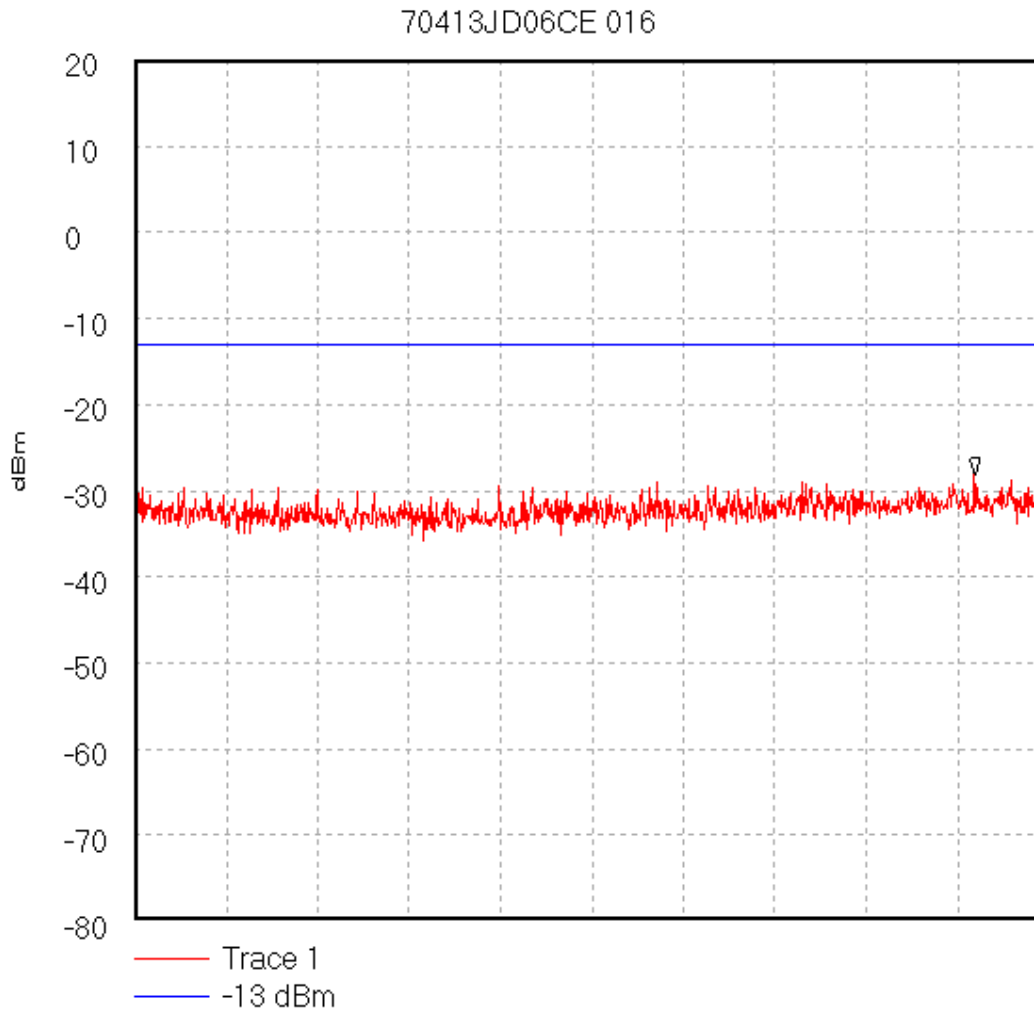

Start 1.911 GHz; Stop 2.0 GHz

Ref 20 dBm; Ref Offset 41.2 dB; 10 dB/div

RBW 1.0 MHz; VBW 1.0 MHz; Att 5 dB; Swp 20.0 mS

Peak 1.992781 GHz, -28.24 dBm

Display Line: -13 dBm;

28/10/02 12:02:49

Test Of: Nokia UK Ltd.

Cameron Imaging Phone 3650 (NHL-8) Mobile Phone Handset

To: FCC Part 24: 2001, FCC Part 15: 2001 and Part 2: 2001

GPH\70413JD06CE\017

Conducted Antenna Port Spurious Emissions

Test for Nokia of NHL-8XX CAMERON M.S. IMEI:-004400/11/1753558/3.

Operating Condition :- Allocated Top Channel.

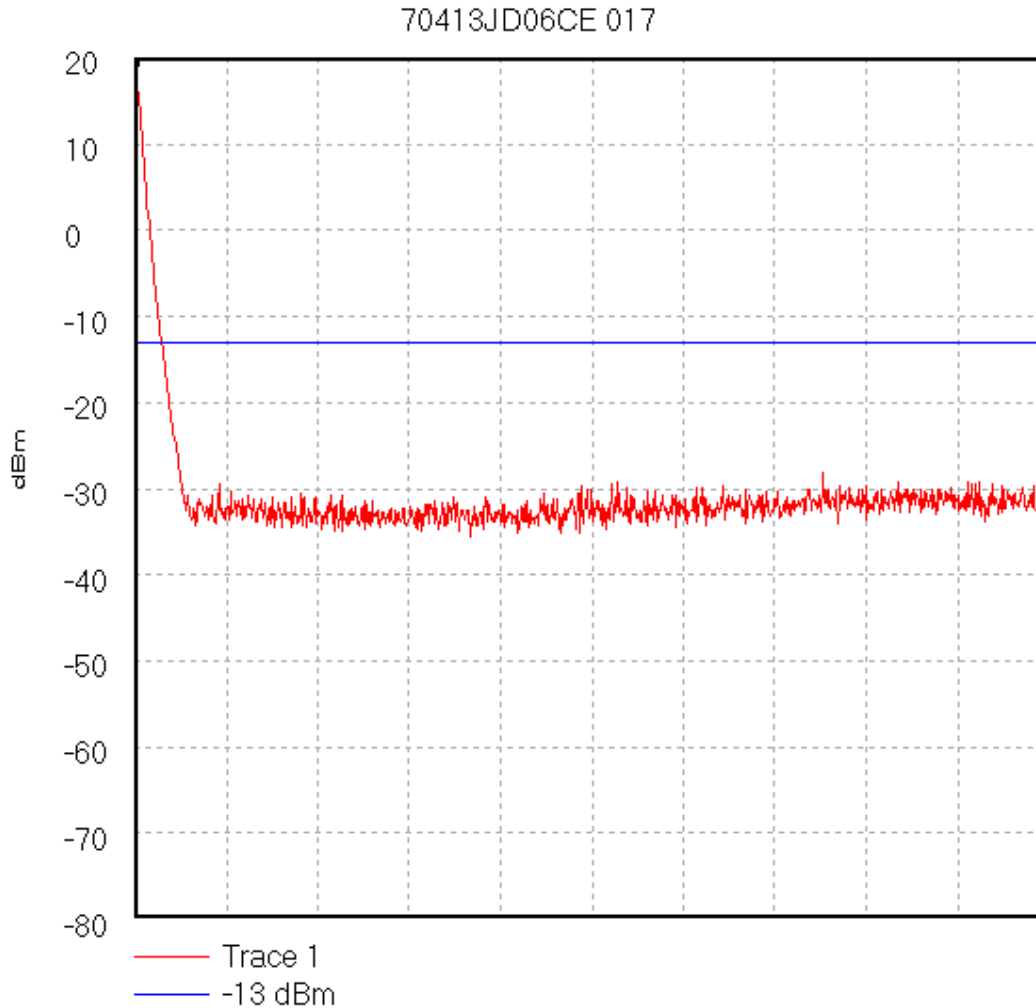

Start 1.911 GHz; Stop 2.0 GHz

Ref 20 dBm; Ref Offset 41.2 dB; 10 dB/div

RBW 1.0 MHz; VBW 1.0 MHz; Att 5 dB; Swp 20.0 mS

Peak 1.911 GHz, 17.69 dBm

Display Line: -13 dBm;

28/10/02 12:03:32



Test Of: Nokia UK Ltd.

Cameron Imaging Phone 3650 (NHL-8) Mobile Phone Handset

To: FCC Part 24: 2001, FCC Part 15: 2001 and Part 2: 2001

GPH\70413JD06CE\018

Test for Nokia of NHL-8XX CAMERON M.S. IMEI:-004400/11/1753558/3.

Operating Condition :- Allocated Bottom Channel.

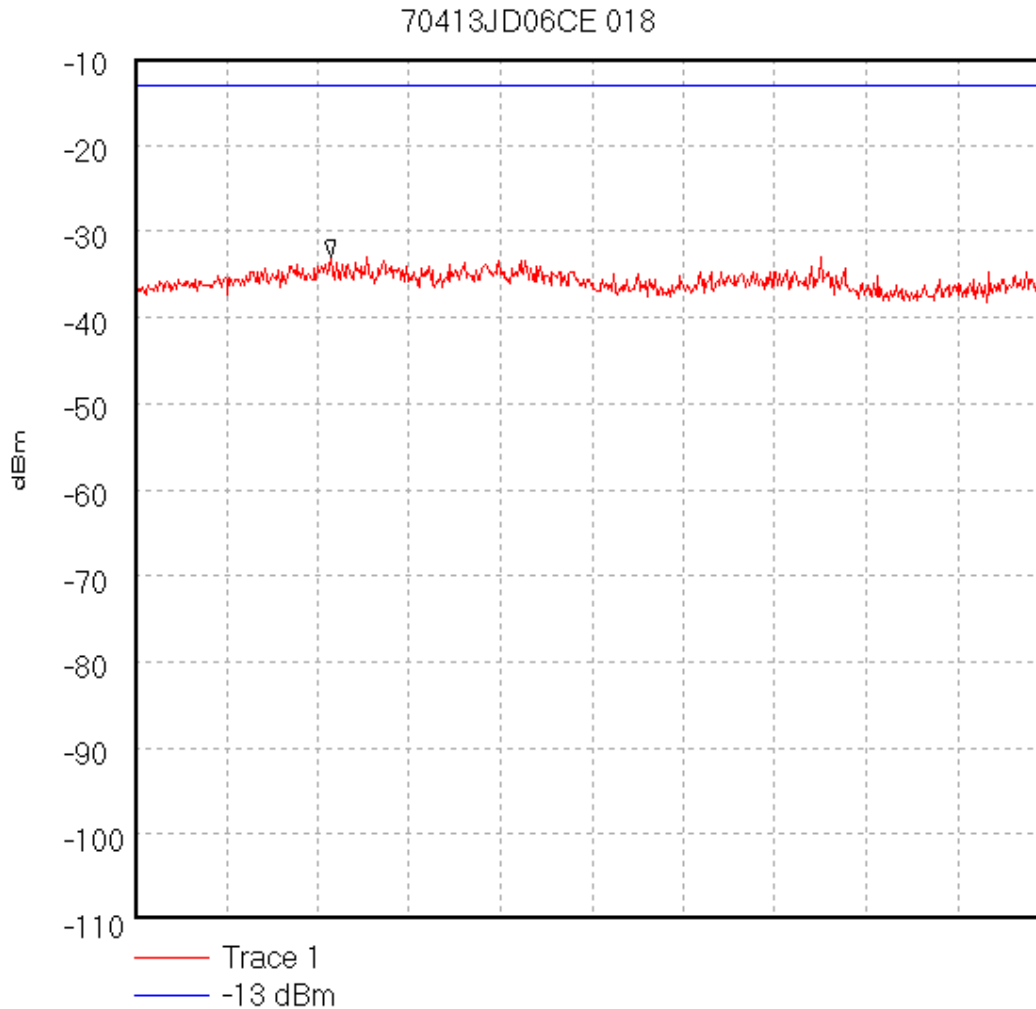

Start 2.0 GHz; Stop 5.0 GHz

Ref -10 dBm; Ref Offset 36.2 dB; 10 dB/div

RBW 1.0 MHz; VBW 1.0 MHz; Att 10 dB; Swp 60.0 mS

Peak 2.645 GHz, -33.0 dBm

Display Line: -13 dBm; ; Limit Test Passed

28/10/02 16:42:03

Test Of: Nokia UK Ltd.

Cameron Imaging Phone 3650 (NHL-8) Mobile Phone Handset

To: FCC Part 24: 2001, FCC Part 15: 2001 and Part 2: 2001

GPH\70413JD06CE\019

Test for Nokia of NHL-8XX CAMERON M.S. IMEI:-004400/11/1753558/3.

Operating Condition :- Allocated Middle Channel.

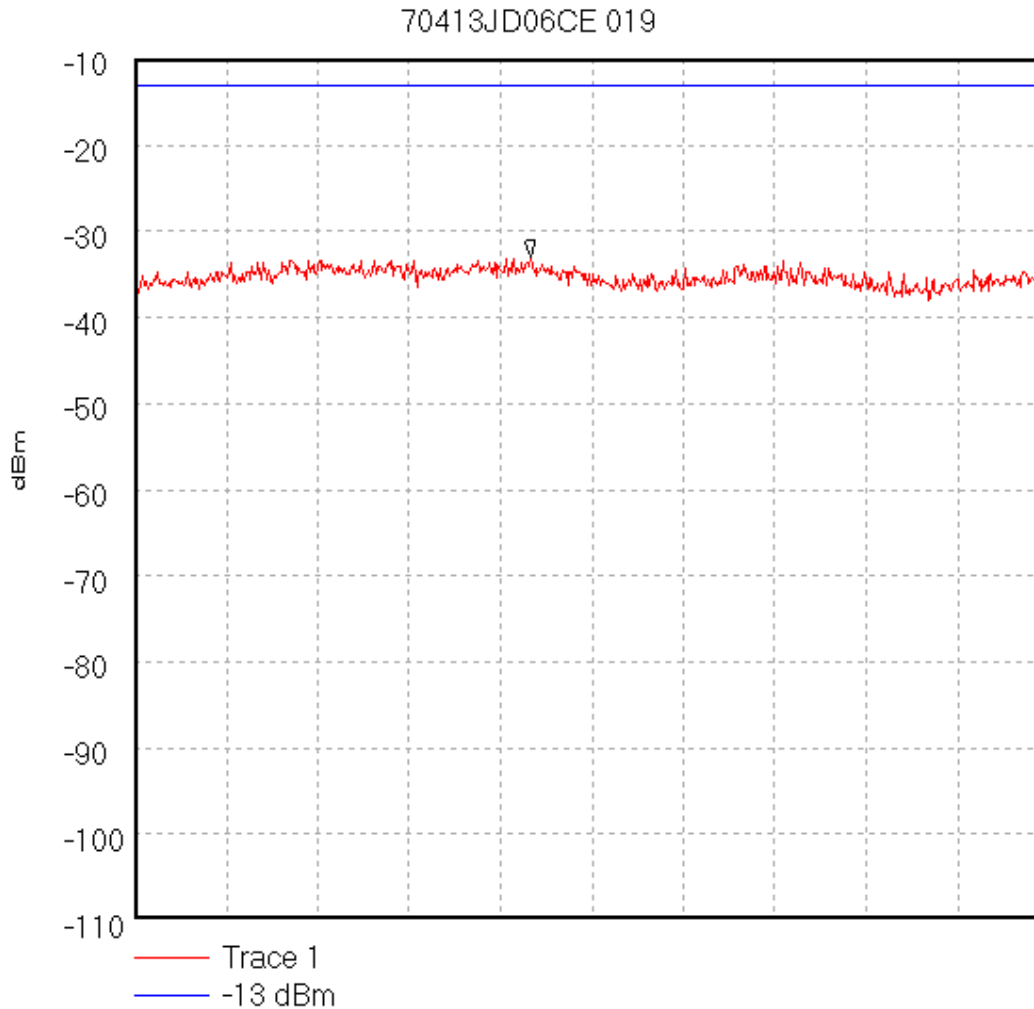

Start 2.0 GHz; Stop 5.0 GHz

Ref -10 dBm; Ref Offset 36.2 dB; 10 dB/div

RBW 1.0 MHz; VBW 1.0 MHz; Att 10 dB; Swp 60.0 mS

Peak 3.3 GHz, -33.0 dBm

Display Line: -13 dBm; ; Limit Test Passed

28/10/02 16:44:26

Test Of: Nokia UK Ltd.

Cameron Imaging Phone 3650 (NHL-8) Mobile Phone Handset

To: FCC Part 24: 2001, FCC Part 15: 2001 and Part 2: 2001

GPH\70413JD06CE\020

Test for Nokia of NHL-8XX CAMERON M.S. IMEI:-004400/11/1753558/3.

Operating Condition :- Allocated Top Channel.

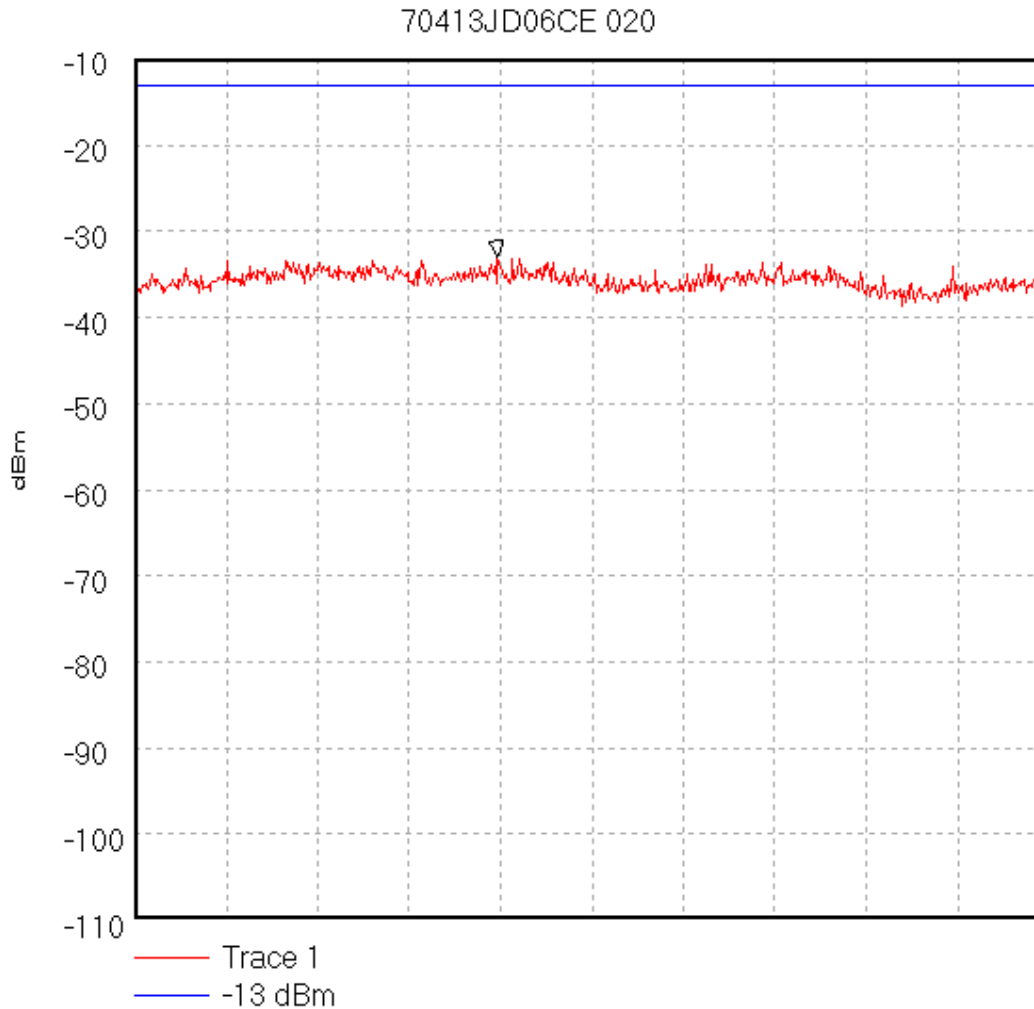

Start 2.0 GHz; Stop 5.0 GHz

Ref -10 dBm; Ref Offset 36.2 dB; 10 dB/div

RBW 1.0 MHz; VBW 1.0 MHz; Att 10 dB; Swp 60.0 mS

Peak 3.19 GHz, -33.0 dBm

Display Line: -13 dBm; ; Limit Test Passed

28/10/02 16:45:10

Test Of: Nokia UK Ltd.

Cameron Imaging Phone 3650 (NHL-8) Mobile Phone Handset

To: FCC Part 24: 2001, FCC Part 15: 2001 and Part 2: 2001

GPH\70413JD06CE\021

Test for Nokia of NHL-8XX CAMERON M.S. IMEI:-004400/11/1753558/3.

Operating Condition :- Allocated Bottom Channel.

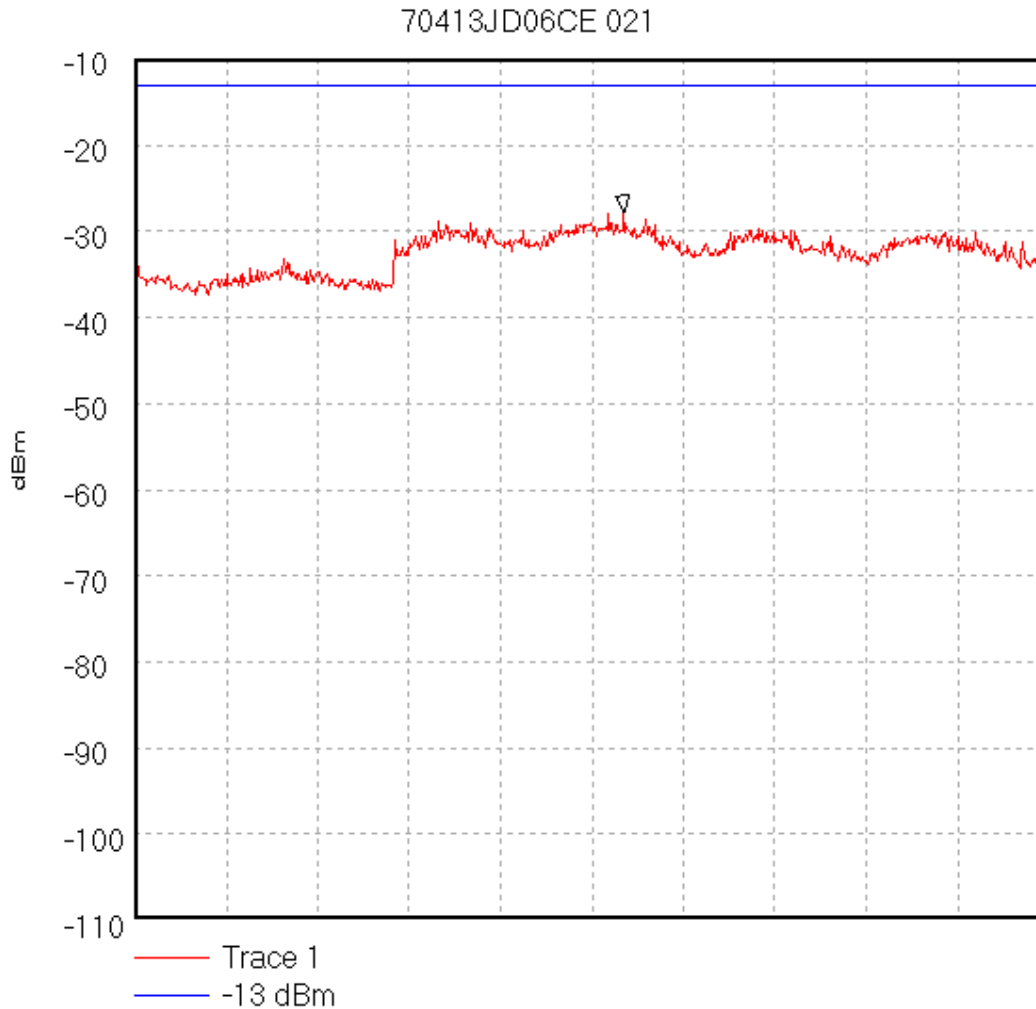

Start 5.0 GHz; Stop 10.0 GHz

Ref -10 dBm; Ref Offset 36.2 dB; 10 dB/div

RBW 1.0 MHz; VBW 1.0 MHz; Att 10 dB; Swp 100.0 mS

Peak 7.675 GHz, -27.83 dBm

Display Line: -13 dBm; ; Limit Test Passed

28/10/02 16:48:46

Test Of: Nokia UK Ltd.

Cameron Imaging Phone 3650 (NHL-8) Mobile Phone Handset

To: FCC Part 24: 2001, FCC Part 15: 2001 and Part 2: 2001

GPH\70413JD06CE\022

Test for Nokia of NHL-8XX CAMERON M.S. IMEI:-004400/11/1753558/3.

Operating Condition :- Allocated Middle Channel.

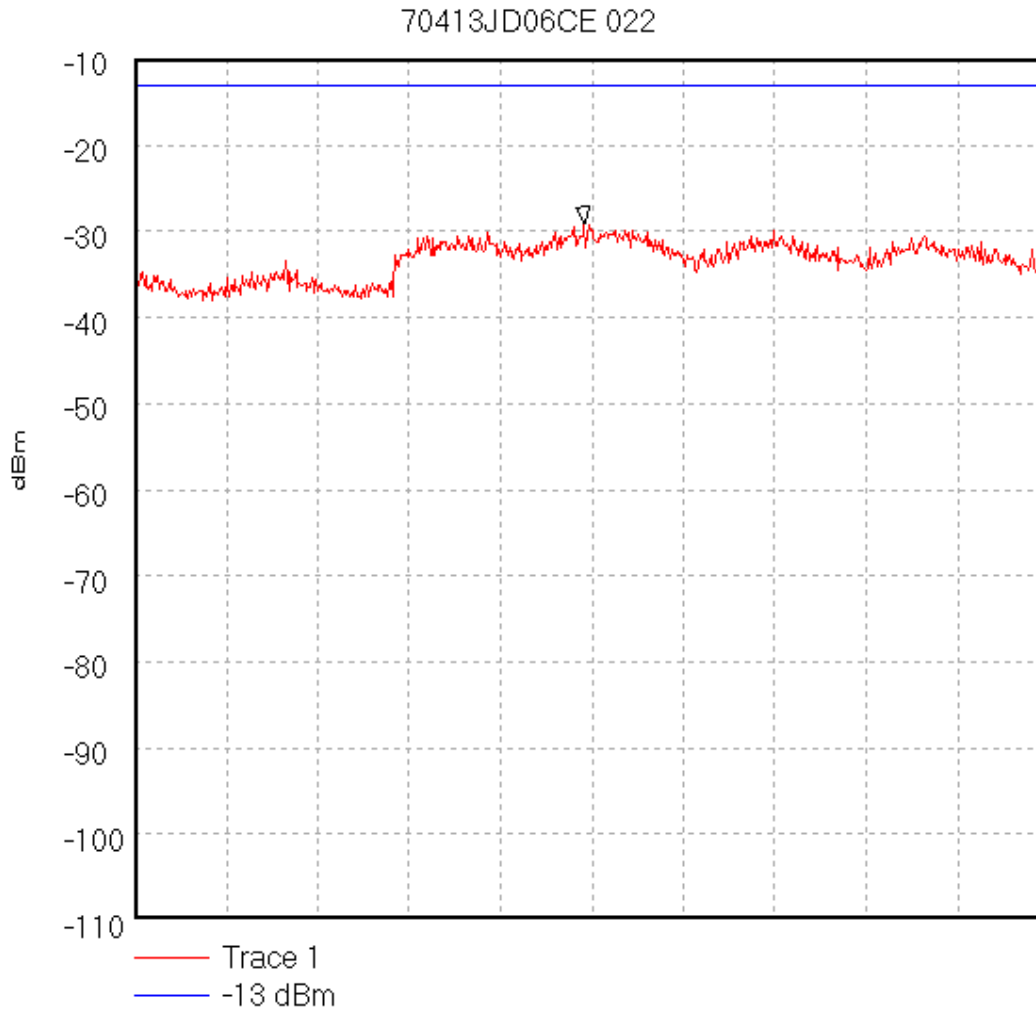

Start 5.0 GHz; Stop 10.0 GHz

Ref -10 dBm; Ref Offset 36.2 dB; 10 dB/div

RBW 1.0 MHz; VBW 1.0 MHz; Att 10 dB; Swp 100.0 mS

Peak 7.458333 GHz, -29.17 dBm

Display Line: -13 dBm; ; Limit Test Passed

28/10/02 16:49:39

Test Of: Nokia UK Ltd.

Cameron Imaging Phone 3650 (NHL-8) Mobile Phone Handset

To: FCC Part 24: 2001, FCC Part 15: 2001 and Part 2: 2001

GPH\70413JD06CE\023

Test for Nokia of NHL-8XX CAMERON M.S. IMEI:-004400/11/1753558/3.

Operating Condition :- Allocated Top Channel.

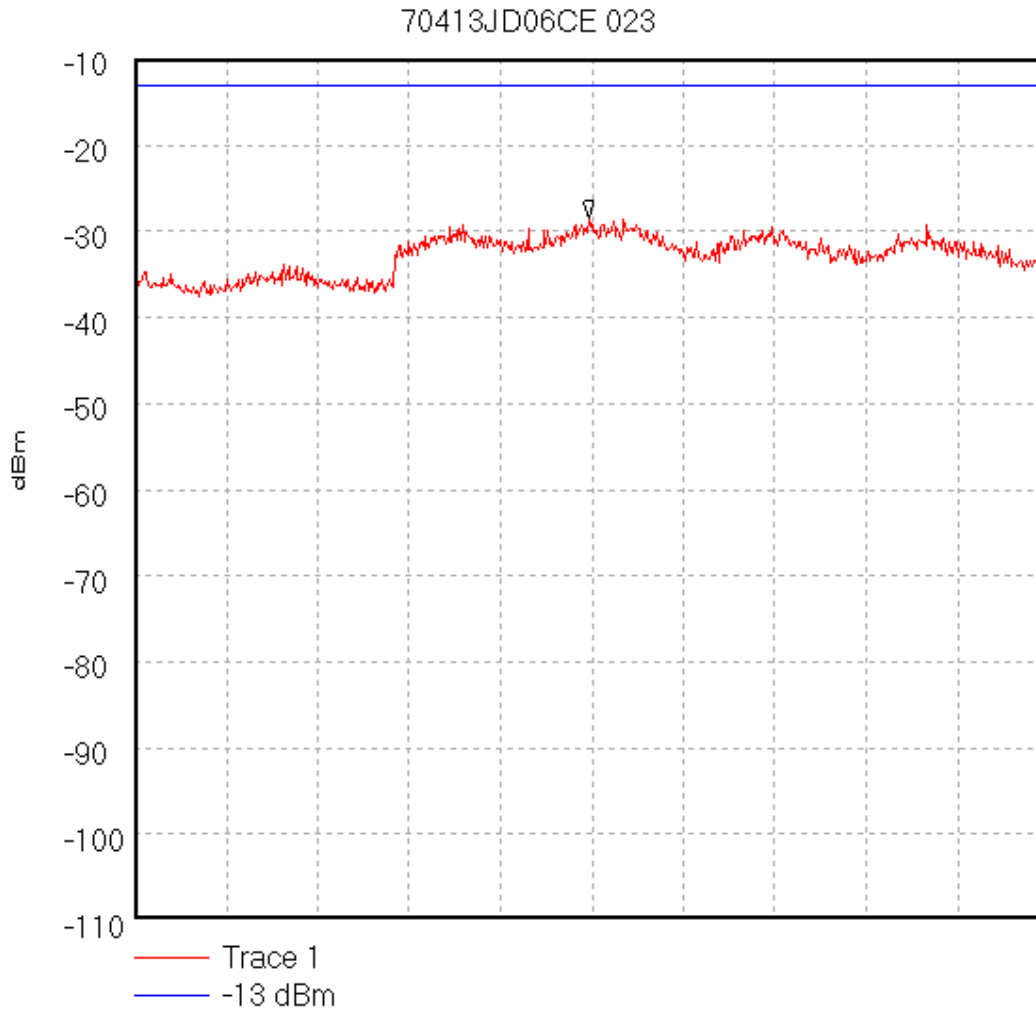

Start 5.0 GHz; Stop 10.0 GHz

Ref -10 dBm; Ref Offset 36.2 dB; 10 dB/div

RBW 1.0 MHz; VBW 1.0 MHz; Att 10 dB; Swp 100.0 mS

Peak 7.483333 GHz, -28.5 dBm

Display Line: -13 dBm; ; Limit Test Passed

28/10/02 16:50:17

Test Of: Nokia UK Ltd.

Cameron Imaging Phone 3650 (NHL-8) Mobile Phone Handset

To: FCC Part 24: 2001, FCC Part 15: 2001 and Part 2: 2001

GPH\70413JD06CE\024

Test for Nokia of NHL-8XX CAMERON M.S. IMEI:-004400/11/1753558/3.

Operating Condition :- Allocated Bottom Channel.

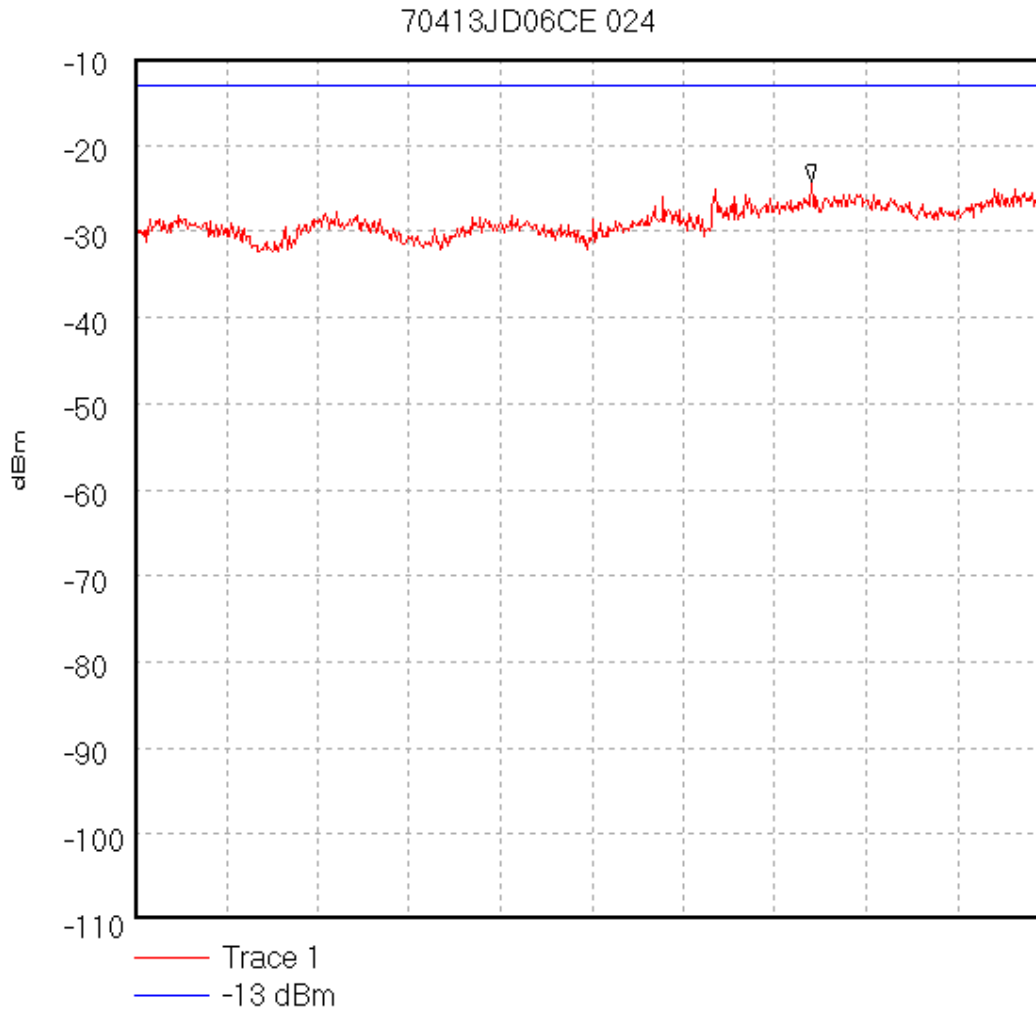

Start 10.0 GHz; Stop 15.0 GHz

Ref -10 dBm; Ref Offset 38.4 dB; 10 dB/div

RBW 1.0 MHz; VBW 1.0 MHz; Att 10 dB; Swp 100.0 mS

Peak 13.7 GHz, -24.17 dBm

Display Line: -13 dBm; ; Limit Test Passed

28/10/02 16:56:03

Test Of: Nokia UK Ltd.

Cameron Imaging Phone 3650 (NHL-8) Mobile Phone Handset

To: FCC Part 24: 2001, FCC Part 15: 2001 and Part 2: 2001

GPH\70413JD06CE\025

Test for Nokia of NHL-8XX CAMERON M.S. IMEI:-004400/11/1753558/3.

Operating Condition :- Allocated Middle Channel.

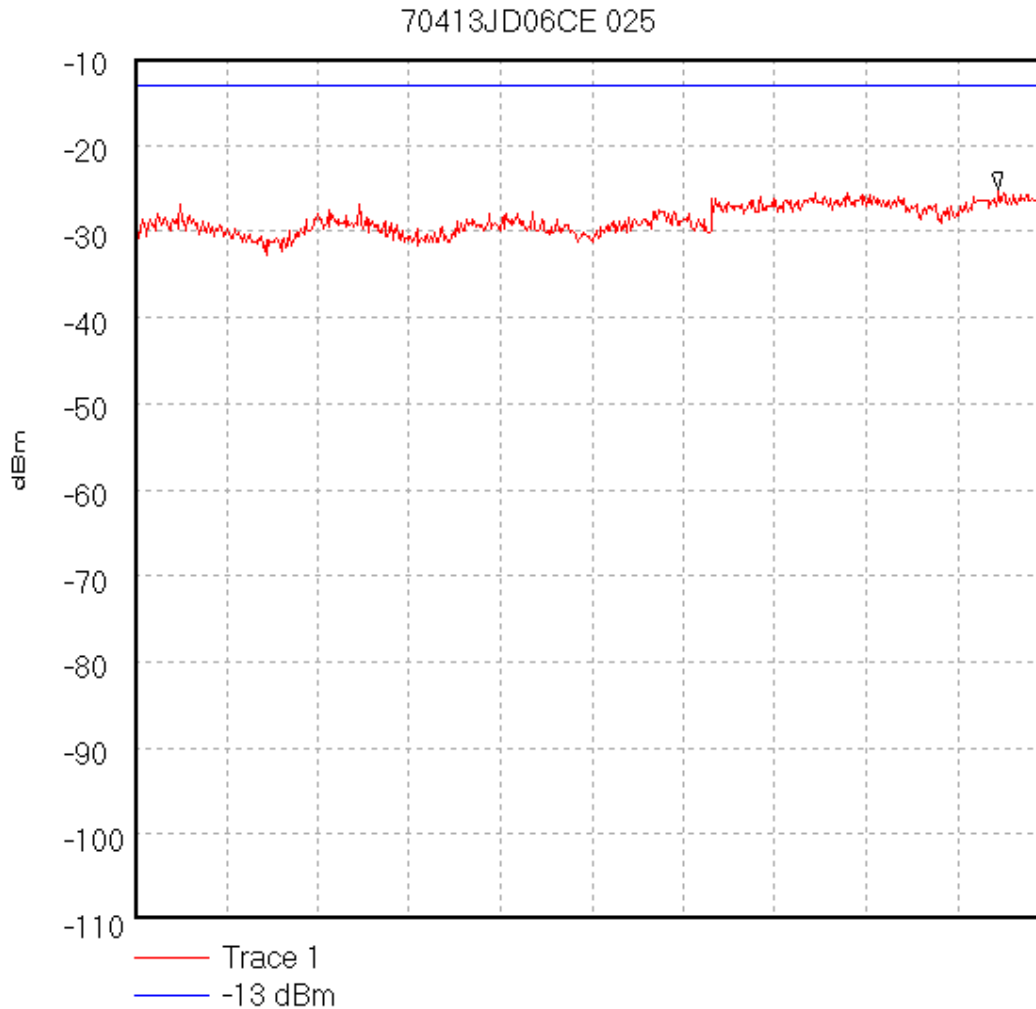

Start 10.0 GHz; Stop 15.0 GHz

Ref -10 dBm; Ref Offset 38.4 dB; 10 dB/div

RBW 1.0 MHz; VBW 1.0 MHz; Att 10 dB; Swp 100.0 mS

Peak 14.725 GHz, -25.17 dBm

Display Line: -13 dBm; ; Limit Test Passed

28/10/02 16:57:00



Test Of: Nokia UK Ltd.

Cameron Imaging Phone 3650 (NHL-8) Mobile Phone Handset

To: FCC Part 24: 2001, FCC Part 15: 2001 and Part 2: 2001

GPH\70413JD06CE\026

Test for Nokia of NHL-8XX CAMERON M.S. IMEI:-004400/11/1753558/3.

Operating Condition :- Allocated Top Channel.

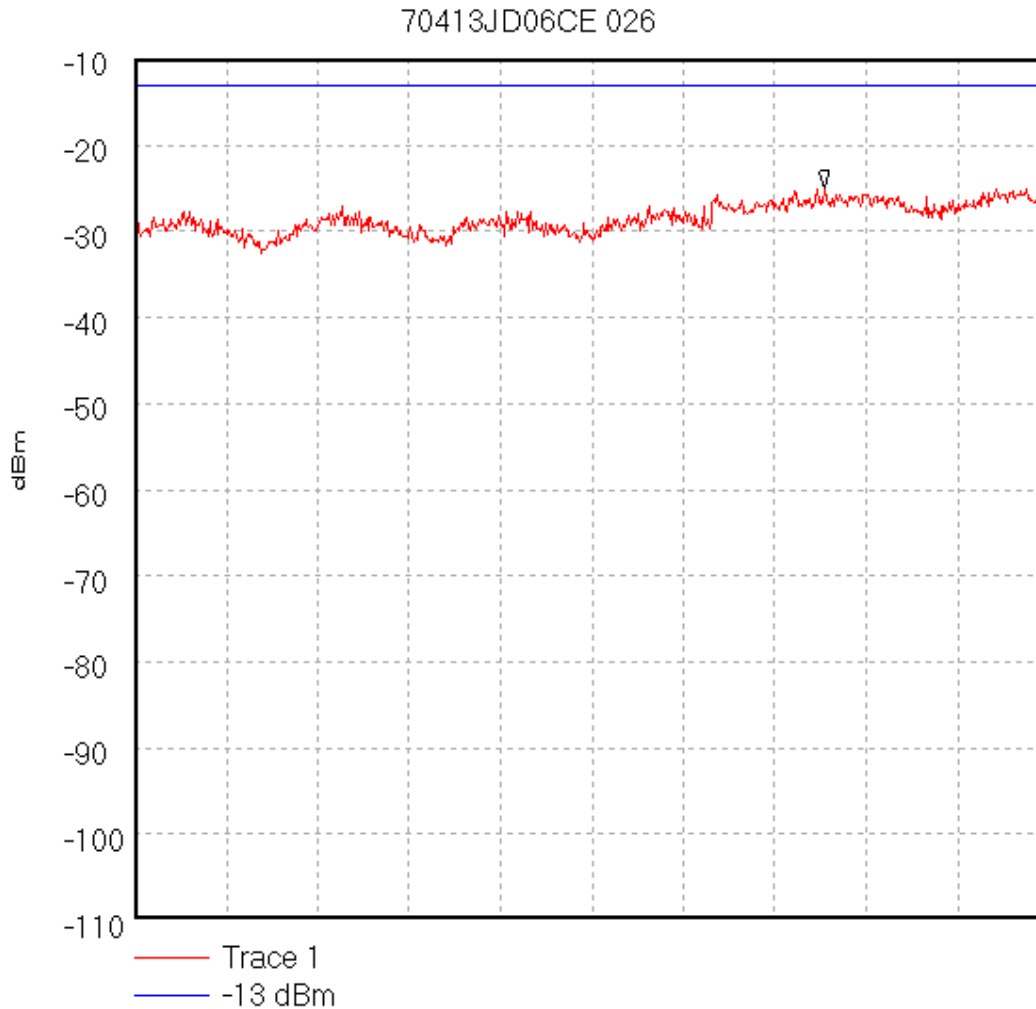

Start 10.0 GHz; Stop 15.0 GHz

Ref -10 dBm; Ref Offset 38.4 dB; 10 dB/div

RBW 1.0 MHz; VBW 1.0 MHz; Att 10 dB; Swp 100.0 mS

Peak 13.775 GHz, -25.0 dBm

Display Line: -13 dBm; ; Limit Test Passed

28/10/02 16:57:40

Test Of: Nokia UK Ltd.

Cameron Imaging Phone 3650 (NHL-8) Mobile Phone Handset

To: FCC Part 24: 2001, FCC Part 15: 2001 and Part 2: 2001

GPH\70413JD06CE\027

Test for Nokia of NHL-8XX CAMERON M.S. IMEI:-004400/11/1753558/3.

Operating Condition :- Allocated Bottom Channel.

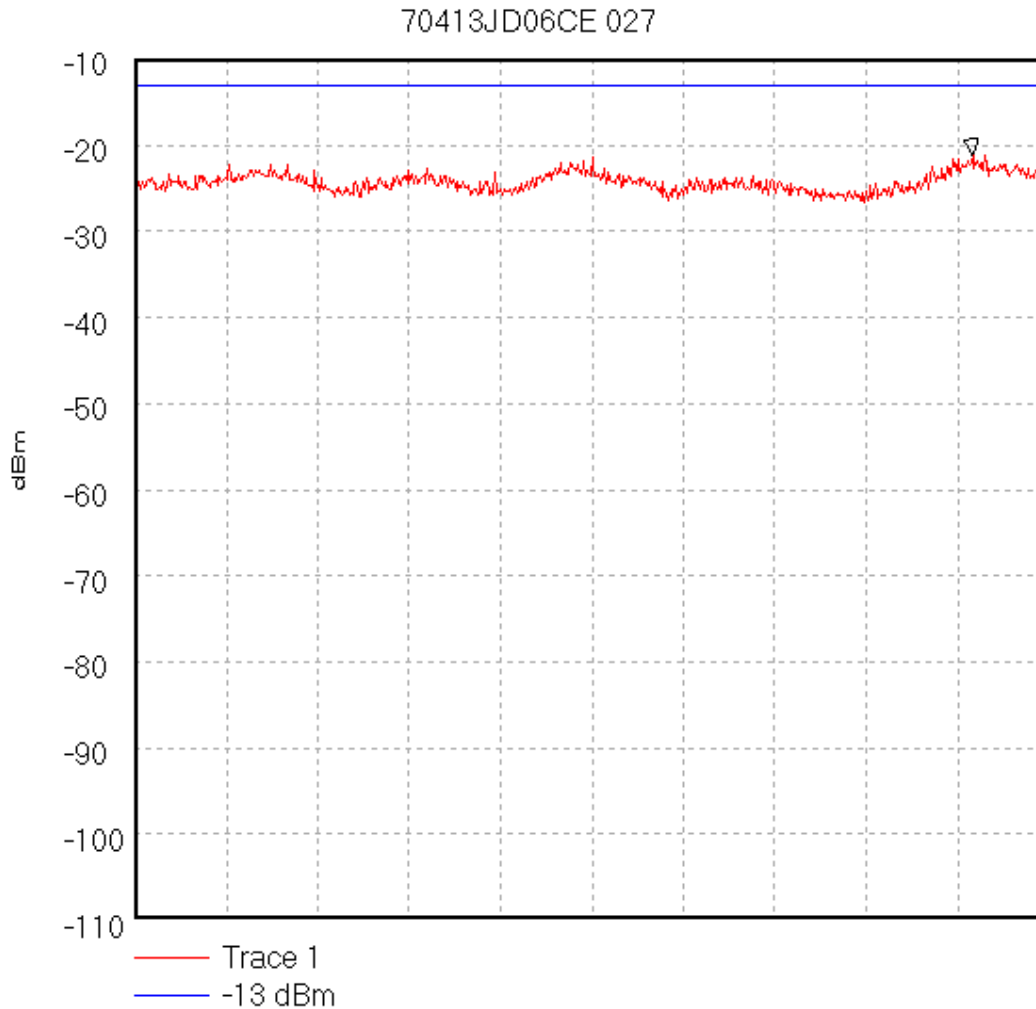

Centre 17.5 GHz; Span 5.0 GHz

Ref -10 dBm; Ref Offset 42.0 dB; 10 dB/div

RBW 1.0 MHz; VBW 1.0 MHz; Att 10 dB; Swp 100.0 mS

Peak 19.583333 GHz, -21.17 dBm

Display Line: -13 dBm; ; Limit Test Passed

29/10/02 08:56:29

Test Of: Nokia UK Ltd.

Cameron Imaging Phone 3650 (NHL-8) Mobile Phone Handset

To: FCC Part 24: 2001, FCC Part 15: 2001 and Part 2: 2001

GPH\70413JD06CE\028

Test for Nokia of NHL-8XX CAMERON M.S. IMEI:-004400/11/1753558/3.

Operating Condition :- Allocated Mid Channel.

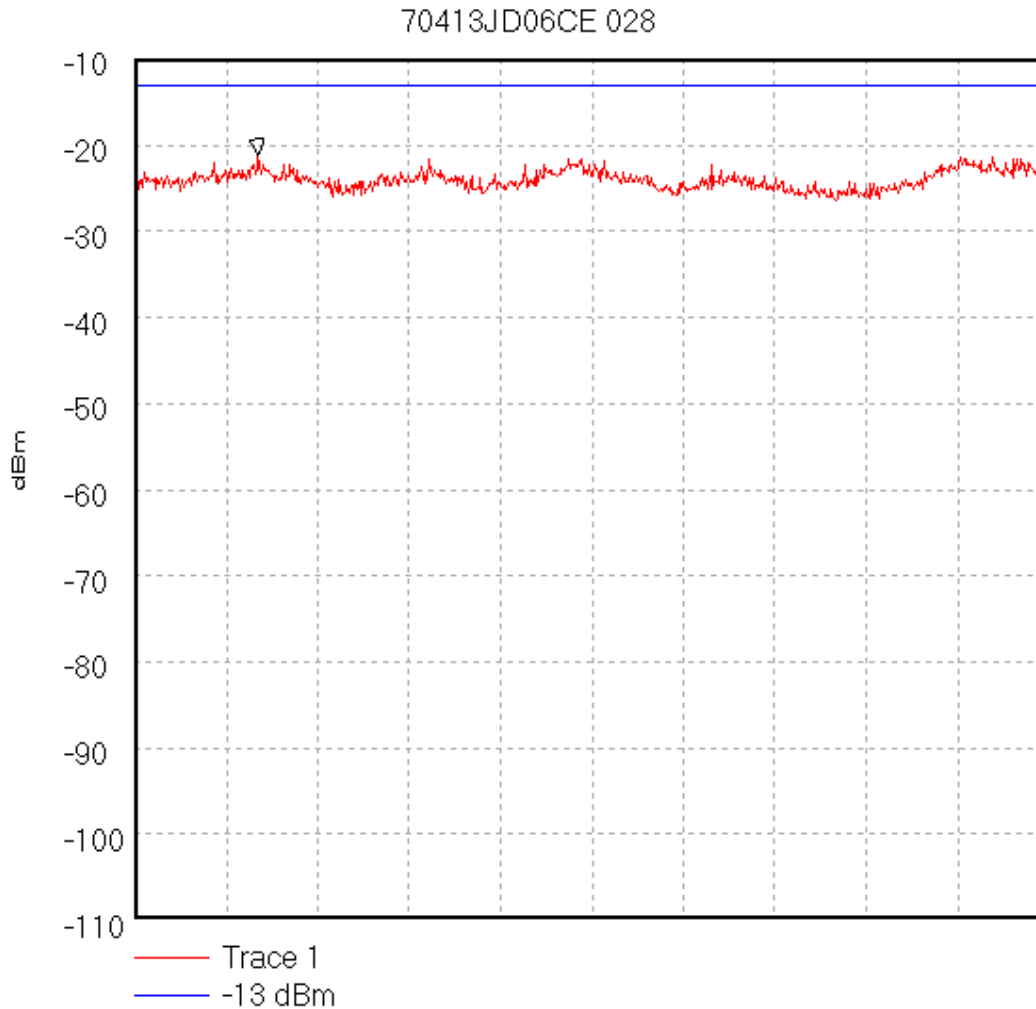

Centre 17.5 GHz; Span 5.0 GHz

Ref -10 dBm; Ref Offset 42.0 dB; 10 dB/div

RBW 1.0 MHz; VBW 1.0 MHz; Att 10 dB; Swp 100.0 mS

Peak 15.675 GHz, -21.17 dBm

Display Line: -13 dBm; ; Limit Test Passed

29/10/02 09:01:01

Test Of: Nokia UK Ltd.

Cameron Imaging Phone 3650 (NHL-8) Mobile Phone Handset

To: FCC Part 24: 2001, FCC Part 15: 2001 and Part 2: 2001

GPH\70413JD06CE\029

Test for Nokia of NHL-8XX CAMERON M.S. IMEI:-004400/11/1753558/3.

Operating Condition :- Allocated Top Channel.

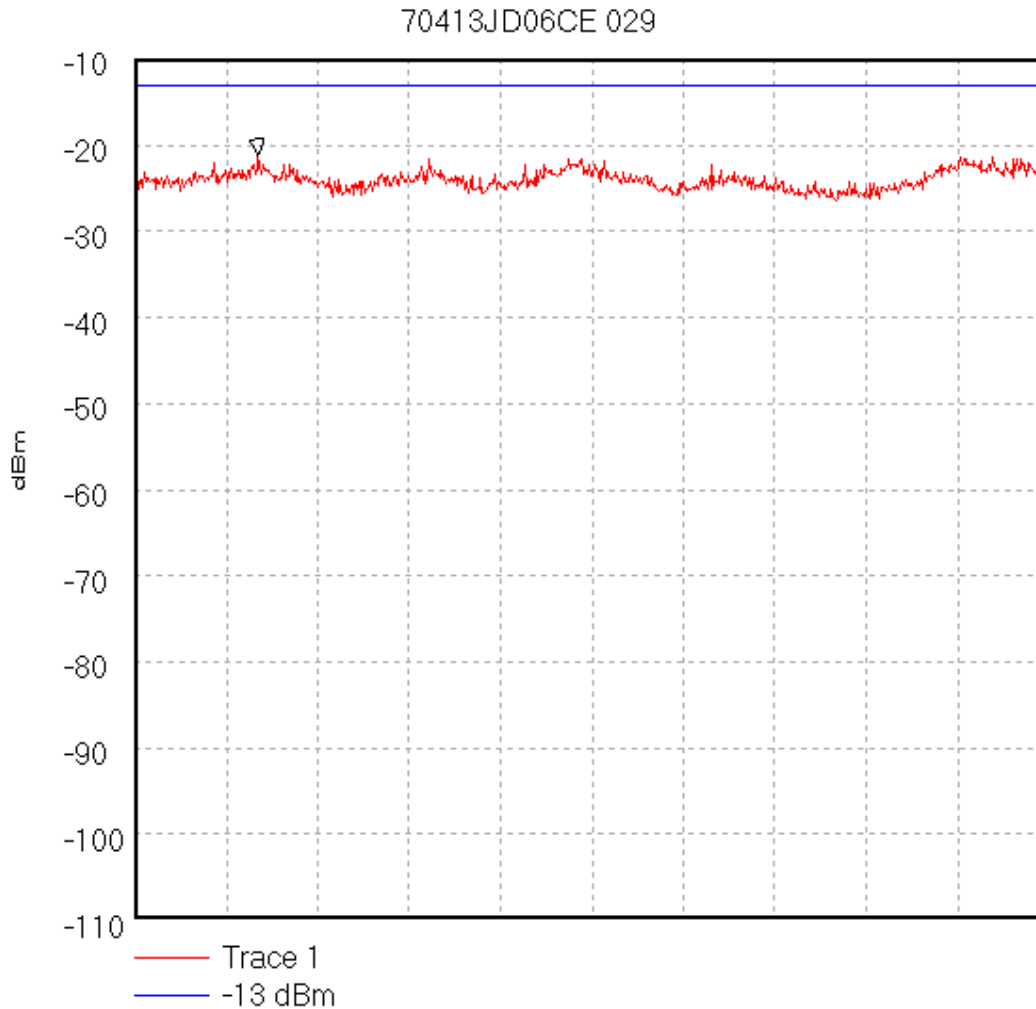

Centre 17.5 GHz; Span 5.0 GHz

Ref -10 dBm; Ref Offset 42.0 dB; 10 dB/div

RBW 1.0 MHz; VBW 1.0 MHz; Att 10 dB; Swp 100.0 mS

Peak 15.675 GHz, -21.17 dBm

Display Line: -13 dBm; ; Limit Test Passed

29/10/02 09:02:34

Test Of: Nokia UK Ltd.

Cameron Imaging Phone 3650 (NHL-8) Mobile Phone Handset

To: FCC Part 24: 2001, FCC Part 15: 2001 and Part 2: 2001

GPH\70413JD06\001

Test for Nokia of NHL-8XX CAMERON M.S. IMEI:-004400/11/1753558/3.

Operating Condition :- Allocated Middle Channel.

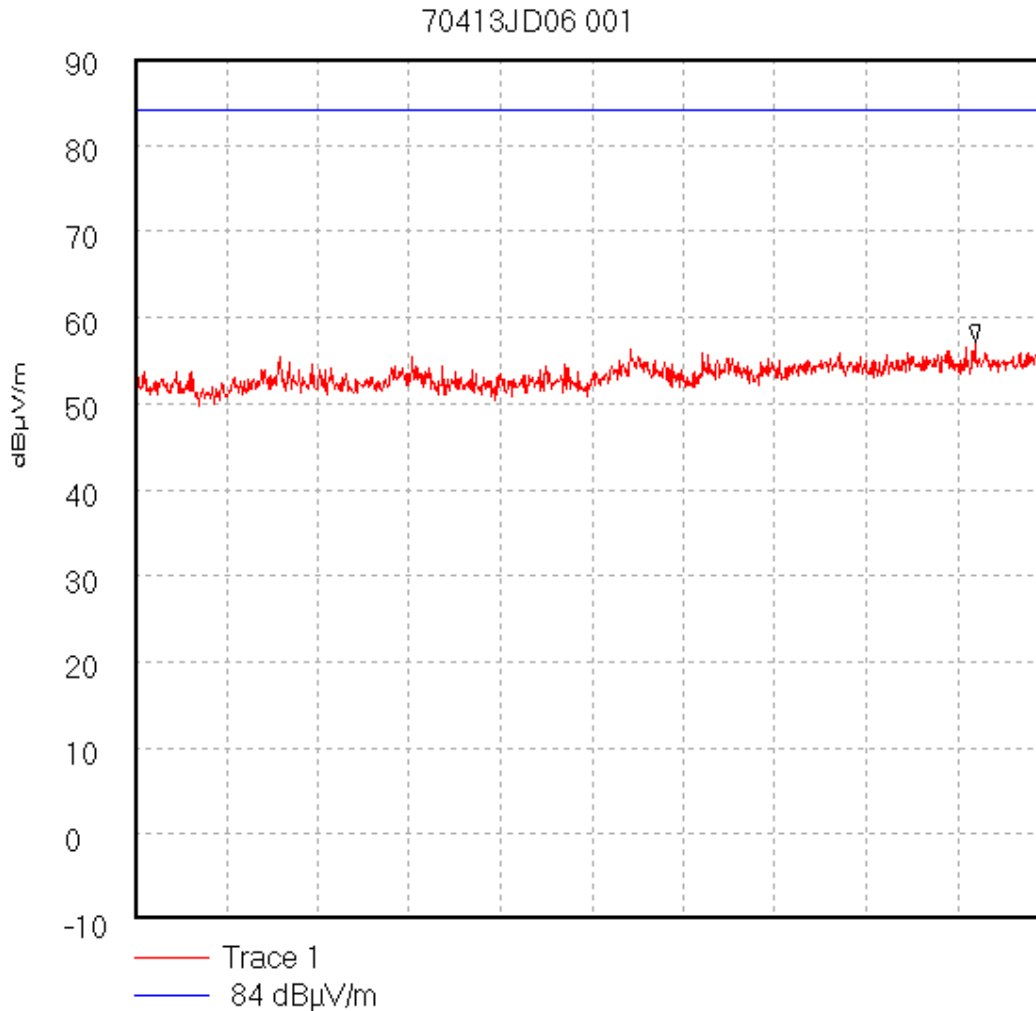

Start 4.0 GHz; Stop 5.0 GHz

Ref 90 dBµV/m; Ref Offset 0.0 dB; 10 dB/div

RBW 1.0 MHz; VBW 1.0 MHz; Att 5 dB; Swp 20.0 mS

Peak 4.92 GHz, 57.17 dBµV/m

Display Line: 84 dBµV/m; ; Limit Test Passed

22/10/02 13:29:51

Test Of: Nokia UK Ltd.

Cameron Imaging Phone 3650 (NHL-8) Mobile Phone Handset

To: FCC Part 24: 2001, FCC Part 15: 2001 and Part 2: 2001

GPH\70413JD06\002

Test for Nokia of NHL-8XX CAMERON M.S. IMEI:-004400/11/1753558/3.

Operating Condition :- Idle Mode.

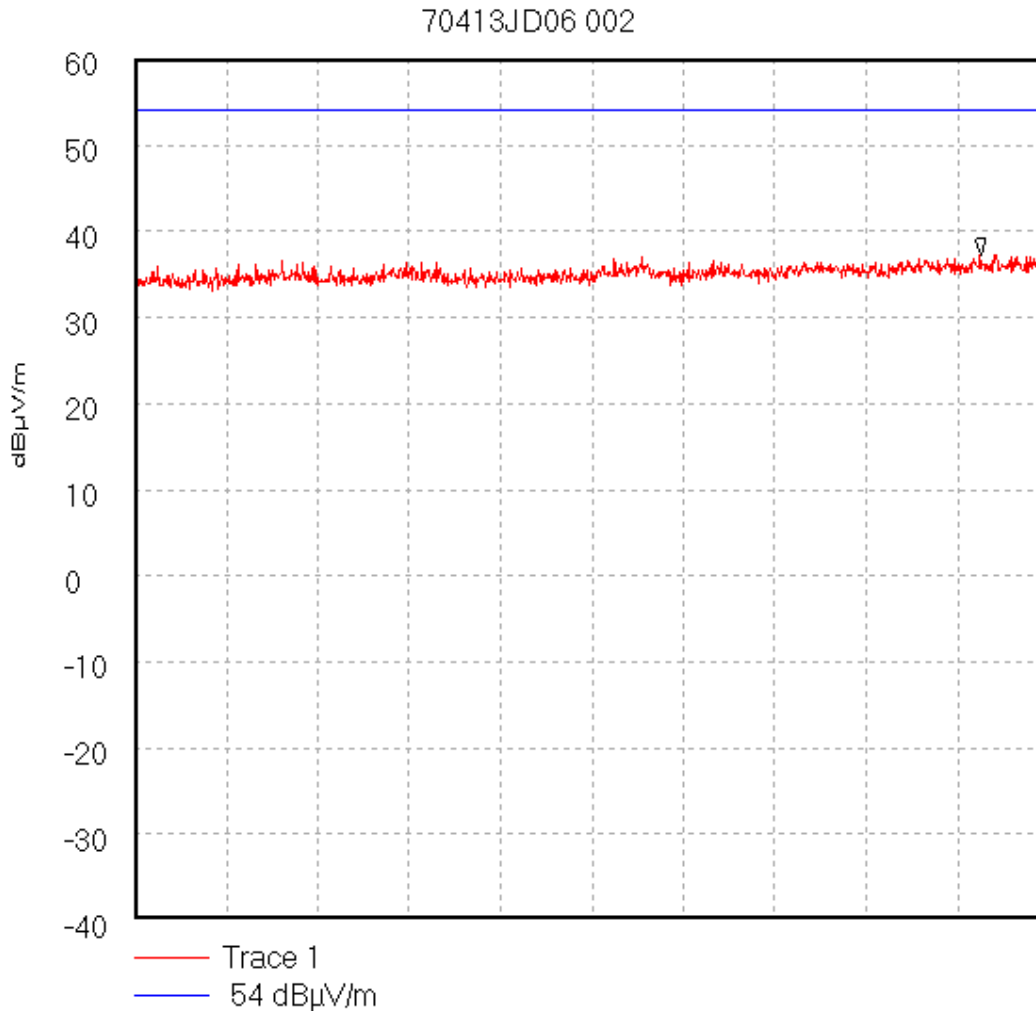

Start 4.0 GHz; Stop 5.0 GHz

Ref 60 dBµV/m; Ref Offset 0.0 dB; 10 dB/div

RBW 1.0 MHz; VBW 1.0 MHz; Att 0 dB; Swp 20.0 mS

Peak 4.925556 GHz, 37.18 dBµV/m

Display Line: 54 dBµV/m; ; Limit Test Passed

22/10/02 13:31:52

Test Of: Nokia UK Ltd.

Cameron Imaging Phone 3650 (NHL-8) Mobile Phone Handset

To: FCC Part 24: 2001, FCC Part 15: 2001 and Part 2: 2001

**GPH\70413JD06\003**

**Test for Nokia of NHL-8XX CAMERON M.S. IMEI:-004400/11/1753558/3.**

**Operating Condition :- Allocated Middle Channel.**

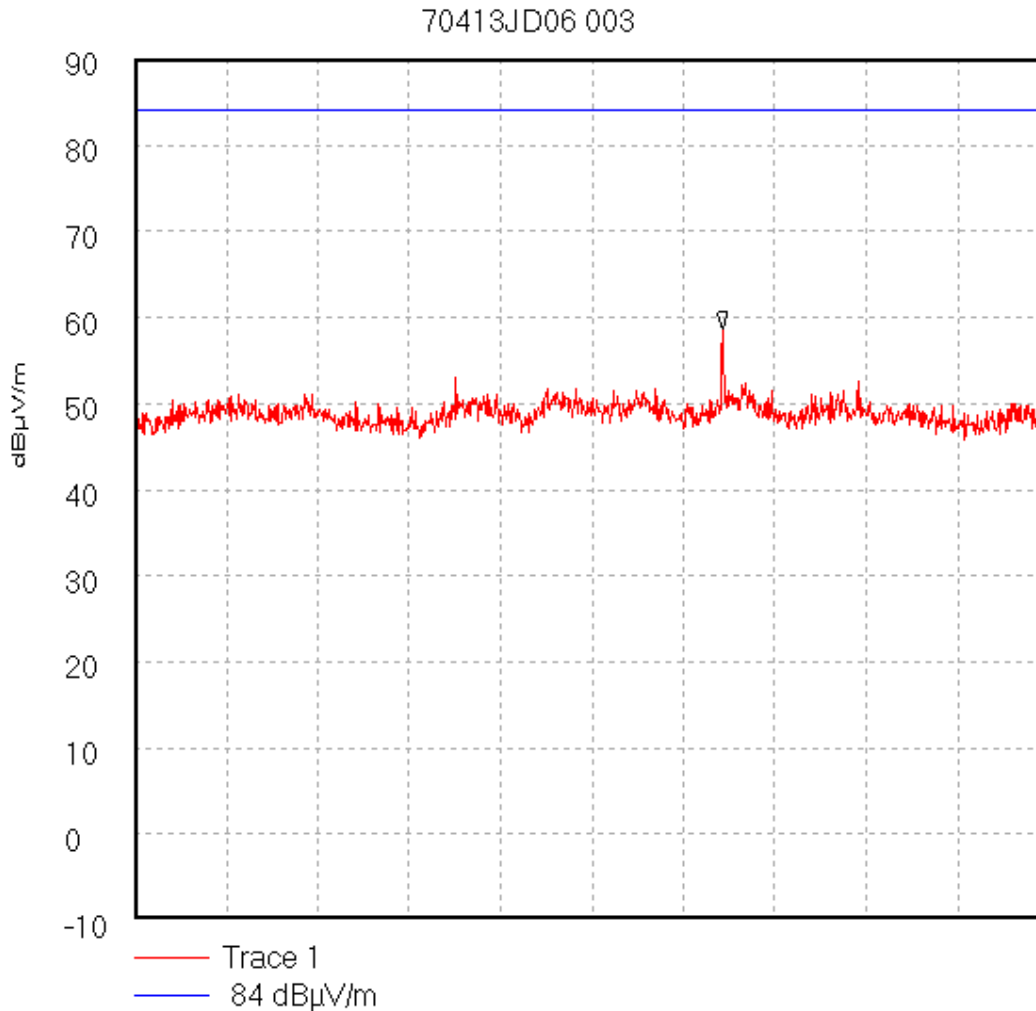

Start 5.0 GHz; Stop 6.0 GHz

Ref 90 dBµV/m; Ref Offset 0.0 dB; 10 dB/div

RBW 1.0 MHz; VBW 1.0 MHz; Att 5 dB; Swp 20.0 mS

Peak 5.643333 GHz, 58.62 dBµV/m

Display Line: 84 dBµV/m; ; Limit Test Failed

22/10/02 13:34:48

Test Of: Nokia UK Ltd.

Cameron Imaging Phone 3650 (NHL-8) Mobile Phone Handset

To: FCC Part 24: 2001, FCC Part 15: 2001 and Part 2: 2001

GPH\70413JD06\004

Test for Nokia of NHL-8XX CAMERON M.S. IMEI:-004400/11/1753558/3.

Operating Condition :- Idle Mode.

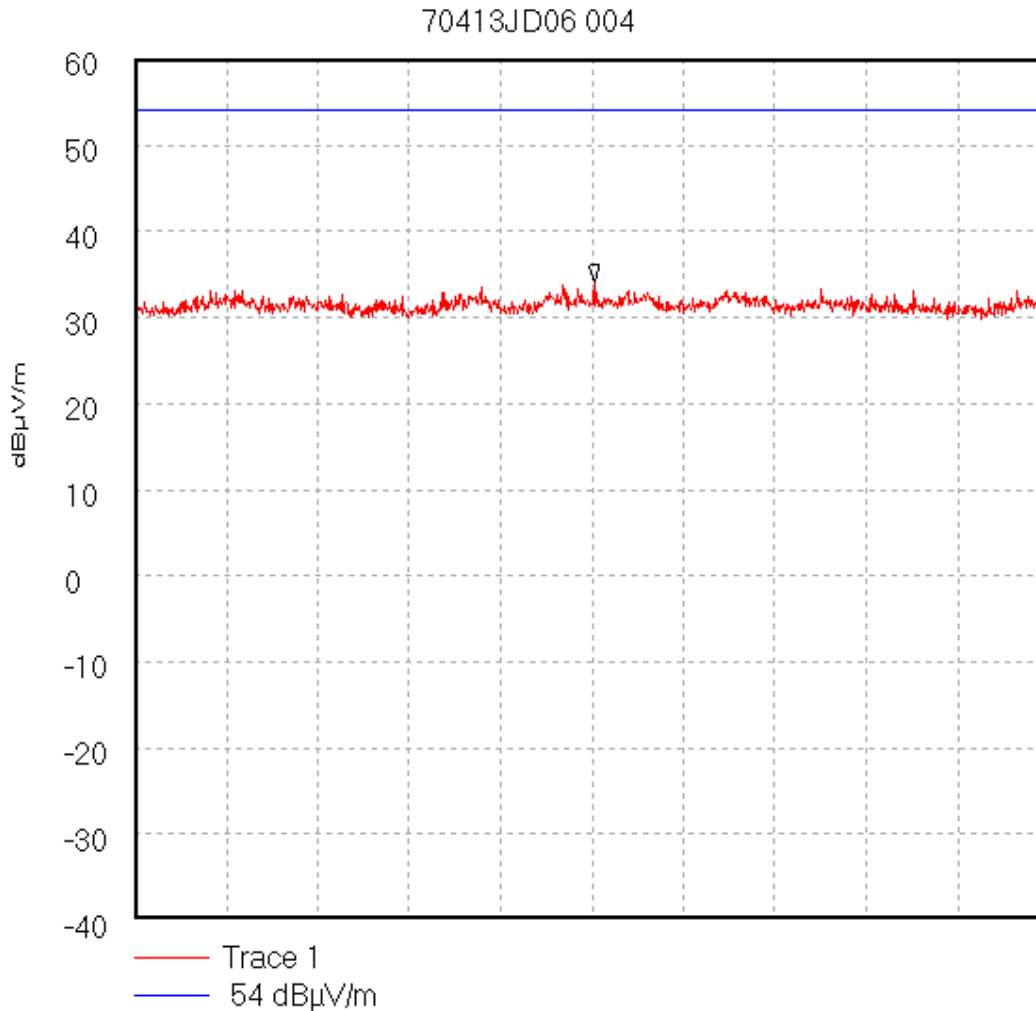

Start 5.0 GHz; Stop 6.0 GHz

Ref 60 dBµV/m; Ref Offset 0.0 dB; 10 dB/div

RBW 1.0 MHz; VBW 1.0 MHz; Att 0 dB; Swp 20.0 mS

Peak 5.503333 GHz, 34.08 dBµV/m

Display Line: 54 dBµV/m; ; Limit Test Passed

22/10/02 13:37:10



Test Of: Nokia UK Ltd.

Cameron Imaging Phone 3650 (NHL-8) Mobile Phone Handset

To: FCC Part 24: 2001, FCC Part 15: 2001 and Part 2: 2001

GPH\70413JD06\007

Test for Nokia of NHL-8XX CAMERON M.S. IMEI:-004400/11/1753558/3.

Operating Condition :- Allocated Middle Channel.

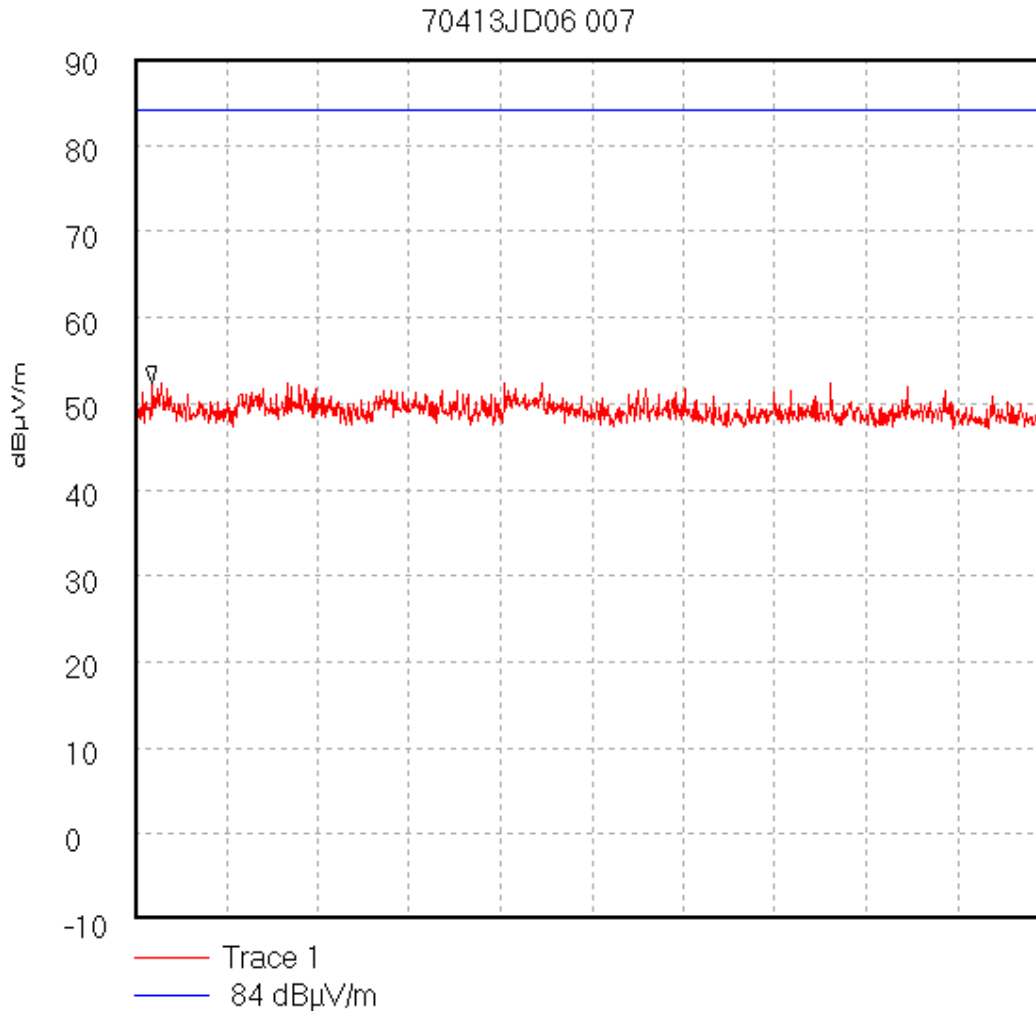

Start 6.0 GHz; Stop 8.0 GHz

Ref 90 dBµV/m; Ref Offset 0.0 dB; 10 dB/div

RBW 1.0 MHz; VBW 1.0 MHz; Att 5 dB; Swp 20.0 mS

Peak 6.037778 GHz, 52.42 dBµV/m

Display Line: 84 dBµV/m; ; Limit Test Passed

22/10/02 13:57:57

Test Of: Nokia UK Ltd.

Cameron Imaging Phone 3650 (NHL-8) Mobile Phone Handset

To: FCC Part 24: 2001, FCC Part 15: 2001 and Part 2: 2001

GPH\70413JD06\008

Test for Nokia of NHL-8XX CAMERON M.S. IMEI:-004400/11/1753558/3.

Operating Condition :- Idle Mode.

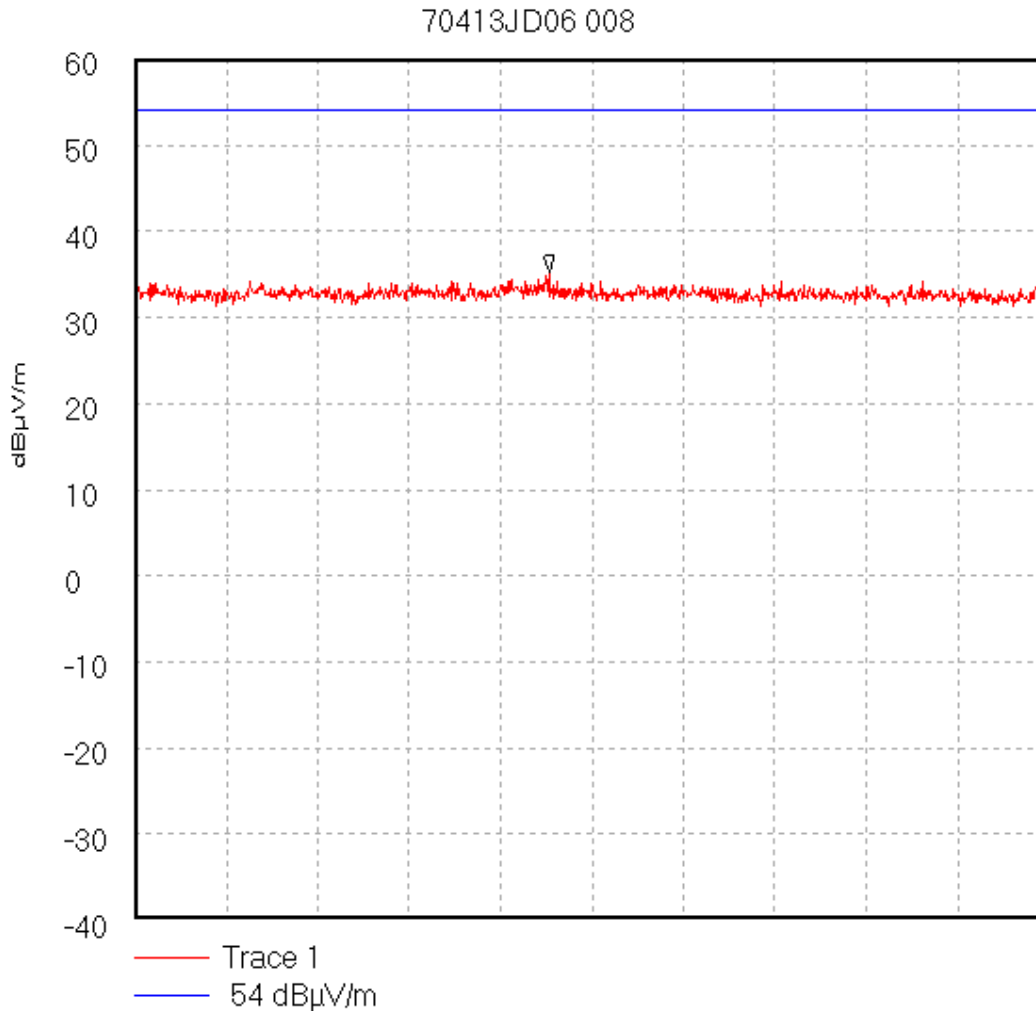

Start 6.0 GHz; Stop 8.0 GHz

Ref 60 dBµV/m; Ref Offset 0.0 dB; 10 dB/div

RBW 1.0 MHz; VBW 1.0 MHz; Att 0 dB; Swp 20.0 mS

Peak 6.906667 GHz, 35.3 dBµV/m

Display Line: 54 dBµV/m; ; Limit Test Passed

22/10/02 13:59:31

Test Of: Nokia UK Ltd.

Cameron Imaging Phone 3650 (NHL-8) Mobile Phone Handset

To: FCC Part 24: 2001, FCC Part 15: 2001 and Part 2: 2001

GPH\70413JD06\009

Test for Nokia of NHL-8XX CAMERON M.S. IMEI:-004400/11/1753558/3.

Operating Condition :- Allocated Middle Channel.

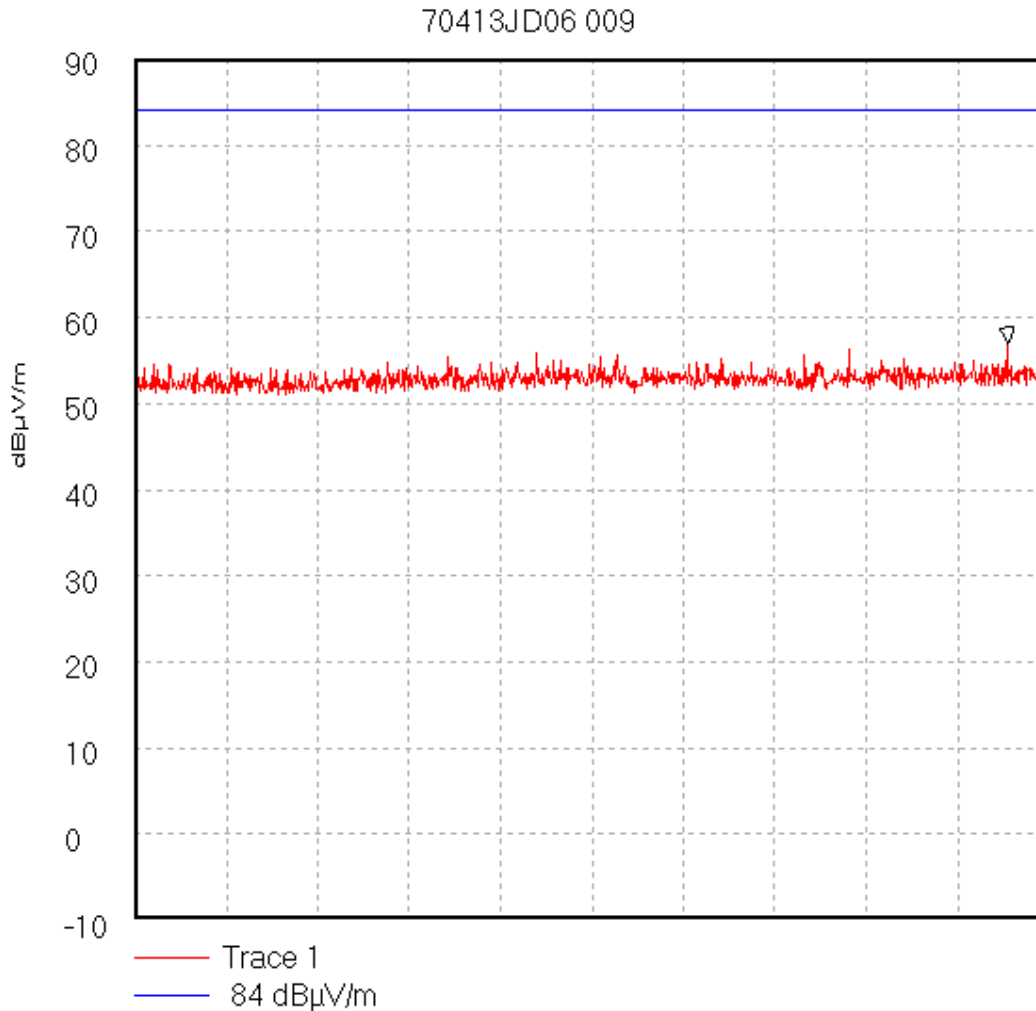

Start 8.0 GHz; Stop 12.5 GHz

Ref 90 dBµV/m; Ref Offset 0.0 dB; 10 dB/div

RBW 1.0 MHz; VBW 1.0 MHz; Att 5 dB; Swp 40.0 mS

Peak 12.3 GHz, 56.92 dBµV/m

Display Line: 84 dBµV/m; ; Limit Test Failed

22/10/02 14:03:48

Test Of: Nokia UK Ltd.

Cameron Imaging Phone 3650 (NHL-8) Mobile Phone Handset

To: FCC Part 24: 2001, FCC Part 15: 2001 and Part 2: 2001

GPH\70413JD06\010

Test for Nokia of NHL-8XX CAMERON M.S. IMEI:-004400/11/1753558/3.

Operating Condition :- Idle Mode.

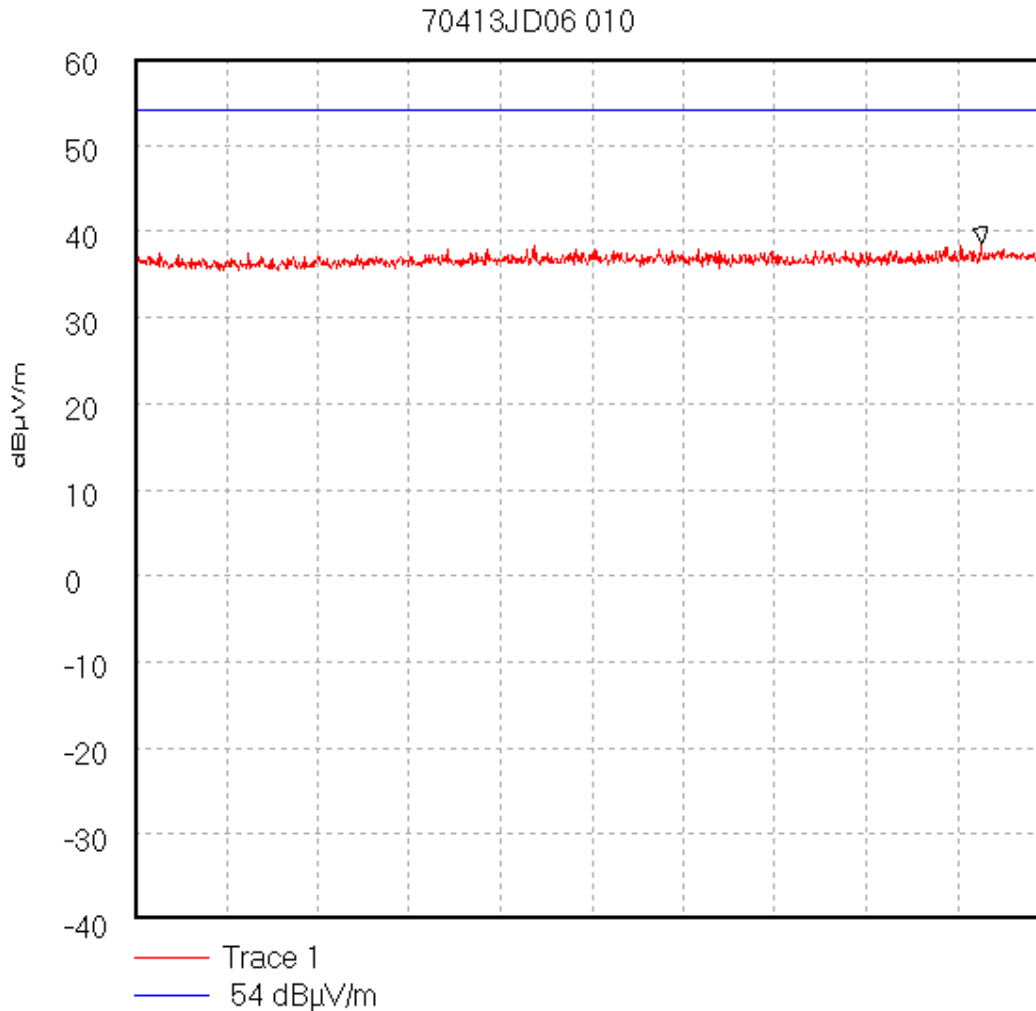

Start 8.0 GHz; Stop 12.5 GHz

Ref 60 dBµV/m; Ref Offset 0.0 dB; 10 dB/div

RBW 1.0 MHz; VBW 1.0 MHz; Att 0 dB; Swp 40.0 mS

Peak 12.17 GHz, 38.52 dBµV/m

Display Line: 54 dBµV/m; ; Limit Test Passed

22/10/02 14:07:33

Test Of: Nokia UK Ltd.

Cameron Imaging Phone 3650 (NHL-8) Mobile Phone Handset

To: FCC Part 24: 2001, FCC Part 15: 2001 and Part 2: 2001

GPH\70413JD06\011

Test for Nokia of NHL-8XX CAMERON M.S. IMEI:-004400/11/1753558/3.

Operating Condition :- Allocated Middle Channel.

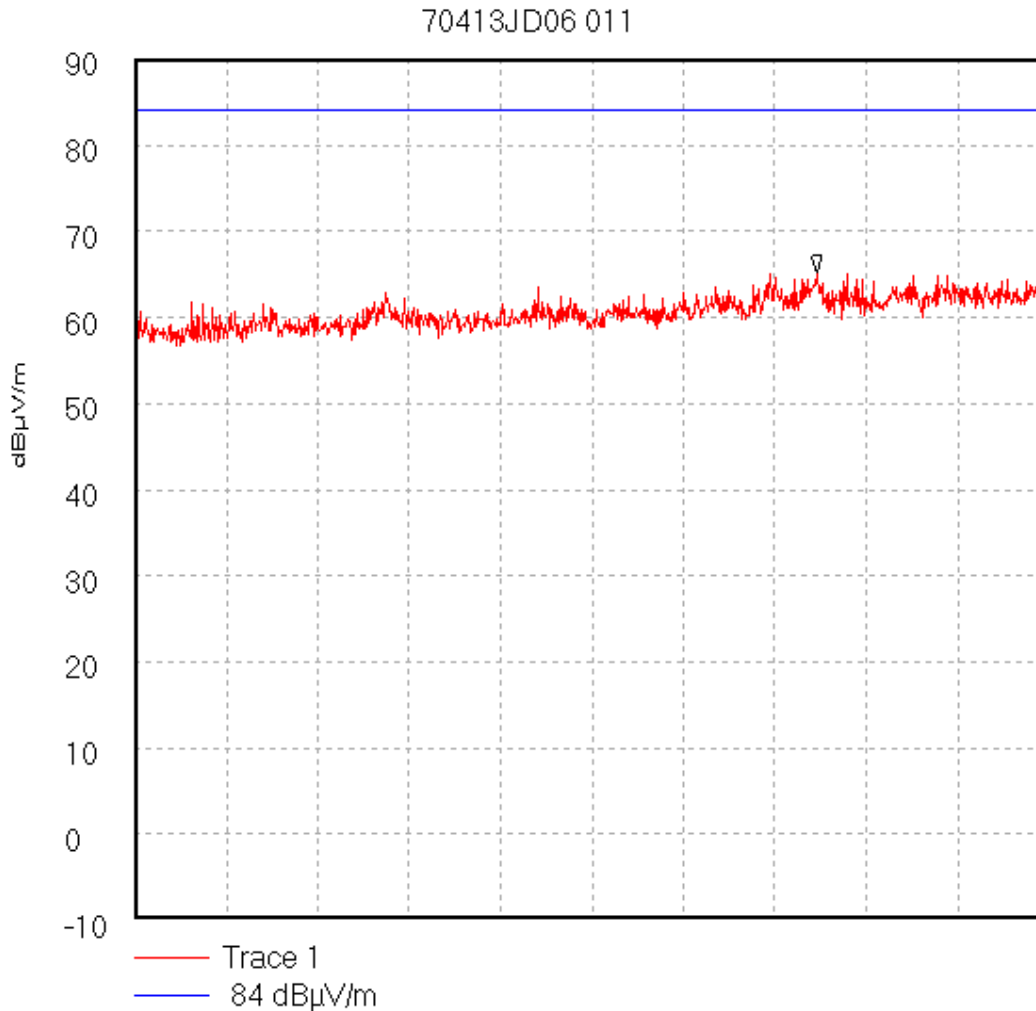

Start 12.5 GHz; Stop 18.0 GHz

Ref 90 dBµV/m; Ref Offset 0.0 dB; 10 dB/div

RBW 1.0 MHz; VBW 1.0 MHz; Att 5 dB; Swp 40.0 mS

Peak 16.606667 GHz, 65.14 dBµV/m

Display Line: 84 dBµV/m; ; Limit Test Failed

22/10/02 14:13:17

Test Of: Nokia UK Ltd.

Cameron Imaging Phone 3650 (NHL-8) Mobile Phone Handset

To: FCC Part 24: 2001, FCC Part 15: 2001 and Part 2: 2001

GPH\70413JD06\012

Test for Nokia of NHL-8XX CAMERON M.S. IMEI:-004400/11/1753558/3.

Operating Condition :- Idle Mode.

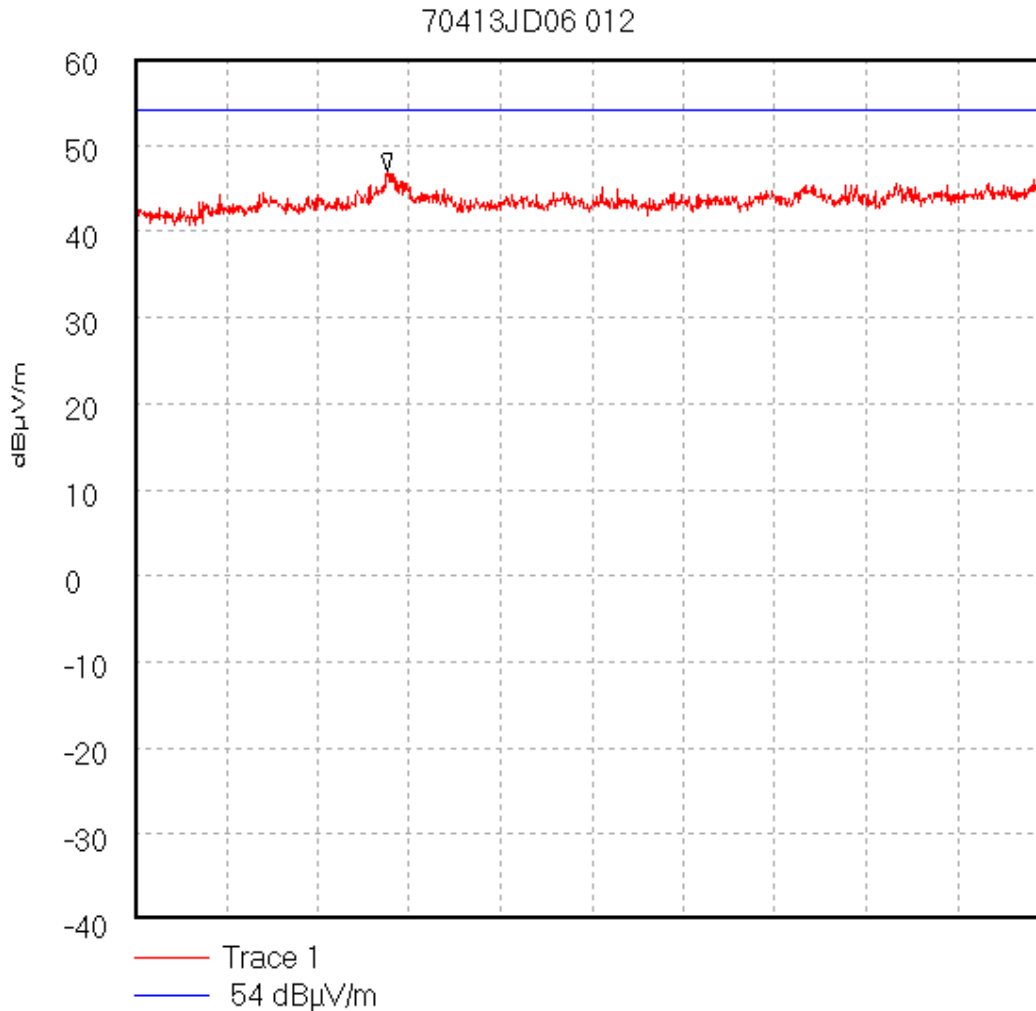

Start 12.5 GHz; Stop 18.0 GHz

Ref 60 dBµV/m; Ref Offset 0.0 dB; 10 dB/div

RBW 1.0 MHz; VBW 1.0 MHz; Att 0 dB; Swp 40.0 mS

Peak 14.021667 GHz, 46.98 dBµV/m

Display Line: 54 dBµV/m; ; Limit Test Passed

22/10/02 14:15:06

Test Of: Nokia UK Ltd.

Cameron Imaging Phone 3650 (NHL-8) Mobile Phone Handset

To: FCC Part 24: 2001, FCC Part 15: 2001 and Part 2: 2001

**GPH\70413JD06\013**

**Test for Nokia of NHL-8XX CAMERON M.S. IMEI:-004400/11/1753558/3.**

**Operating Condition :- Allocated Middle Channel.**

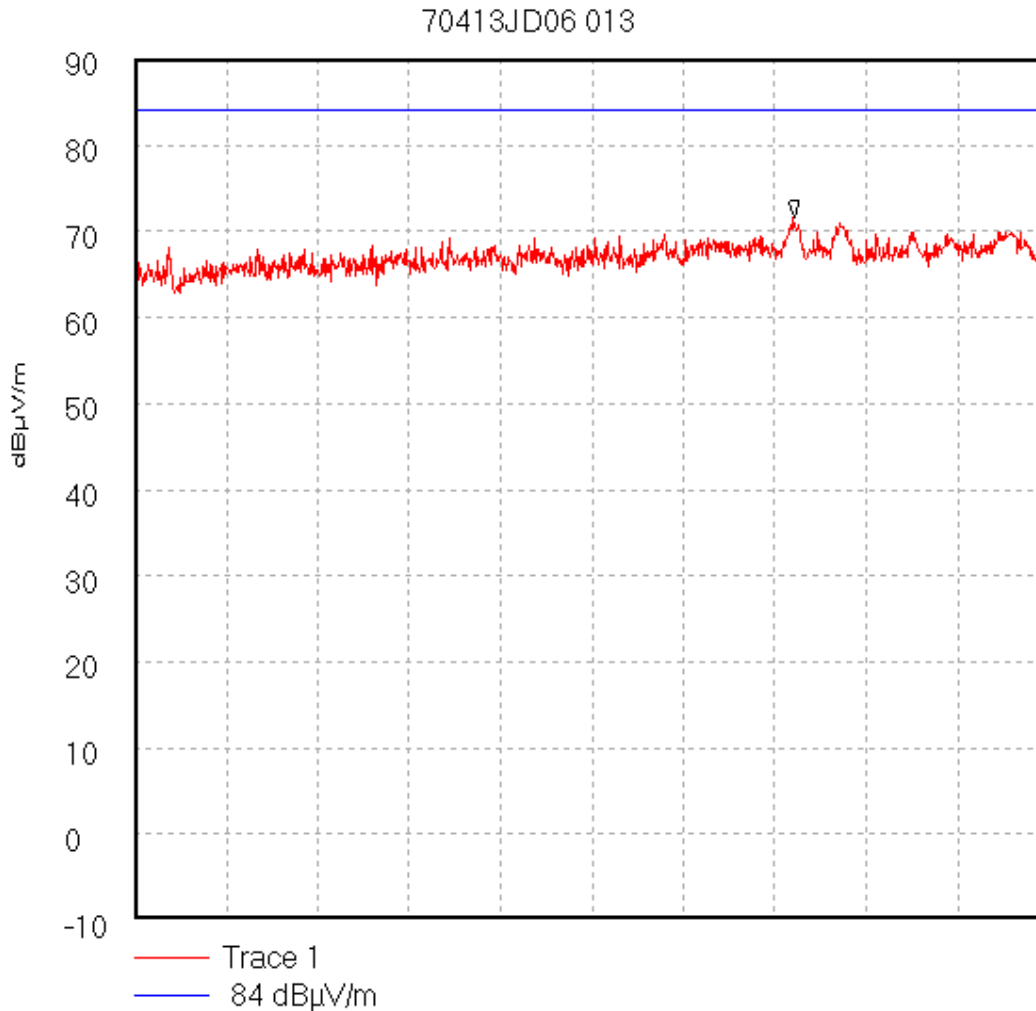

Start 18.0 GHz; Stop 26.5 GHz

Ref 90 dBµV/m; Ref Offset 0.0 dB; 10 dB/div

RBW 1.0 MHz; VBW 1.0 MHz; Att 5 dB; Swp 60.0 mS

Peak 24.129444 GHz, 71.57 dBµV/m

Display Line: 84 dBµV/m; ; Limit Test Failed

22/10/02 14:49:34

Test Of: Nokia UK Ltd.

Cameron Imaging Phone 3650 (NHL-8) Mobile Phone Handset

To: FCC Part 24: 2001, FCC Part 15: 2001 and Part 2: 2001

GPH\70413JD06\015

Test for Nokia of NHL-8XX CAMERON M.S. IMEI:-004400/11/1753558/3.

Operating Condition :- Idle Mode.

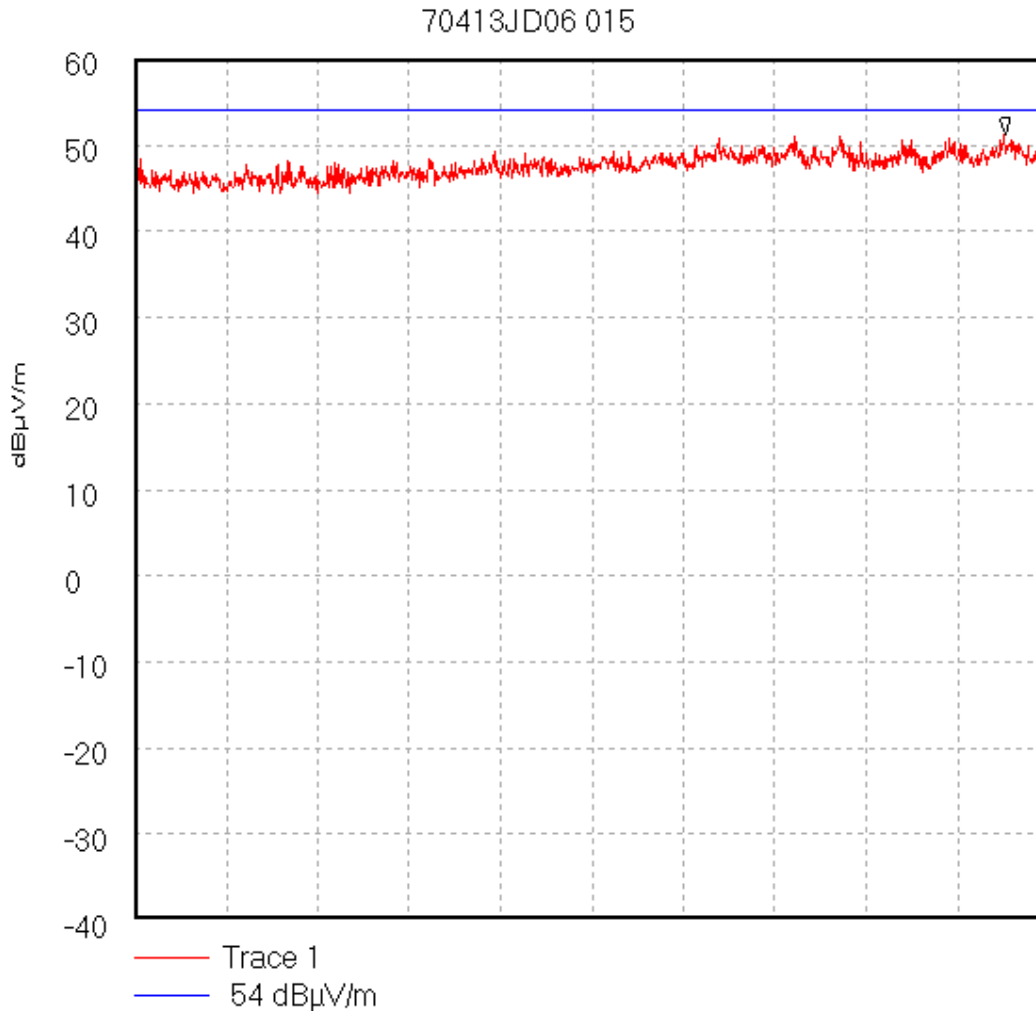

Start 18.0 GHz; Stop 26.5 GHz

Ref 60 dBµV/m; Ref Offset 0.0 dB; 10 dB/div

RBW 1.0 MHz; VBW 1.0 MHz; Att 0 dB; Swp 60.0 mS

Peak 26.093889 GHz, 51.24 dBµV/m

Display Line: 54 dBµV/m; ; Limit Test Passed

22/10/02 14:50:39



Test Of: Nokia UK Ltd.

Cameron Imaging Phone 3650 (NHL-8) Mobile Phone Handset

To: FCC Part 24: 2001, FCC Part 15: 2001 and Part 2: 2001

GPH\70413JD06\022

Radiated Emissions..

Test for Nokia of NHL-8XX CAMERON M.S. IMEI:-004400/11/1753558/3..

Operating Condition :- Idle Mode.

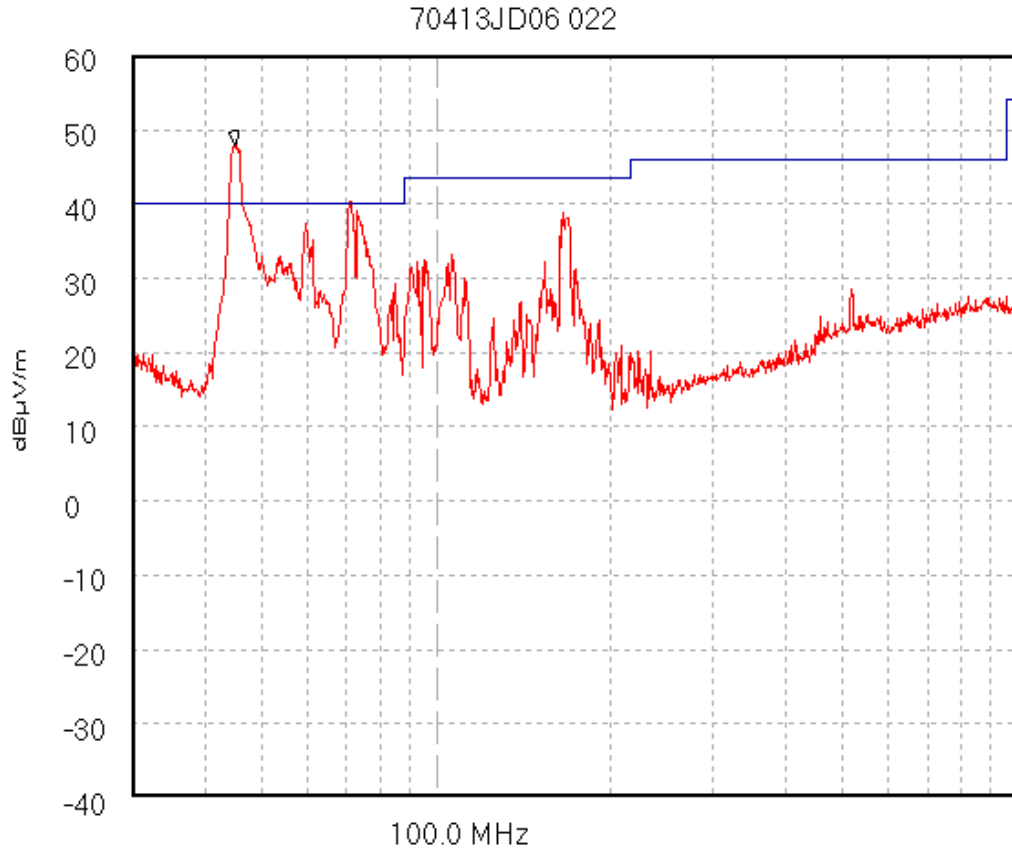

Trace 1  
rad\_30\_to\_1000

Start 30.0 MHz; Stop 1.0 GHz - Log Scale  
Ref 60 dBµV/m; Ref Offset 0.0 dB; 10 dB/div  
RBW 120.0 kHz; VBW 100.0 kHz; Att 0 dB; Swp 380.0 mS  
Peak 45.164 MHz, 47.99 dBµV/m  
Limit/Mask: rad\_30\_to\_1000; ; Limit Test Failed  
Transducer Factors: A1037  
21/11/2002 10:28:38

Test Of: Nokia UK Ltd.

Cameron Imaging Phone 3650 (NHL-8) Mobile Phone Handset

To: FCC Part 24: 2001, FCC Part 15: 2001 and Part 2: 2001

GPH\70413JD06\023

Radiated Emissions.

Test for Nokia of NHL-8XX CAMERON M.S. IMEI:-004400/11/1753558/3.

Operating Condition :- Allocated Middle Channel.

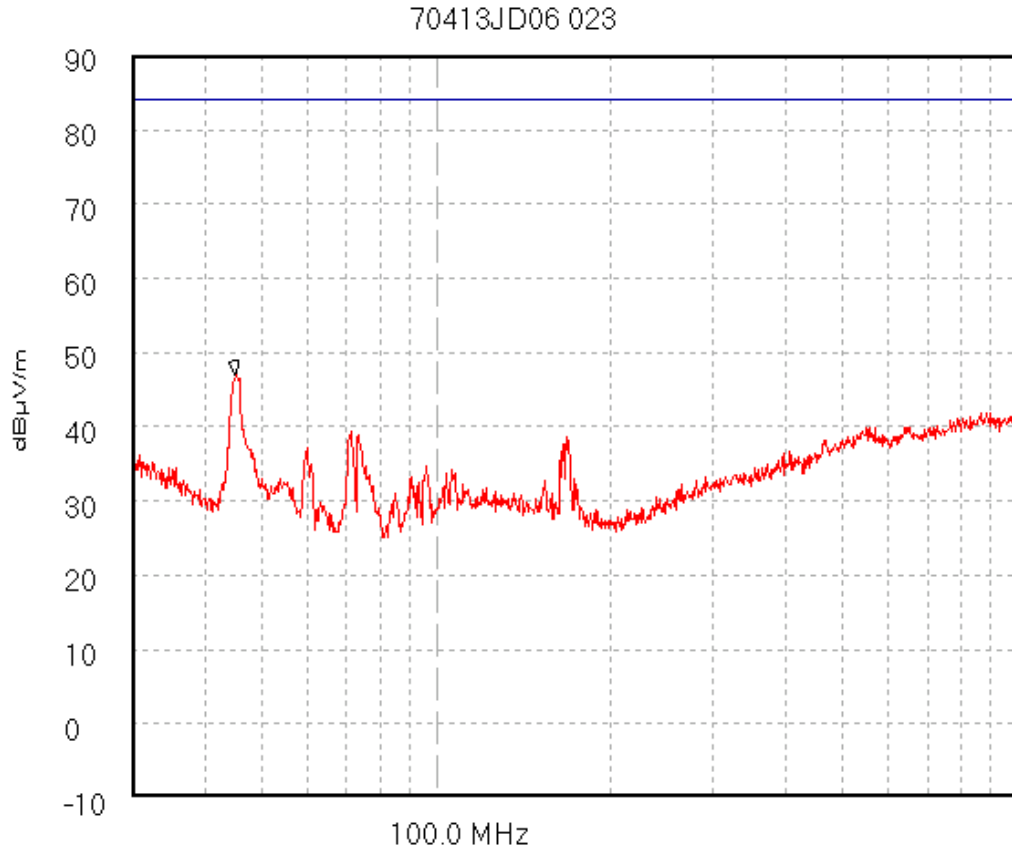

Trace 1  
84 dBµV/m

Start 30.0 MHz; Stop 1.0 GHz - Log Scale  
Ref 90 dBµV/m; Ref Offset 0.0 dB; 10 dB/div  
RBW 120.0 kHz; VBW 100.0 kHz; Att 6 dB; Swp 380.0 mS  
Peak 45.164 MHz, 47.04 dBµV/m  
Display Line: 84 dBµV/m; ; Limit Test Passed  
Transducer Factors: A1037  
21/11/2002 10:33:32

Test Of: Nokia UK Ltd.

Cameron Imaging Phone 3650 (NHL-8) Mobile Phone Handset

To: FCC Part 24: 2001, FCC Part 15: 2001 and Part 2: 2001

GPH\70413JD06\024

Test for Nokia of NHL-8XX CAMERON M.S. IMEI:-004400/11/1753558/3.

Operating Condition :- Allocated Middle Channel.

70413JD06 024

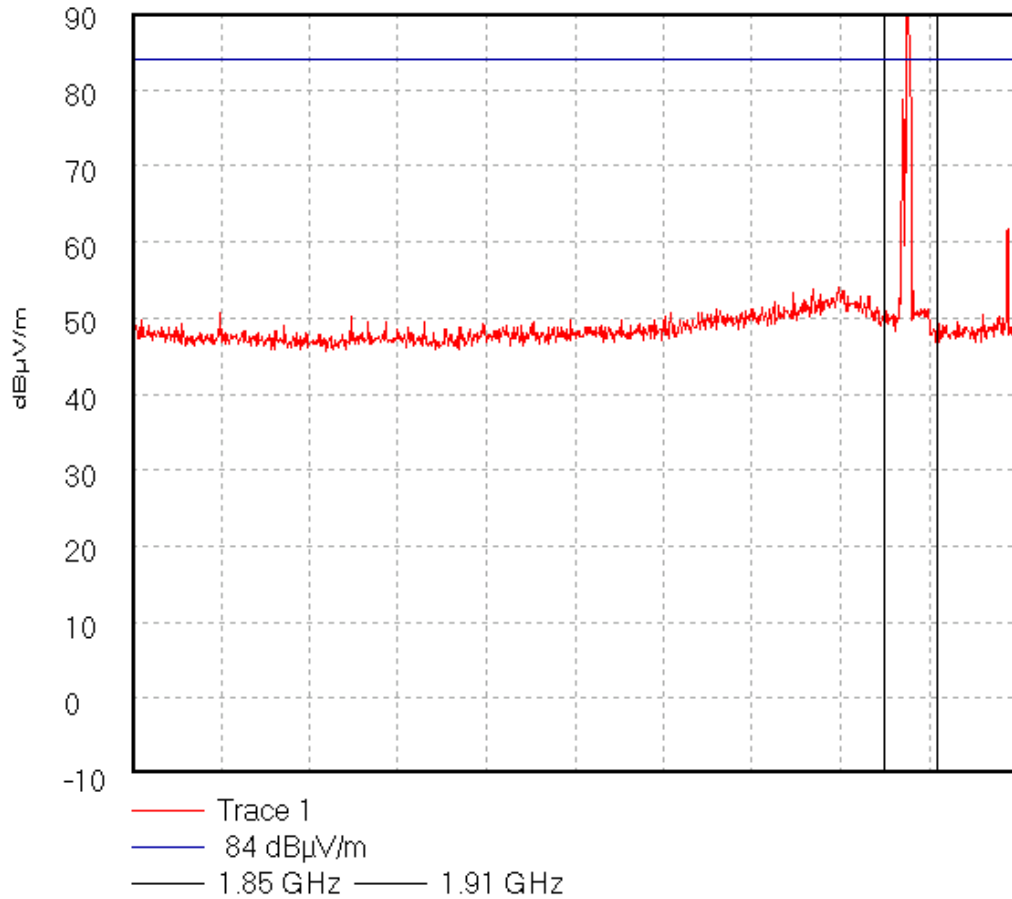

Start 1.0 GHz; Stop 2.0 GHz

Ref 90 dBµV/m; Ref Offset 0.0 dB; 10 dB/div

RBW 1000.0 kHz; VBW 1.0 MHz; Att 6 dB; Swp 20.0 mS

Peak 1.877 GHz, 93.98 dBµV/m

Display Line: 84 dBµV/m; ; Limit Test Failed

Transducer Factors: 1 to 2

21/11/2002 10:44:22

Test Of: Nokia UK Ltd.

Cameron Imaging Phone 3650 (NHL-8) Mobile Phone Handset

To: FCC Part 24: 2001, FCC Part 15: 2001 and Part 2: 2001

GPH\70413JD06\025

Test for Nokia of NHL-8XX CAMERON M.S. IMEI:-004400/11/1753558/3.

Operating Condition :- Idle Mode.

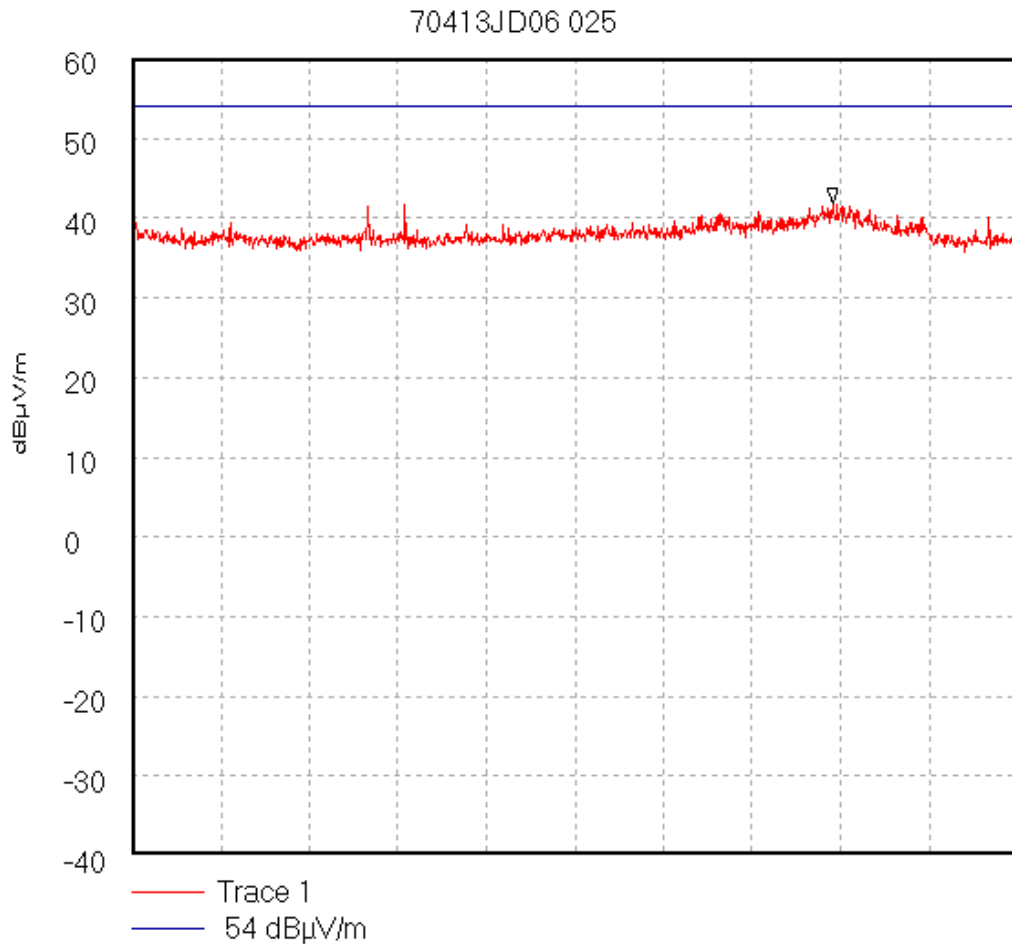

Start 1.0 GHz; Stop 2.0 GHz

Ref 60 dBµV/m; Ref Offset 0.0 dB; 10 dB/div

RBW 1000.0 kHz; VBW 1.0 MHz; Att 0 dB; Swp 20.0 mS

Peak 1.792 GHz, 41.8 dBµV/m

Display Line: 54 dBµV/m; ; Limit Test Passed

Transducer Factors: 1 to 2

21/11/2002 10:47:10

Test Of: Nokia UK Ltd.

Cameron Imaging Phone 3650 (NHL-8) Mobile Phone Handset

To: FCC Part 24: 2001, FCC Part 15: 2001 and Part 2: 2001

GPH\70413JD06\026

Test for Nokia of NHL-8XX CAMERON M.S. IMEI:-004400/11/1753558/3.

Operating Condition :- Idle Mode.

70413JD06 026

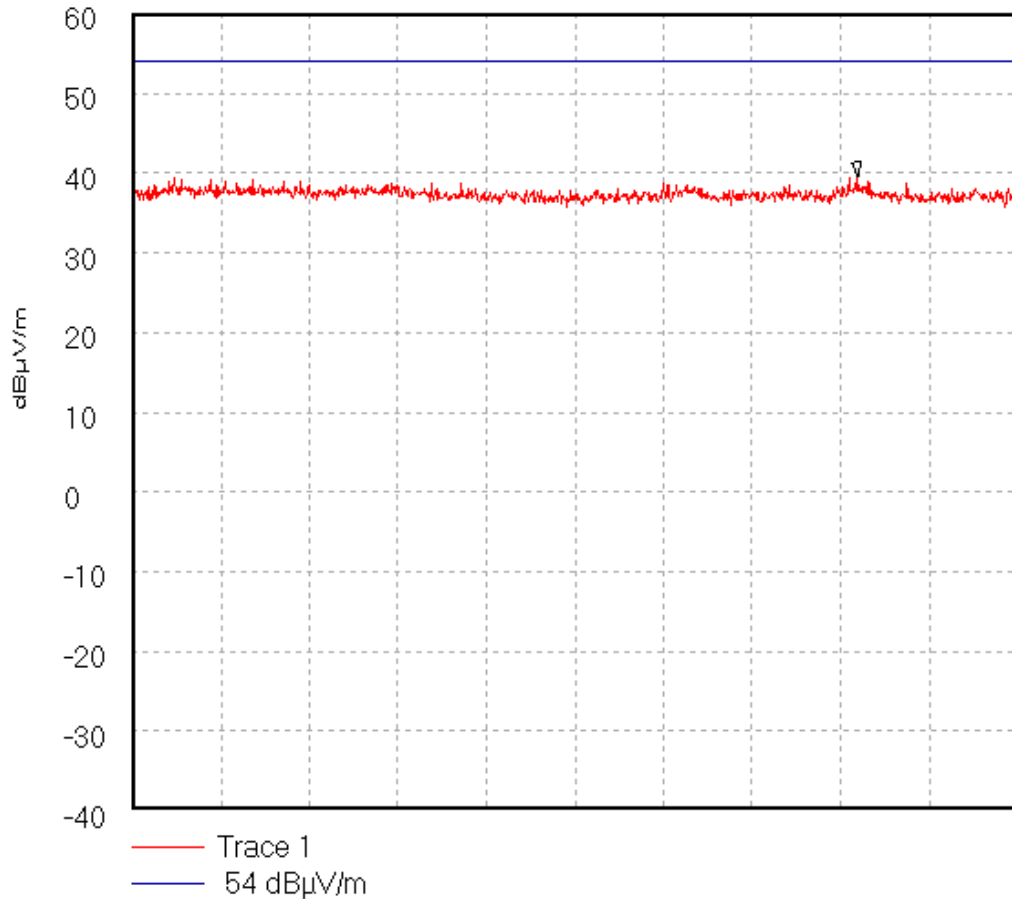

Start 2.0 GHz; Stop 4.0 GHz  
Ref 60 dBµV/m; Ref Offset 0.0 dB; 10 dB/div  
RBW 1000.0 kHz; VBW 1.0 MHz; Att 0 dB; Swp 20.0 mS  
Peak 3.64 GHz, 39.49 dBµV/m  
Display Line: 54 dBµV/m; ; Limit Test Failed  
Transducer Factors: 2 to 4  
21/11/2002 10:51:03

Test Of: Nokia UK Ltd.

Cameron Imaging Phone 3650 (NHL-8) Mobile Phone Handset

To: FCC Part 24: 2001, FCC Part 15: 2001 and Part 2: 2001

GPH\70413JD06\027

Test for Nokia of NHL-8XX CAMERON M.S. IMEI:-004400/11/1753558/3.

Operating Condition :- Allocated Middle Channel.

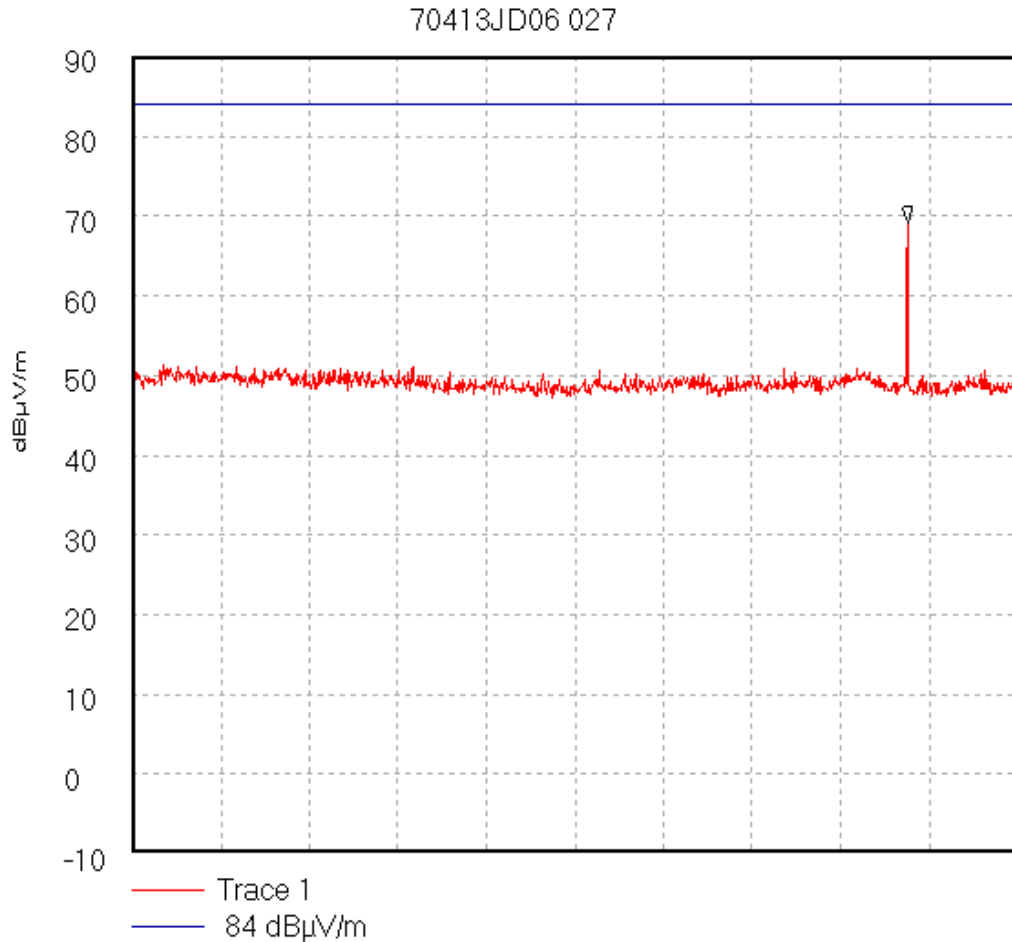

Start 2.0 GHz; Stop 4.0 GHz

Ref 90 dBµV/m; Ref Offset 0.0 dB; 10 dB/div

RBW 1000.0 kHz; VBW 1.0 MHz; Att 6 dB; Swp 20.0 mS

Peak 3.753 GHz, 69.18 dBµV/m

Display Line: 84 dBµV/m; ; Limit Test Failed

Transducer Factors: 2 to 4

21/11/2002 10:53:10

Test Of: Nokia UK Ltd.

Cameron Imaging Phone 3650 (NHL-8) Mobile Phone Handset

To: FCC Part 24: 2001, FCC Part 15: 2001 and Part 2: 2001

GPH\70413JD06\028

Conducted Emissions.

Test for Nokia of NHL-8XX CAMERON M.S. IMEI:-004400/11/1753558/3.

Operating Condition :- Idle Mode.

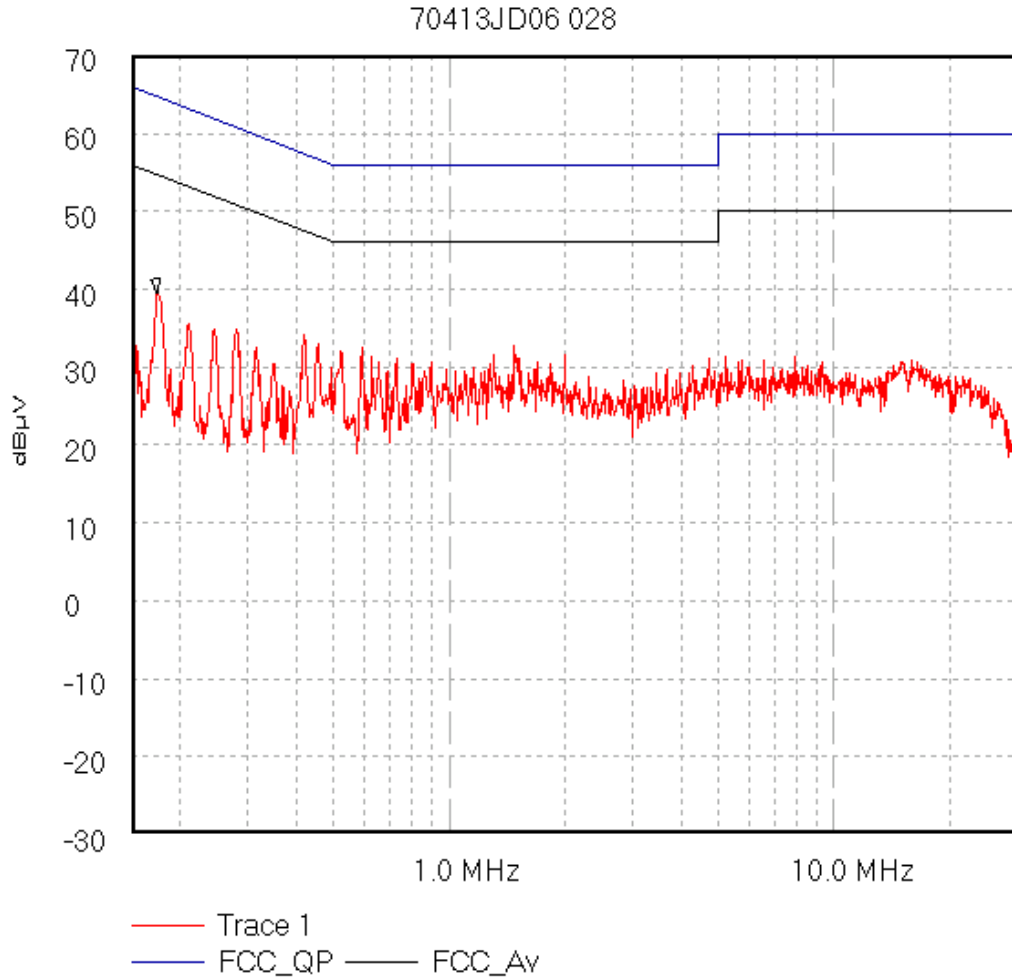

Start 150.0 kHz; Stop 30.0 MHz - Log Scale

Ref 70 dBµV; Ref Offset 0.0 dB; 10 dB/div

RBW 9.0 kHz; VBW 10.0 kHz; Att 6 dB; Swp 1.94 S

Peak 173.783 kHz, 39.46 dBµV

Limit/Mask: FCC\_QP; FCC\_Av; ; Limit Test Passed

21/11/2002 11:19:16

Test Of: Nokia UK Ltd.

Cameron Imaging Phone 3650 (NHL-8) Mobile Phone Handset

To: FCC Part 24: 2001, FCC Part 15: 2001 and Part 2: 2001

GPH\70413JD06BE\001

Radiated band Edge.

Test for Nokia of NHL-8XX CAMERON M.S. IMEI:-004400/11/1753558/3.

Operating Condition :- Allocated Bottom Channel.

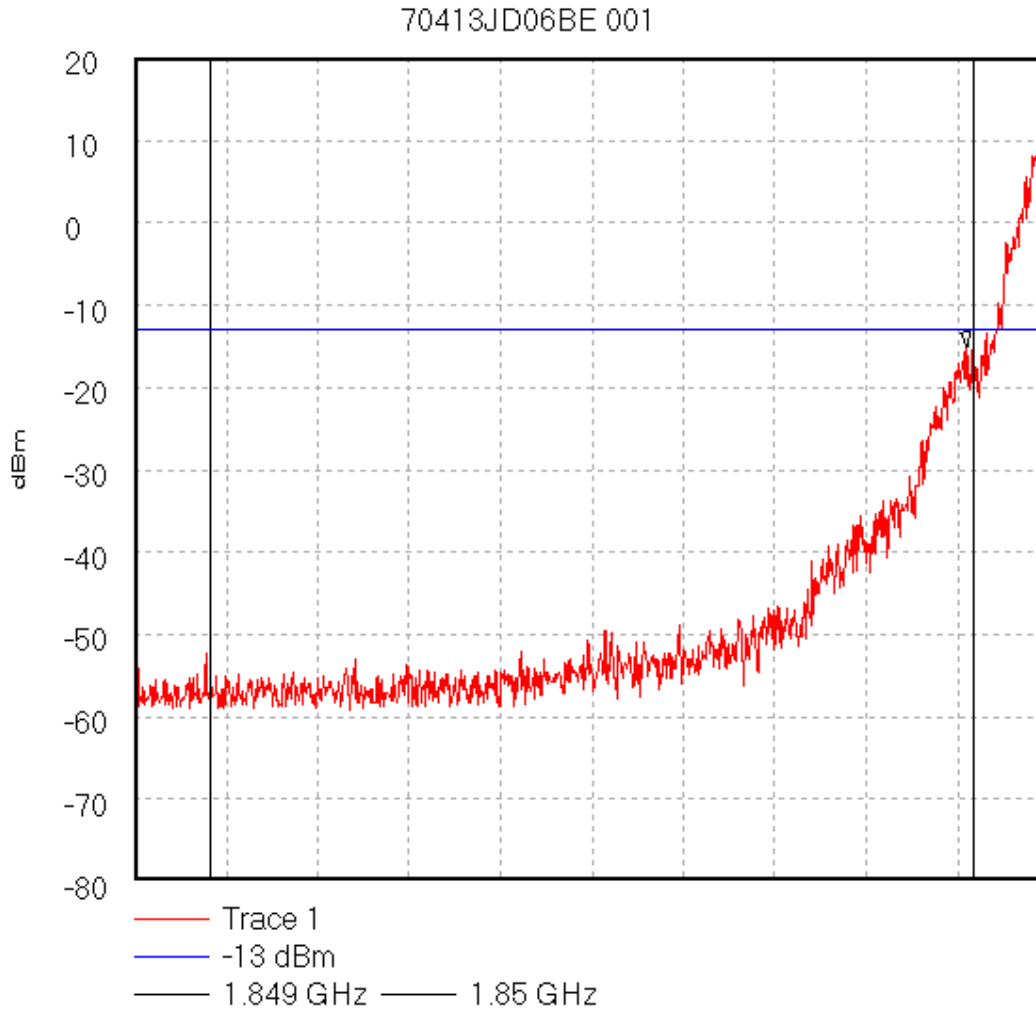

Start 1.8489 GHz; Stop 1.8501 GHz

Ref 20 dBm; Ref Offset 22.2 dB; 10 dB/div

RBW 3.0 kHz; VBW 3.0 kHz; Att 10 dB; Swp 400.0 mS

Marker 1.849993 GHz, -15.09 dBm

Display Line: -13 dBm;

27/11/02 13:22:57



Test Of: Nokia UK Ltd.

Cameron Imaging Phone 3650 (NHL-8) Mobile Phone Handset

To: FCC Part 24: 2001, FCC Part 15: 2001 and Part 2: 2001

GPH\70413JD06BE\002

Radiated Band Edge.

Test for Nokia of NHL-8XX CAMERON M.S. IMEI:-004400/11/1753558/3.

Operating Condition :- Allocated Top Channel.

70413JD06BE 002

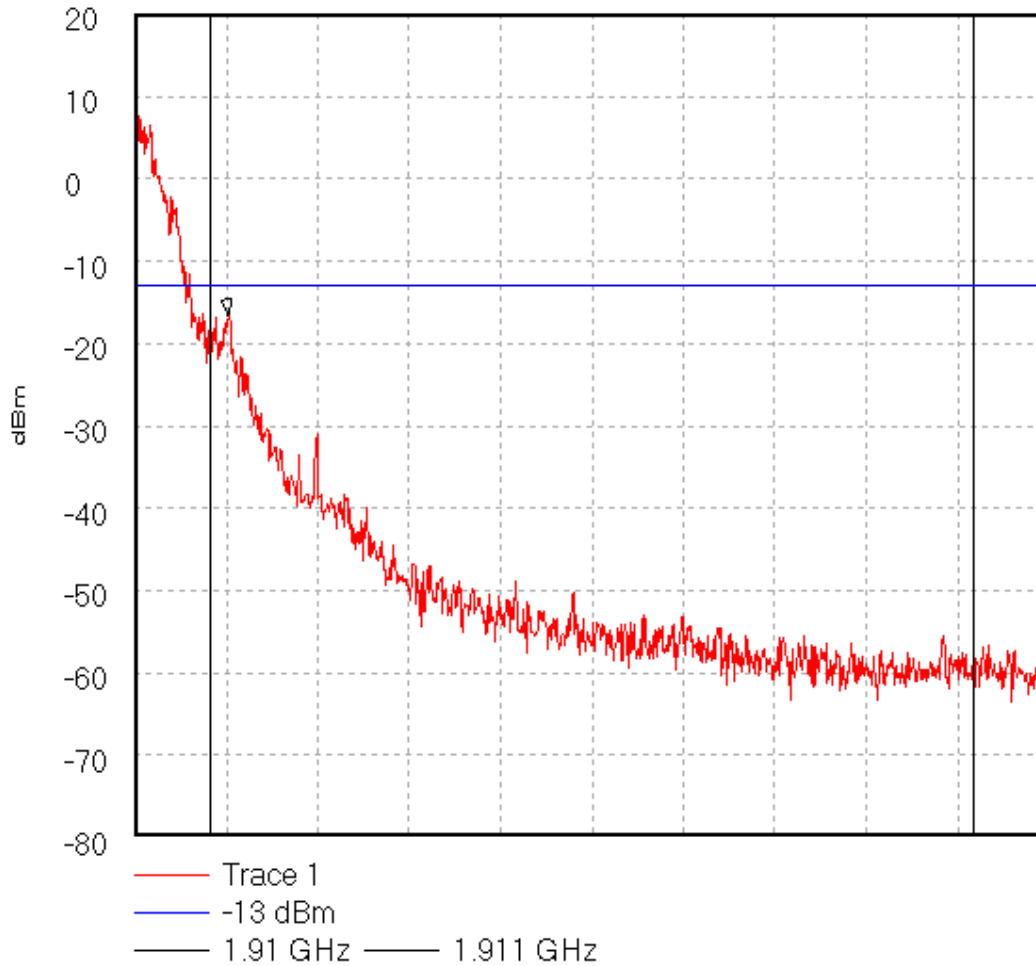

Start 1.9099 GHz; Stop 1.9111 GHz

Ref 20 dBm; Ref Offset 25.6 dB; 10 dB/div

RBW 3.0 kHz; VBW 3.0 kHz; Att 10 dB; Swp 400.0 mS

Marker 1.910023 GHz, -16.64 dBm

Display Line: -13 dBm;

27/11/02 13:38:51

Test Of: Nokia UK Ltd.

Cameron Imaging Phone 3650 (NHL-8) Mobile Phone Handset

To: FCC Part 24: 2001, FCC Part 15: 2001 and Part 2: 2001

---

### **Appendix 5. Photographs of EUT**

This appendix contains the following photographs:

<b>Photo Reference Number</b>	<b>Title</b>
PHT\70413JD06\001	Front View of Conducted Emissions Set-up
PHT\70413JD06\002	Rear View of Conducted Emissions Set-up
PHT\70413JD06\003	Front View of Radiated Emissions Set-up
PHT\70413JD06\004	Rear View of Radiated Emissions Set-up

**These pages are not included in the total number of pages for this report.**

RADIO FREQUENCY INVESTIGATION LTD.

TEST REPORT

Conformance Testing Department

Photograph Section

S.No: RFI/MPTB3/RP70413JD06A

Test Of: Nokia UK Ltd.

Cameron Imaging Phone 3650 (NHL-8) Mobile Phone Handset

To: FCC Part 24: 2001, FCC Part 15: 2001 and Part 2: 2001

---

**PHT\70413JD06\001 Front View of AC Conducted Emissions Set-up**



RADIO FREQUENCY INVESTIGATION LTD.

TEST REPORT

Conformance Testing Department

Photograph Section

S.No: RFI/MPTB3/RP70413JD06A

Test Of: Nokia UK Ltd.

Cameron Imaging Phone 3650 (NHL-8) Mobile Phone Handset

To: FCC Part 24: 2001, FCC Part 15: 2001 and Part 2: 2001

---

**PHT\70413JD06\002 Rear View of AC Conducted Emissions Set-up**



RADIO FREQUENCY INVESTIGATION LTD.

TEST REPORT

Conformance Testing Department

Photograph Section

S.No: RFI/MPTB3/RP70413JD06A

Test Of: Nokia UK Ltd.

Cameron Imaging Phone 3650 (NHL-8) Mobile Phone Handset

To: FCC Part 24: 2001, FCC Part 15: 2001 and Part 2: 2001

---

**PHT\70413JD06\003 Front View of Radiated Emissions Set-up**



RADIO FREQUENCY INVESTIGATION LTD.

TEST REPORT

Conformance Testing Department

Photograph Section

S.No: RFI/MPTB3/RP70413JD06A

Test Of: Nokia UK Ltd.

Cameron Imaging Phone 3650 (NHL-8) Mobile Phone Handset

To: FCC Part 24: 2001, FCC Part 15: 2001 and Part 2: 2001

---

**PHT\70413JD06\004 Rear View of Radiated Emissions Set-up**

