



FCC TEST REPORT (15.247)

REPORT NO.: RF970807L10

MODEL NO.: WET610N

RECEIVED: Aug. 07, 2008

TESTED: Aug. 13 ~ Sep. 10, 208

ISSUED: Sep. 10, 2008

APPLICANT: Cisco-Linksys LLC

ADDRESS: 121 Theory Drive Irvine, CA 92617 (USA)

ISSUED BY: Advance Data Technology Corporation

LAB ADDRESS: No. 47, 14th Ling, Chia Pau Tsuen, Lin Kou Hsiang, Taipei Hsien 244, Taiwan, R.O.C.

TEST LOCATION: No. 19, Hwa Ya 2nd Rd, Wen Hwa Tsuen, Kwei Shan Hsiang, Taoyuan Hsien 333, Taiwan, R.O.C.

This test report consists of 155 pages in total. It may be duplicated completely for legal use with the approval of the applicant. It should not be reproduced except in full, without the written approval of our laboratory. The client should not use it to claim product endorsement by TAF or any government agencies. The test results in the report only apply to the tested sample.





TABLE OF CONTENTS

1.	CERTIFICATION.....	5
2.	SUMMARY OF TEST RESULTS	6
2.1	MEASUREMENT UNCERTAINTY.....	6
3.	GENERAL INFORMATION.....	7
3.1	GENERAL DESCRIPTION OF EUT	7
3.2	DESCRIPTION OF TEST MODES.....	9
3.2.1	CONFIGURATION OF SYSTEM UNDER TEST	9
3.2.2	TEST MODE APPLICABILITY AND TESTED CHANNEL DETAIL	10
3.3	GENERAL DESCRIPTION OF APPLIED STANDARDS	14
3.4	DESCRIPTION OF SUPPORT UNITS	14
4.	TEST TYPES AND RESULTS (FOR 2.4GHz BAND).....	15
4.1	RADIATED EMISSION MEASUREMENT	15
4.1.1	LIMITS OF RADIATED EMISSION MEASUREMENT.....	15
4.1.2	TEST INSTRUMENTS.....	16
4.1.3	TEST PROCEDURES	17
4.1.4	DEVIATION FROM TEST STANDARD.....	17
4.1.5	TEST SETUP.....	18
4.1.6	EUT OPERATING CONDITIONS	18
4.1.7	TEST RESULTS	19
4.2	CONDUCTED EMISSION MEASUREMENT	32
4.2.1	LIMITS OF CONDUCTED EMISSION MEASUREMENT.....	32
4.2.2	TEST INSTRUMENTS.....	32
4.2.3	TEST PROCEDURES	33
4.2.4	DEVIATION FROM TEST STANDARD.....	33
4.2.5	TEST SETUP.....	34
4.2.6	EUT OPERATING CONDITIONS	34
4.2.7	TEST RESULTS	35
4.3	6dB BANDWIDTH MEASUREMENT.....	37
4.3.1	LIMITS OF 6dB BANDWIDTH MEASUREMENT	37
4.3.2	TEST INSTRUMENTS.....	37
4.3.3	TEST PROCEDURE.....	37
4.3.4	DEVIATION FROM TEST STANDARD.....	37
4.3.5	TEST SETUP.....	38
4.3.6	EUT OPERATING CONDITIONS	38
4.3.7	TEST RESULTS	39
4.4	MAXIMUM PEAK OUTPUT POWER.....	53
4.4.1	LIMITS OF MAXIMUM PEAK OUTPUT POWER MEASUREMENT	53
4.4.2	INSTRUMENTS.....	53
4.4.3	TEST PROCEDURES	53
4.4.4	DEVIATION FROM TEST STANDARD.....	53
4.4.5	TEST SETUP.....	54
4.4.6	EUT OPERATING CONDITIONS	54
4.4.7	TEST RESULTS	55
4.5	POWER SPECTRAL DENSITY MEASUREMENT.....	57
4.5.1	LIMITS OF POWER SPECTRAL DENSITY MEASUREMENT	57
4.5.2	TEST INSTRUMENTS.....	57
4.5.3	TEST PROCEDURE.....	57
4.5.4	DEVIATION FROM TEST STANDARD.....	58



4.5.5	TEST SETUP.....	58
4.5.6	EUT OPERATING CONDITION.....	58
4.5.7	TEST RESULTS	59
4.6	BAND EDGES MEASUREMENT	73
4.6.1	LIMITS OF BAND EDGES MEASUREMENT.....	73
4.6.2	TEST INSTRUMENTS.....	73
4.6.3	TEST PROCEDURE.....	74
4.6.4	DEVIATION FROM TEST STANDARD.....	74
4.6.5	EUT OPERATING CONDITION.....	74
4.6.6	TEST RESULTS	75
4.7	ANTENNA REQUIREMENT	91
4.7.1	STANDARD APPLICABLE	91
4.7.2	ANTENNA CONNECTED CONSTRUCTION	91
5.	TEST TYPES AND RESULTS (FOR 5.0GHz BAND).....	92
5.1	RADIATED EMISSION MEASUREMENT	92
5.1.1	LIMITS OF RADIATED EMISSION MEASUREMENT.....	92
5.1.2	TEST INSTRUMENTS.....	93
5.1.3	TEST PROCEDURES	94
5.1.4	DEVIATION FROM TEST STANDARD.....	94
5.1.5	TEST SETUP.....	95
5.1.6	EUT OPERATING CONDITIONS	95
5.1.7	TEST RESULTS	96
5.2	CONDUCTED EMISSION MEASUREMENT	105
5.2.1	LIMITS OF CONDUCTED EMISSION MEASUREMENT.....	105
5.2.2	TEST INSTRUMENTS.....	105
5.2.3	TEST PROCEDURES	106
5.2.4	DEVIATION FROM TEST STANDARD.....	106
5.2.5	TEST SETUP.....	107
5.2.6	EUT OPERATING CONDITIONS	107
5.2.7	TEST RESULTS	108
5.3	6dB BANDWIDTH MEASUREMENT.....	110
5.3.1	LIMITS OF 6dB BANDWIDTH MEASUREMENT	110
5.3.2	TEST INSTRUMENTS.....	110
5.3.3	TEST PROCEDURE.....	110
5.3.4	DEVIATION FROM TEST STANDARD.....	111
5.3.5	TEST SETUP.....	111
5.3.6	EUT OPERATING CONDITIONS	111
5.3.7	TEST RESULTS	112
5.4	MAXIMUM PEAK OUTPUT POWER.....	123
5.4.1	LIMITS OF MAXIMUM PEAK OUTPUT POWER MEASUREMENT	123
5.4.2	INSTRUMENTS.....	123
5.4.3	TEST PROCEDURES	123
5.4.4	DEVIATION FROM TEST STANDARD.....	124
5.4.5	TEST SETUP.....	124
5.4.6	EUT OPERATING CONDITIONS	124
5.4.7	TEST RESULTS	125
5.5	POWER SPECTRAL DENSITY MEASUREMENT.....	127
5.5.1	LIMITS OF POWER SPECTRAL DENSITY MEASUREMENT	127
5.5.2	TEST INSTRUMENTS.....	127
5.5.3	TEST PROCEDURE.....	127
5.5.4	DEVIATION FROM TEST STANDARD.....	128



5.5.5	TEST SETUP	128
5.5.6	EUT OPERATING CONDITION.....	128
5.5.7	TEST RESULTS	129
5.6	BAND EDGES MEASUREMENT	140
5.6.1	LIMITS OF BAND EDGES MEASUREMENT	140
5.6.2	TEST INSTRUMENTS.....	140
5.6.3	TEST PROCEDURE.....	141
5.6.4	DEVIATION FROM TEST STANDARD.....	142
5.6.5	EUT OPERATING CONDITION.....	142
5.6.6	TEST RESULTS	142
5.7	ANTENNA REQUIREMENT	152
5.7.1	STANDARD APPLICABLE	152
5.7.2	ANTENNA CONNECTED CONSTRUCTION	152
6.	PHOTOGRAPHS OF THE TEST CONFIGURATION.....	153
7.	INFORMATION ON THE TESTING LABORATORIES	154
8.	APPENDIX A - MODIFICATIONS RECORDERS FOR ENGINEERING CHANGES TO THE EUT BY THE LAB.....	155



1. CERTIFICATION

PRODUCT: Wireless-N Ethernet Bridge with Dual-Band

MODEL: WET610N

BRAND: Linksys

APPLICANT: Cisco-Linksys LLC

TEST SAMPLE: ENGINEERING SAMPLE

TESTED: Aug. 13 ~ Sep. 10, 2008

**STANDARDS: FCC Part 15, Subpart C (Section 15.247)
ANSI C63.4-2003**

The above equipment (Model: WET610N) has been tested by **Advance Data Technology Corporation**, and found compliance with the requirement of the above standards. The test record, data evaluation & Equipment Under Test (EUT) configurations represented herein are true and accurate accounts of the measurements of the sample's EMC characteristics under the conditions specified in this report.

PREPARED BY : Andrea Hsia , **DATE:** Sep. 10, 2008
Andrea Hsia / Specialist

TECHNICAL ACCEPTANCE : Long Chen , **DATE:** Sep. 10, 2008
Responsible for RF Long Chen / Senior Engineer

APPROVED BY : Gary Chang , **DATE:** Sep. 10, 2008
Gary Chang / Assistant Manager

2. SUMMARY OF TEST RESULTS

The EUT has been tested according to the following specifications:

APPLIED STANDARD: FCC PART 15, SUBPART C (SECTION 15.247)			
STANDARD SECTION	TEST TYPE AND LIMIT	RESULT	REMARK
15.207	AC Power Conducted Emission	PASS	Meet the requirement of limit. Minimum passing margin is -14.90dB at 0.197MHz
15.247(a)(2)	Spectrum Bandwidth of a Direct Sequence Spread Spectrum System Limit: min. 500kHz	PASS	Meet the requirement of limit.
15.247(b)	Maximum Peak Output Power Limit: max. 30dBm	PASS	Meet the requirement of limit.
15.247(d)	Radiated Emissions Limit: Table 15.209	PASS	Meet the requirement of limit. Minimum passing margin is -1.24dB at 11570.00MHz
15.247(e)	Power Spectral Density Limit: max. 8dBm	PASS	Meet the requirement of limit.
15.247(d)	Band Edge Measurement Limit: 20dB less than the peak value of fundamental frequency	PASS	Meet the requirement of limit.

2.1 MEASUREMENT UNCERTAINTY

Where relevant, the following measurement uncertainty levels have been estimated for tests performed on the EUT as specified in CISPR 16-4-2:

MEASUREMENT	FREQUENCY	UNCERTAINTY
Conducted emissions	9kHz~30MHz	2.44 dB
Radiated emissions	30MHz ~ 200MHz	2.93 dB
	200MHz ~1000MHz	2.95 dB
	1GHz ~ 18GHz	2.26 dB
	18GHz ~ 40GHz	1.94 dB

This uncertainty represents an expanded uncertainty expressed at approximately the 95% confidence level using a coverage factor of $k = 2$.



3. GENERAL INFORMATION

3.1 GENERAL DESCRIPTION OF EUT

EUT	Wireless-N Ethernet Bridge with Dual-Band
MODEL NO.	WET610N
FCC ID	Q87-WET610N
POWER SUPPLY	12Vdc from AC Adapter
MODULATION TYPE	CCK, DQPSK, DBPSK for DSSS 64QAM, 16QAM, QPSK, BPSK for OFDM
MODULATION TECHNOLOGY	DSSS, OFDM
TRANSFER RATE	802.11b: 11.0/ 5.5/ 2.0/ 1.0Mbps 802.11g: 54.0/ 48.0/ 36.0/ 24.0/ 18.0/ 12.0/ 9.0/ 6.0Mbps 802.11a: 54.0/ 48.0/ 36.0/ 24.0/ 18.0/ 12.0/ 9.0/ 6.0Mbps Draft 802.11n: up to 300.0Mbps
FREQUENCY RANGE	2.4GHz: 2400.0 ~ 2483.5MHz 5.0GHz: 5150.0 ~ 5350.0MHz, 5470.0 ~ 5725.0MHz, 5725 ~ 5850MHz
NUMBER OF CHANNEL	2.4GHz: 11 for 802.11b, 802.11g, draft 802.11n (20MHz) 7 for draft 802.11n (40MHz) 5.0GHz: 5150 ~ 5350MHz: 8 for 802.11a, draft 802.11n (20MHz) 4 for draft 802.11n (40MHz) 5470 ~ 5725MHz: 11 for 802.11a, draft 802.11n (20MHz) 5 for draft 802.11n (40MHz) 5725 ~ 5850MHz: 5 for 802.11a, draft 802.11n (20MHz) 2 for draft 802.11n (40MHz)
OUTPUT POWER	342.857mW for 2400.0 ~ 2483.5MHz 26.991mW for 5150.0 ~ 5350.0MHz 25.796mW for 5470.0 ~ 5725.0MHz 324.370mW for 5725.0 ~ 5850.0MHz
ANTENNA TYPE	For transmission & receiving: PIFA antenna with 1.00dBi gain (for 2.4GHz) PIFA antenna with 1.28dBi gain (for 5.0GHz) For receiving only: PIFA antenna with 1.58dBi gain (for 2.4GHz) PIFA antenna with 1.45dBi gain (for 5.0GHz)
DATA CABLE	NA
I/O PORTS	RJ45
ACCESSORY DEVICES	Adapter

NOTE:

1. The EUT is a Wireless-N Ethernet Bridge with Dual-Band. The functions of EUT listed as below:

	TEST STANDARD	REFERENCE REPORT
WLAN 802.11b/g, draft 802.11n	FCC Part 15, Subpart C (Section 15.247)	RF970807L10
WLAN 802.11a, draft 802.11n (5725~5850 MHz)		
WLAN 802.11a, draft 802.11n (5150~ 5350MHz, 5470 ~ 5725MHz)	FCC Part 15, Subpart E (Section 15.407)	RF970807L10-1

2. The frequency bands used in this EUT are listed as follows:

Frequency Band (MHz)	2400~2483.5	5150~5350	5470 ~ 5725	5725~5850
802.11b	√	-	-	-
802.11g	√	-	-	-
802.11a	-	√	√	√
Draft 802.11n (20MHz)	√	√	√	√
Draft 802.11n (40MHz)	√	√	√	√

3. The EUT was powered by the following adapter:

BRAND	BesTec
MODEL	EA0121WAA
INPUT POWER	100-240Vac, 50-60Hz, 0.5A
OUTPUT POWER	12Vdc, 1A MAX
POWER LINE	1.8m non-shielded cable without core

4. The EUT incorporates a MIMO function. Physically, the EUT provides two completed transmitters and three receivers.

MODULATION MODE	TX FUNCTION
802.11b	1TX
802.11g	2TX
802.11a	2TX
Draft 802.11n (20MHz)	2TX
Draft 802.11n (40MHz)	2TX

5. The above EUT information was declared by manufacturer and for more detailed features description, please refer to the manufacturer's specifications or user's manual.

3.2 DESCRIPTION OF TEST MODES

FOR 2.4GHz:

11 channels are provided for 802.11b, 802.11g and draft 802.11n (20MHz):

CHANNEL	FREQUENCY	CHANNEL	FREQUENCY
1	2412MHz	7	2442MHz
2	2417MHz	8	2447MHz
3	2422MHz	9	2452MHz
4	2427MHz	10	2457MHz
5	2432MHz	11	2462MHz
6	2437MHz		

7 channels are provided for draft 802.11n (40MHz):

CHANNEL	FREQUENCY	CHANNEL	FREQUENCY
1	2422MHz	5	2442MHz
2	2427MHz	6	2447MHz
3	2432MHz	7	2452MHz
4	2437MHz		

FOR 5.0GHz (5725 ~ 5850MHz):

5 channels are provided for 802.11a, draft 802.11n (20MHz):

CHANNEL	FREQUENCY	CHANNEL	FREQUENCY
149	5745MHz	161	5805MHz
153	5765MHz	165	5825MHz
157	5785MHz		

2 channels are provided for draft 802.11n (40MHz):

CHANNEL	FREQUENCY	CHANNEL	FREQUENCY
151	5755MHz	159	5795MHz

3.2.1 CONFIGURATION OF SYSTEM UNDER TEST

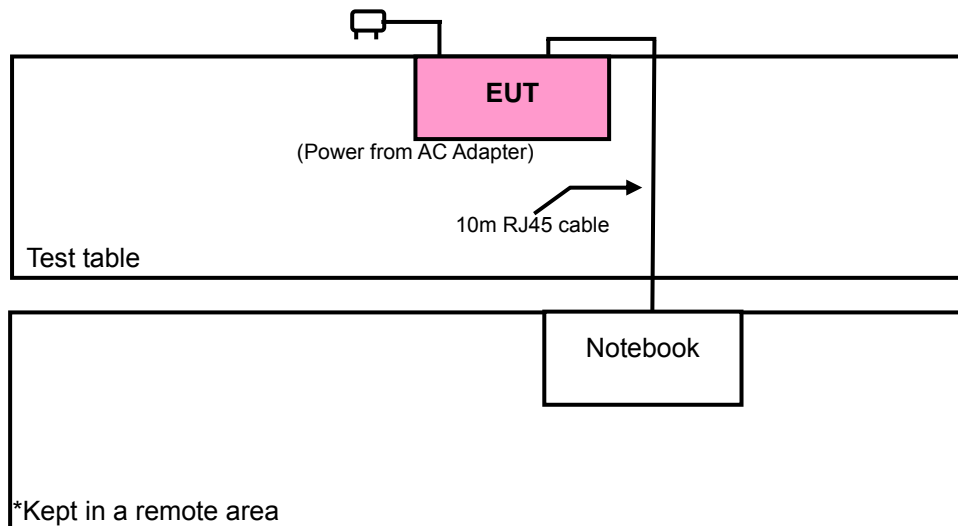

3.2.2 TEST MODE APPLICABILITY AND TESTED CHANNEL DETAIL

FOR 2.4GHz:

EUT CONFIGURE MODE	APPLICABLE TO				DESCRIPTION
	RE \geq 1G	RE<1G	PLC	APCM	
-	√	√	√	√	-

Where **RE \geq 1G**: Radiated Emission above 1GHz **RE<1G**: Radiated Emission below 1GHz
PLC: Power Line Conducted Emission **APCM**: Antenna Port Conducted Measurement

RADIATED EMISSION TEST (ABOVE 1GHz):

- Pre-Scan has been conducted to determine the worst-case mode from all possible combinations between available modulations, data rates and antenna ports (if EUT with antenna diversity architecture).
- Following channel(s) was (were) selected for the final test as listed below.

MODE	AVAILABLE CHANNEL	TESTED CHANNEL	MODULATION TECHNOLOGY	MODULATION TYPE	DATA RATE (Mbps)
802.11b	1 to 11	1, 6, 11	DSSS	DBPSK	1.0
802.11g	1 to 11	1, 6, 11	OFDM	BPSK	6.0
Draft 802.11n (20MHz)	1 to 11	1, 6, 11	OFDM	BPSK	7.2
Draft 802.11n (40MHz)	1 to 7	1, 4, 7	OFDM	BPSK	15.0

RADIATED EMISSION TEST (BELOW 1GHz):

- Pre-Scan has been conducted to determine the worst-case mode from all possible combinations between available modulations, data rates and antenna ports (if EUT with antenna diversity architecture).
- Following channel(s) was (were) selected for the final test as listed below.

MODE	AVAILABLE CHANNEL	TESTED CHANNEL	MODULATION TECHNOLOGY	MODULATION TYPE	DATA RATE (Mbps)
802.11g	1 to 11	6	OFDM	BPSK	6.0

POWER LINE CONDUCTED EMISSION TEST:

- Pre-Scan has been conducted to determine the worst-case mode from all possible combinations between available modulations, data rates and antenna ports (if EUT with antenna diversity architecture).
- Following channel(s) was (were) selected for the final test as listed below.

MODE	AVAILABLE CHANNEL	TESTED CHANNEL	MODULATION TECHNOLOGY	MODULATION TYPE	DATA RATE (Mbps)
802.11g	1 to 11	6	OFDM	BPSK	6.0

BANDEDGE MEASUREMENT:

- Pre-Scan has been conducted to determine the worst-case mode from all possible combinations between available modulations, data rates and antenna ports (if EUT with antenna diversity architecture).
- Following channel(s) was (were) selected for the final test as listed below.

MODE	AVAILABLE CHANNEL	TESTED CHANNEL	MODULATION TECHNOLOGY	MODULATION TYPE	DATA RATE (Mbps)
802.11b	1 to 11	1, 11	DSSS	DBPSK	1.0
802.11g	1 to 11	1, 11	OFDM	BPSK	6.0
Draft 802.11n (20MHz)	1 to 11	1, 11	OFDM	BPSK	7.2
Draft 802.11n (40MHz)	1 to 7	1, 7	OFDM	BPSK	15.0

ANTENNA PORT CONDUCTED MEASUREMENT:

- Pre-Scan has been conducted to determine the worst-case mode from all possible combinations between available modulations, data rates and antenna ports (if EUT with antenna diversity architecture).
- Following channel(s) was (were) selected for the final test as listed below.

MODE	AVAILABLE CHANNEL	TESTED CHANNEL	MODULATION TECHNOLOGY	MODULATION TYPE	DATA RATE (Mbps)
802.11b	1 to 11	1, 6, 11	DSSS	DBPSK	1.0
802.11g	1 to 11	1, 6, 11	OFDM	BPSK	6.0
Draft 802.11n (20MHz)	1 to 11	1, 6, 11	OFDM	BPSK	7.2
Draft 802.11n (40MHz)	1 to 7	1, 4, 7	OFDM	BPSK	15.0

FOR 5.0GHz (5.725 ~ 5.850GHz):

EUT CONFIGURE MODE	APPLICABLE TO				DESCRIPTION
	PLC	RE<1G	RE≥1G	APCM	
-	√	√	√	√	-

Where **PLC:** Power Line Conducted Emission **RE<1G:** Radiated Emission below 1GHz
RE≥1G: Radiated Emission above 1GHz **APCM:** Antenna Port Conducted Measurement

RADIATED EMISSION TEST (ABOVE 1GHz):

- Pre-Scan has been conducted to determine the worst-case mode from all possible combinations between available modulations, data rates and antenna ports (if EUT with antenna diversity architecture).
- Following channel(s) was (were) selected for the final test as listed below.

MODE	AVAILABLE CHANNEL	TESTED CHANNEL	MODULATION TECHNOLOGY	MODULATION TYPE	DATA RATE (Mbps)
802.11a	149 to 165	149, 157, 165	OFDM	BPSK	6.0
Draft 802.11n (20MHz)	149 to 165	149, 157, 165	OFDM	BPSK	7.2
Draft 802.11n (40MHz)	151 to 159	151, 159	OFDM	BPSK	15.0

RADIATED EMISSION TEST (BELOW 1GHz):

- Pre-Scan has been conducted to determine the worst-case mode from all possible combinations between available modulations, data rates and antenna ports (if EUT with antenna diversity architecture).
- Following channel(s) was (were) selected for the final test as listed below.

MODE	AVAILABLE CHANNEL	TESTED CHANNEL	MODULATION TECHNOLOGY	MODULATION TYPE	DATA RATE (Mbps)
802.11a	149 to 165	165	OFDM	BPSK	6.0

POWER LINE CONDUCTED EMISSION TEST:

- Pre-Scan has been conducted to determine the worst-case mode from all possible combinations between available modulations, data rates and antenna ports (if EUT with antenna diversity architecture).
- Following channel(s) was (were) selected for the final test as listed below.

MODE	AVAILABLE CHANNEL	TESTED CHANNEL	MODULATION TECHNOLOGY	MODULATION TYPE	DATA RATE (Mbps)
802.11a	149 to 165	165	OFDM	BPSK	6.0

BANDEDGE MEASUREMENT:

- Pre-Scan has been conducted to determine the worst-case mode from all possible combinations between available modulations, data rates and antenna ports (if EUT with antenna diversity architecture).
- Following channel(s) was (were) selected for the final test as listed below.

MODE	AVAILABLE CHANNEL	TESTED CHANNEL	MODULATION TECHNOLOGY	MODULATION TYPE	DATA RATE (Mbps)
802.11a	149 to 165	149, 165	OFDM	BPSK	6.0
Draft 802.11n (20MHz)	149 to 165	149, 165	OFDM	BPSK	7.2
Draft 802.11n (40MHz)	151 to 159	151, 159	OFDM	BPSK	15.0

ANTENNA PORT CONDUCTED MEASUREMENT:

- Pre-Scan has been conducted to determine the worst-case mode from all possible combinations between available modulations, data rates and antenna ports (if EUT with antenna diversity architecture).
- Following channel(s) was (were) selected for the final test as listed below.

MODE	AVAILABLE CHANNEL	TESTED CHANNEL	MODULATION TECHNOLOGY	MODULATION TYPE	DATA RATE (Mbps)
802.11a	149 to 165	149, 157, 165	OFDM	BPSK	6.0
Draft 802.11n (20MHz)	149 to 165	149, 157, 165	OFDM	BPSK	7.2
Draft 802.11n (40MHz)	151 to 159	151, 159	OFDM	BPSK	15.0



3.3 GENERAL DESCRIPTION OF APPLIED STANDARDS

The EUT is a RF Product. According to the specifications of the manufacturer, it must comply with the requirements of the following standards:

FCC Part 15, Subpart C (15.247)

ANSI C63.4-2003

All test items have been performed and recorded as per the above standards.

NOTE: The EUT is also considered as a kind of computer peripheral, because the connection to computer is necessary for typical use. It has been verified to comply with the requirements of FCC Part 15, Subpart B, Class B (DoC). The test report has been issued separately.

3.4 DESCRIPTION OF SUPPORT UNITS

The EUT has been tested as an independent unit together with other necessary accessories or support units. The following support units or accessories were used to form a representative test configuration during the tests.

NO.	PRODUCT	BRAND	MODEL NO.	SERIAL NO.	FCC ID
1	NOTEBOOK	DELL	PP05L	16484462992	E2K24CLNS

NO.	SIGNAL CABLE DESCRIPTION OF THE ABOVE SUPPORT UNITS
1	10m UTP RJ 45 cable

NOTE 1: All power cords of the above support units are non shielded (1.8m).

NOTE 2: Item 1 acted as communication partners to transfer data.

4. TEST TYPES AND RESULTS (FOR 2.4GHz BAND)

4.1 RADIATED EMISSION MEASUREMENT

4.1.1 LIMITS OF RADIATED EMISSION MEASUREMENT

Emissions radiated outside of the specified bands, shall be according to the general radiated limits in 15.209 as following:

FREQUENCIES (MHz)	FIELD STRENGTH (microvolts/meter)	MEASUREMENT DISTANCE (meters)
0.009 ~ 0.490	2400/F(kHz)	300
0.490 ~ 1.705	24000/F(kHz)	30
1.705 ~ 30.0	30	30
30 ~ 88	100	3
88 ~ 216	150	3
216 ~ 960	200	3
Above 960	500	3

NOTE:

1. The lower limit shall apply at the transition frequencies.
2. Emission level (dBuV/m) = 20 log Emission level (uV/m).
3. As shown in 15.35(b), for frequencies above 1000MHz, the field strength limits are based on average detector, however, the peak field strength of any emission shall not exceed the maximum permitted average limits, specified above by more than 20dB under any condition of modulation.



4.1.2 TEST INSTRUMENTS

DESCRIPTION & MANUFACTURER	MODEL NO.	SERIAL NO.	DATE OF CALIBRATION	DUE DATE OF CALIBRATION
Test Receiver ROHDE & SCHWARZ	ESIB7	100212	May 28, 2008	May 27, 2009
Spectrum Analyzer ROHDE & SCHWARZ	FSP40	100269	Aug. 08, 2008	Aug. 07, 2009
BILOG Antenna SCHWARZBECK	VULB9168	9168-156	Apr. 25, 2008	Apr. 24, 2009
HORN Antenna SCHWARZBECK	BBHA 9170	BBHA9170242	Jan. 07, 2008	Jan. 06, 2009
Preamplifier Agilent	8449B	3008A01911	Sep. 10, 2008	Sep. 09, 2009
Preamplifier Agilent	8447D	2944A10634	Dec. 13, 2007	Dec. 12, 2008
RF signal cable HUBER+SUHNNER	SUCOFLEX 104	274039/223650	Nov. 08, 2007	Nov. 07, 2008
RF signal cable Worken	8D-FB	Cable-HYCH9-01	Aug. 09, 2008	Aug. 08, 2009
Software	ADT_Radiated_V7.6	NA	NA	NA
Antenna Tower EMCO	2070/2080	512.835.4684	NA	NA
Turn Table EMCO	2087-2.03	NA	NA	NA
Antenna Tower & Turn Table Controller EMCO	2090	NA	NA	NA

- NOTE:**
1. The calibration interval of the above test instruments is 12 months and the calibrations are traceable to NML/ROC and NIST/USA.
 2. The test was performed in HwaYa Chamber 9.
 3. The horn antenna and HP preamplifier (model: 8449B) are used only for the measurement of emission frequency above 1GHz if tested.
 4. The FCC Site Registration No. is 215374.
 5. The IC Site Registration No. is IC3789B-9.

4.1.3 TEST PROCEDURES

- a. The EUT was placed on the top of a rotating table 0.8 meters above the ground at a 3 meters semi-anechoic chamber. The table was rotated 360 degrees to determine the position of the highest radiation.
- b. The EUT was set 3 meters away from the interference-receiving antenna, which was mounted on the top of a variable-height antenna tower.
- c. The antenna is a broadband antenna, and its height is varied from one meter to four meters above the ground to determine the maximum value of the field strength. Both horizontal and vertical polarizations of the antenna are set to make the measurement.
- d. For each suspected emission, the EUT was arranged to its worst case and then the antenna was tuned to heights from 1 meter to 4 meters and the rotatable table was turned from 0 degrees to 360 degrees to find the maximum reading.
- e. The test-receiver system was set to Peak Detect Function and Specified Bandwidth with Maximum Hold Mode.
- f. If the emission level of the EUT in peak mode was lower than the limit specified, then testing could be stopped and the peak values of the EUT would be reported. Otherwise the emissions would be re-tested one by one using peak, quasi-peak or average method as specified and then reported in a data sheet.

NOTE:

1. The resolution bandwidth and video bandwidth of test receiver/spectrum analyzer is 120kHz for Quasi-peak detection at frequency below 1GHz.
2. The resolution bandwidth of test receiver/spectrum analyzer is 1MHz and video bandwidth is 3MHz for Peak detection at frequency above 1GHz.
3. The resolution bandwidth of test receiver/spectrum analyzer is 1MHz and the video bandwidth is 10Hz for Average detection (AV) at frequency above 1GHz.
4. All modes of operation were investigated and the worst-case emissions are reported.

4.1.4 DEVIATION FROM TEST STANDARD

No deviation

4.1.5 TEST SETUP

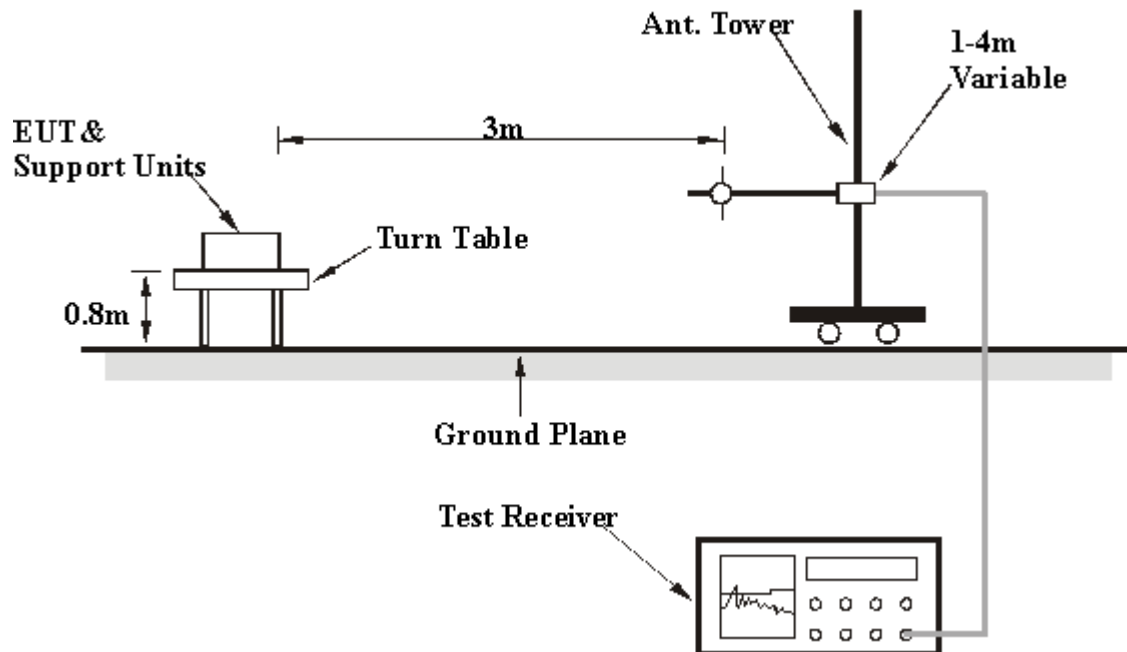

For the actual test configuration, please refer to the attached file (Test Setup Photo).

4.1.6 EUT OPERATING CONDITIONS

- a. Placed the EUT on a testing table.
- b. Prepared notebook computer and placed it outside of testing area to act as communication partner for EUT.
- c. The EUT ran a test program (provided by manufacturer) to enable all functions under transmission condition continuously at specific channel frequency.
- d. The necessary accessories enable the EUT in full functions.

4.1.7 TEST RESULTS

802.11b DSSS MODULATION

EUT TEST CONDITION		MEASUREMENT DETAIL	
CHANNEL	Channel 1	FREQUENCY RANGE	1 ~ 25GHz
INPUT POWER (SYSTEM)	120Vac, 60 Hz	DETECTOR FUNCTION	Peak (PK) Average (AV)
ENVIRONMENTAL CONDITIONS	25deg. C, 65%RH 999hPa	TESTED BY	Brad Wu

ANTENNA POLARITY & TEST DISTANCE: HORIZONTAL AT 3 M								
NO.	FREQ. (MHz)	EMISSION LEVEL (dBuV/m)	LIMIT (dBuV/m)	MARGIN (dB)	ANTENNA HEIGHT (m)	TABLE ANGLE (Degree)	RAW VALUE (dBuV)	CORRECTION FACTOR (dB/m)
1	2390.00	69.08 PK	74.00	-4.92	1.00 H	50	35.60	33.48
2	2390.00	48.39 AV	54.00	-5.61	1.00 H	50	14.91	33.48
3	*2412.00	103.89 PK			1.00 H	50	70.42	33.47
4	*2412.00	98.59 AV			1.00 H	50	65.12	33.47
5	4824.00	53.49 PK	74.00	-20.51	1.18 H	44	14.15	39.34
6	4824.00	49.01 AV	54.00	-4.99	1.18 H	44	9.67	39.34
ANTENNA POLARITY & TEST DISTANCE: VERTICAL AT 3 M								
NO.	FREQ. (MHz)	EMISSION LEVEL (dBuV/m)	LIMIT (dBuV/m)	MARGIN (dB)	ANTENNA HEIGHT (m)	TABLE ANGLE (Degree)	RAW VALUE (dBuV)	CORRECTION FACTOR (dB/m)
1	2390.00	70.14 PK	74.00	-3.86	1.03 V	2	36.66	33.48
2	2390.00	48.88 AV	54.00	-5.12	1.03 V	2	15.40	33.48
3	*2412.00	104.43 PK			1.57 V	9	70.96	33.47
4	*2412.00	99.63 AV			1.57 V	9	66.16	33.47
5	4824.00	51.15 PK	74.00	-22.85	1.10 V	126	11.81	39.34
6	4824.00	44.81 AV	54.00	-9.19	1.10 V	126	5.47	39.34

- REMARKS:**
1. Emission level (dBuV/m) = Raw Value (dBuV) + Correction Factor (dB/m).
 2. Correction Factor (dB/m) = Antenna Factor (dB/m) + Cable Factor (dB).
 3. The other emission levels were very low against the limit.
 4. Margin value = Emission level – Limit value.
 5. “ * “: Fundamental frequency.



EUT TEST CONDITION		MEASUREMENT DETAIL	
CHANNEL	Channel 6	FREQUENCY RANGE	1 ~ 25GHz
INPUT POWER (SYSTEM)	120Vac, 60 Hz	DETECTOR FUNCTION	Peak (PK) Average (AV)
ENVIRONMENTAL CONDITIONS	25deg. C, 65%RH 999hPa	TESTED BY	Brad Wu

ANTENNA POLARITY & TEST DISTANCE: HORIZONTAL AT 3 M								
NO.	FREQ. (MHz)	EMISSION LEVEL (dBuV/m)	LIMIT (dBuV/m)	MARGIN (dB)	ANTENNA HEIGHT (m)	TABLE ANGLE (Degree)	RAW VALUE (dBuV)	CORRECTION FACTOR (dB/m)
1	*2437.00	102.59 PK			1.00 H	50	69.12	33.47
2	*2437.00	97.57 AV			1.00 H	50	64.10	33.47
3	4874.00	52.17 PK	74.00	-21.83	1.16 H	46	12.71	39.45
4	4874.00	46.98 AV	54.00	-7.02	1.16 H	46	7.52	39.45
ANTENNA POLARITY & TEST DISTANCE: VERTICAL AT 3 M								
NO.	FREQ. (MHz)	EMISSION LEVEL (dBuV/m)	LIMIT (dBuV/m)	MARGIN (dB)	ANTENNA HEIGHT (m)	TABLE ANGLE (Degree)	RAW VALUE (dBuV)	CORRECTION FACTOR (dB/m)
1	*2437.00	103.61 PK			1.57 V	11	70.14	33.47
2	*2437.00	99.07 AV			1.57 V	11	65.60	33.47
3	4874.00	49.74 PK	74.00	-24.26	1.00 V	11	10.28	39.45
4	4874.00	43.64 AV	54.00	-10.36	1.00 V	11	4.18	39.45

- REMARKS:**
1. Emission level (dBuV/m) = Raw Value (dBuV) + Correction Factor (dB/m).
 2. Correction Factor (dB/m) = Antenna Factor (dB/m) + Cable Factor (dB).
 3. The other emission levels were very low against the limit.
 4. Margin value = Emission level – Limit value.
 5. “ * “: Fundamental frequency.



EUT TEST CONDITION		MEASUREMENT DETAIL	
CHANNEL	Channel 11	FREQUENCY RANGE	1 ~ 25GHz
INPUT POWER (SYSTEM)	120Vac, 60 Hz	DETECTOR FUNCTION	Peak (PK) Average (AV)
ENVIRONMENTAL CONDITIONS	25deg. C, 65%RH 999hPa	TESTED BY	Brad Wu

ANTENNA POLARITY & TEST DISTANCE: HORIZONTAL AT 3 M								
NO.	FREQ. (MHz)	EMISSION LEVEL (dBuV/m)	LIMIT (dBuV/m)	MARGIN (dB)	ANTENNA HEIGHT (m)	TABLE ANGLE (Degree)	RAW VALUE (dBuV)	CORRECTION FACTOR (dB/m)
1	*2462.00	102.11 PK			1.23 H	53	68.64	33.47
2	*2462.00	97.40 AV			1.23 H	53	63.93	33.47
3	2483.50	67.87 PK	74.00	-6.13	1.23 H	53	34.40	33.47
4	2483.50	47.03 AV	54.00	-6.97	1.23 H	53	13.56	33.47
5	4924.00	52.34 PK	74.00	-21.66	1.26 H	44	12.74	39.60
6	4924.00	46.52 AV	54.00	-7.48	1.26 H	44	6.92	39.60
ANTENNA POLARITY & TEST DISTANCE: VERTICAL AT 3 M								
NO.	FREQ. (MHz)	EMISSION LEVEL (dBuV/m)	LIMIT (dBuV/m)	MARGIN (dB)	ANTENNA HEIGHT (m)	TABLE ANGLE (Degree)	RAW VALUE (dBuV)	CORRECTION FACTOR (dB/m)
1	*2462.00	103.62 PK			1.57 V	9	70.15	33.47
2	*2462.00	98.93 AV			1.57 V	9	65.46	33.47
3	2483.50	68.05 PK	74.00	-5.95	1.57 V	9	34.58	33.47
4	2483.50	48.40 AV	54.00	-5.60	1.57 V	9	14.93	33.47
5	4924.00	50.33 PK	74.00	-23.67	1.00 V	4	10.73	39.60
6	4924.00	44.38 AV	54.00	-9.62	1.00 V	4	4.78	39.60

- REMARKS:**
1. Emission level (dBuV/m) = Raw Value (dBuV) + Correction Factor (dB/m).
 2. Correction Factor (dB/m) = Antenna Factor (dB/m) + Cable Factor (dB).
 3. The other emission levels were very low against the limit.
 4. Margin value = Emission level – Limit value.
 5. “ * “: Fundamental frequency.

802.11g OFDM MODULATION

EUT TEST CONDITION		MEASUREMENT DETAIL	
CHANNEL	Channel 1	FREQUENCY RANGE	1 ~ 25GHz
INPUT POWER (SYSTEM)	120Vac, 60 Hz	DETECTOR FUNCTION	Peak (PK) Average (AV)
ENVIRONMENTAL CONDITIONS	25deg. C, 65%RH 999hPa	TESTED BY	Kevin Liang

ANTENNA POLARITY & TEST DISTANCE: HORIZONTAL AT 3 M								
NO.	FREQ. (MHz)	EMISSION LEVEL (dBuV/m)	LIMIT (dBuV/m)	MARGIN (dB)	ANTENNA HEIGHT (m)	TABLE ANGLE (Degree)	RAW VALUE (dBuV)	CORRECTION FACTOR (dB/m)
1	2390.00	58.77 PK	74.00	-15.23	1.52 H	157	25.29	33.48
2	2390.00	47.86 AV	54.00	-6.14	1.52 H	157	14.38	33.48
3	*2412.00	101.25 PK			1.52 H	157	67.78	33.47
4	*2412.00	90.80 AV			1.52 H	157	57.33	33.47
5	4824.00	47.12 PK	74.00	-26.88	1.15 H	231	7.78	39.34
6	4824.00	34.74 AV	54.00	-19.26	1.15 H	231	-4.60	39.34
ANTENNA POLARITY & TEST DISTANCE: VERTICAL AT 3 M								
NO.	FREQ. (MHz)	EMISSION LEVEL (dBuV/m)	LIMIT (dBuV/m)	MARGIN (dB)	ANTENNA HEIGHT (m)	TABLE ANGLE (Degree)	RAW VALUE (dBuV)	CORRECTION FACTOR (dB/m)
1	2390.00	61.65 PK	74.00	-12.35	1.10 V	14	28.17	33.48
2	2390.00	49.40 AV	54.00	-4.60	1.10 V	14	15.92	33.48
3	*2412.00	105.46 PK			1.10 V	14	71.99	33.47
4	*2412.00	95.55 AV			1.10 V	14	62.08	33.47
5	4824.00	49.31 PK	74.00	-24.69	1.02 V	185	9.97	39.34
6	4824.00	35.93 AV	54.00	-18.07	1.02 V	185	-3.41	39.34

- REMARKS:**
1. Emission level (dBuV/m) = Raw Value (dBuV) + Correction Factor (dB/m).
 2. Correction Factor (dB/m) = Antenna Factor (dB/m) + Cable Factor (dB).
 3. The other emission levels were very low against the limit.
 4. Margin value = Emission level – Limit value.
 5. “ * ”: Fundamental frequency.

EUT TEST CONDITION		MEASUREMENT DETAIL	
CHANNEL	Channel 6	FREQUENCY RANGE	1 ~ 25GHz
INPUT POWER (SYSTEM)	120Vac, 60 Hz	DETECTOR FUNCTION	Peak (PK) Average (AV)
ENVIRONMENTAL CONDITIONS	25deg. C, 65%RH 999hPa	TESTED BY	Kevin Liang

ANTENNA POLARITY & TEST DISTANCE: HORIZONTAL AT 3 M								
NO.	FREQ. (MHz)	EMISSION LEVEL (dBuV/m)	LIMIT (dBuV/m)	MARGIN (dB)	ANTENNA HEIGHT (m)	TABLE ANGLE (Degree)	RAW VALUE (dBuV)	CORRECTION FACTOR (dB/m)
1	*2437.00	101.57 PK			1.52 H	150	68.10	33.47
2	*2437.00	91.07 AV			1.52 H	150	57.60	33.47
3	4874.00	47.87 PK	74.00	-26.13	1.00 H	225	8.41	39.45
4	4874.00	34.56 AV	54.00	-19.44	1.00 H	225	-4.90	39.45
ANTENNA POLARITY & TEST DISTANCE: VERTICAL AT 3 M								
NO.	FREQ. (MHz)	EMISSION LEVEL (dBuV/m)	LIMIT (dBuV/m)	MARGIN (dB)	ANTENNA HEIGHT (m)	TABLE ANGLE (Degree)	RAW VALUE (dBuV)	CORRECTION FACTOR (dB/m)
1	*2437.00	105.78 PK			1.13 V	14	72.31	33.47
2	*2437.00	95.73 AV			1.13 V	14	62.26	33.47
3	4874.00	47.57 PK	74.00	-26.43	1.07 V	107	8.11	39.45
4	4874.00	35.18 AV	54.00	-18.82	1.07 V	107	-4.28	39.45

- REMARKS:**
1. Emission level (dBuV/m) = Raw Value (dBuV) + Correction Factor (dB/m).
 2. Correction Factor (dB/m) = Antenna Factor (dB/m) + Cable Factor (dB).
 3. The other emission levels were very low against the limit.
 4. Margin value = Emission level – Limit value.
 5. “ * “: Fundamental frequency.

EUT TEST CONDITION		MEASUREMENT DETAIL	
CHANNEL	Channel 11	FREQUENCY RANGE	1 ~ 25GHz
INPUT POWER (SYSTEM)	120Vac, 60 Hz	DETECTOR FUNCTION	Peak (PK) Average (AV)
ENVIRONMENTAL CONDITIONS	25deg. C, 65%RH 999hPa	TESTED BY	Kevin Liang

ANTENNA POLARITY & TEST DISTANCE: HORIZONTAL AT 3 M								
NO.	FREQ. (MHz)	EMISSION LEVEL (dBuV/m)	LIMIT (dBuV/m)	MARGIN (dB)	ANTENNA HEIGHT (m)	TABLE ANGLE (Degree)	RAW VALUE (dBuV)	CORRECTION FACTOR (dB/m)
1	*2462.00	101.60 PK			1.42 H	152	68.13	33.47
2	*2462.00	91.48 AV			1.42 H	152	58.01	33.47
3	2483.50	59.35 PK	74.00	-14.65	1.42 H	152	25.88	33.47
4	2483.50	47.94 AV	54.00	-6.06	1.42 H	152	14.47	33.47
5	4924.00	47.25 PK	74.00	-26.75	1.14 H	233	7.65	39.60
6	4924.00	34.83 AV	54.00	-19.17	1.14 H	233	-4.77	39.60
ANTENNA POLARITY & TEST DISTANCE: VERTICAL AT 3 M								
NO.	FREQ. (MHz)	EMISSION LEVEL (dBuV/m)	LIMIT (dBuV/m)	MARGIN (dB)	ANTENNA HEIGHT (m)	TABLE ANGLE (Degree)	RAW VALUE (dBuV)	CORRECTION FACTOR (dB/m)
1	*2462.00	105.67 PK			1.36 V	19	72.20	33.47
2	*2462.00	95.80 AV			1.36 V	19	62.33	33.47
3	2483.50	63.14 PK	74.00	-10.86	1.36 V	19	29.67	33.47
4	2483.50	48.74 AV	54.00	-5.26	1.36 V	19	15.27	33.47
5	4924.00	50.42 PK	74.00	-23.58	1.01 V	188	10.82	39.60
6	4924.00	36.16 AV	54.00	-17.84	1.01 V	188	-3.44	39.60

- REMARKS:**
1. Emission level (dBuV/m) = Raw Value (dBuV) + Correction Factor (dB/m).
 2. Correction Factor (dB/m) = Antenna Factor (dB/m) + Cable Factor (dB).
 3. The other emission levels were very low against the limit.
 4. Margin value = Emission level – Limit value.
 5. “ * “: Fundamental frequency.

DRAFT 802.11n (20MHz) OFDM MODULATION

EUT TEST CONDITION		MEASUREMENT DETAIL	
CHANNEL	Channel 1	FREQUENCY RANGE	1 ~ 25GHz
INPUT POWER (SYSTEM)	120Vac, 60 Hz	DETECTOR FUNCTION	Peak (PK) Average (AV)
ENVIRONMENTAL CONDITIONS	25deg. C, 65%RH 999hPa	TESTED BY	Kevin Liang

ANTENNA POLARITY & TEST DISTANCE: HORIZONTAL AT 3 M								
NO.	FREQ. (MHz)	EMISSION LEVEL (dBuV/m)	LIMIT (dBuV/m)	MARGIN (dB)	ANTENNA HEIGHT (m)	TABLE ANGLE (Degree)	RAW VALUE (dBuV)	CORRECTION FACTOR (dB/m)
1	2390.00	60.32 PK	74.00	-13.68	1.18 H	12	26.84	33.48
2	2390.00	48.00 AV	54.00	-6.00	1.18 H	12	14.52	33.48
3	*2412.00	100.24 PK			1.18 H	122	66.77	33.47
4	*2412.00	90.30 AV			1.18 H	122	56.83	33.47
5	4824.00	46.28 PK	74.00	-27.72	1.30 H	148	6.94	39.34
6	4824.00	33.60 AV	54.00	-20.40	1.30 H	148	-5.74	39.34
ANTENNA POLARITY & TEST DISTANCE: VERTICAL AT 3 M								
NO.	FREQ. (MHz)	EMISSION LEVEL (dBuV/m)	LIMIT (dBuV/m)	MARGIN (dB)	ANTENNA HEIGHT (m)	TABLE ANGLE (Degree)	RAW VALUE (dBuV)	CORRECTION FACTOR (dB/m)
1	2390.00	61.40 PK	74.00	-12.60	1.12 V	11	27.92	33.48
2	2390.00	48.93 AV	54.00	-5.07	1.12 V	11	15.45	33.48
3	*2412.00	102.07 PK			1.12 V	11	68.60	33.47
4	*2412.00	92.73 AV			1.12 V	11	59.26	33.47
5	4824.00	48.72 PK	74.00	-25.28	1.01 V	139	9.38	39.34
6	4824.00	35.31 AV	54.00	-18.69	1.01 V	139	-4.03	39.34

- REMARKS:**
1. Emission level (dBuV/m) = Raw Value (dBuV) + Correction Factor (dB/m).
 2. Correction Factor (dB/m) = Antenna Factor (dB/m) + Cable Factor (dB).
 3. The other emission levels were very low against the limit.
 4. Margin value = Emission level – Limit value.
 5. “ * “: Fundamental frequency.

EUT TEST CONDITION		MEASUREMENT DETAIL	
CHANNEL	Channel 6	FREQUENCY RANGE	1 ~ 25GHz
INPUT POWER (SYSTEM)	120Vac, 60 Hz	DETECTOR FUNCTION	Peak (PK) Average (AV)
ENVIRONMENTAL CONDITIONS	25deg. C, 65%RH 999hPa	TESTED BY	Kevin Liang

ANTENNA POLARITY & TEST DISTANCE: HORIZONTAL AT 3 M								
NO.	FREQ. (MHz)	EMISSION LEVEL (dBuV/m)	LIMIT (dBuV/m)	MARGIN (dB)	ANTENNA HEIGHT (m)	TABLE ANGLE (Degree)	RAW VALUE (dBuV)	CORRECTION FACTOR (dB/m)
1	*2437.00	100.30 PK			1.18 H	123	66.83	33.47
2	*2437.00	90.58 AV			1.18 H	123	57.11	33.47
3	4874.00	46.33 PK	74.00	-27.67	1.29 H	151	6.87	39.45
4	4874.00	33.66 AV	54.00	-20.34	1.29 H	151	-5.80	39.45
ANTENNA POLARITY & TEST DISTANCE: VERTICAL AT 3 M								
NO.	FREQ. (MHz)	EMISSION LEVEL (dBuV/m)	LIMIT (dBuV/m)	MARGIN (dB)	ANTENNA HEIGHT (m)	TABLE ANGLE (Degree)	RAW VALUE (dBuV)	CORRECTION FACTOR (dB/m)
1	*2437.00	102.34 PK			1.13 V	20	68.87	33.47
2	*2437.00	93.02 AV			1.13 V	20	59.55	33.47
3	4874.00	48.76 PK	74.00	-25.24	1.01 V	133	9.31	39.45
4	4874.00	35.38 AV	54.00	-18.62	1.01 V	133	-4.07	39.45

- REMARKS:**
1. Emission level (dBuV/m) = Raw Value (dBuV) + Correction Factor (dB/m).
 2. Correction Factor (dB/m) = Antenna Factor (dB/m) + Cable Factor (dB).
 3. The other emission levels were very low against the limit.
 4. Margin value = Emission level – Limit value.
 5. “ * “: Fundamental frequency.

EUT TEST CONDITION		MEASUREMENT DETAIL	
CHANNEL	Channel 11	FREQUENCY RANGE	1 ~ 25GHz
INPUT POWER (SYSTEM)	120Vac, 60 Hz	DETECTOR FUNCTION	Peak (PK) Average (AV)
ENVIRONMENTAL CONDITIONS	25deg. C, 65%RH 999hPa	TESTED BY	Kevin Liang

ANTENNA POLARITY & TEST DISTANCE: HORIZONTAL AT 3 M								
NO.	FREQ. (MHz)	EMISSION LEVEL (dBuV/m)	LIMIT (dBuV/m)	MARGIN (dB)	ANTENNA HEIGHT (m)	TABLE ANGLE (Degree)	RAW VALUE (dBuV)	CORRECTION FACTOR (dB/m)
1	*2462.00	100.40 PK			1.17 H	122	66.93	33.47
2	*2462.00	90.76 AV			1.17 H	122	57.29	33.47
3	2483.50	62.10 PK	74.00	-11.90	1.17 H	122	28.63	33.47
4	2483.50	48.03 AV	54.00	-5.97	1.17 H	122	14.56	33.47
5	4924.00	46.33 PK	74.00	-27.67	1.35 H	142	6.73	39.60
6	4924.00	33.65 AV	54.00	-20.35	1.35 H	142	-5.95	39.60
ANTENNA POLARITY & TEST DISTANCE: VERTICAL AT 3 M								
NO.	FREQ. (MHz)	EMISSION LEVEL (dBuV/m)	LIMIT (dBuV/m)	MARGIN (dB)	ANTENNA HEIGHT (m)	TABLE ANGLE (Degree)	RAW VALUE (dBuV)	CORRECTION FACTOR (dB/m)
1	*2462.00	102.56 PK			1.10 V	12	69.09	33.47
2	*2462.00	93.03 AV			1.10 V	12	59.56	33.47
3	2483.50	61.58 PK	74.00	-12.42	1.10 V	12	28.11	33.47
4	2483.50	48.60 AV	54.00	-5.40	1.10 V	12	15.13	33.47
5	4924.00	48.93 PK	74.00	-25.07	1.01 V	147	9.33	39.60
6	4924.00	35.40 AV	54.00	-18.60	1.01 V	147	-4.20	39.60

- REMARKS:**
1. Emission level (dBuV/m) = Raw Value (dBuV) + Correction Factor (dB/m).
 2. Correction Factor (dB/m) = Antenna Factor (dB/m) + Cable Factor (dB).
 3. The other emission levels were very low against the limit.
 4. Margin value = Emission level – Limit value.
 5. “ * “: Fundamental frequency.

DRAFT 802.11n (40MHz) OFDM MODULATION

EUT TEST CONDITION		MEASUREMENT DETAIL	
CHANNEL	Channel 1	FREQUENCY RANGE	1 ~ 25GHz
INPUT POWER (SYSTEM)	120Vac, 60 Hz	DETECTOR FUNCTION	Peak (PK) Average (AV)
ENVIRONMENTAL CONDITIONS	25deg. C, 65%RH 999hPa	TESTED BY	Kevin Liang

ANTENNA POLARITY & TEST DISTANCE: HORIZONTAL AT 3 M								
NO.	FREQ. (MHz)	EMISSION LEVEL (dBuV/m)	LIMIT (dBuV/m)	MARGIN (dB)	ANTENNA HEIGHT (m)	TABLE ANGLE (Degree)	RAW VALUE (dBuV)	CORRECTION FACTOR (dB/m)
1	2390.00	59.71 PK	74.00	-14.29	1.18 H	271	26.23	33.48
2	2390.00	47.99 AV	54.00	-6.01	1.18 H	271	14.51	33.48
3	*2422.00	96.44 PK			1.18 H	271	62.97	33.47
4	*2422.00	86.94 AV			1.18 H	271	53.47	33.47
5	4844.00	46.81 PK	74.00	-27.19	1.11 H	274	7.43	39.38
6	4844.00	33.90 AV	54.00	-20.10	1.11 H	274	-5.48	39.38
ANTENNA POLARITY & TEST DISTANCE: VERTICAL AT 3 M								
NO.	FREQ. (MHz)	EMISSION LEVEL (dBuV/m)	LIMIT (dBuV/m)	MARGIN (dB)	ANTENNA HEIGHT (m)	TABLE ANGLE (Degree)	RAW VALUE (dBuV)	CORRECTION FACTOR (dB/m)
1	2390.00	61.47 PK	74.00	-12.53	1.12 V	12	27.99	33.48
2	2390.00	49.97 AV	54.00	-4.03	1.12 V	12	16.49	33.48
3	*2422.00	100.15 PK			1.12 V	12	66.68	33.47
4	*2422.00	90.13 AV			1.12 V	12	56.66	33.47
5	4844.00	48.98 PK	74.00	-25.02	1.00 V	139	9.60	39.38
6	4844.00	35.49 AV	54.00	-18.51	1.00 V	139	-3.89	39.38

- REMARKS:**
1. Emission level (dBuV/m) = Raw Value (dBuV) + Correction Factor (dB/m).
 2. Correction Factor (dB/m) = Antenna Factor (dB/m) + Cable Factor (dB).
 3. The other emission levels were very low against the limit.
 4. Margin value = Emission level – Limit value.
 5. “ * “: Fundamental frequency.

EUT TEST CONDITION		MEASUREMENT DETAIL	
CHANNEL	Channel 4	FREQUENCY RANGE	1 ~ 25GHz
INPUT POWER (SYSTEM)	120Vac, 60 Hz	DETECTOR FUNCTION	Peak (PK) Average (AV)
ENVIRONMENTAL CONDITIONS	25deg. C, 65%RH 999hPa	TESTED BY	Kevin Liang

ANTENNA POLARITY & TEST DISTANCE: HORIZONTAL AT 3 M								
NO.	FREQ. (MHz)	EMISSION LEVEL (dBuV/m)	LIMIT (dBuV/m)	MARGIN (dB)	ANTENNA HEIGHT (m)	TABLE ANGLE (Degree)	RAW VALUE (dBuV)	CORRECTION FACTOR (dB/m)
1	*2437.00	97.53 PK			1.17 H	121	64.06	33.47
2	*2437.00	87.31 AV			1.17 H	121	53.84	33.47
3	4874.00	47.05 PK	74.00	-26.95	1.10 H	263	7.60	39.45
4	4874.00	34.27 AV	54.00	-19.73	1.10 H	263	-5.18	39.45
ANTENNA POLARITY & TEST DISTANCE: VERTICAL AT 3 M								
NO.	FREQ. (MHz)	EMISSION LEVEL (dBuV/m)	LIMIT (dBuV/m)	MARGIN (dB)	ANTENNA HEIGHT (m)	TABLE ANGLE (Degree)	RAW VALUE (dBuV)	CORRECTION FACTOR (dB/m)
1	*2437.00	100.46 PK			1.12 V	9	66.99	33.47
2	*2437.00	90.56 AV			1.12 V	9	57.09	33.47
3	4874.00	50.38 PK	74.00	-23.62	1.01 V	144	10.93	39.45
4	4874.00	35.77 AV	54.00	-18.23	1.01 V	144	-3.68	39.45

- REMARKS:**
1. Emission level (dBuV/m) = Raw Value (dBuV) + Correction Factor (dB/m).
 2. Correction Factor (dB/m) = Antenna Factor (dB/m) + Cable Factor (dB).
 3. The other emission levels were very low against the limit.
 4. Margin value = Emission level – Limit value.
 5. “ * “: Fundamental frequency.

EUT TEST CONDITION		MEASUREMENT DETAIL	
CHANNEL	Channel 7	FREQUENCY RANGE	1 ~ 25GHz
INPUT POWER (SYSTEM)	120Vac, 60 Hz	DETECTOR FUNCTION	Peak (PK) Average (AV)
ENVIRONMENTAL CONDITIONS	25deg. C, 65%RH 999hPa	TESTED BY	Kevin Liang

ANTENNA POLARITY & TEST DISTANCE: HORIZONTAL AT 3 M								
NO.	FREQ. (MHz)	EMISSION LEVEL (dBuV/m)	LIMIT (dBuV/m)	MARGIN (dB)	ANTENNA HEIGHT (m)	TABLE ANGLE (Degree)	RAW VALUE (dBuV)	CORRECTION FACTOR (dB/m)
1	*2452.00	96.22 PK			1.17 H	269	62.75	33.47
2	*2452.00	86.13 AV			1.17 H	269	52.66	33.47
3	2483.50	59.16 PK	74.00	-14.84	1.17 H	269	25.69	33.47
4	2483.50	47.69 AV	54.00	-6.31	1.17 H	269	14.22	33.47
5	4904.00	46.97 PK	74.00	-27.03	1.10 H	279	7.45	39.52
6	4904.00	34.16 AV	54.00	-19.84	1.10 H	279	-5.36	39.52
ANTENNA POLARITY & TEST DISTANCE: VERTICAL AT 3 M								
NO.	FREQ. (MHz)	EMISSION LEVEL (dBuV/m)	LIMIT (dBuV/m)	MARGIN (dB)	ANTENNA HEIGHT (m)	TABLE ANGLE (Degree)	RAW VALUE (dBuV)	CORRECTION FACTOR (dB/m)
1	*2452.00	100.22 PK			1.11 V	34	66.75	33.47
2	*2452.00	89.74 AV			1.11 V	34	56.27	33.47
3	2483.50	61.13 PK	74.00	-12.87	1.11 V	34	27.66	33.47
4	2483.50	48.63 AV	54.00	-5.37	1.11 V	34	15.16	33.47
5	4904.00	49.21 PK	74.00	-24.79	1.01 V	145	9.69	39.52
6	4904.00	35.64 AV	54.00	-18.36	1.01 V	145	-3.88	39.52

- REMARKS:**
1. Emission level (dBuV/m) = Raw Value (dBuV) + Correction Factor (dB/m).
 2. Correction Factor (dB/m) = Antenna Factor (dB/m) + Cable Factor (dB).
 3. The other emission levels were very low against the limit.
 4. Margin value = Emission level – Limit value.
 5. “ * “: Fundamental frequency.

BELOW 1GHz WORST-CASE DATA : 802.11g OFDM MODULATION

EUT TEST CONDITION		MEASUREMENT DETAIL	
CHANNEL	Channel 6	FREQUENCY RANGE	Below 1000MHz
INPUT POWER (SYSTEM)	120Vac, 60 Hz	DETECTOR FUNCTION	Quasi-Peak
ENVIRONMENTAL CONDITIONS	23deg. C, 68%RH 999hPa	TESTED BY	Antony Lee

ANTENNA POLARITY & TEST DISTANCE: HORIZONTAL AT 3 M								
NO.	FREQ. (MHz)	EMISSION LEVEL (dBuV/m)	LIMIT (dBuV/m)	MARGIN (dB)	ANTENNA HEIGHT (m)	TABLE ANGLE (Degree)	RAW VALUE (dBuV)	CORRECTION FACTOR (dB/m)
1	222.38	30.89 QP	46.00	-15.11	1.00 H	10	19.35	11.54
2	249.60	44.01 QP	46.00	-1.99	1.00 H	10	31.25	12.76
3	374.04	25.08 QP	46.00	-20.92	1.00 H	10	9.71	15.37
4	624.85	28.11 QP	46.00	-17.89	1.00 H	10	6.36	21.75
5	751.23	30.55 QP	46.00	-15.45	1.00 H	10	6.80	23.75
6	875.67	37.23 QP	46.00	-8.77	1.00 H	10	11.61	25.62
ANTENNA POLARITY & TEST DISTANCE: VERTICAL AT 3 M								
NO.	FREQ. (MHz)	EMISSION LEVEL (dBuV/m)	LIMIT (dBuV/m)	MARGIN (dB)	ANTENNA HEIGHT (m)	TABLE ANGLE (Degree)	RAW VALUE (dBuV)	CORRECTION FACTOR (dB/m)
1	49.34	34.44 QP	40.00	-5.56	1.50 V	70	20.84	13.59
2	97.95	34.03 QP	43.50	-9.47	1.00 V	283	24.75	9.29
3	164.06	36.54 QP	43.50	-6.96	1.00 V	10	23.16	13.38
4	250.00	42.80 QP	46.00	-3.20	1.00 V	49	30.02	12.78
5	500.42	40.46 QP	46.00	-5.54	1.00 V	211	21.35	19.12
6	624.85	34.95 QP	46.00	-11.05	1.50 V	208	13.20	21.75
7	751.23	38.56 QP	46.00	-7.44	1.00 V	196	14.81	23.75

- REMARKS:**
1. Emission level (dBuV/m) = Raw Value (dBuV) + Correction Factor (dB/m).
 2. Correction Factor (dB/m) = Antenna Factor (dB/m) + Cable Factor (dB).
 3. The other emission levels were very low against the limit.
 4. Margin value = Emission level – Limit value.

4.2 CONDUCTED EMISSION MEASUREMENT

4.2.1 LIMITS OF CONDUCTED EMISSION MEASUREMENT

FREQUENCY OF EMISSION (MHz)	CONDUCTED LIMIT (dB μ V)	
	Quasi-peak	Average
0.15 ~ 0.5	66 to 56	56 to 46
0.5 ~ 5	56	46
5 ~ 30	60	50

- NOTE:** 1. The lower limit shall apply at the transition frequencies.
2. The limit decreases in line with the logarithm of the frequency in the range of 0.15 to 0.50MHz.
3. All emanations from a class A/B digital device or system, including any network of conductors and apparatus connected thereto, shall not exceed the level of field strengths specified above.

4.2.2 TEST INSTRUMENTS

DESCRIPTION & MANUFACTURER	MODEL NO.	SERIAL NO.	DATE OF CALIBRATION	DUE DATE OF CALIBRATION
Test Receiver ROHDE & SCHWARZ	ESCS30	100291	Nov. 22, 2007	Nov. 21, 2008
RF signal cable Woken	5D-FB	Cable-HYC01-01	Jan. 04, 2008	Jan. 03, 2009
LISN ROHDE & SCHWARZ	ESH3-Z5	100312	Jun. 13, 2008	Jun. 12, 2009
V-LISN SCHWARZBECK	NNBL 8226-2	8226-142	Jun. 10, 2008	Jun. 09, 2009
Software ADT	ADT_Cond_V3	NA	NA	NA

- NOTE:** 1. The calibration interval of the above test instruments is 12 months and the calibrations are traceable to NML/ROC and NIST/USA.
2. The test was performed in HwaYa Shielded Room 1.
3. The VCCI Site Registration No. is C-2040.

4.2.3 TEST PROCEDURES

- a. The EUT was placed 0.4 meters from the conducting wall of the shielded room with EUT being connected to the power mains through a line impedance stabilization network (LISN). Other support units were connected to the power mains through another LISN. The two LISNs provide 50 ohm/ 50uH of coupling impedance for the measuring instrument.
- b. Both lines of the power mains connected to the EUT were checked for maximum conducted interference.
- c. The frequency range from 150kHz to 30MHz was searched. Emission levels under (Limit - 20dB) was not recorded.

NOTE: All modes of operation were investigated and the worst-case emissions are reported.

4.2.4 DEVIATION FROM TEST STANDARD

No deviation

4.2.5 TEST SETUP

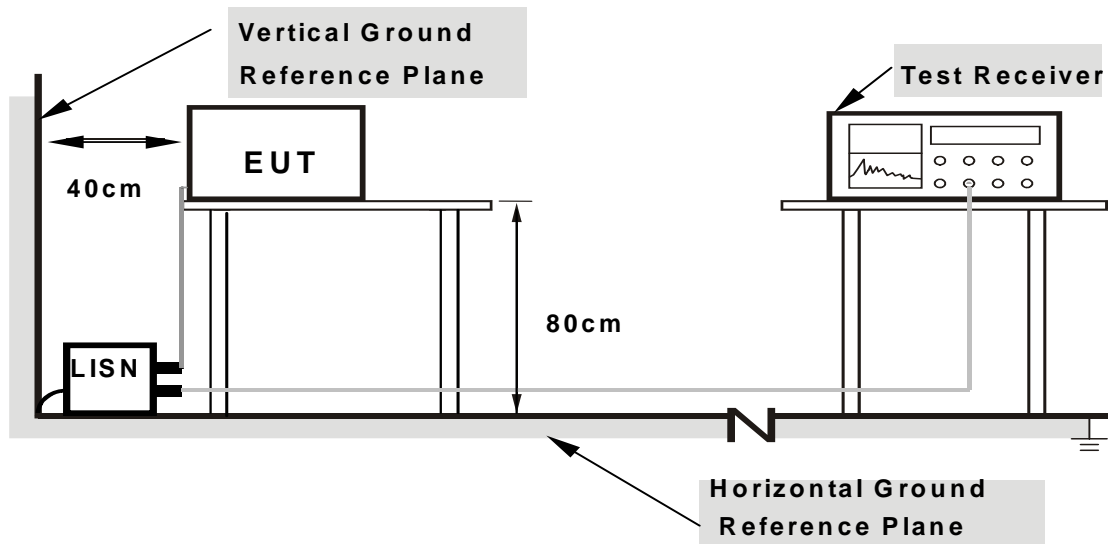

- Note:**
1. Support units were connected to second LISN.
 2. Both of LISNs (AMN) are 80 cm from EUT and at least 80 from other units and other metal planes

For the actual test configuration, please refer to the attached file (Test Setup Photo).

4.2.6 EUT OPERATING CONDITIONS

Same as 4.1.6.

4.2.7 TEST RESULTS

CONDUCTED WORST-CASE DATA : DRAFT 802.11g OFDM MODULATION

EUT TEST CONDITION		MEASUREMENT DETAIL	
CHANNEL	Channel 6	PHASE	Line 1
MODULATION TYPE	BPSK	INPUT POWER (SYSTEM)	120Vac, 60Hz
TRANSFER RATE	6Mbps	6dB BANDWIDTH	9kHz
ENVIRONMENTAL CONDITIONS	25deg. C, 65%RH, 988hPa	TESTED BY	Brad Wu

No	Freq. [MHz]	Corr. Factor (dB)	Reading Value [dB (uV)]		Emission Level [dB (uV)]		Limit [dB (uV)]		Margin (dB)	
			Q.P.	AV.	Q.P.	AV.	Q.P.	AV.	Q.P.	AV.
			1	0.197	0.20	48.64	-	48.84	-	63.74
2	0.259	0.20	44.65	-	44.85	-	61.45	51.45	-16.60	-
3	0.392	0.20	37.20	-	37.40	-	58.02	48.02	-20.62	-
4	0.654	0.20	33.72	-	33.92	-	56.00	46.00	-22.08	-
5	1.113	0.20	23.44	-	23.64	-	56.00	46.00	-32.36	-
6	9.125	0.51	18.97	-	19.48	-	60.00	50.00	-40.52	-

- REMARKS:**
1. Q.P. and AV. are abbreviations of quasi-peak and average individually.
 2. "-": The Quasi-peak reading value also meets average limit and measurement with the average detector is unnecessary.
 3. The emission levels of other frequencies were very low against the limit.
 4. Margin value = Emission level - Limit value
 5. Correction factor = Insertion loss + Cable loss
 6. Emission Level = Correction Factor + Reading Value.

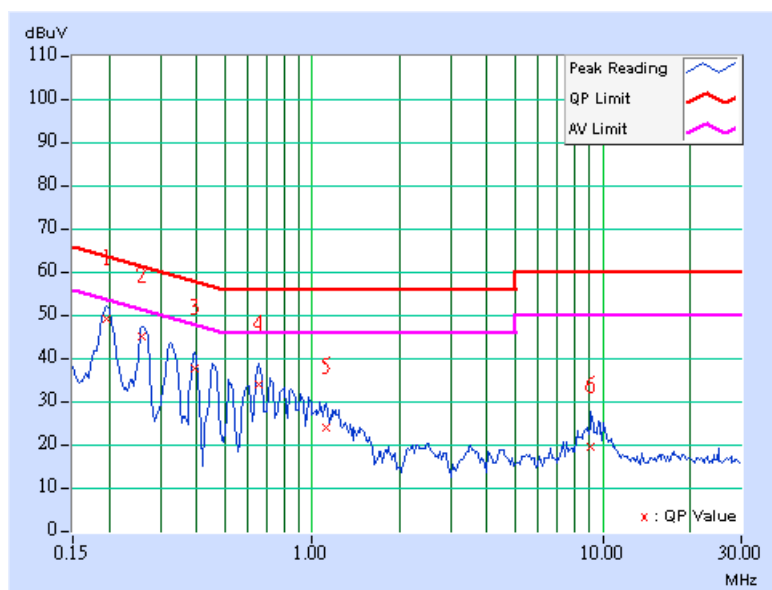

EUT TEST CONDITION		MEASUREMENT DETAIL	
CHANNEL	Channel 6	PHASE	Line 2
MODULATION TYPE	BPSK	INPUT POWER (SYSTEM)	120Vac, 60Hz
TRANSFER RATE	6Mbps	6dB BANDWIDTH	9kHz
ENVIRONMENTAL CONDITIONS	25deg. C, 65%RH, 988hPa	TESTED BY	Brad Wu

No	Freq. [MHz]	Corr. Factor (dB)	Reading Value [dB (uV)]		Emission Level [dB (uV)]		Limit [dB (uV)]		Margin (dB)	
			Q.P.	AV.	Q.P.	AV.	Q.P.	AV.	Q.P.	AV.
1	0.197	0.20	48.40	-	48.60	-	63.74	53.74	-15.14	-
2	0.263	0.20	45.38	-	45.58	-	61.33	51.33	-15.75	-
3	0.330	0.20	41.00	-	41.20	-	59.46	49.46	-18.26	-
4	0.650	0.20	38.93	-	39.13	-	56.00	46.00	-16.87	-
5	2.738	0.27	21.04	-	21.31	-	56.00	46.00	-34.69	-
6	9.129	0.51	19.88	-	20.39	-	60.00	50.00	-39.61	-

- REMARKS:**
1. Q.P. and AV. are abbreviations of quasi-peak and average individually.
 2. "-": The Quasi-peak reading value also meets average limit and measurement with the average detector is unnecessary.
 3. The emission levels of other frequencies were very low against the limit.
 4. Margin value = Emission level - Limit value
 5. Correction factor = Insertion loss + Cable loss
 6. Emission Level = Correction Factor + Reading Value.

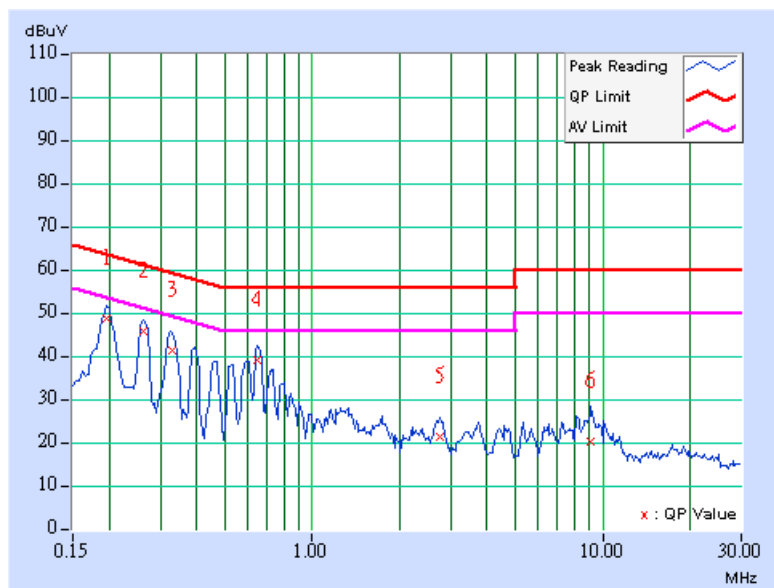



4.3 6dB BANDWIDTH MEASUREMENT

4.3.1 LIMITS OF 6dB BANDWIDTH MEASUREMENT

The minimum of 6dB Bandwidth Measurement is 0.5 MHz.

4.3.2 TEST INSTRUMENTS

DESCRIPTION & MANUFACTURER	MODEL NO.	SERIAL NO.	DATE OF CALIBRATION	CALIBRATED UNTIL
R&S SPECTRUM ANALYZER	FSP40	100041	Apr. 22, 2008	Apr. 21, 2009

NOTE: The calibration interval of the above test instruments is 12 months and the calibrations are traceable to NML/ROC and NIST/USA.

4.3.3 TEST PROCEDURE

The transmitter output was connected to the spectrum analyzer through an attenuator. The bandwidth of the fundamental frequency was measured by spectrum analyzer with 100kHz RBW and 300kHz VBW. The 6dB bandwidth is defined as the total spectrum the power of which is higher than peak power minus 6dB.

4.3.4 DEVIATION FROM TEST STANDARD

No deviation

4.3.5 TEST SETUP

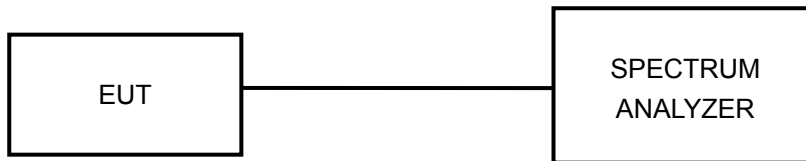

4.3.6 EUT OPERATING CONDITIONS

The software provided by client to enable the EUT under transmission condition continuously at lowest, middle and highest channel frequencies individually.

4.3.7 TEST RESULTS

802.11b DSSS MODULATION

MODULATION TYPE	DBPSK	TRANSFER RATE	1.0Mbps
INPUT POWER (SYSTEM)	120Vac, 60Hz	ENVIRONMENTAL CONDITIONS	25deg.C, 65%RH, 991hPa
TESTED BY	Brad Wu		

CHANNEL	CHANNEL FREQUENCY (MHz)	6dB BANDWIDTH (MHz)	MINIMUM LIMIT (MHz)	PASS / FAIL
1	2412	13.03	0.5	PASS
6	2437	12.62	0.5	PASS
11	2462	12.08	0.5	PASS

CH 1

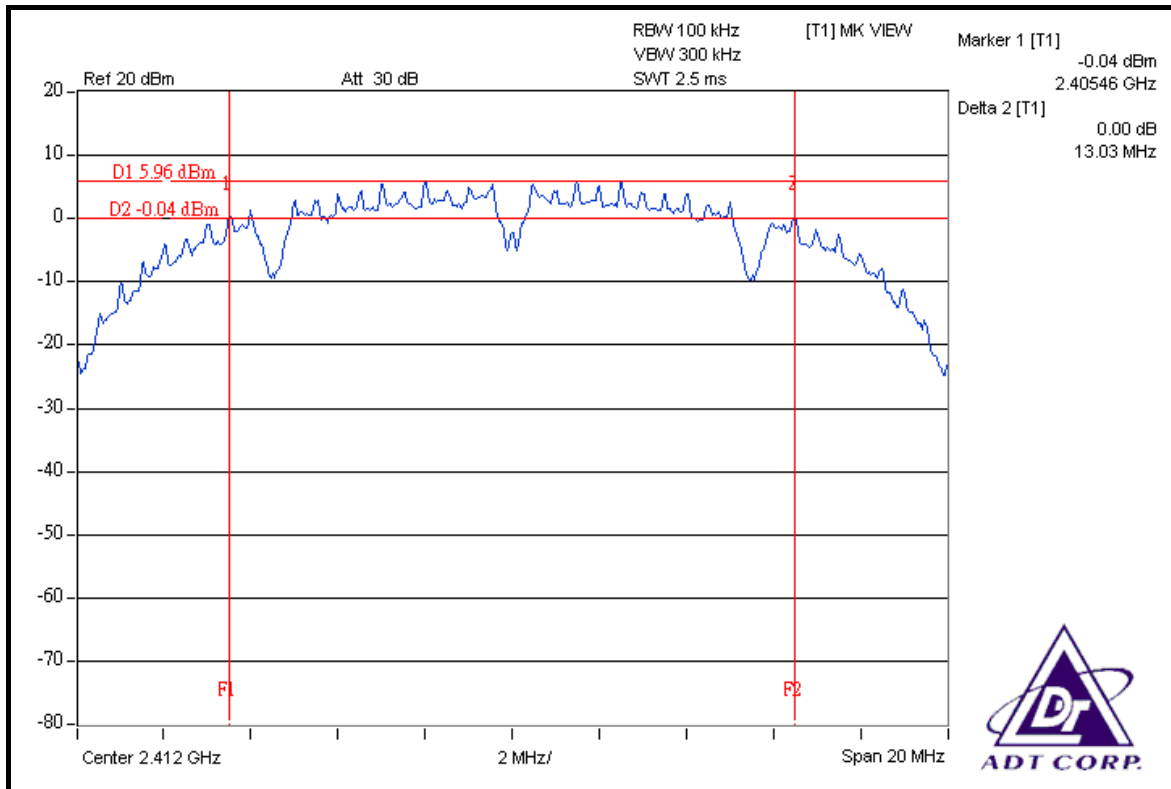

CH 6

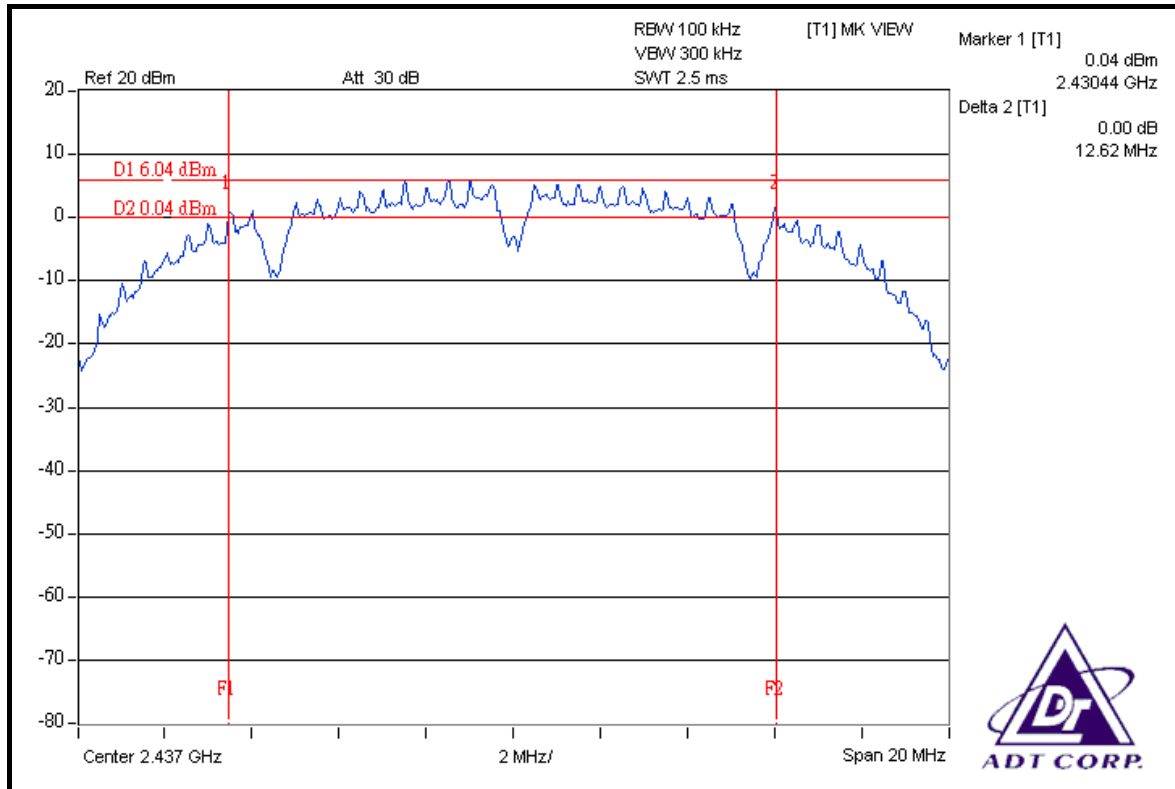

CH 11

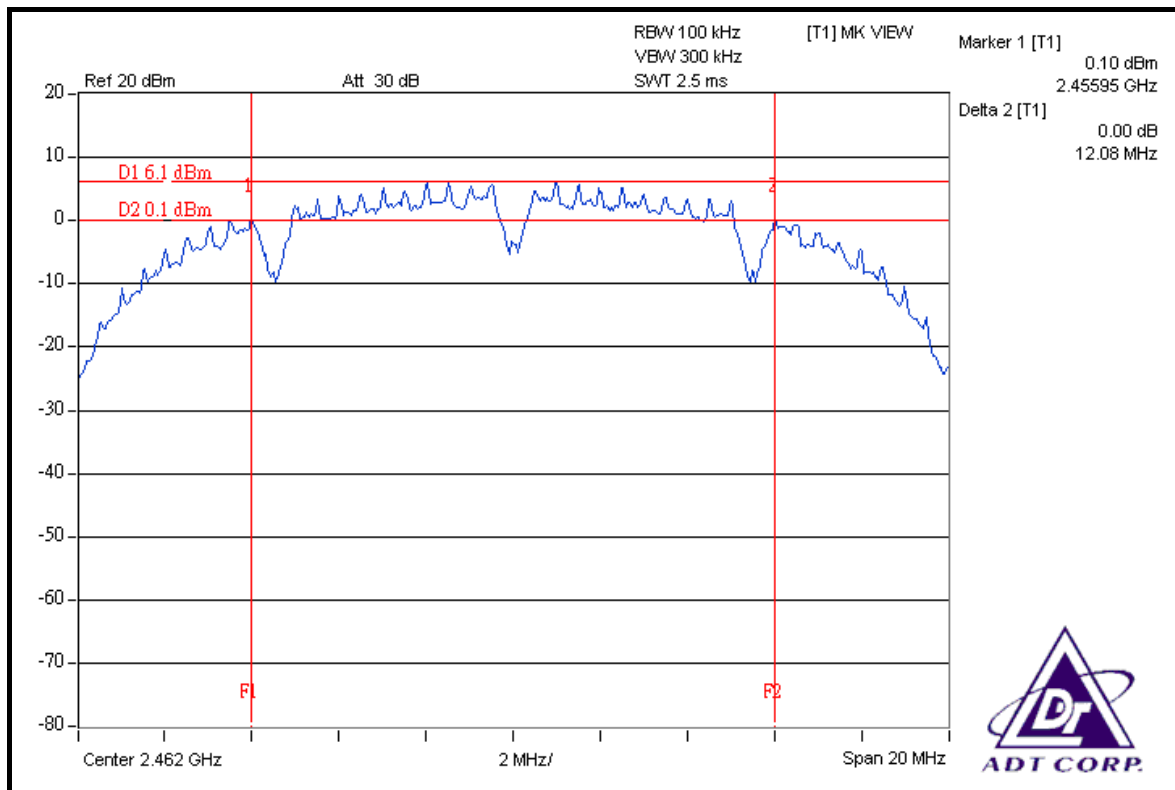



802.11g OFDM MODULATION

MODULATION TYPE	BPSK	TRANSFER RATE	6.0Mbps
INPUT POWER (SYSTEM)	120Vac, 60Hz	ENVIRONMENTAL CONDITIONS	25deg.C, 65%RH, 991hPa
TESTED BY	Brad Wu		

CHANNEL	CHANNEL FREQUENCY (MHz)	6dB BANDWIDTH (MHz)		MINIMUM LIMIT (MHz)	PASS / FAIL
		CHAIN 0	CHAIN 1		
1	2412	16.35	16.36	0.5	PASS
6	2437	16.36	16.38	0.5	PASS
11	2462	16.35	16.37	0.5	PASS

FOR CHAIN 0: CH 1

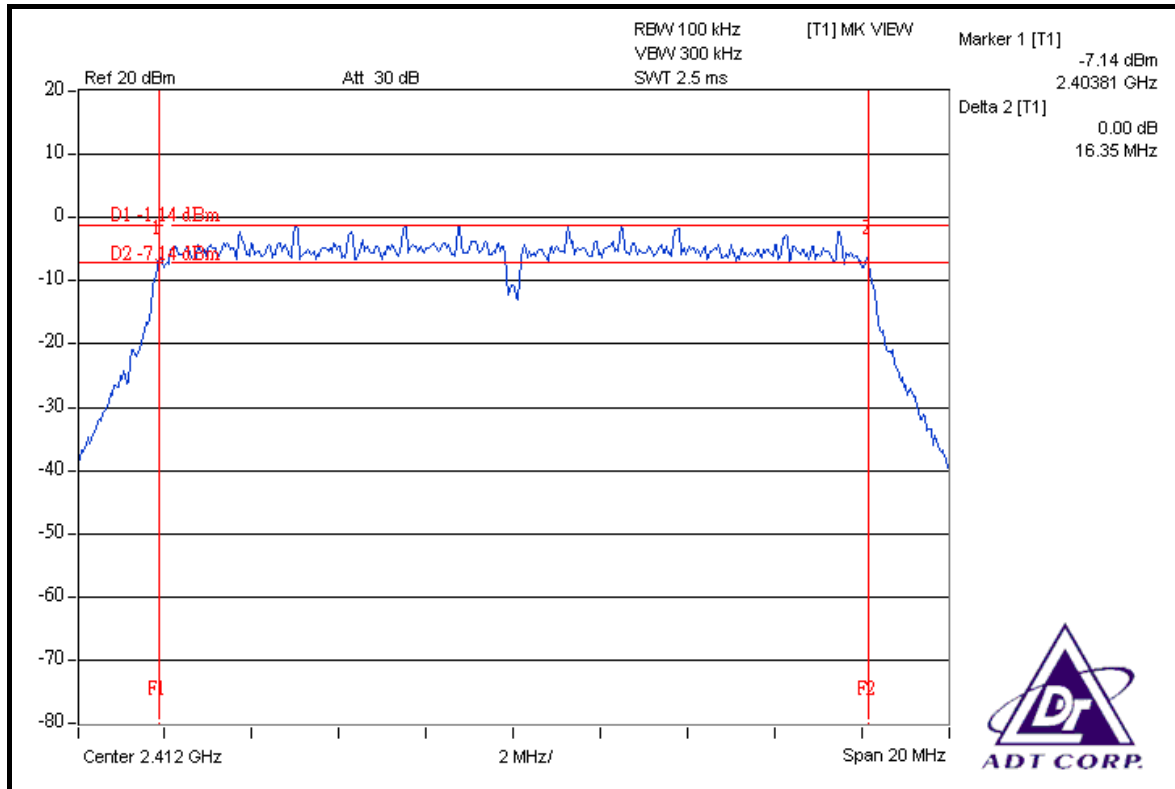

CH 6

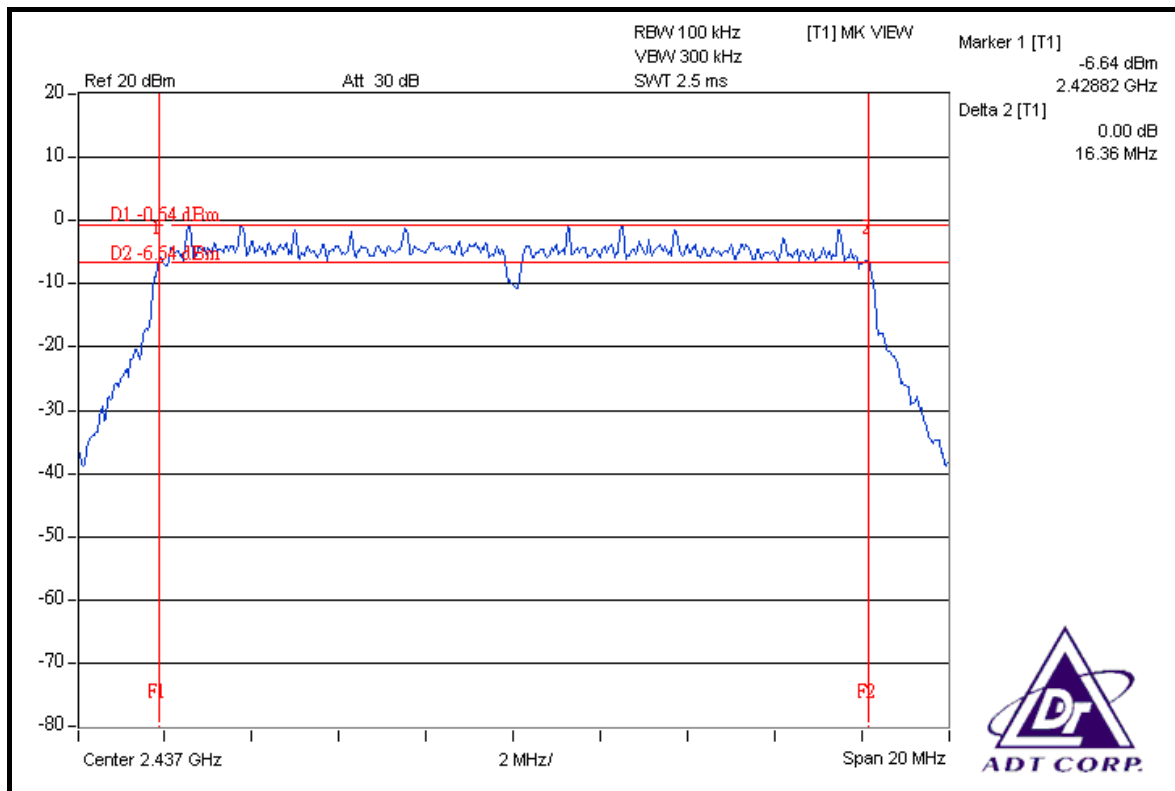

CH 11

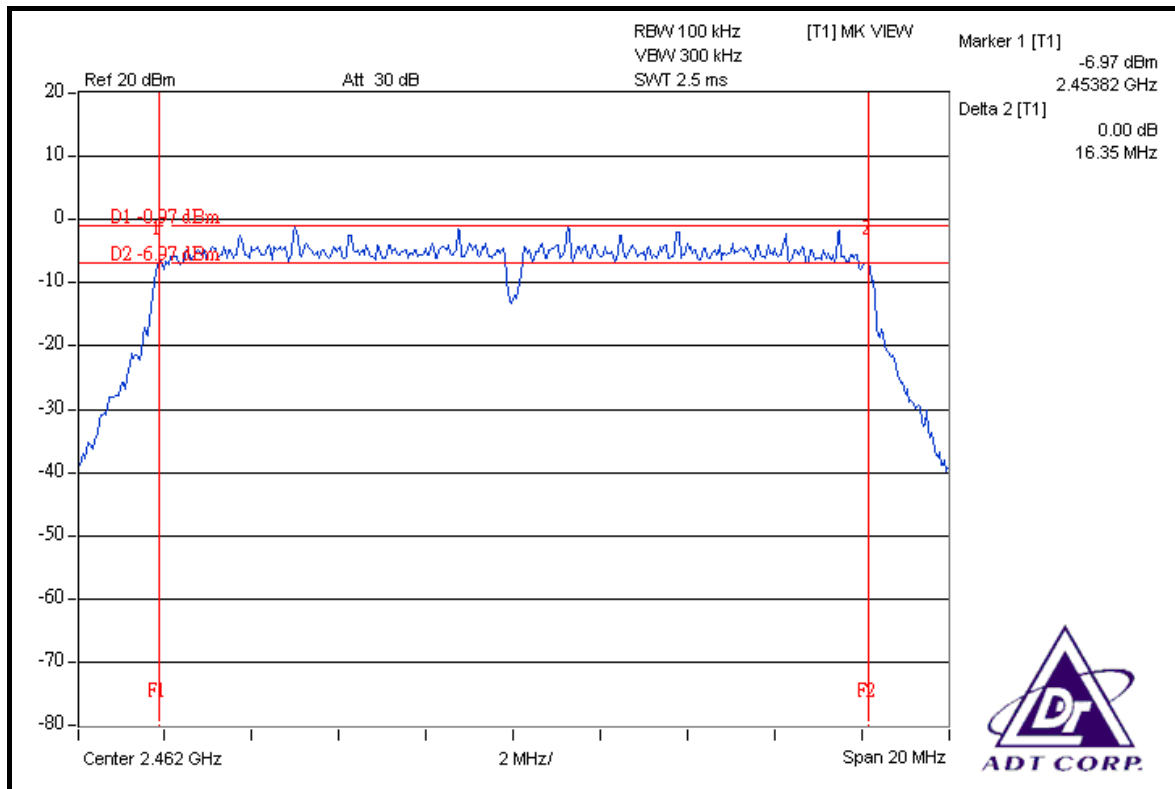

FOR CHAIN 1: CH 1

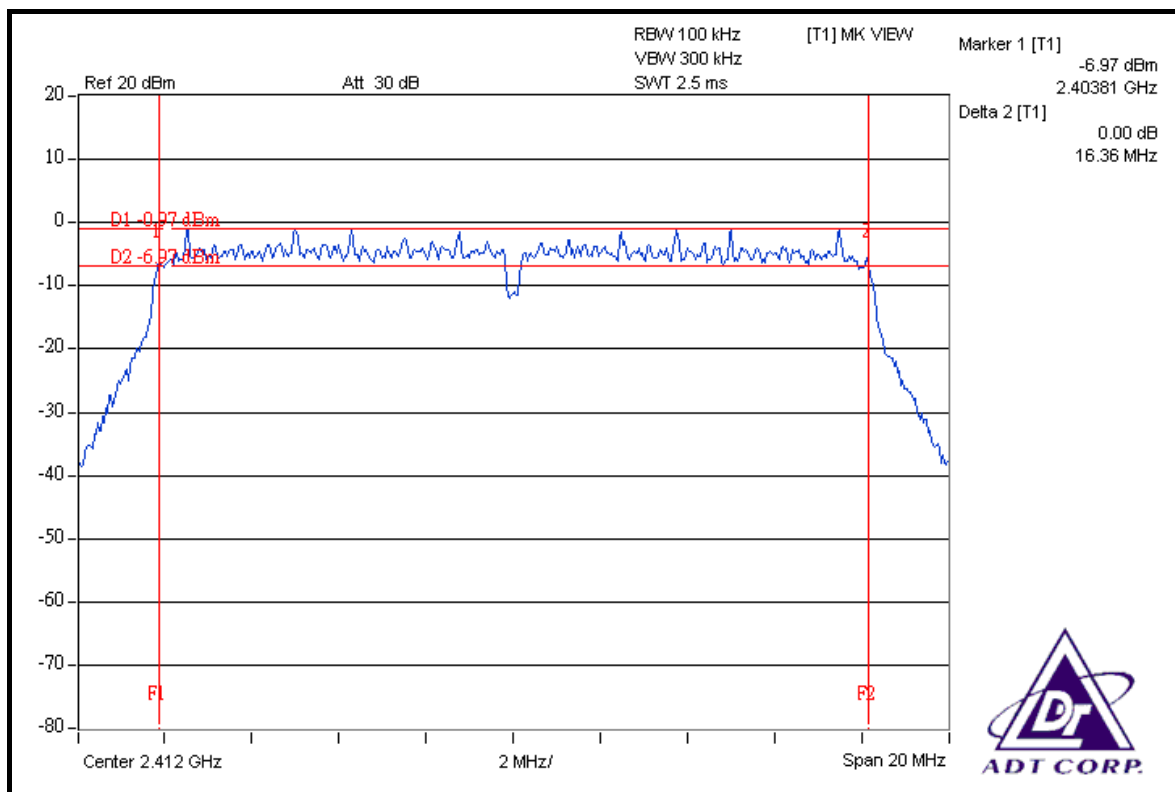

CH 6

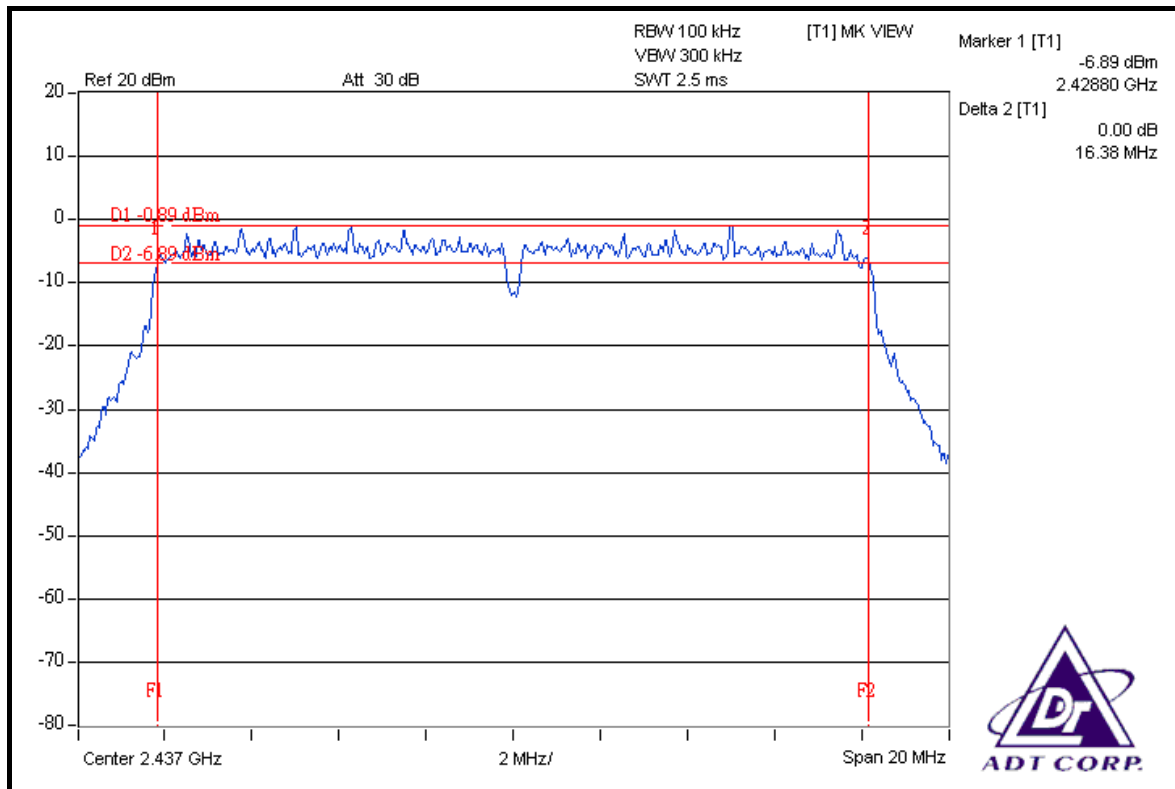

CH 11

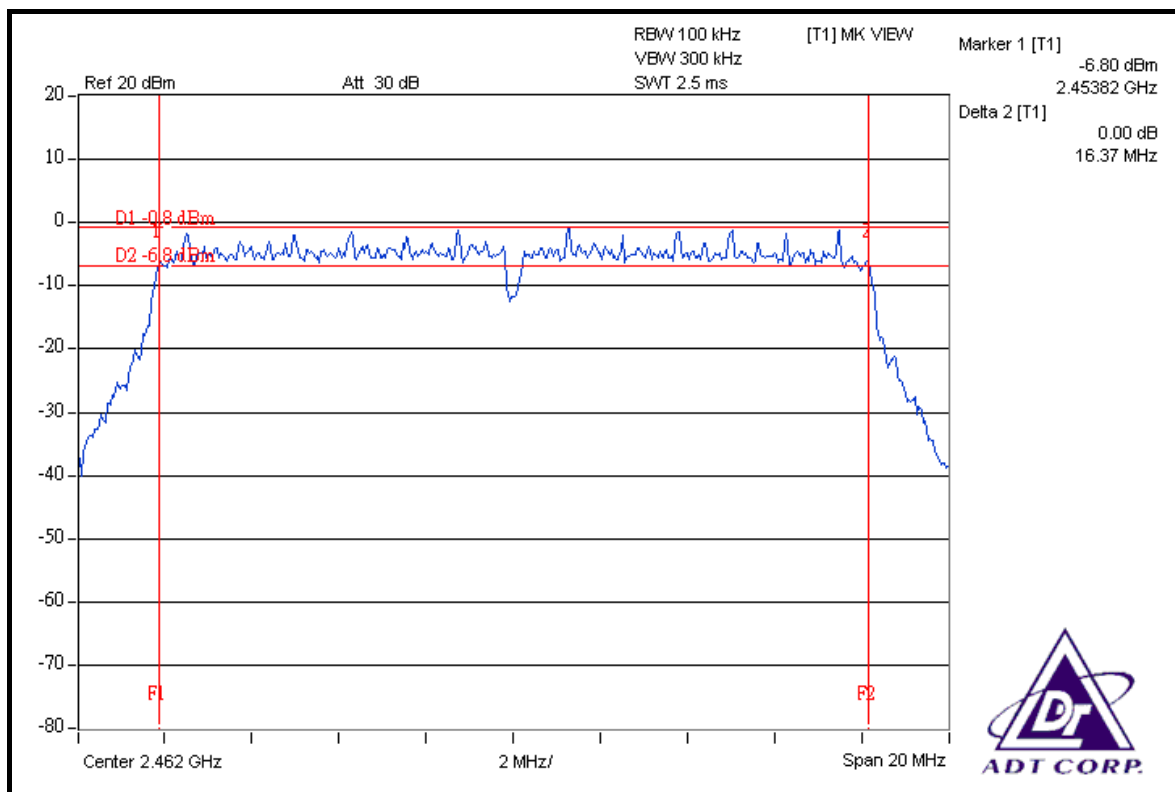



DRAFT 802.11n (20MHz) OFDM MODULATION

MODULATION TYPE	BPSK	TRANSFER RATE	7.2Mbps
INPUT POWER (SYSTEM)	120Vac, 60Hz	ENVIRONMENTAL CONDITIONS	25deg.C, 65%RH, 991hPa
TESTED BY	Brad Wu		

CHANNEL	CHANNEL FREQUENCY (MHz)	6dB BANDWIDTH (MHz)		MINIMUM LIMIT (MHz)	PASS / FAIL
		CHAIN 0	CHAIN 1		
1	2412	16.95	16.67	0.5	PASS
6	2437	16.78	16.43	0.5	PASS
11	2462	16.61	16.43	0.5	PASS



FOR CHAIN 0: CH 1

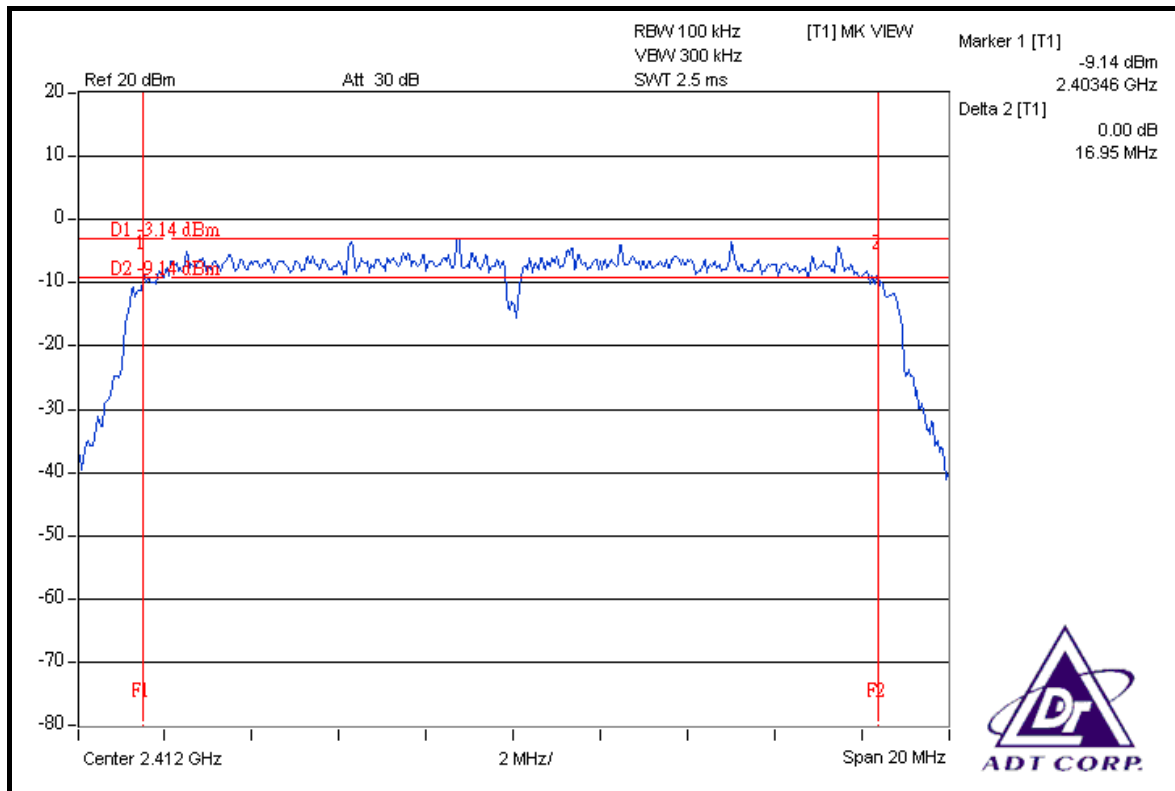

CH 6

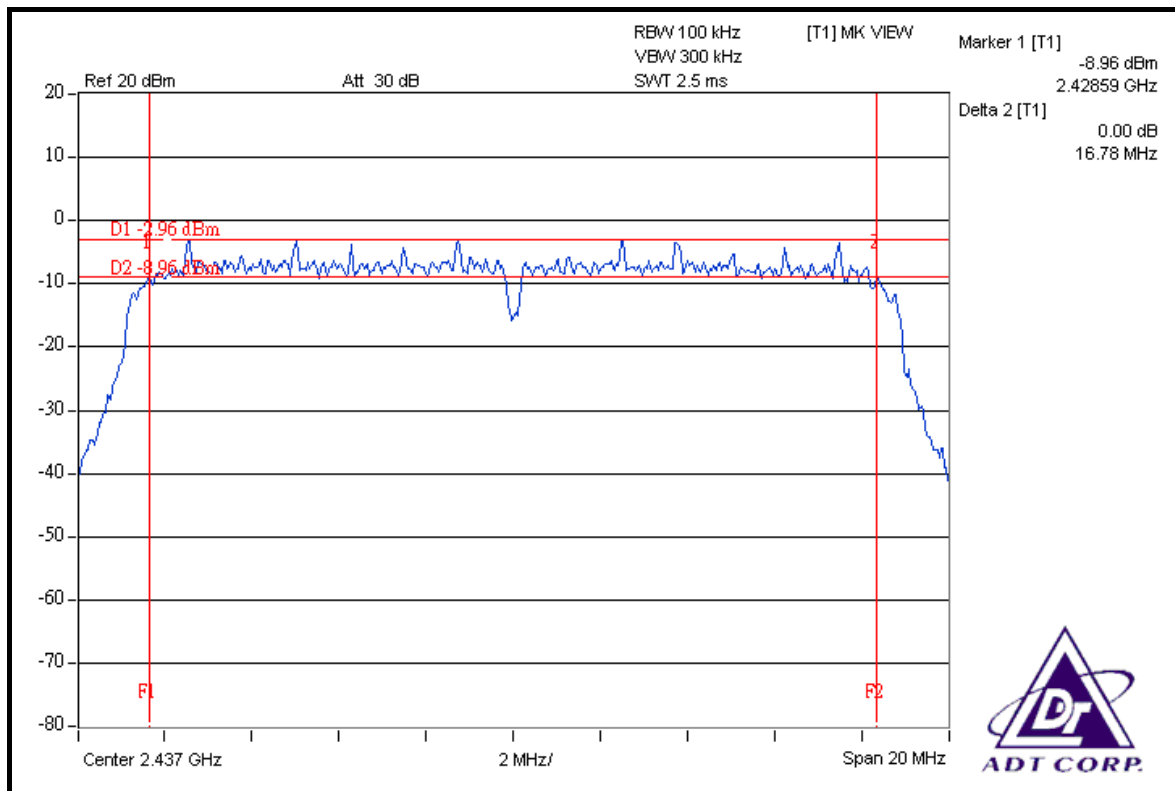

CH 11

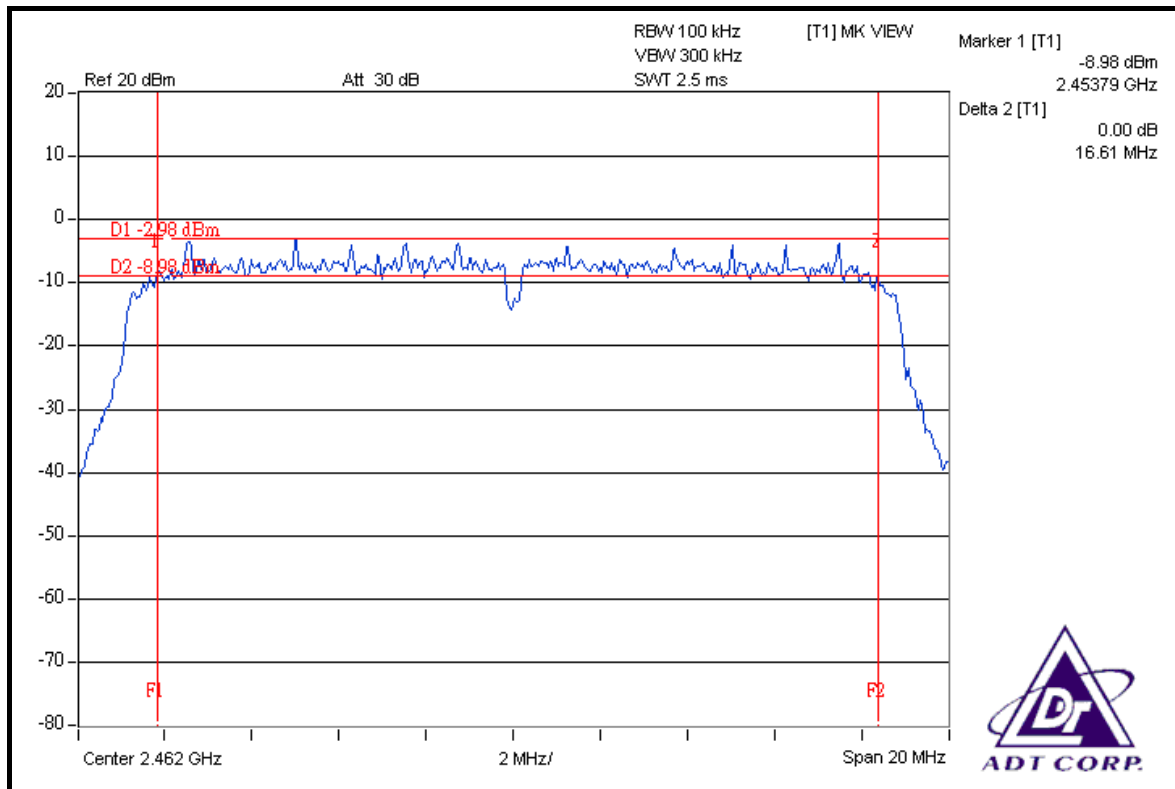

FOR CHAIN 1: CH 1

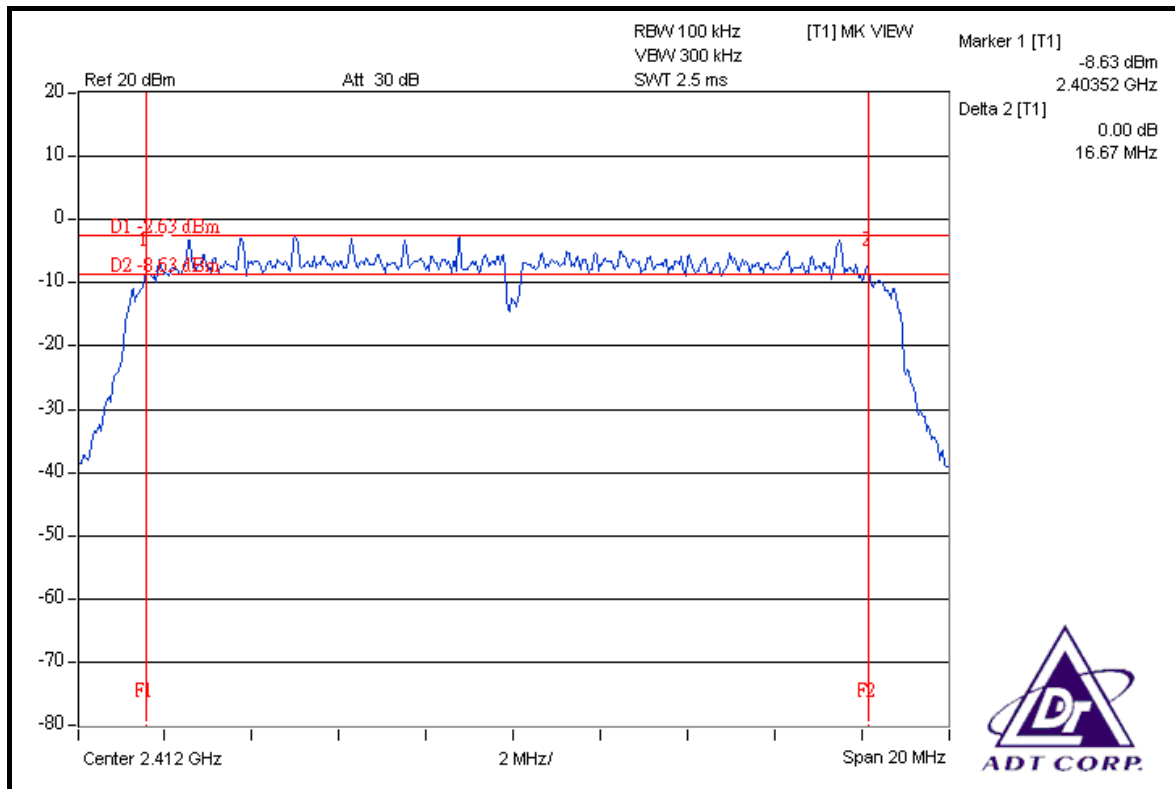

CH 6

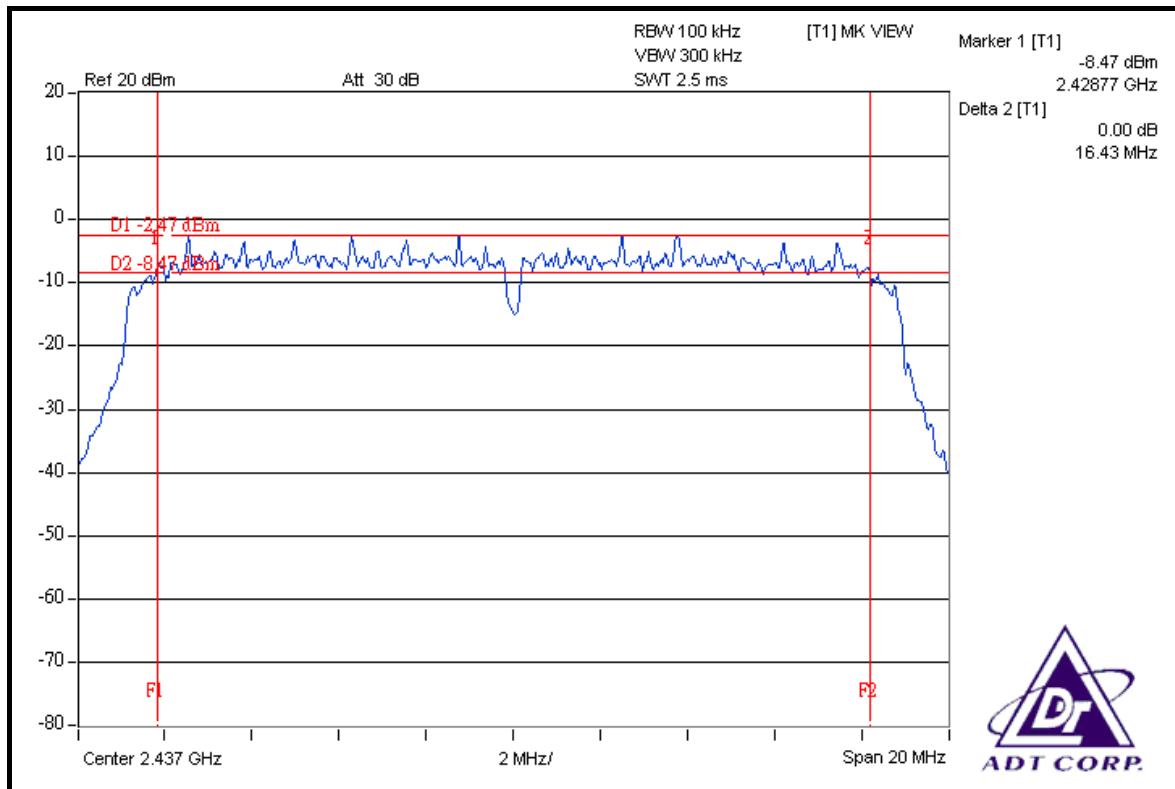

CH 11

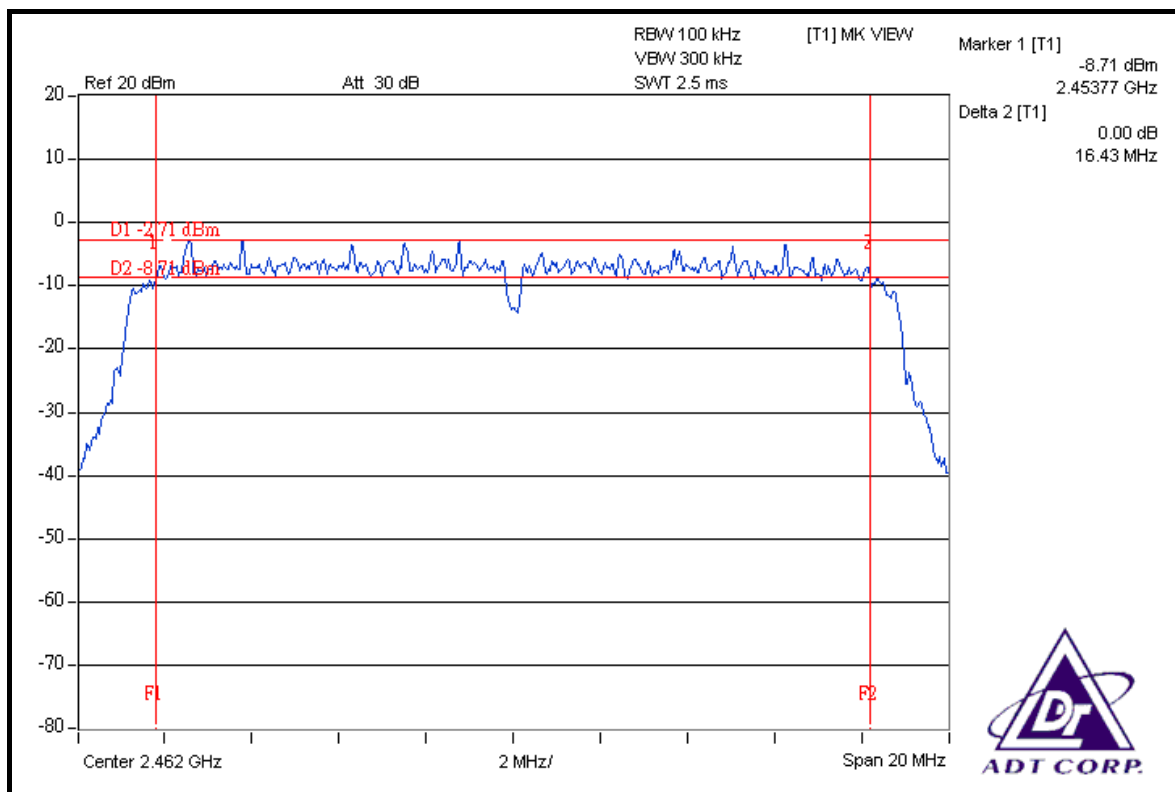



DRAFT 802.11n (40MHz) OFDM MODULATION

MODULATION TYPE	BPSK	TRANSFER RATE	15Mbps
INPUT POWER (SYSTEM)	120Vac, 60Hz	ENVIRONMENTAL CONDITIONS	25deg.C, 65%RH, 991hPa
TESTED BY	Brad Wu		

CHANNEL	CHANNEL FREQUENCY (MHz)	6dB BANDWIDTH (MHz)		MINIMUM LIMIT (MHz)	PASS / FAIL
		CHAIN 0	CHAIN 1		
1	2422	35.09	35.15	0.5	PASS
4	2437	35.15	35.12	0.5	PASS
7	2452	35.11	35.10	0.5	PASS

FOR CHAIN 0: CH 1

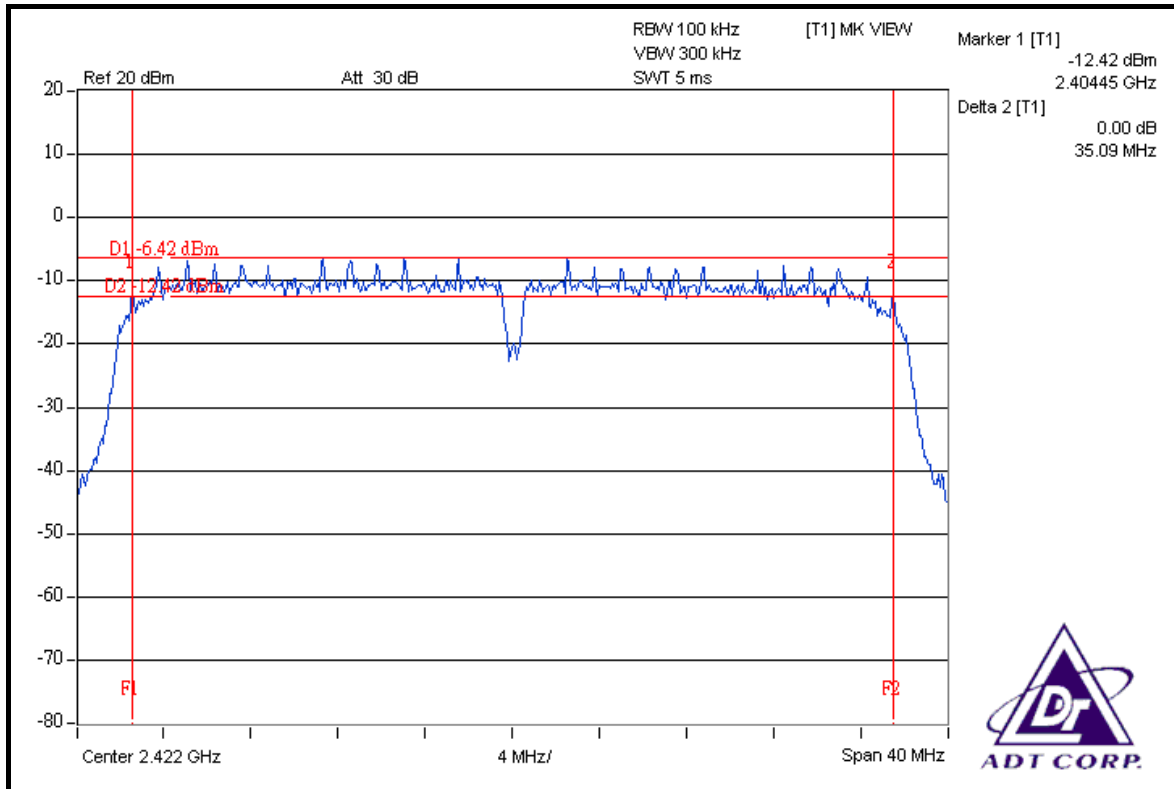

CH 4

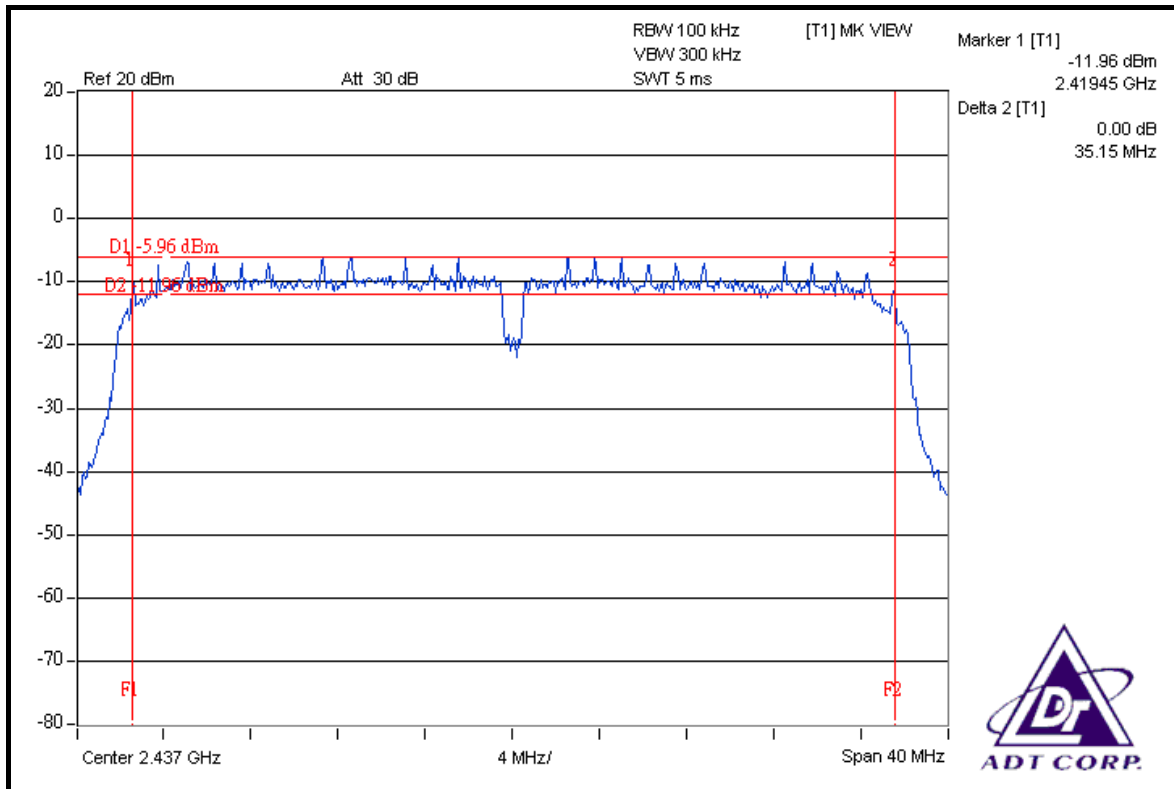

CH 7

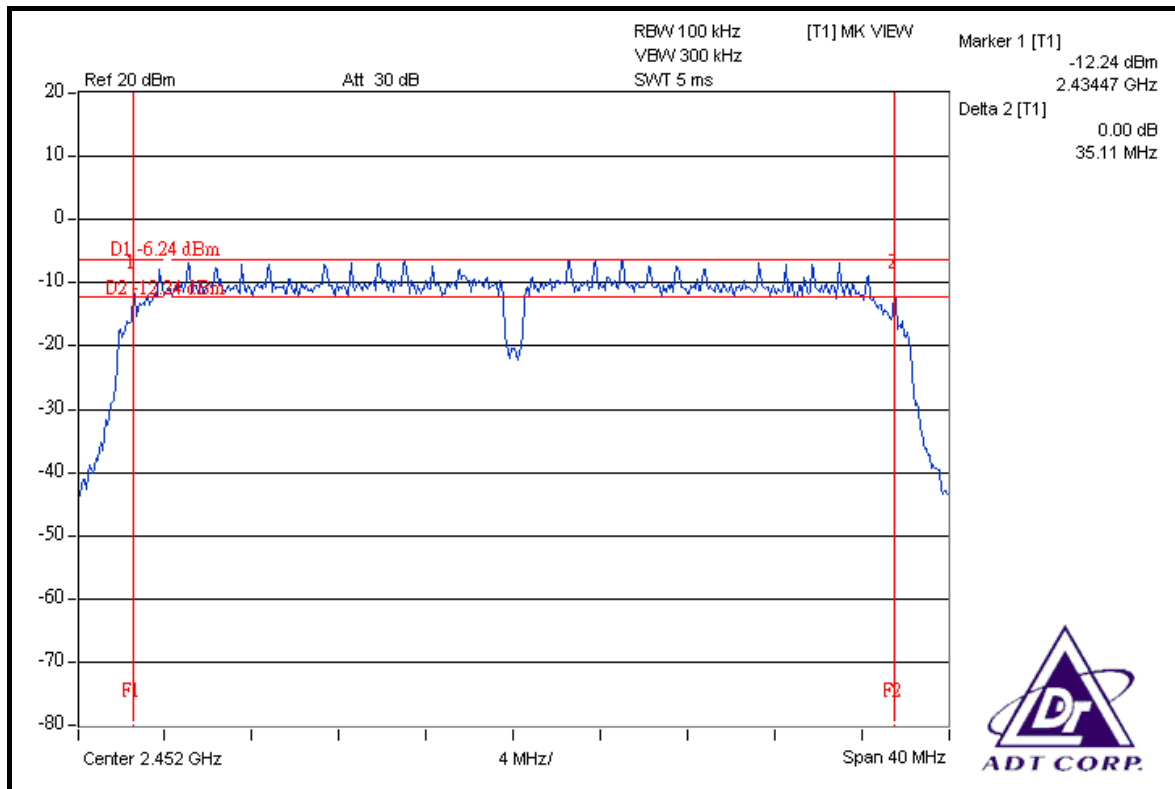

FOR CHAIN 1: CH 1

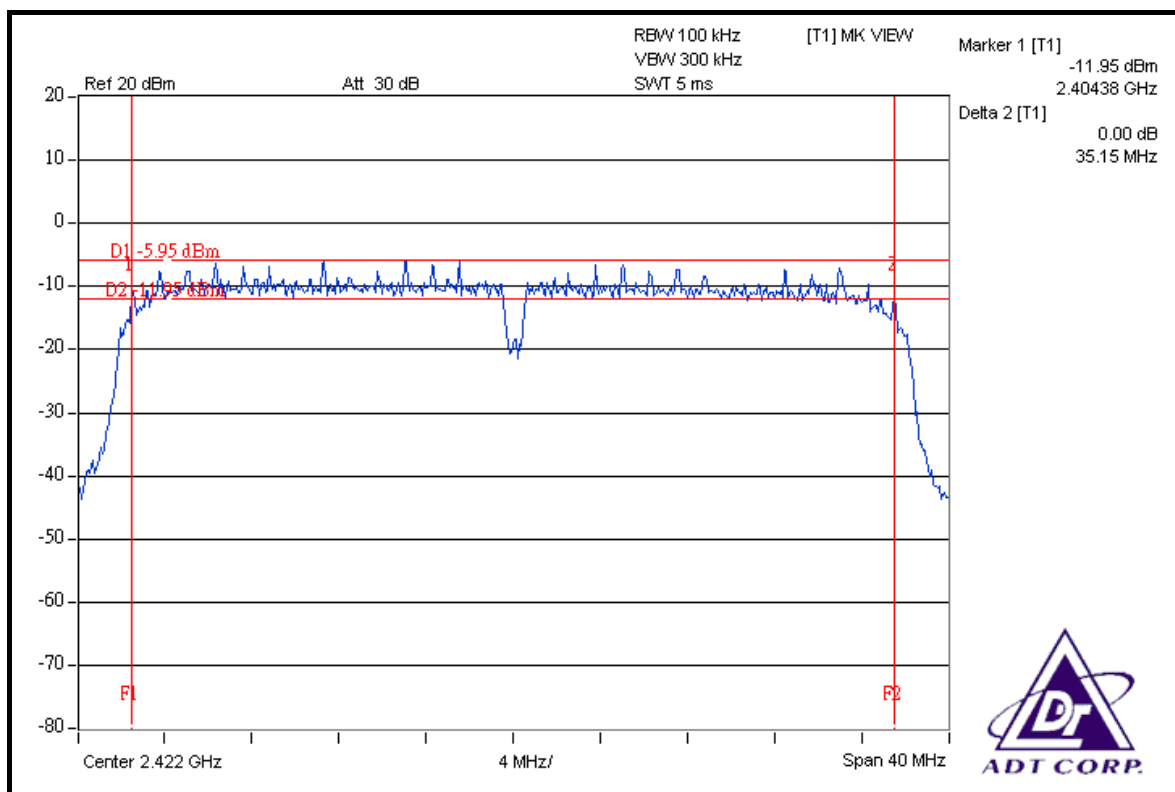



CH 4

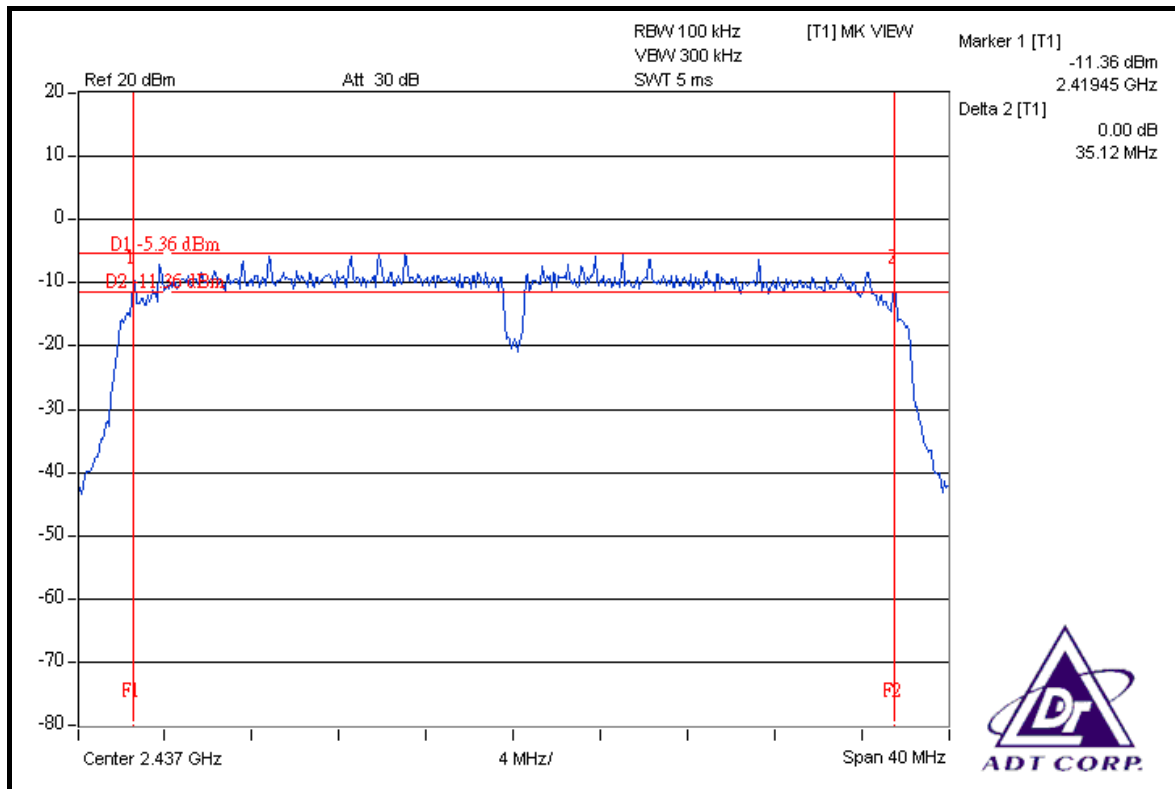

CH 7

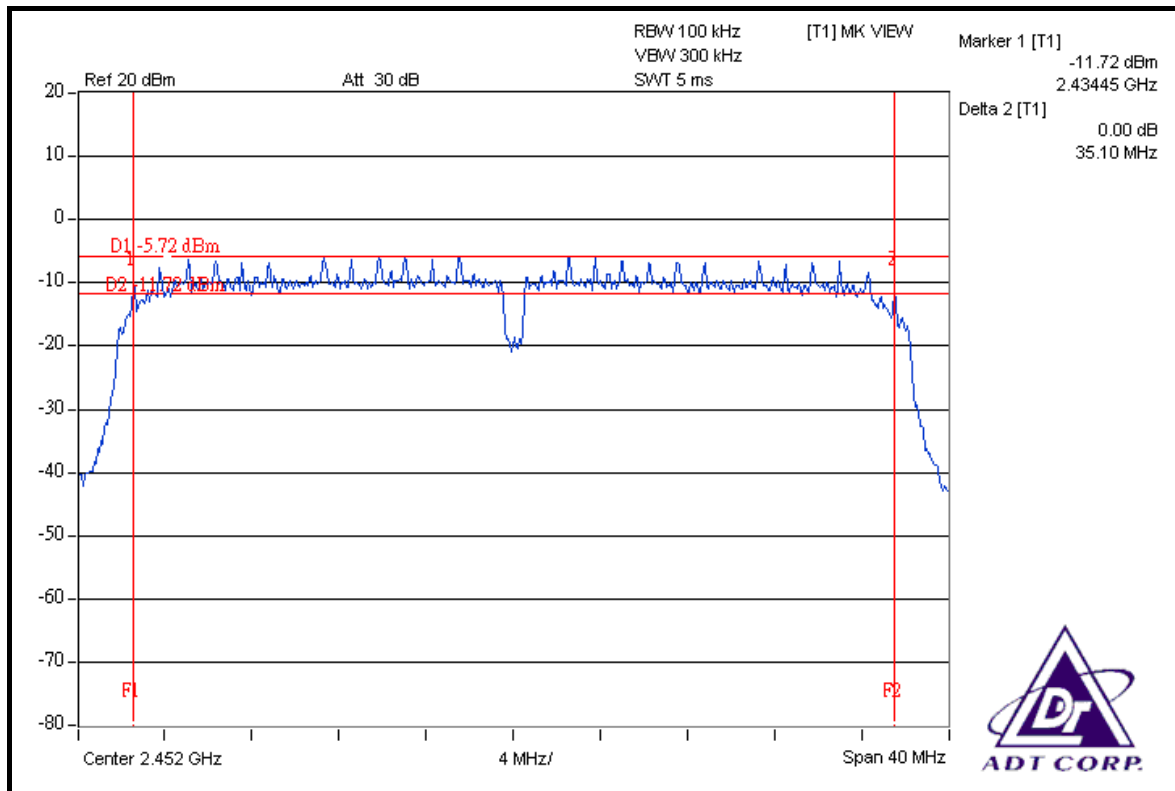



4.4 MAXIMUM PEAK OUTPUT POWER

4.4.1 LIMITS OF MAXIMUM PEAK OUTPUT POWER MEASUREMENT

The Maximum Peak Output Power Measurement is 30dBm.

4.4.2 INSTRUMENTS

DESCRIPTION & MANUFACTURER	MODEL NO.	SERIAL NO.	DATE OF CALIBRATION	CALIBRATED UNTIL
High Speed Peak Power Meter	ML2495A	0824012	Aug. 04, 2008	Aug. 03, 2009
Power Sensor	MA2444B	0738138	Aug. 04, 2008	Aug. 03, 2009

Note:

1. The calibration interval of the above test instruments is 12 months and the calibrations are traceable to NML/ROC and NIST/USA.
2. Measurement Bandwidth of ML2495A is 65MHz greater than 6dB bandwidth of emission.

4.4.3 TEST PROCEDURES

A power sensor was used on the output port of the EUT. A power meter was used to read the response of the power sensor. Record the power level.

4.4.4 DEVIATION FROM TEST STANDARD

No deviation

4.4.5 TEST SETUP

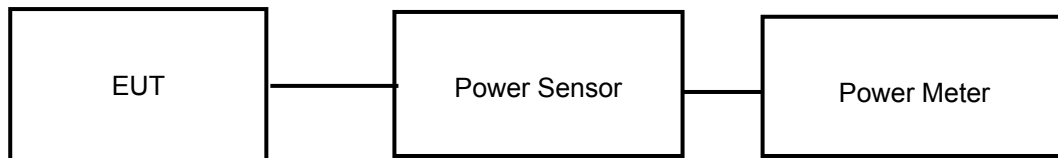

4.4.6 EUT OPERATING CONDITIONS

Same as Item 4.3.6



4.4.7 TEST RESULTS

802.11b DSSS MODULATION

MODULATION TYPE	DBPSK	TRANSFER RATE	1.0Mbps
INPUT POWER (SYSTEM)	120Vac, 60Hz	ENVIRONMENTAL CONDITIONS	25deg.C, 65%RH, 991hPa
TESTED BY	Brad Wu		

CHANNEL	CHANNEL FREQUENCY (MHz)	PEAK POWER OUTPUT (mW)	PEAK POWER OUTPUT (dBm)	PEAK POWER LIMIT (dBm)	PASS / FAIL
1	2412	129.122	21.11	30	PASS
6	2437	128.529	21.09	30	PASS
11	2462	127.350	21.05	30	PASS

802.11g OFDM MODULATION

MODULATION TYPE	BPSK	TRANSFER RATE	6.0Mbps
INPUT POWER (SYSTEM)	120Vac, 60Hz	ENVIRONMENTAL CONDITIONS	25 deg.C, 65 %RH, 991hPa
TESTED BY	Brad Wu		

CHAN.	CHAN. FREQ. (MHz)	PEAK POWER OUTPUT (dBm)		TOTAL PEAK POWER (mW)	TOTAL PEAK POWER (dBm)	PEAK POWER LIMIT (dBm)	PASS / FAIL
		CHAIN 0	CHAIN 1				
1	2412	22.06	22.08	322.130	25.08	30	PASS
6	2437	22.56	22.11	342.857	25.35	30	PASS
11	2462	22.11	22.07	323.619	25.10	30	PASS



DRAFT 802.11n (20MHz) OFDM MODULATION

MODULATION TYPE	BPSK	TRANSFER RATE	7.2Mbps
INPUT POWER (SYSTEM)	120Vac, 60Hz	ENVIRONMENTAL CONDITIONS	25 deg.C, 65 %RH, 991hPa
TESTED BY	Brad Wu		

CHAN.	CHAN. FREQ. (MHz)	PEAK POWER OUTPUT (dBm)		TOTAL PEAK POWER (mW)	TOTAL PEAK POWER (dBm)	PEAK POWER LIMIT (dBm)	PASS / FAIL
		CHAIN 0	CHAIN 1				
1	2412	19.05	19.09	161.449	22.08	30	PASS
6	2437	19.09	19.08	162.006	22.10	30	PASS
11	2462	19.03	19.03	159.967	22.04	30	PASS

DRAFT 802.11n (40MHz) OFDM MODULATION:

MODULATION TYPE	BPSK	TRANSFER RATE	15Mbps
INPUT POWER (SYSTEM)	120Vac, 60Hz	ENVIRONMENTAL CONDITIONS	25deg.C, 65%RH, 991hPa
TESTED BY	Brad Wu		

CHAN.	CHAN. FREQ. (MHz)	PEAK POWER OUTPUT (dBm)		TOTAL PEAK POWER (mW)	TOTAL PEAK POWER (dBm)	PEAK POWER LIMIT (dBm)	PASS / FAIL
		CHAIN 0	CHAIN 1				
1	2422	19.04	19.11	161.638	22.09	30	PASS
4	2437	19.59	19.62	182.613	22.62	30	PASS
7	2452	19.06	19.07	161.261	22.08	30	PASS



4.5 POWER SPECTRAL DENSITY MEASUREMENT

4.5.1 LIMITS OF POWER SPECTRAL DENSITY MEASUREMENT

The Maximum of Power Spectral Density Measurement is 8dBm.

4.5.2 TEST INSTRUMENTS

DESCRIPTION & MANUFACTURER	MODEL NO.	SERIAL NO.	DATE OF CALIBRATION	CALIBRATED UNTIL
R&S SPECTRUM ANALYZER	FSP40	100041	Apr. 22, 2008	Apr. 21, 2009

NOTE: The calibration interval of the above test instruments is 12 months and the calibrations are traceable to NML/ROC and NIST/USA.

4.5.3 TEST PROCEDURE

The transmitter output was connected to the spectrum analyzer through an attenuator, the bandwidth of the fundamental frequency was measured with the spectrum analyzer using 3kHz RBW and 30kHz VBW, set sweep time = span/3kHz. The power spectral density was measured and recorded.

The sweep time is allowed to be longer than span/3kHz for a full response of the mixer in the spectrum analyzer.

4.5.4 DEVIATION FROM TEST STANDARD

No deviation

4.5.5 TEST SETUP

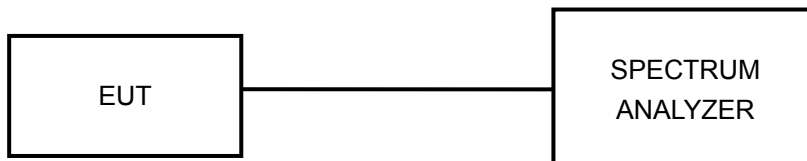

4.5.6 EUT OPERATING CONDITION

Same as Item 4.3.6



4.5.7 TEST RESULTS

802.11b DSSS MODULATION

MODULATION TYPE	DBPSK	TRANSFER RATE	1.0Mbps
INPUT POWER (SYSTEM)	120Vac, 60Hz	ENVIRONMENTAL CONDITIONS	25deg.C, 65%RH, 991hPa
TESTED BY	Brad Wu		

CHANNEL	CHANNEL FREQUENCY (MHz)	RF POWER LEVEL IN 3kHz BW (dBm)	MAXIMUM LIMIT (dBm)	PASS / FAIL
1	2412	-7.96	8	PASS
6	2437	-8.01	8	PASS
11	2462	-7.89	8	PASS

CH 1

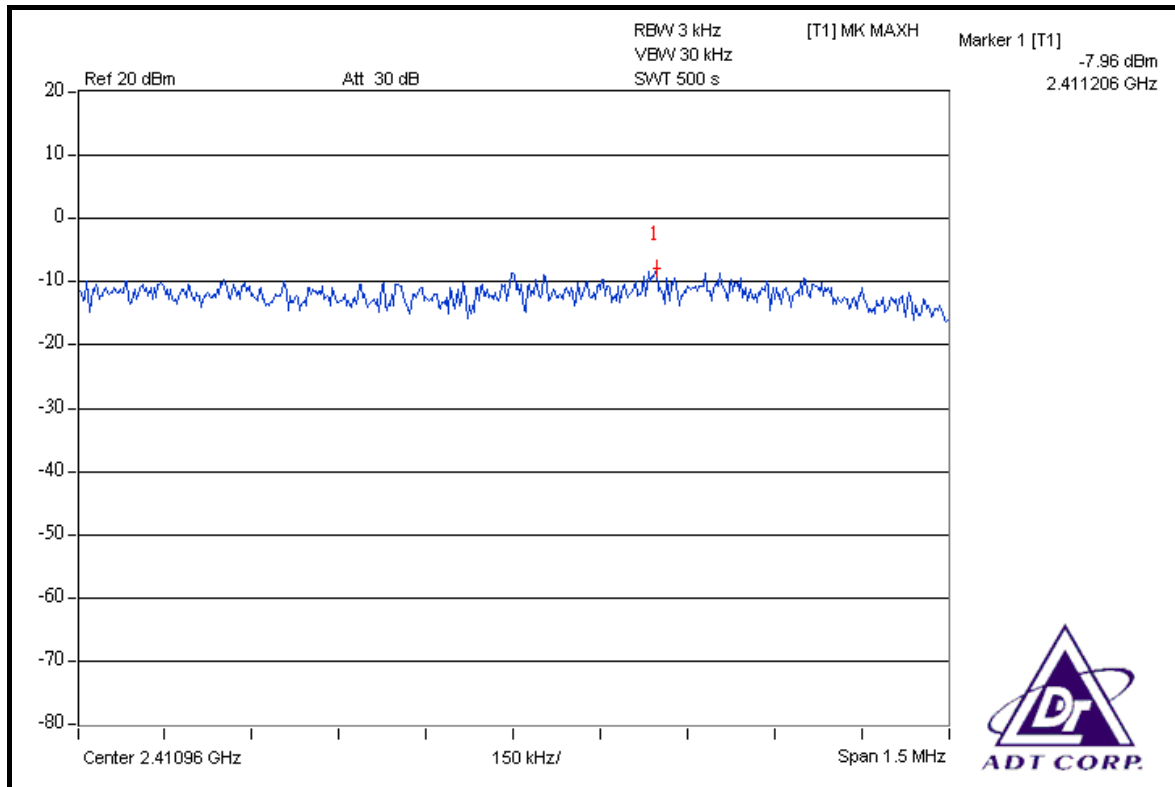



CH 6

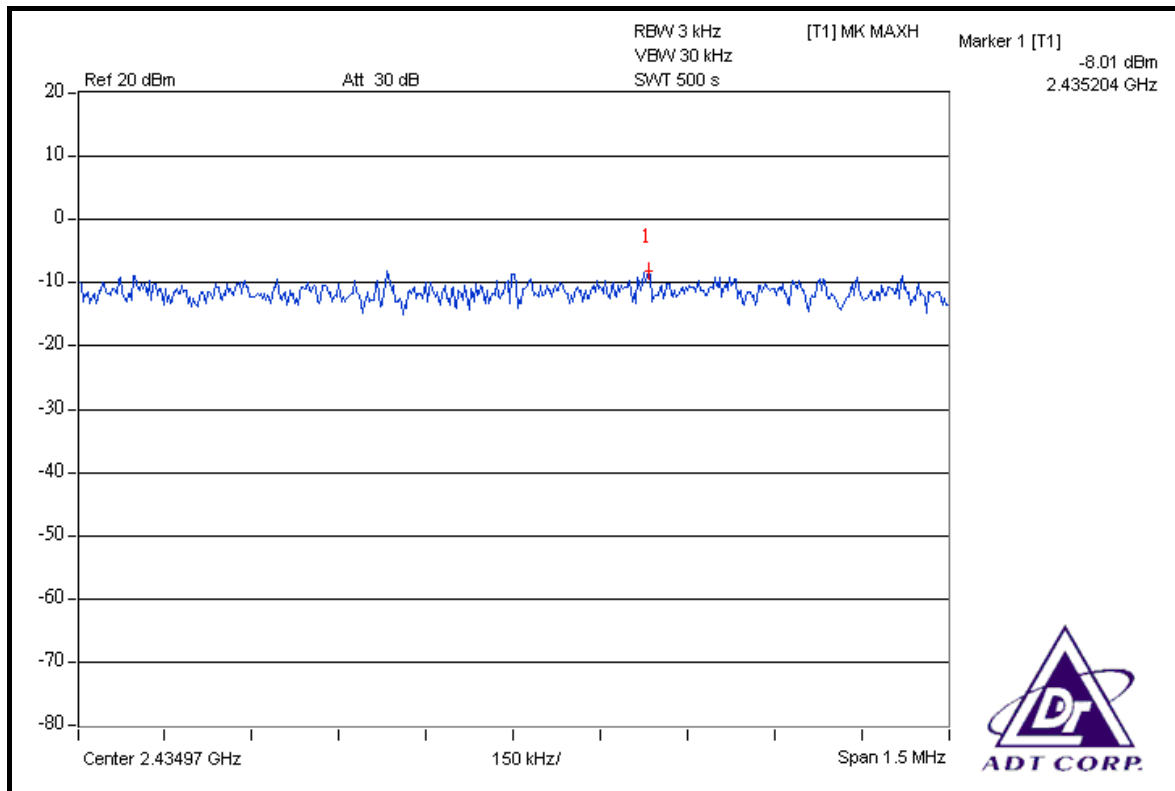

CH 11

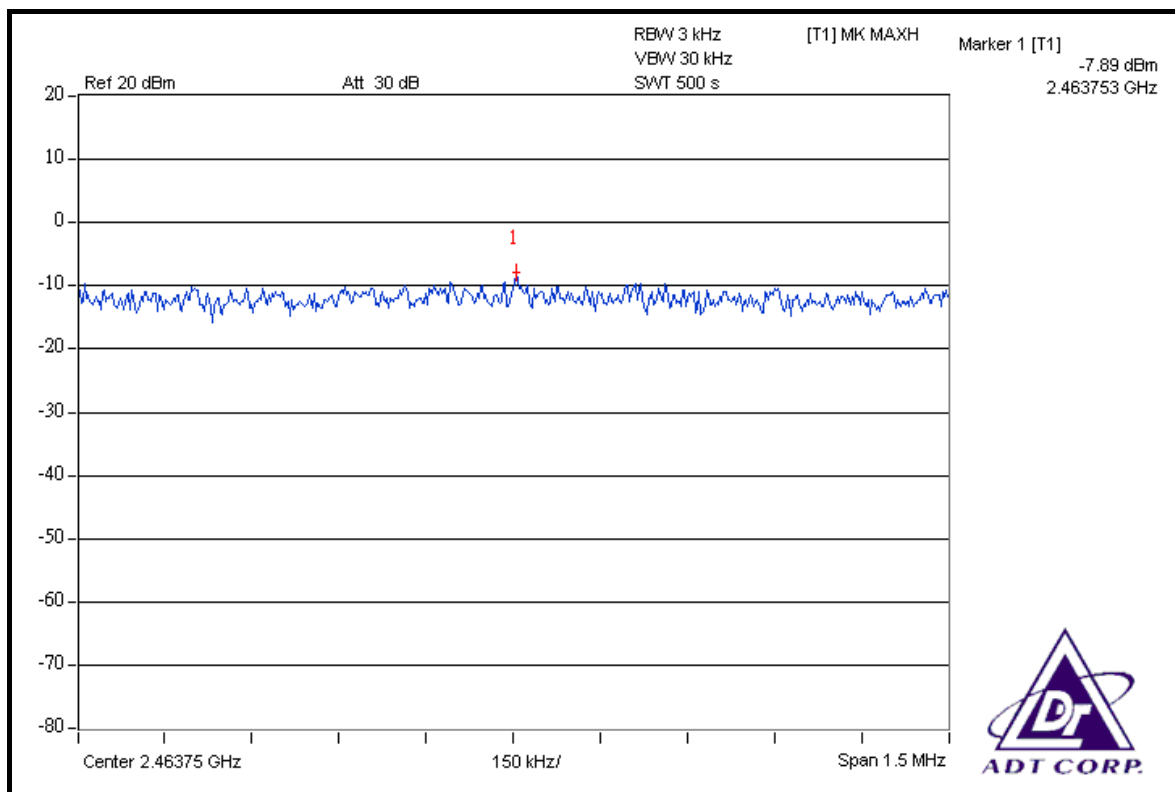



802.11g OFDM MODULATION

MODULATION TYPE	BPSK	TRANSFER RATE	6.0Mbps
INPUT POWER (SYSTEM)	120Vac, 60Hz	ENVIRONMENTAL CONDITIONS	25deg.C, 65%RH, 991hPa
TESTED BY	Long Chen		

CHAN.	CHAN. FREQ. (MHz)	RF POWER LEVEL IN 3kHz BW (dBm)		TOTAL POWER DENSITY (mW)	TOTAL POWER DENSITY (dBm)	MAX. LIMIT (dBm)	PASS / FAIL
		CHAIN 0	CHAIN 1				
1	2412	-14.37	-14.34	0.073	-11.34	8	PASS
6	2437	-13.82	-14.15	0.080	-10.97	8	PASS
11	2462	-14.47	-14.27	0.073	-11.36	8	PASS



FOR CHAIN 0: CH 1

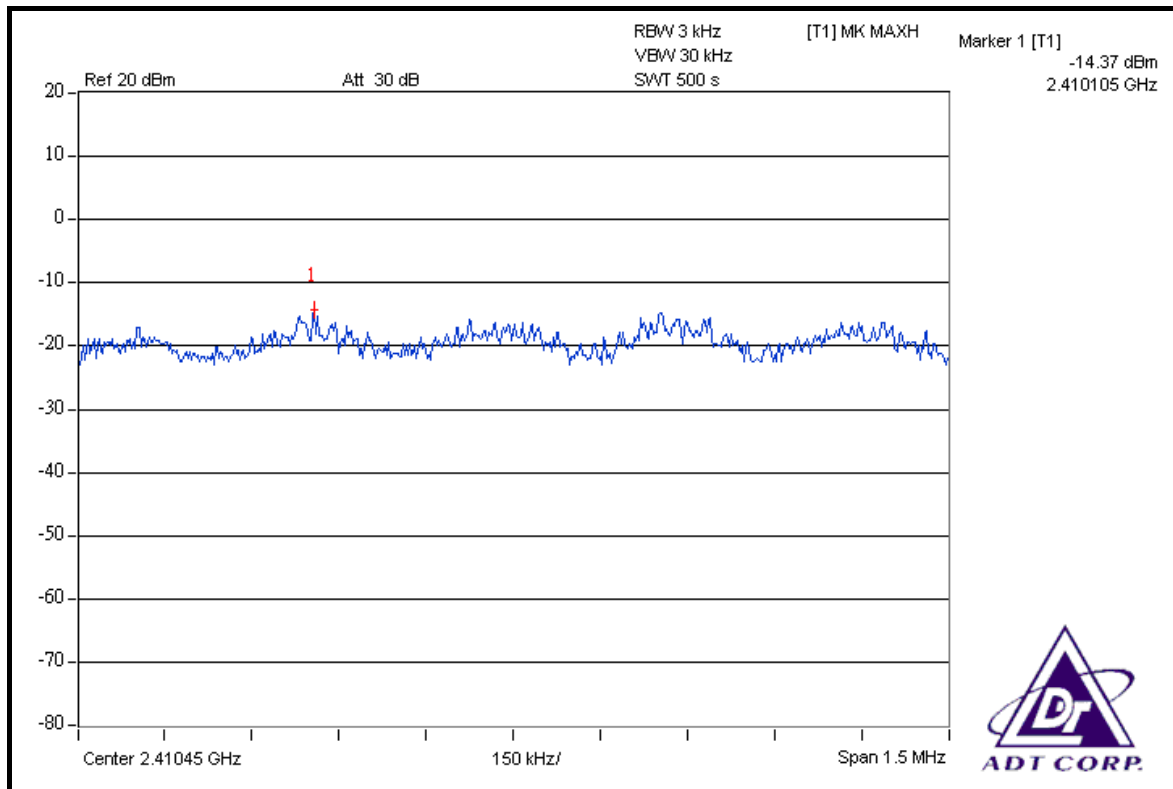

CH 6

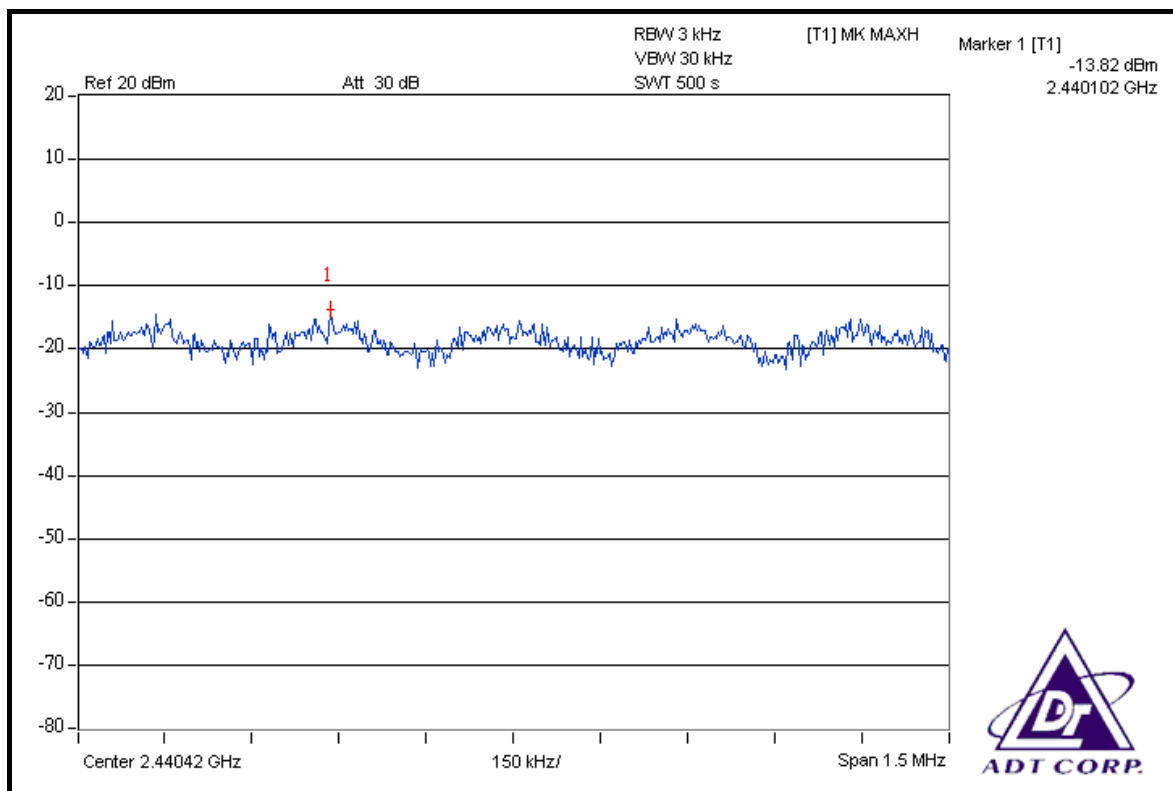



CH 11

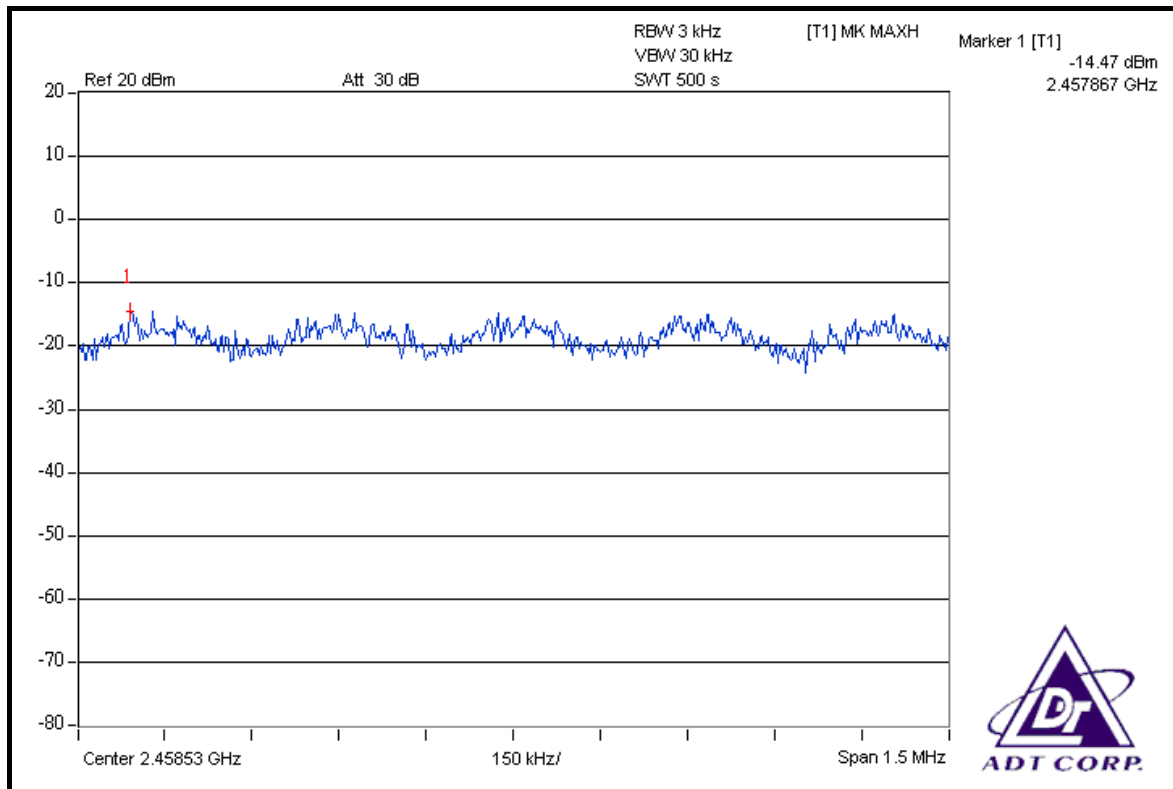

FOR CHAIN 1: CH 1

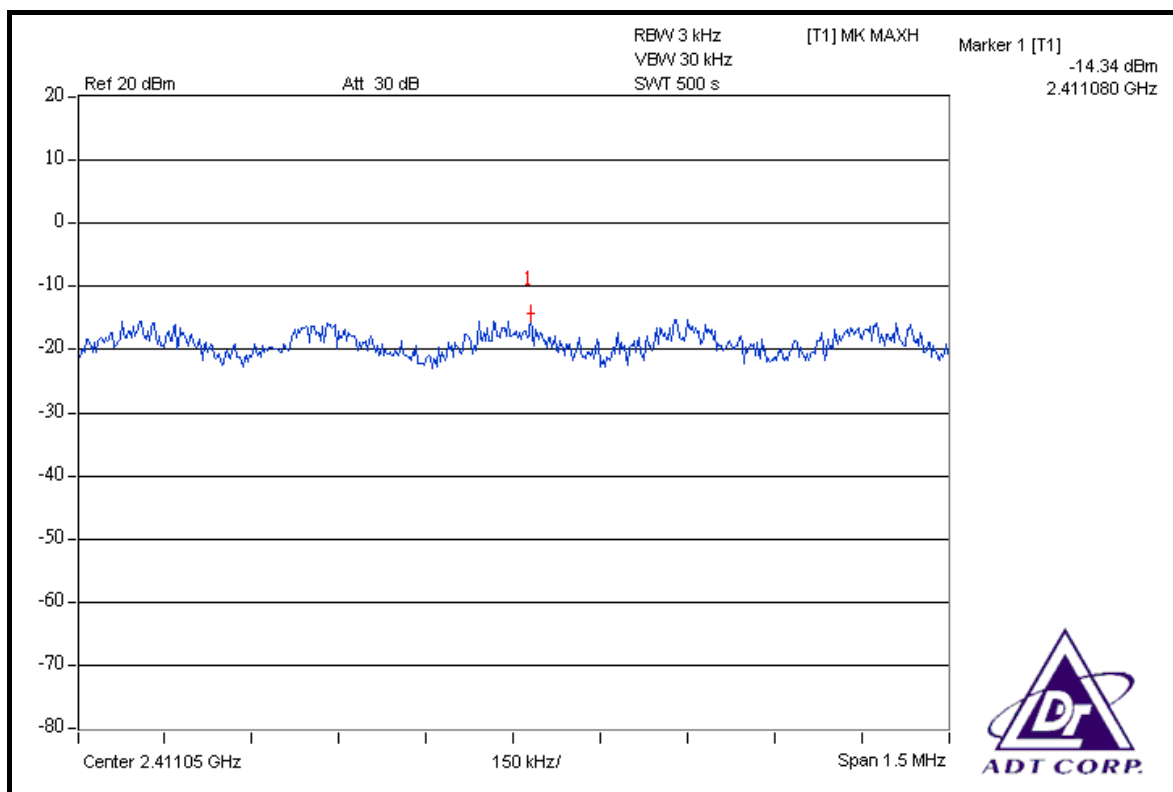



CH 6

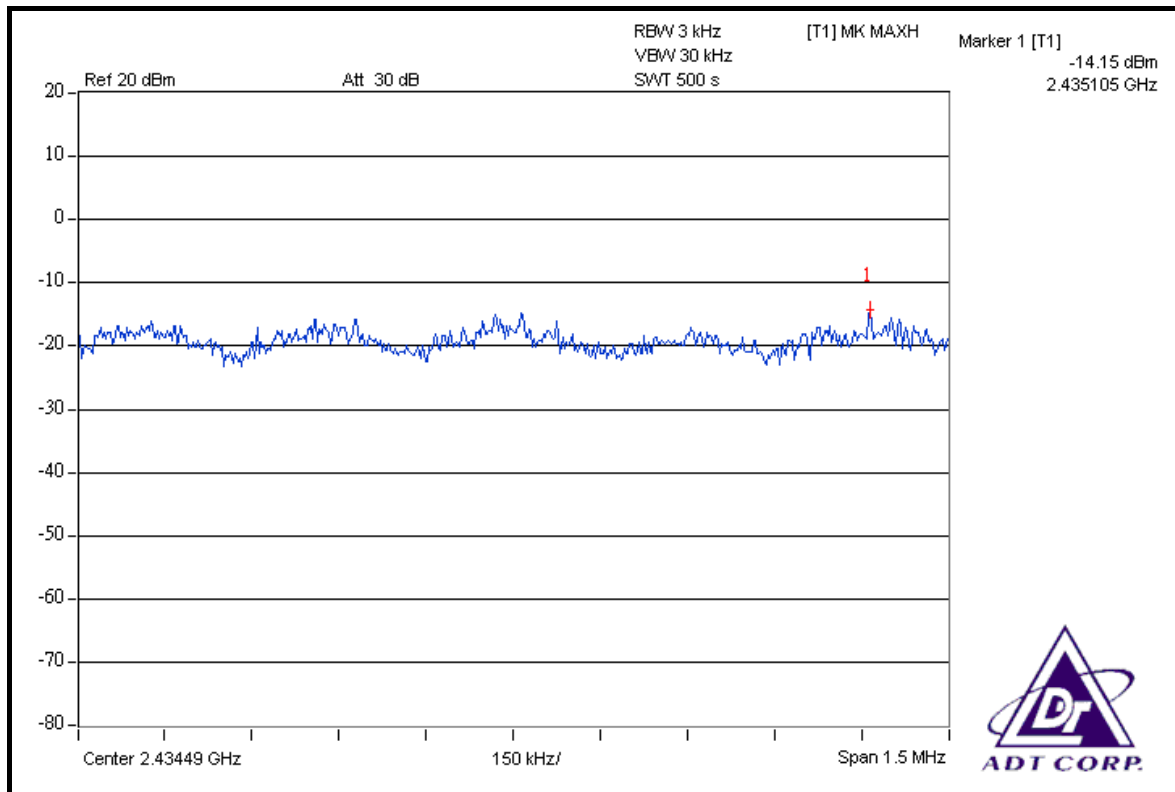

CH 11

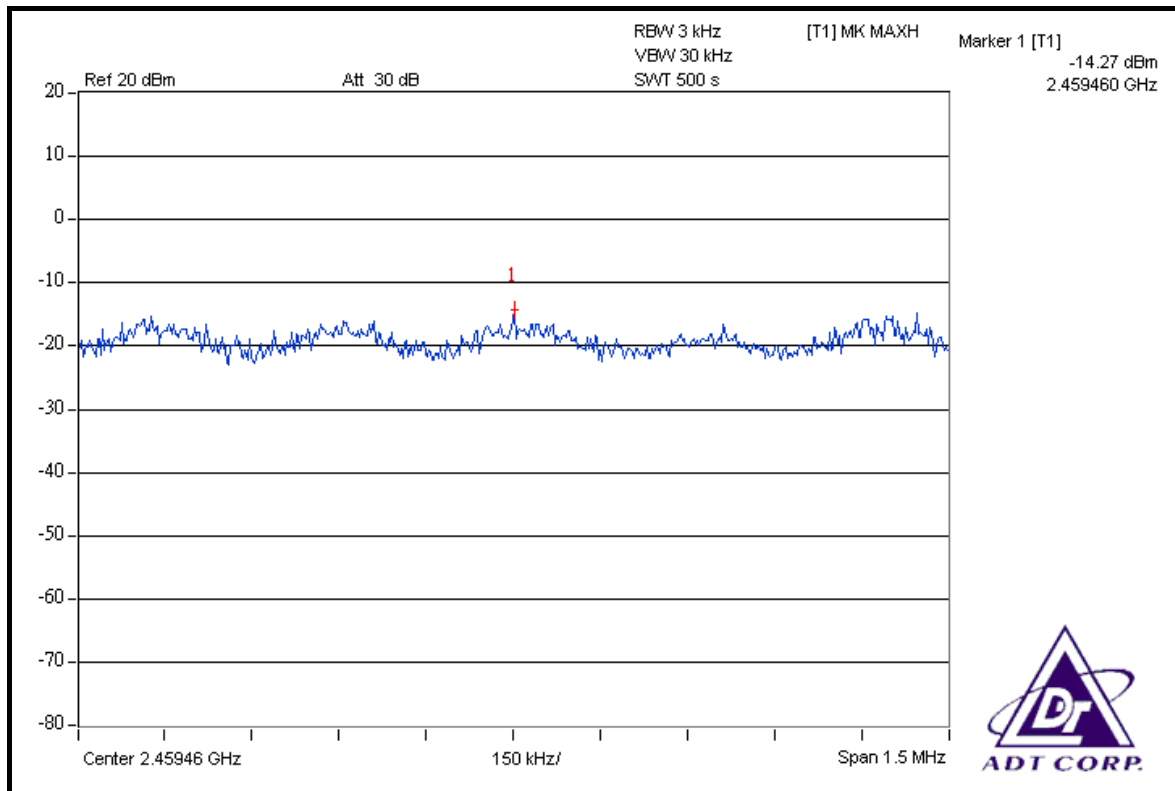



DRAFT 802.11n (20MHz) OFDM MODULATION

MODULATION TYPE	BPSK	TRANSFER RATE	7.2Mbps
INPUT POWER (SYSTEM)	120Vac, 60Hz	ENVIRONMENTAL CONDITIONS	25deg.C, 65%RH, 991hPa
TESTED BY	Brad Wu		

CHAN.	CHAN. FREQ. (MHz)	RF POWER LEVEL IN 3kHz BW (dBm)		TOTAL POWER DENSITY (mW)	TOTAL POWER DENSITY (dBm)	MAX. LIMIT (dBm)	PASS / FAIL
		CHAIN 0	CHAIN 1				
1	2412	-16.69	-16.85	0.042	-13.76	8	PASS
6	2437	-16.55	-16.70	0.044	-13.61	8	PASS
11	2462	-16.87	-16.73	0.042	-13.79	8	PASS



FOR CHAIN 0: CH 1

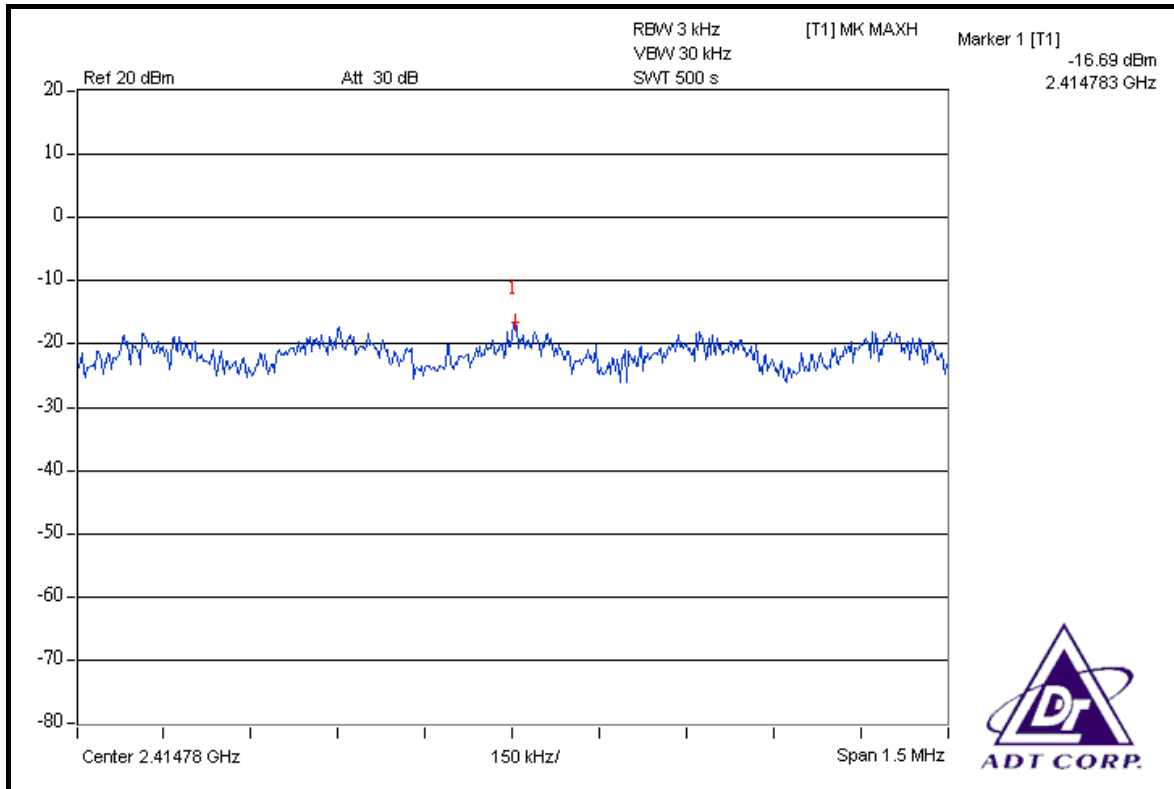

CH 6

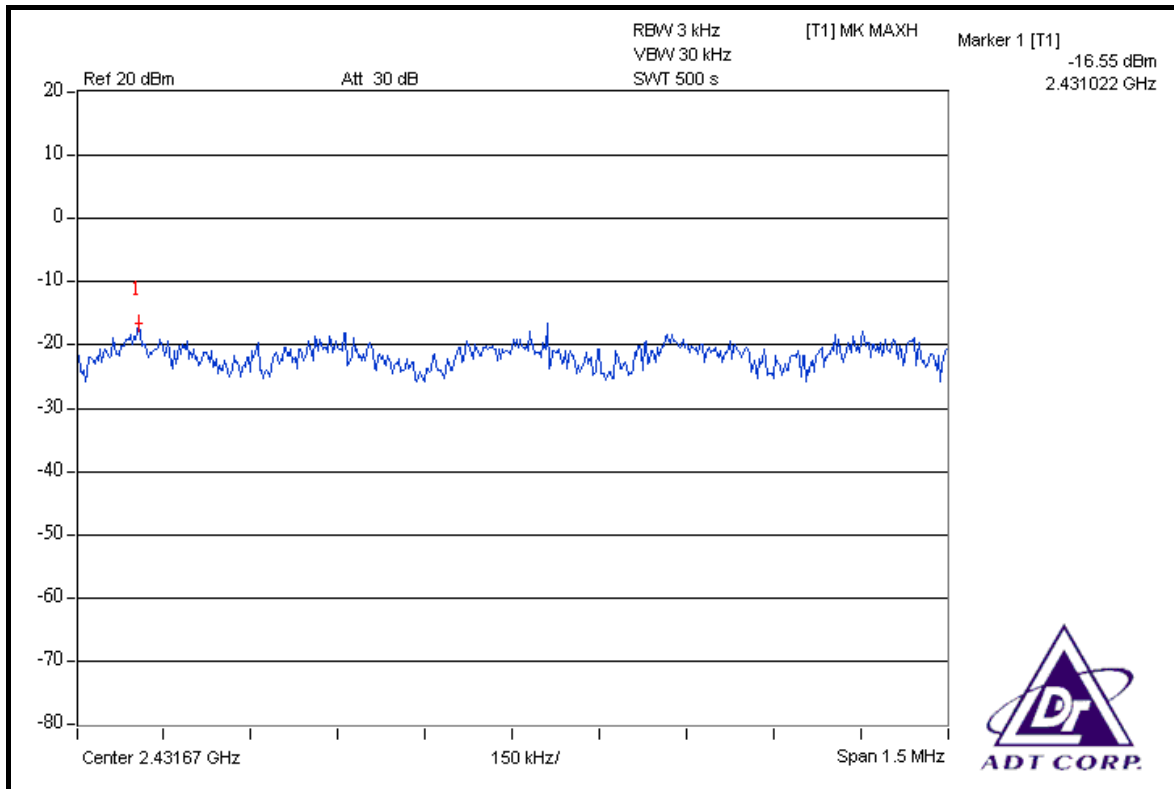



CH 11

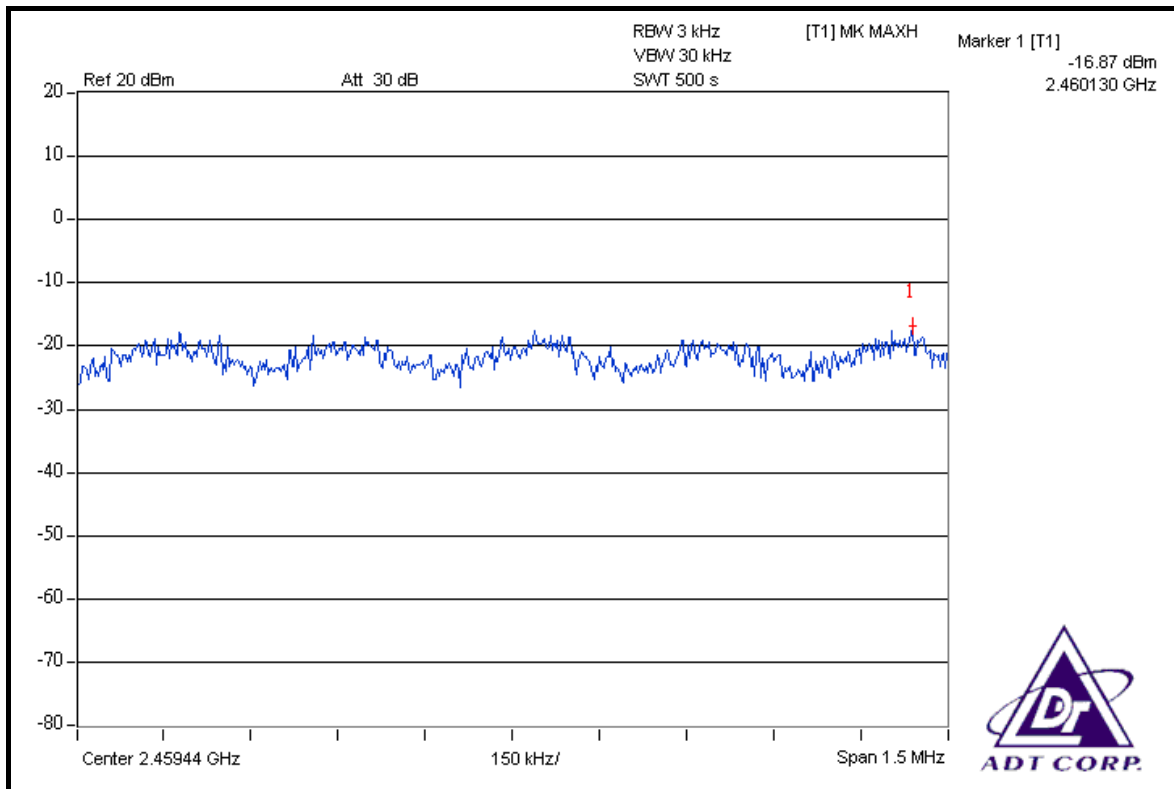

FOR CHAIN 1: CH 1

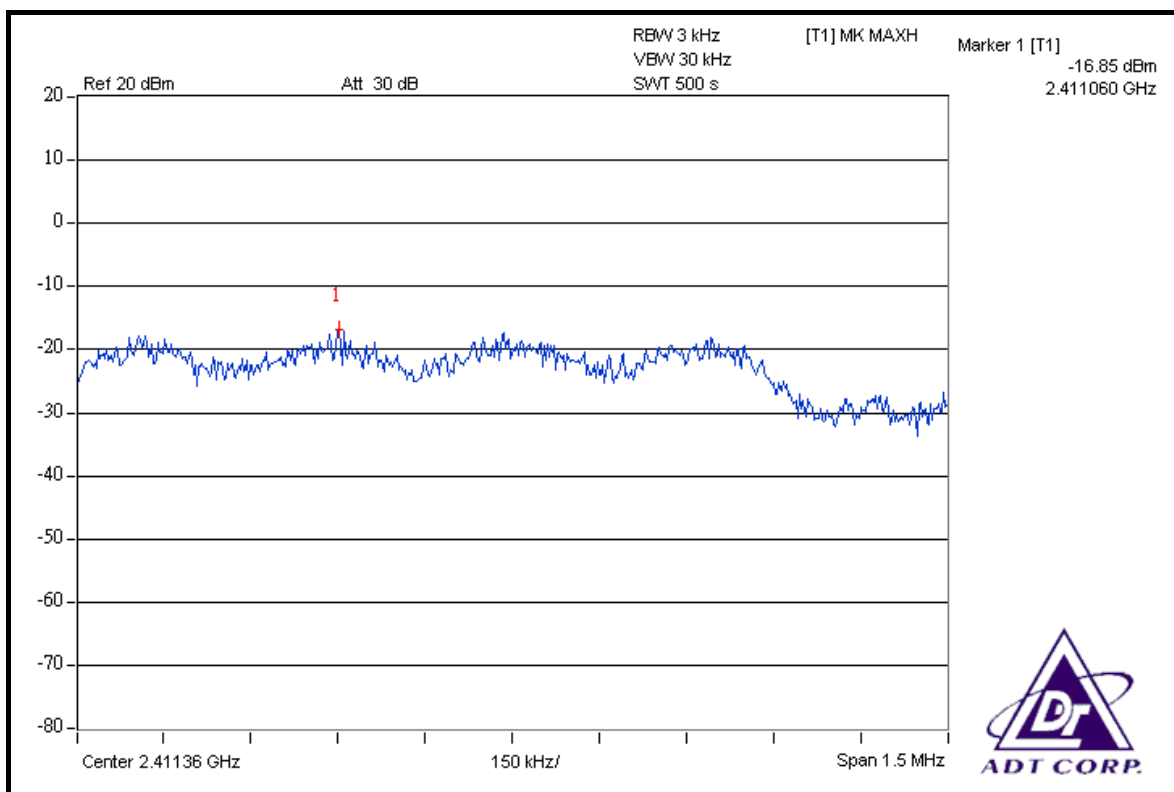

CH 6

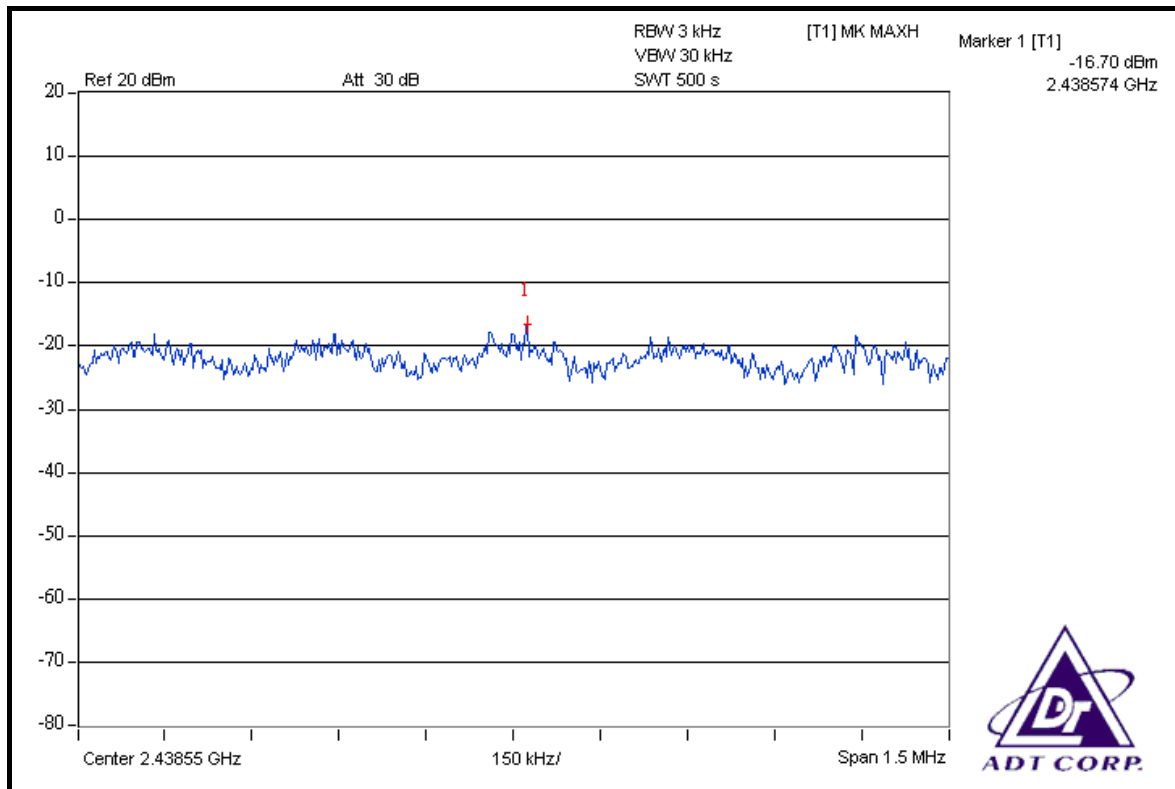

CH 11

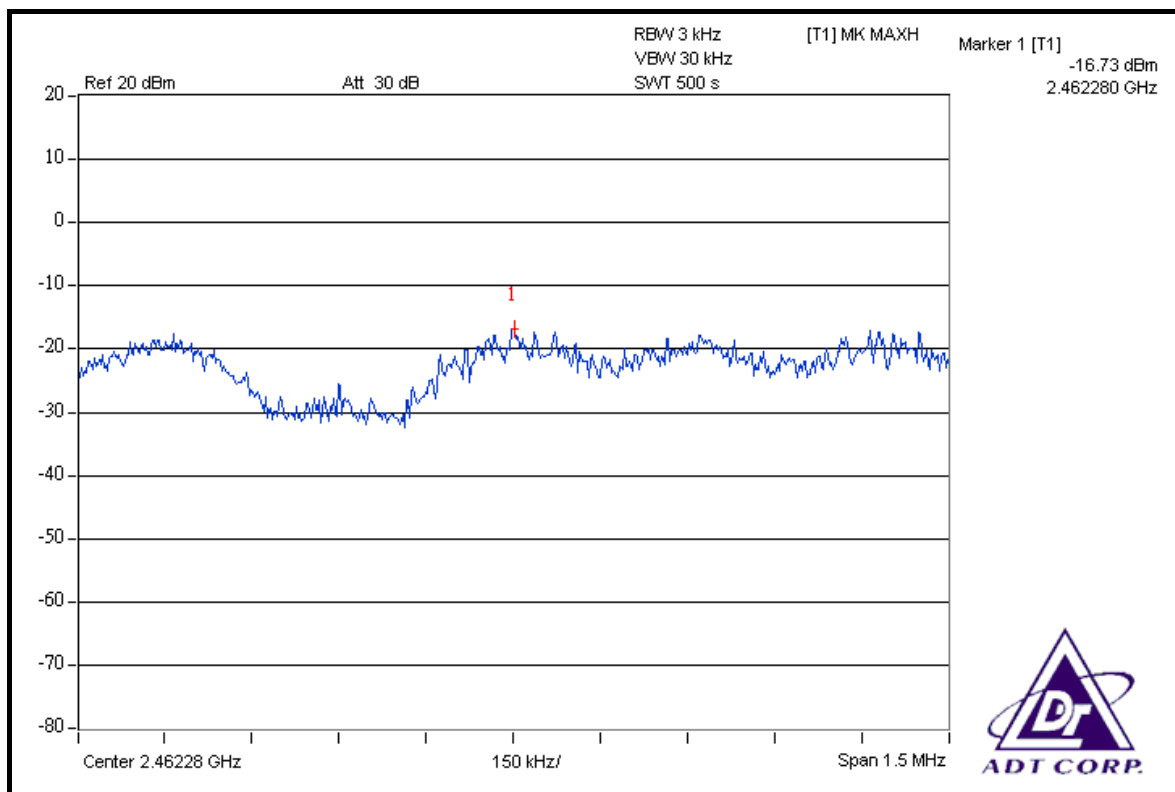



DRAFT 802.11n (40MHz) OFDM MODULATION

MODULATION TYPE	BPSK	TRANSFER RATE	15Mbps
INPUT POWER (SYSTEM)	120Vac, 60Hz	ENVIRONMENTAL CONDITIONS	25 deg.C, 65 %RH, 991hPa
TESTED BY	Brad Wu		

CHAN.	CHAN. FREQ. (MHz)	RF POWER LEVEL IN 3kHz BW (dBm)		TOTAL POWER DENSITY (mW)	TOTAL POWER DENSITY (dBm)	MAX. LIMIT (dBm)	PASS / FAIL
		CHAIN 0	CHAIN 1				
1	2422	-20.44	-20.74	0.017	-17.58	8	PASS
4	2437	-19.79	-20.01	0.020	-16.89	8	PASS
7	2452	-20.23	-20.54	0.018	-17.37	8	PASS



FOR CHAIN 0: CH 1

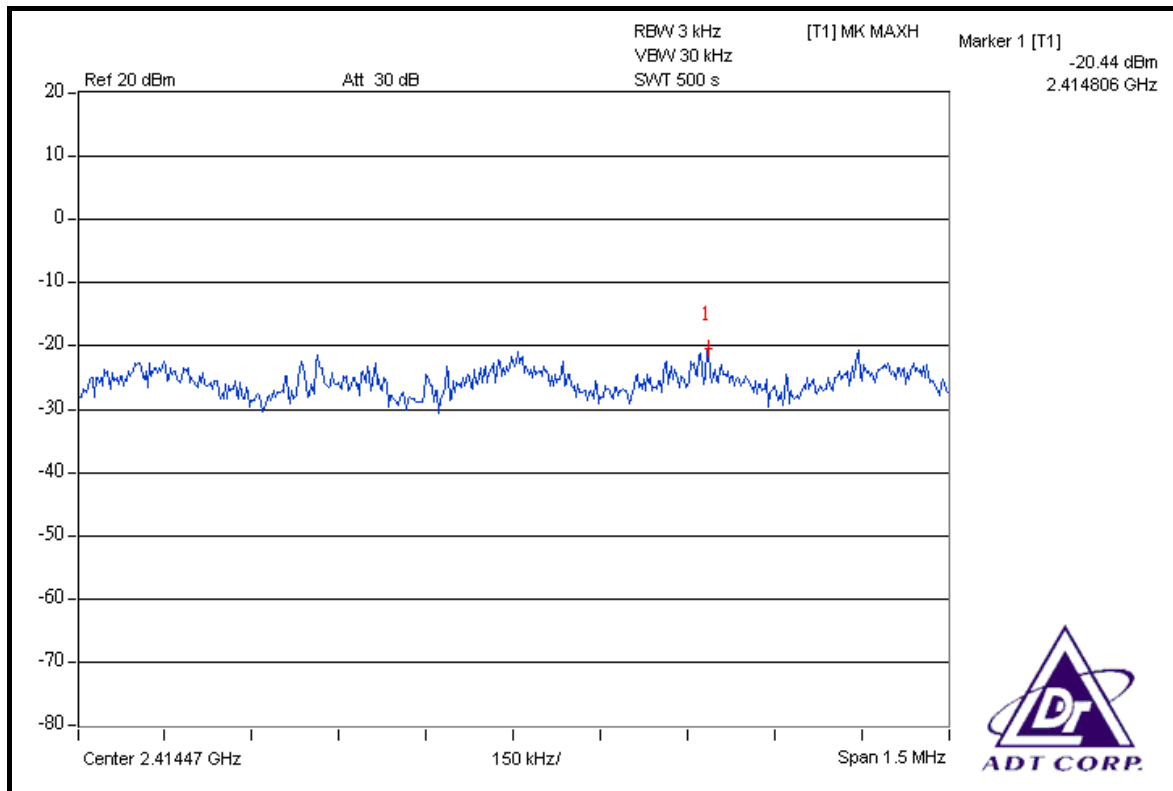

CH 4

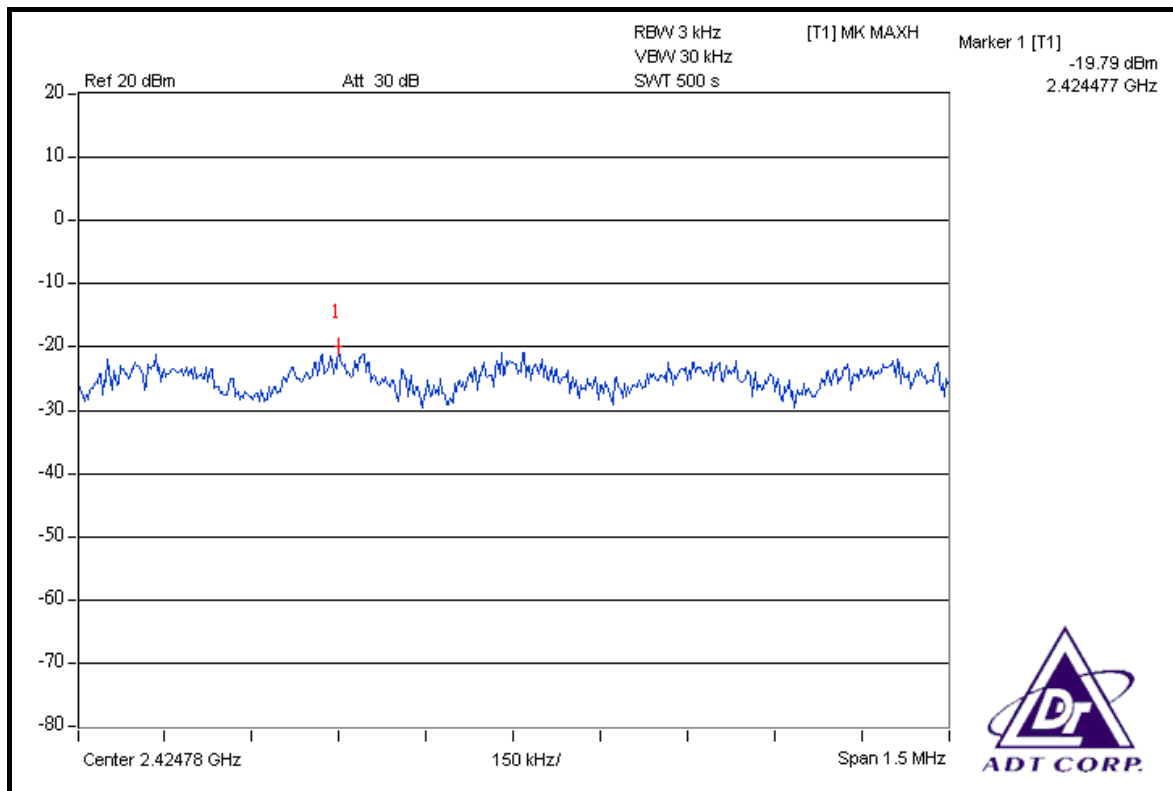



CH 7

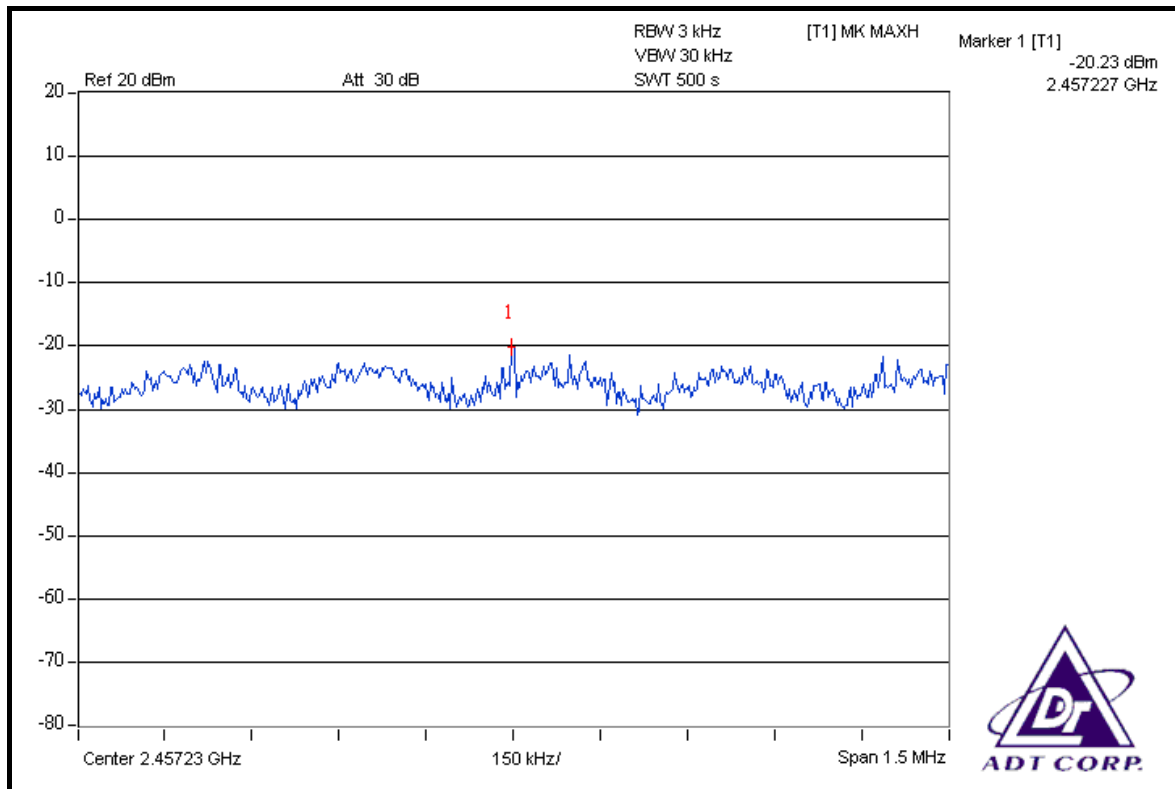

FOR CHAIN 1: CH 1

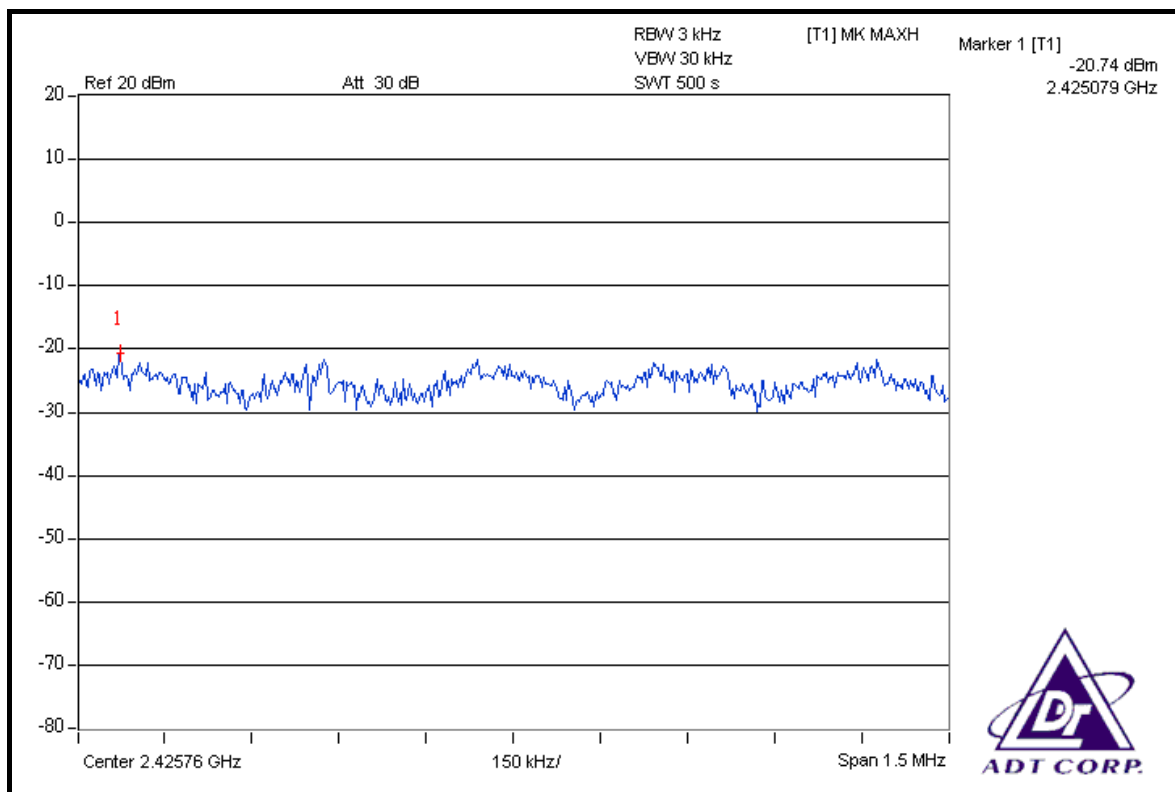

CH 4

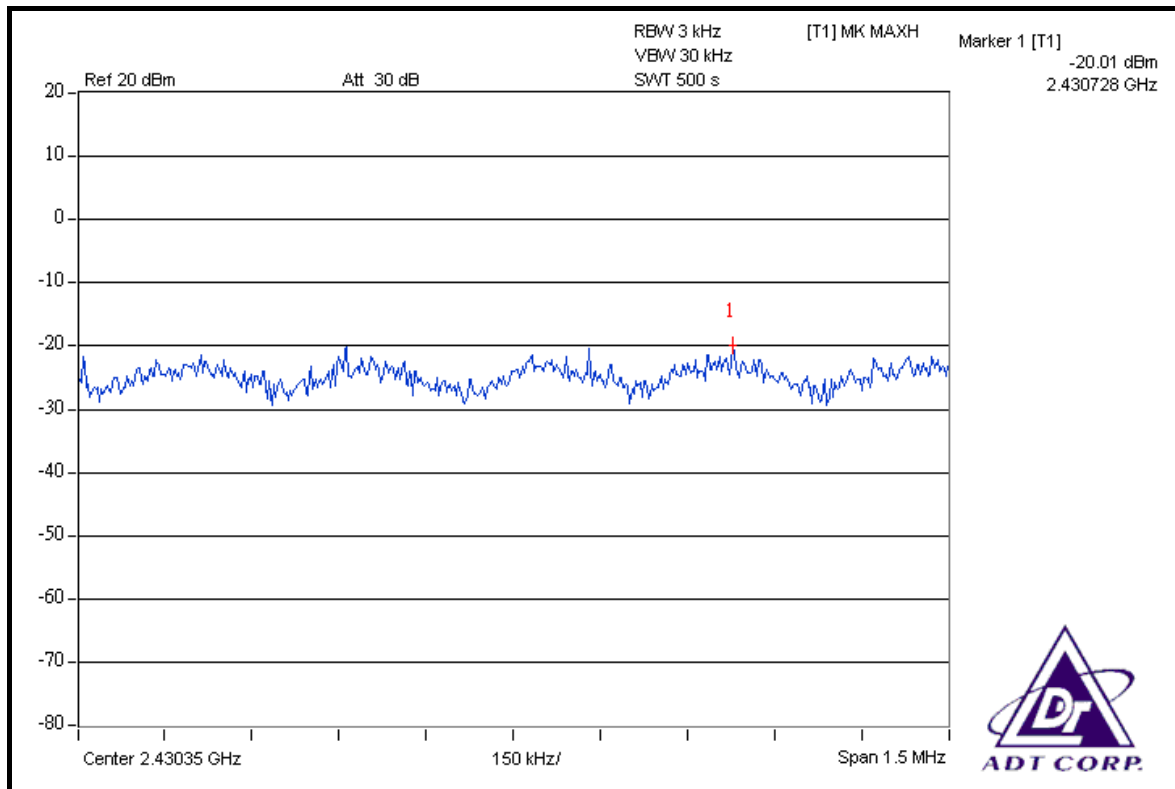

CH 7

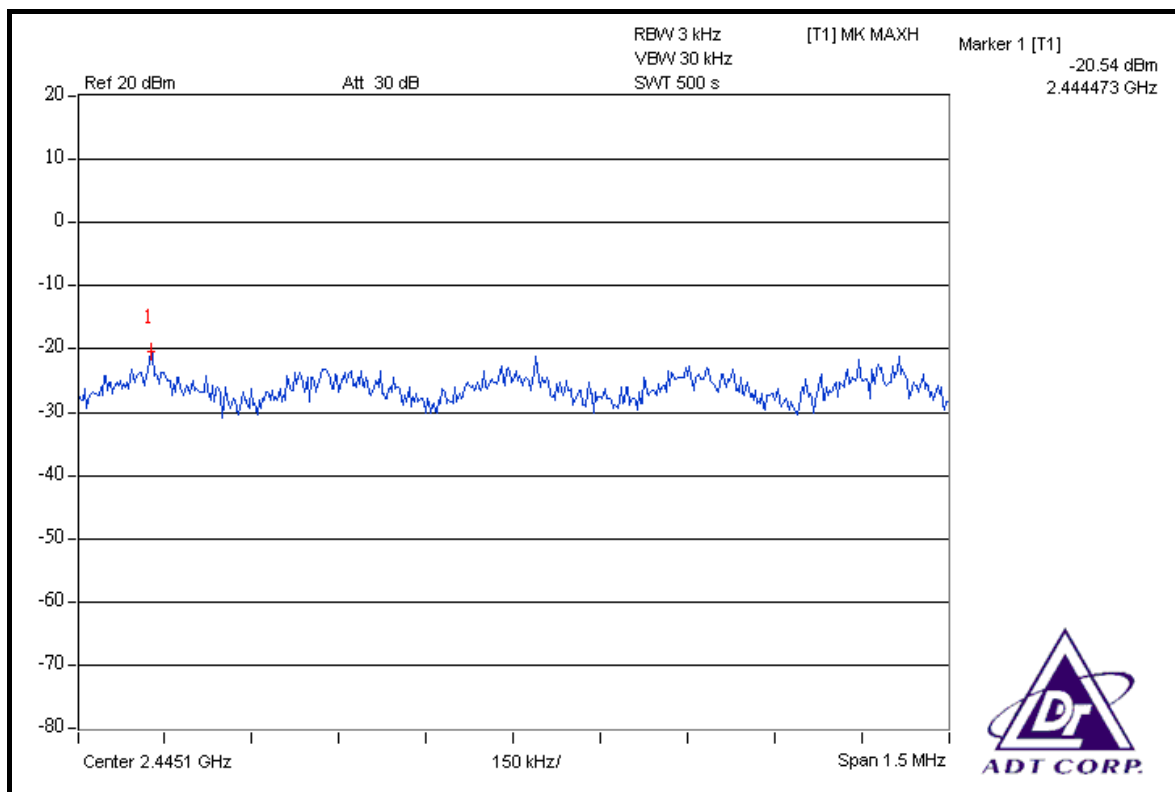



4.6 BAND EDGES MEASUREMENT

4.6.1 LIMITS OF BAND EDGES MEASUREMENT

Below -20dB of the highest emission level of operating band (in 100kHz Resolution Bandwidth).

4.6.2 TEST INSTRUMENTS

DESCRIPTION & MANUFACTURER	MODEL NO.	SERIAL NO.	DATE OF CALIBRATION	CALIBRATED UNTIL
FOR CONDUCTED MEASUREMENT:				
R&S SPECTRUM ANALYZER	FSP40	100041	Apr. 22, 2008	Apr. 21, 2009
FOR RADIATED MEASUREMENT:				
Test Receiver ROHDE & SCHWARZ	ESIB7	100212	May 28, 2008	May 27, 2009
Spectrum Analyzer ROHDE & SCHWARZ	FSP40	100269	Aug. 08, 2008	Aug. 07, 2009
BILOG Antenna SCHWARZBECK	VULB9168	9168-156	Apr. 25, 2008	Apr. 24, 2009
HORN Antenna SCHWARZBECK	BBHA 9170	BBHA9170242	Jan. 07, 2008	Jan. 06, 2009
Preamplifier Agilent	8449B	3008A01911	Sep. 10, 2008	Sep. 09, 2009
Preamplifier Agilent	8447D	2944A10634	Dec. 13, 2007	Dec. 12, 2008
RF signal cable HUBER+SUHNNER	SUCOFLEX 104	274039/223650	Nov. 08, 2007	Nov. 07, 2008
RF signal cable Worken	8D-FB	Cable-HYCH9-01	Aug. 09, 2008	Aug. 08, 2009
Software	ADT_Radiated_V7.6	NA	NA	NA
Antenna Tower EMCO	2070/2080	512.835.4684	NA	NA
Turn Table EMCO	2087-2.03	NA	NA	NA
Antenna Tower & Turn Table Controller EMCO	2090	NA	NA	NA

NOTE: The calibration interval of the above test instruments is 12 months and the calibrations are traceable to NML/ROC and NIST/USA.

4.6.3 TEST PROCEDURE

FOR CONDUCTED MEASUREMENT:

The transmitter output was connected to the spectrum analyzer via a low lose cable. Set both RBW and VBW of spectrum analyzer to 100kHz and 300kHz with suitable frequency span including 100MHz bandwidth from band edge. The band edges was measured and recorded.

The spectrum plots (Peak RBW = 100kHz, VBW = 300kHz) are attached on the following pages.

FOR RADIATED MEASUREMENT:

- a. The EUT was placed on the top of a rotating table 0.8 meters above the ground at a 3 meter semi-anechoic chamber. The table was rotated 360 degrees to determine the position of the highest radiation.
- b. The EUT was set 3 meters away from the interference-receiving antenna, which was mounted on the top of a variable-height antenna tower.
- c. The antenna is a broadband antenna, and its height is varied from one meter to four meters above the ground to determine the maximum value of the field strength. Both horizontal and vertical polarizations of the antenna are set to make the measurement.
- d. For each suspected emission, the EUT was arranged to its worst case and then the antenna was tuned to heights from 1 meter to 4 meters and the rotatable table was turned from 0 degrees to 360 degrees to find the maximum reading.
- e. Set both RBW and VBW of spectrum analyzer to 100kHz and 300kHz with suitable frequency span including 100MHz bandwidth from band edge. The band edges was measured and recorded.

The spectrum plots (Peak RBW = 100kHz, VBW = 300kHz) are attached on the following pages.

NOTE: The resolution bandwidth of test receiver/spectrum analyzer is 1MHz and the video bandwidth is 10Hz for Average detection (AV) at frequency above 1GHz.

4.6.4 DEVIATION FROM TEST STANDARD

No deviation

4.6.5 EUT OPERATING CONDITION

Same as Item 4.3.6

4.6.6 TEST RESULTS

The spectrum plots are attached on the following pages. D1 line indicates the highest level, and D2 line indicates the 20dB offset below D1. It shows compliance with the requirement in part 15.247(d).

802.11b DSSS MODULATION

NOTE 1: The band edge emission plot on the next page shows 48.47dBc between carrier maximum power and local maximum emission in restrict band (2.3900GHz). The emission of carrier strength list in the test result of channel 1 at the item 4.2.7 is 104.43dBuV/m (Peak), so the maximum field strength in restrict band is $104.43 - 48.47 = 55.96$ dBuV/m which is under 74dBuV/m limit.

The band edge emission plot of on the next page shows 53.56dBc between carrier maximum power and local maximum emission in restrict band (2.3600GHz). The emission of carrier strength list in the test result of channel 1 at the item 4.2.7 is 99.63dBuV/m (Average), so the maximum field strength in restrict band is $99.63 - 53.56 = 46.07$ dBuV/m which is under 54dBuV/m limit.

NOTE 2: The band edge emission plot on the next second page shows 50.54dBc between carrier maximum power and local maximum emission in restrict band (2.4880GHz). The emission of carrier strength list in the test result of channel 11 at the item 4.2.7 is 103.62dBuV/m (Peak), so the maximum field strength in restrict band is $103.62 - 50.54 = 53.08$ dBuV/m which is under 74dBuV/m limit.

The band edge emission plot on the next third page shows 54.97dBc between carrier maximum power and local maximum emission in restrict band (2.4880GHz). The emission of carrier strength list in the test result of channel 11 at the item 4.2.7 is 98.93dBuV/m (Average), so the maximum field strength in restrict band is $98.93 - 54.97 = 43.96$ dBuV/m which is under 54dBuV/m limit.

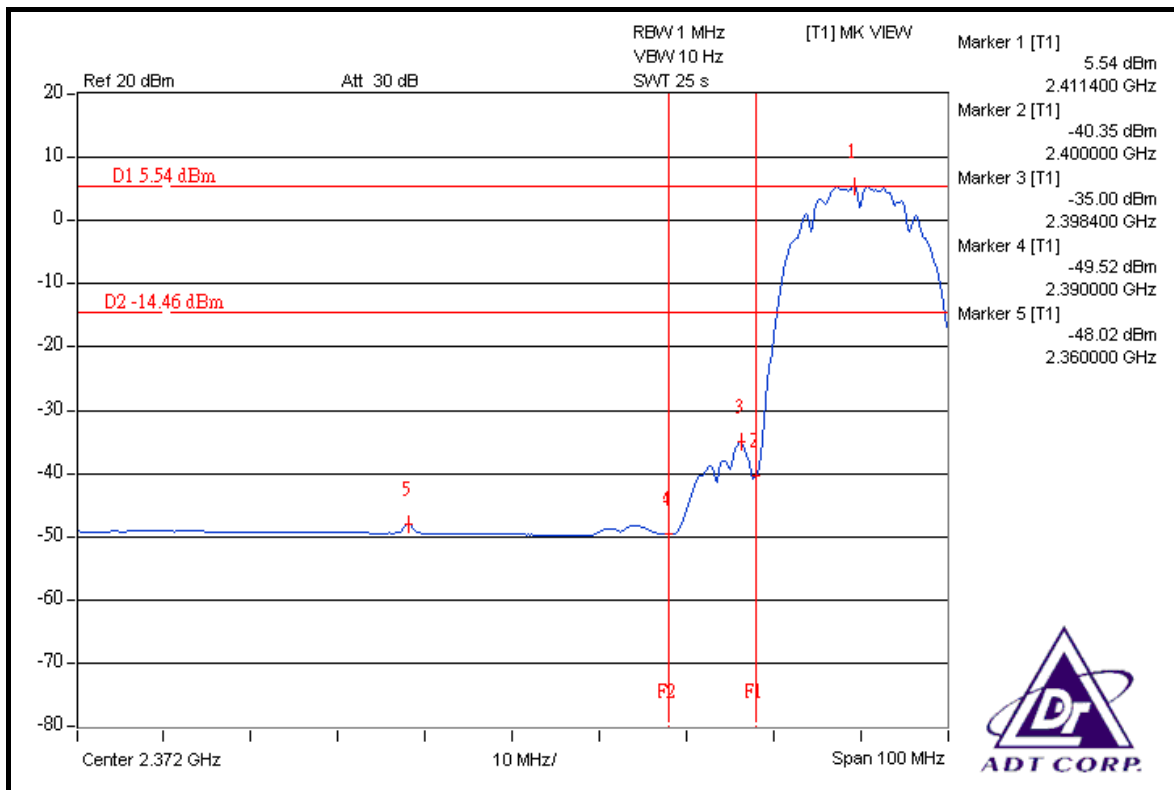
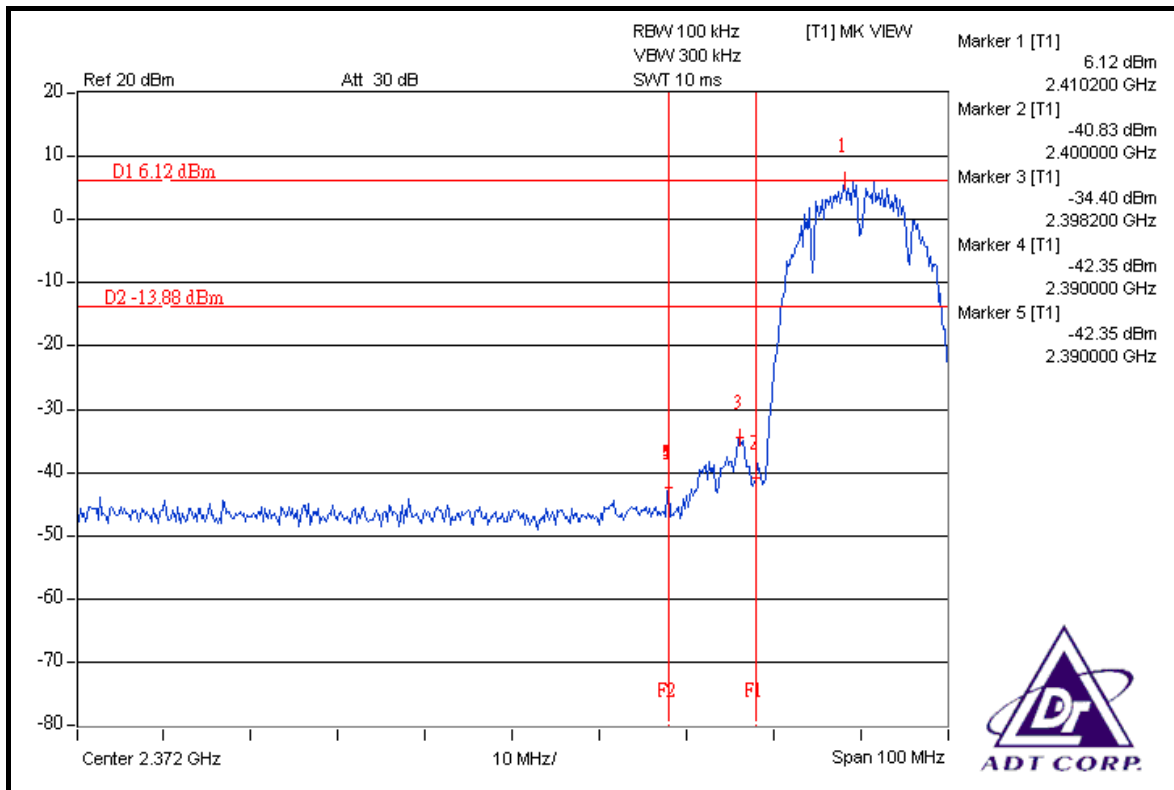

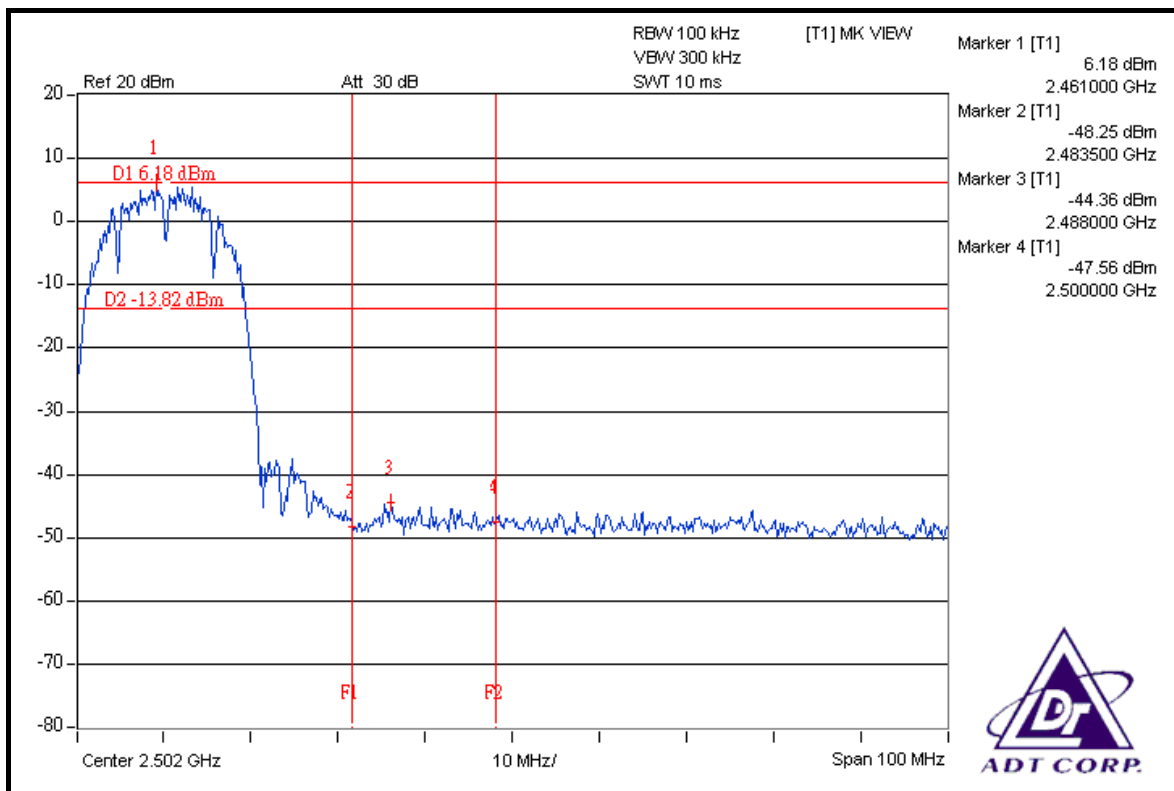
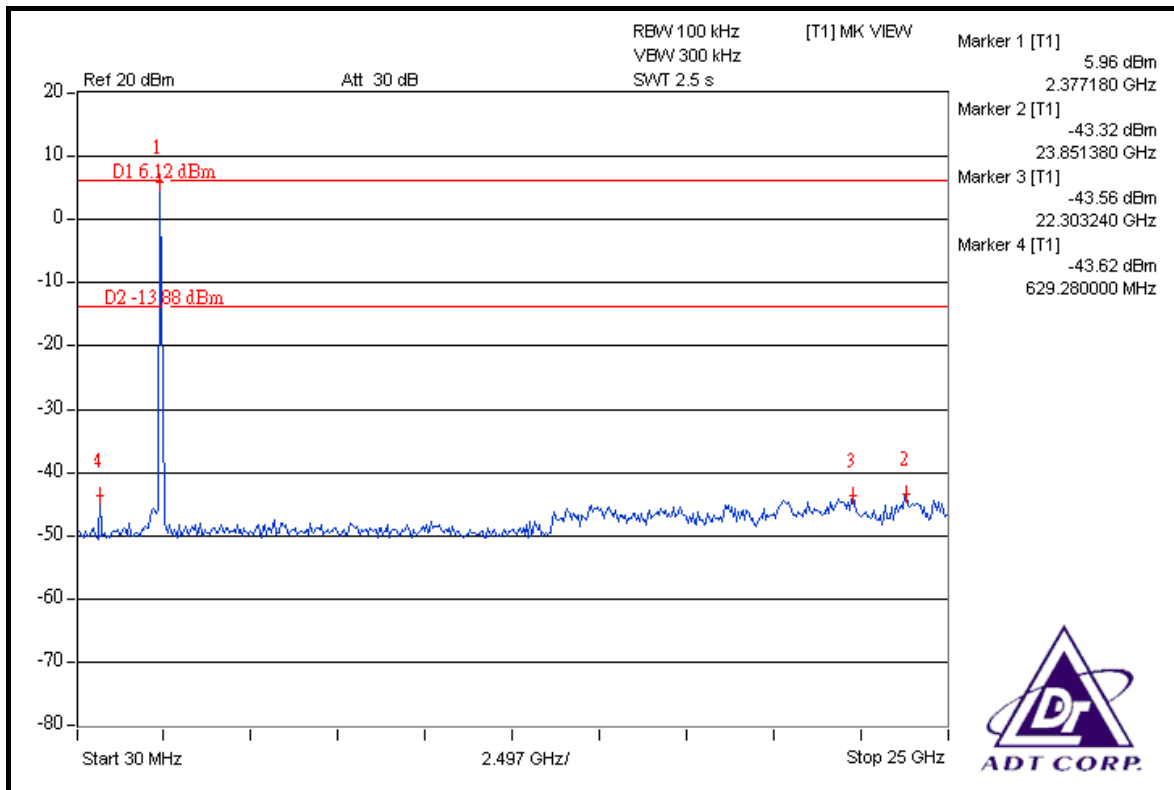

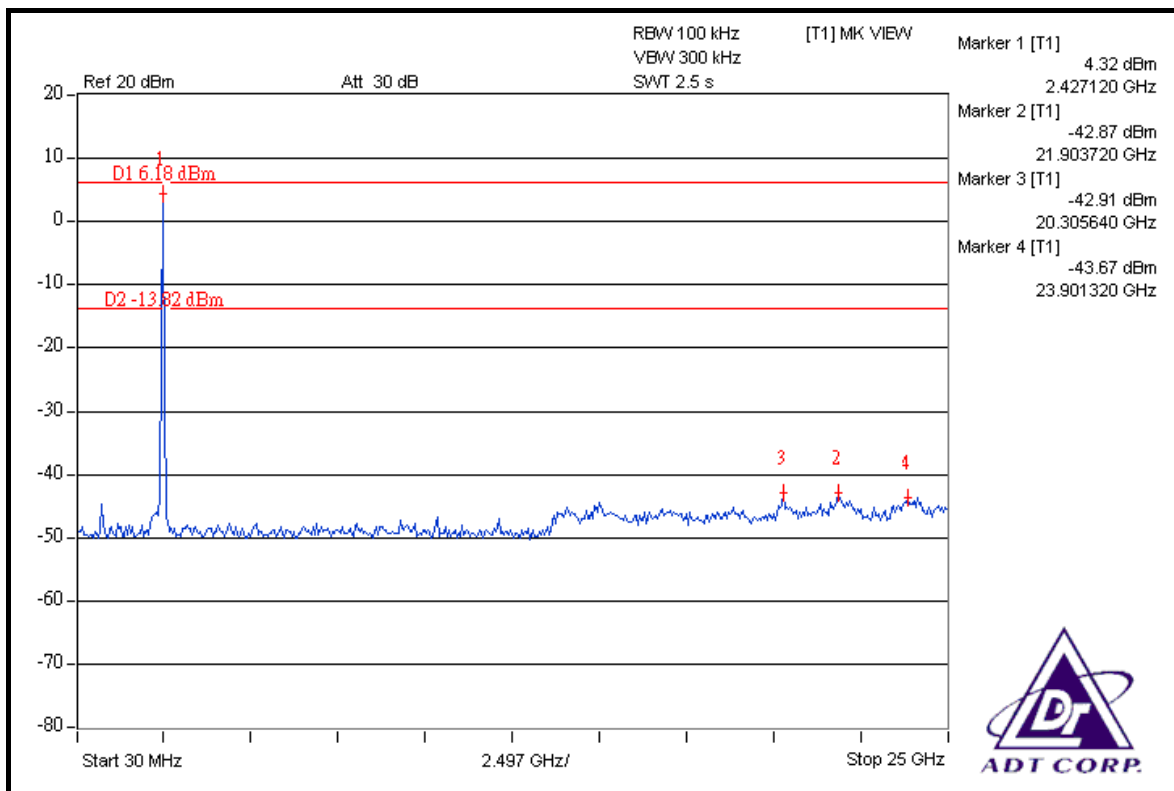
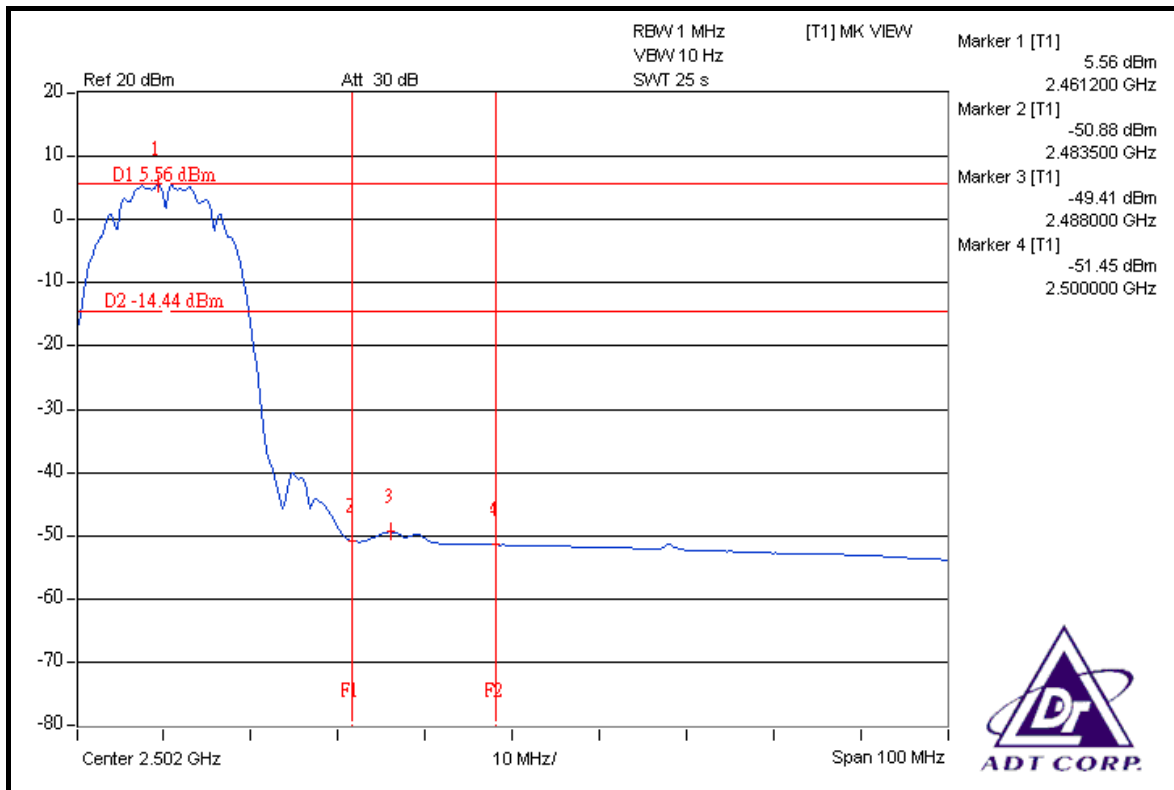

802.11g OFDM MODULATION

NOTE 1: The band edge emission plot on the next page shows 40.70dBc between carrier maximum power and local maximum emission in restrict band (2.3330GHz). The emission of carrier strength list in the test result of channel 1 at the item 4.2.7 is 105.46dBuV/m (Peak), so the maximum field strength in restrict band is $105.46 - 40.70 = 64.76$ dBuV/m which is under 74dBuV/m limit.

The band edge emission plot of on the next page shows 47.52dBc between carrier maximum power and local maximum emission in restrict band (2.3308GHz). The emission of carrier strength list in the test result of channel 1 at the item 4.2.7 is 95.55dBuV/m (Average), so the maximum field strength in restrict band is $95.55 - 47.52 = 48.03$ dBuV/m which is under 54dBuV/m limit.

NOTE 2: The band edge emission plot on the next second page shows 41.48dBc between carrier maximum power and local maximum emission in restrict band (2.4852GHz). The emission of carrier strength list in the test result of channel 11 at the item 4.2.7 is 105.67dBuV/m (Peak), so the maximum field strength in restrict band is $105.67 - 41.48 = 64.19$ dBuV/m which is under 74dBuV/m limit.

The band edge emission plot on the next third page shows 50.06dBc between carrier maximum power and local maximum emission in restrict band (2.4864GHz). The emission of carrier strength list in the test result of channel 11 at the item 4.2.7 is 95.80dBuV/m (Average), so the maximum field strength in restrict band is $95.80 - 50.06 = 45.74$ dBuV/m which is under 54dBuV/m limit.

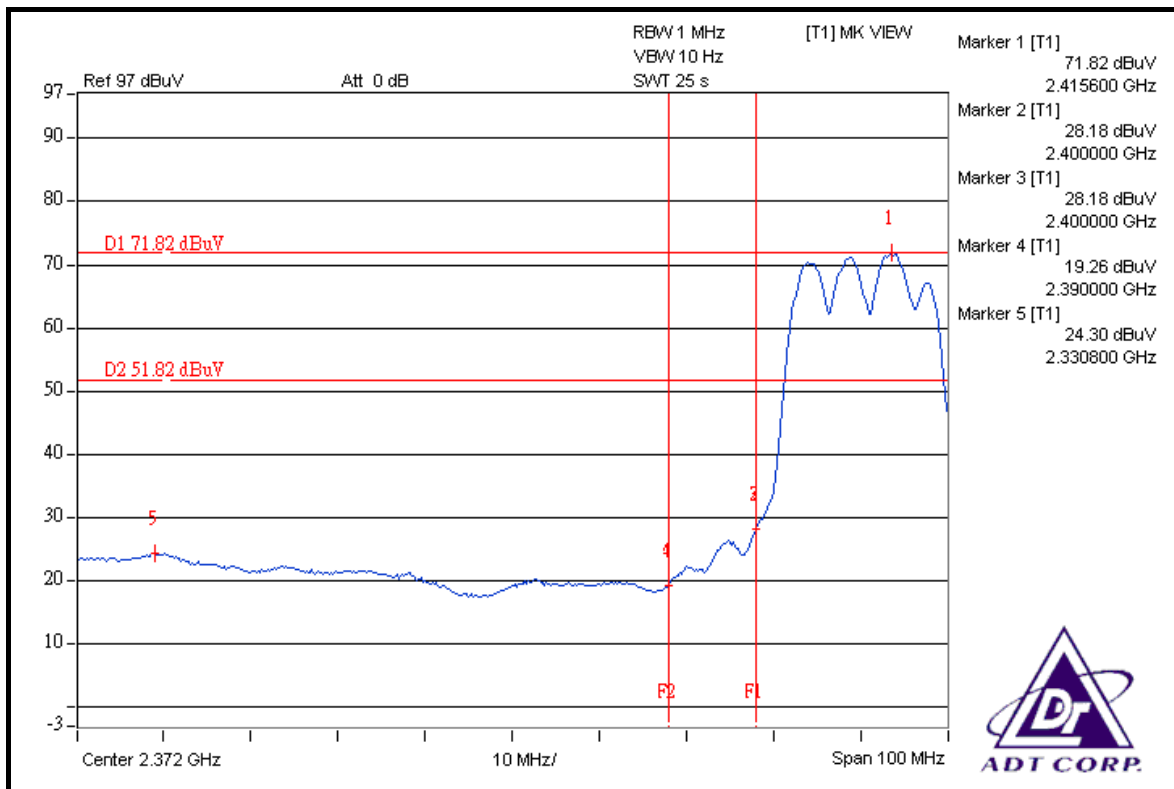
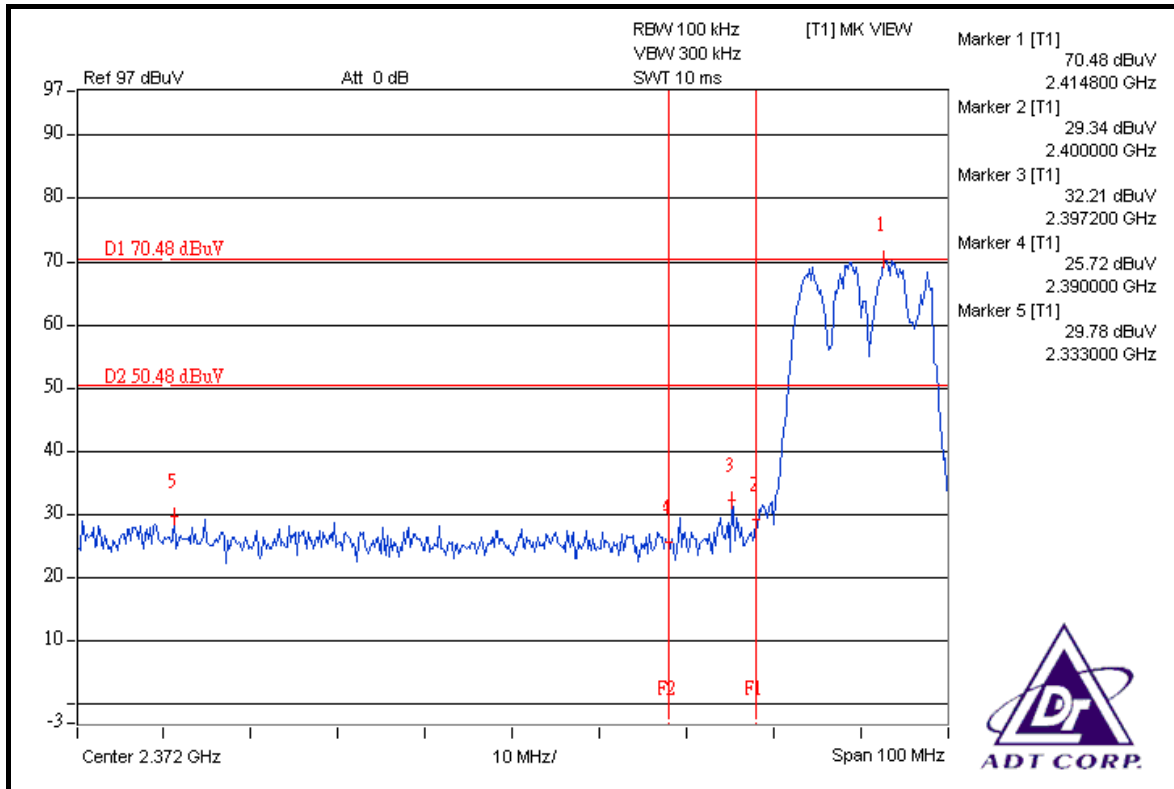

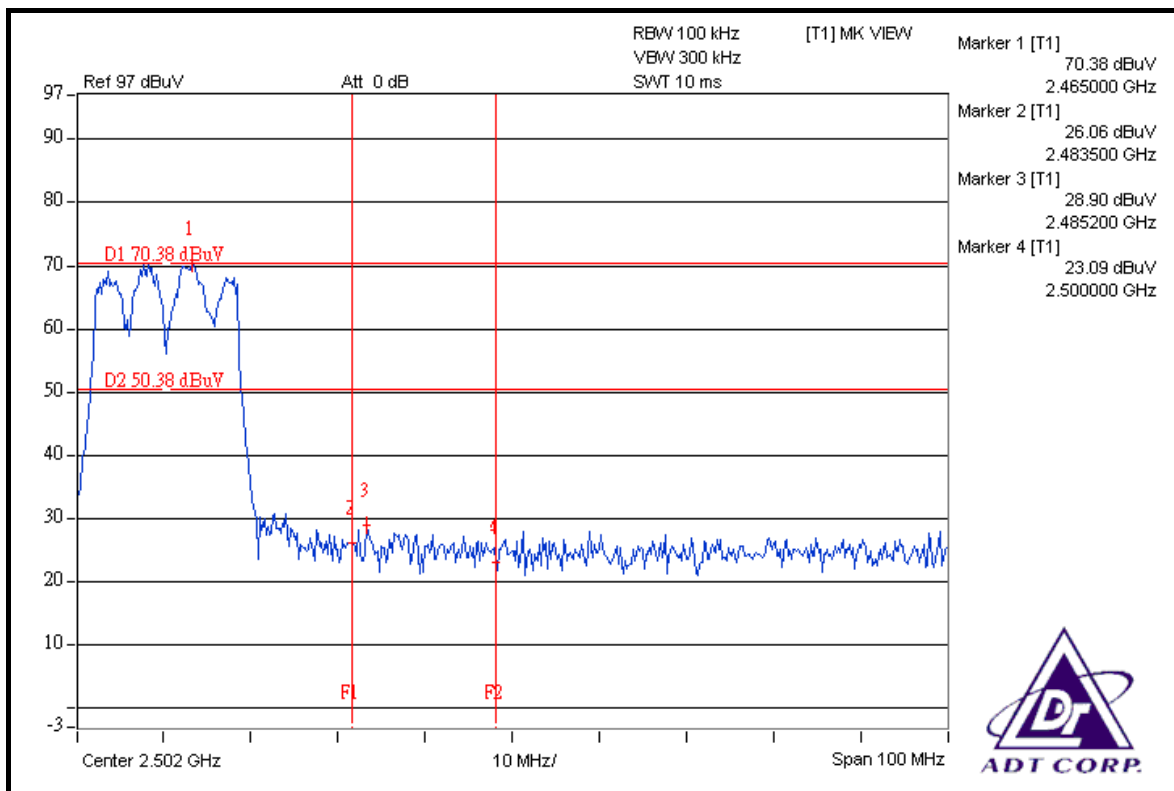
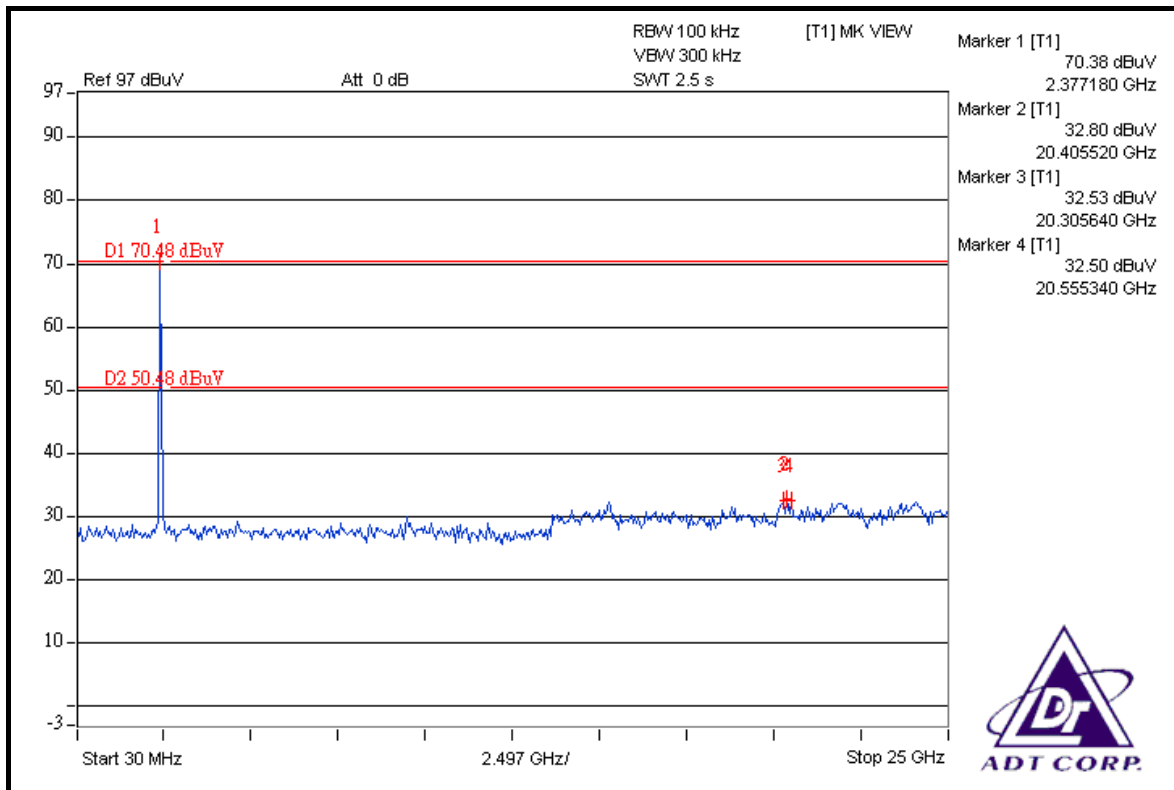

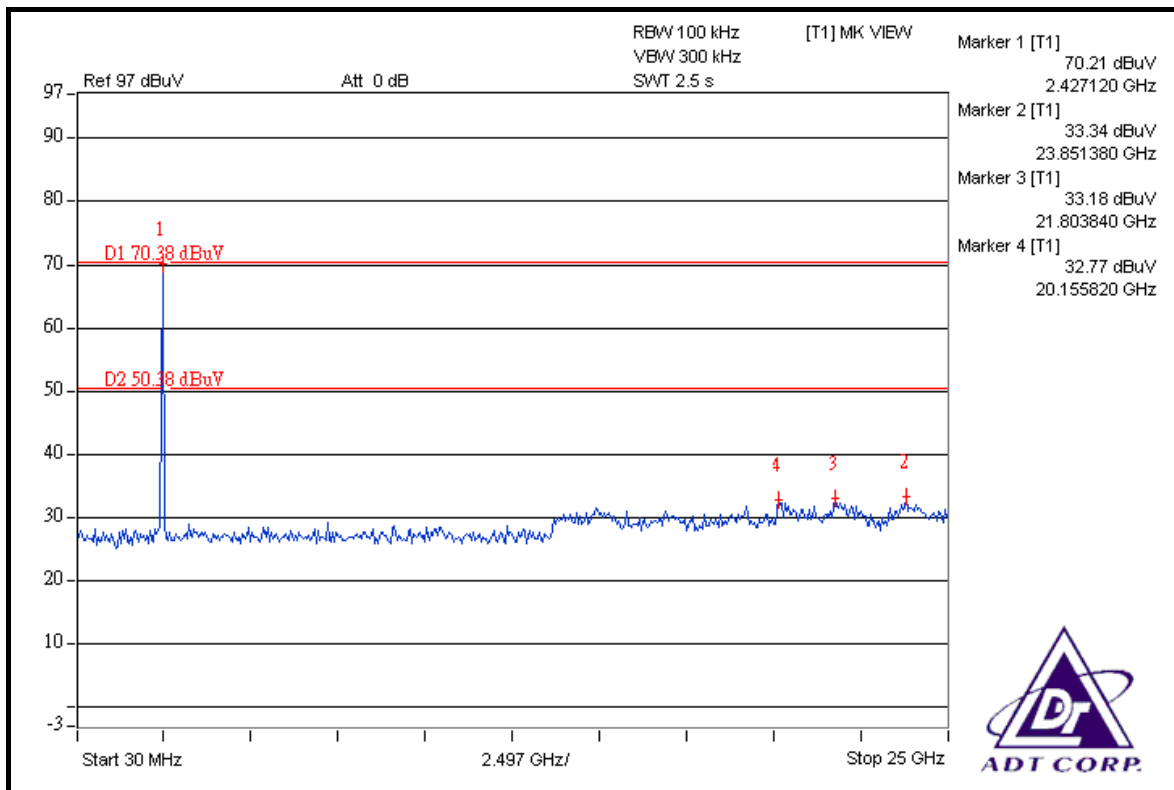
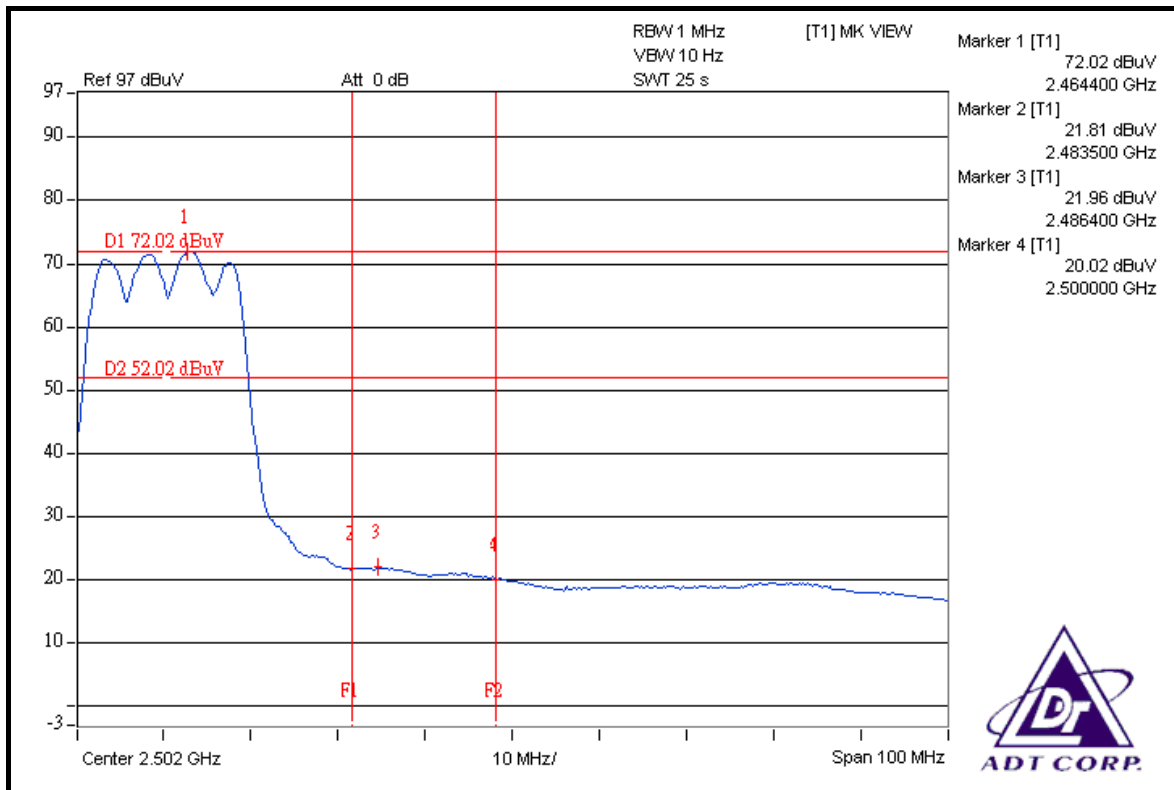

DRAFT 802.11n (20MHz) OFDM MODULATION

NOTE 1: The band edge emission plot on the next page shows 38.25dBc between carrier maximum power and local maximum emission in restrict band (2.3232GHz). The emission of carrier strength list in the test result of channel 1 at the item 4.2.7 is 102.07dBuV/m (Peak), so the maximum field strength in restrict band is $102.07 - 38.25 = 63.82$ dBuV/m which is under 74dBuV/m limit.

The band edge emission plot of on the next page shows 45.12dBc between carrier maximum power and local maximum emission in restrict band (2.3310GHz). The emission of carrier strength list in the test result of channel 1 at the item 4.2.7 is 92.73dBuV/m (Average), so the maximum field strength in restrict band is $92.73 - 45.12 = 47.61$ dBuV/m which is under 54dBuV/m limit.

NOTE 2: The band edge emission plot on the next second page shows 39.16dBc between carrier maximum power and local maximum emission in restrict band (2.4898GHz). The emission of carrier strength list in the test result of channel 11 at the item 4.2.7 is 102.56dBuV/m (Peak), so the maximum field strength in restrict band is $102.56 - 39.16 = 63.40$ dBuV/m which is under 74dBuV/m limit.

The band edge emission plot on the next third page shows 48.88dBc between carrier maximum power and local maximum emission in restrict band (2.4838GHz). The emission of carrier strength list in the test result of channel 11 at the item 4.2.7 is 93.03dBuV/m (Average), so the maximum field strength in restrict band is $93.03 - 48.88 = 44.15$ dBuV/m which is under 54dBuV/m limit.

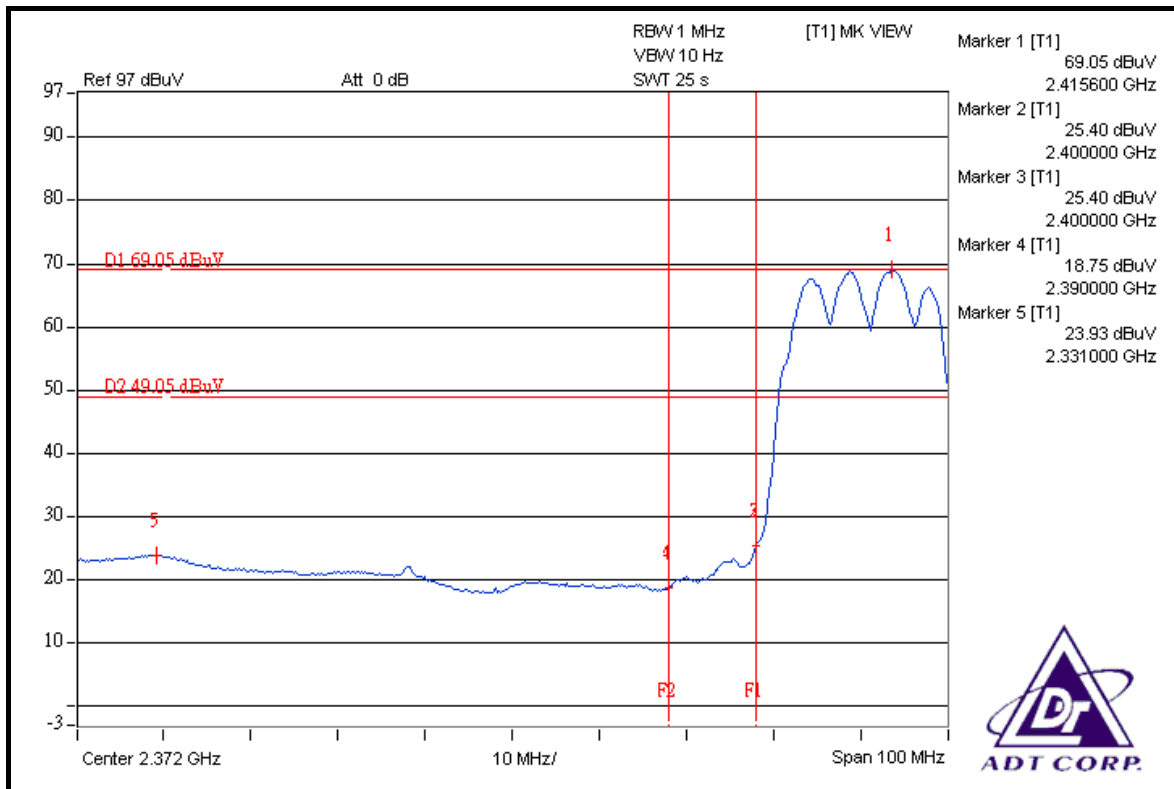
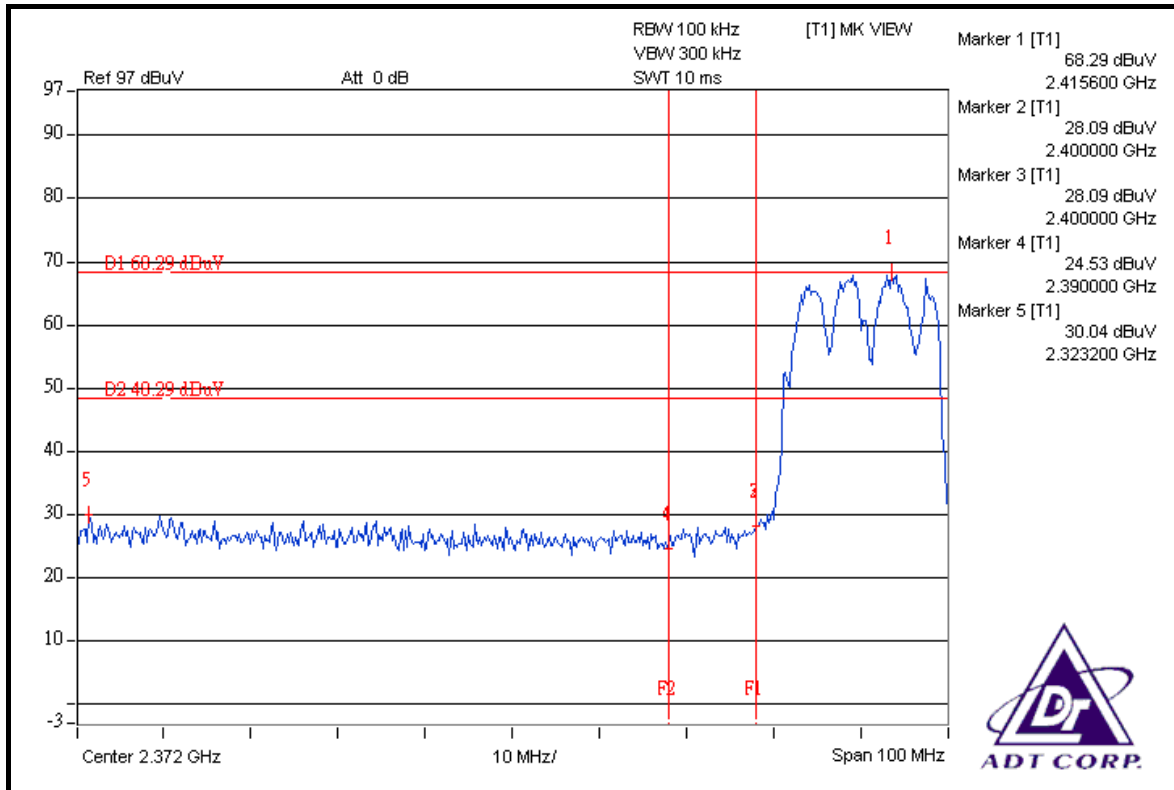

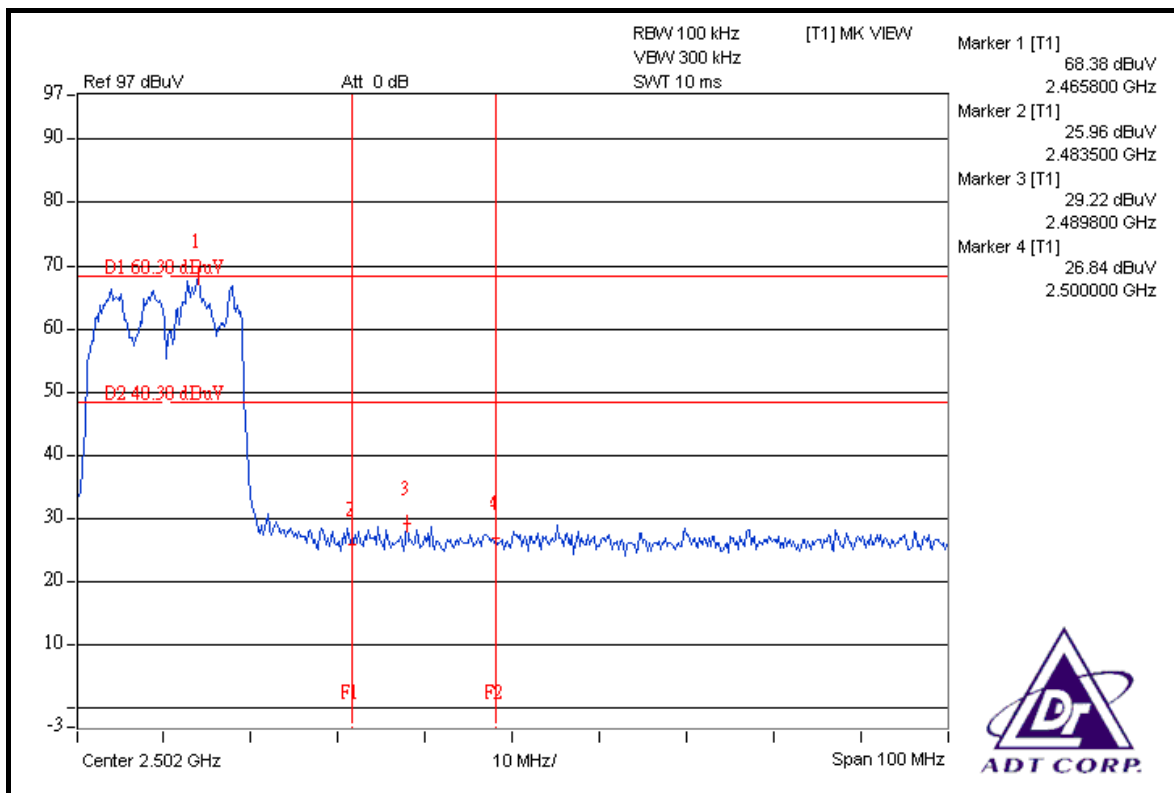
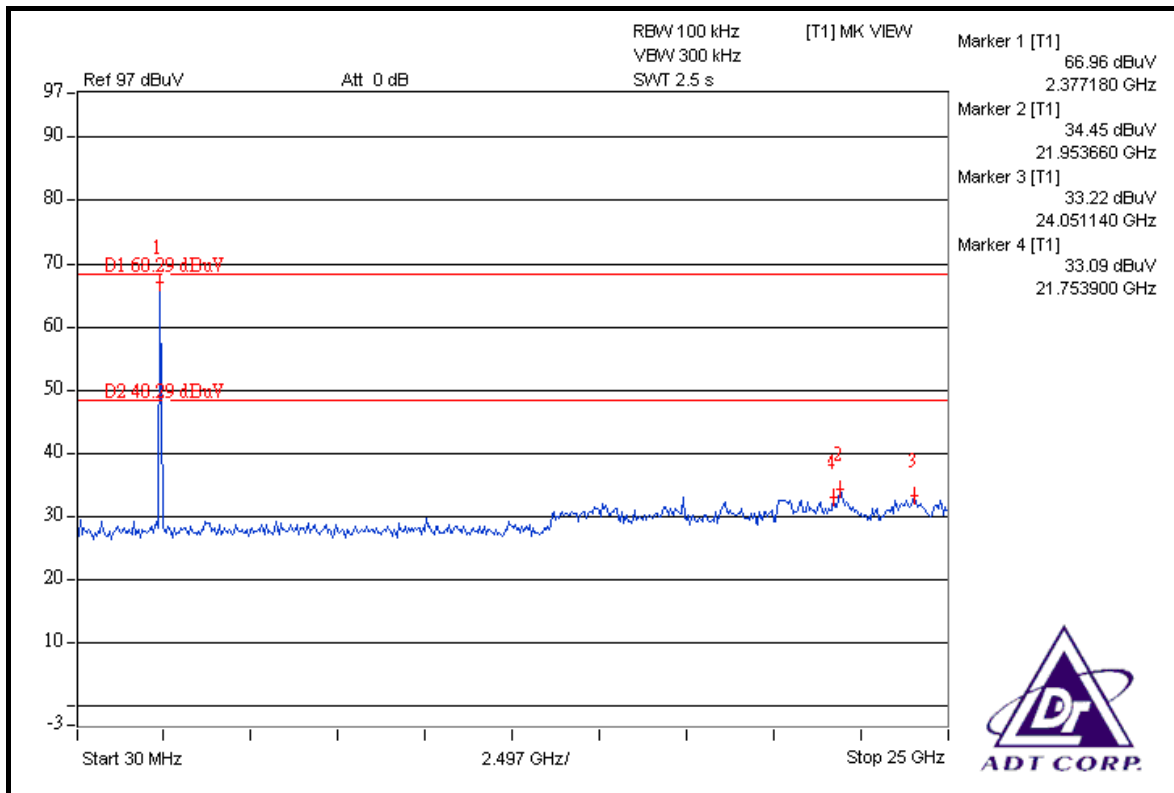

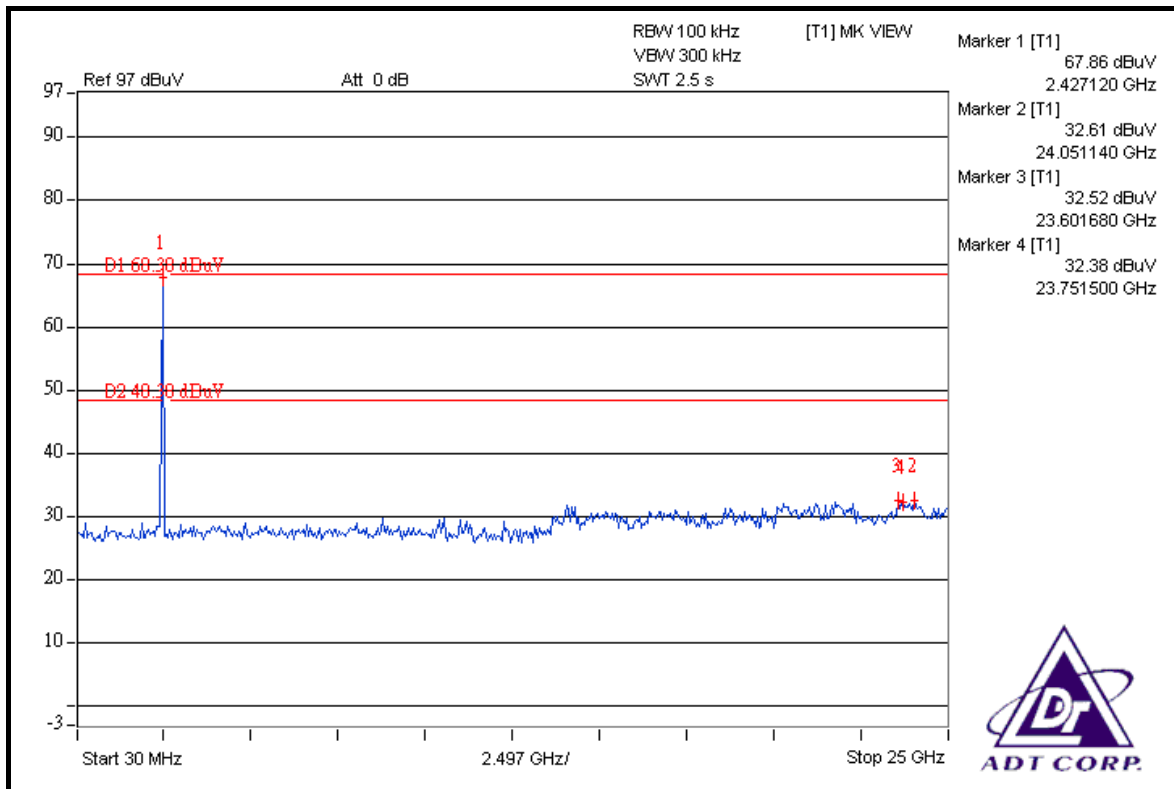
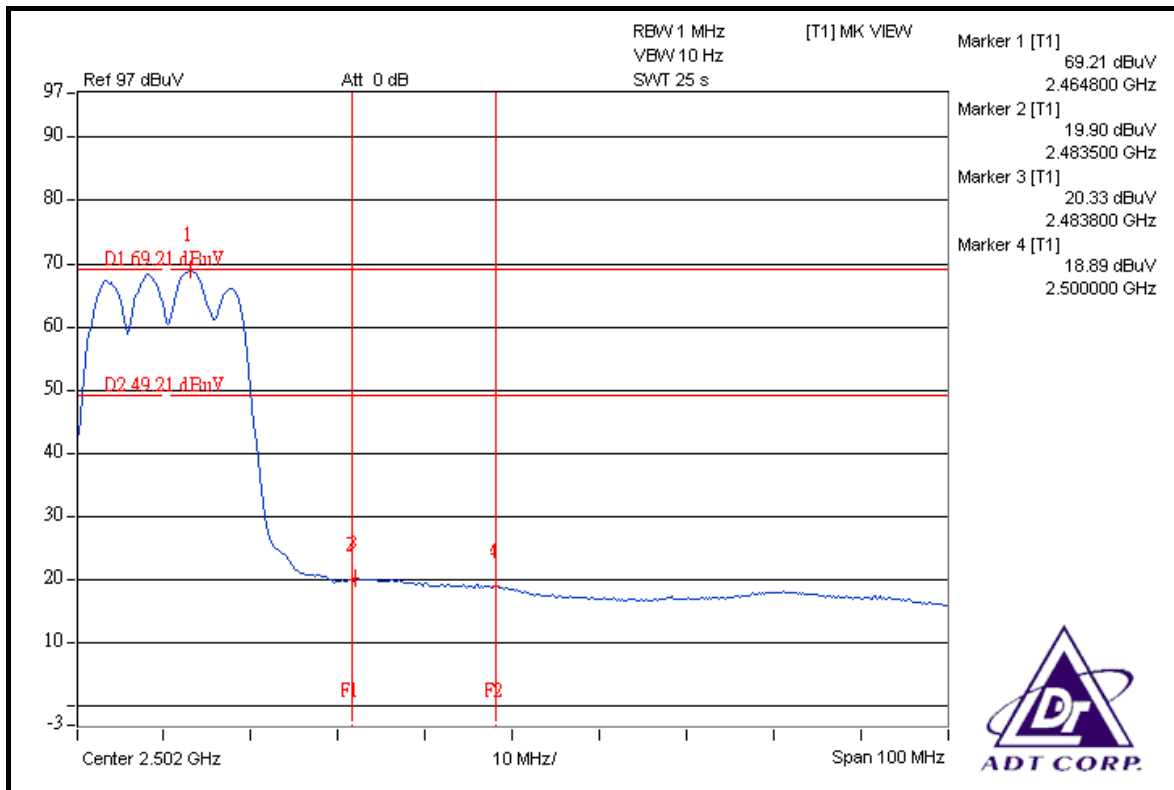

DRAFT 802.11n (40MHz) OFDM MODULATION

NOTE 1: The band edge emission plot on the next page shows 35.40dBc between carrier maximum power and local maximum emission in restrict band (2.3212GHz). The emission of carrier strength list in the test result of channel 1 at the item 4.2.7 is 100.15dBuV/m (Peak), so the maximum field strength in restrict band is $100.15 - 35.40 = 64.75$ dBuV/m which is under 74dBuV/m limit.

The band edge emission plot of on the next page shows 43.00dBc between carrier maximum power and local maximum emission in restrict band (2.3300GHz). The emission of carrier strength list in the test result of channel 1 at the item 4.2.7 is 90.13dBuV/m (Average), so the maximum field strength in restrict band is $90.13 - 43.00 = 47.13$ dBuV/m which is under 54dBuV/m limit.

NOTE 2: The band edge emission plot on the next second page shows 38.04dBc between carrier maximum power and local maximum emission in restrict band (2.4852GHz). The emission of carrier strength list in the test result of channel 7 at the item 4.2.7 is 100.22dBuV/m (Peak), so the maximum field strength in restrict band is $100.22 - 38.04 = 62.18$ dBuV/m which is under 74dBuV/m limit.

The band edge emission plot on the next third page shows 44.51dBc between carrier maximum power and local maximum emission in restrict band (2.4852GHz). The emission of carrier strength list in the test result of channel 7 at the item 4.2.7 is 89.74dBuV/m (Average), so the maximum field strength in restrict band is $89.74 - 44.51 = 45.23$ dBuV/m which is under 54dBuV/m limit.

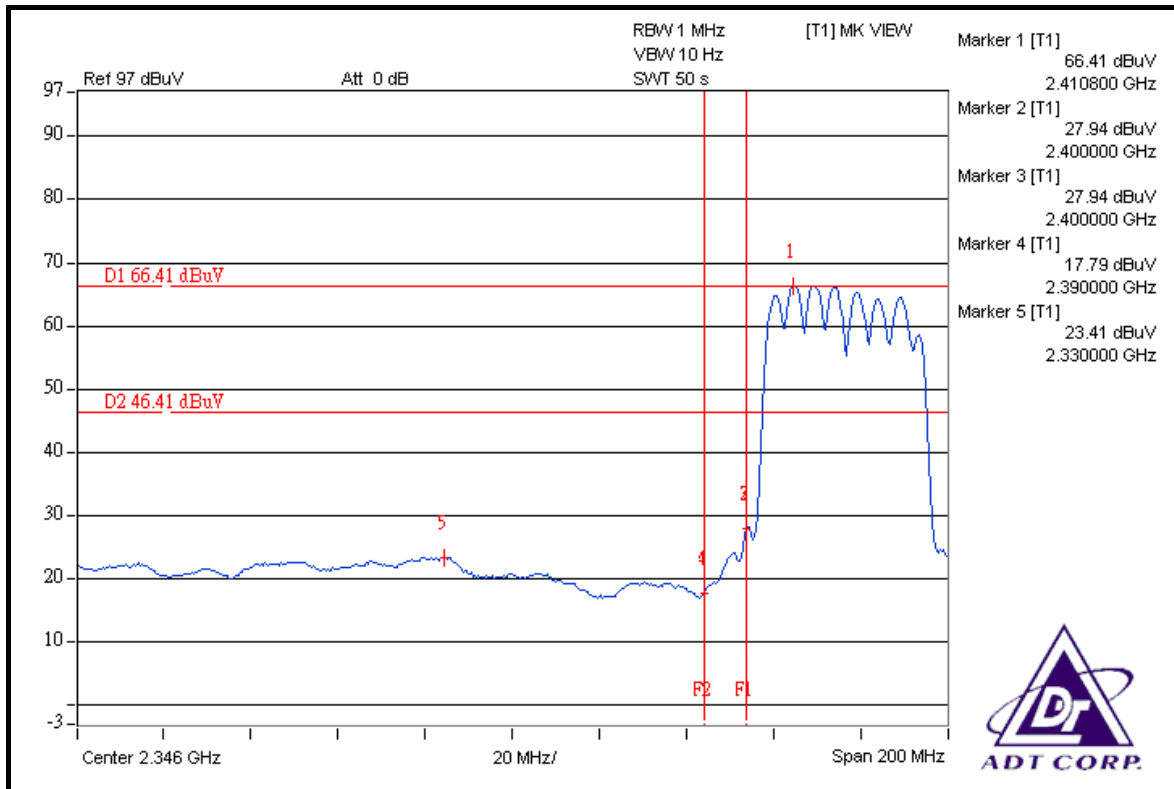
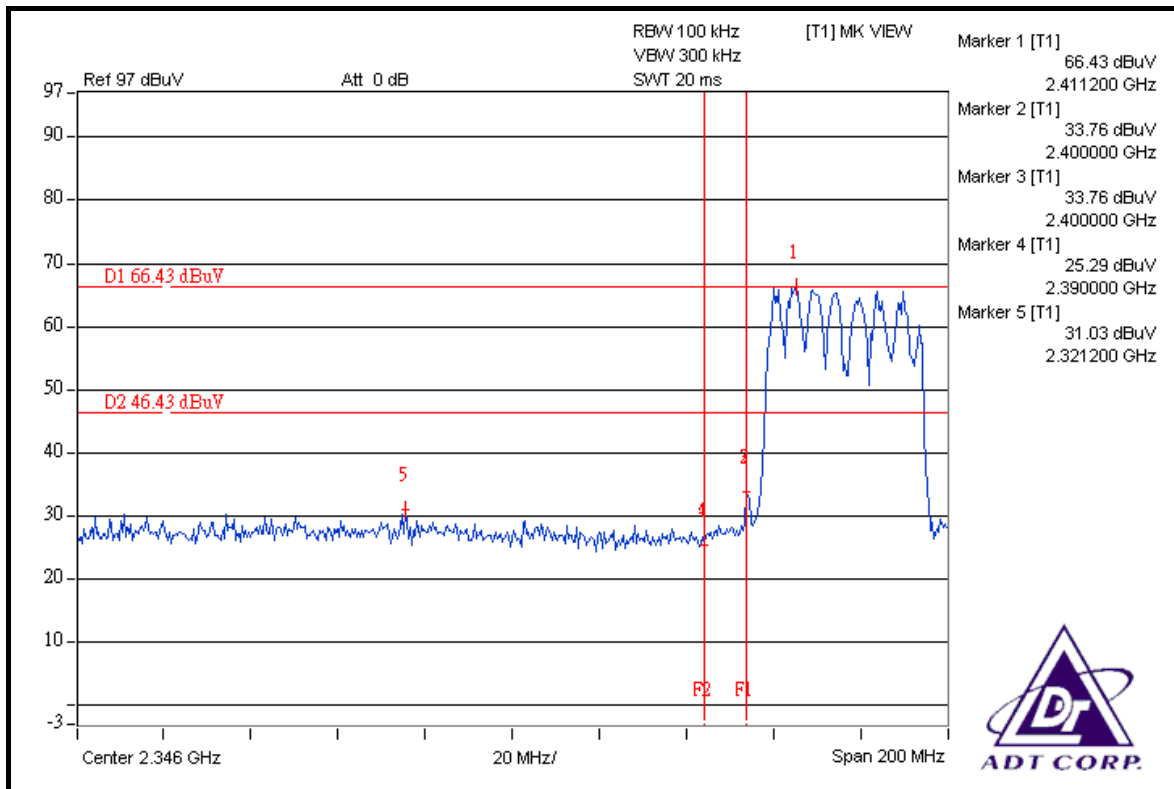

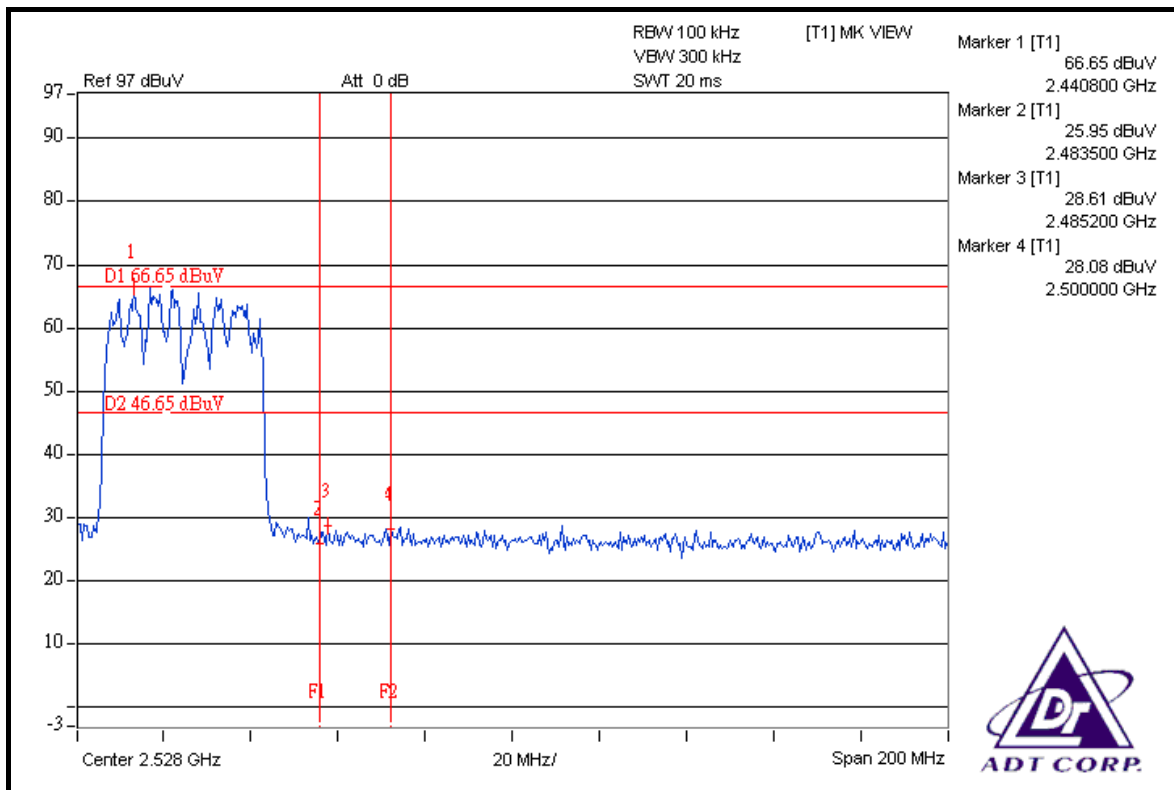
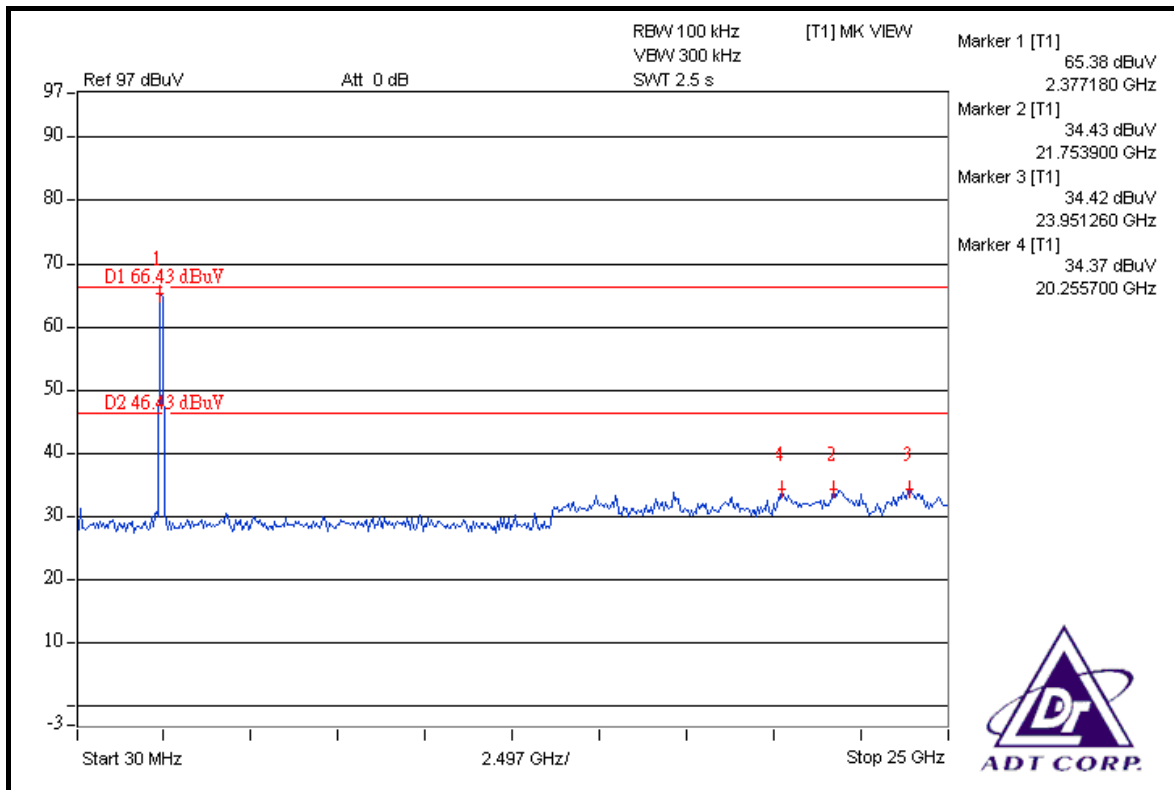

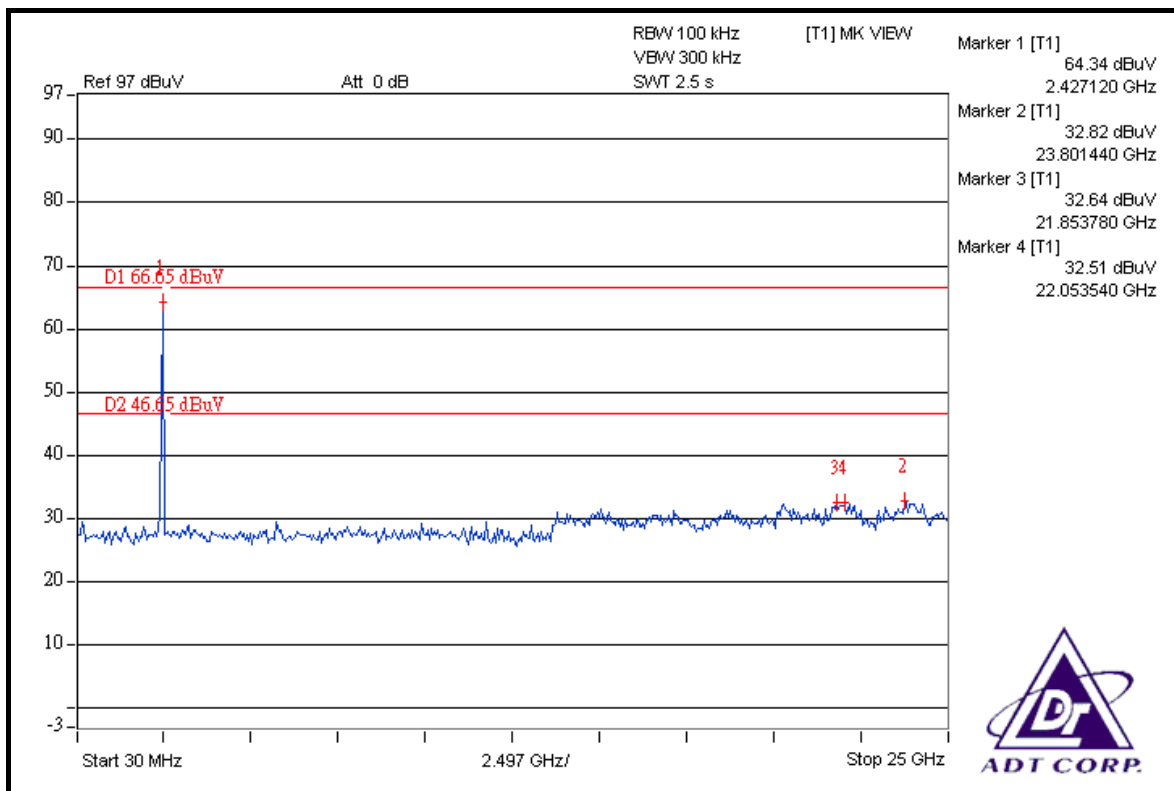
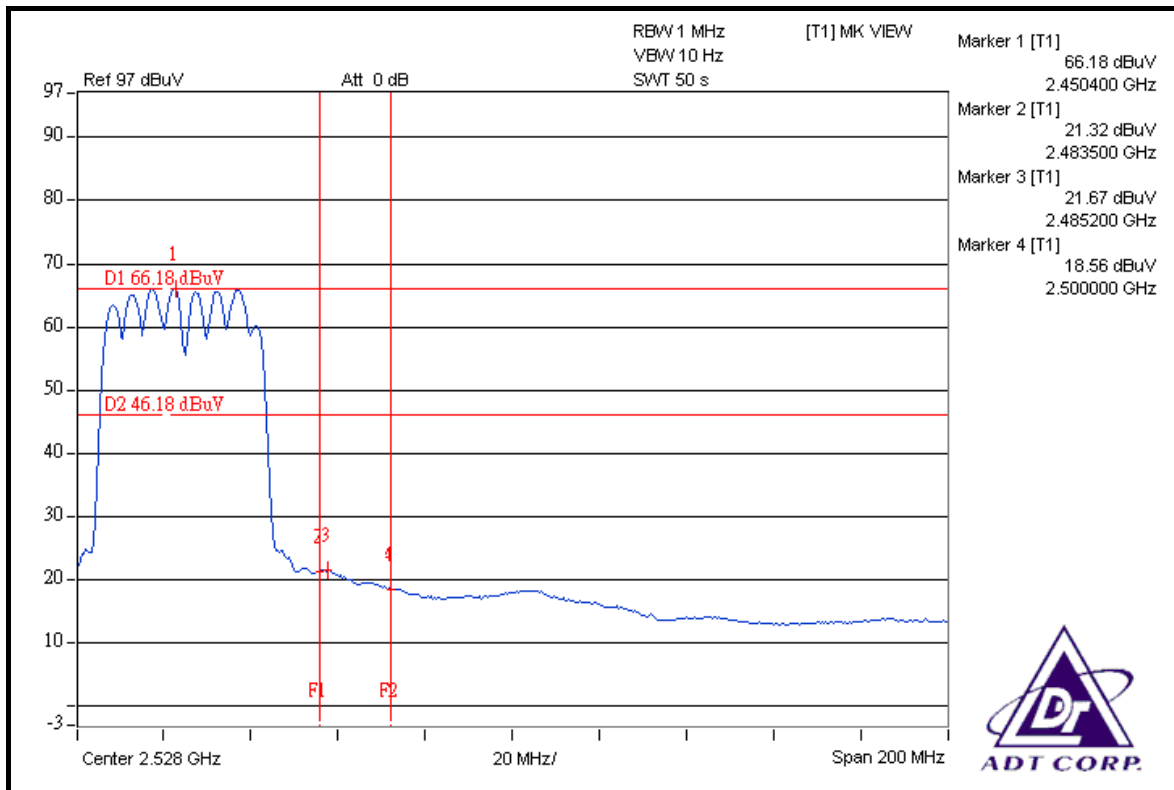



4.7 ANTENNA REQUIREMENT

4.7.1 STANDARD APPLICABLE

For intentional device, according to FCC 47 CFR Section 15.203, an intentional radiator shall be designed to ensure that no antenna other than that furnished by the responsible party shall be used with the device.

And according to FCC 47 CFR Section 15.247 (b), if transmitting antennas of directional gain greater than 6dBi are used, the power shall be reduced by the amount in dB that the directional gain of the antenna exceeds 6dBi.

4.7.2 ANTENNA CONNECTED CONSTRUCTION

The antenna used in this product is PIFA antenna without connector. The maximum Gain of the antenna is 1dBi.

5. TEST TYPES AND RESULTS (FOR 5.0GHz BAND)

5.1 RADIATED EMISSION MEASUREMENT

5.1.1 LIMITS OF RADIATED EMISSION MEASUREMENT

Emissions radiated outside of the specified bands, shall be according to the general radiated limits in 15.209 as following:

FREQUENCIES (MHz)	FIELD STRENGTH (microvolts/meter)	MEASUREMENT DISTANCE (meters)
0.009 ~ 0.490	2400/F(kHz)	300
0.490 ~ 1.705	24000/F(kHz)	30
1.705 ~ 30.0	30	30
30 ~ 88	100	3
88 ~ 216	150	3
216 ~ 960	200	3
Above 960	500	3

NOTE:

1. The lower limit shall apply at the transition frequencies.
2. Emission level (dBuV/m) = 20 log Emission level (uV/m).
3. As shown in 15.35(b), for frequencies above 1000MHz, the field strength limits are based on average detector, however, the peak field strength of any emission shall not exceed the maximum permitted average limits, specified above by more than 20dB under any condition of modulation.



5.1.2 TEST INSTRUMENTS

DESCRIPTION & MANUFACTURER	MODEL NO.	SERIAL NO.	DATE OF CALIBRATION	DUE DATE OF CALIBRATION
Test Receiver ROHDE & SCHWARZ	ESIB7	100212	May 28, 2008	May 27, 2009
Spectrum Analyzer ROHDE & SCHWARZ	FSP40	100269	Aug. 08, 2008	Aug. 07, 2009
BILOG Antenna SCHWARZBECK	VULB9168	9168-156	Apr. 25, 2008	Apr. 24, 2009
HORN Antenna SCHWARZBECK	BBHA 9120 D	9120D-563	Aug. 06, 2008	Aug. 05, 2009
HORN Antenna SCHWARZBECK	BBHA 9170	BBHA9170242	Jan. 07, 2008	Jan. 06, 2009
Preamplifier Agilent	8449B	3008A01911	Sep. 10, 2008	Sep. 09, 2009
Preamplifier Agilent	8447D	2944A10634	Dec. 13, 2007	Dec. 12, 2008
RF signal cable HUBER+SUHNNER	SUCOFLEX 104	274039/223650	Nov. 08, 2007	Nov. 07, 2008
RF signal cable Worken	8D-FB	Cable-HYCH9-01	Aug. 09, 2008	Aug. 08, 2009
Software	ADT_Radiated_V7.6	NA	NA	NA
Antenna Tower EMCO	2070/2080	512.835.4684	NA	NA
Turn Table EMCO	2087-2.03	NA	NA	NA
Antenna Tower & Turn Table Controller EMCO	2090	NA	NA	NA
26GHz ~ 40GHz Amplifier	EM26400	07026401	Aug. 27, 2008	Aug. 26, 2009

- NOTE:**
1. The calibration interval of the above test instruments is 12 months and the calibrations are traceable to NML/ROC and NIST/USA.
 2. The test was performed in HwaYa Chamber 9.
 3. The horn antenna and HP preamplifier (model: 8449B) are used only for the measurement of emission frequency above 1GHz if tested.
 4. The FCC Site Registration No. is 215374.
 5. The IC Site Registration No. is IC3789B-9.

5.1.3 TEST PROCEDURES

- a. The EUT was placed on the top of a rotating table 0.8 meters above the ground at a 3 meters semi-anechoic chamber. The table was rotated 360 degrees to determine the position of the highest radiation.
- b. The EUT was set 3 meters away from the interference-receiving antenna, which was mounted on the top of a variable-height antenna tower.
- c. The antenna is a broadband antenna, and its height is varied from one meter to four meters above the ground to determine the maximum value of the field strength. Both horizontal and vertical polarizations of the antenna are set to make the measurement.
- d. For each suspected emission, the EUT was arranged to its worst case and then the antenna was tuned to heights from 1 meter to 4 meters and the rotatable table was turned from 0 degrees to 360 degrees to find the maximum reading.
- e. The test-receiver system was set to Peak Detect Function and Specified Bandwidth with Maximum Hold Mode.
- f. If the emission level of the EUT in peak mode was lower than the limit specified, then testing could be stopped and the peak values of the EUT would be reported. Otherwise the emissions would be re-tested one by one using peak, quasi-peak or average method as specified and then reported in a data sheet.

NOTE:

1. The resolution bandwidth and video bandwidth of test receiver/spectrum analyzer is 120kHz for Quasi-peak detection at frequency below 1GHz.
2. The resolution bandwidth of test receiver/spectrum analyzer is 1MHz and video bandwidth is 3MHz for Peak detection at frequency above 1GHz.
3. The resolution bandwidth of test receiver/spectrum analyzer is 1MHz and the video bandwidth is 10Hz for Average detection (AV) at frequency above 1GHz.
4. All modes of operation were investigated and the worst-case emissions are reported.

5.1.4 DEVIATION FROM TEST STANDARD

No deviation

5.1.5 TEST SETUP

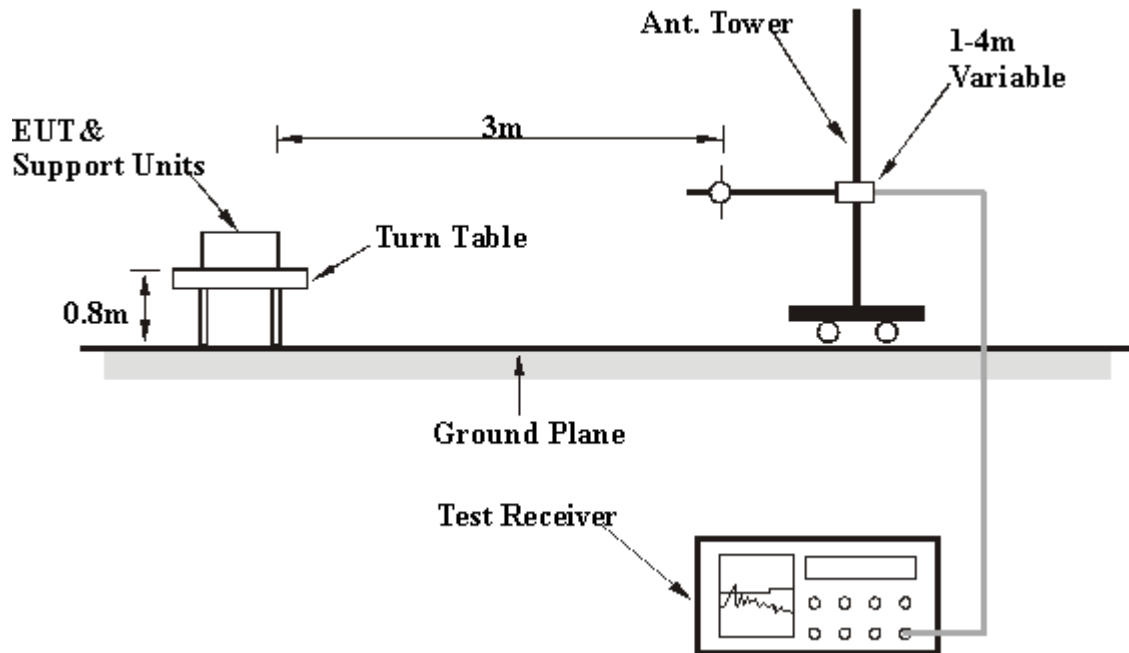

For the actual test configuration, please refer to the attached file (Test Setup Photo).

5.1.6 EUT OPERATING CONDITIONS

Same as 4.1.6

5.1.7 TEST RESULTS

802.11a OFDM MODULATION

EUT TEST CONDITION		MEASUREMENT DETAIL	
CHANNEL	Channel 149	FREQUENCY RANGE	1 ~ 40GHz
INPUT POWER (SYSTEM)	120Vac, 60 Hz	DETECTOR FUNCTION	Peak (PK) Average (AV)
ENVIRONMENTAL CONDITIONS	25deg. C, 65%RH 999hPa	TESTED BY	Kevin Liang

ANTENNA POLARITY & TEST DISTANCE: HORIZONTAL AT 3 M								
NO.	FREQ. (MHz)	EMISSION LEVEL (dBuV/m)	LIMIT (dBuV/m)	MARGIN (dB)	ANTENNA HEIGHT (m)	TABLE ANGLE (Degree)	RAW VALUE (dBuV)	CORRECTION FACTOR (dB/m)
1	#5725.00	63.99 PK	83.67	-19.68	1.08 H	156	22.92	41.07
2	#5725.00	42.79 AV	72.49	-29.70	1.08 H	156	1.72	41.07
3	*5745.00	103.67 PK			1.07 H	156	62.55	41.12
4	*5745.00	92.49 AV			1.07 H	156	51.37	41.12
5	11490.00	67.60 PK	74.00	-6.40	1.17 H	39	15.67	51.93
6	11490.00	52.64 AV	54.00	-1.36	1.17 H	39	0.71	51.93
ANTENNA POLARITY & TEST DISTANCE: VERTICAL AT 3 M								
NO.	FREQ. (MHz)	EMISSION LEVEL (dBuV/m)	LIMIT (dBuV/m)	MARGIN (dB)	ANTENNA HEIGHT (m)	TABLE ANGLE (Degree)	RAW VALUE (dBuV)	CORRECTION FACTOR (dB/m)
1	#5725.00	60.63 PK	86.51	-25.88	1.07 V	166	19.56	41.07
2	#5725.00	44.37 AV	76.11	-31.74	1.07 V	166	3.30	41.07
3	*5745.00	106.51 PK			1.07 V	165	65.39	41.12
4	*5745.00	96.11 AV			1.07 V	165	54.99	41.12
5	11490.00	65.20 PK	74.00	-8.80	1.53 V	110	13.27	51.93
6	11490.00	50.97 AV	54.00	-3.03	1.53 V	110	-0.96	51.93

- REMARKS:**
1. Emission level (dBuV/m) = Raw Value (dBuV) + Correction Factor (dB/m).
 2. Correction Factor (dB/m) = Antenna Factor (dB/m) + Cable Factor (dB).
 3. The other emission levels were very low against the limit.
 4. Margin value = Emission level – Limit value.
 5. “ * “: Fundamental frequency.
 6. The limit value is defined as per 15.247.
 7. "#":The radiated frequency is out the restricted band.



EUT TEST CONDITION		MEASUREMENT DETAIL	
CHANNEL	Channel 157	FREQUENCY RANGE	1 ~ 40GHz
INPUT POWER (SYSTEM)	120Vac, 60 Hz	DETECTOR FUNCTION	Peak (PK) Average (AV)
ENVIRONMENTAL CONDITIONS	25deg. C, 65%RH 999hPa	TESTED BY	Kevin Liang

ANTENNA POLARITY & TEST DISTANCE: HORIZONTAL AT 3 M								
NO.	FREQ. (MHz)	EMISSION LEVEL (dBuV/m)	LIMIT (dBuV/m)	MARGIN (dB)	ANTENNA HEIGHT (m)	TABLE ANGLE (Degree)	RAW VALUE (dBuV)	CORRECTION FACTOR (dB/m)
1	*5785.00	102.98 PK			1.09 H	159	61.77	41.21
2	*5785.00	92.54 AV			1.09 H	159	51.33	41.21
3	11570.00	68.64 PK	74.00	-5.36	1.05 H	41	16.82	51.82
4	11570.00	52.69 AV	54.00	-1.31	1.05 H	41	0.88	51.82
ANTENNA POLARITY & TEST DISTANCE: VERTICAL AT 3 M								
NO.	FREQ. (MHz)	EMISSION LEVEL (dBuV/m)	LIMIT (dBuV/m)	MARGIN (dB)	ANTENNA HEIGHT (m)	TABLE ANGLE (Degree)	RAW VALUE (dBuV)	CORRECTION FACTOR (dB/m)
1	*5785.00	106.42 PK			1.06 V	180	65.21	41.21
2	*5785.00	95.87 AV			1.06 V	180	54.66	41.21
3	11570.00	68.67 PK	74.00	-5.33	1.53 V	105	16.85	51.82
4	11570.00	52.76 AV	54.00	-1.24	1.53 V	105	0.95	51.82

- REMARKS:**
1. Emission level (dBuV/m) = Raw Value (dBuV) + Correction Factor (dB/m).
 2. Correction Factor (dB/m) = Antenna Factor (dB/m) + Cable Factor (dB).
 3. The other emission levels were very low against the limit.
 4. Margin value = Emission level – Limit value.
 5. “ * “: Fundamental frequency.
 6. The limit value is defined as per 15.247.

EUT TEST CONDITION		MEASUREMENT DETAIL	
CHANNEL	Channel 165	FREQUENCY RANGE	1 ~ 40GHz
INPUT POWER (SYSTEM)	120Vac, 60 Hz	DETECTOR FUNCTION	Peak (PK) Average (AV)
ENVIRONMENTAL CONDITIONS	25deg. C, 65%RH 999hPa	TESTED BY	Kevin Liang

ANTENNA POLARITY & TEST DISTANCE: HORIZONTAL AT 3 M								
NO.	FREQ. (MHz)	EMISSION LEVEL (dBuV/m)	LIMIT (dBuV/m)	MARGIN (dB)	ANTENNA HEIGHT (m)	TABLE ANGLE (Degree)	RAW VALUE (dBuV)	CORRECTION FACTOR (dB/m)
1	*5825.00	103.47 PK			1.00 H	159	62.14	41.33
2	*5825.00	93.26 AV			1.00 H	159	51.93	41.33
3	#5850.00	62.86 PK	83.47	-20.61	1.00 H	159	21.45	41.41
4	#5850.00	42.15 AV	73.26	-31.11	1.00 H	159	0.74	41.41
5	11650.00	65.02 PK	74.00	-8.98	1.05 H	43	13.26	51.76
6	11650.00	51.85 AV	54.00	-2.15	1.05 H	43	0.09	51.76
ANTENNA POLARITY & TEST DISTANCE: VERTICAL AT 3 M								
NO.	FREQ. (MHz)	EMISSION LEVEL (dBuV/m)	LIMIT (dBuV/m)	MARGIN (dB)	ANTENNA HEIGHT (m)	TABLE ANGLE (Degree)	RAW VALUE (dBuV)	CORRECTION FACTOR (dB/m)
1	*5825.00	106.43 PK			1.06 V	206	65.10	41.33
2	*5825.00	95.92 AV			1.06 V	206	54.59	41.33
3	#5850.00	55.25 PK	86.43	-31.18	1.06 V	206	13.84	41.41
4	#5850.00	43.63 AV	75.92	-32.29	1.06 V	206	2.22	41.41
5	11650.00	66.47 PK	74.00	-7.53	1.70 V	107	14.71	51.76
6	11650.00	51.49 AV	54.00	-2.51	1.70 V	107	-0.27	51.76

- REMARKS:**
1. Emission level (dBuV/m) = Raw Value (dBuV) + Correction Factor (dB/m).
 2. Correction Factor (dB/m) = Antenna Factor (dB/m) + Cable Factor (dB).
 3. The other emission levels were very low against the limit.
 4. Margin value = Emission level – Limit value.
 5. “ * “: Fundamental frequency.
 6. The limit value is defined as per 15.247.
 7. “#”:The radiated frequency is out the restricted band.

DRAFT 802.11n (20MHz) OFDM MODULATION

EUT TEST CONDITION		MEASUREMENT DETAIL	
CHANNEL	Channel 149	FREQUENCY RANGE	1 ~ 40GHz
INPUT POWER (SYSTEM)	120Vac, 60 Hz	DETECTOR FUNCTION	Peak (PK) Average (AV)
ENVIRONMENTAL CONDITIONS	25deg. C, 65%RH 999hPa	TESTED BY	Kevin Liang

ANTENNA POLARITY & TEST DISTANCE: HORIZONTAL AT 3 M								
NO.	FREQ. (MHz)	EMISSION LEVEL (dBuV/m)	LIMIT (dBuV/m)	MARGIN (dB)	ANTENNA HEIGHT (m)	TABLE ANGLE (Degree)	RAW VALUE (dBuV)	CORRECTION FACTOR (dB/m)
1	#5725.00	62.71 PK	81.60	-18.89	1.00 H	156	21.64	41.07
2	#5725.00	41.15 AV	71.61	-30.46	1.00 H	156	0.08	41.07
3	*5745.00	101.60 PK			1.00 H	156	60.48	41.12
4	*5745.00	91.61 AV			1.00 H	156	50.49	41.12
5	11490.00	66.12 PK	74.00	-7.88	1.05 H	44	14.19	51.93
6	11490.00	51.70 AV	54.00	-2.30	1.05 H	44	-0.23	51.93
ANTENNA POLARITY & TEST DISTANCE: VERTICAL AT 3 M								
NO.	FREQ. (MHz)	EMISSION LEVEL (dBuV/m)	LIMIT (dBuV/m)	MARGIN (dB)	ANTENNA HEIGHT (m)	TABLE ANGLE (Degree)	RAW VALUE (dBuV)	CORRECTION FACTOR (dB/m)
1	#5725.00	60.24 PK	84.68	-24.44	1.00 V	170	19.17	41.07
2	#5725.00	44.08 AV	74.10	-30.02	1.00 V	170	3.01	41.07
3	*5745.00	104.68 PK			1.00 V	170	63.56	41.12
4	*5745.00	94.10 AV			1.00 V	170	52.98	41.12
5	11490.00	63.24 PK	74.00	-10.76	1.41 V	107	11.31	51.93
6	11490.00	50.08 AV	54.00	-3.92	1.41 V	107	-1.85	51.93

- REMARKS:**
1. Emission level (dBuV/m) = Raw Value (dBuV) + Correction Factor (dB/m).
 2. Correction Factor (dB/m) = Antenna Factor (dB/m) + Cable Factor (dB).
 3. The other emission levels were very low against the limit.
 4. Margin value = Emission level – Limit value.
 5. “ * “: Fundamental frequency.
 6. The limit value is defined as per 15.247.
 7. "#":The radiated frequency is out the restricted band.

EUT TEST CONDITION		MEASUREMENT DETAIL	
CHANNEL	Channel 157	FREQUENCY RANGE	1 ~ 40GHz
INPUT POWER (SYSTEM)	120Vac, 60 Hz	DETECTOR FUNCTION	Peak (PK) Average (AV)
ENVIRONMENTAL CONDITIONS	25deg. C, 65%RH 999hPa	TESTED BY	Kevin Liang

ANTENNA POLARITY & TEST DISTANCE: HORIZONTAL AT 3 M								
NO.	FREQ. (MHz)	EMISSION LEVEL (dBuV/m)	LIMIT (dBuV/m)	MARGIN (dB)	ANTENNA HEIGHT (m)	TABLE ANGLE (Degree)	RAW VALUE (dBuV)	CORRECTION FACTOR (dB/m)
1	*5785.00	101.52 PK			1.02 H	154	60.31	41.21
2	*5785.00	91.49 AV			1.02 H	154	50.28	41.21
3	11570.00	63.38 PK	74.00	-10.62	1.11 H	42	11.57	51.82
4	11570.00	50.50 AV	54.00	-3.50	1.11 H	42	-1.31	51.82
ANTENNA POLARITY & TEST DISTANCE: VERTICAL AT 3 M								
NO.	FREQ. (MHz)	EMISSION LEVEL (dBuV/m)	LIMIT (dBuV/m)	MARGIN (dB)	ANTENNA HEIGHT (m)	TABLE ANGLE (Degree)	RAW VALUE (dBuV)	CORRECTION FACTOR (dB/m)
1	*5785.00	104.55 PK			1.01 V	172	63.34	41.21
2	*5785.00	93.90 AV			1.01 V	172	52.69	41.21
3	11570.00	63.26 PK	74.00	-10.74	1.59 V	114	11.45	51.82
4	11570.00	49.62 AV	54.00	-4.38	1.59 V	114	-2.19	51.82

- REMARKS:**
1. Emission level (dBuV/m) = Raw Value (dBuV) + Correction Factor (dB/m).
 2. Correction Factor (dB/m) = Antenna Factor (dB/m) + Cable Factor (dB).
 3. The other emission levels were very low against the limit.
 4. Margin value = Emission level – Limit value.
 5. “ * “: Fundamental frequency.
 6. The limit value is defined as per 15.247.

EUT TEST CONDITION		MEASUREMENT DETAIL	
CHANNEL	Channel 165	FREQUENCY RANGE	1 ~ 40GHz
INPUT POWER (SYSTEM)	120Vac, 60 Hz	DETECTOR FUNCTION	Peak (PK) Average (AV)
ENVIRONMENTAL CONDITIONS	25deg. C, 65%RH 999hPa	TESTED BY	Kevin Liang

ANTENNA POLARITY & TEST DISTANCE: HORIZONTAL AT 3 M								
NO.	FREQ. (MHz)	EMISSION LEVEL (dBuV/m)	LIMIT (dBuV/m)	MARGIN (dB)	ANTENNA HEIGHT (m)	TABLE ANGLE (Degree)	RAW VALUE (dBuV)	CORRECTION FACTOR (dB/m)
1	*5825.00	101.24 PK			1.00 H	155	59.91	41.33
2	*5825.00	90.98 AV			1.00 H	155	49.65	41.33
3	#5850.00	59.32 PK	81.24	-21.92	1.00 H	155	17.91	41.41
4	#5850.00	41.87 AV	70.98	-29.11	1.00 H	155	0.46	41.41
5	11650.00	62.12 PK	74.00	-11.88	1.00 H	36	10.36	51.76
6	11650.00	48.88 AV	54.00	-5.12	1.00 H	36	-2.88	51.76
ANTENNA POLARITY & TEST DISTANCE: VERTICAL AT 3 M								
NO.	FREQ. (MHz)	EMISSION LEVEL (dBuV/m)	LIMIT (dBuV/m)	MARGIN (dB)	ANTENNA HEIGHT (m)	TABLE ANGLE (Degree)	RAW VALUE (dBuV)	CORRECTION FACTOR (dB/m)
1	*5825.00	104.17 PK			1.05 V	169	62.84	41.33
2	*5825.00	93.65 AV			1.05 V	169	52.32	41.33
3	#5850.00	60.83 PK	84.17	-23.34	1.05 V	169	19.42	41.41
4	#5850.00	43.16 AV	73.65	-30.49	1.05 V	169	1.75	41.41
5	11650.00	62.41 PK	74.00	-11.59	1.44 V	107	10.65	51.76
6	11650.00	49.35 AV	54.00	-4.65	1.44 V	107	-2.41	51.76

- REMARKS:**
1. Emission level (dBuV/m) = Raw Value (dBuV) + Correction Factor (dB/m).
 2. Correction Factor (dB/m) = Antenna Factor (dB/m) + Cable Factor (dB).
 3. The other emission levels were very low against the limit.
 4. Margin value = Emission level – Limit value.
 5. “ * “: Fundamental frequency.
 6. The limit value is defined as per 15.247.
 7. “#”:The radiated frequency is out the restricted band.

DRAFT 802.11n (40MHz) OFDM MODULATION

EUT TEST CONDITION		MEASUREMENT DETAIL	
CHANNEL	Channel 151	FREQUENCY RANGE	1 ~ 40GHz
INPUT POWER (SYSTEM)	120Vac, 60 Hz	DETECTOR FUNCTION	Peak (PK) Average (AV)
ENVIRONMENTAL CONDITIONS	25deg. C, 65%RH 999hPa	TESTED BY	Kevin Liang

ANTENNA POLARITY & TEST DISTANCE: HORIZONTAL AT 3 M								
NO.	FREQ. (MHz)	EMISSION LEVEL (dBuV/m)	LIMIT (dBuV/m)	MARGIN (dB)	ANTENNA HEIGHT (m)	TABLE ANGLE (Degree)	RAW VALUE (dBuV)	CORRECTION FACTOR (dB/m)
1	#5725.00	57.02 PK	76.86	-19.84	1.39 H	253	15.95	41.07
2	#5725.00	43.13 AV	65.17	-22.04	1.39 H	253	2.06	41.07
3	*5755.00	96.86 PK			1.39 H	253	55.72	41.14
4	*5755.00	85.17 AV			1.39 H	253	44.03	41.14
5	11510.00	64.57 PK	74.00	-9.43	1.52 H	129	12.64	51.92
6	11510.00	49.75 AV	54.00	-4.25	1.52 H	129	-2.18	51.92
ANTENNA POLARITY & TEST DISTANCE: VERTICAL AT 3 M								
NO.	FREQ. (MHz)	EMISSION LEVEL (dBuV/m)	LIMIT (dBuV/m)	MARGIN (dB)	ANTENNA HEIGHT (m)	TABLE ANGLE (Degree)	RAW VALUE (dBuV)	CORRECTION FACTOR (dB/m)
1	#5725.00	59.46 PK	81.97	-22.51	1.00 V	176	18.39	41.07
2	#5725.00	45.21 AV	71.56	-26.35	1.00 V	176	4.14	41.07
3	*5755.00	101.97 PK			1.00 V	10	60.83	41.14
4	*5755.00	91.56 AV			1.00 V	10	50.42	41.14
5	11510.00	63.30 PK	74.00	-10.70	1.54 V	115	11.37	51.92
6	11510.00	49.27 AV	54.00	-4.73	1.54 V	115	-2.66	51.92

- REMARKS:**
1. Emission level (dBuV/m) = Raw Value (dBuV) + Correction Factor (dB/m).
 2. Correction Factor (dB/m) = Antenna Factor (dB/m) + Cable Factor (dB).
 3. The other emission levels were very low against the limit.
 4. Margin value = Emission level – Limit value.
 5. “ * “: Fundamental frequency.
 6. The limit value is defined as per 15.247.
 7. “#”:The radiated frequency is out the restricted band.

EUT TEST CONDITION		MEASUREMENT DETAIL	
CHANNEL	Channel 159	FREQUENCY RANGE	1 ~ 40GHz
INPUT POWER (SYSTEM)	120Vac, 60 Hz	DETECTOR FUNCTION	Peak (PK) Average (AV)
ENVIRONMENTAL CONDITIONS	25deg. C, 65%RH 999hPa	TESTED BY	Kevin Liang

ANTENNA POLARITY & TEST DISTANCE: HORIZONTAL AT 3 M								
NO.	FREQ. (MHz)	EMISSION LEVEL (dBuV/m)	LIMIT (dBuV/m)	MARGIN (dB)	ANTENNA HEIGHT (m)	TABLE ANGLE (Degree)	RAW VALUE (dBuV)	CORRECTION FACTOR (dB/m)
1	*5795.00	96.16 PK			1.13 H	215	54.92	41.24
2	*5795.00	85.36 AV			1.13 H	215	44.12	41.24
3	#5850.00	57.61 PK	76.16	-18.55	1.00 H	220	16.20	41.41
4	#5850.00	42.97 AV	65.36	-22.39	1.00 H	220	1.56	41.41
5	11590.00	63.88 PK	74.00	-10.12	1.02 H	26	12.10	51.78
6	11590.00	49.03 AV	54.00	-4.97	1.02 H	26	-2.75	51.78
ANTENNA POLARITY & TEST DISTANCE: VERTICAL AT 3 M								
NO.	FREQ. (MHz)	EMISSION LEVEL (dBuV/m)	LIMIT (dBuV/m)	MARGIN (dB)	ANTENNA HEIGHT (m)	TABLE ANGLE (Degree)	RAW VALUE (dBuV)	CORRECTION FACTOR (dB/m)
1	*5795.00	101.20 PK			1.00 V	2	59.96	41.24
2	*5795.00	90.79 AV			1.00 V	2	49.55	41.24
3	#5850.00	58.66 PK	81.20	-22.54	1.00 V	12	17.25	41.41
4	#5850.00	45.03 AV	70.79	-25.76	1.00 V	12	3.62	41.41
5	11590.00	63.89 PK	74.00	-10.11	1.02 V	120	12.11	51.78
6	11590.00	49.52 AV	54.00	-4.48	1.02 V	120	-2.26	51.78

- REMARKS:**
1. Emission level (dBuV/m) = Raw Value (dBuV) + Correction Factor (dB/m).
 2. Correction Factor (dB/m) = Antenna Factor (dB/m) + Cable Factor (dB).
 3. The other emission levels were very low against the limit.
 4. Margin value = Emission level – Limit value.
 5. “ * “: Fundamental frequency.
 6. The limit value is defined as per 15.247.
 7. "#":The radiated frequency is out the restricted band.

BELOW 1GHz WORST-CASE DATA : 802.11a OFDM MODULATION

EUT TEST CONDITION		MEASUREMENT DETAIL	
CHANNEL	Channel 165	FREQUENCY RANGE	Below 1000MHz
INPUT POWER (SYSTEM)	120Vac, 60 Hz	DETECTOR FUNCTION	Quasi-Peak
ENVIRONMENTAL CONDITIONS	26deg. C, 66%RH 999hPa	TESTED BY	Antony Lee

ANTENNA POLARITY & TEST DISTANCE: HORIZONTAL AT 3 M								
NO.	FREQ. (MHz)	EMISSION LEVEL (dBuV/m)	LIMIT (dBuV/m)	MARGIN (dB)	ANTENNA HEIGHT (m)	TABLE ANGLE (Degree)	RAW VALUE (dBuV)	CORRECTION FACTOR (dB/m)
1	164.06	37.09 QP	43.50	-6.41	1.50 H	112	23.71	13.38
2	220.44	38.14 QP	46.00	-7.86	1.50 H	289	26.68	11.46
3	249.60	44.11 QP	46.00	-1.89	1.00 H	127	31.35	12.76
4	500.42	42.80 QP	46.00	-3.20	1.50 H	253	23.68	19.12
5	624.85	36.90 QP	46.00	-9.10	1.00 H	223	15.16	21.75
6	751.23	39.64 QP	46.00	-6.36	1.00 H	229	15.89	23.75
ANTENNA POLARITY & TEST DISTANCE: VERTICAL AT 3 M								
NO.	FREQ. (MHz)	EMISSION LEVEL (dBuV/m)	LIMIT (dBuV/m)	MARGIN (dB)	ANTENNA HEIGHT (m)	TABLE ANGLE (Degree)	RAW VALUE (dBuV)	CORRECTION FACTOR (dB/m)
1	49.34	35.86 QP	40.00	-4.14	1.00 V	121	22.27	13.59
2	86.28	37.86 QP	40.00	-2.14	1.50 V	226	29.11	8.76
3	249.60	42.39 QP	46.00	-3.61	1.00 V	55	29.63	12.76
4	500.42	39.65 QP	46.00	-6.35	1.00 V	235	20.54	19.12
5	624.85	35.27 QP	46.00	-10.73	1.50 V	184	13.52	21.75
6	751.23	36.65 QP	46.00	-9.35	1.00 V	199	12.90	23.75

- REMARKS:**
1. Emission level (dBuV/m) = Raw Value (dBuV) + Correction Factor (dB/m).
 2. Correction Factor (dB/m) = Antenna Factor (dB/m) + Cable Factor (dB).
 3. The other emission levels were very low against the limit.
 4. Margin value = Emission level – Limit value.

5.2 CONDUCTED EMISSION MEASUREMENT

5.2.1 LIMITS OF CONDUCTED EMISSION MEASUREMENT

FREQUENCY OF EMISSION (MHz)	CONDUCTED LIMIT (dB μ V)	
	Quasi-peak	Average
0.15 ~ 0.5	66 to 56	56 to 46
0.5 ~ 5	56	46
5 ~ 30	60	50

- NOTE:** 1. The lower limit shall apply at the transition frequencies.
2. The limit decreases in line with the logarithm of the frequency in the range of 0.15 to 0.50MHz.
3. All emanations from a class A/B digital device or system, including any network of conductors and apparatus connected thereto, shall not exceed the level of field strengths specified above.

5.2.2 TEST INSTRUMENTS

DESCRIPTION & MANUFACTURER	MODEL NO.	SERIAL NO.	DATE OF CALIBRATION	DUE DATE OF CALIBRATION
Test Receiver ROHDE & SCHWARZ	ESCS30	100288	Sep. 22, 2007	Sep. 21, 2008
RF signal cable Woken	5D-FB	Cable-HYCO2-01	Jan. 04, 2008	Jan. 03, 2009
LISN ROHDE & SCHWARZ	ESH2-Z5	100100	Jan. 10, 2008	Jan. 09, 2009
LISN SCHWARZBECK	ESH3-Z5	100311	Jul., 30, 2008	Jul. 29, 2009
Software ADT	ADT_Cond_V3	NA	NA	NA

- NOTE:** 1. The calibration interval of the above test instruments is 12 months and the calibrations are traceable to NML/ROC and NIST/USA.
2. The test was performed in HwaYa Shielded Room 2.
3. The VCCI Site Registration No. is C-2047.

5.2.3 TEST PROCEDURES

- a. The EUT was placed 0.4 meters from the conducting wall of the shielded room with EUT being connected to the power mains through a line impedance stabilization network (LISN). Other support units were connected to the power mains through another LISN. The two LISNs provide 50 ohm/ 50uH of coupling impedance for the measuring instrument.
- b. Both lines of the power mains connected to the EUT were checked for maximum conducted interference.
- c. The frequency range from 150kHz to 30MHz was searched. Emission levels under (Limit - 20dB) was not recorded.

5.2.4 DEVIATION FROM TEST STANDARD

No deviation

5.2.5 TEST SETUP

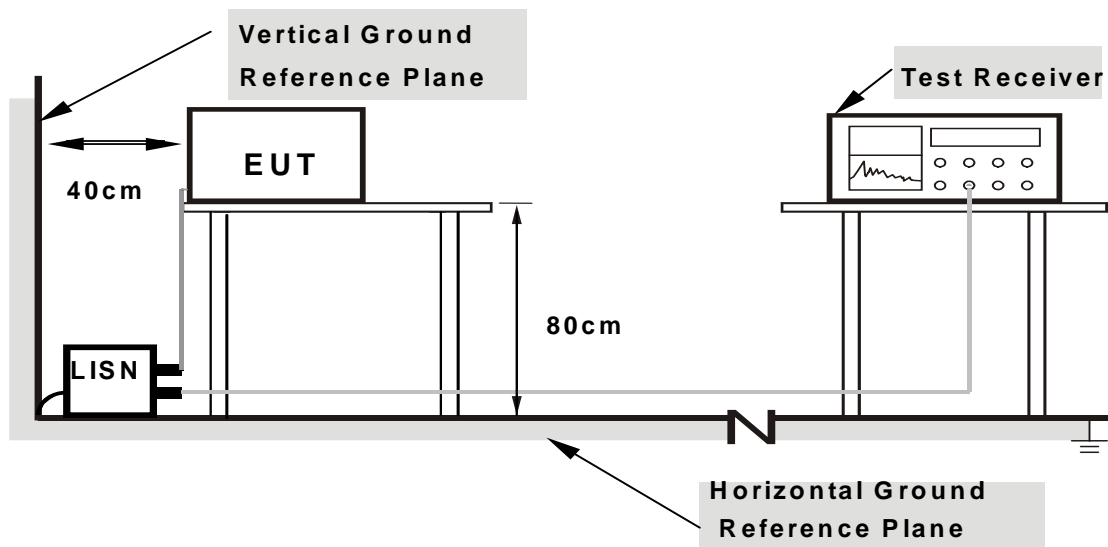

Note: 1. Support units were connected to second LISN.

2. Both of LISNs (AMN) are 80 cm from EUT and at least 80 from other units and other metal planes

For the actual test configuration, please refer to the attached file (Test Setup Photo).

5.2.6 EUT OPERATING CONDITIONS

Same as 4.1.6

5.2.7 TEST RESULTS

CONDUCTED WORST-CASE DATA : DRAFT 802.11a OFDM MODULATION

EUT TEST CONDITION		MEASUREMENT DETAIL	
CHANNEL	Channel 165	PHASE	Line 1
MODULATION TYPE	BPSK	INPUT POWER (SYSTEM)	120Vac, 60Hz
TRANSFER RATE	6Mbps	6dB BANDWIDTH	9kHz
ENVIRONMENTAL CONDITIONS	25deg. C, 65%RH, 988hPa	TESTED BY	Brad Wu

No	Freq. [MHz]	Corr. Factor (dB)	Reading Value [dB (uV)]		Emission Level [dB (uV)]		Limit [dB (uV)]		Margin (dB)	
			Q.P.	AV.	Q.P.	AV.	Q.P.	AV.	Q.P.	AV.
			1	0.197	0.20	44.97	-	45.17	-	63.74
2	0.263	0.20	41.48	-	41.68	-	61.33	51.33	-19.65	-
3	0.392	0.20	35.04	-	35.24	-	58.02	48.02	-22.78	-
4	0.646	0.20	32.47	-	32.67	-	56.00	46.00	-23.33	-
5	3.488	0.35	14.43	-	14.78	-	56.00	46.00	-41.22	-
6	9.105	0.51	17.78	-	18.29	-	60.00	50.00	-41.71	-

- REMARKS:**
1. Q.P. and AV. are abbreviations of quasi-peak and average individually.
 2. "-": The Quasi-peak reading value also meets average limit and measurement with the average detector is unnecessary.
 3. The emission levels of other frequencies were very low against the limit.
 4. Margin value = Emission level - Limit value
 5. Correction factor = Insertion loss + Cable loss
 6. Emission Level = Correction Factor + Reading Value.

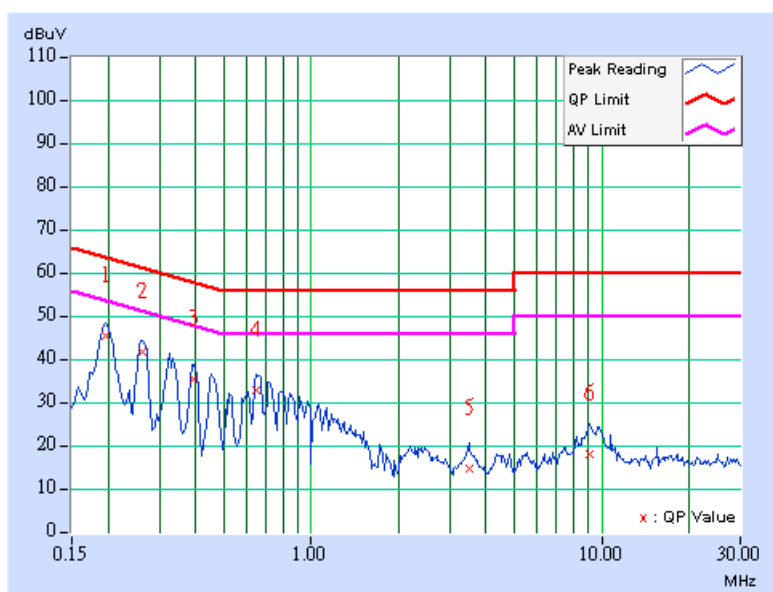

EUT TEST CONDITION		MEASUREMENT DETAIL	
CHANNEL	Channel 165	PHASE	Line 2
MODULATION TYPE	BPSK	INPUT POWER (SYSTEM)	120Vac, 60Hz
TRANSFER RATE	6Mbps	6dB BANDWIDTH	9kHz
ENVIRONMENTAL CONDITIONS	25deg. C, 65%RH, 988hPa	TESTED BY	Brad Wu

No	Freq. [MHz]	Corr. Factor (dB)	Reading Value [dB (uV)]		Emission Level [dB (uV)]		Limit [dB (uV)]		Margin (dB)	
			Q.P.	AV.	Q.P.	AV.	Q.P.	AV.	Q.P.	AV.
1	0.193	0.20	45.62	-	45.82	-	63.91	53.91	-18.09	-
2	0.259	0.20	43.84	-	44.04	-	61.45	51.45	-17.41	-
3	0.330	0.20	39.26	-	39.46	-	59.46	49.46	-20.00	-
4	0.654	0.20	37.82	-	38.02	-	56.00	46.00	-17.98	-
5	2.738	0.27	21.54	-	21.81	-	56.00	46.00	-34.19	-
6	9.082	0.51	20.23	-	20.74	-	60.00	50.00	-39.26	-

- REMARKS:**
1. Q.P. and AV. are abbreviations of quasi-peak and average individually.
 2. "-": The Quasi-peak reading value also meets average limit and measurement with the average detector is unnecessary.
 3. The emission levels of other frequencies were very low against the limit.
 4. Margin value = Emission level - Limit value
 5. Correction factor = Insertion loss + Cable loss
 6. Emission Level = Correction Factor + Reading Value.

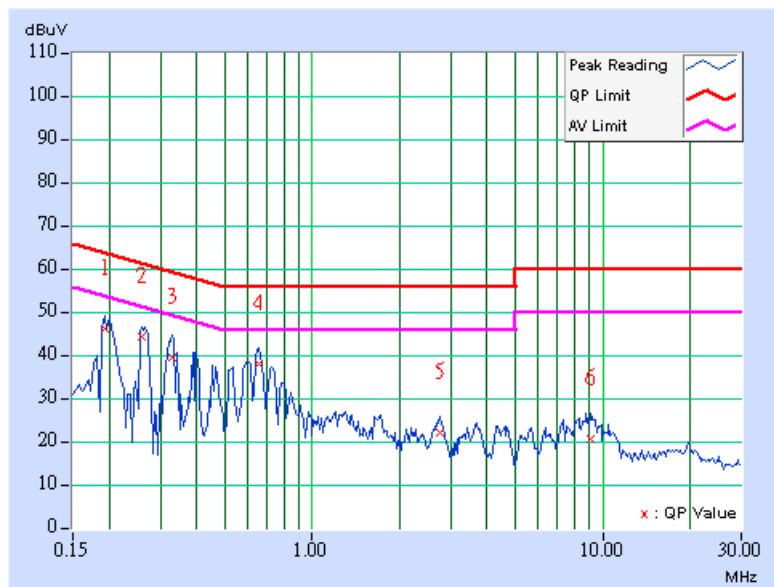



5.3 6dB BANDWIDTH MEASUREMENT

5.3.1 LIMITS OF 6dB BANDWIDTH MEASUREMENT

The minimum of 6dB Bandwidth Measurement is 0.5MHz.

5.3.2 TEST INSTRUMENTS

DESCRIPTION & MANUFACTURER	MODEL NO.	SERIAL NO.	DATE OF CALIBRATION	CALIBRATED UNTIL
R&S SPECTRUM ANALYZER	FSP40	100041	Apr. 22, 2008	Apr. 21, 2009

NOTE: The calibration interval of the above test instruments is 12 months and the calibrations are traceable to NML/ROC and NIST/USA.

5.3.3 TEST PROCEDURE

The transmitter output was connected to the spectrum analyzer through an attenuator. The bandwidth of the fundamental frequency was measured by spectrum analyzer with 100kHz RBW and 300kHz VBW. The 6dB bandwidth is defined as the total spectrum the power of which is higher than peak power minus 6dB.

5.3.4 DEVIATION FROM TEST STANDARD

No deviation

5.3.5 TEST SETUP

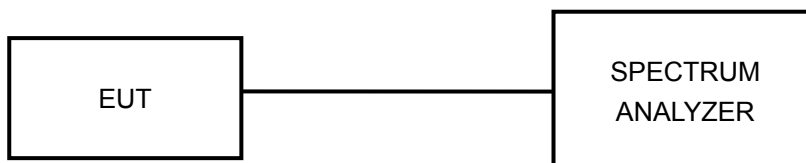

5.3.6 EUT OPERATING CONDITIONS

The software provided by client to enable the EUT under transmission condition continuously at lowest, middle and highest channel frequencies individually.



5.3.7 TEST RESULTS

802.11a OFDM MODULATION

MODULATION TYPE	BPSK	TRANSFER RATE	6.0Mbps
INPUT POWER (SYSTEM)	120Vac, 60Hz	ENVIRONMENTAL CONDITIONS	25deg.C, 65%RH, 991hPa
TESTED BY	Dean Wang		

CHANNEL	CHANNEL FREQUENCY (MHz)	6dB BANDWIDTH (MHz)		MINIMUM LIMIT (MHz)	PASS / FAIL
		CHAIN 0	CHAIN 1		
149	5745	16.35	16.34	0.5	PASS
157	5785	16.38	16.36	0.5	PASS
165	5825	16.37	16.36	0.5	PASS



FOR CHAIN 0: CH 149

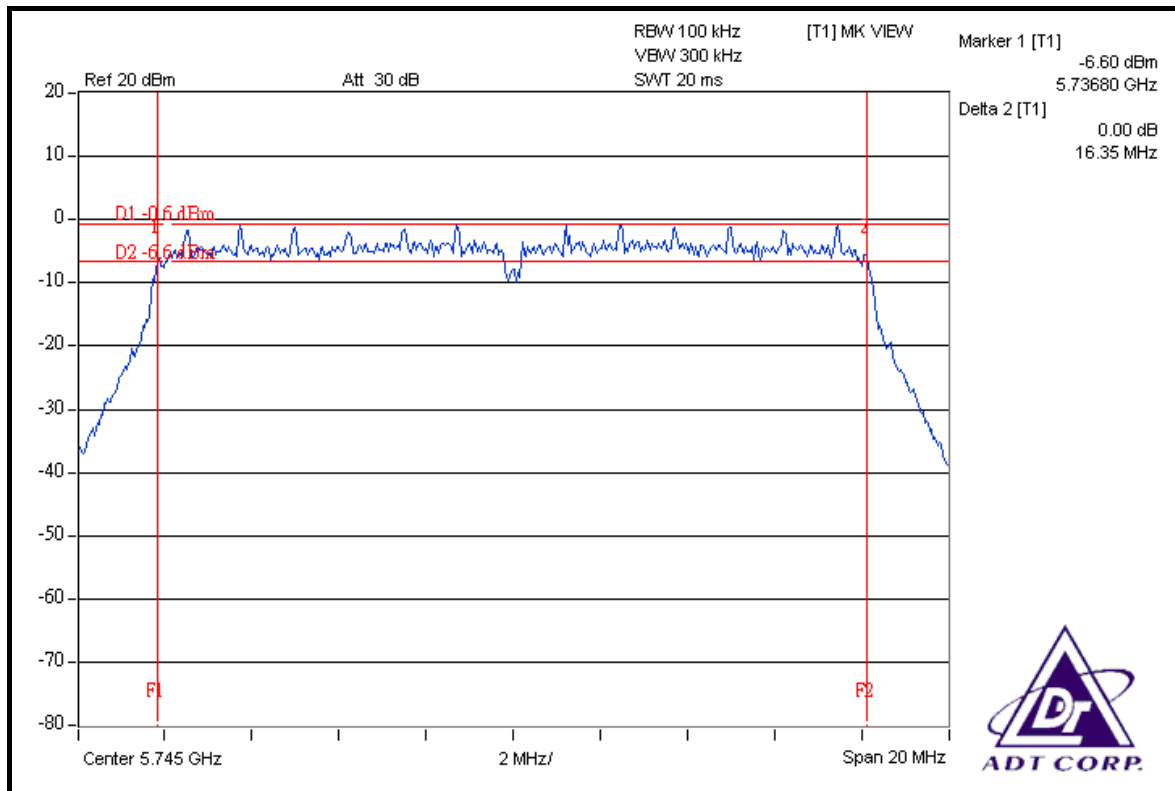

CH 157

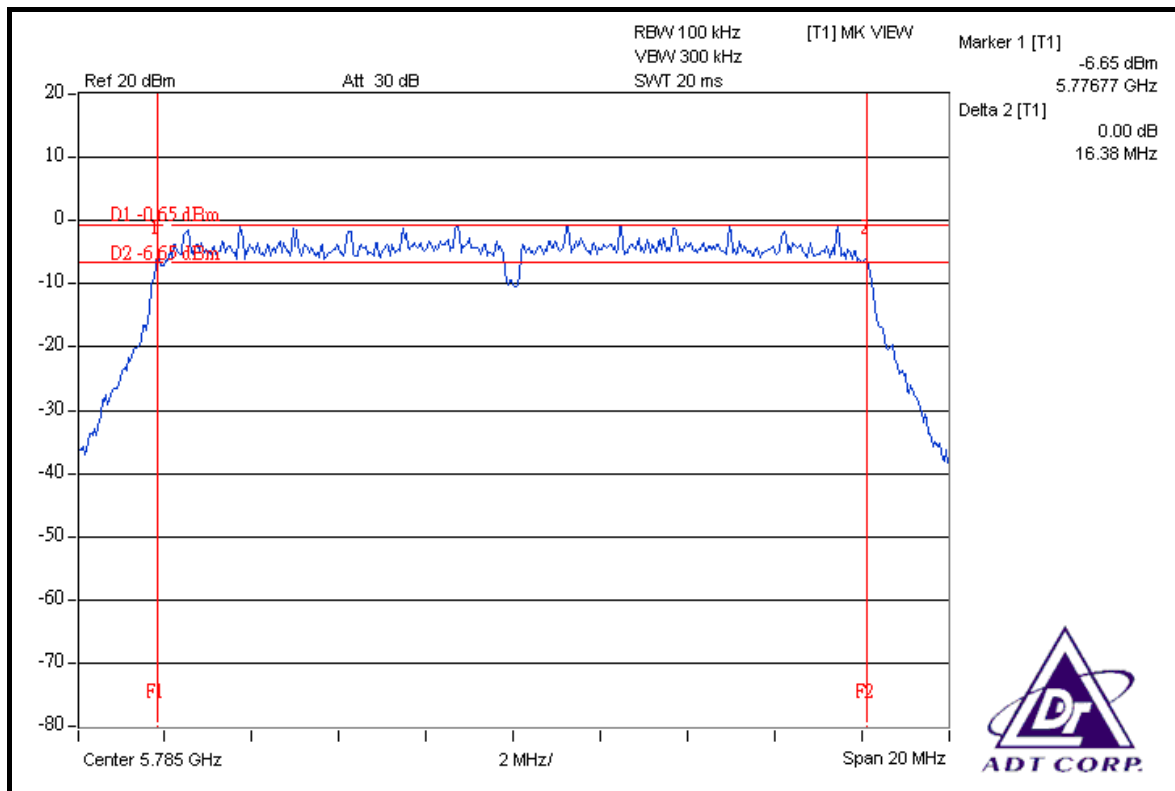



CH 165

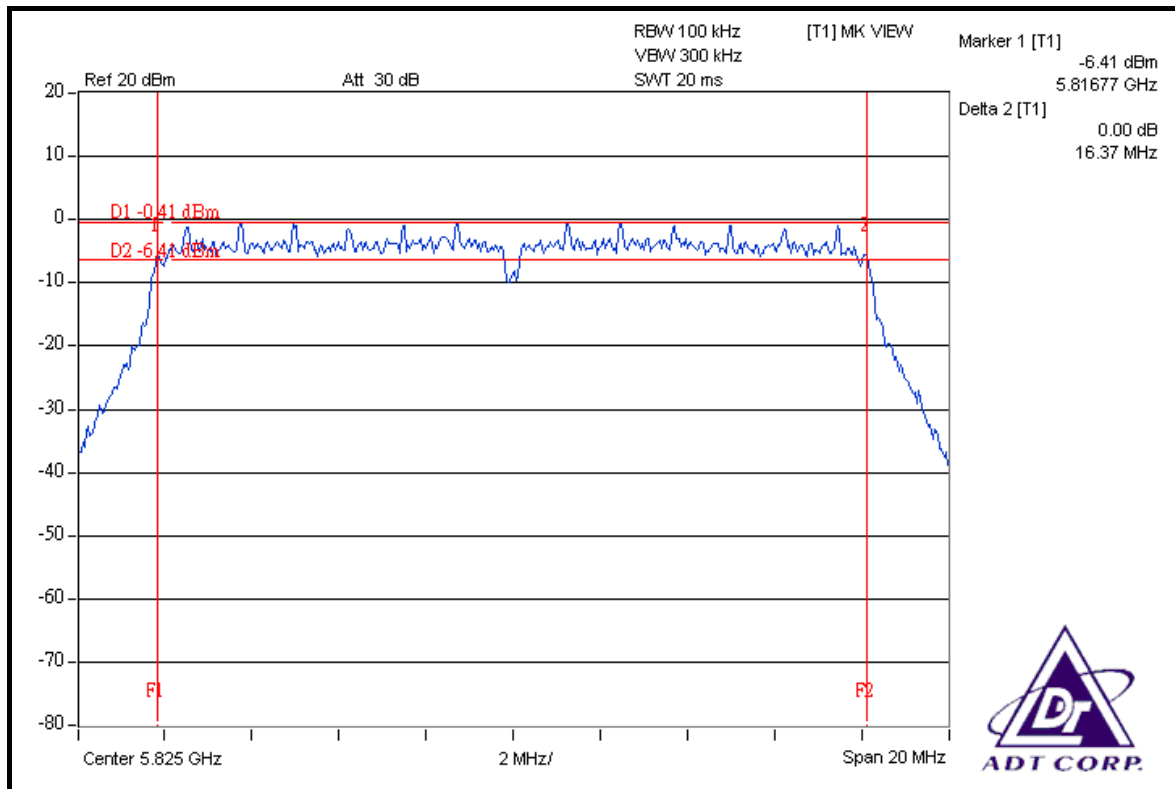

FOR CHAIN 1: CH 149

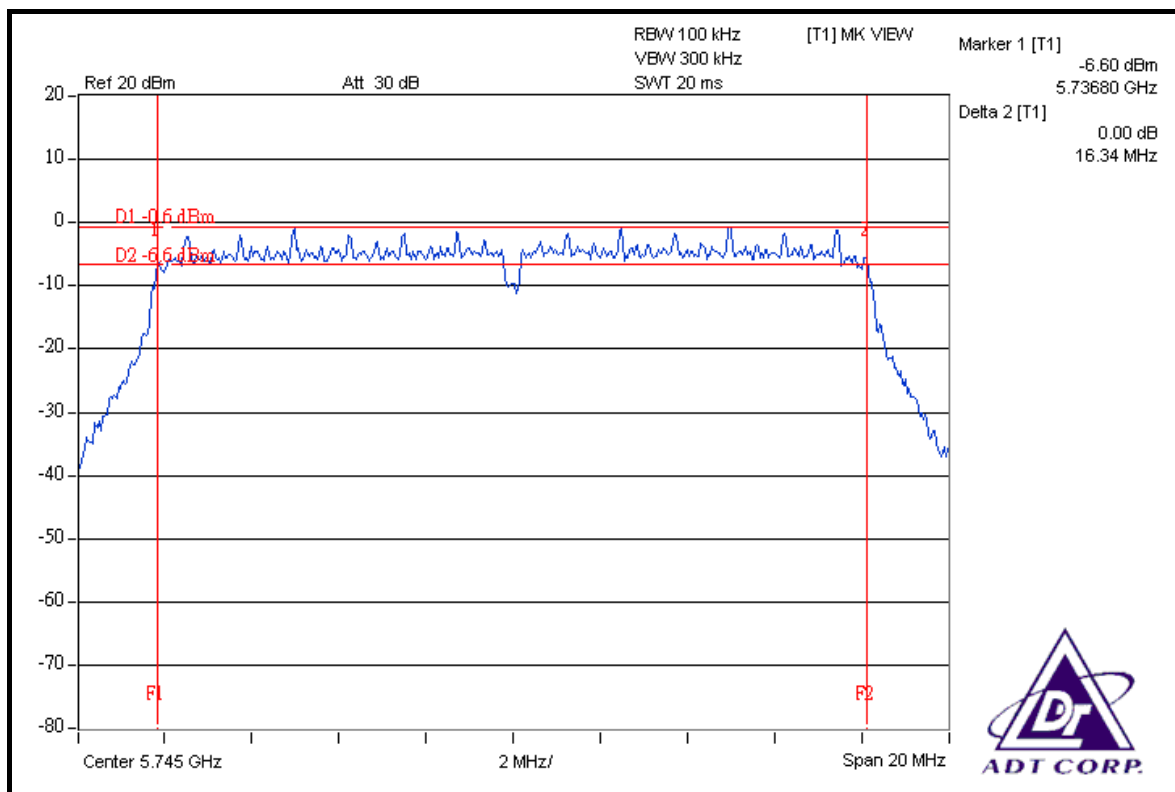

CH 157

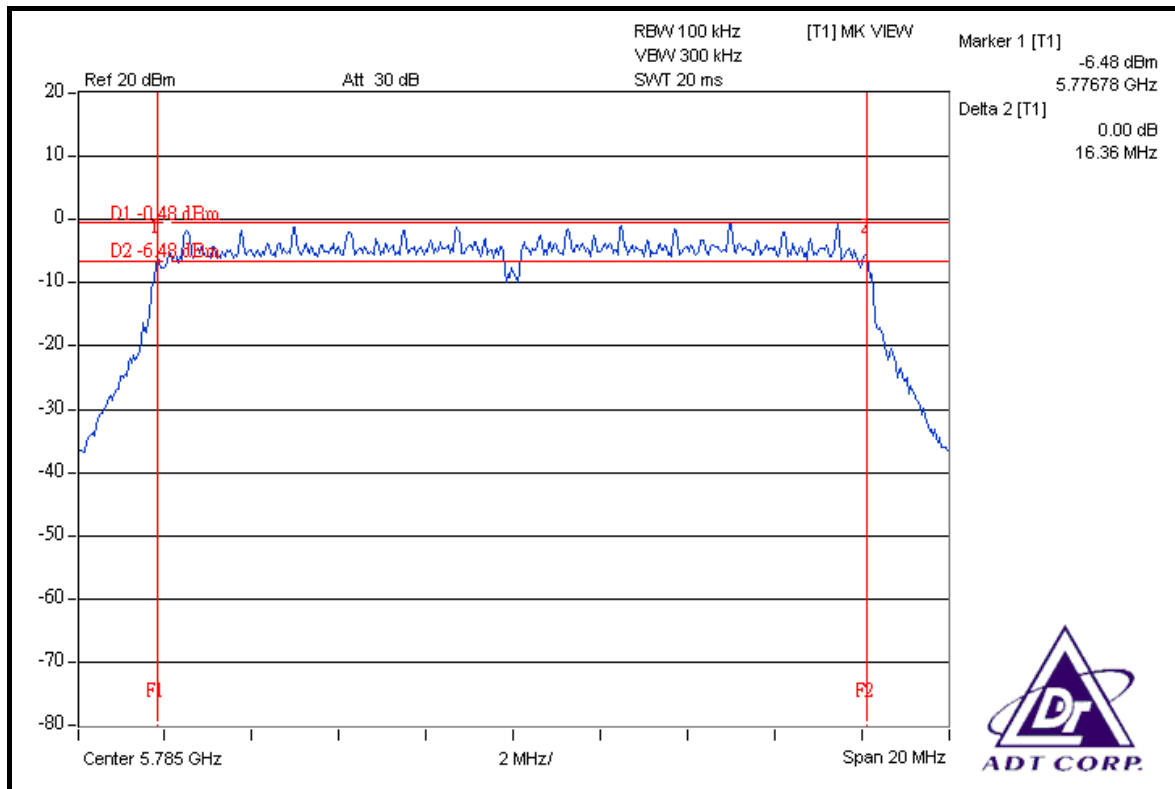

CH 165

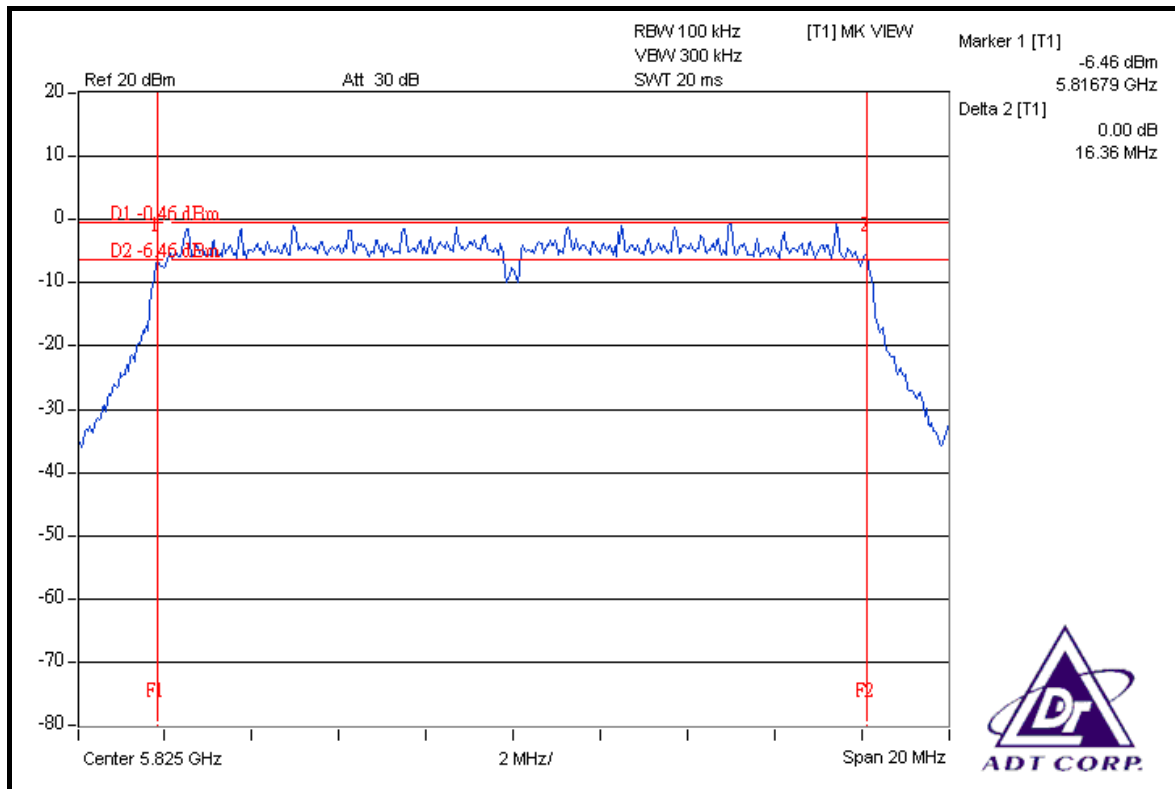



DRAFT 802.11n (20MHz) OFDM MODULATION

MODULATION TYPE	BPSK	TRANSFER RATE	7.2Mbps
INPUT POWER (SYSTEM)	120Vac, 60Hz	ENVIRONMENTAL CONDITIONS	25deg.C, 65%RH, 991hPa
TESTED BY	Dean Wang		

CHANNEL	CHANNEL FREQUENCY (MHz)	6dB BANDWIDTH (MHz)		MINIMUM LIMIT (MHz)	PASS / FAIL
		CHAIN 0	CHAIN 1		
149	5745	16.71	16.37	0.5	PASS
157	5785	16.60	16.37	0.5	PASS
165	5825	16.38	16.38	0.5	PASS



FOR CHAIN 0: CH 149

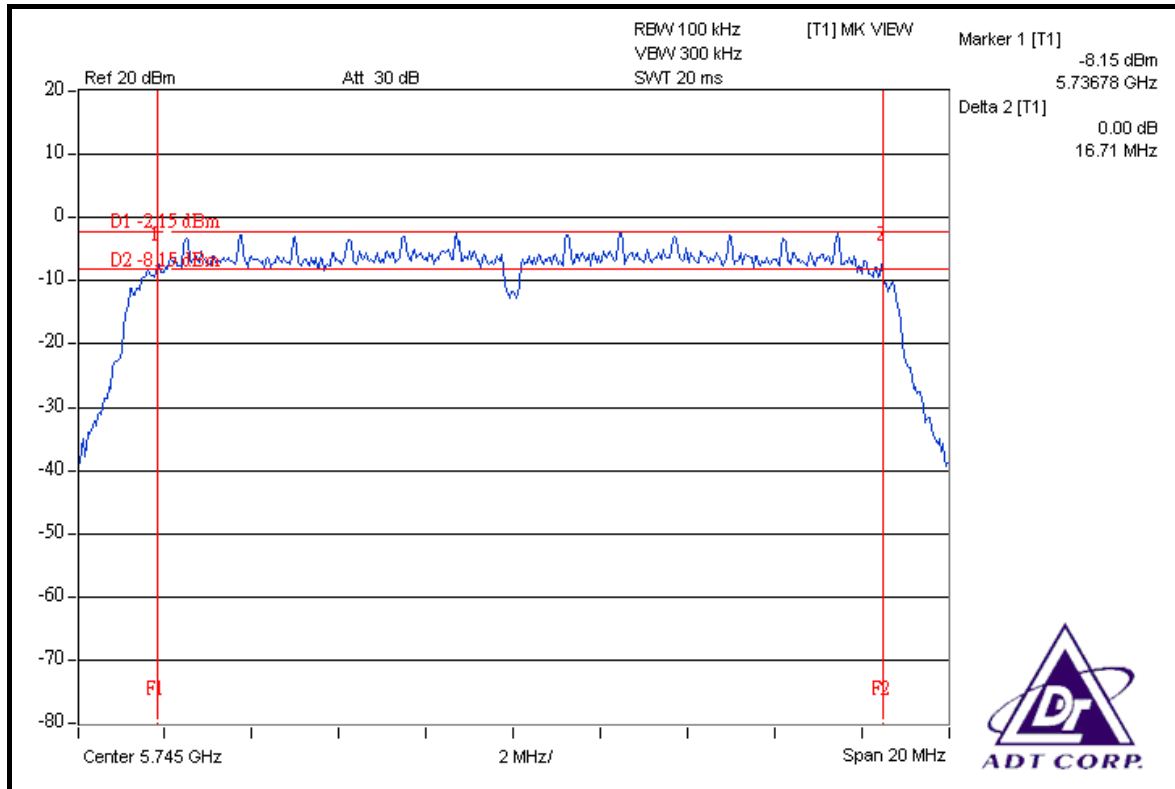

CH 157

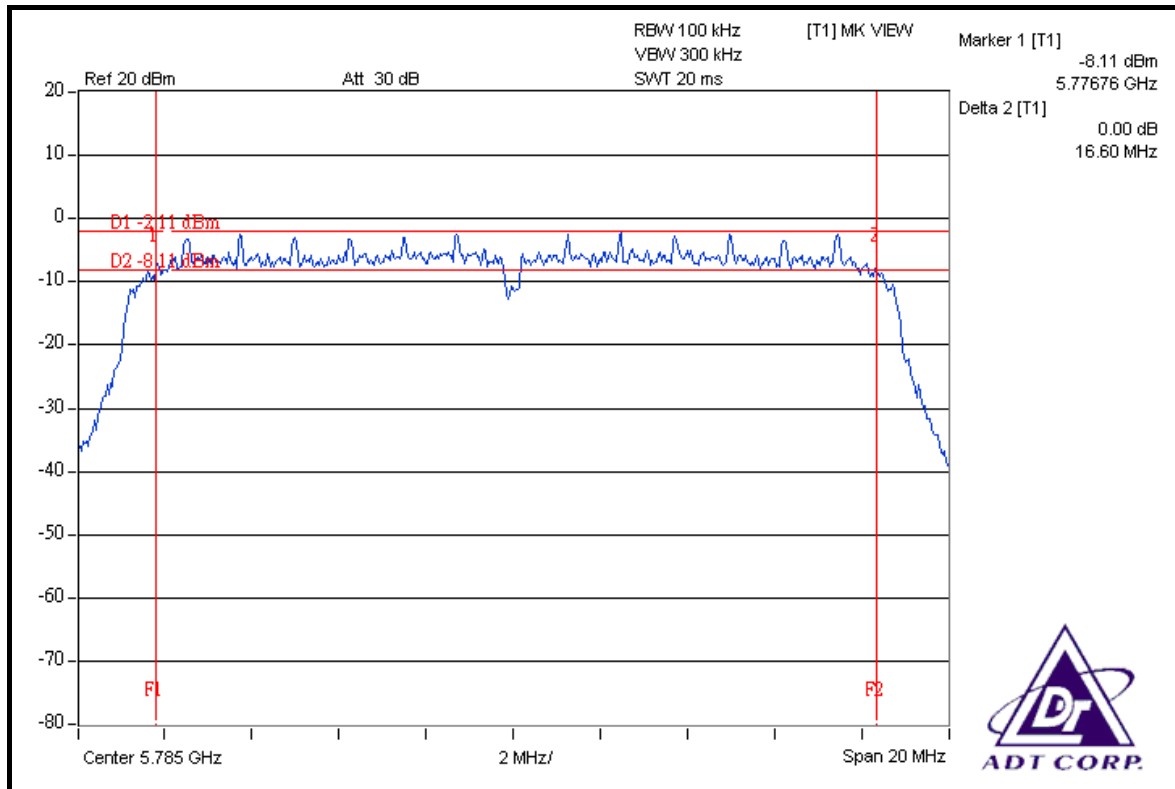



CH 165

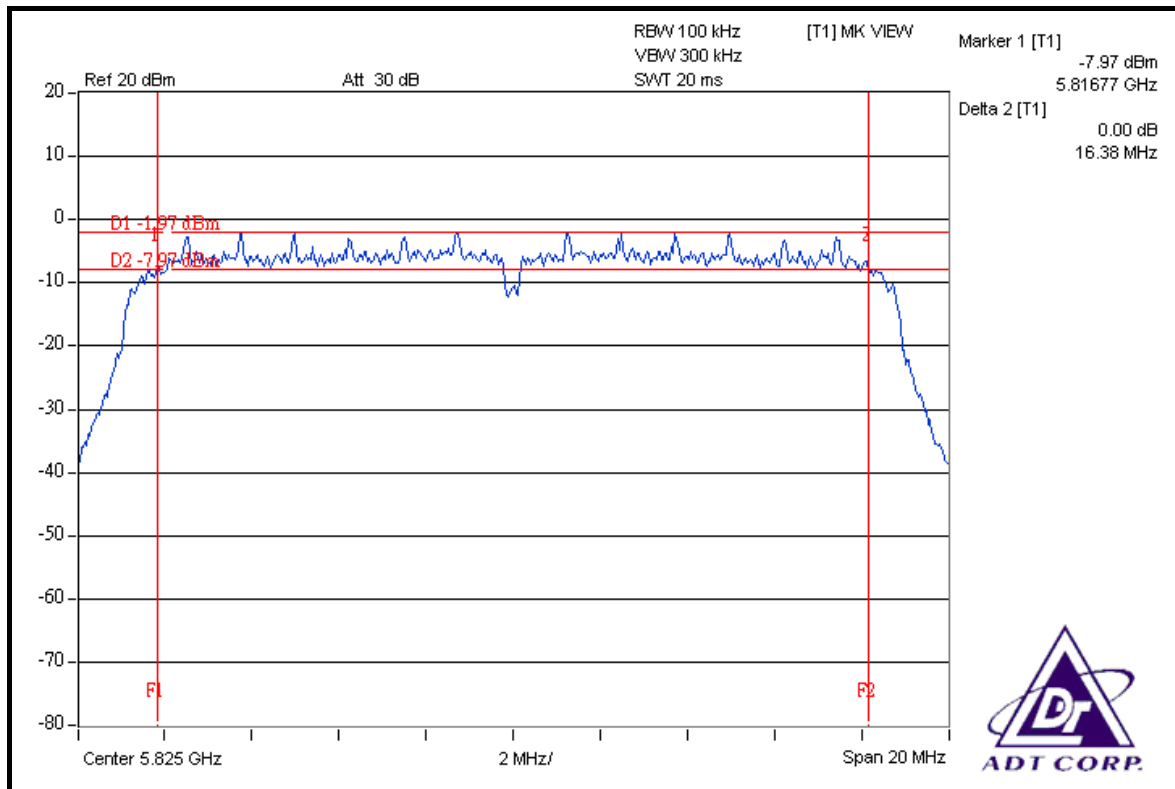

FOR CHAIN 1: CH 149

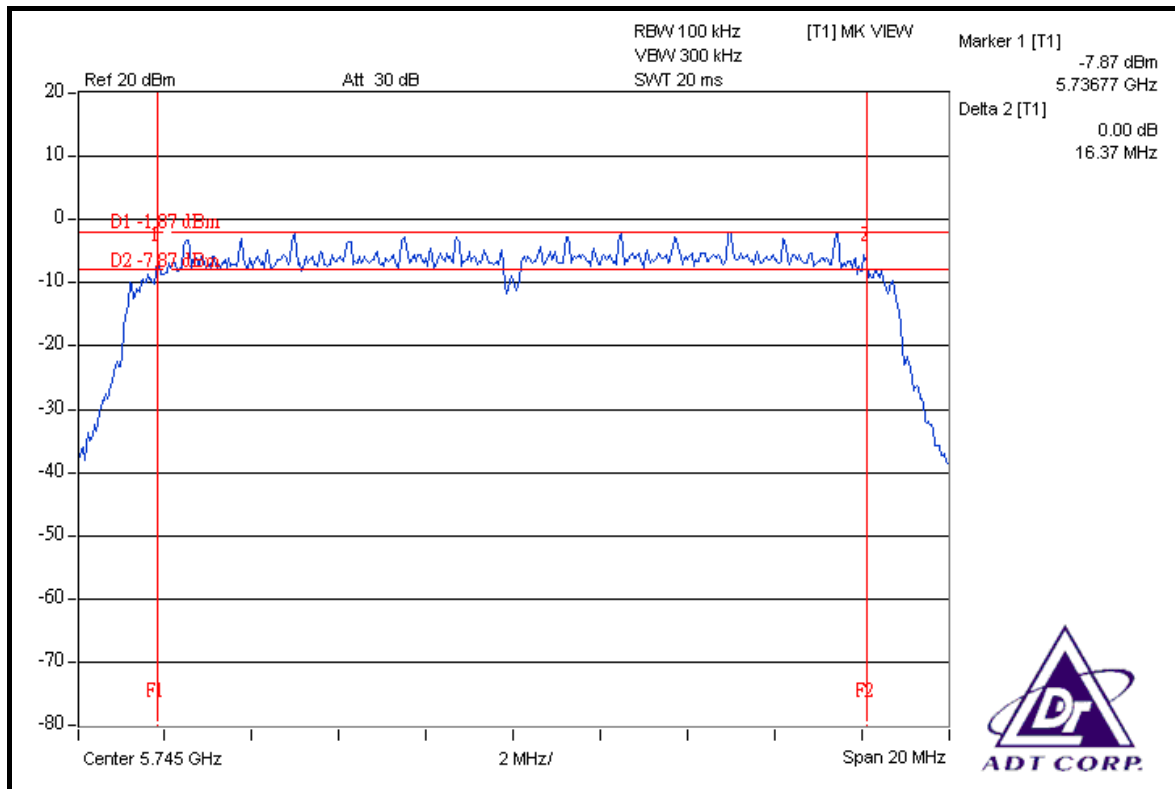

CH 157

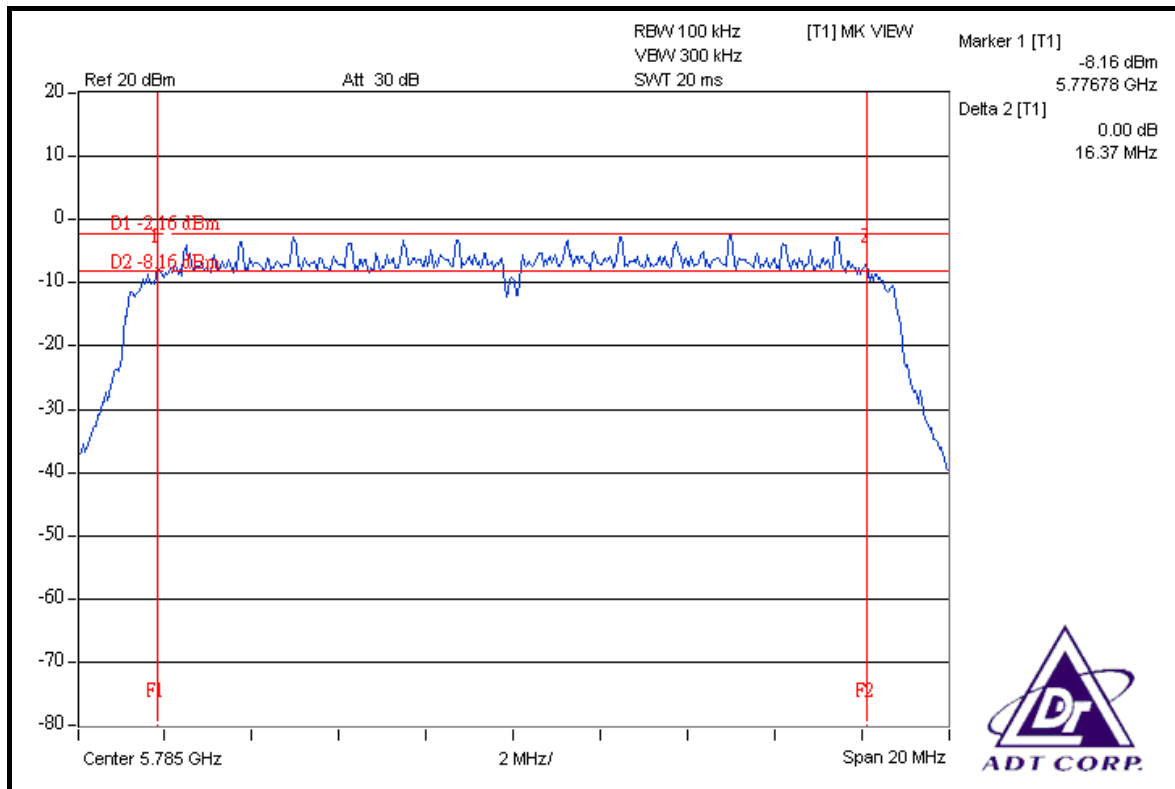

CH 165

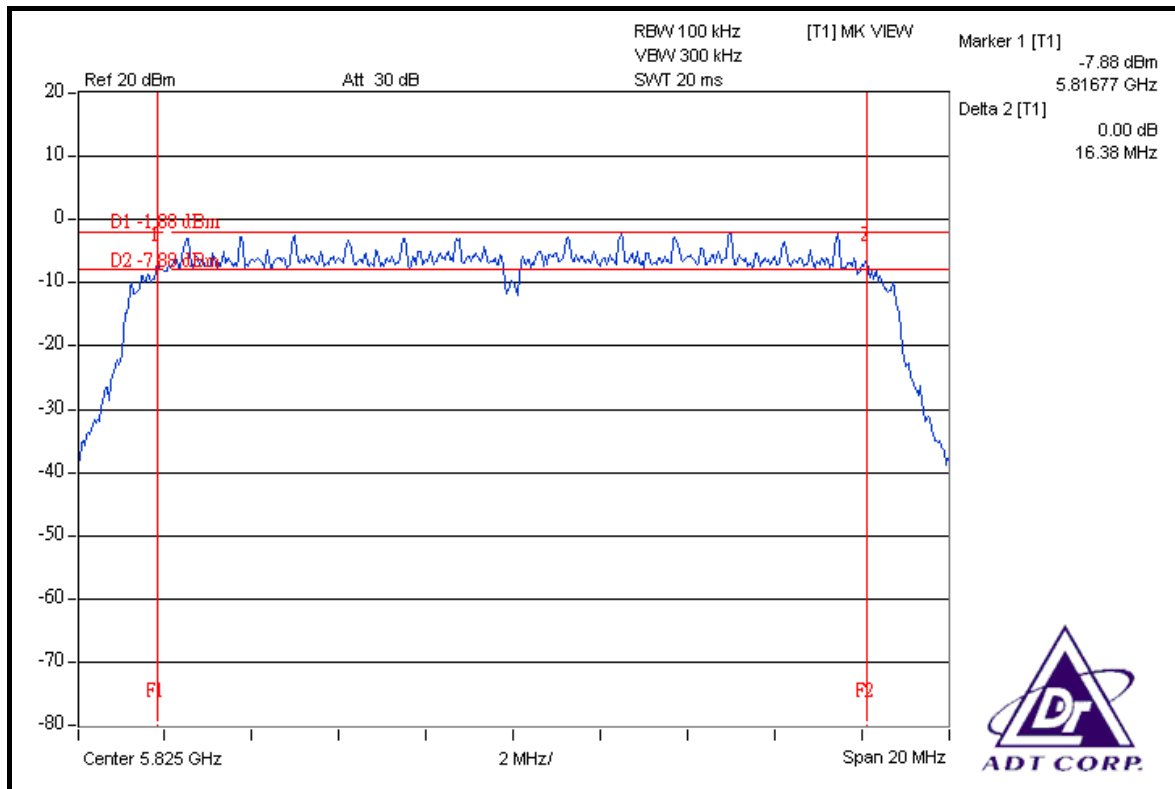



DRAFT 802.11n (40MHz) OFDM MODULATION

MODULATION TYPE	BPSK	TRANSFER RATE	15Mbps
INPUT POWER (SYSTEM)	120Vac, 60Hz	ENVIRONMENTAL CONDITIONS	25deg.C, 65%RH, 991hPa
TESTED BY	Dean Wang		

CHANNEL	CHANNEL FREQUENCY (MHz)	6dB BANDWIDTH (MHz)		MINIMUM LIMIT (MHz)	PASS / FAIL
		CHAIN 0	CHAIN 1		
151	5755	35.17	35.15	0.5	PASS
159	5795	35.16	35.15	0.5	PASS

FOR CHAIN 0: CH 151

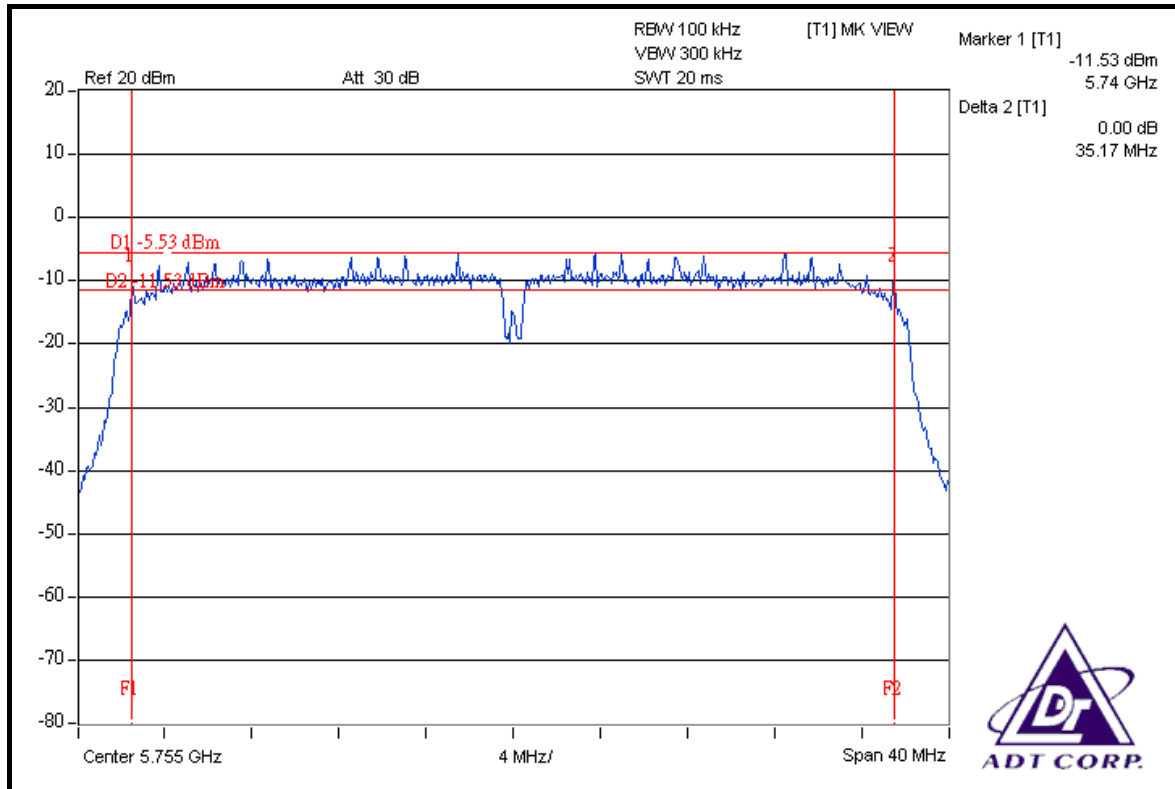

CH 159

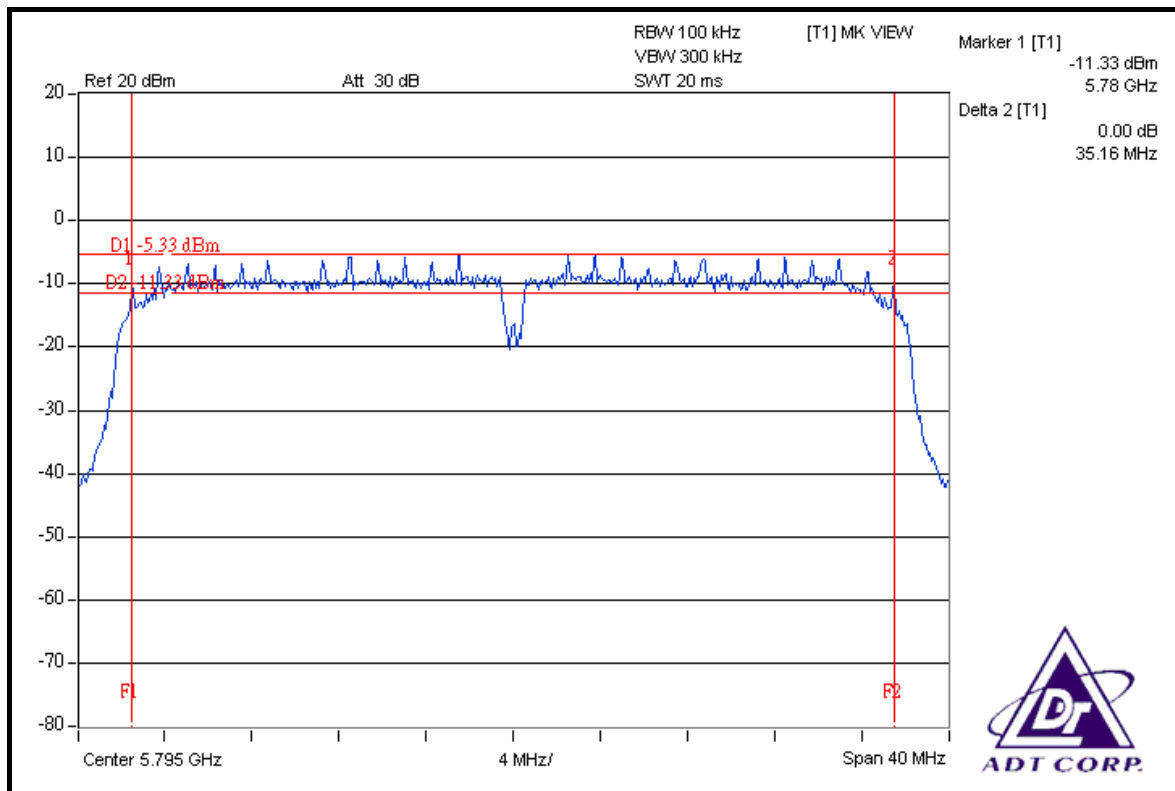



FOR CHAIN 1: CH 151

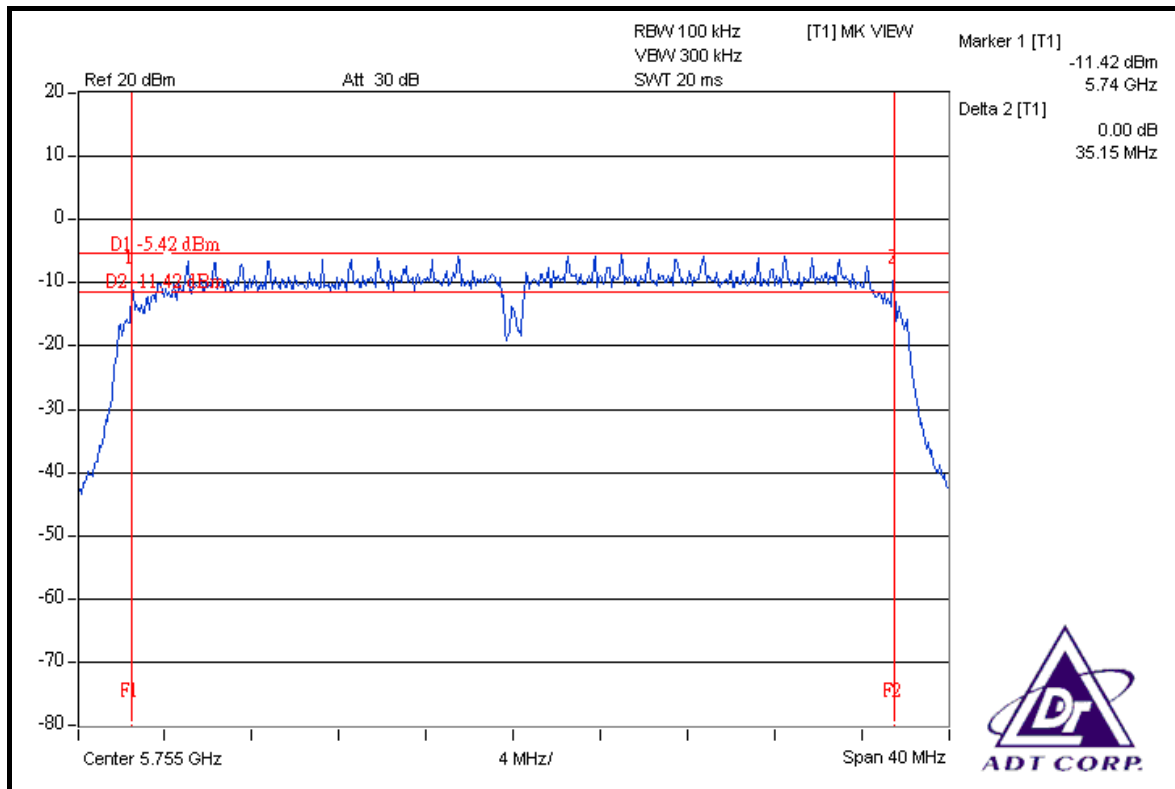

CH 159

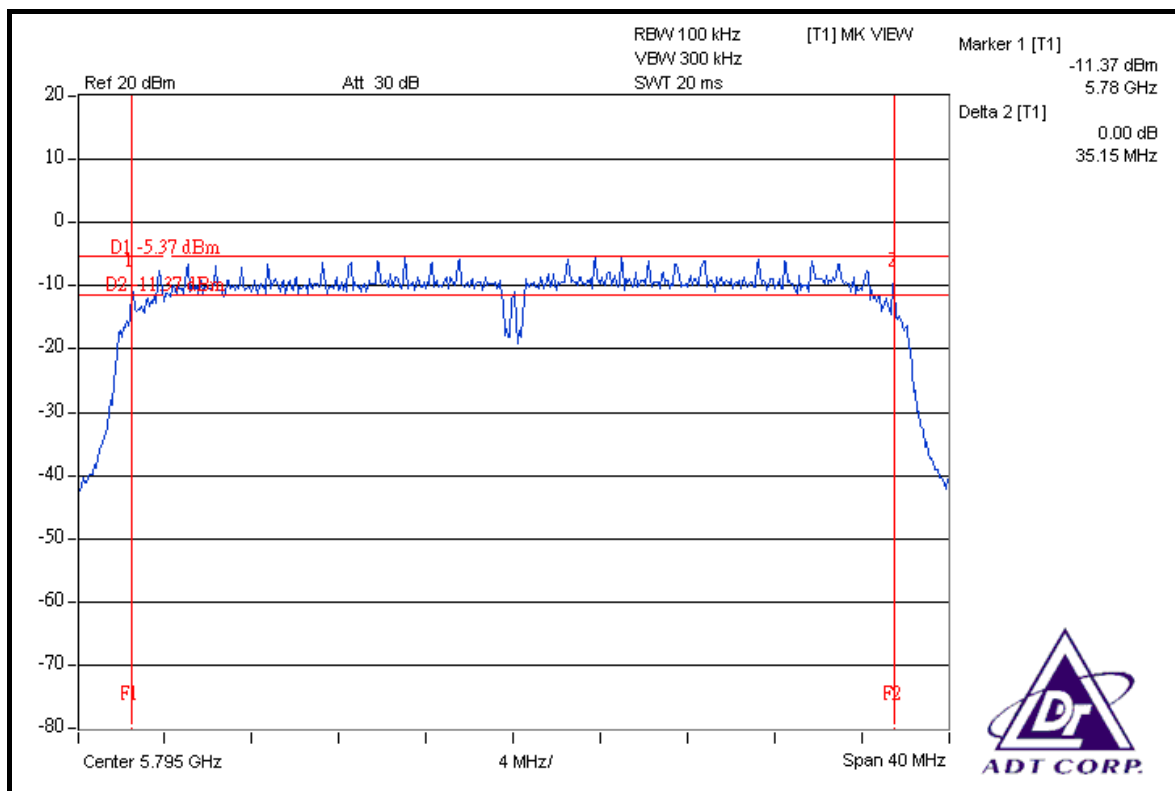

5.4 MAXIMUM PEAK OUTPUT POWER

5.4.1 LIMITS OF MAXIMUM PEAK OUTPUT POWER MEASUREMENT

The Maximum Peak Output Power Measurement is 30dBm.

5.4.2 INSTRUMENTS

DESCRIPTION & MANUFACTURER	MODEL NO.	SERIAL NO.	DATE OF CALIBRATION	CALIBRATED UNTIL
High Speed Peak Power Meter	ML2495A	0824012	Aug. 04, 2008	Aug. 03, 2009
Power Sensor	MA2444B	0738138	Aug. 04, 2008	Aug. 03, 2009

Note:

1. The calibration interval of the above test instruments is 12 months and the calibrations are traceable to NML/ROC and NIST/USA.
2. Measurement Bandwidth of ML2495A is 65MHz greater than 6dB bandwidth of emission.

5.4.3 TEST PROCEDURES

A power sensor was used on the output port of the EUT. A power meter was used to read the response of the power sensor. Record the power level.

5.4.4 DEVIATION FROM TEST STANDARD

No deviation

5.4.5 TEST SETUP

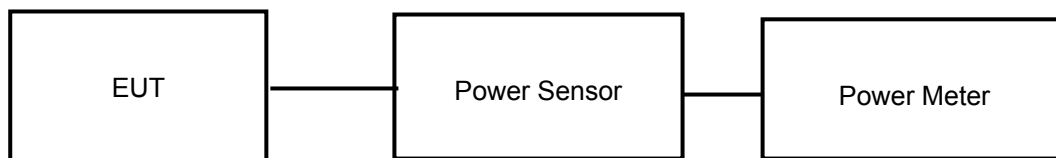

5.4.6 EUT OPERATING CONDITIONS

Same as Item 5.3.6

5.4.7 TEST RESULTS

802.11a OFDM MODULATION

MODULATION TYPE	BPSK	TRANSFER RATE	6.0Mbps
INPUT POWER (SYSTEM)	120Vac, 60Hz	ENVIRONMENTAL CONDITIONS	25deg.C, 65 %RH, 991hPa
TESTED BY	Dean Wang		

CHAN.	CHAN. FREQ. (MHz)	PEAK POWER OUTPUT (dBm)		TOTAL PEAK POWER (mW)	TOTAL PEAK POWER (dBm)	PEAK POWER LIMIT (dBm)	PASS / FAIL
		CHAIN 0	CHAIN 1				
149	5745	22.11	22.03	322.143	25.08	30	PASS
157	5785	22.03	22.04	319.544	25.05	30	PASS
165	5825	22.07	22.13	324.370	25.11	30	PASS

DRAFT 802.11n (20MHz) OFDM MODULATION

MODULATION TYPE	BPSK	TRANSFER RATE	7.2Mbps
INPUT POWER (SYSTEM)	120Vac, 60Hz	ENVIRONMENTAL CONDITIONS	25deg.C, 65 %RH, 991hPa
TESTED BY	Dean Wang		

CHAN.	CHAN. FREQ. (MHz)	PEAK POWER OUTPUT (dBm)		TOTAL PEAK POWER (mW)	TOTAL PEAK POWER (dBm)	PEAK POWER LIMIT (dBm)	PASS / FAIL
		CHAIN 0	CHAIN 1				
149	5745	20.56	20.53	226.742	23.56	30	PASS
157	5785	20.54	20.13	216.279	23.35	30	PASS
165	5825	20.60	20.56	228.578	23.59	30	PASS



DRAFT 802.11n (40MHz) OFDM MODULATION

MODULATION TYPE	BPSK	TRANSFER RATE	15Mbps
INPUT POWER (SYSTEM)	120Vac, 60Hz	ENVIRONMENTAL CONDITIONS	25 deg.C, 65 %RH, 991hPa
TESTED BY	Dean Wang		

CHAN.	CHAN. FREQ. (MHz)	PEAK POWER OUTPUT (dBm)		TOTAL PEAK POWER (mW)	TOTAL PEAK POWER (dBm)	PEAK POWER LIMIT (dBm)	PASS / FAIL
		CHAIN 0	CHAIN 1				
151	5755	19.54	19.58	180.732	22.57	30	PASS
159	5795	19.55	19.57	180.730	22.57	30	PASS



5.5 POWER SPECTRAL DENSITY MEASUREMENT

5.5.1 LIMITS OF POWER SPECTRAL DENSITY MEASUREMENT

The Maximum of Power Spectral Density Measurement is 8dBm.

5.5.2 TEST INSTRUMENTS

DESCRIPTION & MANUFACTURER	MODEL NO.	SERIAL NO.	DATE OF CALIBRATION	CALIBRATED UNTIL
R&S SPECTRUM ANALYZER	FSP40	100041	Apr. 22, 2008	Apr. 21, 2009

NOTE: The calibration interval of the above test instruments is 12 months and the calibrations are traceable to NML/ROC and NIST/USA.

5.5.3 TEST PROCEDURE

The transmitter output was connected to the spectrum analyzer through an attenuator, the bandwidth of the fundamental frequency was measured with the spectrum analyzer using 3kHz RBW and 30kHz VBW, set sweep time = span/3kHz. The power spectral density was measured and recorded.

The sweep time is allowed to be longer than span/3kHz for a full response of the mixer in the spectrum analyzer.

5.5.4 DEVIATION FROM TEST STANDARD

No deviation

5.5.5 TEST SETUP

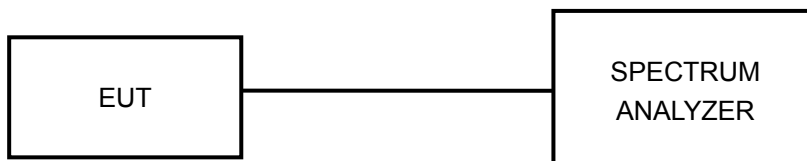

5.5.6 EUT OPERATING CONDITION

Same as Item 5.3.6



5.5.7 TEST RESULTS

802.11a OFDM MODULATION

MODULATION TYPE	BPSK	TRANSFER RATE	6.0Mbps
INPUT POWER (SYSTEM)	120Vac, 60Hz	ENVIRONMENTAL CONDITIONS	25deg.C, 65%RH, 991hPa
TESTED BY	Dean Wang		

CHAN.	CHAN. FREQ. (MHz)	RF POWER LEVEL IN 3kHz BW (dBm)		TOTAL POWER DENSITY (mW)	TOTAL POWER DENSITY (dBm)	MAX. LIMIT (dBm)	PASS / FAIL
		CHAIN 0	CHAIN 1				
149	5745	-14.95	-15.41	0.061	-12.16	8	PASS
157	5785	-15.01	-15.21	0.062	-12.10	8	PASS
165	5825	-15.09	-15.22	0.061	-12.14	8	PASS



FOR CHAIN 0: CH 149

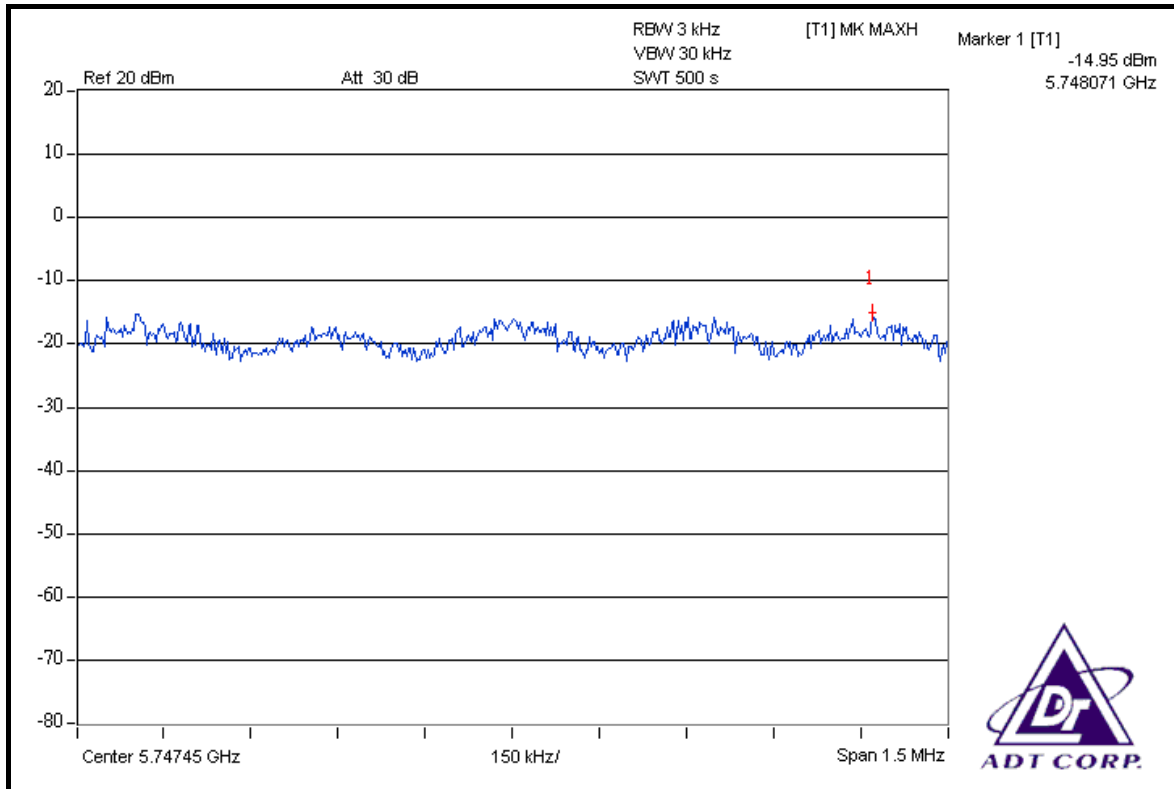

CH 157

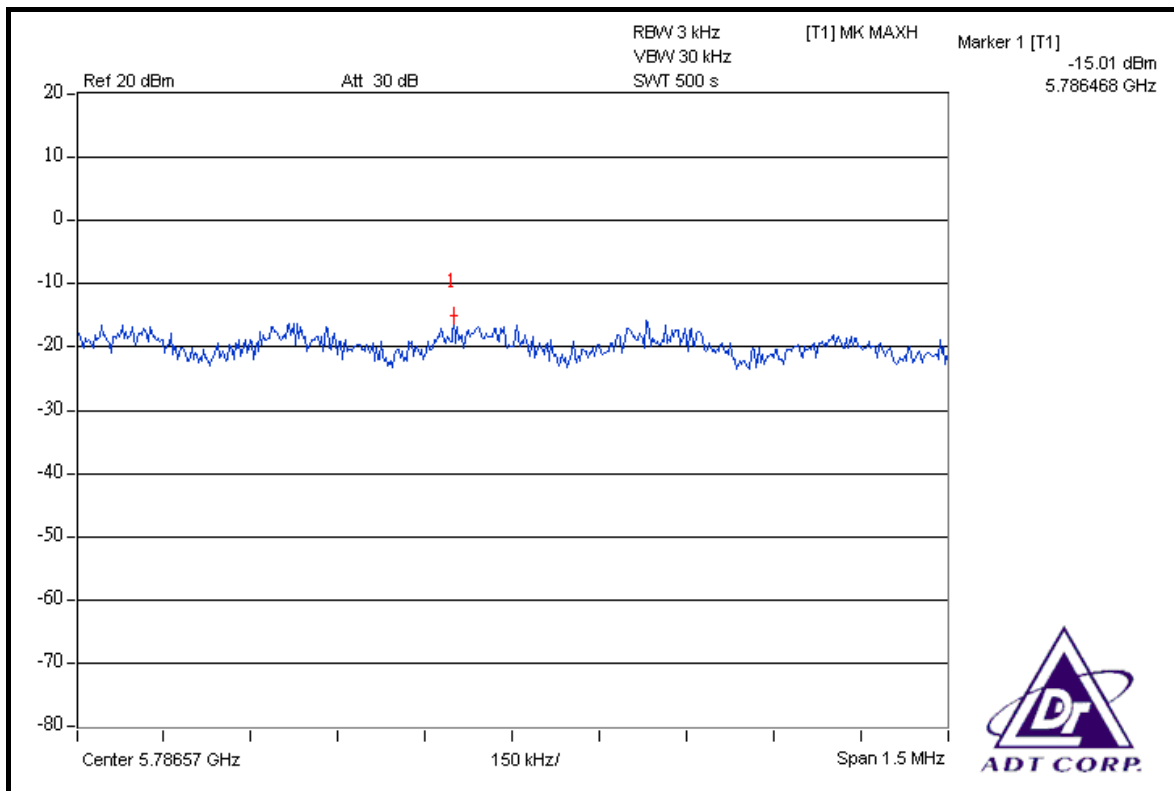



CH 165

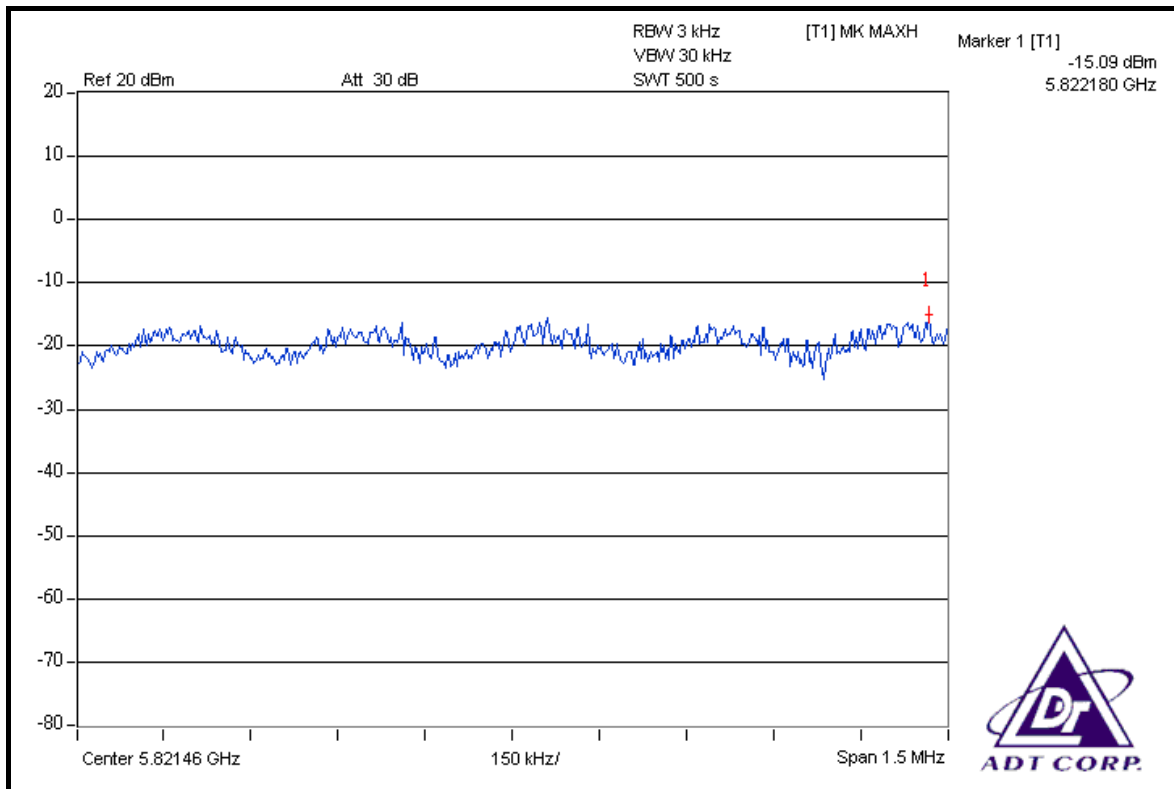

FOR CHAIN 1: CH 149

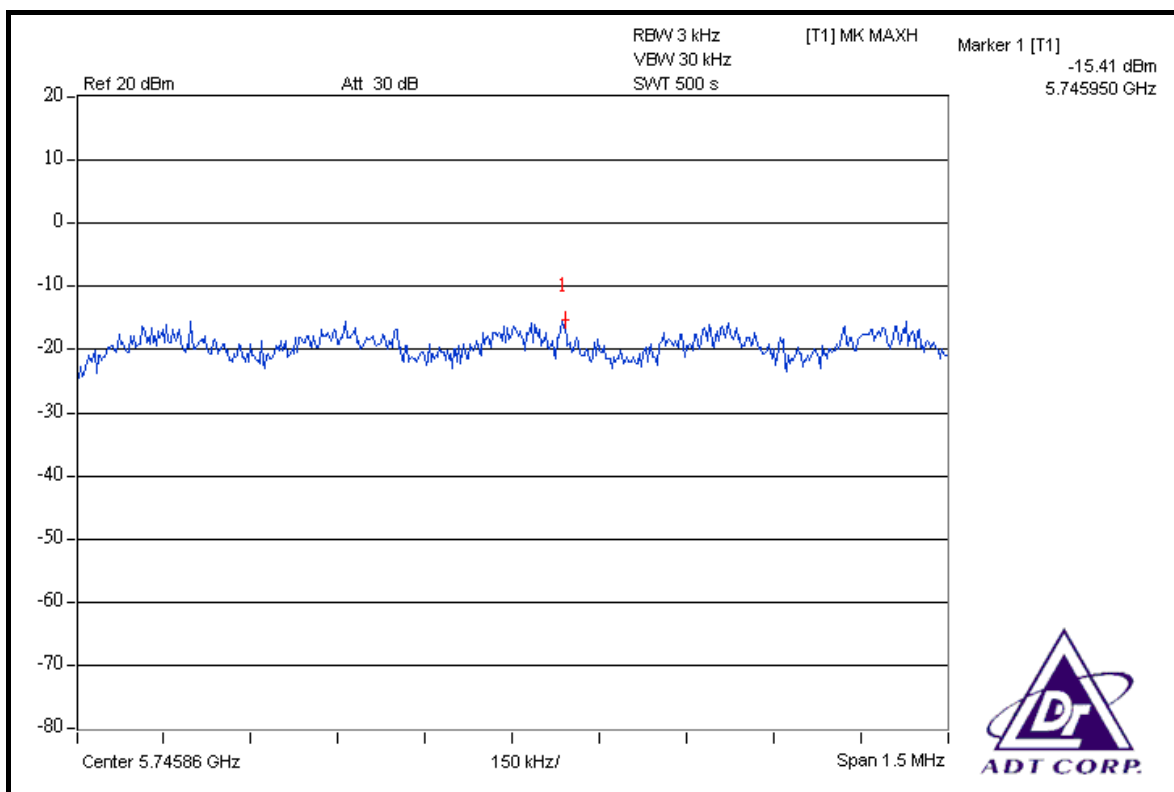



CH 157

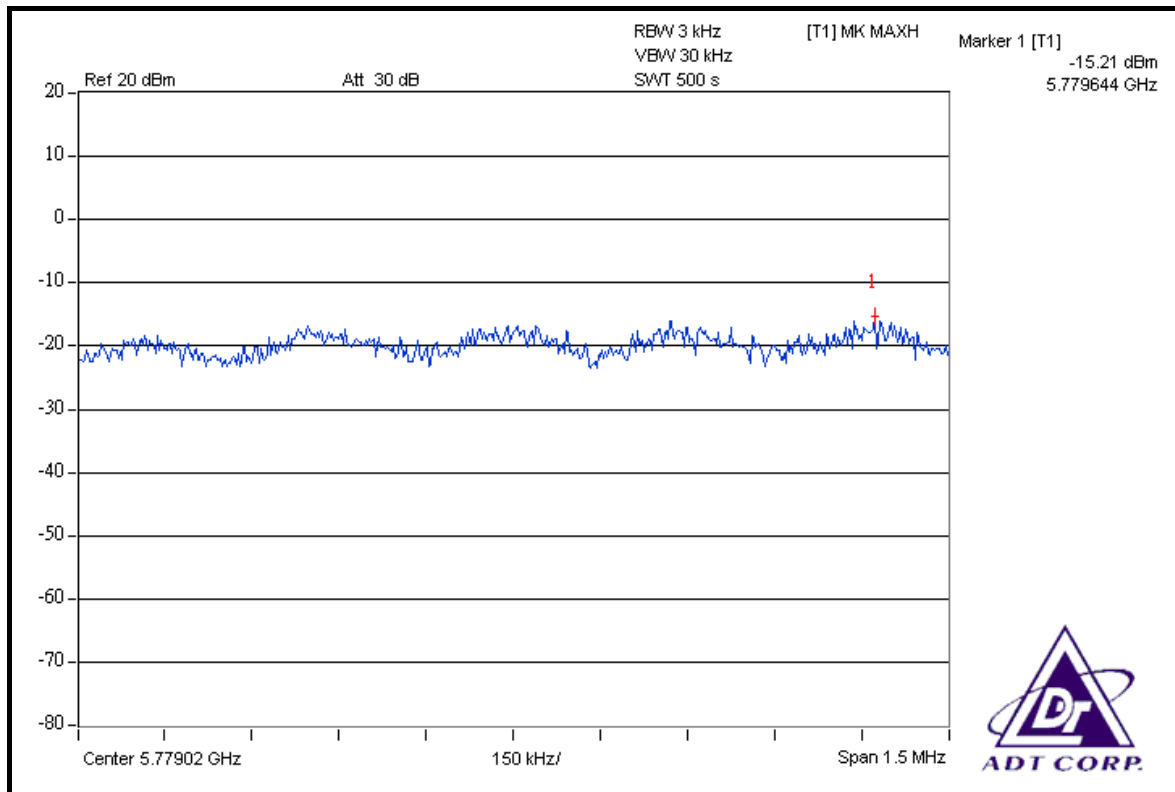

CH 165

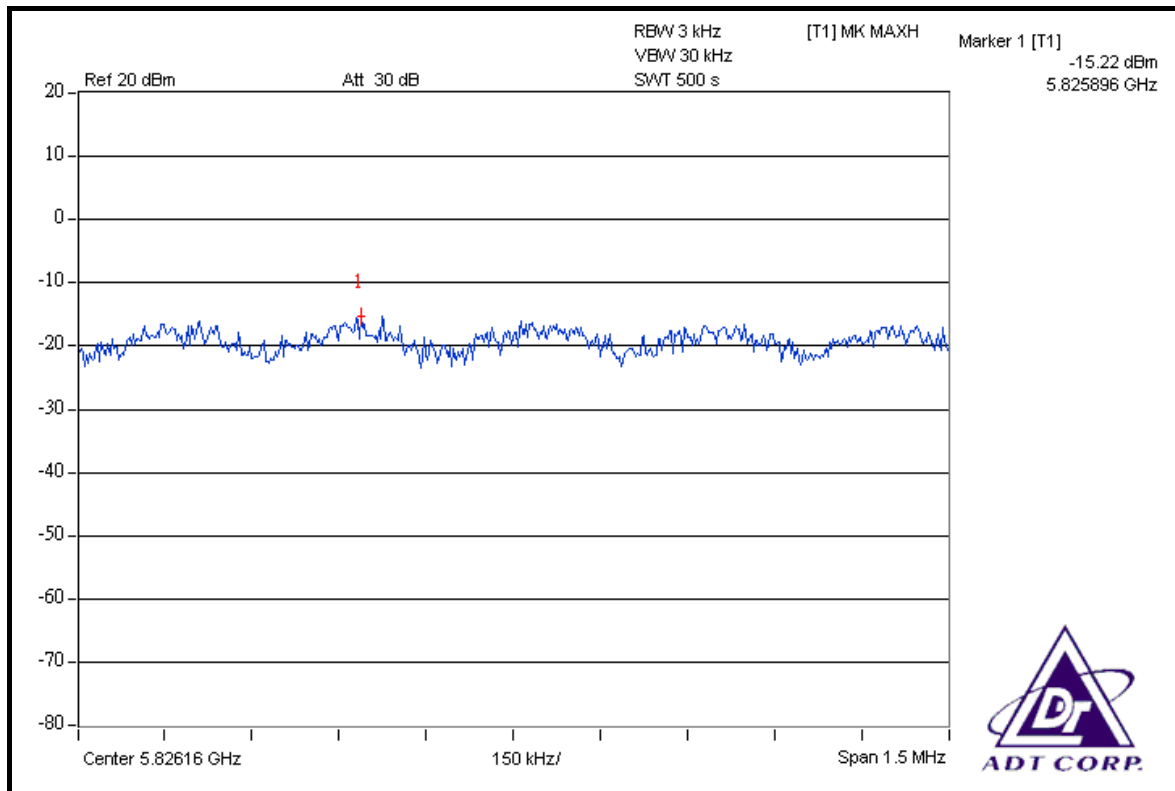



DRAFT 802.11n (20MHz) OFDM MODULATION

MODULATION TYPE	BPSK	TRANSFER RATE	7.2Mbps
INPUT POWER (SYSTEM)	120Vac, 60Hz	ENVIRONMENTAL CONDITIONS	25 deg.C, 65 %RH, 991hPa
TESTED BY	Dean Wang		

CHAN.	CHAN. FREQ. (MHz)	RF POWER LEVEL IN 3kHz BW (dBm)		TOTAL POWER DENSITY (mW)	TOTAL POWER DENSITY (dBm)	MAX. LIMIT (dBm)	PASS / FAIL
		CHAIN 0	CHAIN 1				
149	5745	-17.14	-15.99	0.044	-13.52	8	PASS
157	5785	-16.98	-16.24	0.044	-13.58	8	PASS
165	5825	-16.91	-15.76	0.047	-13.29	8	PASS



FOR CHAIN 0: CH 149

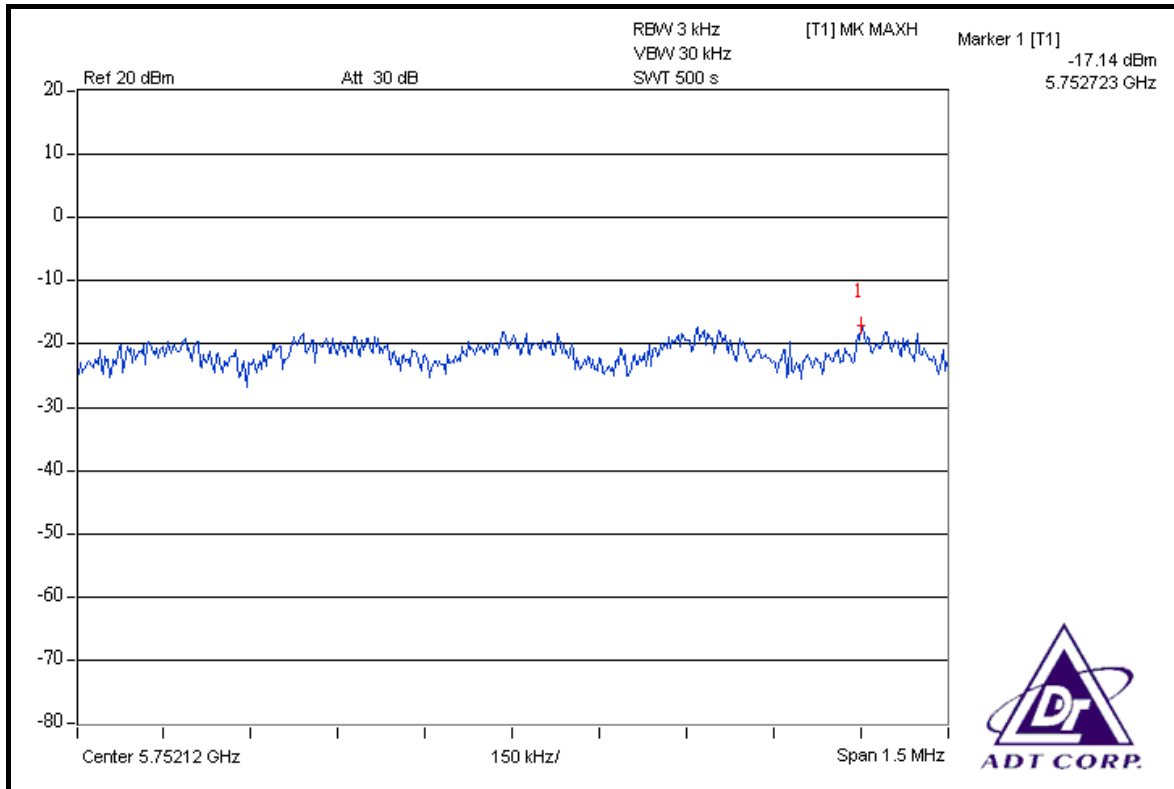

CH 157

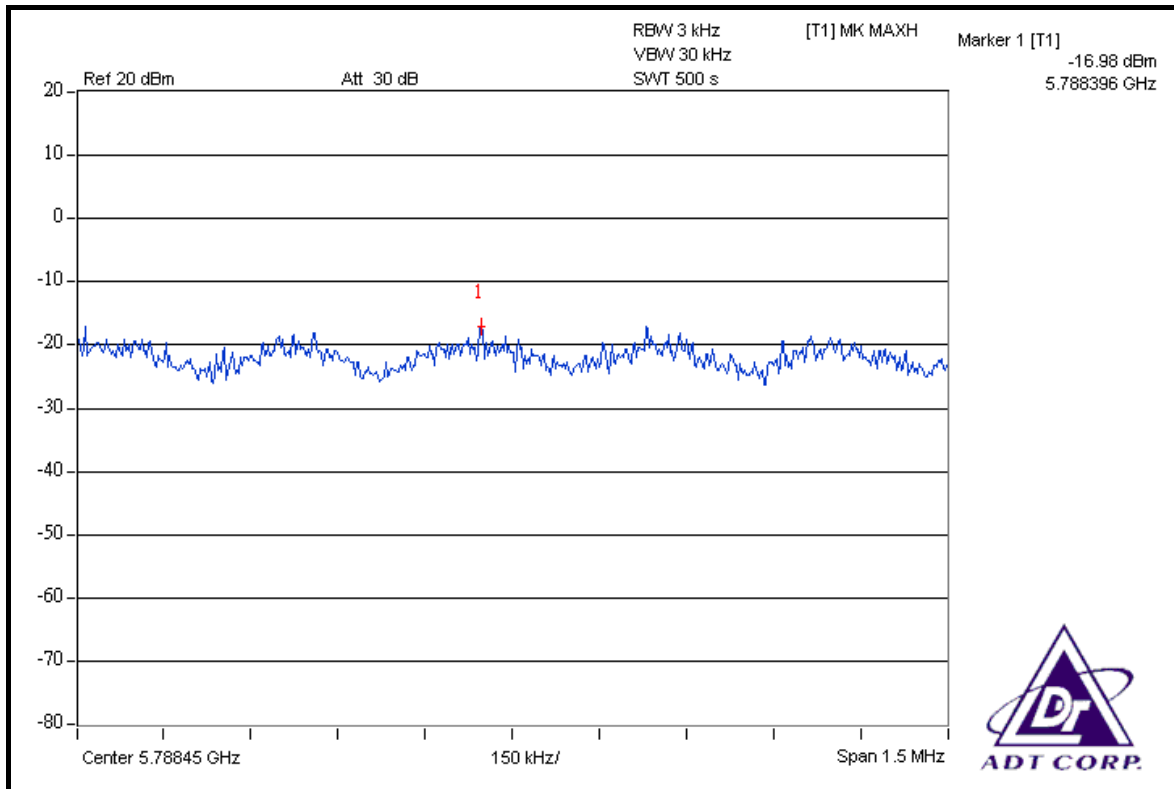



CH 165

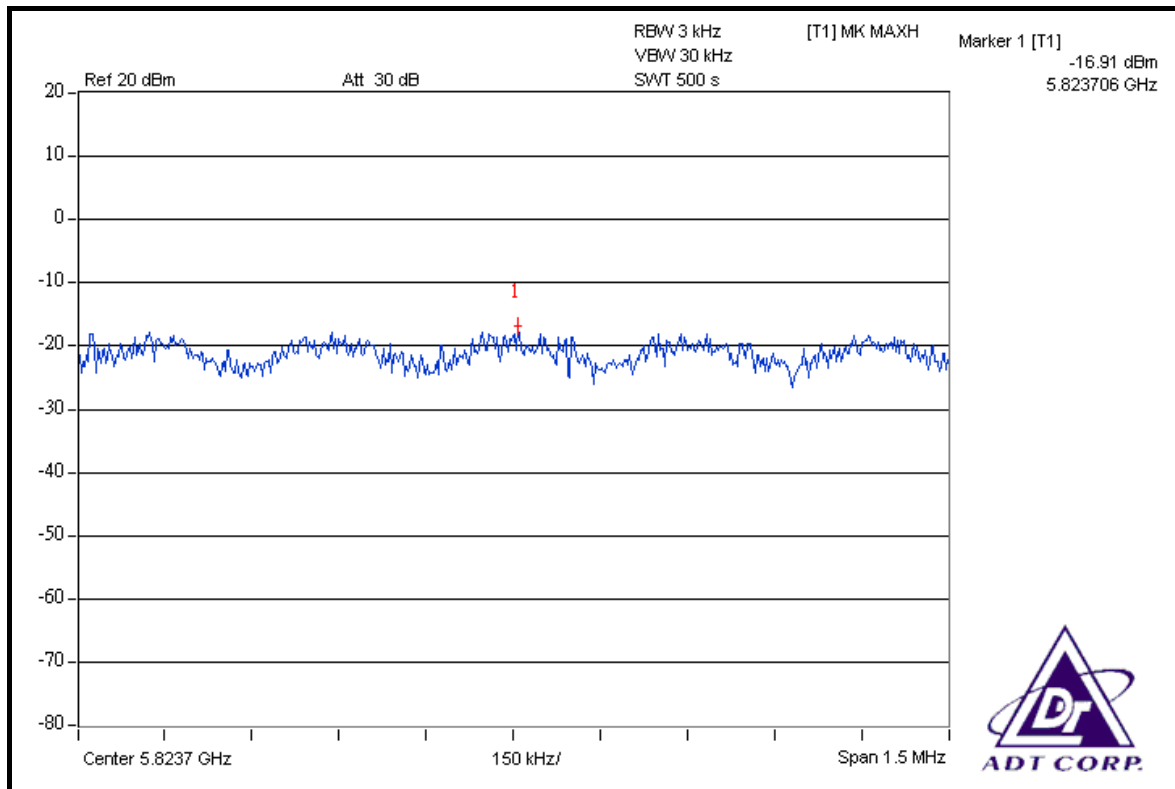

FOR CHAIN 1: CH 149

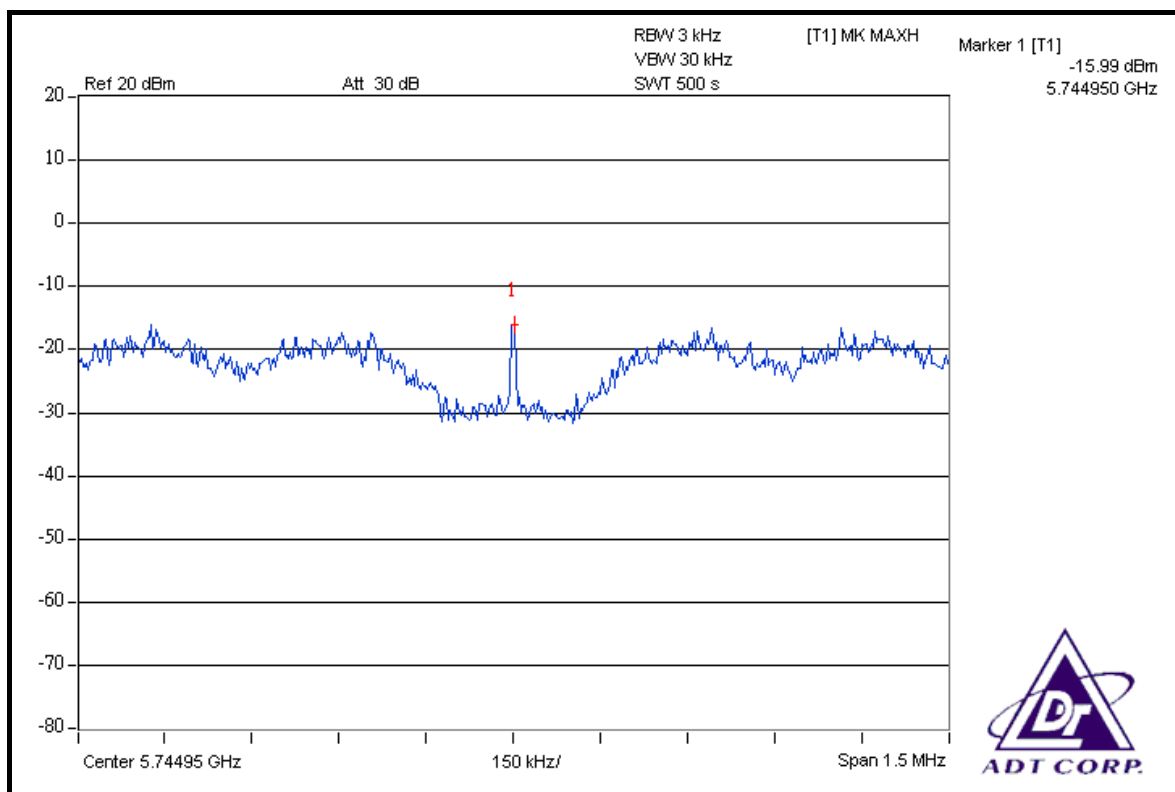



CH 157

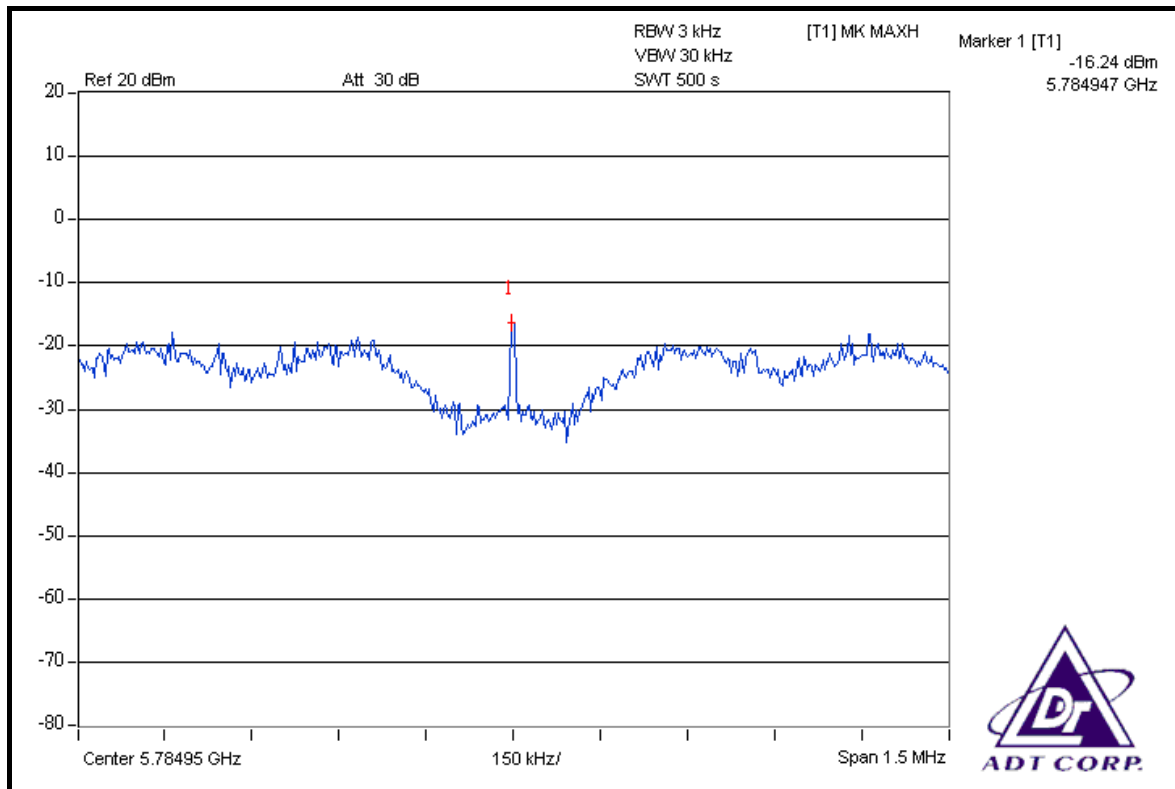

CH 165

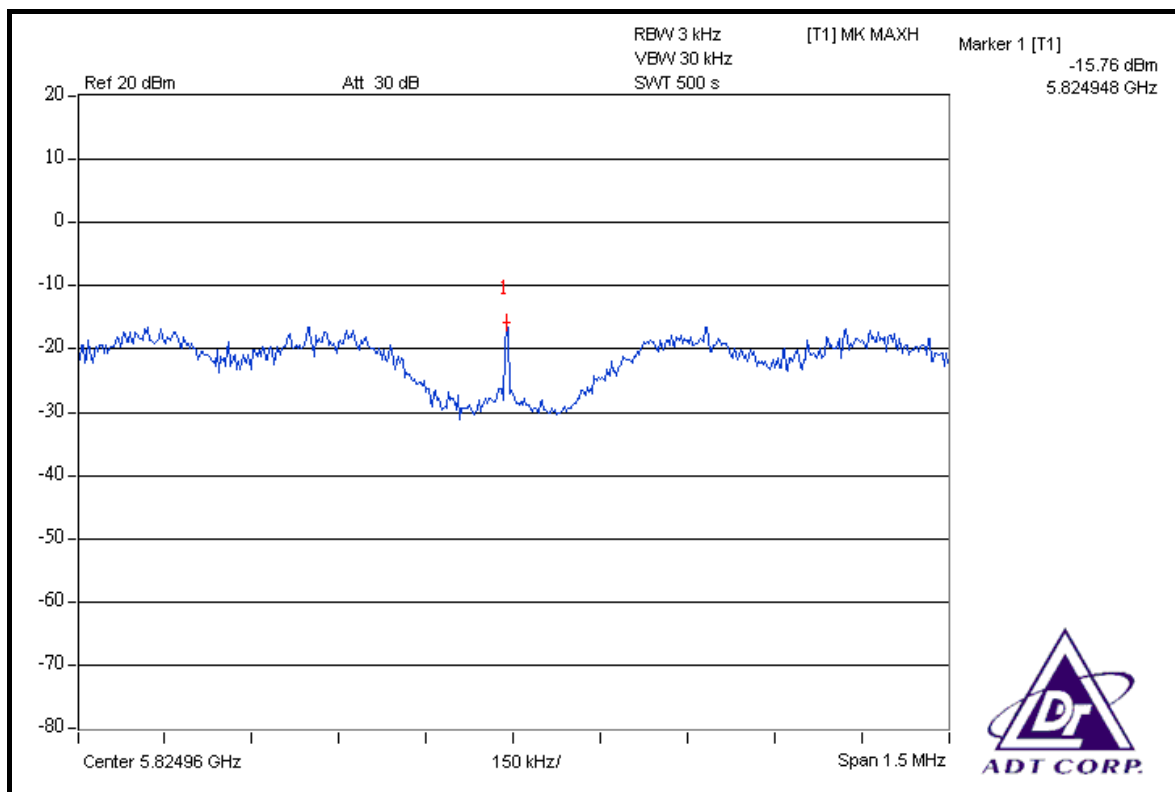



DRAFT 802.11n (40MHz) OFDM MODULATION

MODULATION TYPE	BPSK	TRANSFER RATE	15Mbps
INPUT POWER (SYSTEM)	120Vac, 60Hz	ENVIRONMENTAL CONDITIONS	25deg.C, 65 %RH, 991hPa
TESTED BY	Dean Wang		

CHAN.	CHAN. FREQ. (MHz)	RF POWER LEVEL IN 3kHz BW (dBm)		TOTAL POWER DENSITY (mW)	TOTAL POWER DENSITY (dBm)	MAX. LIMIT (dBm)	PASS / FAIL
		CHAIN 0	CHAIN 1				
151	5755	-19.58	-17.23	0.030	-15.24	8	PASS
159	5795	-19.57	-17.09	0.031	-15.15	8	PASS



FOR CHAIN 0: CH 151

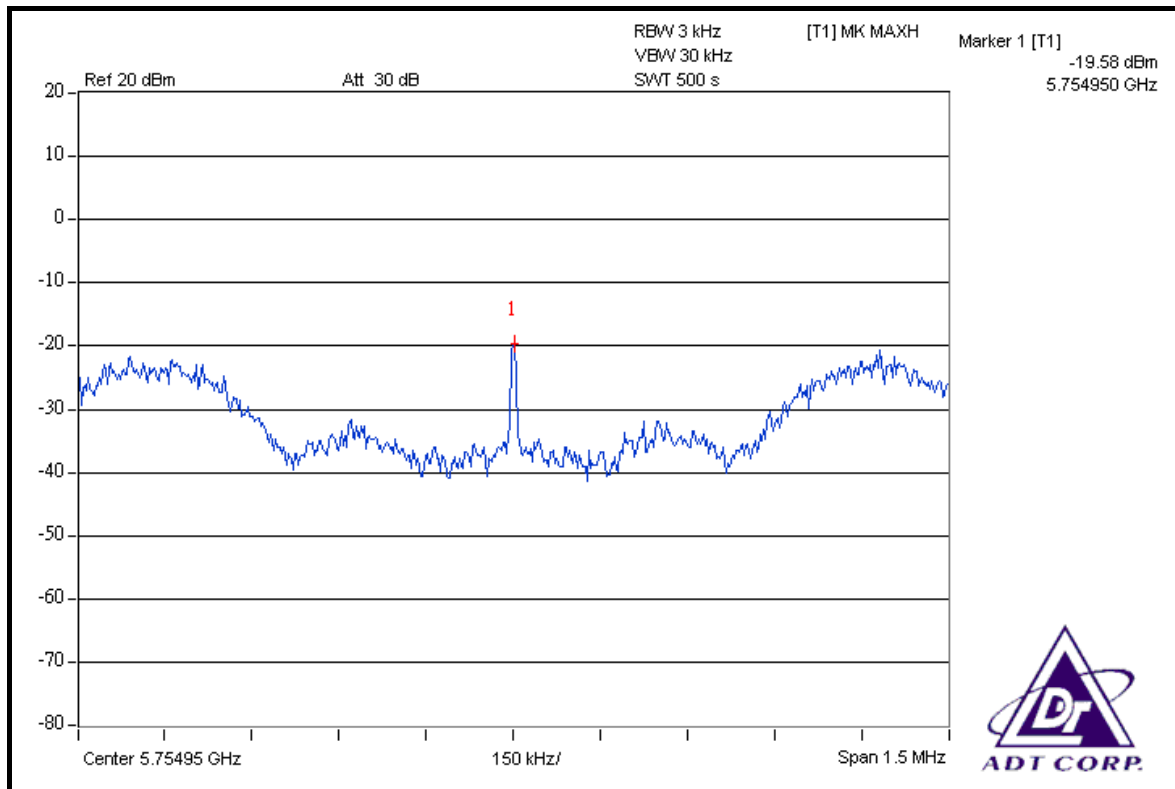

CH 159

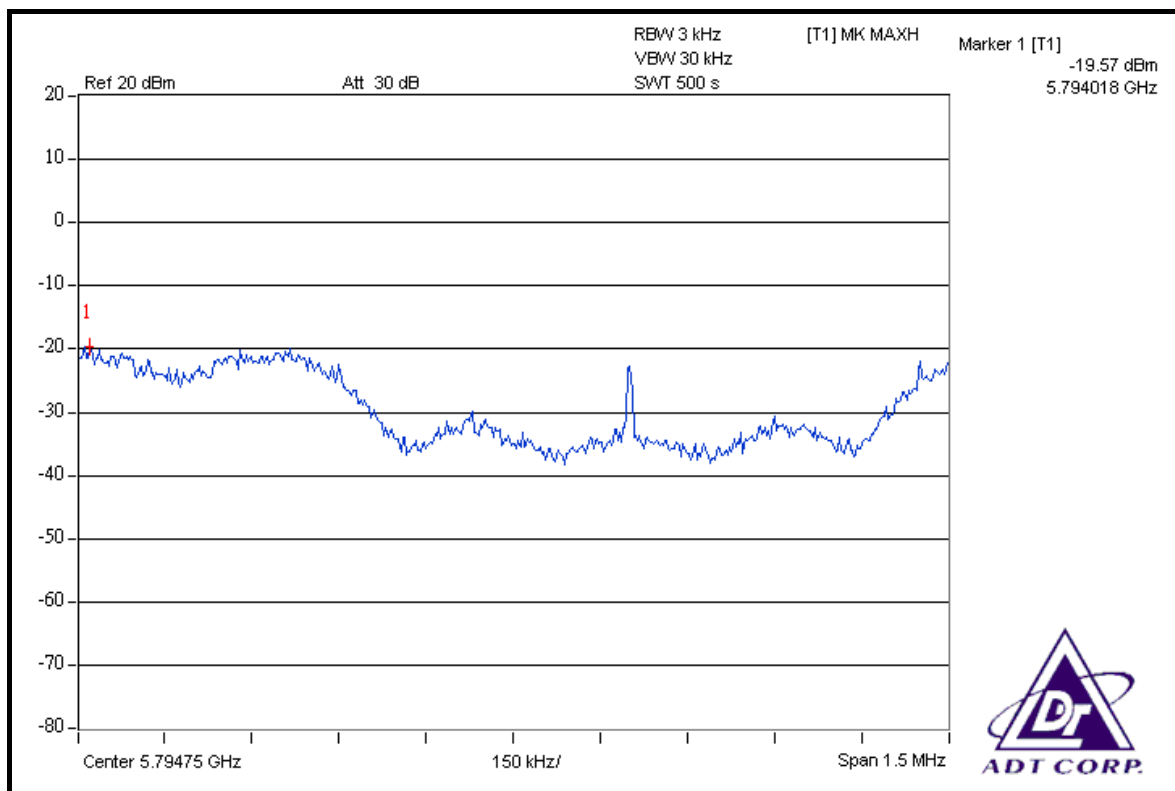



FOR CHAIN 1: CH 151

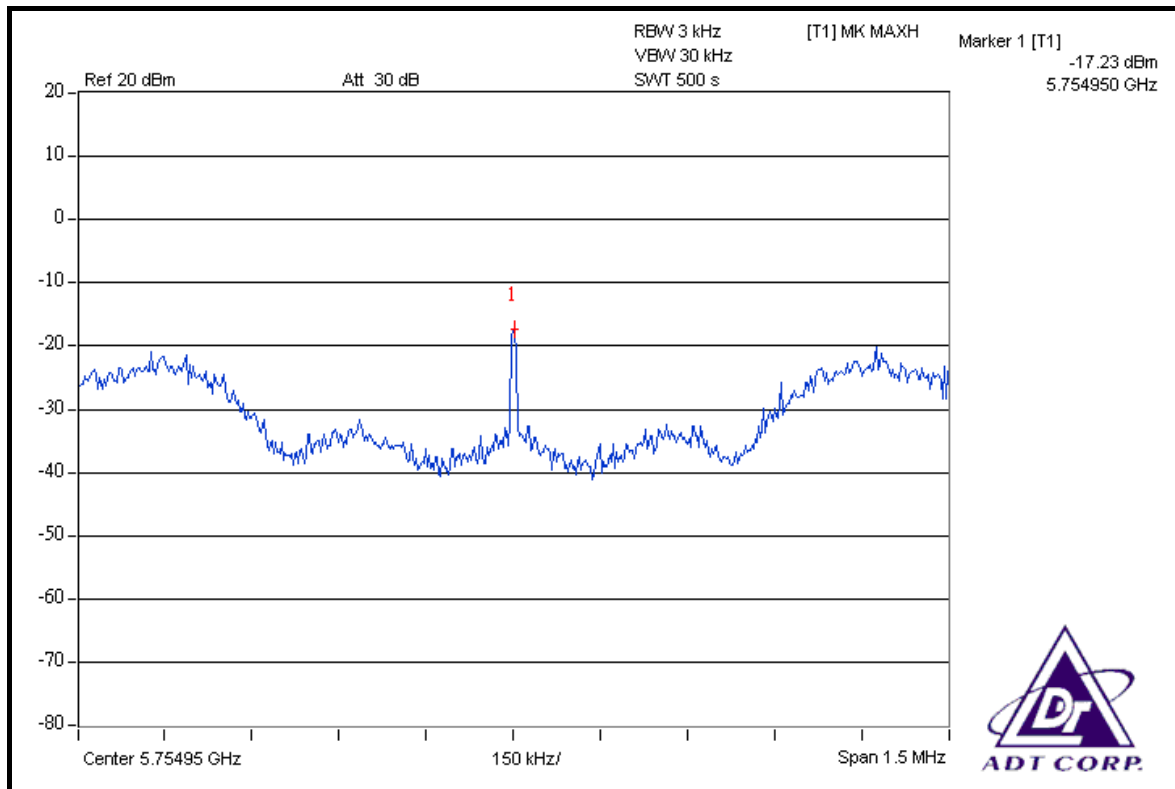

CH 159

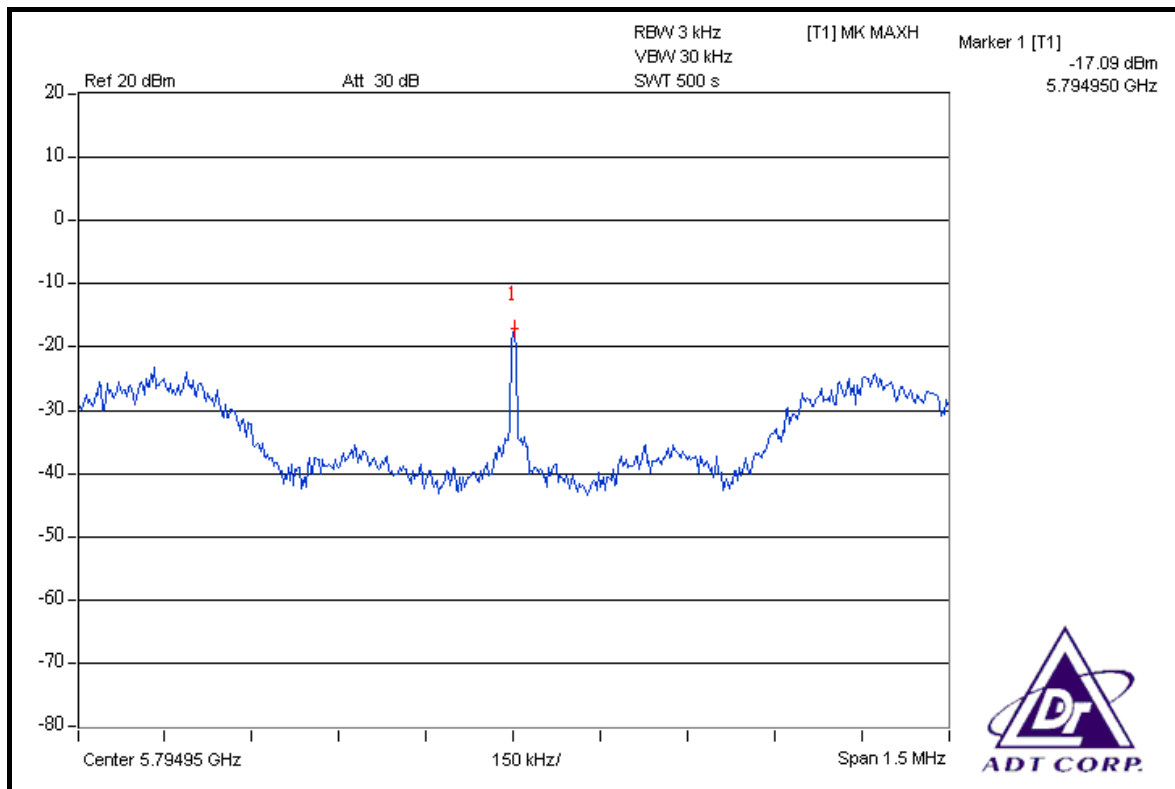



5.6 BAND EDGES MEASUREMENT

5.6.1 LIMITS OF BAND EDGES MEASUREMENT

Below -20dB of the highest emission level of operating band (in 100kHz Resolution Bandwidth).

5.6.2 TEST INSTRUMENTS

DESCRIPTION & MANUFACTURER	MODEL NO.	SERIAL NO.	DATE OF CALIBRATION	CALIBRATED UNTIL
Test Receiver ROHDE & SCHWARZ	ESIB7	100212	May 28, 2008	May 27, 2009
Spectrum Analyzer ROHDE & SCHWARZ	FSP40	100269	Aug. 08, 2008	Aug. 07, 2009
BILOG Antenna SCHWARZBECK	VULB9168	9168-156	Apr. 25, 2008	Apr. 24, 2009
HORN Antenna SCHWARZBECK	BBHA 9120 D	9120D-563	Aug. 06, 2008	Aug. 05, 2009
HORN Antenna SCHWARZBECK	BBHA 9170	BBHA9170242	Jan. 07, 2008	Jan. 06, 2009
Preamplifier Agilent	8449B	3008A01911	Sep. 10, 2008	Sep. 09, 2009
Preamplifier Agilent	8447D	2944A10634	Dec. 13, 2007	Dec. 12, 2008
RF signal cable HUBER+SUHNNER	SUCOFLEX 104	274039/223650	Nov. 08, 2007	Nov. 07, 2008
RF signal cable Worken	8D-FB	Cable-HYCH9-01	Aug. 09, 2008	Aug. 08, 2009
Software	ADT Radiated V7.6	NA	NA	NA
Antenna Tower EMCO	2070/2080	512.835.4684	NA	NA
Turn Table EMCO	2087-2.03	NA	NA	NA
Antenna Tower &Turn Table Controller EMCO	2090	NA	NA	NA
26GHz ~ 40GHz Amplifier	EM26400	07026401	May 06, 2008	May 05, 2009

NOTE: The calibration interval of the above test instruments is 12 months and the calibrations are traceable to NML/ROC and NIST/USA.

5.6.3 TEST PROCEDURE

- a. The EUT was placed on the top of a rotating table 0.8 meters above the ground at a 3 meter semi-anechoic chamber. The table was rotated 360 degrees to determine the position of the highest radiation.
- b. The EUT was set 3 meters away from the interference-receiving antenna, which was mounted on the top of a variable-height antenna tower.
- c. The antenna is a broadband antenna, and its height is varied from one meter to four meters above the ground to determine the maximum value of the field strength. Both horizontal and vertical polarizations of the antenna are set to make the measurement.
- d. For each suspected emission, the EUT was arranged to its worst case and then the antenna was tuned to heights from 1 meter to 4 meters and the rotatable table was turned from 0 degrees to 360 degrees to find the maximum reading.
- e. Set both RBW and VBW of spectrum analyzer to 100kHz and 300kHz with suitable frequency span including 100MHz bandwidth from band edge. The band edges was measured and recorded.

NOTE: The resolution bandwidth of test receiver/spectrum analyzer is 1MHz and the video bandwidth is 10Hz for Average detection (AV) at frequency above 1GHz.

5.6.4 DEVIATION FROM TEST STANDARD

No deviation

5.6.5 EUT OPERATING CONDITION

Same as Item 5.3.6

5.6.6 TEST RESULTS

The spectrum plots are attached on the following pages. D1 line indicates the highest level, D2 line indicates the 20dB offset below D1. It shows compliance with the requirement in part 15.247(d).

802.11a OFDM MODULATION

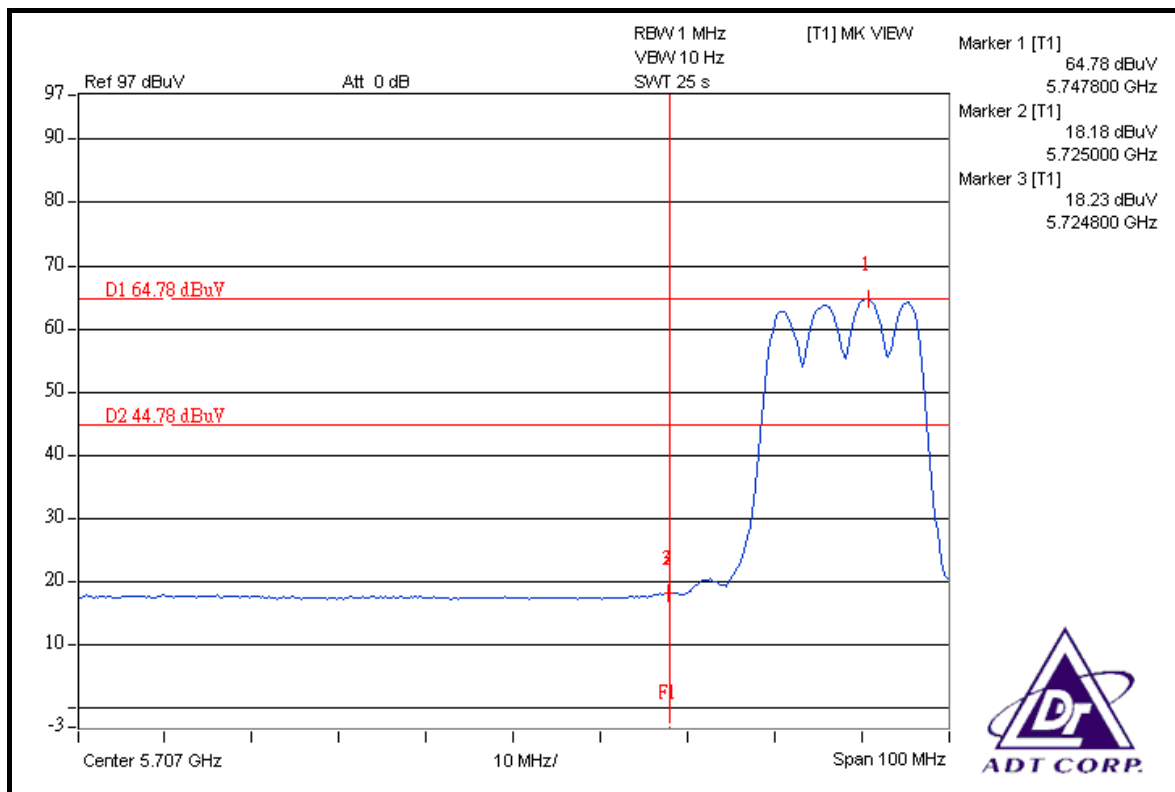
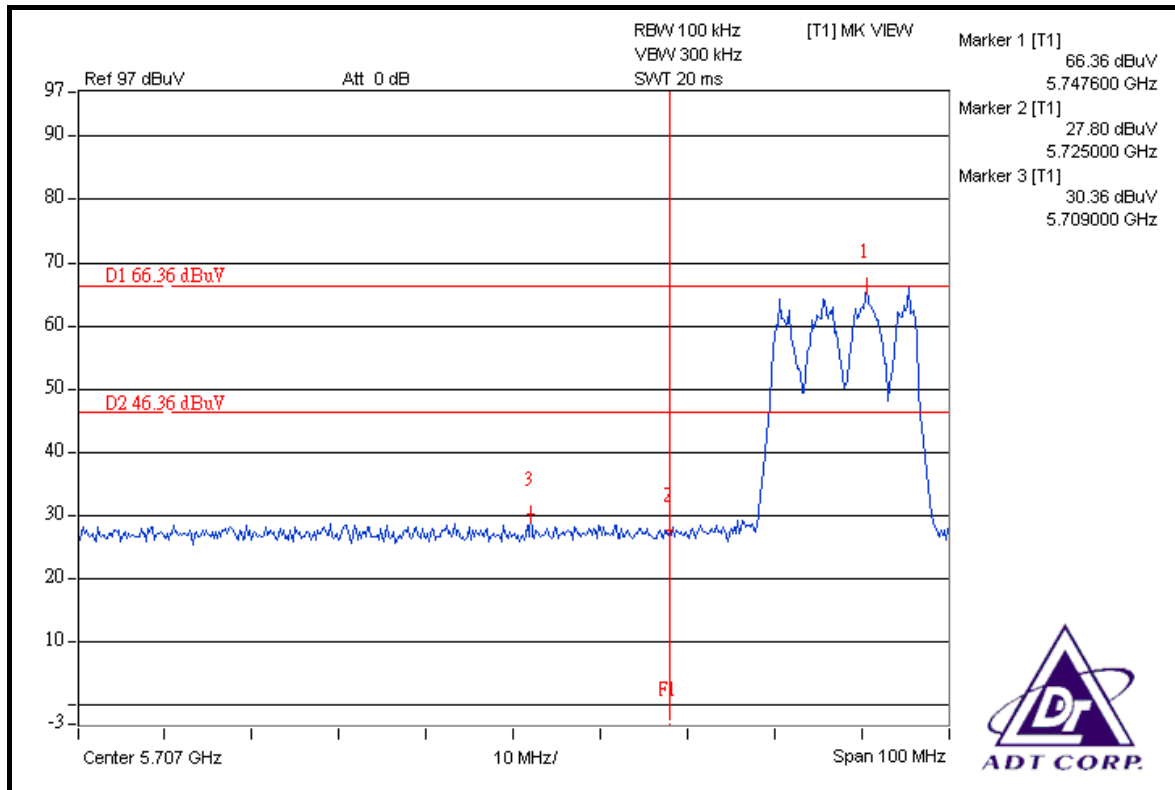

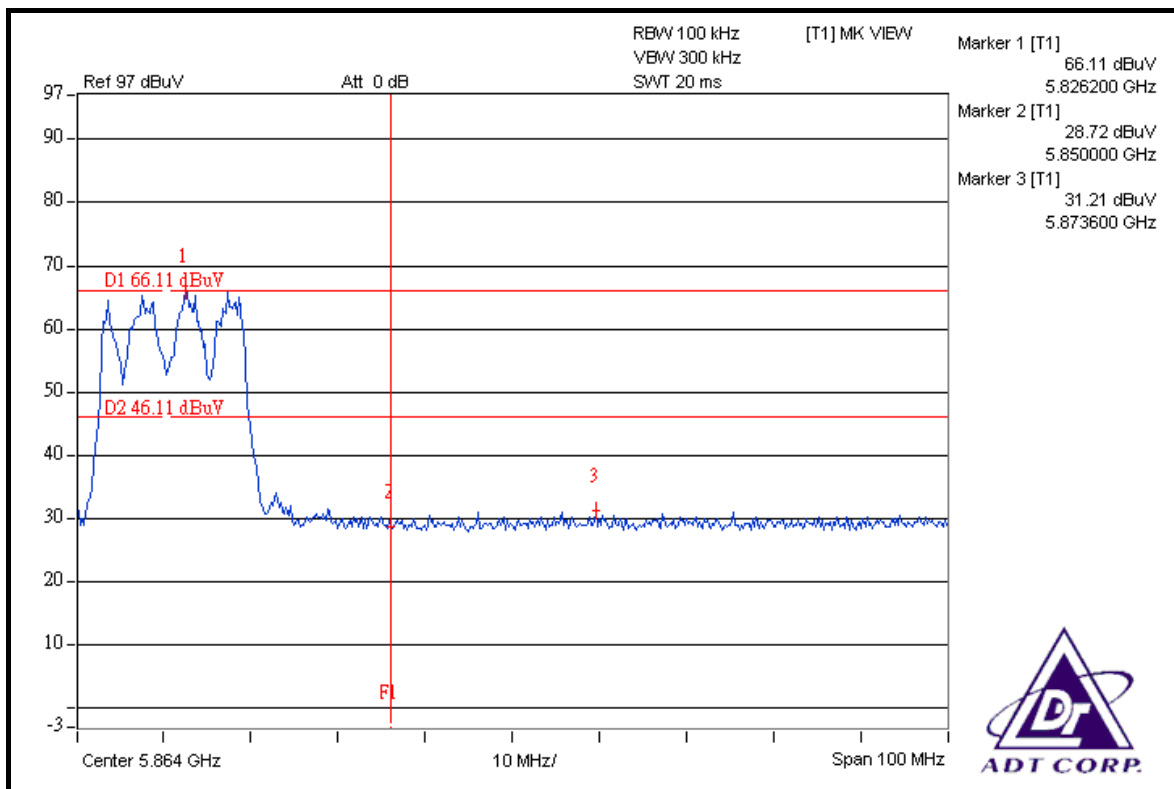
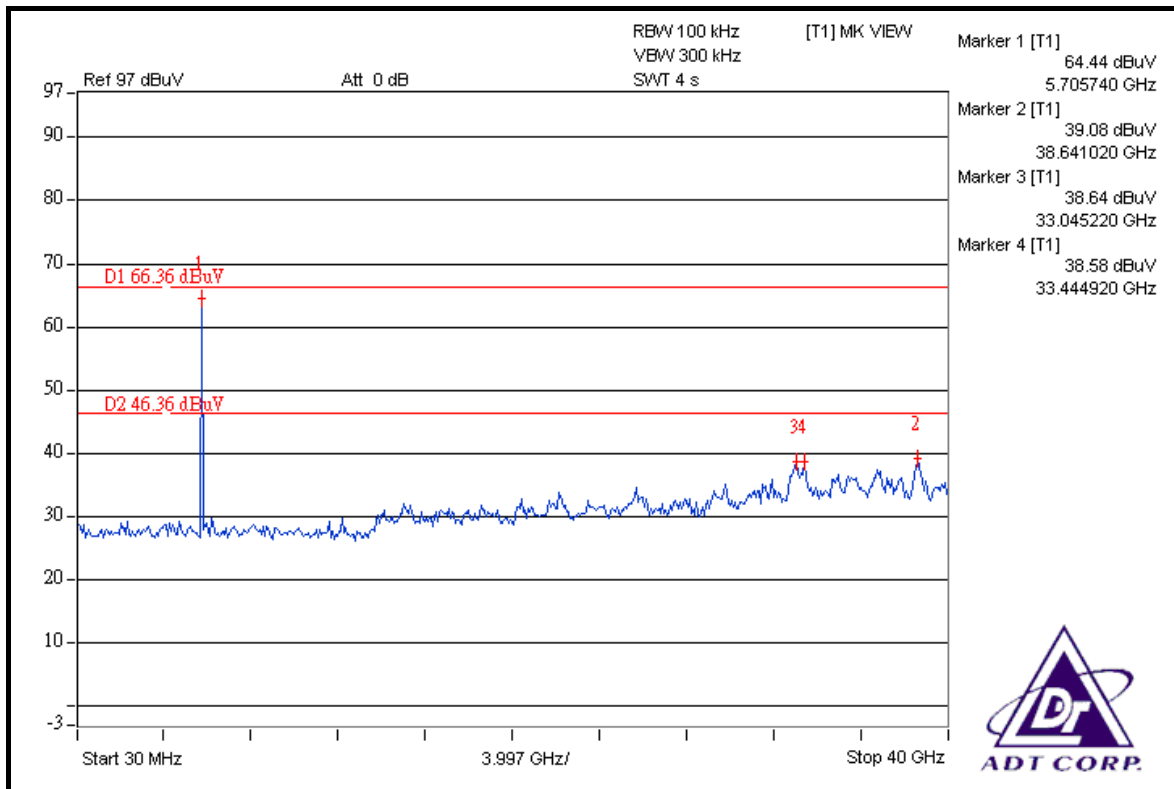

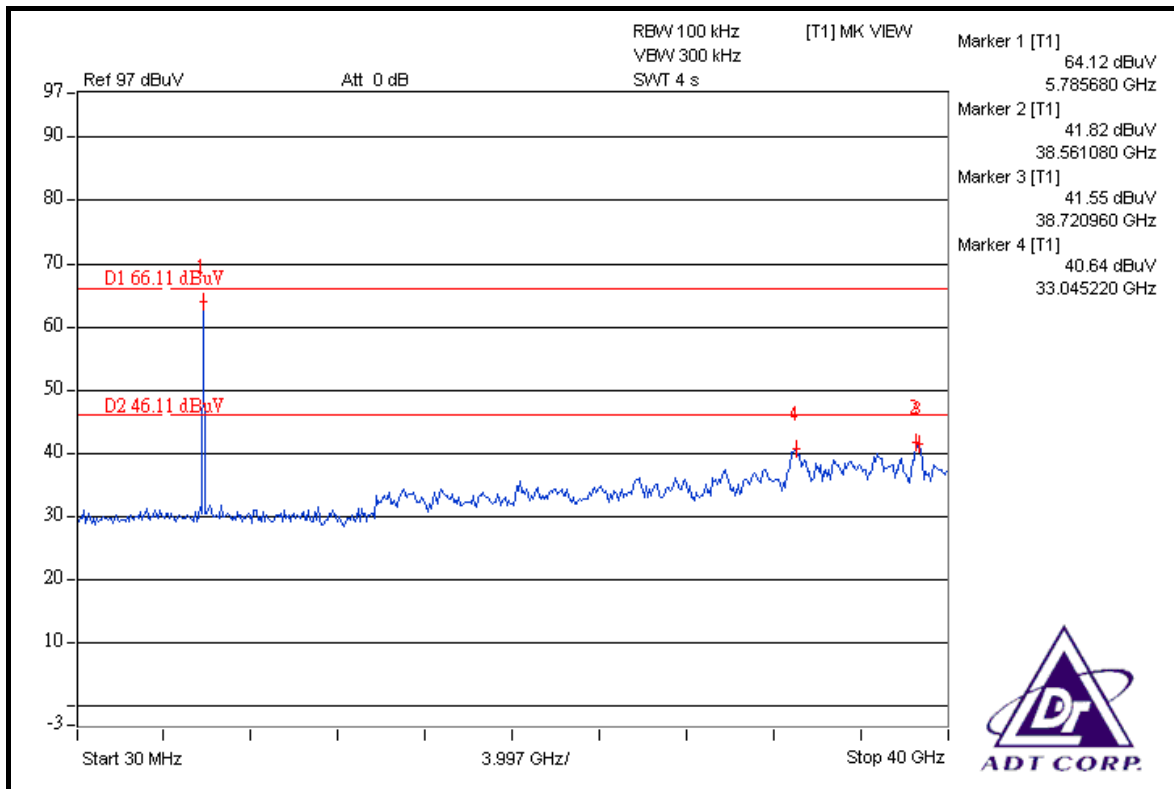
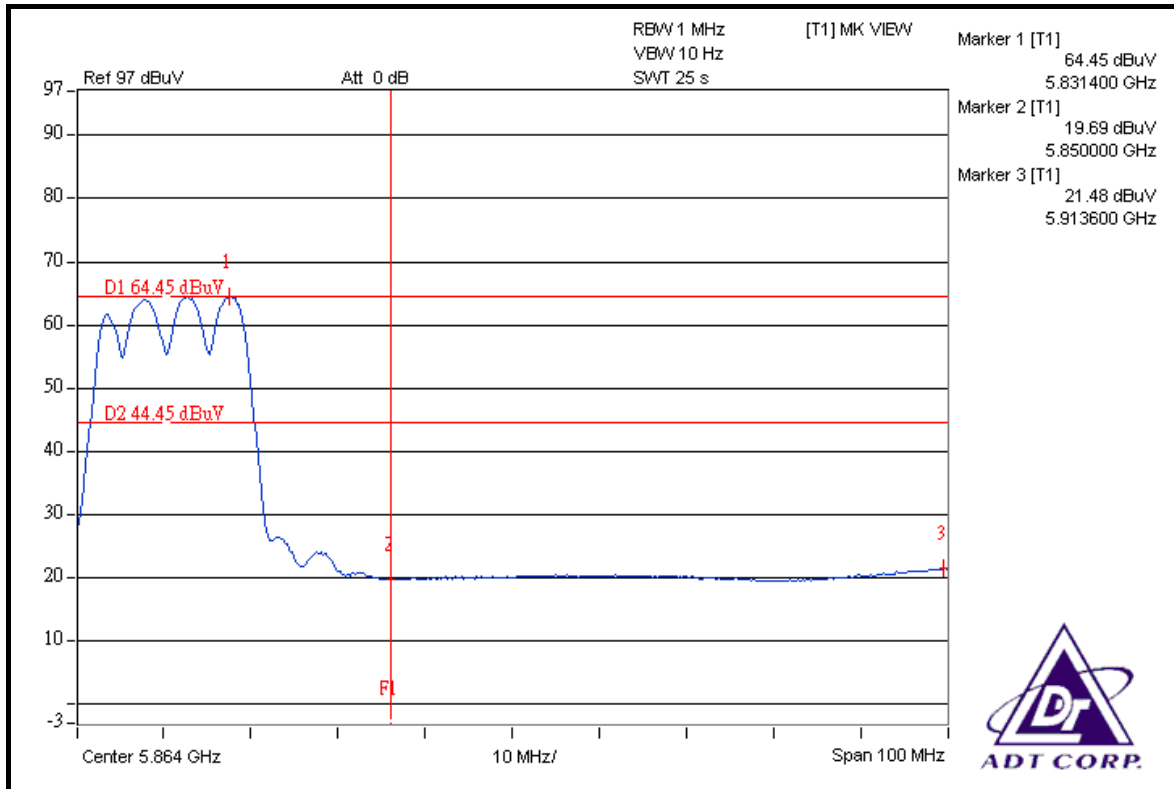

DRAFT 802.11n (20MHz) OFDM MODULATION

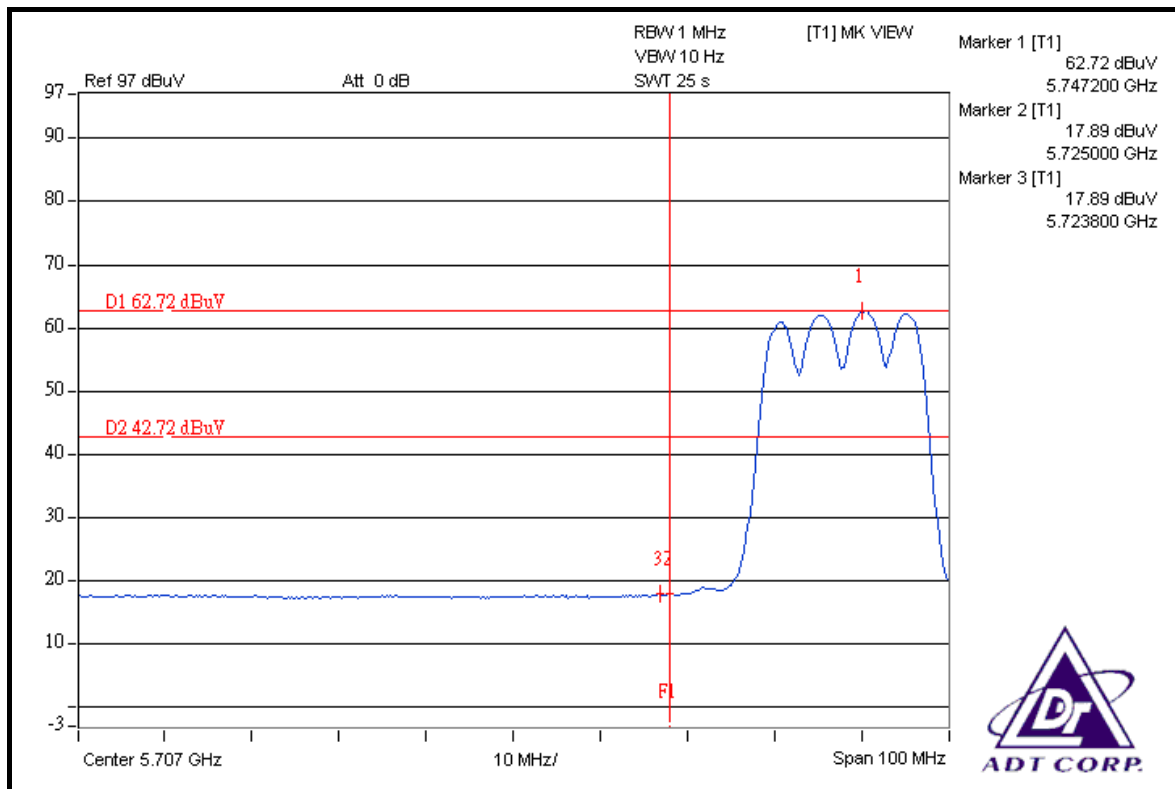
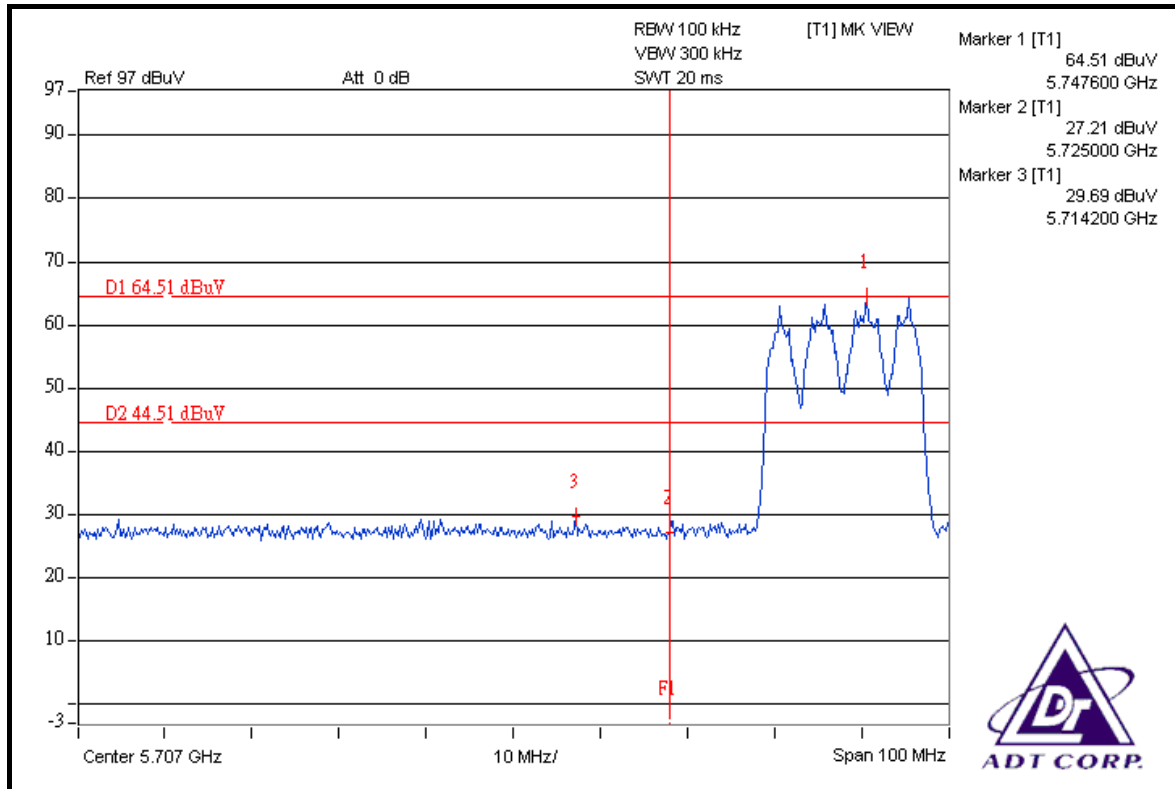

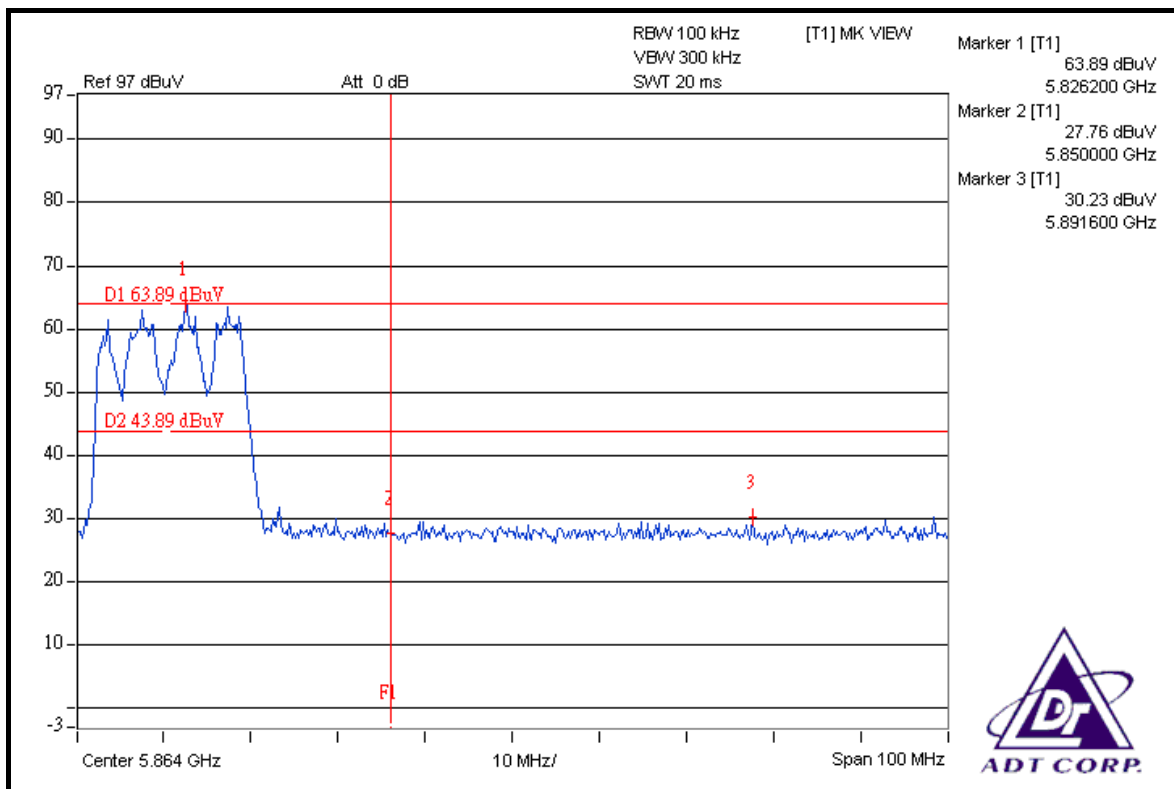
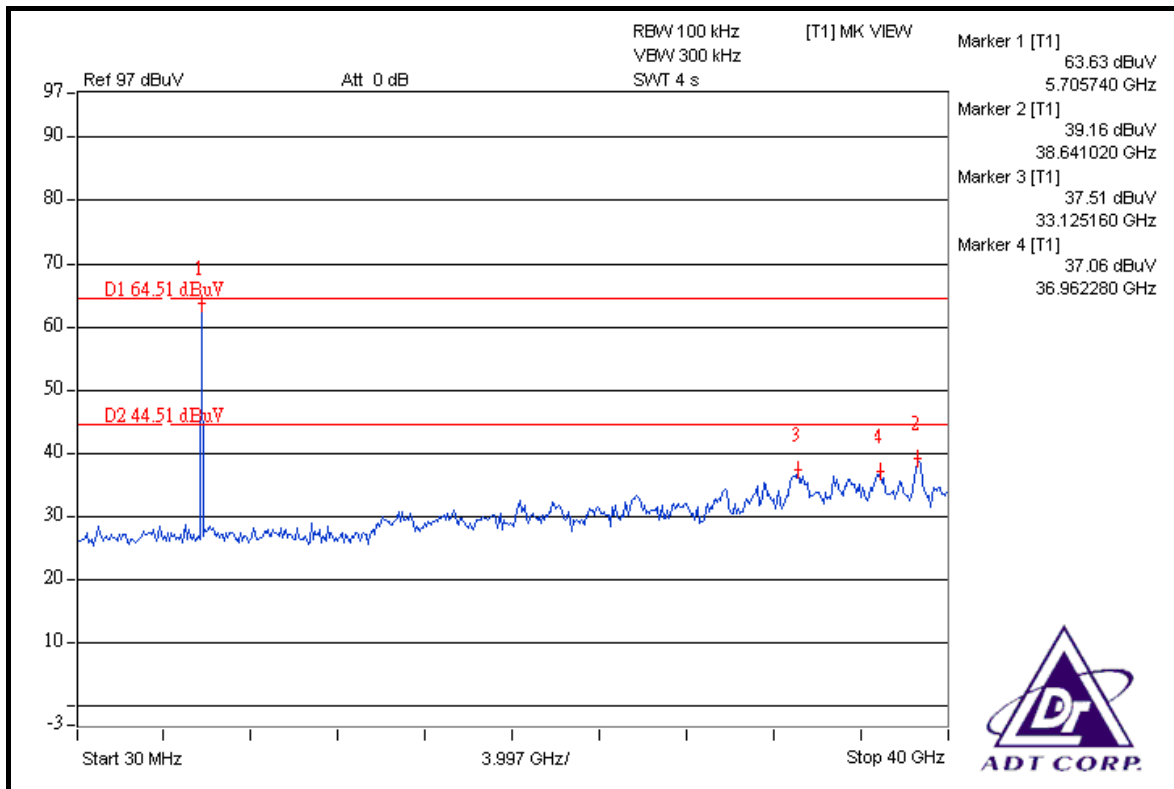

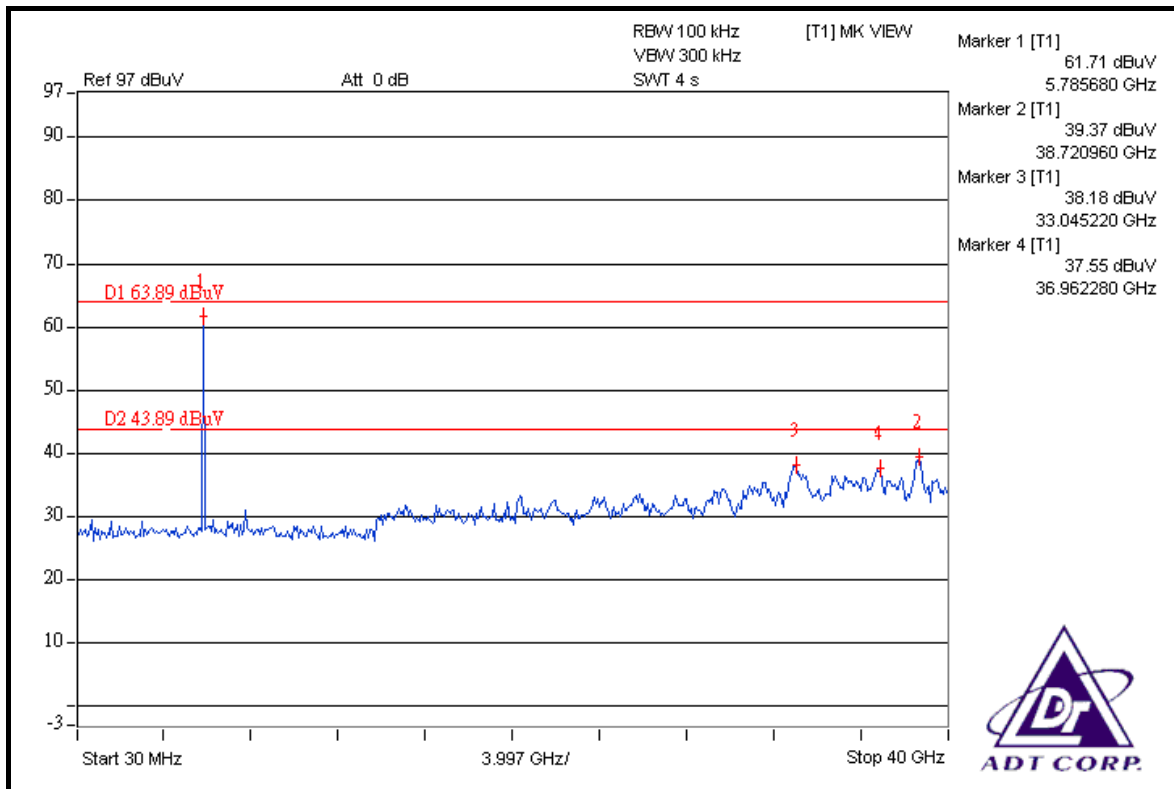
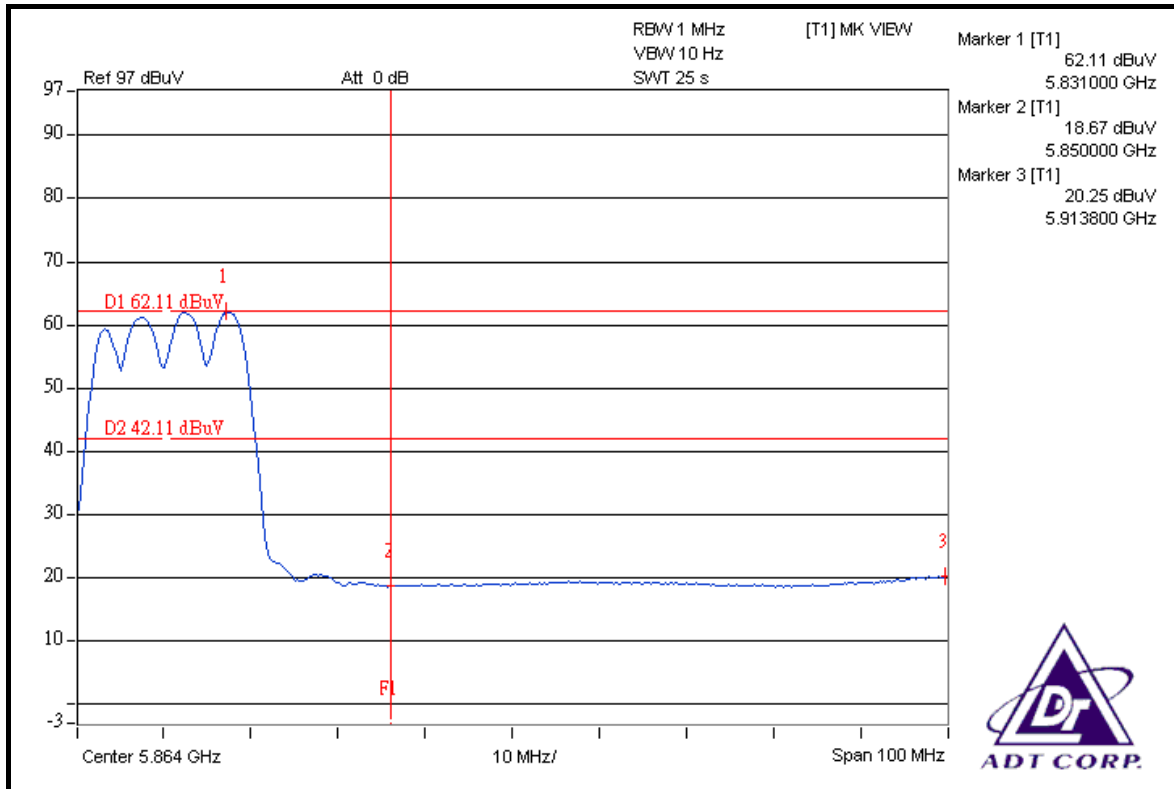

DRAFT 802.11n (40MHz) OFDM MODULATION

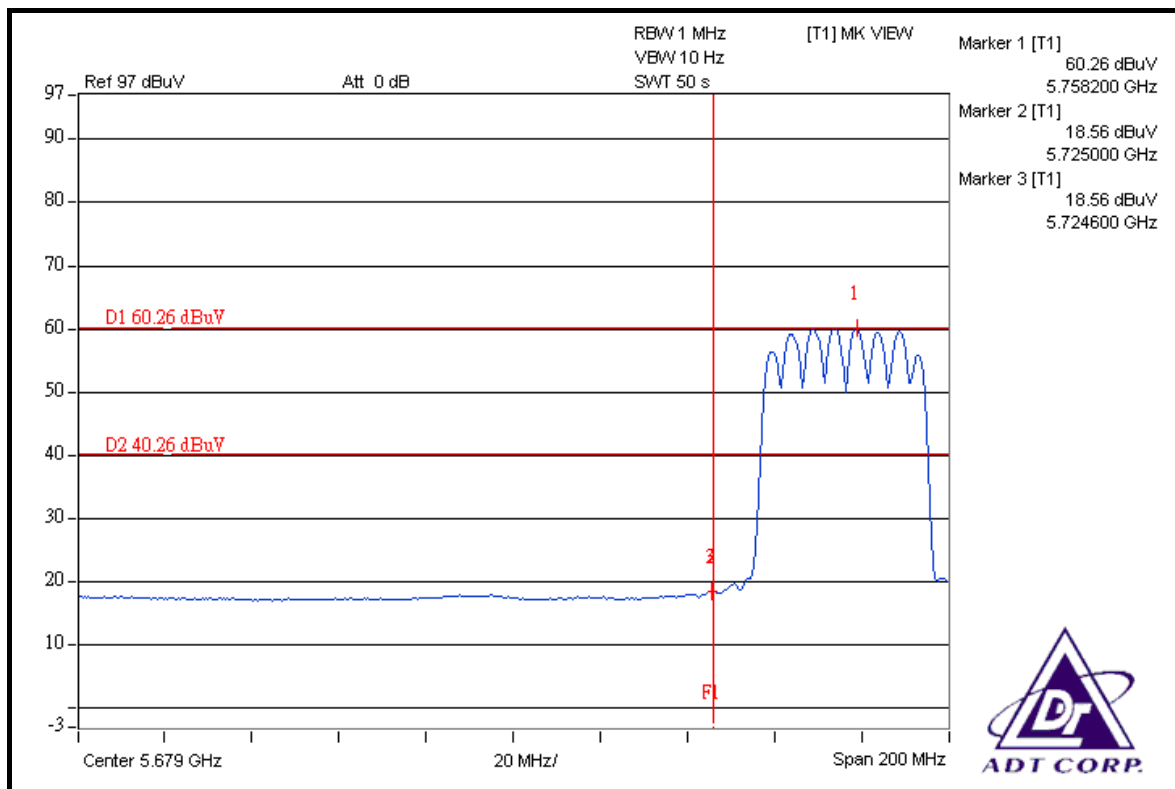
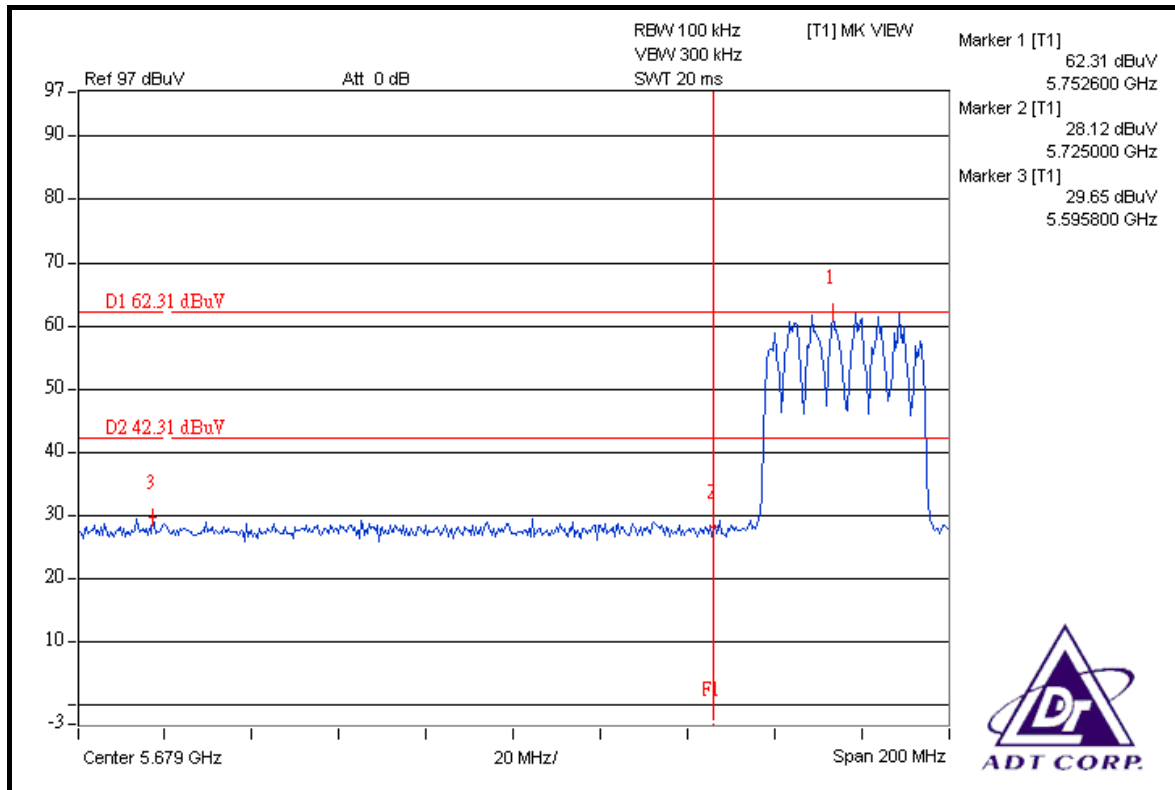

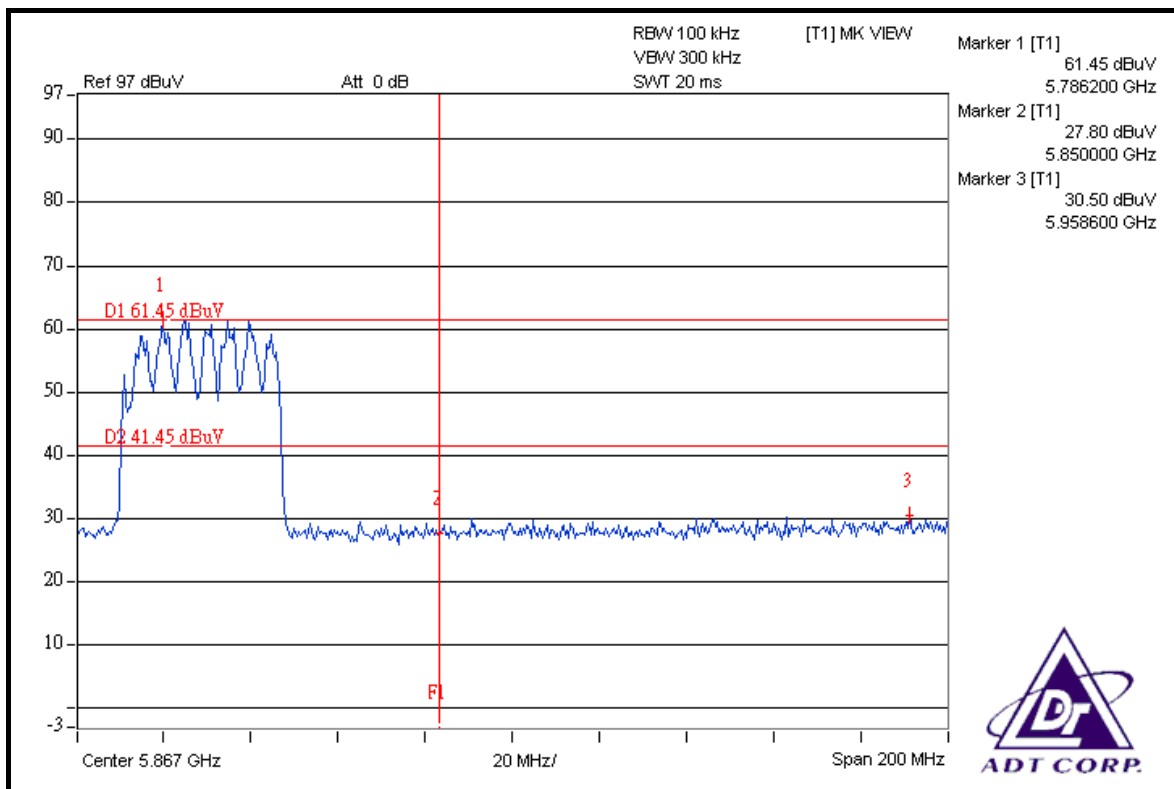
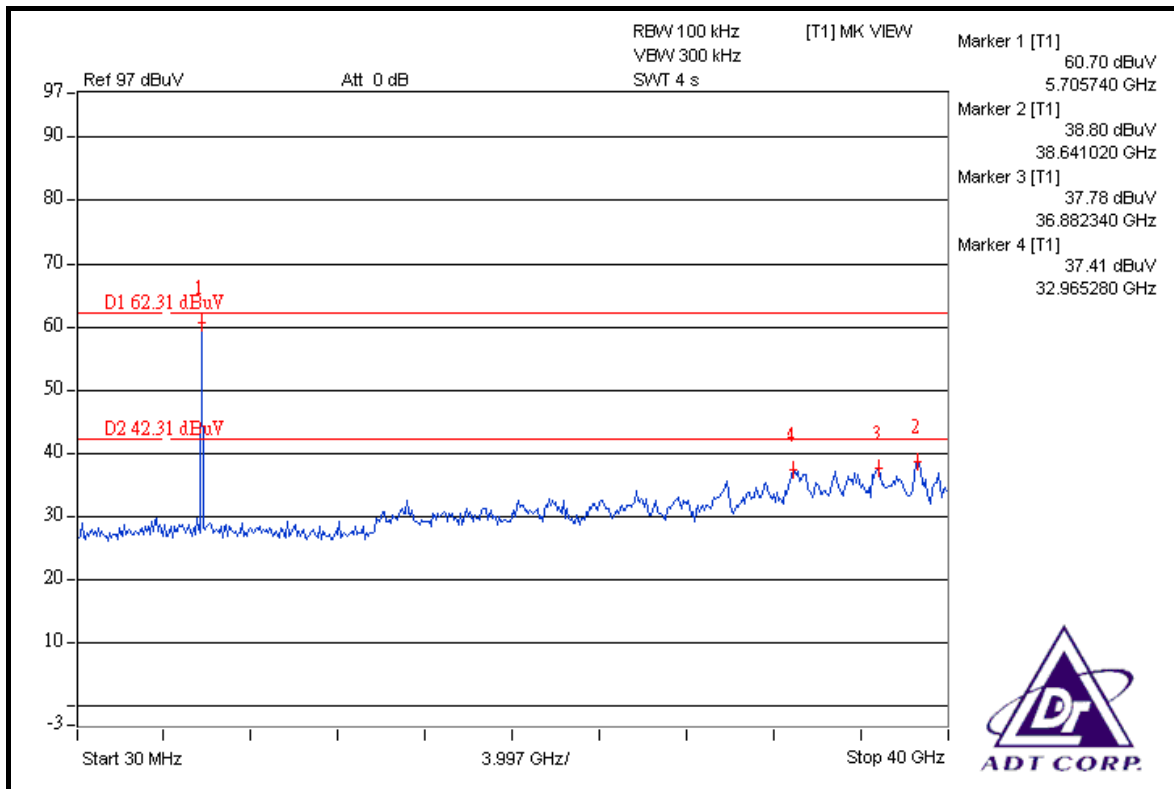

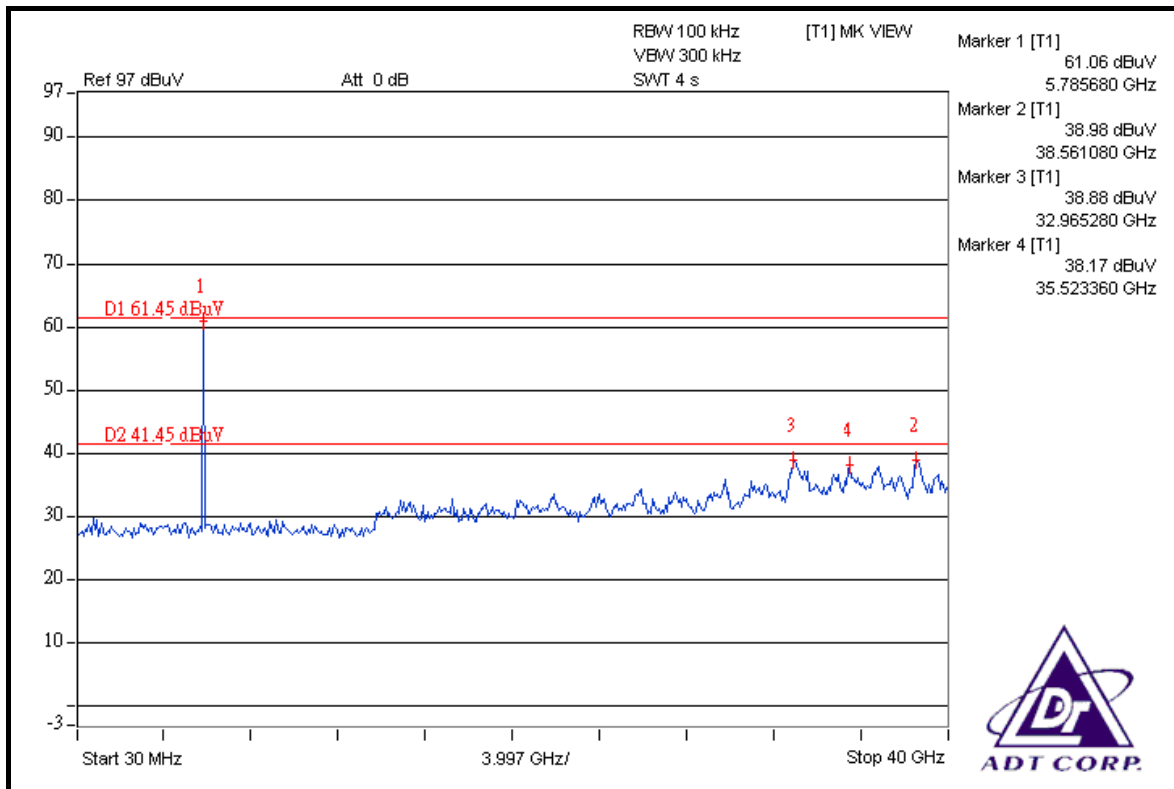
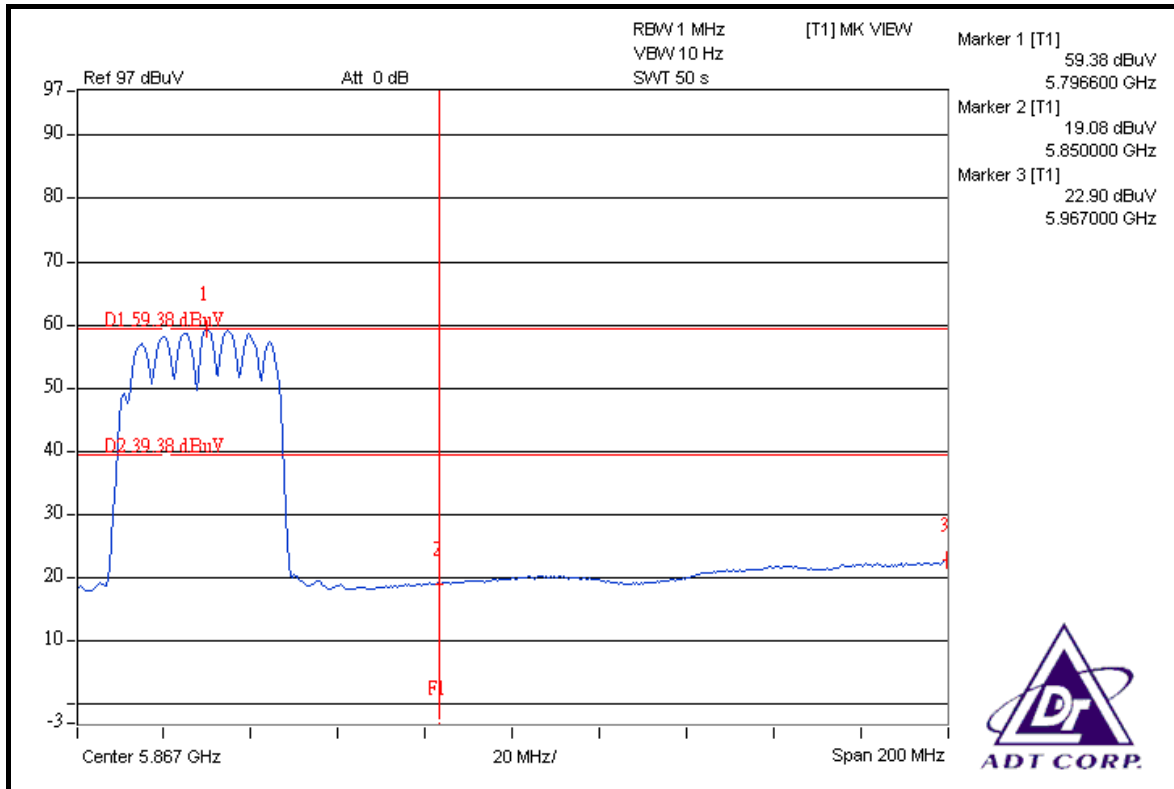

5.7 ANTENNA REQUIREMENT

5.7.1 STANDARD APPLICABLE

For intentional device, according to FCC 47 CFR Section 15.203, an intentional radiator shall be designed to ensure that no antenna other than that furnished by the responsible party shall be used with the device.

And according to FCC 47 CFR Section 15.247(a), if transmitting antennas of directional gain greater than 6dBi are used, the power shall be reduced by the amount in dB that the directional gain of the antenna exceeds 6dBi.

5.7.2 ANTENNA CONNECTED CONSTRUCTION

The antenna used in this product is PIFA antenna without connector. The maximum Gain of the antenna is 1.28dBi.



6. PHOTOGRAPHS OF THE TEST CONFIGURATION

Please refer to the attached file (Test Setup Photo).



7. INFORMATION ON THE TESTING LABORATORIES

We, ADT Corp., were founded in 1988 to provide our best service in EMC, Radio, Telecom and Safety consultation. Our laboratories are accredited and approved by the following approval agencies according to ISO/IEC 17025.

USA	FCC, UL
Germany	TUV Rheinland
Japan	VCCI
Norway	NEMKO
Canada	INDUSTRY CANADA , CSA
R.O.C.	TAF, BSMI, NCC
Netherlands	Telefication
Singapore	GOST-ASIA(MOU)
Russia	CERTIS(MOU)

Copies of accreditation certificates of our laboratories obtained from approval agencies can be downloaded from our web site:
www.adt.com.tw/index.5/phtml. If you have any comments, please feel free to contact us at the following:

Linko EMC/RF Lab:
Tel: 886-2-26052180
Fax: 886-2-26051924

Hsin Chu EMC/RF Lab:
Tel: 886-3-5935343
Fax: 886-3-5935342

Hwa Ya EMC/RF/Safety Telecom Lab:
Tel: 886-3-3183232
Fax: 886-3-3185050

Web Site: www.adt.com.tw

The address and road map of all our labs can be found in our web site also.

8. APPENDIX A - MODIFICATIONS RECORDERS FOR ENGINEERING CHANGES TO THE EUT BY THE LAB

No any modifications are made to the EUT by the lab during the test.

---END---